

NEW PRODUCTS 2017 – 2018  
EFFICIENT SOLUTIONS



# AQUAREA

## Aquarea Air to Water Heat Pump Range.

Aquarea is a ground breaking low energy system for heating and domestic hot water production: delivering outstanding performance, even at extreme outdoor temperatures.

### New Aquarea H Generation A+++.

The beauty of comfort. The new H Generation is being introduced ranging from 3 to 16kW. The small capacity units are specially designed for low energy homes and achieve an impressive COP of 5 (on the 3kW).



### New All in One H Generation.

The new All in One solution from 3 to 16kW with 200L stainless tank with free maintenance. The "A" class pump provides a small foot print and ideal solution for new, retrofit homes.

### DHW tank with built-in Heat Pump.

The Heat Pump is one of the most energy efficient and cost effective methods of water heating. The pump is mounted on the storage tank and draws energy from the ambient air, using that extra energy source to heat the water up to 55°C.

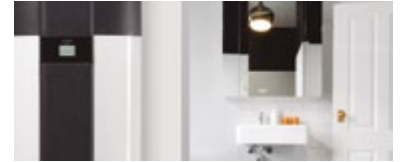

### New Mono-Bloc Generation.

The "A" class water pump equipped with the new remote controller maximises savings while improving the performance and comfort.

### New Aquarea Smart Cloud.

The Aquarea Smart Cloud is a powerful and intuitive service for remotely controlling the full range of heating and hot water functions, including monitoring energy consumption.



# DOMESTIC

## Domestic Range.

Panasonic has developed a range of domestic products designed for you and your clients.

### New Etherea.

New Etherea with Econavi intelligent sensor and new nanoe™ air-purifying system: outstanding efficiency A+++, comfort (Super Quiet technology only 19dB(A)) and healthy air combined with a breakthrough design.

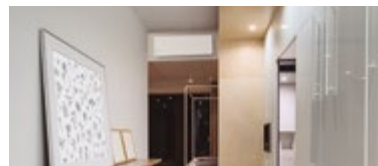
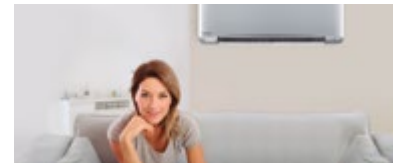

### Panasonic new 2017 range is Compact Style.

Excellent features with an compact and elegant pure white matte finish. Reaches great comfort with this new compact and quiet unit in Split and Multi Split.

### New R32 gas environmentally friendly.

Compared to R22 and R410A, R32 has a very low potential impact on the depletion of ozone layer and global warming. More efficiency and less refrigerant charge needed.



### New Anti-allergy nanoe™ and PM2,5 Filter.

It also neutralises odours to provide a more pleasant and healthy environment.

### Control and connectivity.

Control your units from anywhere with the Wifi adapter or integrate to any protocol: KNX, Modbus or BACnet. And new integration to P-Line to connect to PACi or VRF systems.





# COMMERCIAL

## Commercial Range.

The commercial range is constantly expanding so that you can always offer your clients the best solutions: high performance, silent machines and a complete range of ducts, cassettes and ceiling installations.

### New PACi 90x90 Cassette.

Thanks to advances in design and technology such as the new high performance turbo fan, more efficient and silent, the nanoe air cleaner, for total healthy and the floor temperature & humidity sensor to more control, the new PUZ Panasonic 90 x 90 4 way cassette is the best Industry in energy savings, healthy and comfort.

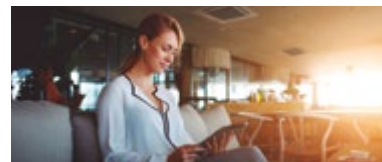

### New Panasonic Big PACi Series PE2.

Panasonic breaks new ground in offering high performance and power in a small space. The 8-10HP from Panasonic is ideally suited for large retail applications and other large areas not needing the higher capacities of VRF systems.

### New Panasonic Mini PACi Series PE2.

New outdoor PACi Elite from 3,6kW to 6,0kW and PACi Standard 6,0kW to 7,1kW, all made in Japan.

Fully new outdoor design with last generation compressor. Higher performance, better partial load and lighter unit (up to 35% less in the 6HP PACi Elite). Includes control consumption, 0-10V demand control and all latest remote controller's functionalities.



### Server room solutions.

Choose the best solution to ensure any server room needs. Designed for high durability and adverse weather conditions its server room ad hoc control ensure permanent operation and failure alarms communications.

### New control CZ-RTC5A.

Ready to control 2 PACi systems with backup and alternate operation.

### Complete AHU Solution.

Demand control 0-10V, box IP65 case, cold draft prevention, monitoring status digital output, remote control built-in.

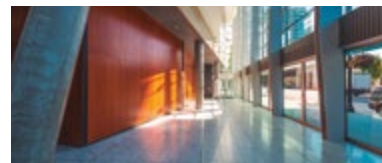

# VRF

## VRF Systems.

The VRF industrial range considerably improves efficiency so even large buildings can benefit from a high-level of comfort with less energy consumption.

### New VRF Systems ECOi EX.

A VRF system delivering energy-saving performance, powerful operation, reliability and comfort surpassing anything previously possible. It represents a true paradigm shift in air conditioning solutions.



### New 8/10HP Mini ECOi.

The New Mini VRF compact system is the ideal solution for minimum outdoor space. Panasonic extends the Mini VRF range by 8 and 10HP units.

### New ECO G GE3 series.

New "L" type heat exchanger and new inverter DC fan motor with a 3-blade propeller to reduce by 30% electrical energy consumption giving better energy efficiency.



### New VRF Smart Connectivity.

Panasonic's VRF Smart Connectivity is a completely new, state-of-the-art solution providing energy saving and comfort as well as simple installation, operation and running.

### Panasonic AC Smart Cloud.

Centralised control of your business premises, from wherever 24/7. Smartly control, maintain, optimise and save.



# INDEX



## EDITORIAL

- 6 THE LAST GENERATION OF AIR CONDITIONING
- 8 A GLOBALLY TRUSTED AIR CONDITIONING BRAND
- 10 100% PANASONIC, THE DNA OF JAPANESE CRAFTSMANSHIP
- 12 PANASONIC: ECO & SMART IDEAS FOR A SUSTAINABLE LIFESTYLE
- 14 PROJECTS & CASE STUDIES OF PANASONIC HEATING AND COOLING SOLUTIONS
- 16 PRO CLUB. THE PROFESSIONAL WEBSITE OF PANASONIC
- 17 AQUAREA DESIGNER



## AQUAREA

- 18 WELCOME TO AQUAREA AIR TO WATER HEAT PUMP
- 20 HIGHLIGHTED FEATURES
- 22 HOW DO YOU GET HEATING AND DOMESTIC HOT WATER FROM AIR?
- 24 AQUAREA HEAT PUMP LINE-UP
- 26 NEW AQUAREA H GENERATION A+++
- 28 AQUAREA T-CAP
- 30 AQUAREA HT
- 32 AQUAREA COMMERCIAL
- 34 NEW AQUAREA SMART CLOUD FOR H GENERATION
- 35 CONTROL & CONNECTIVITY
- 38 AQUAREA + PV PANELS
- 40 AQUAREA HEAT PUMPS LINE-UP
- 42 AQUAREA ALL IN ONE H GENERATION HIGH PERFORMANCE BI-BLOC SINGLE PHASE / THREE PHASE. HEATING AND COOLING. 1 ZONE HYDROKIT OR 2 ZONES BUILT-IN HYDROKIT
- 43 AQUAREA ALL IN ONE H GENERATION T-CAP BI-BLOC SINGLE PHASE / THREE PHASE. HEATING AND COOLING
- 44 AQUAREA H GENERATION HIGH PERFORMANCE BI-BLOC SINGLE PHASE / THREE PHASE. HEATING AND COOLING - SDC
- 45 AQUAREA H GENERATION T-CAP BI-BLOC SINGLE PHASE / THREE PHASE. HEATING AND COOLING - SXC
- 46 AQUAREA H GENERATION T-CAP BI-BLOC THREE PHASE. SUPER QUIET OUTDOOR UNIT. HEATING AND COOLING - SXC
- 47 AQUAREA HT BI-BLOC SINGLE PHASE / THREE PHASE. HEATING ONLY - SHF
- 48 AQUAREA H GENERATION HIGH PERFORMANCE MONO-BLOC SINGLE PHASE. HEATING AND COOLING - MDC
- 49 AQUAREA G GENERATION HIGH PERFORMANCE MONO-BLOC SINGLE PHASE. HEATING AND COOLING - MDC
- 50 AQUAREA G GENERATION T-CAP MONO-BLOC SINGLE PHASE / THREE PHASE. HEATING AND COOLING - MXC
- 51 AQUAREA G GENERATION HT MONO-BLOC SINGLE PHASE. HEATING ONLY - MHF
- 52 AQUAREA AIR RADIATORS FAN COILS FOR HEAT PUMP APPLICATION
- 54 SANITARY TANKS
- 56 AQUAREA DHW
- 58 ACCESSORIES & CONTROL
- 60 HEATING & COOLING CAPACITY TABLES
- 70 DIMENSIONS



## DOMESTIC

- 76 WELCOME TO DOMESTIC RANGE
- 78 HIGHLIGHTED FEATURES
- 80 NEW R32 REFRIGERANT GAS
- 82 NEW ETHEREA. NEW TECHNOLOGY '17
- 84 NEW NANO-SIZED ELECTROSTATIC ATOMIZED WATER PARTICLES, NANOETM, THAT IMPROVE AIR QUALITY
- 86 ECONAVI INTELLIGENT SENSORS. DISCOVER HOW TO ACHIEVE ENERGY SAVINGS
- 90 NEW WALL MOUNTED TZ/TE COMPACT STYLE
- 92 HEATCHARGE. ENERGY CHARGE SYSTEM
- 94 PANASONIC R2 ROTARY COMPRESSOR
- 96 R22 RENEWAL. PANASONIC STANDARD UNITS CAN BE INSTALL ON EXISTING R22 PIPINGS
- 98 CONTROL & CONNECTIVITY
- 100 DOMESTIC AIR CONDITIONER RANGE
- 102 FEATURES EXPLAINED
- 103 FEATURE COMPARISON
- 104 WALL MOUNTED HEATCHARGE VZ INVERTER+ • R32 GAS
- 105 WALL MOUNTED ETHEREA INVERTER+ SILVER / MATT PEARL WHITE • R32 GAS
- 106 WALL MOUNTED TZ COMPACT STYLE INVERTER • R32 GAS
- 107 WALL MOUNTED TE COMPACT STYLE INVERTER • R410A GAS
- 108 WALL MOUNTED KE TYPE STANDARD INVERTER • R410A GAS
- 109 WALL MOUNTED UZ TYPE STANDARD INVERTER • R32 GAS
- 110 WALL MOUNTED PROFESSIONAL INVERTER -20°C • R410A GAS
- 112 FLOOR CONSOLE TYPE INVERTER+ • R410A GAS
- 113 4 WAY 60x60 CASSETTE STANDARD INVERTER • R410A GAS
- 114 LOW STATIC PRESSURE HIDE AWAY STANDARD INVERTER • R410A GAS
- 115 MULTI SPLIT SYSTEM
- 117 FREE MULTI SYSTEM E • R410A GAS
- 119 FREE MULTI 2X1 COMBINATIONS TABLE
- 120 FREE MULTI 3X1 COMBINATIONS TABLE
- 122 FREE MULTI 4X1 COMBINATIONS TABLE
- 126 FREE MULTI 5X1 COMBINATIONS TABLE



**Certified to ISO 9001: 2008**  
Panasonic Appliances Air-Conditioning  
Malaysia. Sdn.Bhd.  
Cert. No.: MY-AR 1010



**Certified to ISO 9001: 2008**  
Panasonic Appliances Air-Conditioning  
(GuangZhou) Co., Ltd.  
Registration Number: 01209Q20645R5L



**Certified to ISO 14001: 2004**  
Panasonic Appliances Air-Conditioning  
Malaysia Sdn.Bhd.  
Cert. No.: MY-ER0112



**Certified to ISO 14001: 2004**  
Panasonic Appliances Air-Conditioning  
(GuangZhou) Co., Ltd.  
Registration Number: 02110E10562R4L



## COMMERCIAL

- 134 WELCOME TO THE COMMERCIAL RANGE
- 136 HIGHLIGHTED FEATURES
- 138 PACi OUTDOOR UNITS ENERGY SAVING CONCEPT
- 140 PACi ELITE: EXCELLENT SEER AND SCOP VALUES
- 142 SOLUTIONS FOR SERVER ROOMS
- 144 NEW GENERATION PACi 90x90 CASSETTE
- 146 RANGE OF COMMERCIAL UNITS
- 148 WALL MOUNTED PKEA PROFESSIONAL INVERTER -20°C
- 150 4 WAY 90x90 CASSETTE PACi INVERTER+
- 152 4 WAY 60x60 CASSETTE PACi INVERTER+
- 154 CEILING PACi INVERTER+
- 156 HIGH STATIC PRESSURE HIDE AWAY PACi INVERTER+
- 158 LOW STATIC PRESSURE HIDE AWAY PACi INVERTER+
- 160 WALL MOUNTED PACi INVERTER+
- 162 HIGH STATIC PRESSURE HIDE AWAY 20-25kW BIG PACi INVERTER+
- 164 PACi SINGLE, TWIN, TRIPLE AND DOUBLE-TWIN SYSTEM
- 168 PANASONIC VENTILATION SOLUTIONS
- 170 AIR HANDLING UNIT KIT 10-25kW FOR PACi
- 172 AIR CURTAIN WITH DX COIL, CONNECTED TO THE VRF OR PACi SYSTEMS
- 174 R22 RENEWAL FAST, EASY TO INSTALL AND COST EFFECTIVE
- 176 ACCESSORIES & CONTROL
- 178 DIMENSIONS



## VRF SYSTEMS

- 190 PANASONIC INDUSTRIAL VRF SYSTEMS
- 192 VRF HIGHLIGHTED FEATURES
- 194 PANASONIC IS DEFINITELY THE MOST EFFICIENT SYSTEM THROUGHOUT THE YEARS
- 196 PANASONIC VRF TOP COMFORT
- 198 SOLUTIONS FOR RESTAURANTS
- 200 YOUR ENTIRE HOTEL WITH MAXIMUM SAVINGS, CONTROL AND COMFORT
- 202 INNOVATIVE SOLUTIONS FOR RETAIL
- 204 BEST EFFICIENCY ECOi SERIES FROM PANASONIC
- 206 2-PIPE MINI ECOi LE1 SERIES
- 210 NEW 2-PIPE ECOi EX THE GAME CHANGER
- 224 3-PIPE ECOi MF2 6N SERIES
- 232 ECO G, THE GAS DRIVEN VRF
- 236 NEW ECO G GE3 SERIES
- 240 ECO G GF2 3-PIPE
- 242 WATER HEAT EXCHANGER FOR HYDRONIC APPLICATIONS
- 246 LEAK DETECTION AND AUTOMATIC REFRIGERANT PUMP DOWN
- 247 DESIGN SUPPORT SOFTWARE FOR VRF
- 248 NEW VRF SYSTEMS INDOOR UNITS
- 250 ECOi AND ECO G SYSTEMS INDOOR UNITS RANGE
- 252 U2 TYPE 4 WAY 90x90 CASSETTE SEMI CONCEALED
- 254 U1 TYPE 4 WAY 90x90 CASSETTE SEMI CONCEALED
- 255 Y2 TYPE 4 WAY 60x60 CASSETTE MINI SEMI CONCEALED
- 256 L1 TYPE 2 WAY CASSETTE
- 257 D1 TYPE 1 WAY CASSETTE
- 258 F2 TYPE VARIABLE STATIC PRESSURE HIDE AWAY
- 259 M1 TYPE SLIM VARIABLE STATIC PRESSURE HIDE AWAY CONCEALED DUCT
- 260 E2 TYPE HIGH STATIC PRESSURE HIDE AWAY
- 261 HEAT RECOVERY WITH DX COIL
- 262 T2 TYPE CEILING
- 263 K2/K1 TYPE WALL MOUNTED
- 264 P1 TYPE. FLOOR STANDING
- 264 R1 TYPE. CONCEALED FLOOR STANDING
- 265 HYDROKIT FOR ECOi WATER AT 45°C
- 266 AQUAREA AIR RADIATORS
- 266 FAN COILS FOR HEAT PUMP APPLICATION
- 268 PANASONIC VENTILATION SOLUTIONS
- 270 AHU CONNECTION KIT 16, 28 AND 56KW FOR ECOi AND GHP
- 272 AIR CURTAIN WITH DX COIL, CONNECTED TO THE VRF OR PACi SYSTEMS
- 274 ENERGY RECOVERY VENTILATION
- 276 HEAT RECOVERY WITH DX COIL
- 278 DIMENSIONS

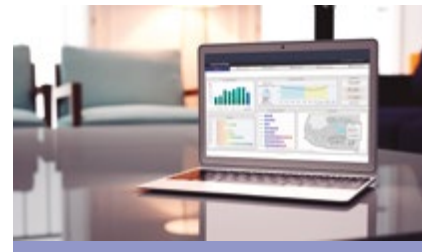

## CONTROL AND CONNECTIVITY

- 300 CONTROL AND CONNECTIVITY
- 304 CONNECT TO THE FUTURE. VRF SMART CONNECTIVITY
- 308 PANASONIC AC SMART CLOUD
- 310 REMOTE CONTROLLER WITH ECONAVI
- 312 ECONAVI SENSOR
- 314 NEW INTELLIGENT CONTROLLER
- 316 CONTROL FOR HOTEL APPLICATION
- 318 CONTROL AND CONNECTIVITY
- 320 INDIVIDUAL CONTROLLERS
- 322 CENTRALISED CONTROLLERS
- 327 PACi AND VRF CONNECTIVITY & CONTROL
- 328 ECOi, ECO G AND PACi CONNECTIVITY INDOOR UNITS



# THE LAST GENERATION OF AIR CONDITIONING

NEW PANASONIC  
TECHNOLOGY

'17



Panasonic is committed to creating a better life and a better world thanks to its breakthrough technology, continuously contributing to the evolution of society and to the happiness of people around the globe.

**Constantly Improving**

At Panasonic, we know that the best is always yet to come. This is why our air conditioning and heat pump solutions are constantly upgraded. We are always looking to improve our technology; finding the most efficient solutions that save our customers money. Our Technology & Design teams anticipate the needs of tomorrow. We look to produce smaller, quieter, efficient solutions - with better technological features - that can reduce energy consumption while providing suitable temperature conditions for the user.

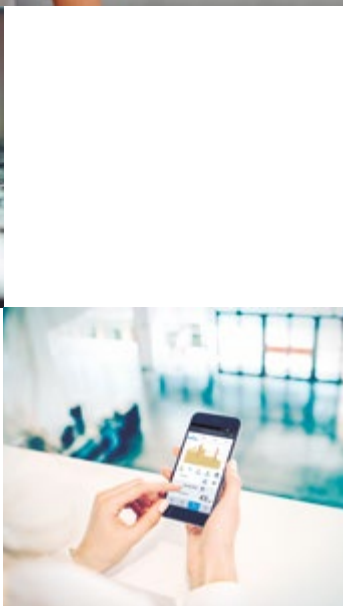

**Look ahead to the “Future,” keep taking on challenges**

Starting 1918, Panasonic has constantly added to its guarantee for innovation, taking tomorrow’s technologies and applying them to today’s needs. Always making “people” central to our activities, and thereby focusing on “people’s lives,” we will continue to provide better living for our customers. This is the unchanging commitment we at Panasonic have had over many years. We are aiming for now is to expand our contribution to “better living” everywhere. This means that in the variety of spaces where our customers go about their lives, ranging from inside the home, the office, the store, the automobile, and the airplane, as well as the town, we will provide not only single pieces of hardware,

but also total solutions including software and services. We will pursue the concept of “A Better Life, A Better World,” meeting the needs of each individual customer.

To that end, we will leverage the strengths that we at Panasonic have long developed in our consumer electronics business, the strengths of our business partners who have in-depth expertise in many areas, and will work to combine these strengths by pursuing “Cross-Value Innovation.” In this way, we will create new value. This is the new and challenging task we are now addressing.



# A GLOBALLY TRUSTED AIR CONDITIONING BRAND





Panasonic – leading the way in Heating and Cooling. With more than 30 years of experience, selling to more than 120 countries around the world, Panasonic is unquestionably one of the leaders in the heating and cooling sector.

With a diverse network of production and R&D facilities, Panasonic delivers innovative products incorporating cutting-edge technologies that set the standard for air conditioners worldwide. Expanding globally, Panasonic provides superior international products transcending borders.



**100% Panasonic: we control the process**

The company is also a world leader in innovation as it has filed more than 91,539 patents to improve its customers' lives. Moreover, Panasonic is determined to remain at the forefront of its market. In all, the company has produced more than 200 million compressors and its products are manufactured in 294 plants which are located all over the world. You can be assured of the extremely high quality of Panasonic's heat pumps. This wish to excel has made Panasonic the international leader in heating and turn-key air conditioning solutions. These offer maximum effectiveness, comply with the strictest environmental standards and meet the most avant-garde construction requirements of our time.

**History of Air Conditioning Group**

Panasonic starts with a desire to create things of value. As hard work and dedication results in one innovative product after another, the new company took its first steps towards becoming the electronics giant of today. Heating and Cooling Solutions designed and produced by Panasonic since 1958. See more information on [www.aircon.panasonic.eu](http://www.aircon.panasonic.eu)



1958

First room air conditioner launched for domestic installation.

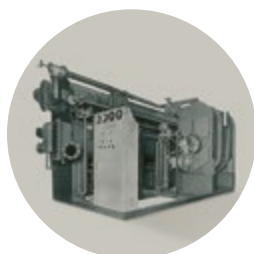

1971

Starts production of absorption chillers.



1973

Panasonic launches the first highly efficient air-to-water heat pump in Japan.



1975

Panasonic becomes the first Japanese air conditioner manufacturer in Europe.



1985

Introduces first GHP (gas heat pump) VRF air conditioner.



1989

Introduces world's first simultaneous 3-Pipe heating/cooling VRF system.



2008

Etherea new concept of air conditioning systems: high efficiency and high performances with a great design.



2010

New Aquarea. Panasonic has created Aquarea, an innovative new, low-energy system.



2012

New GHP units. Panasonic's gas-driven VRF systems are ideal for projects where power restrictions apply.



Looking ahead

New VRF Systems ECOi EX with Extraordinary Energy-Saving Performance and Powerful Operation EER 4.7.

100% PANASONIC, THE DNA OF  
JAPANESE CRAFTSMANSHIP

JAPAN  
QUALITY



Applying advanced technologies that truly make life better, we live by an unparalleled commitment to product quality. Panasonic is building on the Japanese tradition of uncompromising quality control worldwide, developing and manufacturing fine products and delivering them to customers everywhere.

At Panasonic, we believe that the best air conditioner is one that works quietly and effectively in the background whilst minimising its impact on the environment

People who use our products can look forward to long years of high-quality performance without the need for constant service. As part of our rigorous design and development process, Panasonic air conditioners undergo a variety of stringent tests to ensure their effectiveness and long-term reliability. Tests for durability, waterproofing, shock resistance, and noise are conducted on component parts or on the finished products themselves.

As a result of all of these time consuming efforts, Panasonic air conditioners meet even the most demanding industrial standards and regulations in every country where they are sold.

### International Standard Quality

To uphold the company's reputation around the world, Panasonic strives continuously to offer the highest quality with the lowest possible environmental impact.



#### Reliable parts that meet or exceed industrial standards

In every country where they are sold, Panasonic air conditioners comply with all required industrial standards and regulations. In addition, Panasonic conducts stringent testing to ensure the reliability of parts and materials. The strength of the resin material used in a propeller fan is confirmed by a tension test.



#### RoHS / REACH compliant parts

All Panasonic parts and materials comply with Europe's strict RoHS/REACH environmental regulations. During the development and production of parts, stringent inspections are conducted on over 100 materials to ensure that no hazardous substances are included.



#### Sophisticated production process

Panasonic's air conditioner production lines employ state-of-the-art factory automation technologies to ensure products are manufactured efficiently and with uniformly high levels of quality and reliability.

### Durability

At Panasonic we know the importance of a long service life with minimal maintenance. That's why we subject our air conditioners to a wide range of stringent durability tests.



#### Long-term durability test

To ensure durability and stable operation for many years, we conduct a long-term continuous operation test under conditions that are much more severe than actual operating conditions.



#### Compressor reliability test

After the continuous operation test, we remove the compressor from a selected outdoor unit, disassemble it, and examine the internal mechanisms and parts for potential failure. This helps ensure reliable long-term performance under harsh conditions.

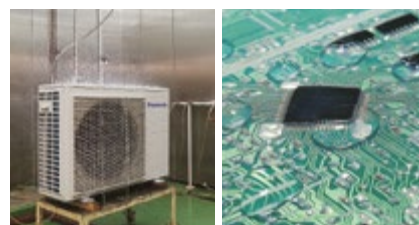

#### Waterproofing test

The unit - which is subject to rain and wind - complies with IPX4 waterproof specifications. Contact sections on printed circuit boards are resin-potted to prevent adverse effects caused by exposure to water (an unlikely occurrence).



# PANASONIC: ECO & SMART IDEAS FOR A SUSTAINABLE LIFESTYLE



Panasonic Green Innovation Company.  
 We will make the environment central to all our business activities and work to realise our vision with innovations for both every day life and business.

**Exemplary sustainable projects**

**Fujisawa Sustainable Smart Town Goes Into Full-Scale Operation Near Tokyo.**

Fujisawa SST Council is a consortium led by Panasonic Corporation spearheading the development of the Fujisawa Sustainable Smart Town (Fujisawa SST). With its core facility supporting sustainable development of the town and its community now coming into operation, the Fujisawa SST is moving from the construction stage into a new stage where the town is nurtured to grow in full-scale into an eco and smart town that puts a high priority on the residents' lifestyles.

The Fujisawa SST Management Company is the town management company located in the SQUARE. Together with partner companies, the company provides five essential services in the town: energy, security, mobility, healthcare and community. The company will also collect and manage information relating to the town's overall environment, energy, security and safety to support an eco and smart life in the town. As a fresh development in the town, the Fujisawa SST has set a detached housing zone for non car owners for the second phase of sales. By using the town's eco-car sharing and rent-a-car services, residents in the zone



can enjoy their lifestyles without the need to own a car while reducing economic burden and making effective use of the lot. Preparations are also underway for a new base to provide environmentally-friendly logistic services to the residents.

**Solar Power Generator.**  
 HIT solar cells achieve maximum output even on smaller roofs. These solar modules are 100% emission free, have no moving parts and produce no noise.

**Home AV.**  
 Panasonic offers a wide range of energy saving home equipment to fulfil a sustainable and comfortable lifestyle.

**Heat Pump.**  
 The Aquarea Heat Pump is part of a new generation of heating systems that use a renewable, free energy source: air, to heat or cool the home and to produce hot water.

**Fuel Cell.**  
 The Panasonic Fuel Cell is an energy-creating device, which generates electricity and heat at the same time with chemical reaction between hydrogen extracted from natural gas and oxygen.

**LED Lamps.**  
 Expertise gathered over years of research and development has enabled Panasonic to provide a renaissance in energy saving home LED lighting – with our LED Nostalgic Clear lamp.

**Home Appliances.**  
 Panasonic is globally committed to develop products which are environmentally friendly. Panasonic delivers home appliances such as refrigerators and washing machines that incorporate the latest energy-efficient technology.

**Solar Power Generator.**  
 Our mobility space can be connected to our HIT solar panels – with the help from our storage batteries.

**Storage Battery.**  
 The battery stores the energy generated by a combination of solar power and fuel cells to ensure a constant supply of electricity on demand.



# PROJECTS & CASE STUDIES OF PANASONIC HEATING AND COOLING SOLUTIONS



New Hotel Monument 5\*GL is located in an 1896 palace.  
Barcelona, Spain. ECOi and E-Control



Panasonic, a partner with the knowledge and experience to achieve your objectives and green needs.

**Integrated technology that permits better work, easy installation, high efficiency performance, and energy saving**

Our main targets are the distributed services and B2B-integrated solutions.

Panasonic provides a single point of contact for the design and maintenance of your system, making things easy for you.

Given our experience in processes, technologies and complex business models, we can offer you effective solutions that reduce costs, whilst also being efficient, user-friendly, reliable and innovative.

Another advantage we offer to our clients is a support service for systems integration projects, which we provide through our wide range of services and solutions.

As a global company, we have at our disposal the financial, logistical and technical resources to develop complex and wide-ranging solutions, both at country and international level by implementing them both on-time and on-budget.



The latest glamorous Burger & Lobster restaurant in Bath. UK. **AQUAREA**



Brabrand Boligforening has constructed 75 low-energy houses in Hasselager near Århus **AQUAREA**



An water tower has been converted into a stunning family home. Yorkshire, UK. **AQUAREA**



Panasonic Smart Home. A house with zero emissions. Tokyo, Japan. **RAC-AQUAREA**



New IKEA "Click and Collect" store in city centre. Birmingham, UK. **ECOi - ECO G**



New Hotel OD Port Portals. Palma de Mallorca. Spain. **ECOi - ECO G**



Le Dolcezza Patisserie, Italy. **PACi**



GE Aviation. Bristol, UK. **PACi**



Lo + Fit Galapagar Gym. Madrid, Spain. **VRF, PACi, AHU**



Lock Building, offices for media giant Viacom. Camden, London, UK. **ECOi**



Restaurant Burger & Lobster. London, UK. **ECOi**



The new Hotel Vincci Gala with efficiency class A, up to 70% save energy. Barcelona, Spain. **ECOi - ECO G**

# PRO CLUB. THE PROFESSIONAL WEBSITE OF PANASONIC



**PRO Club** 

Download on  
[www.panasonicproclub.com](http://www.panasonicproclub.com)  
or connect simply with your  
smartphone to the PRO Club  
using this QR



Panasonic has an impressive range of support services for designers, specifiers, engineers and distributors working in the heating and cooling markets.

Panasonic PRO Club ([www.panasonicproclub.com](http://www.panasonicproclub.com)) is the online tool which makes your life easier! You just have to register and a lot of functionalities are freely available to you, where ever you are, from your computer or smart phone!

- Print catalogues with your logo and your address
- Download the latest Aquarea designer to define your system and select the good Aquarea Heat pump.
- Calculate the specs of the Aquarea Air fan coil based on the parameters of your system
- Get Documents of conformity and all other documents you may need
- Download all the service manuals, end user manuals and installation manuals
- Know what to do with error codes
- Find out about the latest news first
- Register for training

#### Highlighted Features:

- Extensive library of resources
- Tools & Apps for end users. Check availability in your country:
  - My Home: sizing wizard for domestic and A2W range
  - My Project: Contact form to Panasonic team
  - iFinder: Lists of installers displayed by postcode



Easy download Panasonic service documentation and brochures



Customise leaflets with your logo & contact details. Save and print the PDF



Energy label generator. Download Energy labels of any device in PDF format



Error Code on your smartphone and your PC: Search by error code or model reference. Online version + downloadable version for offline use

- Special offers & promotions
- Training PRO Academy
- Catalogues (Commercial documentation)
- Marketing (Images in high resolution, advertisements, deco guidelines)
- Tools (Professional software, sizing tools...)
- Installers customize leaflets in PDF format with their logo & contact details
- Energy label generator. Download energy labels of any device in PDF format
- Heating calculator
- Noise calculator for outdoor unit
- Aquarea Radiator calculator
- Error Code Search by error code or unit ref. Compatible with smartphone and tablet computer
- Revit / CAD Images / Spec texts
- Access to Pananet, online library of technical documentation
- Download Documents of Conformity and other Certifications
- Commissioning online

Panasonic PRO Club is fully compatible with tablet computer and smartphone.

#### The Panasonic PRO Academy

Panasonic takes its responsibility to its distributors, specifiers and installers seriously and has developed a comprehensive Training Programme. The Panasonic Pro-Academy encompasses the traditional hands-on approach to teaching.

New training courses cover three levels. Design, installation, and commissioning & trouble-shooting. Training courses include:

- Domestic applications Air to Air
- Aquarea air source heat pumps
- VRF ECOi

The courses are offered on site at Panasonic's premises across Europe. The Training Centres display Panasonic's latest product range and give delegates an opportunity to get a hands-on experience with the latest controllers, indoor and outdoor units from the VRF ECOi, Etherea, GHP and Aquarea ranges.





# WELCOME TO AQUAREA AIR TO WATER HEAT PUMP



Aquarea's new Air to Water Heat Pump for residential and commercial applications. Offering capacities from 3kW all the way through to 16kW, the Aquarea Heat Pump Range is the widest on the market, ensuring a system is available, whatever your heating and cooling needs. Suitable for new build and refurbishment projects, the solutions are cost-effective and environmentally friendly.





# HIGHLIGHTED FEATURES





Panasonic's Aquarea range of Heat Pumps deliver major energy savings thanks to its incredible efficiency even at -20°C. The Panasonic Aquarea Heat Pumps are designed and produced by Panasonic and not by other companies.

The Aquarea Heat Pump is a system that generates the perfect temperature and produces hot water, in an easy, cheap and environmentally friendly way, by transferring heat instead of generating it. It is among the Technologies listed on the International Energy Agency (IEA) Blue Map, whose goal is to reduce CO<sub>2</sub> emissions to half the levels emitted in 2005, by the year 2050.

Aquarea is part of a new generation of heating solutions that use a renewable, free energy source (the air) to heat or cool the home and to produce hot water:

- Extremely high efficiency (COP of 5,08 for new 5kW Mono-bloc unit)
- Line up developed for low consumption homes (starting at 3kW)
- T-CAP solution is ideal for cold areas, as it maintains the nominal capacity up to -15°C
- Easy to control with your smart phone (using an optional interface)
- Large range of efficient tanks for domestic hot water storage

Energy saving



Better Efficiency & Value. For medium temperature applications. Aquarea systems meets ErP regulation as A++.



Better Efficiency & Value. For low temperature applications. Aquarea systems meets ErP regulation as A++.



Better Efficiency & Value. For low temperature applications. Aquarea systems meets ErP regulation as A.

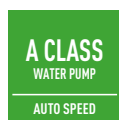

Aquarea are built-in with A class water pump. H Generation with auto speed, and F Generation and normal G Generation with 7 speeds.



The A Inverter+ system provides energy savings of up to 30% compared to non Inverter models. Both you, and nature, wins!

High Performance



Aquarea High Performance for low consumption houses. From 3 to 16kW. For a house with low temperature radiators or under-floor heating, our high performance Aquarea HP is a good solution.



Aquarea T-CAP for extremely low temperatures. From 9 to 16kW. If the most important aspect is to maintain nominal heating capacities even at temperatures as low as -7°C or -20°C, select the Aquarea T-CAP.



Aquarea HT ideal for retrofit. From 9 to 12kW. For a house with traditional high-temperature radiators, the Aquarea HT solution is the most appropriate, can work in output water temperatures of 65°C even at outdoor temperatures as low as -15°C.



DHW. With Aquarea you can also heat your domestic hot water at a very low cost with the optional hot water cylinder.



Down to -20°C in heating mode. The Heat Pumps work in Heat Pump mode with an outdoor temperature as low as -20°C.



Water filter (easy access & fast clip technology) for H Generation.



Water stop valve included on H Generation.

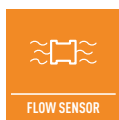

Water Flow Sensor included on H Generation.



We guarantee the outdoor unit compressors in the entire range for five years.



SG Ready: Thanks to Aquarea HPM, Aquarea range (Bi-bloc and Mono-bloc) is holding the SG Ready Label (Smart Grid Ready Label), given by Bundesverband Wärmepumpe (German Heat Pump Association). This Label shows the real capacity of Aquarea to be connected in an intelligent grid control. MCS Certificate number: MCS HP0086.\*



High connectivity



Renovation. Our Aquarea Heat Pumps can be connected to an existing or new boiler for optimum comfort even at very low outdoor temperatures.



Solar Kit. For even greater efficiency, our Aquarea Heat Pumps can be connected to photovoltaic solar panels with an optional kit.



New remote controller with full dotted 3,5" wide back light screen. Menu with 10 available languages easy to use for installer and user. Included on H Generation.



Internet Control is a next generation system providing a user-friendly remote controller of air conditioning or Heat Pump units from everywhere, using a simple Android or iOS smartphone, tablet or PC via internet.



Connectivity. The communication port is integrated into the indoor unit and provides easy connection to, and control of, your Panasonic Heat Pump to your home or building management system.

\* Not all products certified. As the certification process is on-going and the list of certified products constantly changing, please check for latest details on the official websites.

# HOW DO YOU GET HEATING AND DOMESTIC HOT WATER FROM AIR?



**New Aquarea Air to Water Heat Pump, the best seasonal efficiency.**

At the forefront of energy innovation, Aquarea is resolutely positioned as a “green” heating and air conditioning solution.

**Introducing the Panasonic Aquarea – Air Source Heat Pump**

An Aquarea air source Heat Pump circulates fresh air and passes it over refrigerant-filled coils (like a refrigerator). The captured heat is automatically transferred to water, which is then ready for use in your heating system and for supplying all of your domestic hot water needs. Panasonic’s latest technology offers you a sustainable alternative to oil, LPG and electric heating systems.

**Up to 80% energy savings\***

At the forefront of energy innovation, Aquarea is resolutely positioned as a “green” heating and air-conditioning solution. Aquarea is part of a new generation of heating and air-conditioning solutions that use a renewable, free energy source – the air – to heat or cool the home and produce hot water. The Aquarea Heat Pump is a much more flexible and cost-effective alternative to a traditional fossil fuel boiler.

**“Green” High-efficiency heating with Panasonic’s new Air to Water Heat Pump Systems**

Panasonic’s Aquarea Heat Pump provides savings of up to 80% on heating expenses compared to electrical heaters. For example, the Aquarea 5kW system has a COP of 5,28. This is 5,28 more than a conventional electrical heating system which has a maximum COP of 1. This is equivalent to an 80%\* saving. Consumption can be further reduced by connecting photovoltaic solar panels to the Aquarea system.

**Aquarea Air to Water Heat Pump: An innovative low energy solution, designed to create great comfort at home even at extreme outdoor temperatures. Providing heat to radiators, underfloor heating, fancoils as well as producing domestic hot water.**

**Why Air Source Heat Pumps?**

- Heating, cooling and domestic hot water produced with a single system
- Best in terms of efficiency: even at extreme outdoor temperatures
- Environmentally friendly: can be connected to solar panels
- Technology that adapts to each home: extreme low temp, high temperature, whatever the climate
- Wide range of solutions: floor heating, radiators and fan coils
- Reduced heating bills and maintenance costs
- Reduce your carbon footprint
- Simple to integrate into existing heating systems
- Energy efficient alternative to oil, LPG and electric systems
- Ideal for properties without access to mains gas
- Externally positioned saving valuable internal living space



**Aquarea up to 80% energy savings\***

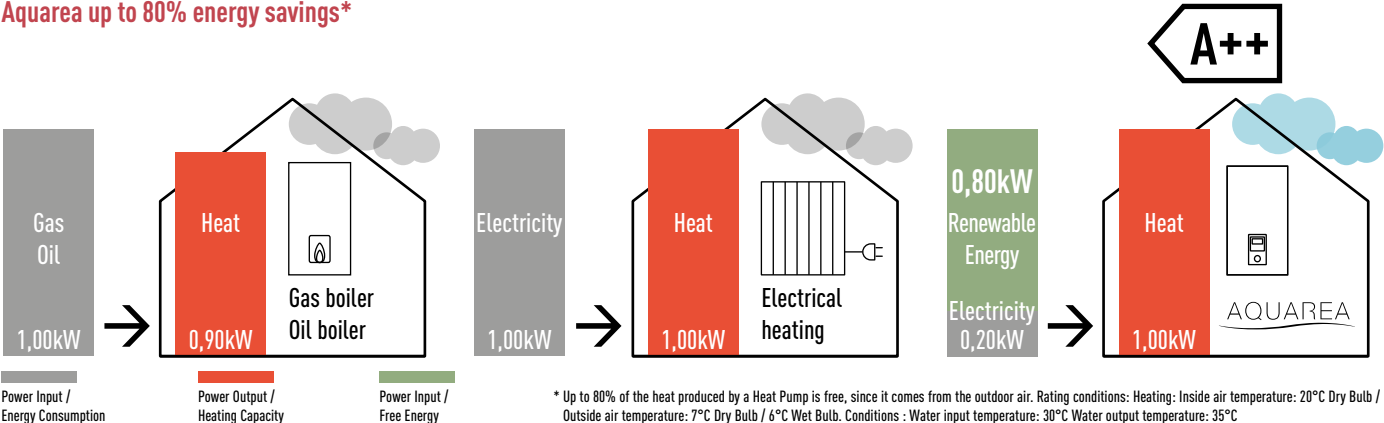



# AQUAREA HEAT PUMP LINE-UP

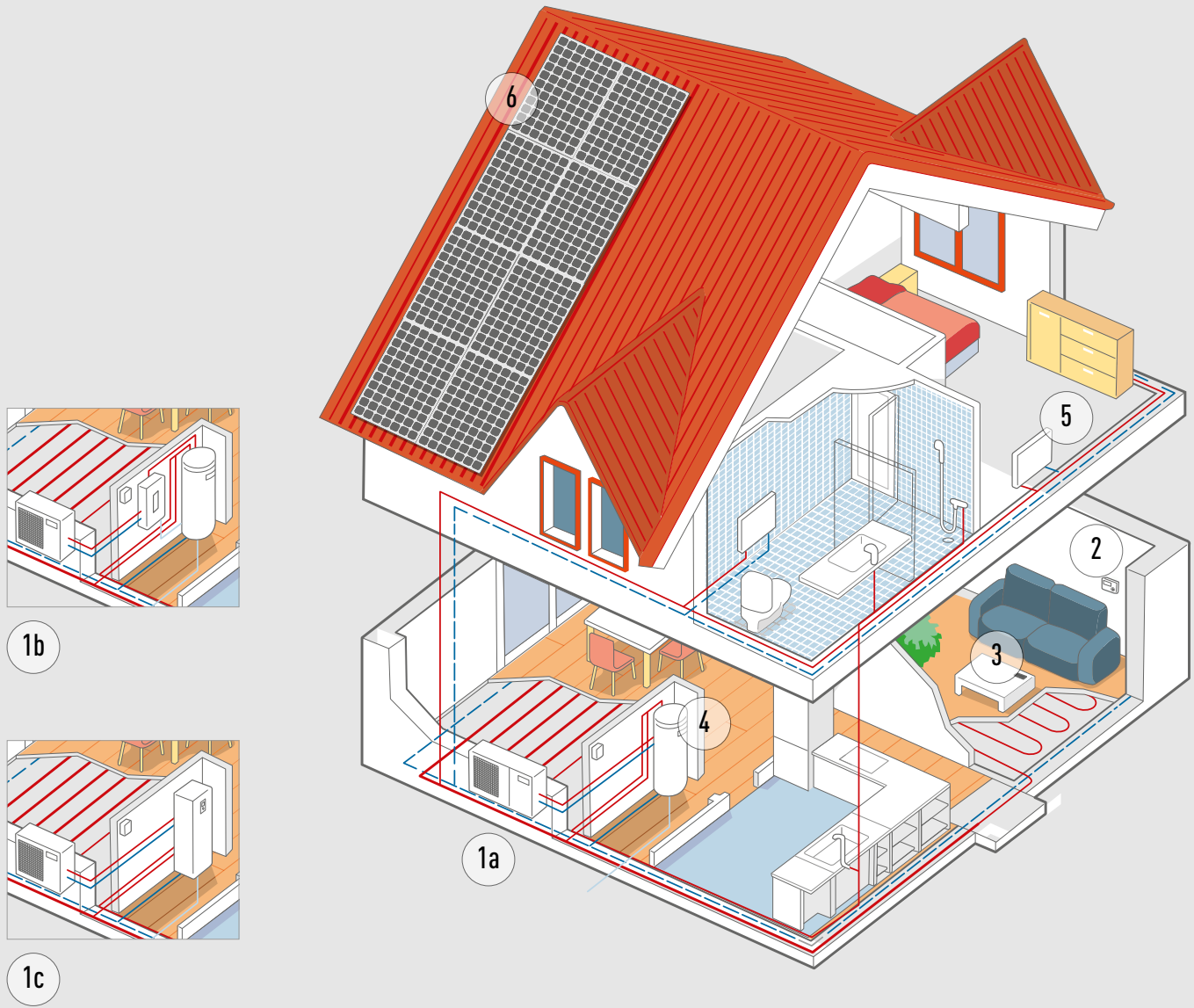

- 

**1a**  
Mono-bloc system
- 

**1b**  
Bi-bloc system
- 

**1c**  
All in One system
- 

**2**  
Aquarea Heat Pump Manager (optional)
- 

**3**  
Control through smart phone, tablet or computer (optional)
- 

**4**  
Super High Efficiency cylinder (optional)
- 

**5**  
High efficient radiators for heating and cooling (optional)
- 

**6**  
Heat Pump + HIT Photovoltaic solar panel (optional)

Panasonic Aquarea offers you solutions, helping to make the home more efficient and the installation cheaper and easier.

**Aquarea High Performance. For new installations and low consumption homes**

Maximum savings, maximum efficiency, minimum CO<sub>2</sub> emissions, minimum of space. Improved performance with COP's up to 5,28.

**Aquarea T-CAP. For extremely low temperatures, refurbishment and innovation**

Ideal to ensure that the heating capacity is maintained even at very low temperatures. This line-up is able to maintain the Heat Pump output capacity until -20°C outdoor temperature without the help of an electrical booster heater.

**Aquarea HT. For a house with old high-temperature radiators**

Ideal for retrofit: green energy source works with existing radiators. Aquarea HT Solution is the most appropriate, provides output water temperatures of 65°C even at outdoor temperatures as low as -15°C.

**Aquarea DHW**

DHW tank with built-in Heat Pump.

Aquarea High Performance	Aquarea T-CAP	Aquarea HT	Aquarea DHW
Heating - Cooling - DHW Single Phase from 3 to 16kW Three Phase from 9 to 16kW	Heating - Cooling - DHW Single Phase from 9 to 12kW Three Phase from 9 to 16kW	Heating - DHW Single Phase from 9 to 12kW Three Phase from 9 to 12kW	Only DHW From 80 to 295L
<b>Connectable to</b>			
Radiators - Fancoil - Underfloor heating - DHW	Radiators - Fancoil - Underfloor heating - DHW	Traditional high-temperature radiators - DHW	Domestic hot water
<b>Application</b>			
Normal installation	For extreme cold ambient	Retrofit for old radiators	Only DHW
<b>Energy efficiency</b>			
Heating 35°C / 55°C	Heating 35°C / 60°C <sup>1</sup>	Heating 35°C / 55°C	DHW 55°C
<b>Outdoor ambient temperature limit. Operation</b>			
-23°C	No limit	-28°C	-7°C
<b>Constant capacity</b>			
	-20°C <sup>1</sup>	-15°C	
<b>Supply temperature for heating. Max. / Heat pump only</b>			
75°C / 55°C	75°C / 60°C <sup>1</sup>	75°C / 65°C	75°C / 55°C
<b>Control and connectivity</b>			
Smart Grid Ready <sup>2</sup> Wifi Ready	Smart Grid Ready <sup>2</sup> Wifi Ready	Smart Grid Ready <sup>2</sup> Wifi Ready	Smart Grid Ready <sup>2</sup> Wifi Ready
<b>Range</b>			
Bi-bloc from 3 to 16kW Mono-bloc from 5 to 16kW All in One from 3 to 16kW (185L)	Bi-bloc from 9 to 16kW Mono-bloc from 9 to 16kW All in One from 9 to 16kW (185L)	Bi-bloc from 9 to 12kW Mono-bloc from 9 to 12kW	From 80 to 295L

All data in this chart is applicable in most of models in each line up, check product specs to confirm. 1) H Generation T-CAP. 2) H Generation with CZ-NS4P, F and G Generation with Heat Pump Manager.

# NEW AQUAREA H GENERATION A+++





The beauty of comfort. The new H Generation is being introduced from 3 to 16kW. The small capacities are specially designed for low energy homes and achieve an impressive COP of 5 (on the 3kW).

### Better Efficiency & Value A++/A++

- A++ for medium temperature applications (radiators. ErP 55°C)
- A++ for low temperature applications (floor heating. ErP 35°C)
- 3 & 5kW meet Sep'19 ErP regulation as A+++

### Aquarea, a new generation of energy efficient heating and hot water

Thanks to the system's high degree of technology and advanced control, it is able to maintain a high output capacity and efficiency even at -7°C and -15°C. The Aquarea's software can be set for the requirements of low consumption homes in order to maximise energy efficiency. Whatever the weather, Aquarea can work even at -20°C. The compact design of the outdoor unit makes installation very easy.

### New Design

New improved square design with white goods finish. Modern remote controller can be installed up to 50m from the indoor unit.

### Installer Friendly:

- Electrical connections is now located on front side
- Easy access to parts and easy to install by having all pipings in a row
- New remote controller with full dotted wide screen and new functions
- Can connect additional room temperature sensor, solar kit, 2 zones control, swimming pool and circulating pump (need optional PCB: CZ-NS4P)

### Compact and free space. More value in 1 compact space:

- Line strainer (easy access & fast clip technology)
- Isolation valves
- Electronic flow sensor
- 3 way valve ready (optional CZ-NV1 in internal space)

### New All in One with 2 zones control

- 2 heating circuits, with 2 different water temperatures
- 2 water pumps and 2 water filters
- Floor heating water control with mixing valve

2 Zones kit included with control of 2 water temperatures (underfloor with water at 35°C and radiators with water at 45°C)

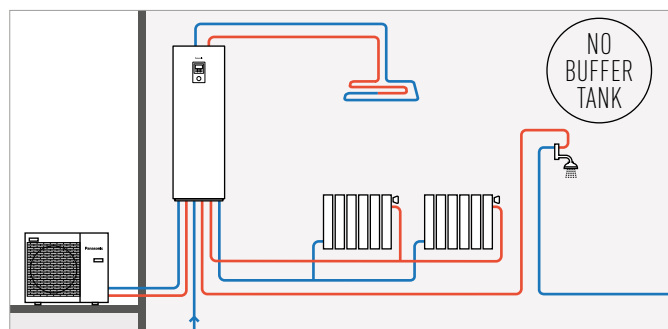

FREE  
MAINTENANCE  
STAINLESS TANK\*

\* FOR ALL IN ONE H GENERATION



### New All in One, compact and easy to install

Space-saving solution ideal for installations with restricted space. In addition, Panasonic has developed bivalent and cascade systems that give the user control of two heating zones.

The Aquarea All in One belongs to the new generation of Panasonic heat pumps for heating, cooling and providing domestic hot water in the home. Aquarea T-CAP is one of the newest heat pumps on the market, maintaining nominal heating capacities even at temperatures as low as -20°C\*. This ensures the best possible seasonal energy efficiency ratio. The heat pumps are tested at an outdoor temperature of -28°C to ensure the most efficient and stable operation.

BEST IN TEST 2016: \* Applies to ALL in One T-CAP 5kW H Generation: The highest measured SCOP (energy efficiency) of all air/water heat pumps, in the corresponding category, that have been published on the heat pump list of the Danish Energy Agency: sparenergi.dk/forbruger/vaerktoejer/

### New Aquarea Smart Cloud for H Generation

#### The most advanced heating control for today and for the future:

Easy and powerful energy management. The Aquarea Smart Cloud is much more than a simple thermostat for switching a heating device on or off. It is a powerful and intuitive service for remotely controlling the full range of heating and domestic hot water functions, including monitoring energy consumption, Malfunction notification, Failure Prediction & Remote Servicing as some options.

### Advanced Control

**Ease of use:** New remote controller with full dotted 3,5" wide back light screen provides clearer visibility to the user.

**Relocation:** Remote controller can be installed up to 50m from the indoor unit.

### New Accessory

Optional PCB (CZ-NS4P). With this new PCB you can also manage one or more functions like below: SG Ready, 0-10V demand signal, 2-zones control function (pump + mixing valve), solar and external switch (heat / cool).

# AQUAREA T-CAP





For retrofit and new builds, install the T-CAP heat pump where the kW output capacity is demanding.

**Ensure the heating capacity is maintained even at low temperatures**

The whole T-CAP line-up can replace old gas or oil boilers, and in a new application with underfloor heating, radiators or even fan-coil heaters, the whole T-CAP line-up is an ideal replacement for old gas/oil boilers. All Aquarea heat pumps can also be connected to a solar thermal or PV system in order to increase efficiency and minimise the impact on the ecosystem.

**Best efficiency compared to other heating systems**

Panasonic Heat Pumps have a maximum COP of 4,85 at +7°C which makes them much more efficient than others heating systems.

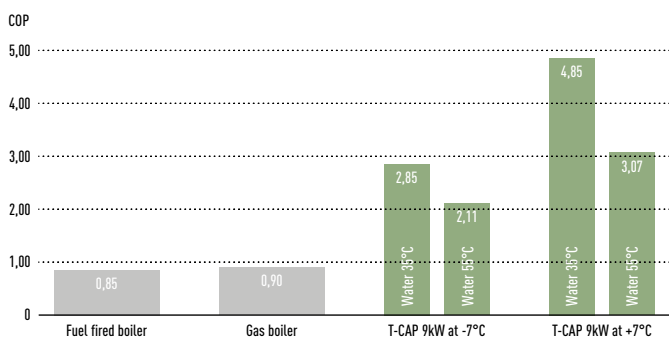

**More Energy saving**

T-CAP is also able to provide extremely high efficiencies, whatever the outside or the water temperature.

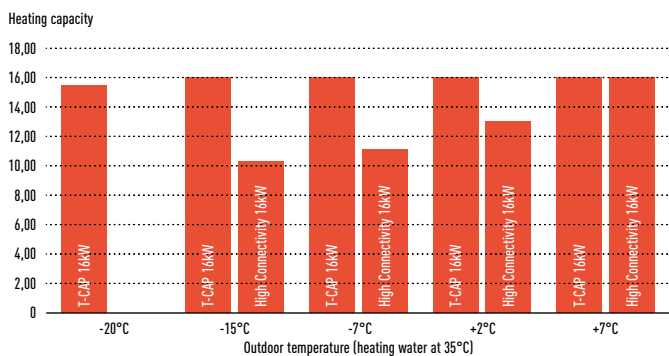

**Key points of the line-up**

- Ability to maintain the heat pump kW<sup>1</sup> output capacity until -20°C outdoor temperature without the help of an electrical booster heater
- High heating capacity even at low ambient temperatures
- Additional functions: Auto and holiday mode, boost, drying concrete and power consumption display
- Backup heater capacity can be selected depending on the model (3/6/9kW)
- Cooling mode activation possible via software<sup>2</sup>

1) At 35°C flow  
2) This activation can only be done by service partner or installer

**With a Panasonic heat pump, there is no need to oversize in order to reach the required capacity at low temperatures**

- Panasonic’s unique software and inverter technology for low consumption houses, allows the heat pump to produce heating water at 20°C. When only a little heating is required due to warmer outside air temperature
- All Aquarea heat pump’s have a 10L expansion vessel fitted internally
- Aquarea heat pump’s has an inverter compressor which can regulate the output capacity depending on demand
- New twin dice system included within the system (Twin fan outdoor unit)
- 3/6/9kW electrical heater is included in the heat pump (depending on unit)
- Panasonic heat pumps can work in outdoor temperatures as low as -28°C and guarantee the capacity without backup heating down to -15°C<sup>1</sup>
- Panasonic heat pumps are very quiet and have a noise reduction setting for night mode. See noise calculator on [www.panasonicproclub.com](http://www.panasonicproclub.com)

1) 35°C flow temperature.

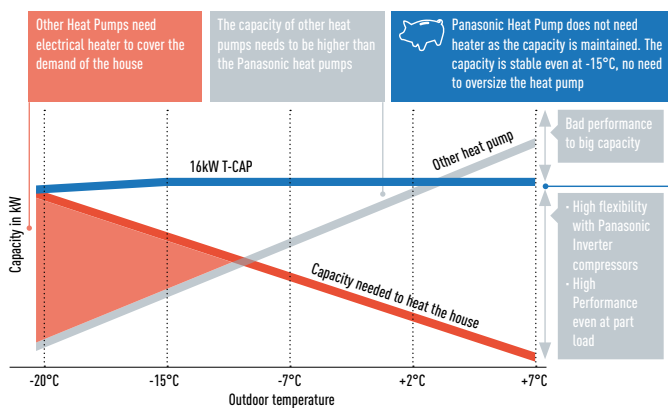

**Applications**



For retrofit houses. Easy to replace expensive gas or oil boilers for high efficient 16kW T-CAP.



For commercial applications. Wide range of capacities from 9kW to 45kW. Also you are able to connect up to five Heat Pumps.



For heating and cooling mode. The 16kW is able to heat the water at 60°C and can work when the temperature is as low as -28°C.



For heating and domestic hot water. Efficient domestic hot water tanks allow large storage for high consumption of hot water.

# AQUAREA HT



Aquarea HT can produce a flow temperature of 65°C making it the ideal high efficiency replacement for oil/gas boilers connected to high temperature radiators.

**Green energy source works with existing radiators**

The Aquarea HT (9kW & 12kW) allows you to replace your traditional heating source (such as oil or gas) while keeping the existing old style radiators for minimum disruption to the home.

**Aquarea HT: High savings and low CO<sub>2</sub>**

The benefit of replacing a traditional heating systems with Aquarea HT are clear: Reduced CO<sub>2</sub> emissions, future proofing running costs. Panasonic Heat Pumps are much more efficient than fossil fueled boilers and help you to reach your house energy targets.

**Yearly savings with Aquarea HT**

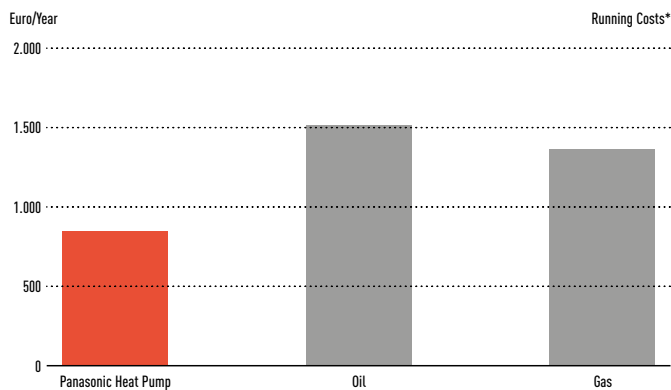

\* For a 170m<sup>2</sup> house and 40 W/m<sup>2</sup> energy losses in central Europe Conditions, outside minimum conditions -10°C.

**Panasonic Aquarea HT is highly efficient even at low outdoor temperatures**

Heating Capacity of a 9kW HT (WH-SHF09F3E5).

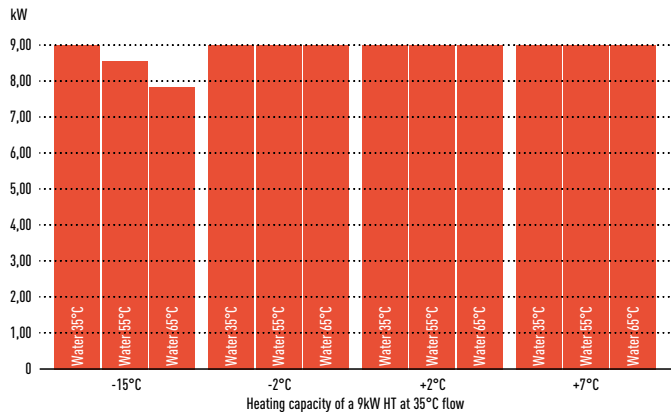

**Smart Bivalent operation**

Using the Aquarea bivalent controller, it is now possible to combine different heat sources (boiler with heat pump) allowing to set up the system to operate in the most efficient way.



**Heat Pump + Boiler with DHW cylinder controlled by the smart bivalent controller.**

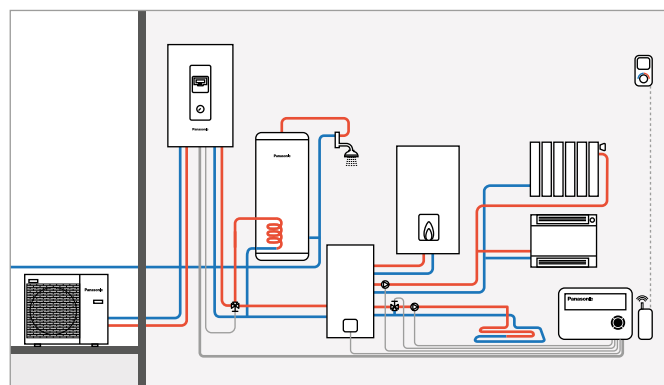

**Easy installation**

Air source Heat Pumps are simple to install. They do not require a chimney, gas connection or oil/lpg tank. All that is required is a power supply connection.

COP (Coefficient of Performance) of a 9kW HT (WH-MHF09G3E5).

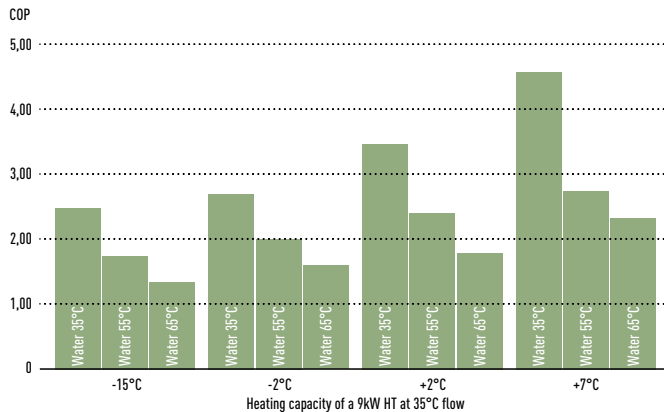

The Aquarea HT range is easy to install and is available with nominal heat outputs of 9kW or 12kW. These can be either single or three phase, in both Bi-bloc and Mono-bloc versions. The HT is also very quiet in operation with minimal noise inside the house due to no double stage compression cycle.



# AQUAREA COMMERCIAL

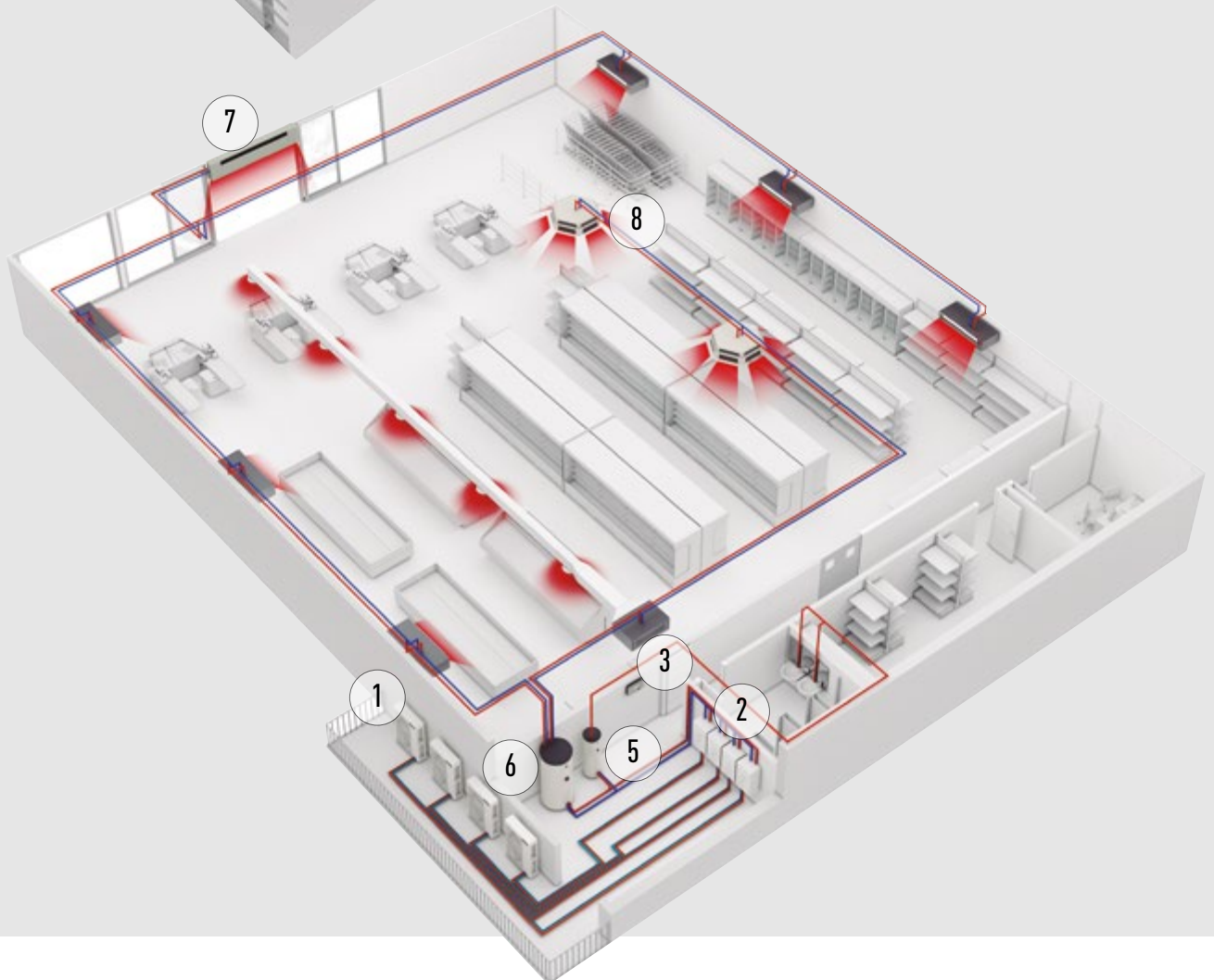
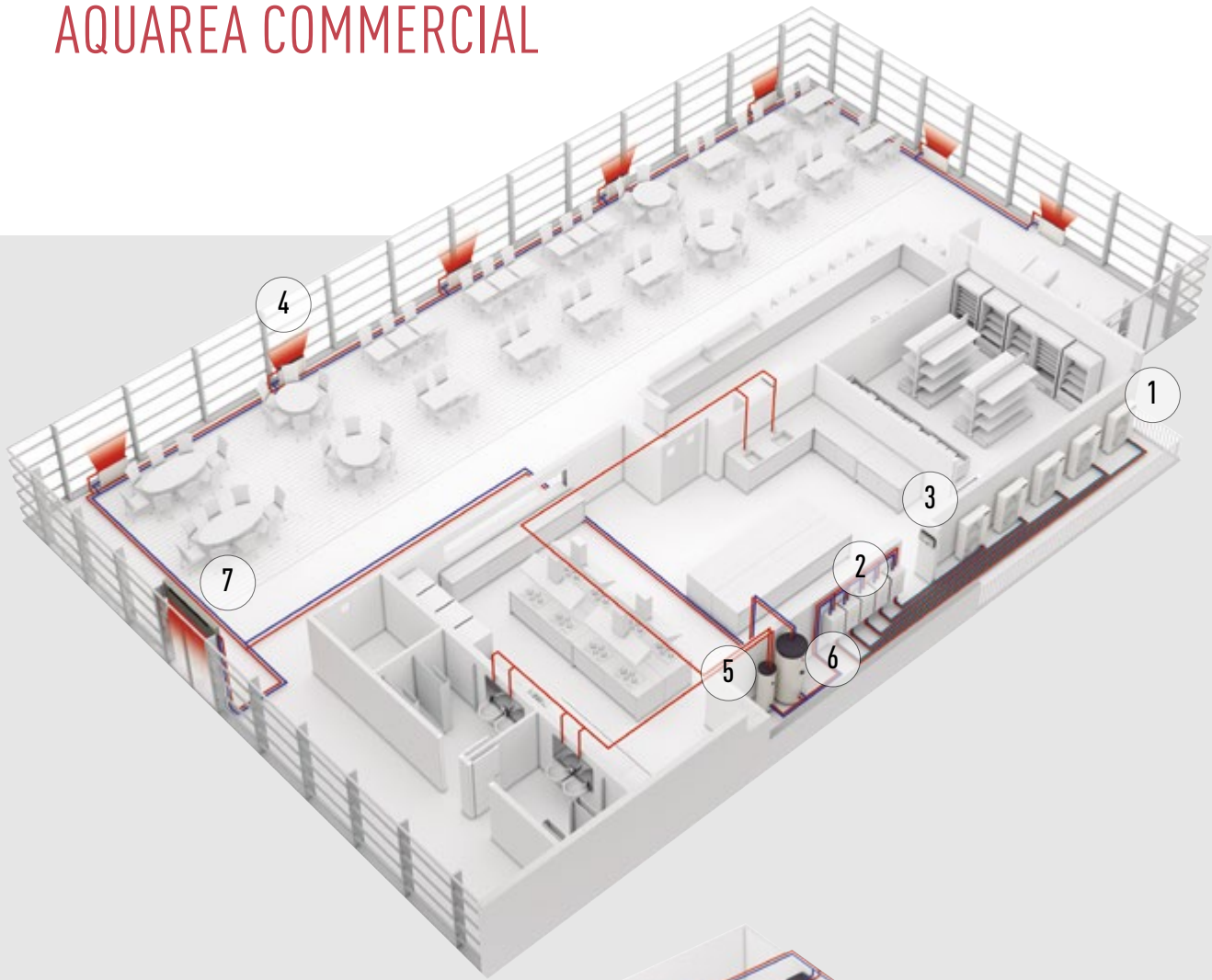

**Solutions for best savings. Efficient Panasonic Heat Pumps can help to significantly reduce the energy consumption of your business. Recent improvements to air source Heat Pump technology, including compact single unit systems, can provide an ideal housing and commercial solution.**

They offer space saving, energy-efficient heating and can be easily adapted for installation in flats, houses and commercial premises. Businesses producing heat, such as restaurants, installing an Aquarea Heat Pump system can also use this wasted heat to improve energy efficiency further.

**Restaurant with Aquarea**

If you are looking for savings for your business, Aquarea is the right choice! Ideal for heating, cooling and for production of big quantities of hot water at 65°C, Aquarea have a extremely quick return on investment and a low CO<sub>2</sub> footprint.

**Key points:**

- Produce hot water efficiency
- Fast return of investment
- Easy control
- Cascade management for higher durability of the system

\* 1 HPM can control 3 HP, on this case 2 HPM are needed

**Supermarket with Aquarea**

Heat pump technology is scalable, meaning that it can be installed in buildings of varying sizes, offering both small- and large-scale heating solutions. The technology is also environmentally friendly when compared to existing technologies, offering demonstrable energy-use and emissions savings and in most cases; will deliver operational cost savings when compared with fossil fuel alternatives.

**Can be integrated in the water system.**

Easy connection to existing system

- Fan Coils
- Floor Heating
- 4 way and 2 way convectors
- Domestic hot water tanks
- High efficiency
- Very good part load management
- Cascade management for higher durability of the system

\* 1 HPM can control 3 HP, on this case 2 HPM are needed

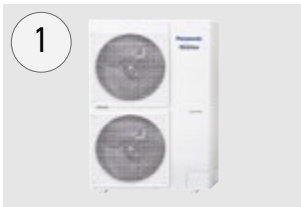

**Aquarea T-CAP.**  
Heat Pump 16kW on cascade mode.



**High Efficiency Aquarea Hydrokit.**



**HPM to control the Heat Pumps on cascade mode\*.**



**High efficiency Aquarea Air radiators.**  
32% more efficient than standard radiators.



**Super high efficiency Tanks.**  
From 200L to 500L for domestic hot water.

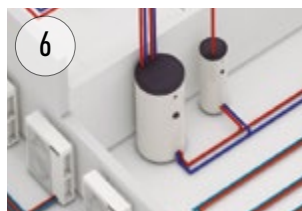

**Buffer Tank of 1.000L.**



**Air Curtain with DX Coil.**  
Designed for smooth operation and efficient performance.



**Convectors.**

**Case study: Carluccio's restaurant**

On of UK's leading Italian restaurant, Carluccio's, wanted to install a system which would provide the desired volume of hot water, at the correct temperature while at the same time reduced energy costs. Previous restaurants in the chain had been fitted with a more traditional 12kW boiler system. FWP installed a 12kW Aquarea T-CAP mono bloc unit which would allow for the free air from the kitchen roof space to be transferred through

condensing unit providing hot water at the optimum temperature. With a high coefficient of performance (COP), the system returns an impressive 4kW of energy, for every kW used. This makes the Aquarea far more cost effective than a conventional heating system. To heat the water for their Leeds restaurant cost £3782 whilst at the Meadowhall site the comparable cost was just £951. These sizeable savings mean the site will see a return on investment in approximately 2 years.

# NEW AQUAREA SMART CLOUD FOR H GENERATION

## The most advanced heating control for today and for the future

### Easy and powerful energy management.

The Aquarea Smart Cloud is much more than a simple thermostat for switching a heating device on or off. It is a powerful and intuitive service for remotely controlling the full range of heating and hot water functions, including monitoring energy consumption.

New functions for maintenance companies will be added during 1st Half of 2018 making advanced remote maintenance available to users and companies using any device.

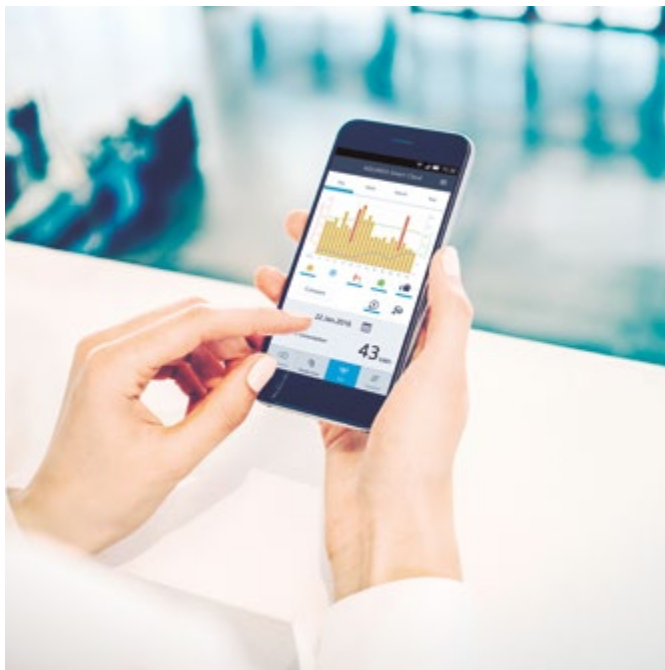

### Advantages

Energy savings, comfort and control from anywhere. Increase efficiency and resources management, operating costs savings and owner satisfaction. Throughout 2018 Panasonic will add new services to the Aquarea Smart Cloud focused on enabling full remote maintenance of the Aquarea system. This will allow maintenance specialists to engage in predictive maintenance and system fine-tuning, as well as fixing malfunctions when they occur.

Aquarea compatibility	H Generation
Connection point	CN-CNT Aquarea port
Home router connection	Wireless or Wired LAN
Temperature sensor	Can use remote controller sensor
Tablet or PC browser compatibility*	Yes
Operation from remote — On/Off — House Temp setting mode selection — DHW setting — Error codes — Scheduling	Yes
Heating areas	Up to 2 zones
Power consumption estimation — Operation log history	Yes — Yes

\* Check browsers and version compatibility.

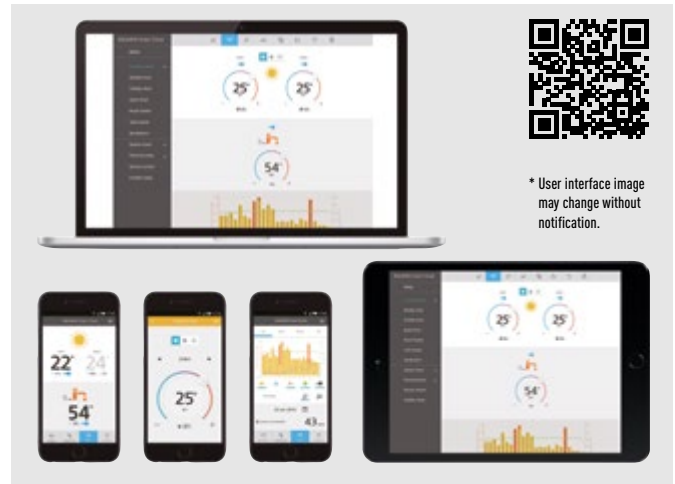

\* User interface image may change without notification.

### How it works?

Connect Aquarea H Generation system to the cloud using wireless LAN or a wired LAN Network. User connects to the Cloud portal to remotely operate all unit functions and can also permit partners to access customised functions for remote maintenance and monitoring. See demo: <https://aquarea.aircon.panasonic.eu>

### Requirements:

1. H Generation Aquarea system
2. In-house internet connection with router wireless LAN or wired LAN
3. Get a Panasonic ID in <https://aquarea-smart.panasonic.com/>

### 2 step introduction with same hardware: CZ-TAW1

	Step 1	Step 2 (during 2018) Same CZ-TAW1 hardware. Changes implemented in the cloud server.
<b>End User management and energy control</b>		
Visualization & Control	✓	—
Scheduling	✓	—
Energy Statistics	✓	—
Malfunction notification	✓	—
<b>Advanced functions for remote maintenance with professional screens<sup>1</sup></b>		
Monitoring	—	✓
Control	—	✓
Statistics (exportable)	—	✓
Remote Service	—	✓

1) Advanced functions not confirmed, final ones might differ from this list.



1. LAN  
2. Aquarea connection by CN-CNT



# CONTROL & CONNECTIVITY

Home connectivity and Home Managements Systems integration is becoming more and more popular. These integrations helps to control all house devices from centralised platform and helps to optimise the operation and running costs. Panasonic interfaces are made to work with

both Modbus and KNX, the most popular protocols. Also for non integrated control, Panasonic developed a simple connection to Wireless LAN, with this End User can control remotely its own heat pump from wherever.

## Internet Control

### What's Internet Control?

Aquarea heat pumps can be connected to Internet thru wireless LAN. When connection is done unit can be controlled from wherever and whenever with just Computer or Smartphone. Offering full system operation and error code messages, CZ-TAW1 offers full scheduling and powerful consumption stats. This device is ready for future improvements in the server, bringing advanced new functions for remote maintenance. This advanced features will bring quicker service to user and time savings to installers and maintenance companies.



## Connectivity. Control by BMS

Great flexibility for integration into your KNX / Modbus projects allows fully bi-directional monitoring and control of all the functioning parameters.

### Interface to connect Aquarea to KNX.

Reference: PAW-AW-KNX-1i / PAW-AW-KNX-H.



These new interfaces allows full monitoring and control, bi-directional, of all the functioning parameters of Aquarea control from KNX installations.

- Small dimensions. / Quick installation and possibility of hidden installation
- External power not required
- Direct connection to the unit
- Fully KNX interoperable: Control and monitoring, from sensors or gateways, of the internal variables of the indoor unit and error codes and indication
- Aquarea unit can be controlled simultaneously by its remote controller and by KNX Master devices

### Interface to connect Aquarea to Modbus.

## Modbus®

Reference: PAW-AW-MBS-1 / PAW-AW-MBS-H.

These new interfaces allows full monitoring and control, bi-directional, of all the functioning parameters of Aquarea control from Modbus installations.

- Small dimensions. / Quick installation and possibility of hidden installation
- External power not required
- Direct connection to the unit
- Fully Modbus interoperable: Control and monitoring, from any BMS or PLC Modbus Master, of internal variables of the indoor unit and error codes and indication
- Aquarea unit can be controlled simultaneously by its remote controller and by Modbus Master devices

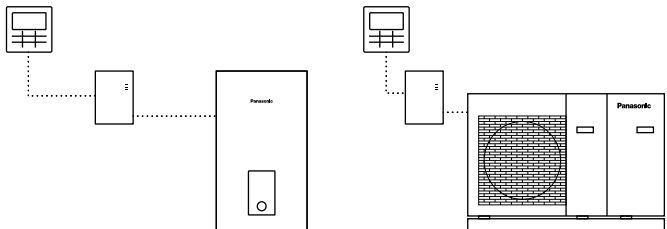

Model name	Interface
PAW-AW-KNX-H	KNX interface for H Generation
PAW-AW-MBS-H	Modbus interface for H Generation
PAW-AW-KNX-1i	KNX interface (not compatible with H Generation)
PAW-AW-MBS-1	Modbus interface (not compatible with H Generation)
PA-AW-WIFI-TE1	Internet control Wifi connection (not compatible with H Generation)
CZ-TAW1	Aquarea Smart Cloud, H Generation Internet control through Wifi or wired LAN

# REMOTE CONTROLLER



## Advanced controller for H Generation

**Improved visibility & easy operation by full dotted LCD panel and large touch panel!**

Remote controller can be removed from indoor unit and installed in living room.

### Key Points:

- Full dot big LCD screen (3,5 inch)
- High resolution screen with backlight
- Easy set up
- Check conditions easily even at the living room
- Flat, innovative design
- Temperature Sensor included in controller

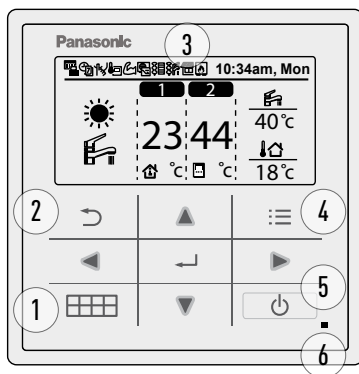

1. Quick Menu button (For more details, refer to the separate Quick Menu Guide)
2. Back button. Returns to the previous screen
3. LCD Display
4. Main Menu button. For function setup
5. ON/OFF button. Starts/Stops operation
6. Operation indicator. Illuminates during operation, blinks during alarm



## Remote controller for F and G Generation

Panasonic has introduced a new remote controller to improve performance, enhance comfort and deliver maximum savings.

### New function for installer:

- Floor heating concrete dry mode: Allows slow increase in temperature of floor heating via software
- Heating and Cooling Mode: Authorized service partner or Authorized installer can enable the cooling mode through a special operation via the remote controller on site
- Pump with 7 speeds: Pump speed can be selected on the remote controller

### New function for end user:

- Auto Mode: Automatically changes from heating to cooling depending on outdoor temperature.
- Energy Consumption: Displays the heat pump's energy consumption, split by heating, cooling and domestic hot water, and shows total consumption figure
- Holiday Mode: Enables the system to resume at the preset temperature after your holiday

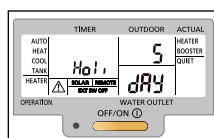
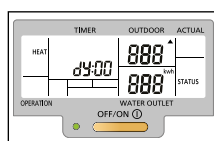

## New Remote controller changing point.

### Better user interface:

1. Adding Holiday Mode
  2. Adding Power Consumption
- ### LCD display:
1. Expand LCD display to show mode on left and right side
  2. Adding AUTO mode and remove defrost display (using heat blink)
  3. Change not available into EXT SW OFF
  4. Adding kWh and Hr
- ### Button:
5. Adding holiday button
  6. Change force and error reset position

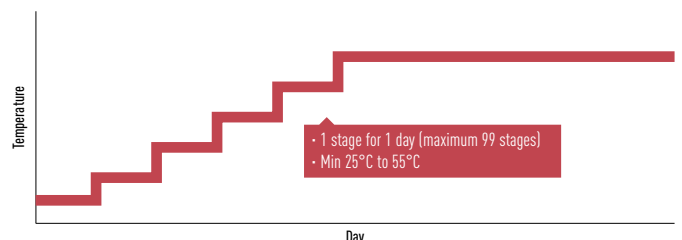
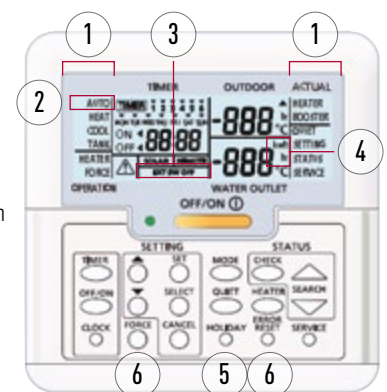

# HEAT PUMP MANAGER



Connected to a router, all information of the heating system controlled by the HPM is available via the internet. Installers, service companies and end-users can monitor the installation remotely.

Panasonic has developed a new easy start up mode for the HPM. Start your bivalent system in just 10 minutes!

## Easy Installation & Easy Configuration

Ready: Pre-programmed with up to 610 applications/system diagrams

Steady: At start up - state the number of application/system diagram

Go: The controller starts working according to selected diagram

## The next generation of Aquarea Manager

This new generation of smart controllers for eco-efficient heating features our versatile stand-alone controller for heating and domestic hot water.

## Panasonic offers:

Trends. Statistics. Consumption Energy Management-Optimization. Alarm. Handling + Maintenance. Complete documentation etc.



## Key points:

- Easy selection with the "ready to go" system
- Up to 610 preconfiguration installations available on [www.panasonicproclub.com](http://www.panasonicproclub.com)
- Cascade system possible for big installations
- Bivalent control in order to also manage gas boilers
- Able to control 2 mixed heated zones
- Smart grid ready
- Solar panel mode in order to produce heat when the PV is generating electricity
- Online access with control of all parameters
- Easy installation, needing less than 3 minutes to configure a complex system

## Technical Specification:

- New function: Smart Setup
- Control of 2 x Mixed Heating Circuits
- Floor screed dry program
- Cascade/bivalent controller
- Automatic switch from heating to cooling mode
- Night shift: - Internal Energy Manager
- Solar collector control
- Domestic hot water priority
- Easy to startup – easy to operate
- 7 output relays
- 0-10 V In/Output Signal
- 8 Sensor inputs (PT1000)
- USB interface (upload, service, remote controller, trend)
- RS485 interface (com. with additional heat pump)
- RS485 interface (for external display)
- Built-in backlit text display

## Easy mounting.

Simple mounting without screws in the cabinet/door or on DIN-rail. Also possible to mount directly on to the wall.





# AQUAREA + PV PANELS

**Key points:**

- Increases the amount of self-consumed electricity from the solar system up to 120%
- Control the heat pump's energy consumption according to the output of electricity from the PV considering the electric energy consumption requirement of the house
- Innovative algorithm balancing the heat pump's consumption and the in-house comfort, based on the outside temperature and the energy demand of the building
- Easy configuration of the Heat Pump manager system with the PV system

**For F and G Generation**

Panasonic has developed an innovative algorithm for its HPM (Heat Pump Manager) which drastically improves the Heat Pump's use of self-generated electricity from connected Photovoltaic panels. The Heat Pump will take the electricity generation by the solar system into consideration for the heating system and the domestic hot water production, without reducing comfort in the house.



**For H Generation**

Aquarea H Generation can synchronize with PV panel with simple CZ-NS4P PCB. A part of converting Aquarea in Smart Grid Ready, there is a new advantage, this new PCB allows 0-10V control. With this Aquarea demand is adapting all moment with the PV Panel production.



## Produce and heat Domestic Hot Water for free.

### Comparison on new housing.

Increase usage of self production by: 120%

The Panasonic Aquarea PV Control could increase the energy consumption of the heat pump coming from the Photovoltaic Panels from 352kWh to 775kWh a year. Results of simulations:

#### New building Frankfurt (non-optimized).

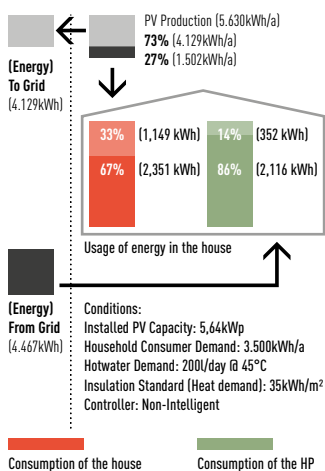

#### New building Frankfurt (optimized-eco).

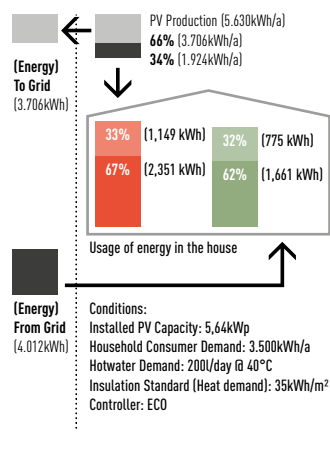

### Comparison on old housing.

Increase usage of self production by: 71%

The Panasonic Aquarea PV Control could increase the energy consumption of the heat pump coming from the Photovoltaic Panels from 526kWh to 898kWh a year. Results of simulations:

#### Old building Frankfurt (non-optimized).

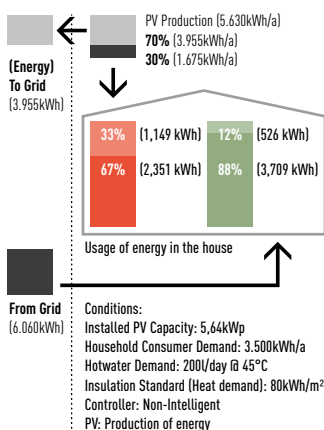

#### Old building Frankfurt (optimized-eco).

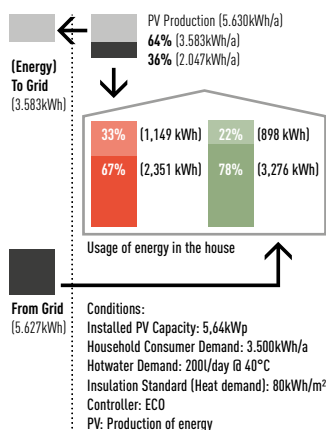

### PV + HP control

How to create added value of the combination PV+HP?

- Optimize the HP considering the PV production
- When the PV is producing enough to cover the HP consumption, then Tank mode will be forced to heat up the DHW to 55 or 65 degrees
- If buffer tank on the installation, temperature on the buffer tank will increase 1-to 5 degrees or up to 55°C.

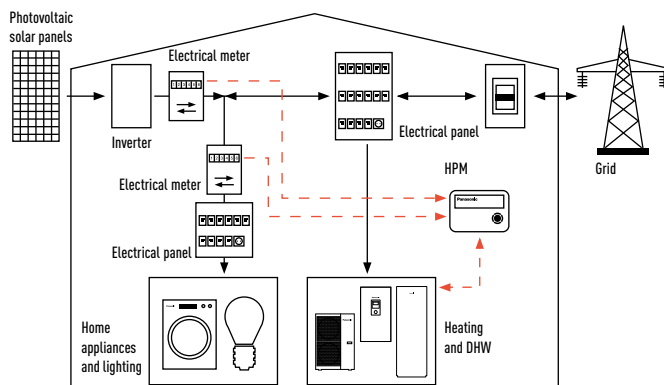

### Standard combination PV+HP. Why the Panasonic Aquarea PV Control can increase by 120% the performance of the combination PV+HP.



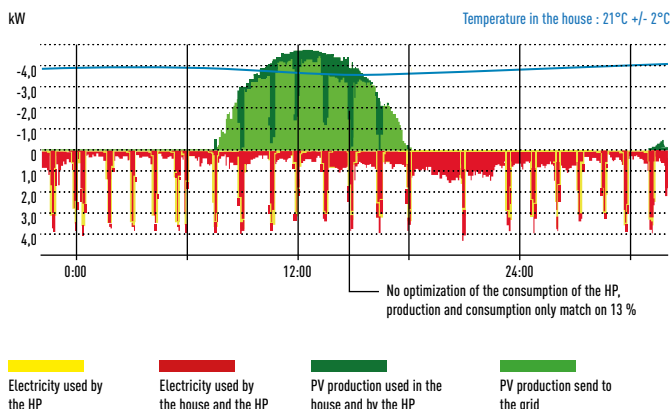



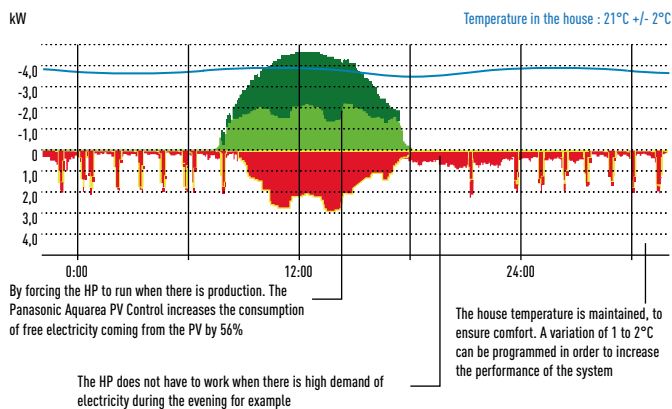









Typical Electricity consumption and production profile without Panasonic Aquarea PV Control.



Typical Electricity consumption and production profile optimized by the Panasonic Aquarea PV Control.





















































# AQUAREA HEAT PUMPS LINE-UP

			3kW	5kW
<b>Aquarea High Performance</b> for well insulated houses 	<b>All in One</b> Single Phase Three Phase	<b>Heating, cooling and DHW</b> 	 WH-ADC0309H3E5 WH-ADC0309H3E5B WH-UD03HE5-1	 WH-ADC0309H3E5 WH-ADC0309H3E5B WH-UD05HE5-1
	<b>Bi-bloc</b> Single Phase Three Phase	<b>Heating and cooling</b> 	 WH-SDC03H3E5(-1) WH-UD03HE5(-1)	 WH-SDC05H3E5(-1) WH-UD05HE5(-1)
	<b>Mono-bloc</b> Single Phase	<b>Heating and cooling</b> 		 WH-MDC05H3E5 WH-MDC05F3E5
<b>Aquarea T-CAP High</b> Capacity for cold areas 	<b>All in One</b> Single Phase Three Phase	<b>Heating, cooling and DHW</b> 		
	<b>Bi-bloc</b> Single Phase Three Phase	<b>Heating and cooling</b> 		
	<b>Mono-bloc</b> Single Phase Three Phase	<b>Heating and cooling</b> 		
<b>Aquarea HT for retrofit</b> 	<b>Bi-bloc</b> Single Phase Three Phase	<b>Heating only</b> 		
	<b>Mono-bloc</b> Single Phase	<b>Heating only</b> 		

WH-\_\_E5 Single Phase // WH-\_\_E8 Three Phase. 1) All in One G Generation model. 2) Hydrokit F Generation model.



	7kW	9kW	12kW	16kW
	  <p>WH-ADC0309H3E5 WH-ADC0309H3E5B WH-UD07HE5-1</p>	  <p>WH-ADC0309H3E5 WH-ADC0309H3E5B WH-UD09HE5-1 WH-ADC0916H9E8 WH-UD09HE8</p>	  <p>WH-ADC1216H6E5 WH-UD12HE5 WH-ADC1216G6E5<sup>1</sup> WH-UD12FE5 WH-ADC0916H9E8 WH-UD12HE8</p>	  <p>WH-ADC1216H6E5 WH-UD16HE5 WH-ADC1216G6E5<sup>1</sup> WH-UD16FE5 WH-ADC0916H9E8 WH-UD16HE8</p>
	  <p>WH-SDC07H3E5(-1) WH-UD07HE5(-1)</p>	  <p>WH-SDC09H3E5(-1) WH-UD09HE5(-1) WH-SDC09H3E8 WH-UD09HE8</p>	  <p>WH-SDC12H6E5 WH-UD12HE5 WH-SDC12H9E8 WH-UD12HE8</p>	  <p>WH-SDC16H6E5 WH-UD16HE5 WH-SDC16H9E8 WH-UD16HE8</p>
	  <p>WH-MDC07H3E5 WH-MDC06G3E5 (6kW)</p>	  <p>WH-MDC09H3E5 WH-MDC09G3E5</p>	  <p>WH-MDC12G6E5</p>	  <p>WH-MDC16G6E5</p>
		  <p>WH-ADC1216H6E5 WH-UX09HE5 WH-ADC0916H9E8 WH-UX09HE8</p>	  <p>WH-ADC1216H6E5 WH-UX12HE5 WH-ADC0916H9E8 WH-UX12HE8</p>	  <p>WH-ADC0916H9E8 WH-UX16HE8</p>
		  <p>WH-SXC09H3E5 WH-UX09HE5 WH-SXC09H3E8 WH-UX09HE8 WH-SQC09H3E8 WH-UD09HE8</p>	  <p>WH-SXC12H6E5 WH-UX12HE5 WH-SXC12H9E8 WH-UX12HE8 WH-SQC12H9E8 WH-UD12HE8</p>	  <p>WH-SXC16H9E8 WH-UX16HE8 WH-SQC16H9E8 WH-UD16HE8</p>
		  <p>WH-MXC09G3E5 WH-MXC09G3E8</p>	  <p>WH-MXC12G6E5 WH-MXC12G9E8</p>	  <p>WH-MXC16G9E8</p>
		  <p>WH-SHF09F3E5 WH-UH09FE5 WH-SHF09F3E8 WH-UH09FE8</p>	  <p>WH-SHF12F6E5 WH-UH12FE5 WH-SHF12F9E8 WH-UH12FE8</p>	
		  <p>WH-MHF09G3E5</p>	  <p>WH-MHF12G6E5</p>	

# AQUAREA ALL IN ONE H GENERATION HIGH PERFORMANCE BI-BLOC SINGLE PHASE / THREE PHASE. HEATING AND COOLING. 1 ZONE HYDROKIT OR 2 ZONES BUILT-IN HYDROKIT

Panasonic has developed a highly efficient solution, easy to install.

Aquarea All in One is the new generation of Panasonic Heat Pumps for Heating, Cooling and Domestic Hot Water (DHW). This new range intelligently integrates the best Hydrokit technology with a premium quality stainless steel tank.

### Technical focus

- **NEW!** Indoor Unit
- **NEW!** Touch Controller
- Space saving: 1.800 x 598 x 717 (H x W x D)

- Reduced installation costs
- Piping at the bottom of the All in One (easy to install)
- Reduced installation time and minimised installation errors
- Easy remote controller to set up
- Reduced installation spaces
- Electrical connections at the front
- Easier installation and maintenance
- New remote controller functions (cooling mode activation possible by software. This activation can only be done by service partner)



Kit	Single Phase (Power to indoor)						Three Phase (Power to indoor)			
	KIT-ADC03HE5	KIT-ADC05HE5	KIT-ADC07HE5	KIT-ADC09HE5	KIT-ADC12HE51*	KIT-ADC16HE51*	KIT-ADC9HE8²	KIT-ADC12HE8²	KIT-ADC16HE8²	
Heating capacity at +7°C (heating water at 35°C)	kW	3,20	5,00	7,00	9,00	12,00	16,00	9,00	12,00	16,00
COP at +7°C (heating water at 35°C)	W/W	5,00	4,63	4,46	4,13	4,74	4,28	4,84	4,74	4,28
Heating capacity at +2°C (heating water at 35°C)	kW	3,20	4,20	6,55	6,70	11,40	13,00	9,00	11,40	13,00
COP at +2°C (heating water at 35°C)	W/W	3,56	3,11	3,34	3,13	3,44	3,28	3,59	3,44	3,28
Heating capacity at -7°C (heating water at 35°C)	kW	3,20	4,20	5,15	5,90	10,00	11,40	9,00	10,00	11,40
COP at -7°C (heating water at 35°C)	W/W	2,69	2,59	2,68	2,52	2,73	2,57	2,85	2,73	2,57
Cooling capacity at 35°C (cooling water at 7/12°C)	kW	3,20	4,50	6,00	7,00	10,00	12,20	7,00	10,00	12,20
EER at 35°C (cooling water at 7/12°C)	W/W	3,08	2,69	2,63	2,43	2,81	2,56	3,17	2,85	2,56
Energy Efficiency Class at 35°C / at 55°C / at 55°C for DHW		A+++ / A++ / A	A+++ / A++ / A	A+++ / A++ / A	A+++ / A++ / A	A+++ / A++ / A	A+++ / A++ / A	A+++ / A++ / A	A+++ / A++ / A	A+++ / A++ / A
System label 35°C / 55°C³		A+++ / A++ / A	A+++ / A++ / A	A+++ / A++ / A	A+++ / A++ / A	A+++ / A++ / A	A+++ / A++ / A	A+++ / A++ / A	A+++ / A++ / A	A+++ / A++ / A
<b>Indoor unit 1 zone</b>		WH-ADC0309H3E5	WH-ADC0309H3E5	WH-ADC0309H3E5	WH-ADC0309H3E5	WH-ADC1216H6E5	WH-ADC1216H6E5	WH-ADC0916H9E8	WH-ADC0916H9E8	WH-ADC0916H9E8
<b>Indoor unit 2 zones</b>		WH-ADC0309H3E5B	WH-ADC0309H3E5B	WH-ADC0309H3E5B	WH-ADC0309H3E5B	—	—	—	—	—
Sound pressure	Heating / Cooling	dB(A)	28 / 28	28 / 28	28 / 28	28 / 28	33 / 33	33 / 33	33 / 33	33 / 33
Dimensions* / Net Weight*	H x W x D	mm / kg	1.800 x 598 x 717 / 124	1.800 x 598 x 717 / 124	1.800 x 598 x 717 / 124	1.800 x 598 x 717 / 124	1.800 x 598 x 717 / —	1.800 x 598 x 717 / 126	1.800 x 598 x 717 / 126	1.800 x 598 x 717 / 126
Water pipe connector		mm	R 1 ¼	R 1 ¼	R 1 ¼	R 1 ¼	R 1 ¼	R 1 ¼	R 1 ¼	R 1 ¼
A class Pump	Number of speeds		Variable Speed	Variable Speed	Variable Speed	Variable Speed	Variable Speed	Variable Speed	Variable Speed	Variable Speed
	Input power (Min / Max)*	W	30 / 120	30 / 120	30 / 120	30 / 120	36 / 152	36 / 152	36 / 152	36 / 152
Heating water flow (ΔT=5 K, 35°C)		l/min	9,2	14,3	20,1	25,8	34,4	45,9	25,8	34,4
Capacity of integrated electric heater		kW	3	3	3	3	6	6	9	9
Recommended Fuse		A	15 / 15	15 / 15	30 / 15	30 / 15	30 / 30	30 / 30	16 / 16	16 / 16
Recommended cable size, supply 1 & 2		mm²	3 x 1,5 / 3 x 1,5	3 x 1,5 / 3 x 1,5	3 x 2,5 / 3 x 1,5	3 x 2,5 / 3 x 1,5	3 x 4,0 / 3 x 4,0	3 x 4,0 / 3 x 4,0	5 x 1,5 / 5 x 1,5	5 x 1,5 / 5 x 1,5
Water volume		L	185	185	185	185	185	185	185	185
Maximum water temperature		°C	65	65	65	65	65	65	65	65
Material inside tank			Stainless steel	Stainless steel	Stainless steel	Stainless steel	Stainless steel	Stainless steel	Stainless steel	Stainless steel
<b>Outdoor Unit</b>			WH-UD03HE5-1	WH-UD05HE5-1	WH-UD07HE5-1	WH-UD09HE5-1	WH-UD12HE5	WH-UD16HE5	WH-UD09HE8	WH-UD12HE8
Sound pressure	Heating / Cooling	dB(A)	48 / 47	49 / 48	50 / 48	51 / 50	52 / 50	55 / 54	51 / 49	52 / 50
Sound power level	Heating / Cooling	dB	64 / 65	65 / 66	68 / 66	69 / 68	67 / 68	70 / 72	68 / 67	69 / 68
Dimensions / Weight	H x W x D	mm / kg	622 x 824 x 298 / 39	622 x 824 x 298 / 39	795 x 900 x 320 / 66	795 x 900 x 320 / 66	1.340 x 900 x 320 / 101	1.340 x 900 x 320 / 101	1.340 x 900 x 320 / 107	1.340 x 900 x 320 / 107
Refrigerant (R410A)		kg / TCO₂ Eq.	1,20 / 2,506	1,20 / 2,506	1,45 / 3,028	1,45 / 3,028	2,55 / —	2,55 / —	2,55 / 5,324	2,55 / 5,324
Pipe diameter	Liquid / Gas	Inch (mm)	1/4 (6,35) / 1/2 (12,7)	1/4 (6,35) / 1/2 (12,7)	1/4 (6,35) / 5/8 (15,88)	1/4 (6,35) / 5/8 (15,88)	3/8 (9,52) / 5/8 (15,88)	3/8 (9,52) / 5/8 (15,88)	3/8 (9,52) / 5/8 (15,88)	3/8 (9,52) / 5/8 (15,88)
Pipe length range / Elevation difference (in/out)		m	3 - 15 / 5	3 - 15 / 5	3 - 30 / 20	3 - 30 / 20	3 - 30 / 20	3 - 30 / 20	3 - 30 / 20	3 - 30 / 20
Pipe length for additional gas / Additional gas amount		m / g/m	10 / 20	10 / 20	10 / 30	10 / 30	10 / 50	10 / 50	10 / 50	10 / 50
Operation range	Outdoor ambient	°C	-20 ~ +35	-20 ~ +35	-20 ~ +35	-20 ~ +35	-20 ~ +35	-20 ~ +35	-20 ~ +35	-20 ~ +35
Water outlet	Heating / Cooling	°C	25 - 55 / 5 - 20	25 - 55 / 5 - 20	25 - 55 / 5 - 20	25 - 55 / 5 - 20	25 - 55 / 5 - 20	25 - 55 / 5 - 20	25 - 55 / 5 - 20	25 - 55 / 5 - 20

### Accessories

<b>PAW-ADC-PREKIT-1</b>	Pre installation kit for piping
<b>PAW-ADC-CV150</b>	Decorative magnetic side cover
<b>CZ-NS4P</b>	Additional functions PCB

### Accessories

<b>CZ-TAW1</b>	Aquarea Smart Cloud, H Generation Internet control through Wifi or wired LAN
<b>PAW-A2W-RTWIRED</b>	Room thermostat

COP classification is at 230V only in accordance with EU directive 2003/32/EC. Sound pressure measured at 1m from the outdoor unit and at 1,5m height. Heating sound pressure measured at +7°C (heating water at 55°C). Performance in agreement with EN14511. Insulated tested under EN12897. 1) Available in August 2017. 2) Available in March 2017. 3) System label with controller. \* Tentative data.



INTERNET CONTROL: Optional.

# AQUAREA ALL IN ONE H GENERATION T-CAP BI-BLOC SINGLE PHASE / THREE PHASE. HEATING AND COOLING



## Benefits of the T-CAP All in One unit!

Aquarea T-CAP can work in extreme outdoor conditions as low as -28°C and warranty the capacity without back up heating down to -20°C. Ready to work at extreme outdoor conditions the H Generation T-CAP can produce water up to 60°C, expanding its possibilities for retrofit application. On top of All in One Aquarea unique advantages, the quickest installation in the market and easy maintenance including the outstanding inox tank maintenance free.

- Works at temperatures as low as -28°C
- Constant capacity up to -20°C
- Space saving: 1.800 x 598 x 717 (H x W x D)
- Reduced installation costs
- Piping at the bottom of the All in One (easy to install)
- Reduced installation time and minimised installation errors
- Easy remote controller to set up
- Reduced installation spaces
- Electrical connections at the front
- Easier installation and maintenance
- 1 phase and 3 phase
- New remote controller functions (cooling mode activation possible by software. This activation can only be done by service partner)

## Technical focus

- **NEW!** Indoor Unit
- **NEW!** Touch Controller

Kit	Single Phase (Power to indoor)			Three Phase (Power to indoor)		
	KIT-AXC9HE5 <sup>1</sup>	KIT-AXC12HE5 <sup>1</sup>	KIT-AXC9HE8 <sup>2</sup>	KIT-AXC12HE8 <sup>2</sup>	KIT-AXC16HE8 <sup>2</sup>	
Heating capacity at +7°C (heating water at 35°C)	kW	9,00	12,00	9,00	12,00	16,00
COP at +7°C (heating water at 35°C)	W/W	4,84	4,74	4,84	4,74	4,28
Heating capacity at +2°C (heating water at 35°C)	kW	9,00	12,00	9,00	12,00	16,00
COP at +2°C (heating water at 35°C)	W/W	3,59	3,44	3,59	3,44	3,10
Heating capacity at -7°C (heating water at 35°C)	kW	9,00	12,00	9,00	12,00	16,00
COP at -7°C (heating water at 35°C)	W/W	2,85	2,72	2,85	2,72	2,49
Cooling capacity at 35°C (cooling water at 7/12°C)	kW	7,00	10,00	7,00	10,00	12,20
EER at 35°C (cooling water at 7/12°C)	W/W	3,17	2,81	3,17	2,81	2,57
Energy Efficiency Class at 35°C / at 55°C / at 55°C for DHW		A++ / A++ / A	A++ / A++ / A	A++ / A++ / A	A++ / A++ / A	A++ / A++ / A
System label 35°C / 55°C <sup>3</sup>		A+++ / A++	A+++ / A++	A+++ / A++	A+++ / A++	A+++ / A++
<b>Indoor unit</b>		<b>WH-ADC1216H6E5</b>	<b>WH-ADC1216H6E5</b>	<b>WH-ADC0916H9E8</b>	<b>WH-ADC0916H9E8</b>	<b>WH-ADC0916H9E8</b>
Sound pressure	Heating / Cooling	dB(A)	33 / 33	33 / 33	33 / 33	33 / 33
Dimensions* / Net Weight*	H x W x D	mm / kg	1.800 x 598 x 717 / 137	1.800 x 598 x 717 / 137	1.800 x 598 x 717 / 126	1.800 x 598 x 717 / 126
Water pipe connector		mm	R 1 1/2	R 1 1/2	R 1 1/2	R 1 1/2
A class pump	Number of speeds		Variable Speed	Variable Speed	Variable Speed	Variable Speed
	Input power (Min / Max)*	W	36 / 152	36 / 152	36 / 152	36 / 152
Heating water flow (ΔT=5 K, 35°C)		L/min	25,8	34,4	25,8	34,4
Capacity of integrated electric heater		kW	6	6	9	9
Recommended fuse		A	30 / 30	30 / 30	16 / 16	16 / 16
Recommended cable size, supply 1 & 2		mm <sup>2</sup>	3 x 4,0 / 3 x 4,0	3 x 4,0 / 3 x 4,0	5 x 1,5 / 5 x 1,5	5 x 1,5 / 5 x 1,5
Water volume		L	185	185	185	185
Maximum water temperature		°C	65	65	65	65
Material inside tank			Stainless steel	Stainless steel	Stainless steel	Stainless steel
<b>Outdoor Unit</b>			<b>WH-UX09HE5</b>	<b>WH-UX12HE5</b>	<b>WH-UX09HE8</b>	<b>WH-UX12HE8</b>
Sound pressure	Heating / Cooling	dB(A)	51 / 49	52 / 50	51 / 49	52 / 50
Sound power level	Heating / Cooling	dB			68 / 67	69 / 68
Dimensions / Weight	H x W x D	mm / kg	1.340 x 900 x 320 / 101	1.340 x 900 x 320 / 101	1.340 x 900 x 320 / 108	1.340 x 900 x 320 / 108
Refrigerant (R410A)		kg / TCO <sub>2</sub> Eq.	2,85 / 5,951	2,85 / 5,951	2,85 / 5,951	2,85 / 5,951
Pipe diameter	Liquid / Gas	Inch (mm)	3/8 (9,52) / 5/8 (15,88)	3/8 (9,52) / 5/8 (15,88)	3/8 (9,52) / 5/8 (15,88)	3/8 (9,52) / 5/8 (15,88)
Pipe length range / Elevation difference (in/out)		m	3 - 30 / 20	3 - 30 / 20	3 - 30 / 20	3 - 30 / 20
Pipe length for additional gas / Additional gas amount		m / g/m	10 / 50	10 / 50	10 / 50	10 / 50
Operation range	Outdoor ambient	°C	-28 ~ +35	-28 ~ +35	-28 ~ +35	-28 ~ +35
Water outlet	Heating / Cooling	°C	25 - 60 / 5 - 20	25 - 60 / 5 - 20	25 - 60 / 5 - 20	25 - 60 / 5 - 20

## Accessories

<b>PAW-ADC-PREKIT-1</b>	Pre installation kit for piping
<b>PAW-ADC-CV150</b>	Decorative magnetic side cover
<b>CZ-NS4P</b>	Additional functions PCB

## Accessories

<b>CZ-TAW1</b>	Aquarea Smart Cloud, H Generation Internet control through Wifi or wired LAN
<b>PAW-AZW-RTWIRED</b>	Room thermostat

COP classification is at 230V only in accordance with EU directive 2003/32/EC. Sound pressure measured at 1m from the outdoor unit and at 1,5m height. Heating sound pressure measured at +7°C (heating water at 55°C). Performance in agreement with EN14511. Insulated tested under EN12897. 1) Available in July 2017. 2) Available in March 2017. 3) System label with controller. \* Tentative data.

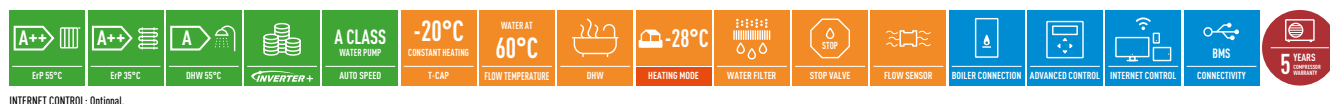

INTERNET CONTROL: Optional.



# AQUAREA H GENERATION HIGH PERFORMANCE BI-BLOC SINGLE PHASE / THREE PHASE. HEATING AND COOLING - SDC

NEW TECHNOLOGY  
17

The new H Generation are specially designed for low energy homes and achieve an impressive COP of 5 (on the 3,2kW).

Thanks to the system's high degree of technology and advanced control, it is able to maintain a high capacity and efficiency even at -7°C and -15°C. The Aquarea's software is optimised to the requirements of low consumption homes in order to maximise energy efficiency. Whatever the weather, Aquarea can work even at -20°C. The compact design of the outdoor unit makes installation very easy.

### Technical focus

- **NEW!** Touch Controller
- **NEW!** Indoor Unit
- Super efficient: COP of 5 in the 3,2kW!
- Very high energy savings A+++ (\*)
- Simple installation & maintenance
- Special software for low consumption homes with minimum output temperature: 20°C
- Works at temperatures as low as -20°C
- Automatic Air purge valve
- Display of the compressor frequency



WH-UD03HE5 (-1) WH-UD09HE5 (-1) WH-UD07HE5 (-1) WH-UD12HE5 WH-UD16HE5 WH-UD09HE5 WH-UD12HE5 WH-UD16HE5

Kit	Single Phase Heating and Cooling						Three Phase (Power to indoor)				
	KIT-WC03H3E5	KIT-WC05H3E5	KIT-WC07H3E5	KIT-WC09H3E5	KIT-WC12H6E5 <sup>1</sup>	KIT-WC16H6E5 <sup>1</sup>	KIT-WC09H3E8 <sup>1</sup>	KIT-WC12H9E8 <sup>1</sup>	KIT-WC16H9E8 <sup>1</sup>		
Heating capacity at +7°C (heating water at 35°C)	kW	3,20	5,00	7,00	9,00	12,00	16,00	9,00	12,00	16,00	
COP at +7°C (heating water at 35°C)	W/W	5,00	4,63	4,46	4,13	4,74	4,28	4,84	4,74	4,28	
Heating capacity at +2°C (heating water at 35°C)	kW	3,20	4,20	6,55	6,70	11,40	13,00	9,00	11,40	13,00	
COP at +2°C (heating water at 35°C)	W/W	3,56	3,11	3,34	3,13	3,44	3,28	3,59	3,44	3,28	
Heating capacity at -7°C (heating water at 35°C)	kW	3,20	4,20	5,15	5,90	10,00	11,40	9,00	10,00	11,40	
COP at -7°C (heating water at 35°C)	W/W	2,69	2,59	2,68	2,52	2,73	2,57	2,85	2,73	2,57	
Cooling capacity at 35°C (cooling water at 7/12°C)	kW	3,20	4,50	6,00	7,00	10,00	12,20	7,00	10,00	12,20	
EER at 35°C (cooling water at 7/12°C)	W/W	3,08	2,69	2,63	2,43	2,81	2,56	3,17	2,81	2,56	
Energy Efficiency Class at 35°C / 55°C		A+++ / A++	A+++ / A++	A+++ / A++	A+++ / A++	A+++ / A++	A+++ / A++	A+++ / A++	A+++ / A++	A+++ / A++	
System label 35°C / 55°C <sup>2</sup>		A+++ / A++	A+++ / A++	A+++ / A++	A+++ / A++	A+++ / A++	A+++ / A++	A+++ / A++	A+++ / A++	A+++ / A++	
<b>Indoor Unit<sup>3</sup></b>		<b>WH-SDC03H3E5 (-1)</b>	<b>WH-SDC05H3E5 (-1)</b>	<b>WH-SDC07H3E5 (-1)</b>	<b>WH-SDC09H3E5 (-1)</b>	<b>WH-SDC12H6E5</b>	<b>WH-SDC16H6E5</b>	<b>WH-SDC09H3E8</b>	<b>WH-SDC12H9E8</b>	<b>WH-SDC16H9E8</b>	
Sound pressure	Heating / Cooling	dB(A)		28 / 28		28 / 28		30 / 30		33 / 33	
Dimensions / Weight	H x W x D	mm / kg		892 x 500 x 340 / 44		892 x 500 x 340 / 44		892 x 500 x 340 / 44		892 x 500 x 340 / 45	
Water pipe connector		mm		R 1 1/4		R 1 1/4		R 1 1/4		R 1 1/4	
A class pump	Number of speeds	Variable Speed		Variable Speed		Variable Speed		Variable Speed		Variable Speed	
	Input power (Min / Max)	W		30 / 100		33 / 106		34 / 110		34 / 110	
Heating water flow (ΔT=5 K, 35°C)	L/min	9,2		14,3		20,1		25,8		34,4	
Capacity of integrated electric heater	kW	3		3		3		6		6	
Recommended fuse	A	15 / 30		15 / 30		15 / 30		15 / 30		15 / 30	
Recommended cable size, supply 1 & 2	mm <sup>2</sup>	3 x 1,5 / 3 x 1,5		3 x 1,5 / 3 x 1,5		3 x 1,5 / 3 x 1,5		3 x 1,5 / 3 x 1,5		3 x 1,5 / 3 x 1,5	
<b>Outdoor Unit<sup>3</sup></b>		<b>WH-UD03HE5 (-1)</b>	<b>WH-UD05HE5 (-1)</b>	<b>WH-UD07HE5 (-1)</b>	<b>WH-UD09HE5 (-1)</b>	<b>WH-UD12HE5</b>	<b>WH-UD16HE5</b>	<b>WH-UD09HE8</b>	<b>WH-UD12HE8</b>	<b>WH-UD16HE8</b>	
Sound pressure	Heating / Cooling	dB(A)		47 / 47		48 / 48		50 / 48		51 / 50	
Dimensions / Weight	H x W x D	mm / kg		622 x 824 x 298 / 39		622 x 824 x 298 / 39		795 x 900 x 320 / 66		795 x 900 x 320 / 66	
Refrigerant (R410A)	kg / TCO <sub>2</sub> Eq.	1,20 / -		1,20 / -		1,45 / -		1,45 / -		2,55 / -	
Pipe diameter	Liquid / Gas	Inch (mm)		1/4 (6,35) / 1/2 (12,7)		1/4 (6,35) / 1/2 (12,7)		1/4 (6,35) / 5/8 (15,88)		1/4 (6,35) / 5/8 (15,88)	
Pipe length range / Elevation difference (in/out)	m	3 - 15 / 5		3 - 15 / 5		3 - 30 / 20		3 - 30 / 20		3 - 30 / 20	
Pipe length for additional gas / Additional gas amount	m / g/m	10 / 20		10 / 20		10 / 30		10 / 30		10 / 50	
Operation range	Outdoor ambient	°C		-20 ~ +35		-20 ~ +35		-20 ~ +35		-20 ~ +35	
Water outlet	Heating / Cooling	°C		20 - 55 / 5 - 20		20 - 55 / 5 - 20		20 - 55 / 5 - 20		20 - 55 / 5 - 20	

### Accessories

<b>PAW-TD20C1E5</b>	Tank 200L - Stainless steel
<b>PAW-TD30C1E5</b>	Tank 300L - Stainless steel
<b>PAW-TG20C1E3STD-1</b>	Tank 200L - Enamelled
<b>PAW-TG30C1E3STD-1</b>	Tank 300L - Enamelled
<b>CZ-TK1</b>	Temperature sensor for 3rd party tank

### Accessories

<b>CZ-NV1</b>	3 way valve Kit for inside of hydrokit
<b>CZ-NS4P</b>	Additional functions PCB
<b>PAW-BTANK50L</b>	Buffer tank 50L
<b>CZ-TAW1</b>	Aquarea Smart Cloud, H Generation Internet control through Wifi or wired LAN
<b>PAW-A2W-RTWIRED</b>	Room thermostat

COP classification is at 230V only in accordance with EU directive 2003/32/EC. Sound pressure measured at 1m from the outdoor unit and at 1.5m height. Performance in agreement with EN14511.

Remark to energy efficiency class: These indications are based on the official ErP regulations [EU regulations N° 811/2013, EN 14511 and EN 14825] for heat pumps, which is officially binding from September 2015. Efficiency classes marked with \* would meet the new regulations from September 2019 to a classification as A+++.

A++  
ErP 55°C

A++  
ErP 35°C

INVERTER+

A CLASS  
WATER PUMP

5,00  
COP

-20°C  
DHW

HEATING MODE

WATER FILTER

STOP VALVE

FLOW SENSOR

BOILER CONNECTION

SOLAR KIT

ADVANCED CONTROL

INTERNET CONTROL

CONNECTIVITY

5 YEARS  
WARRANTY

INTERNET CONTROL: Optional.

# AQUAREA H GENERATION T-CAP BI-BLOC SINGLE PHASE / THREE PHASE. HEATING AND COOLING - SXC



The best for extreme outdoor conditions.  
Constant capacity at -20°C.

Aquarea T-CAP can work in extreme outdoor conditions as low as -28°C and warranty the capacity without back up heating down to 20°C. Ready to work at extreme outdoor conditions the H Generation T-CAP can produce water up to 60°C, expanding its possibilities for retrofit application. H Generation is the quickest to install and easiest maintenance.

### Technical focus

- **NEW!** Touch Controller
- **NEW!** Indoor Unit
- Very high energy savings A++
- Simple installation & maintenance
- Constant capacity up to -20°C
- Water temperature up to 60°C
- Special software for low consumption homes with minimum output temperature: 20°C
- Works at temperatures as low as -28°C
- Automatic Air purge valve
- Display of the compressor frequency



WH-UX09HE5 WH-UX12HE8  
WH-UX12HE5 WH-UX16HE8

Kit	Single Phase (Power to indoor)			Three Phase (Power to indoor)	
	KIT-WXC09H3E5 <sup>1</sup>	KIT-WXC12H6E5 <sup>1</sup>	KIT-WXC09H3E8	KIT-WXC12H9E8	KIT-WXC16H9E8
Heating capacity at +7°C (heating water at 35°C)	kW 9,00	12,00	9,00	12,00	16,00
COP at +7°C (heating water at 35°C)	W/W 4,84	4,74	4,84	4,74	4,28
Heating capacity at +2°C (heating water at 35°C)	kW 9,00	12,00	9,00	12,00	16,00
COP at +2°C (heating water at 35°C)	W/W 3,59	3,44	3,59	3,44	3,10
Heating capacity at -7°C (heating water at 35°C)	kW 9,00	12,00	9,00	12,00	16,00
COP at -7°C (heating water at 35°C)	W/W 2,85	2,72	2,85	2,72	2,49
Cooling capacity at 35°C (cooling water at 7°C)	kW 7,00	10,00	7,00	10,00	12,20
EER at 35°C (cooling water at 7°C)	W/W 3,17	2,81	3,17	2,81	2,57
Energy Efficiency Class at 35°C	A++	A++	A++	A++	A++
Energy Efficiency Class at 55°C	A++	A++	A++	A++	A++
<b>Indoor Unit</b>	<b>WH-SXC09H3E5</b>	<b>WH-SXC12H6E5</b>	<b>WH-SXC09H3E8</b>	<b>WH-SXC12H9E8</b>	<b>WH-SXC16H9E8</b>
Sound pressure	Heating / Cooling dB(A) 33 / 33	33 / 33	33 / 33	33 / 33	33 / 33
Dimensions / Weight*	H x W x D mm / kg 892 x 500 x 340 / 43	892 x 500 x 340 / 43	892 x 500 x 340 / 43	892 x 500 x 340 / 44	892 x 500 x 340 / 45
Water pipe connector	R 1 1/2	R 1 1/2	R 1 1/2	R 1 1/2	R 1 1/2
Pump	Number of speeds	Variable Speed	Variable Speed	Variable Speed	Variable Speed
	Input power (Min / Max) W	32 / 102	34 / 110	32 / 102	34 / 110
Heating water flow (ΔT=5 K, 35°C)	l/min 25,8	34,4	25,8	34,4	45,9
Capacity of integrated electric heater	kW 3	6	3	9	9
Recommended Fuse	A 30 / 30	30 / 30	16 / 16	16 / 16	16 / 16
Recommended cable size, supply 1 & 2	mm <sup>2</sup> 3 x 4,0 or 6,0 / 3 x 4,0	3 x 4,0 or 6,0 / 3 x 4,0	5 x 1,5 / 3 x 1,5	5 x 1,5 / 5 x 1,5	5 x 1,5 / 5 x 1,5
<b>Outdoor Unit</b>	<b>WH-UX09HE5</b>	<b>WH-UX12HE5</b>	<b>WH-UX09HE8</b>	<b>WH-UX12HE8</b>	<b>WH-UX16HE8</b>
Sound pressure	Heating / Cooling dB(A) 51 / 49	52 / 50	51 / 49	52 / 50	55 / 54
Dimensions / Weight	H x W x D mm / kg 1.340 x 900 x 320 / 101	1.340 x 900 x 320 / 101	1.340 x 900 x 320 / 108	1.340 x 900 x 320 / 108	1.340 x 900 x 320 / 118
Refrigerant (R410A)	kg / TCO <sub>2</sub> Eq. 2,85 / 5,951	2,85 / 5,951	2,85 / 5,951	2,85 / 5,951	2,90 / 6,055
Pipe diameter	Liquid / Gas Inch (mm) 3/8 (9,52) / 5/8 (15,88)	3/8 (9,52) / 5/8 (15,88)	3/8 (9,52) / 5/8 (15,88)	3/8 (9,52) / 5/8 (15,88)	3/8 (9,52) / 5/8 (15,88)
Pipe length range / Elevation difference (in/out)	m 3 - 30 / 20	3 - 30 / 20	3 - 30 / 20	3 - 30 / 20	3 - 30 / 20
Pipe length for additional gas / Additional gas amount	m / g/m 10 / 50	10 / 50	10 / 50	10 / 50	10 / 50
Operation range	Outdoor ambient °C -28 ~ +35	-28 ~ +35	-28 ~ +35	-28 ~ +35	-28 ~ +35
Water outlet	Heating / Cooling °C 25 - 60 / 5 - 20	25 - 60 / 5 - 20	25 - 60 / 5 - 20	25 - 60 / 5 - 20	25 - 60 / 5 - 20

### Accessories

<b>PAW-TD20C1E5</b>	Tank 200L - Stainless steel
<b>PAW-TD30C1E5</b>	Tank 300L - Stainless steel
<b>PAW-TG20C1E3STD-1</b>	Tank 200L - Enamelled
<b>PAW-TG30C1E3STD-1</b>	Tank 300L - Enamelled
<b>CZ-TK1</b>	Temperature sensor for 3rd party tank

### Accessories

<b>CZ-NV1</b>	3 way valve Kit for inside of hydrokit
<b>CZ-NS4P</b>	Additional functions PCB
<b>PAW-BTANK50L</b>	Buffer tank 50L
<b>CZ-TAW1</b>	Aquarea Smart Cloud, H Generation Internet control through Wifi or wired LAN
<b>PAW-AZW-RTWIRED</b>	Room thermostat

COP classification is at 230V only in accordance with EU directive 2003/32/EC. Sound pressure measured at 1m from the outdoor unit and at 1,5m height. Heating sound pressure measured at +7°C (heating water at 55°C). Performance in agreement with EN14511. 1) Available in April 2017. \* Tentative data.

A++  
EFP 55°C

A++  
EFP 35°C

INVERTER +

A CLASS  
WATER PUMP  
AUTO SPEED

-20°C  
CONSTANT HEATING  
T-CAP

DHW

-28°C  
HEATING MODE

WATER FILTER

STOP VALVE

FLOW SENSOR

BOILER CONNECTION

SOLAR KIT

ADVANCED CONTROL

INTERNET CONTROL

CONNECTIVITY

5 YEARS WARRANTY

INTERNET CONTROL- Optional.

# AQUAREA H GENERATION T-CAP BI-BLOC THREE PHASE. SUPER QUIET OUTDOOR UNIT. HEATING AND COOLING - SXC

The best for extreme outdoor conditions.  
Constant capacity at -20°C.

Aquarea T-CAP can work in extreme outdoor conditions as low as -28°C and warranty the capacity without back up heating down to 20°C. Ready to work at extreme outdoor conditions the H Generation T-CAP can produce water up to 60°C, expanding its possibilities for retrofit application. H Generation is the quickest to install and easiest maintenance.

### Technical focus

- **NEW!** Touch Controller
- **NEW!** Indoor Unit
- Very high energy savings A++
- Noise reduction of 7dB is based on power level when heating mode
- With Quite mode we can reach 10 ~ 12dB(A)
- Simple installation & maintenance
- Constant capacity up to -20°C
- Water temperature up to 60°C
- Special software for low consumption homes with minimum output temperature: 20°C
- Works at temperatures as low as -28°C
- Automatic Air purge valve
- Display of the compressor frequency



NEW TECHNOLOGY  
17



NEW  
SUPER QUIET  
OUTDOOR UNIT

WH-UQ09HE8  
WH-UQ12HE8  
WH-UQ16HE8

Kit	Three Phase. New Super Quiet outdoor unit			
	KIT-WQC09H3E8	KIT-WQC12H9E8	KIT-WQC16H9E8	
Heating capacity at +7°C (heating water at 35°C)	kW 9,00	12,00	16,00	
COP at +7°C (heating water at 35°C)	W/W 4,84	4,74	4,28	
Heating capacity at +2°C (heating water at 35°C)	kW 9,00	12,00	16,00	
COP at +2°C (heating water at 35°C)	W/W 3,59	3,44	3,10	
Heating capacity at -7°C (heating water at 35°C)	kW 9,00	10,00	11,40	
COP at -7°C (heating water at 35°C)	W/W 2,85	2,73	2,68	
Cooling capacity at 35°C (cooling water at 7°C)	kW 7,00	10,00	12,20	
EER at 35°C (cooling water at 7°C)	W/W 3,17	2,81	2,57	
Energy Efficiency Class at 35°C	A++	A++	A++	
Energy Efficiency Class at 55°C	A++	A++	A++	
<b>Indoor Unit</b>				
		<b>WH-SQC09H3E8</b>	<b>WH-SQC12H9E8</b>	<b>WH-SQC16H9E8</b>
Sound pressure	Heating / Cooling	33 / 33	33 / 33	33 / 33
Dimensions / Weight*	H x W x D	892 x 500 x 340 / 43	892 x 500 x 340 / 44	892 x 500 x 340 / 45
Water pipe connector		R 1 1/4	R 1 1/4	R 1 1/4
Pump	Number of speeds	Variable Speed	Variable Speed	Variable Speed
	Input power (Min / Max)	32 / 102	34 / 110	30 / 105
Heating water flow (ΔT=5 K, 35°C)	l/min	25,8	34,4	45,9
Capacity of integrated electric heater	kW	3	9	9
Recommended Fuse	A	15 / 30	15 / 30	15 / 30
Recommended cable size, supply 1 & 2	mm²	3 x 1,5 / 3 x 1,5	3 x 1,5 / 3 x 1,5	3 x 1,5 / 3 x 1,5
<b>Outdoor Unit</b>				
		<b>WH-UQ09HE8</b>	<b>WH-UQ12HE8</b>	<b>WH-UQ16HE8</b>
Sound pressure	Heating / Cooling	47 / 48	48 / 49	51 / 53
Dimensions / Weight	H x W x D	1.410 x 1.283 x 320 / 151	1.410 x 1.283 x 320 / 151	1.410 x 1.283 x 320 / 161
Refrigerant (R410A)	kg / TCO <sub>2</sub> Eq.	2,85 / 5,951	2,85 / 5,951	2,99 / 6,243
Pipe diameter	Liquid / Gas	3/8 (9,52) / 5/8 (15,88)	3/8 (9,52) / 5/8 (15,88)	3/8 (9,52) / 5/8 (15,88)
Pipe length range / Elevation difference (in/out)	m	3 ~ 30 / 20	3 ~ 30 / 20	3 ~ 30 / 20
Pipe length for additional gas / Additional gas amount	m / g/m	10 / 50	10 / 50	10 / 50
Operation range	Outdoor ambient	°C -28 ~ +35	°C -28 ~ +35	°C -28 ~ +35
Water outlet	Heating / Cooling	°C 25 - 60 / 5 - 20	°C 25 - 60 / 5 - 20	°C 25 - 60 / 5 - 20

### Accessories

<b>PAW-TD20C1E5</b>	Tank 200L - Stainless steel
<b>PAW-TD30C1E5</b>	Tank 300L - Stainless steel
<b>PAW-TG20C1E3STD-1</b>	Tank 200L - Enamelled
<b>PAW-TG30C1E3STD-1</b>	Tank 300L - Enamelled
<b>CZ-TK1</b>	Temperature sensor for 3rd party tank

### Accessories

<b>CZ-NV1</b>	3 way valve Kit for inside of hydrokit
<b>CZ-NS4P</b>	Additional functions PCB
<b>PAW-BTANK50L</b>	Buffer tank 50L
<b>CZ-TAW1</b>	Aquarea Smart Cloud, H Generation Internet control through Wifi or wired LAN
<b>PAW-A2W-RTWIRED</b>	Room thermostat

COP classification is at 230V only in accordance with EU directive 2003/32/EC. Sound pressure measured at 1m from the outdoor unit and at 1,5m height. Heating sound pressure measured at +7°C (heating water at 55°C). Performance in agreement with EN14511. 1) Available in April 2017. \* Tentative data.



INTERNET CONTROL: Optional.



# AQUAREA HT

## BI-BLOC SINGLE PHASE / THREE PHASE.

### HEATING ONLY - SHF

Aquarea HT is able to deliver water heated to 65°C with the Heat Pump alone.

For a house with high temperature radiators (for example, cast iron radiators), the Aquarea High Temperature Solution is the most suited as it provides output water temperatures of 65°C even at -20°C.

#### Technical focus

- New remote controller functions
- Efficient control of room temperature based on the outdoor temperature, indoor temperature using the Aquarea Manager.
- Optional Smartphone control
- Range from 9 to 12kW, Single and Three Phase
- Maximum hydraulic module output temperature: 65°C
- Works at temperatures as low as -20°C
- Maximum 20m rise between the outdoor unit and the hydraulic module



WH-UH09FE5 WH-UH12FE5  
WH-UH09FE8 WH-UH12FE8

Kit	Single Phase (Power to indoor)		Three Phase (Power to indoor)		
	KIT-WHF09F3E5	KIT-WHF12F6E5	KIT-WHF09F3E8	KIT-WHF12F9E8	
Heating capacity at +7°C (heating water at 35°C)	kW	9,00	12,00	9,00	12,00
COP at +7°C (heating water at 35°C)	W/W	4,64	4,46	4,64	4,46
Heating capacity at +2°C (heating water at 35°C)	kW	9,00	12,00	9,00	12,00
COP at +2°C (heating water at 35°C)	W/W	3,45	3,26	3,45	3,26
Heating capacity at -7°C (heating water at 35°C)	kW	9,00	12,00	9,00	12,00
COP at -7°C (heating water at 35°C)	W/W	2,74	2,52	2,74	2,52
Heating capacity at +7°C (heating water at 65°C)	kW	9,00	12,00	9,00	12,00
COP at +7°C (heating water at 65°C)	W/W	2,27	2,22	2,29	2,22
Heating capacity at +2°C (heating water at 65°C)	kW	9,00	10,30	9,00	10,30
COP at +2°C (heating water at 65°C)	W/W	1,89	1,84	1,89	1,84
Heating capacity at -7°C (heating water at 65°C)	kW	8,90	9,60	8,90	9,60
COP at -7°C (heating water at 65°C)	W/W	1,63	1,62	1,63	1,62
Energy Efficiency Class at 35°C		A++	A++	A++	A++
Energy Efficiency Class at 55°C		A++	A++	A++	A++
<b>Indoor Unit</b>		<b>WH-SHF09F3E5</b>	<b>WH-SHF12F6E5</b>	<b>WH-SHF09F3E8</b>	<b>WH-SHF12F9E8</b>
Sound pressure	dB(A)	33	33	33	33
Dimensions / Weight	H x W x D mm / kg	892 x 502 x 353 / 46	892 x 502 x 353 / 47	892 x 502 x 353 / 47	892 x 502 x 353 / 48
Water pipe connector		R 1 ¼	R 1 ¼	R 1 ¼	R 1 ¼
Pump	Number of speeds	7	7	7	7
	Input power (Min / Max)	W	38 / 100	40 / 106	38 / 100
Heating water flow (ΔT=5 K, 35°C)	l/min	25,8	34,4	25,8	34,4
Capacity of integrated electric heater	kW	3	6	3	9
Recommended Fuse	A	30 / 30	30 / 30	30 / 16	30 / 16
Recommended cable size, supply 1 & 2	mm²	3 x 4,0 or 6,0 / 3 x 4,0	3 x 4,0 or 6,0 / 3 x 4,0	5 x 1,5 / 3 x 1,5	5 x 1,5 / 5 x 1,5
<b>Outdoor Unit</b>		<b>WH-UH09FE5</b>	<b>WH-UH12FE5</b>	<b>WH-UH09FE8</b>	<b>WH-UH12FE8</b>
Sound pressure	dB(A)	51	52	51	52
Dimensions / Weight	H x W x D mm / kg	1.340 x 900 x 320 / 104	1.340 x 900 x 320 / 104	1.340 x 900 x 320 / 110	1.340 x 900 x 320 / 110
Refrigerant (R407C)	kg / TCO <sub>2</sub> Eq.	2,90 / 5,145	2,90 / 5,145	2,90 / 5,145	2,90 / 5,145
Pipe diameter	Liquid / Gas Inch (mm)	3/8 (9,52) / 5/8 (15,88)	3/8 (9,52) / 5/8 (15,88)	3/8 (9,52) / 5/8 (15,88)	3/8 (9,52) / 5/8 (15,88)
Pipe length range / Elevation difference (in/out)	m	3 - 30 / 20	3 - 30 / 20	3 - 30 / 20	3 - 30 / 20
Pipe length for additional gas / Additional gas amount	m / g/m	10 / 70	10 / 70	10 / 70	10 / 70
Operation range	Outdoor ambient °C	-20 ~ +35	-20 ~ +35	-20 ~ +35	-20 ~ +35
Water outlet	°C	25 ~ 65	25 ~ 65	25 ~ 65	25 ~ 65

#### Accessories

PAW-TD20C1E5	Tank 200L - Stainless steel
PAW-TD30C1E5	Tank 300L - Stainless steel
PAW-TG20C1E3STD-1	Tank 200L - Enamelled
PAW-TG30C1E3STD-1	Tank 300L - Enamelled
CZ-TK1	Temperature sensor for 3rd party tank
PAW-3WVVLV-SI	3 way valve

#### Accessories

PAW-BTANK50L	Buffer tank 50L
PA-AW-WIFI-1TE	Wifi interface
PAW-A2W-BIV	Bivalent control
PAW-FILTER	Filter
PAW-A2W-RTWIRED	Room thermostat

COP classification is at 230V only in accordance with EU directive 2003/32/EC. Sound pressure measured at 1m from the outdoor unit and at 1,5m height. Heating sound pressure measured at +7°C (heating water at 55°C). Performance in agreement with EN14511.



INTERNET CONTROL: Optional.

# AQUAREA H GENERATION HIGH PERFORMANCE MONO-BLOC SINGLE PHASE. HEATING AND COOLING - MDC



The Aquarea MDC range adapts well in an existing installation with a boiler backup, and in a new application with underfloor heating, low temperature radiators or even fan-coil heaters.

This range can also be connected to a solar kit in order to increase efficiency and minimise the impact on the ecosystem. Finally, it is possible to connect a thermostat for even better heating and cooling control and management.

Whatever the weather, Aquarea can work even at -20°C. The Mono-bloc is easy to install in new and existing residential properties.

### Technical focus

- **NEW!** Touch Controller
- Optional Smartphone control
- Range from 5 to 9kW, Single Phase
- Maximum hydraulic module output temperature: 55°C
- Works at temperatures as low as -20°C
- Cooling temperature range 5 ~ 20°C

			Single Phase Heating and Cooling		
Outdoor Unit			WH-MDC05H3E5 <sup>1</sup>	WH-MDC07H3E5 <sup>1</sup>	WH-MDC09H3E5 <sup>1</sup>
Heating capacity at +7°C (heating water at 35°C)	kW		5,00	7,00	9,00
COP at +7°C (heating water at 35°C)	W/W		5,08	4,46	4,15
Heating capacity at +2°C (heating water at 35°C)	kW		4,80	5,00	7,45
COP at +2°C (heating water at 35°C)	W/W		3,75	3,45	3,14
Heating capacity at -7°C (heating water at 35°C)	kW		4,50	5,15	7,70
COP at -7°C (heating water at 35°C)	W/W		2,98	2,68	2,12
Cooling capacity at 35°C (cooling water at 7°C)	kW		4,50	5,50	7,00
EER at 35°C (cooling water at 7°C)	W/W		3,33	2,74	2,44
Energy Efficiency Class at 35°C			A++	A++	A++
Energy Efficiency Class at 55°C			A++	A++	A++
Sound pressure	Heating / Cooling	dB(A)	49 / 47	49 / 47	51 / 49
Sound power level	Heating / Cooling	dB	65 / 65	65 / 65	69 / 67
Dimensions	H x W x D	mm	865 x 1.283 x 320	865 x 1.283 x 320	865 x 1.283 x 320
Weight		kg	107	112	112
Refrigerant (R410A) <sup>2</sup>		kg / TCO <sub>2</sub> Eq.	1,42 / -	1,45 / -	1,45 / -
Water pipe connector			R 1 1/4	R 1 1/4	R 1 1/4
Pump	Number of speeds		7	7	7
	Input power (Min / Max)	W	34 / 96	36 / 100	39 / 108
Heating water flow (ΔT=5 K, 35°C)		l/min	14,3	17,2	25,8
Capacity of integrated electric heater		kW	3	3	3
Input Power	Heating	kW	0,985	1,34	2,17
	Cooling	kW	1,35	2,01	2,87
Running and Starting current	Heating	A	4,5	6,1	9,9
	Cooling	A	6,1	9,3	13,0
Current 1		A	19,5	20,5	22,9
Current 2		A	13,0	13,0	13,0
Recommended Fuse		A	30 / 15	30 / 15	30 / 16
Recommended cable size, supply 1 & 2		mm <sup>2</sup>	3 x 4,0 or 6,0 / 3 x 4,0	3 x 4,0 or 6,0 / 3 x 4,0	3 x 4,0 or 6,0 / 3 x 4,0
Operation range	Outdoor ambient	°C	-20 ~ +35	-20 ~ +35	-20 ~ +35
	Heating	°C	20 ~ 55	20 ~ 55	20 ~ 55
Water outlet	Heating	°C	20 ~ 55	20 ~ 55	20 ~ 55
	Cooling	°C	5 ~ 20	5 ~ 20	5 ~ 20

### Accessories

PAW-TD20C1E5	Tank 200L - Stainless steel
PAW-TD30C1E5	Tank 300L - Stainless steel
PAW-TG20C1E3STD-1	Tank 200L - Enamelled
PAW-TG30C1E3STD-1	Tank 300L - Enamelled
CZ-TK1	Temperature sensor for 3rd party tank
PAW-3WVVLV-SI	3 way valve

### Accessories

PAW-BTANK50L	Buffer tank 50L
PA-AW-WIFI-1TE	Wifi interface
PAW-A2W-BIV	Bivalent control
PAW-A2W-RTWIRED	Room thermostat

COP classification is at 230V only in accordance with EU directive 2003/32/EC. Sound pressure measured at 1m from the outdoor unit and at 1.5m height. Heating sound pressure measured at +7°C (heating water at 55°C). Performance in agreement with EN14511. Authorized service partner or Authorized installer can enable the cooling mode through a special operation via the remote controller on site. 1) Available in October 2017. 2) WH-MDC models are hermetically sealed. \* Tentative data.



INTERNET CONTROL: Optional.

# AQUAREA G GENERATION HIGH PERFORMANCE MONO-BLOC SINGLE PHASE. HEATING AND COOLING - MDC

The Aquarea MDC range adapts well in an existing installation with a boiler backup, and in a new application with underfloor heating, low temperature radiators or even fan-coil heaters.

This range can also be connected to a solar kit in order to increase efficiency and minimise the impact on the ecosystem. Finally, it is possible to connect a thermostat for even better heating and cooling control and management.

Whatever the weather, Aquarea can work even at -20°C. The Mono-bloc is easy to install in new and existing residential properties.

## Technical focus

- Efficient control of room temperature based on the outdoor temperature, indoor temperature using the Aquarea Manager.
- Optional Smartphone control
- Range from 5 to 16kW, Single Phase
- Maximum hydraulic module output temperature: 55°C
- Works at temperatures as low as -20°C
- Cooling temperature range 5 ~ 20°C
- Plug and play system (WH-MDC05F3E5)



			Single Phase Heating and Cooling				
Outdoor Unit			WH-MDC05F3E5	WH-MDC06G3E5	WH-MDC09G3E5	WH-MDC12G6E5	WH-MDC16G6E5
Heating capacity at +7°C (heating water at 35°C)	kW		5,00	6,00	9,00	12,00	16,00
COP at +7°C (heating water at 35°C)	W/W		5,08	4,46	4,15	4,74	4,28
Heating capacity at +2°C (heating water at 35°C)	kW		4,80	5,00	7,45	11,40	13,00
COP at +2°C (heating water at 35°C)	W/W		3,75	3,45	3,14	3,44	3,28
Heating capacity at -7°C (heating water at 35°C)	kW		4,50	5,15	7,70	10,00	11,40
COP at -7°C (heating water at 35°C)	W/W		2,98	2,68	2,12	2,73	2,68
Cooling capacity at 35°C (cooling water at 7°C)	kW		4,50	5,50	7,00	10,00	12,20
EER at 35°C (cooling water at 7°C)	W/W		3,33	2,74	2,44	2,81	2,56
Energy Efficiency Class at 35°C			A++	A++	A++	A++	A++
Energy Efficiency Class at 55°C			A++	A++	A++	A++	A++
Sound pressure	Heating / Cooling	dB(A)	49 / 47	49 / 47	51 / 49	52 / 50	55 / 54
Sound power level	Heating / Cooling	dB	65 / 65	65 / 65	69 / 67	69 / 68	72 / 72
Dimensions	H x W x D	mm	865 x 1.283 x 320	865 x 1.283 x 320	865 x 1.283 x 320	1.410 x 1.283 x 320	1.410 x 1.283 x 320
Weight		kg	107	112	112	147	147
Refrigerant (R410A) <sup>1</sup>		kg / TCO <sub>2</sub> Eq.	1,42 / 2,965	1,45 / 3,028	1,45 / 3,028	2,10 / 4,385	2,10 / 4,385
Water pipe connector			R 1 1/4	R 1 1/4	R 1 1/4	R 1 1/4	R 1 1/4
Pump	Number of speeds		7	7	7	7	7
	Input power (Min / Max)	W	34 / 96	36 / 100	39 / 108	34 / 110	38 / 120
Heating water flow (ΔT=5 K, 35°C)		l/min	14,3	17,2	25,8	34,4	45,9
Capacity of integrated electric heater		kW	3	3	3	6	6
Input Power	Heating	kW	0,985	1,34	2,17	2,53	3,74
	Cooling	kW	1,35	2,01	2,87	3,56	4,76
Running and Starting current	Heating	A	4,5	6,1	9,9	11,7	17,3
	Cooling	A	6,1	9,3	13,0	16,5	22,0
Current 1		A	19,5	20,5	22,9	24,0	26,0
Current 2		A	13,0	13,0	13,0	26,0	26,0
Recommended Fuse		A	30 / 15		30 / 16	30 / 30	30 / 30
Recommended cable size, supply 1 & 2		mm <sup>2</sup>	3 x 4,0 or 6,0 / 3 x 4,0	3 x 4,0 or 6,0 / 3 x 4,0	3 x 4,0 or 6,0 / 3 x 4,0	3 x 4,0 or 6,0 / 3 x 4,0	3 x 4,0 or 6,0 / 3 x 4,0
Operation range	Outdoor ambient	°C	-20 ~ +35	-20 ~ +35	-20 ~ +35	-20 ~ +35	-20 ~ +35
	Heating	°C	20 ~ 55	20 ~ 55	20 ~ 55	25 ~ 55	25 ~ 55
Water outlet	Heating	°C	5 ~ 20	5 ~ 20	5 ~ 20	5 ~ 20	5 ~ 20
	Cooling	°C					

## Accessories

PAW-TD20C1E5	Tank 200L - Stainless steel
PAW-TD30C1E5	Tank 300L - Stainless steel
PAW-TG20C1E3STD-1	Tank 200L - Enamelled
PAW-TG30C1E3STD-1	Tank 300L - Enamelled
CZ-TK1	Temperature sensor for 3rd party tank
PAW-3WVVLV-SI	3 way valve

## Accessories

PAW-BTANK50L	Buffer tank 50L
PA-AW-WIFI-1TE	Wifi interface
PAW-A2W-BIV	Bivalent control
PAW-FILTER	Filter
PAW-A2W-RTWIRED	Room thermostat

COP classification is at 230V only in accordance with EU directive 2003/32/EC. Sound pressure measured at 1m from the outdoor unit and at 1,5m height. Heating sound pressure measured at +7°C (heating water at 55°C). Performance in agreement with EN14511. Authorized service partner or Authorized installer can enable the cooling mode through a special operation via the remote controller on site. 1) WH-MDC models are hermetically sealed.



INTERNET CONTROL: Optional.



# AQUAREA G GENERATION T-CAP MONO-BLOC SINGLE PHASE / THREE PHASE. HEATING AND COOLING - MXC

The MXC is ideal for residential properties which don't have an external boiler and require a maintained capacity level.

T-CAP stands for Total Capacity. This line-up is able to maintain the same nominal capacity even at -15°C without the help of an electrical booster heater. T-CAP is also able to provide extremely high efficiency, regardless of the outside temperature or the water temperature. The MXC adapts well in an existing installation with a boiler backup, and in a new application with underfloor heating, low temperature radiators or even fan-coil heaters. This range can also be connected to a

solar kit in order to increase efficiency and minimise the impact on the ecosystem. Finally, it is possible to connect a thermostat for even better heating or cooling control and management.



### Technical focus

- Efficient control of room temperature based on the outdoor temperature, indoor temperature using the Aquarea Manager.
- Optional Smartphone control
- Range from 9 to 16 kW, Single and Three Phase
- Maximum hydraulic module output temperature: 55°C
- Works at temperatures as low as -20°C
- Cooling temperature range 5 ~ 20°C

Outdoor Unit			Single Phase			Three Phase		
			WH-MXC09G3E5	WH-MXC12G6E5	WH-MXC09G3E8	WH-MXC12G9E8	WH-MXC16G9E8	
Heating capacity at +7°C (heating water at 35°C)	kW	9,00	12,00	9,00	12,00	16,00		
COP at +7°C (heating water at 35°C)	W/W	4,84	4,74	4,84	4,74	4,28		
Heating capacity at +2°C (heating water at 35°C)	kW	9,00	12,00	9,00	12,00	16,00		
COP at +2°C (heating water at 35°C)	W/W	3,59	3,44	3,59	3,44	3,10		
Heating capacity at -7°C (heating water at 35°C)	kW	9,00	12,00	9,00	12,00	16,00		
COP at -7°C (heating water at 35°C)	W/W	2,85	2,72	2,85	2,72	2,49		
Cooling capacity at 35°C (cooling water at 7°C)	kW	7,00	10,00	7,00	10,00	12,20		
EER at 35°C (cooling water at 7°C)	W/W	3,17	2,81	3,17	2,81	2,56		
Energy Efficiency Class at 35°C		◀A++	◀A++	◀A++	◀A++	◀A++		
Energy Efficiency Class at 55°C		◀A++	◀A++	◀A++	◀A++	◀A++		
Sound pressure	Heating / Cooling	dB(A)	51 / 49	52 / 50	51 / 49	52 / 50	55 / 54	
Sound power level	Heating / Cooling	dB	68 / 67	69 / 68	68 / 67	69 / 68	72 / 72	
Dimensions	H x W x D	mm	1.410 x 1.283 x 320	1.410 x 1.283 x 320	1.410 x 1.283 x 320	1.410 x 1.283 x 320	1.410 x 1.283 x 320	
Weight		kg	148	148	155	155	168	
Refrigerant (R410A) <sup>1</sup>		kg / TCO <sub>2</sub> Eq.	2,30 / 4,802	2,30 / 4,802	2,30 / 4,802	2,30 / 4,802	2,35 / 4,907	
Water pipe connector			R 1 ½	R 1 ½	R 1 ½	R 1 ½	R 1 ½	
Pump	Number of speeds		7	7	7	7	7	
	Input power (Min / Max)	W	32 / 102	34 / 110	32 / 102	34 / 110	38 / 120	
Heating water flow (ΔT=5 K, 35°C)		l/min	25,8	34,4	25,8	34,4	45,9	
Capacity of integrated electric heater		kW	3	6	3	9	9	
Input Power	Heating	kW	1,86	2,53	1,86	2,53	3,74	
	Cooling	kW	2,21	3,56	2,21	3,56	4,76	
Running and Starting current	Heating	A	8,6	11,7	2,8	3,8	5,7	
	Cooling	A	10,2	16,5	3,4	5,3	7,2	
Current 1		A	25,0	29,0	14,7	11,9	15,5	
Current 2		A	13,0	26,0	13,0	13,0	13,0	
Recommended Fuse		A	30 / 30	30 / 30	16 / 16	16 / 16	16 / 16	
Recommended cable size, supply 1 & 2		mm <sup>2</sup>	3 x 4,0 or 6,0 / 3 x 4,0	3 x 4,0 or 6,0 / 3 x 4,0	5 x 1,5 / 3 x 1,5	5 x 1,5 / 5 x 1,5	5 x 1,5 / 5 x 1,5	
Operation range	Outdoor ambient	°C	-20 ~ +35	-20 ~ +35	-20 ~ +35	-20 ~ +35	-20 ~ +35	
	Heating	°C	25 ~ 55	25 ~ 55	25 ~ 55	25 ~ 55	25 ~ 55	
Water outlet	Heating	°C	5 ~ 20	5 ~ 20	5 ~ 20	5 ~ 20	5 ~ 20	
	Cooling	°C	5 ~ 20	5 ~ 20	5 ~ 20	5 ~ 20	5 ~ 20	

### Accessories

PAW-TD20C1E5	Tank 200L - Stainless steel
PAW-TD30C1E5	Tank 300L - Stainless steel
PAW-TG20C1E3STD-1	Tank 200L - Enamelled
PAW-TG30C1E3STD-1	Tank 300L - Enamelled
CZ-TK1	Temperature sensor for 3rd party tank
PAW-3WVVLV-SI	3 way valve

### Accessories

PAW-BTANK50L	Buffer tank 50L
PA-AW-WIFI-1TE	Wifi interface
PAW-A2W-BIV	Bivalent control
PAW-FILTER	Filter
PAW-A2W-RTWIRED	Room thermostat

COP classification is at 230V only in accordance with EU directive 2003/32/EC. Sound pressure measured at 1m from the outdoor unit and at 1,5m height. Heating sound pressure measured at +7°C (heating water at 55°C). Performance in agreement with EN14511. 1) WH-MXC models are hermetically sealed.



INTERNET CONTROL: Optional.

# AQUAREA G GENERATION HT MONO-BLOC SINGLE PHASE. HEATING ONLY - MHF

Aquarea HT is able to deliver 65°C with the Heat Pump alone.

For a house with high temperature radiators (for example, cast iron radiators), the Aquarea High Temperature Solution is most suited as it provides output water temperatures of 65°C even at -20°C.

### Technical focus

- Efficient control of room temperature based on the outdoor temperature, indoor temperature using the Aquarea Manager.
- Optional Smartphone control
- Range from 9 to 12kW, Single and Three Phase
- Maximum hydraulic module output temperature: 65°C
- Works at temperatures as low as -20°C



		Single Phase	
Outdoor Unit		WH-MHF09G3E5	WH-MHF12G6E5
Heating capacity at +7°C (heating water at 35°C)	kW	9,00	12,00
COP at +7°C (heating water at 35°C)	W/W	4,64	4,46
Heating capacity at +2°C (heating water at 35°C)	kW	9,00	12,00
COP at +2°C (heating water at 35°C)	W/W	3,45	3,26
Heating capacity at -7°C (heating water at 35°C)	kW	9,00	12,00
COP at -7°C (heating water at 35°C)	W/W	2,74	2,52
Heating capacity at +7°C (heating water at 65°C)	kW	9,00	12,00
COP at +7°C (heating water at 65°C)	W/W	2,27	2,22
Heating capacity at +2°C (heating water at 65°C)	kW	9,00	10,30
COP at +2°C (heating water at 65°C)	W/W	1,89	1,84
Heating capacity at -7°C (heating water at 65°C)	kW	8,90	9,60
COP at -7°C (heating water at 65°C)	W/W	1,63	1,62
Energy Efficiency Class at 35°C		A++	A++
Energy Efficiency Class at 55°C		A++	A++
Sound pressure	dB(A)	51	52
Sound power level	dB	68	69
Dimensions	H x W x D	1.410 x 1.283 x 320	1.410 x 1.283 x 320
Weight	kg	151	151
Refrigerant (R407C) <sup>1</sup>	kg / TCO <sub>2</sub> Eq.	1,92 / 3,406	1,92 / 3,406
Water pipe connector		R 1 1/4	R 1 1/4
Pump	Number of speeds	7	7
	Input power (Min / Max)	—	—
Heating water flow (ΔT=5 K, 35°C)	l/min	25,8	34,4
Capacity of integrated electric heater	kW	3	6
Input Power	kW	1,94	2,69
Running and Starting current	A	9,3	12,8
Current 1	A	28,5	29,0
Current 2	A	13,0	26,0
Recommended Fuse	A	30 / 30	30 / 30
Recommended cable size, supply 1 & 2	mm <sup>2</sup>	3 x 4,0 or 6,0 / 3 x 4,0	3 x 4,0 or 6,0 / 3 x 4,0
Operation range	Outdoor ambient	°C	-20 ~ +35
Water outlet	°C	25 ~ 65	25 ~ 65

### Accessories

PAW-TD20C1E5	Tank 200L - Stainless steel
PAW-TD30C1E5	Tank 300L - Stainless steel
PAW-TG20C1E3STD-1	Tank 200L - Enamelled
PAW-TG30C1E3STD-1	Tank 300L - Enamelled
CZ-TK1	Temperature sensor for 3rd party tank
PAW-3WYVVL-SI	3 way valve

### Accessories

PAW-BTANK50L	Buffer tank 50L
PA-AW-WIFI-1TE	Wifi interface
PAW-A2W-BIV	Bivalent control
PAW-FILTER	Filter
PAW-A2W-RTWIRED	Room thermostat

COP classification is at 230V only in accordance with EU directive 2003/32/EC. Sound pressure measured at 1m from the outdoor unit and at 1,5m height. Heating sound pressure measured at +7°C (heating water at 55°C). Performance in agreement with EN14511. 1) WH-MHF models are hermetically sealed.

A++  
EFP 55°C

A++  
EFP 35°C

INVERTER+

A CLASS  
WATER PUMP

65°C  
OUTPUT WATER

DRW

HEATING MODE  
-20°C

BOILER CONNECTION

SOLAR KIT

INTERNET CONTROL

CONNECTIVITY  
BMS

5 YEARS  
WARRANTY

INTERNET CONTROL: Optional.

## AQUAREA AIR RADIATORS FAN COILS FOR HEAT PUMP APPLICATION

### New line up of Super low temperature radiators for Heat Pump application: Aquarea Air 200/700/900 with radiating effect

The slimline Panasonic Aquarea Air radiators deliver high efficiency climate control. With a depth of just under 13 cm they are at the cutting edge of the market. Blending easily into the home, Aquarea Air's elegant design and product refinements are clear to see in every detail. The Aquarea Air's slimline profile has been achieved thanks to the innovative layout of the ventilation unit and the heat exchanger. The fan is tangential with asymmetric blades and the large surface heat exchanger enables high airflows to be achieved with low pressure loss and low noise levels. Exceptional ventilation efficiency means the motor uses considerably less energy (low wattage). The fan speed is continuously modulated by the temperature controller with proportional integral logic, with undoubted advantages for regulating the temperature and humidity in summer mode.

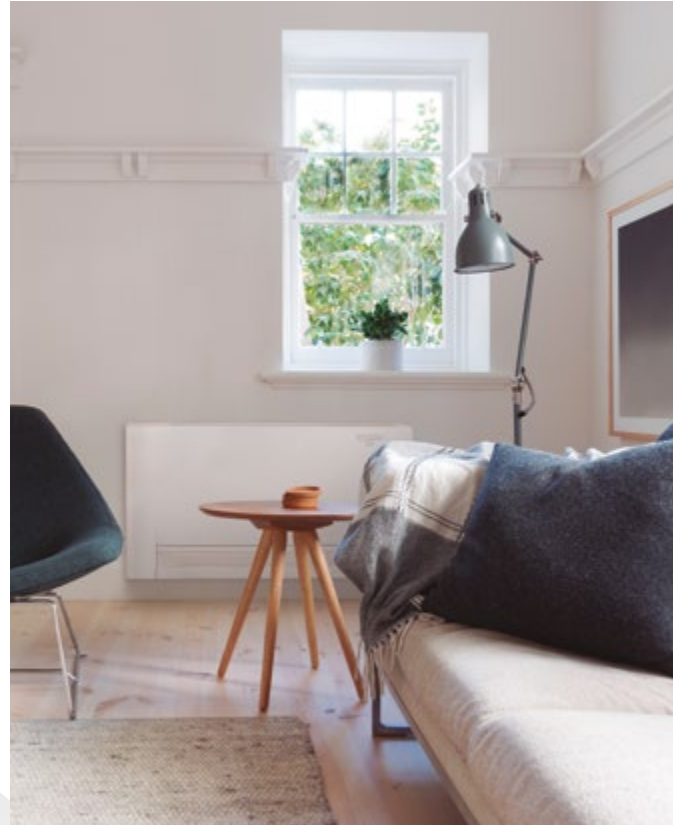

### Line up of super low temperature radiators for Heat Pump application

During winter, the operating principle is based on micro fans with very low power consumption and minimum noise, that send hot air coming from the heat exchanger, to the inside of the front panel of the device and therefore heat it effectively. With this principle, the terminal also provides significant power while heating, without running the main fan. Comfort temperatures are therefore maintained, without air movements and in silence. In summer mode, the airflow generated by the micro fans is stopped to avoid any dew formation on the terminal's front surface.

With standard cast radiators.

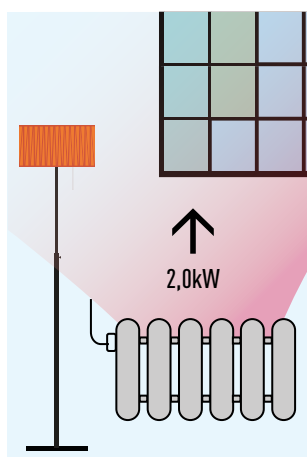

Water at 65°C needed.

With Aquarea Air.

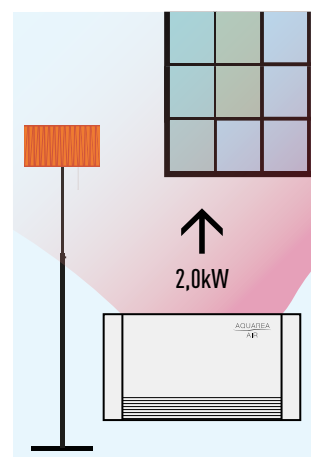

Water at 35°C needed.

#### Technical focus:

- Front panel heating with radiant effect
- High heating capacity (without main fan running)
- 4 fan speeds and capacities
- Exclusive design
- Extremely compact (only 12,9 cm deep)
- Cooling and dehumidification functions possible (drain is needed)
- 3-way valve included (no overflow valve needed on the installation if more than 3 radiators installed)
- Touch screen thermostat

All temperature curves and capacity are available on [www.panasonicproclub.com](http://www.panasonicproclub.com)



# AQUAREA AIR

During winter, the operating principle is based on micro fans with very low power consumption and minimum noise, that send hot air coming from the heat exchanger, to the inside of the front panel of the device and therefore heat it effectively.

With this principle, the terminal also provides significant power while heating, without running the main fan. Comfort temperatures are therefore maintained, without air movements and in silence. In summer mode, the airflow generated by the micro fans is stopped to avoid any dew formation on the terminal's front surface.

### Technical focus

- Front panel heating with radiant effect
- High heating capacity (without main fan running)
- 4 fan speeds and capacities
- Exclusive design
- Extremely compact (only 12,9cm deep)
- Cooling and dehumidification functions possible (drain is needed)
- 3-way valve included (no overflow valve needed on the installation if more than 3 radiators installed)
- Touch screen thermostat

Operating on heating mode with radiator using only radiant effect.

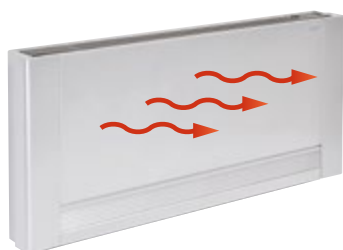

Operating on heating mode with radiant effect and fan mode.

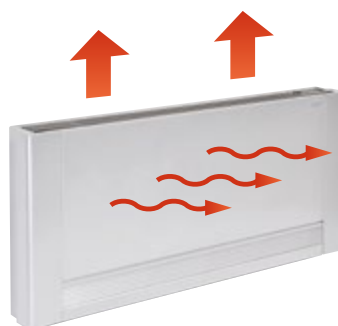

Operating on cooling mode with fan.



Fan Coils for Heat Pump application		PAW-AAIR-200-1					PAW-AAIR-700-1					PAW-AAIR-900-1				
Total heating capacity	W	138	160	217	470	570	223	360	708	1.032	1.188	273	475	886	1.420	1.703
Water flow	kg/h	23,7	27,5	37,3	80,8	98,0	38,4	61,9	121,8	177,5	204,3	47,0	81,7	152,4	244,2	292,9
Water pressure drop	kPa	0,1	0,2	0,4	2,0	2,9	0,1	0,1	0,3	0,8	1,0	0,1	0,2	0,5	1,6	2,2
Air flow	m³/min	0,5	0,6	0,9	1,9	2,7	0,7	1,4	2,6	4,2	5,3	0,9	1,8	4,1	6,1	7,7
	Speed	Main Fan Off	Super Min	Min	Med	Max	Main Fan Off	Super Min	Min	Med	Max	Main Fan Off	Super Min	Min	Med	Max
Maximum input power	W	2	5	7	9	13	3	9	14	18	22	3	11	16	20	24
Sound pressure	dB(A)	17,6	18,8	24,7	33,2	39,4	18,4	19,6	25,8	34,1	40,2	18,4	22,3	26,2	34,4	42,2
Inlet water temperature	°C	35	35	35	35	35	35	35	35	35	35	35	35	35	35	35
Outlet water temperature	°C	30	30	30	30	30	30	30	30	30	30	30	30	30	30	30
Inlet air temperature	°C	19	19	19	19	19	19	19	19	19	19	19	19	19	19	19
Outlet air temperature	°C	34,5	32,6	38,9	32,0	30,0	34,9	32,4	33,3	31,8	30,6	34,8	32,5	30,2	31,1	30,6
Dimensions (H x W x D)	mm	579 x 735 x 129					579 x 935 x 129					579 x 1.135 x 129				
Weight	kg	17					20					23				
3-ways valve included		Yes					Yes					Yes				
Touch screen thermostat		Yes					Yes					Yes				

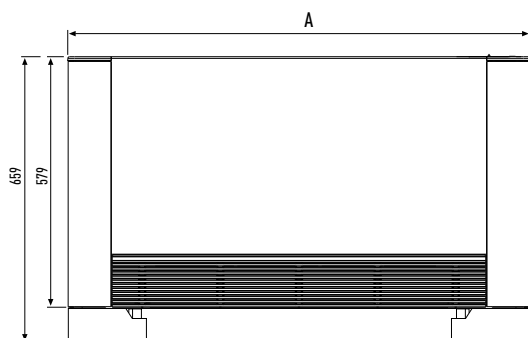

	200	700	900
A	735	935	1.135

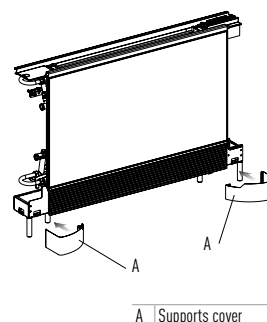

## SANITARY TANKS

### A wide range of tanks adapted to every need.

Panasonic offers best combination of Aquarea with DHW. Wide range of tanks to adapt to any specific need with high quality standards. The wide range is covered with 1 Tank with buffer tank, 2 Stainless Tanks with "A" Class and 5 Enamelled tanks from 150 to 400L.

### Aquarea Tank. DHW tank with buffer tank.

Designed for retrofit applications, the DHW 200L tank with a 80L buffer tank is particularly suitable for fast integration on an existing installation. Panasonic has developed a tank with 80L Buffer tank and 200L sanitary hot water cylinder. This tank includes a 3-way valve and an "A" Class pump. Easy to install, nice looking, high efficiency for DHW production and for heating.

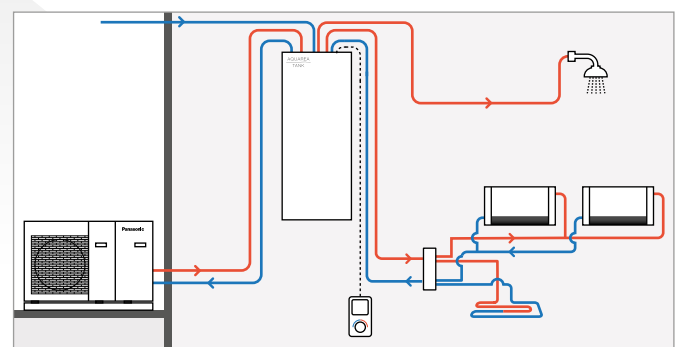

Aquarea Tank. Tanks and buffer tank in one!			PAW-TD20B8E3-NDS	
Water volume		L	185 (for DHW tank) / 80 (for buffer tank)	
Maximum water temperature		°C	100	
Dimension / Weight	H x W x D	mm / kg	1.810 x 600 x 632 / 150	
Electric heater		kW	3	
Power supply		V	230 - 2p	
Material inside tank			Stainless steel	
Exchange surface		m <sup>2</sup>	2,3	
Energy loss at 65°C <sup>1</sup>		kWh/24h	1,3	
A class pump	Number of speed		Stepless (800-4250 rpm)	
	Pressure drop (Min / Max)	kPa	5 / 6	
	Input power (Min / Max)	W	3 / 45	
3 Way valve included			Yes	
Safety thermostat with contact for failure part of E-Heating			Yes	
Location of the electrical heater			Mid	
Electrical backup heater on the buffer tank			Optional	







**Enamelled Tank.**





With our enamelled tanks wide range, we can satisfy any size needs. Consisting on 4 different size: 150, 200, 300 and 400L. The 300L is also available in with 2 coils version.

**Stainless Steel Tank.**

The best heat pump in market needs to be complemented with best efficiency tank. Panasonic "A" Class Stainless Tank consist in 2 capacities 200 and 300L. These 2 models are anode free does not require any maintenance.

Tanks		Stainless Steel Tank	
		PAW-TD20C1E5	PAW-TD30C1E5
Model			
Water volume	L	192	280
Maximum water temperature	°C	75	75
Dimensions	Height / Diameter	mm 1.265 / 595	1.745 / 595
Weight / filled with water	kg	53 / —	65 / —
Electric heater	kW	1,5	1,5
Power supply	V	230	230
Material inside tank		Stainless steel	Stainless steel
Exchange surface	m <sup>2</sup>	1,8	1,8
Energy loss at 65°C <sup>1</sup>	kWh/24h	0,99	1,13
3 Way valve accessory PAW-3WVVLV-SI or CZ-NV1		Optional	Optional
20m temperature sensor cable included		Yes	Yes
Heat up time	Valuation	★★★★	★★★★
Energy losses	Valuation	★★★★	★★★★
Energy Efficiency Class		<b>A</b>	<b>A</b>
Warranty		2 years	2 years
Maintenance required		No	No

1) Insulated tested under EN12897. \* Includes proportional control thermostat.

Tanks		Enamelled Tank				Enamelled 2 coils Tank (for bivalent Solar + HP)
		PAW-TG15C1EZ**	PAW-TG20C1E3STD-1	PAW-TG30C1E3STD-1	PAW-TG40C1E3STD-1	PAW-TG30C2E3STD-1
Model						
Water volume	L	150	185	285	396	284
Maximum water temperature	°C	95	95	95	95	95
Dimensions	Height / Diameter	mm 500 x 1.345	1.507 / 580	1.565 / 680	1.888 / 760	1.417 / 760
Weight / filled with water	kg	—	97 / 282	140 / 425	171 / 567	134 / 418
Electric heater	kW	—	3	3	3	3
Power supply	V	230	230	230	230	230
Material inside tank		Steel enamelled	Enamelled	Enamelled	Enamelled	Enamelled
Exchange surface	m <sup>2</sup>	1,4	2,0	2,5	6,1	2,4 (for HP) +1,0 (for solar or boiler)
Energy loss at 65°C <sup>1</sup>	kWh/24h	—	1,6	2,1	1,7	1,6
3 Way valve accessory PAW-3WVVLV-SI or CZ-NV1		Optional	Optional	Optional	Optional	Optional
20m temperature sensor cable included		—	Yes	Yes	Yes	Yes
Heat up time	Valuation	—	★★★★	★★★★	★★★★	★★★★
Energy losses	Valuation	—	★★★★	★★★★	★★★★	★★★★
Energy Efficiency Class		<b>C</b>	<b>C</b>	<b>C</b>	<b>B</b>	<b>B</b>
Warranty		2 years	2 years	2 years	2 years	2 years
Maintenance required		Yearly	Yearly	Yearly	Yearly	Yearly

1) Insulated tested under EN12897. \* Includes proportional control thermostat. \*\* Tentative image.



## AQUAREA DHW

### DHW tank with built-in Heat Pump

The Heat Pump is one of the most energy efficient and cost effective methods of water heating. The pump is mounted on the storage tank and draws energy from the ambient air, using that extra energy source to heat the water up to 55°C.

### All new DHW HP will be delivered with a plug, because:

1. IP protection
2. Pull forces
3. No junction box – we want to avoid to have disassembling though installation
4. Bench mark analysis

### Wall mounted Aquarea DHW. Mid Capacity: 80/100/120L

Designed for maximum energy savings, Aquarea DHW's medium tank volume has been designed as a perfect replacement for the electric water heater. The conventional medium tank volume has been boosted with a heat pump generator, which delivers superior energy performance. The air-to-water heat pump design with air ducts enables the selection of inlet and outlet points for the air, which allows it to be used in various parts of the home (kitchen, bathroom, sunrooms, etc.).



### Aquarea DHW Advantages

- High-technology rotational compressor ensures higher energy efficiency and a higher coefficient of performance, which means major energy savings – up to 75%.
- Wrapped around the inside of the outer cover of the tank, it prevents the build-up of limescale, extends the useful life of the equipment and improves safety.
- The dimensions and heating capability of a medium volume Aquarea DHW tank can easily replace an existing electric water heater. Its small size allows it to be installed in spaces where previously a conventional electric water heater would be installed.
- Impressive tank protection is provided through the use of superior super-clean enamel and a large magnesium element. These ensure durability even in the harshest operating conditions, without harmful additives in the water.

### Floor standing at -7°C Aquarea DHW. High capacity: 200/295L

The DHW is ready to achieve levels of high efficiency even at temperatures as low as -7°C. With this range it is possible to connect an additional heat source, such as solar energy. In PAW-DHWM300AE, the heat pump cools and de-humidifies the air pumped either from outdoors or from within the building. By choosing the point of air capture and exhaust, you can ventilate and de-humidify some rooms, while extracting the cooled air either into the environment or into another room that you wish to cool.

Floor standing at -7°C Aquarea DHW. High capacity: 200/295L.

Wall mounted Aquarea DHW. Mid Capacity: 80/100/120L.

Technical focus

- Energy efficiency A class
- 119,1 % Energy efficiency  $\eta_{wh}^1$
- 1.204,2kWh AEC annual electricity consumption<sup>1</sup>
- 6,57kWh Daily electricity consumption  $Q_{elec}^2$
- 55°C Thermostat temperature settings
- 0 Value of smart

1) EU Regulation 812/2013 ; EN 16147:2010. 2) EN 16147:2010.

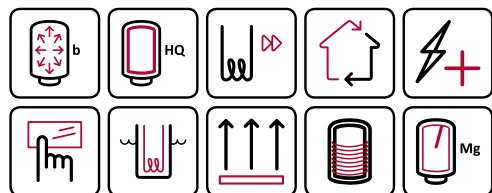

Technical focus

- Capacity: 80, 100 and 120L
- Vertical wall mounting
- Operating range between -7°C to +35°C
- LCD touch screen display

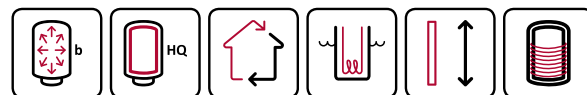

Model Reference	Floor standing at -7°C*			Wall mounted			
	PAW-DHWM200A	PAW-DHWM300A	PAW-DHWM300AE	PAW-DHWM80ZNT	PAW-DHWM100ZNT	PAW-DHWM120ZNT	
Volume	L	208	295	276	80	100	120
<b>Dimensions of Connections</b>							
Height / with air ducts	mm	1.540 x 670 x 690	1.960 x 670 x 690	1.960 x 670 x 690	1.197 x 506 x 533	1.342 x 506 x 533	1.497 x 506 x 533
Connections to the water supply network		G1	G1	G1	G 1/2	G 1/2	G 1/2
Dimensions of air ducts	mm / m	Ø160 / —	Ø160 / —	Ø160 / —	Ø125 (150 x 70) / 10	Ø125 (150 x 70) / 10	Ø125 (150 x 70) / 10
Net weight / with water	kg	149 / 365	164 / 459	207 / 480	58 / 138	62 / 162	68 / 188
<b>Heat Pump</b>							
Nominal electrical power	W	490	490	490	250	250	250
Reference tapping cycle		L	XL	XL	M	M	M
Energy consumption by chosen cycle A7 / W10-55 <sup>1</sup>	kWh	4,05	5,77	5,96	2,45	2,35	2,51
Energy consumption by chosen cycle A15 / W10-55 <sup>2</sup>	kWh	3,95	5,65	5,75	2,04	2,05	2,08
COP DHW (A7 / W10-55) EN 16147 <sup>1</sup>		3,00	3,33	3,30	2,65	2,63	2,61
COP DHW (A15 / W10-55) EN 16147 <sup>2</sup>		3,07	3,39	3,38	3,10	3,10	3,10
Energy Efficiency Class		<b>A</b>	<b>A</b>	<b>A</b>	<b>A</b>	<b>A</b>	<b>A</b>
Standby power input according to EN16147	W	28	18	20	19	20	27
Sound power / Sound Pressure on 1m	dB / dB(A)	— / 58	— / 58	— / 58	51,0 / 39,5	51,0 / 39,5	51,0 / 39,5
Refrigerant		R134a	R134a	R134a	R134a	R134a	R134a
Quantity of refrigerant	g	1.100	1.100	1.100	540	540	540
Operating range - air temperature	°C	-7 / +35	-7 / +35	-7 / +35	-7 / +35	-7 / +35	-7 / +35
Nominal air flow rate (Maximum)	m³/min	7,5	7,5	7,5	1,7 - 3,8	1,7 - 3,8	1,7 - 3,8
Maximum pressure drop (volumetric flow rate at 5,5m³/min (60%))	Pa	100	100	100	—	—	—
Pressure drop by 2,5m³/min (60%/80%) (Maximum) <sup>3</sup>	Pa	—	—	—	70 (90)	70 (90)	70 (90)
<b>Storage Tank</b>							
Enamelled steel tank / Protective magnesium anode		+ / +	+ / +	+ / +	+ / +	+ / +	+ / +
Average insulation thickness	mm	—	—	—	40 - 85	40 - 85	40 - 85
External source exchanger (m² surface / connection)		—	—	2,7 / G1	—	—	—
<b>Electrical Specifications</b>							
Maximum power consumption without heater / with heater	W	490 / 2.490	490 / 2.490	490 / 2.490	— / 2.350	— / 2.350	— / 2.350
Number of electrical heaters x power	W	2 x 1.000	2 x 1.000	2 x 1.000	2 x 1.000	2 x 1.000	2 x 1.000
Voltage / Frequency	V / Hz	230 / 50	230 / 50	230 / 50	230 / 50	230 / 50	230 / 50
Electric protection	A	16	16	16	16	16	16
Moisture protection		IP24	IP24	IP24	IP24	IP24	IP24
Working pressure (Storage tank / Heat Exchanger)	Mpa (bar)	0,6 (6) / 0,9 (9)	0,6 (6) / 0,9 (9)	1,0 (10)	1,0 (10)	1,0 (10)	1,0 (10)
<b>Maximum Temperature</b>							
Heating with heat pump Min / Max	°C	55 / 65	55 / 65	55 / 65	55 / —	55 / —	55 / —
Heating with electrical heater	°C	75	75	75	75	75	75
<b>Refrigerant information</b>							
Refrigerant (R134a) <sup>4</sup>	kg / TCO: Eq.	1,100 / 1,573	1,100 / 1,573	1,100 / 1,573	0,540 / 0,772	0,540 / 0,772	0,540 / 0,772

1) Heating of sanitary water up to 55°C with inlet air temperature at 7°C, humidity at 89% and inlet water temperature at 10°C. According to EN16147. 2) Heating of sanitary water up to 55°C with inlet air temperature at 15°C, humidity at 74% and inlet water temperature at 10°C. According to EN16147. 3) Normal fan speed 60%, higher fan speed - special setting on 80%. 4) Aquarea DHW units are hermetically sealed.

\* When connected as pressurised, use of safety valve is mandatory.



# ACCESSORIES & CONTROL

## Optional PCB's for additional functions

- CZ-NS2P**  
PCB for solar connection kit for Mono-bloc systems.
- CZ-NS3P**  
PCB for solar connection kit for Mono-bloc systems 6kW and 9kW.
- CZ-NS4P**  
PCB for advanced functions in H Generation.

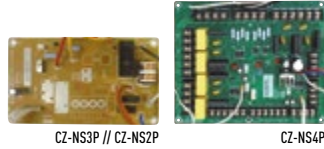

## Deice accessories

- CZ-NE1P**  
Base pan heater (for all old Bi-bloc and Mono-bloc, not for the 3 and 5kW).
- CZ-NE2P**  
Base pan heater (for 3kW and 5kW).
- CZ-NE3P**  
Base pan heater (for all new F Generation products: F3, F6, F9).



## Accessories for All in One

- PAW-ADC-PREKIT-1**  
Flexible pipings and wall mounting plate for All in One H Generation.
- PAW-ADC-PREKIT**  
Flexible pipings and wall mounting plate for All in One G Generation.
- PAW-ADC-CV150**  
Decorative magnetic side cover.

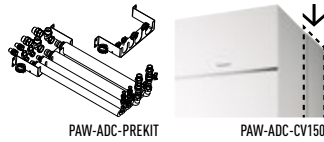

## Accessories for Aquarea Air

- PAW-AAIR-LEGS-1**  
Kits of 2 legs to support the Aquarea Air on the floor and to protect the water pipings.

## Accessories for Aquarea DHW

- PAW-DHWE2C**  
2kW optional electrical heater for floor standing.
- PAW-DHWE3C**  
3kW optional electrical heater for floor standing.

## Sanitary tank accessories

- PAW-TS1**  
Tank sensor with 6m cable length.
- PAW-TS2**  
Tank sensor with 20m cable length.
- PAW-TS4**  
Tank sensor with 6m cable length and only 6mm diameter.
- CZ-TK1**  
Temperature sensor kit for third party tank (with copper pocket and 6m length sensor cable).



## Special outdoor supports

- PAW-WTRAY**  
Tray for condenser water compatible with base ground support.
- PAW-GRDSTD40**  
Outdoor elevation platform.
- PAW-GRDBSE20**  
Outdoor base ground support for noise and vibration absorption (600 x 95 x 130mm, 500kg).



## Hydraulic accessories

- PAW-2PMP2ZONE**  
2 zone kit, hydraulic switch, manifold, 2 A-class pumps, 1 mixture valve.
- PAW-A2W-2ZONECVR**  
2 zone kit box cover.
- PAW-A2W-2ZONEKIT**  
2 zone kit.
- PAW-FILTER\***  
2 check valves + filter with 1" (no needed for H Generation).
- PAW-FILTER-ONLY\***  
Filter with 1" (no needed for H Generation).
- PAW-A2WFILTERFLOW\***  
Filter and water flow meter (no needed for H Generation).
- PAW-BTANK50L**  
Buffer tank 50L
- CZ-NV1**  
3 way valve ready for All in One H Generation (optional in internal space).
- PAW-3WYVLV-SI**  
3 way valve.

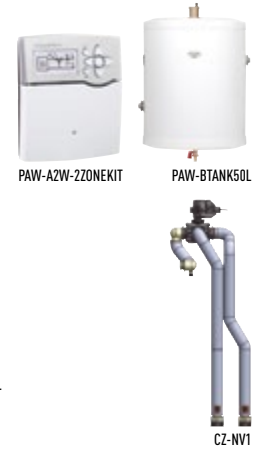

## Aquarea Manager Kits\*

- PAW-HPM12ZONE-U**  
HPM with room sensor and setpoint adaption for Bi-bloc + sensors.
- PAW-HPM12ZONE-M**  
HPM with room sensor and setpoint adaption for Mono-bloc + sensors.
- PAW-HPM12ZONE-UF**  
HPM with room sensor and setpoint adaption for F Generation Bi-bloc and Mono-bloc.
- PAW-HPM12ZONE-MF**  
HPM with room sensor and setpoint adaption for F Generation Bi-bloc and Mono-bloc.
- PAW-HPM12ZONELCD-U**  
HPM with LCD wireless room thermostat for Bi-bloc + sensors.
- PAW-HPM12ZONELCD-M**  
HPM with LCD wireless room thermostat for Mono-bloc + sensors.
- PAW-HPM12ZONELCD-UF**  
HPM with LCD wireless room thermostat for F Generation Bi-bloc and Mono-bloc.
- PAW-HPM12ZONELCD-MF**  
HPM with LCD wireless room thermostat for F Generation Bi-bloc and Mono-bloc.

\* Not compatible with H Generation.

## Aquarea Manager accessories\*

- PAW-HPM1**  
Aquarea Manager with LCD.
- PAW-HPM2**  
Aquarea Manager without LCD.
- PAW-HPMINT-U**  
Interface to connect Aquarea Manager to Heat pump Aquarea Bi-bloc (HPM can control all parameters from HP).
- PAW-HPMINT-M**  
Interface to connect Aquarea Manager to Heat pump Aquarea Mono-bloc (HPM can control all parameters from HP).
- PAW-HPMINT-F**  
Interface to connect Aquarea Manager to Heat pump Aquarea Mono-bloc and Bi-bloc F type (HPM can control all parameters from HP).
- PAW-HPMB1**  
Buffer tank sensor.
- PAW-HPMDHW**  
Buffer tank sensor with well.
- PAW-HPMSOL1**  
Buffer tank sensor solar (with higher temperature range).
- PAW-HPMAH1**  
Water flow pipe sensor for heating circuit.
- PAW-HPMR4**  
Room sensor + set point adaptation.
- PAW-HPMED**  
Touch screen.
- PAW-HPMLCD**  
LCD Display HPM Manager.
- PAW-LANCABLE**  
Network cable.
- PAW-A2WSWITCH**  
Network switch.
- PAW-DEWPOINTSENSOR**  
Dew point sensor.
- PAW-HPMUH**  
Outdoor temperature sensor.



\* Not compatible with H Generation.



**Room thermostats**

**PAW-A2W-RTWIRED**  
Wired LCD room thermostat with weekly timer.  
**PAW-A2W-RTWIRELESS**  
Wireless LCD room thermostat with weekly timer.



**Controller\***

**PAW-A2W-BIV**  
Bivalent controller.



\* Not compatible with H Generation.

**Connectivity solutions**

**CZ-TAW1**  
Aquarea Smart Cloud, H Generation Internet control through Wifi or wired LAN.  
**PAW-AW-KNX-H**  
KNX interface for H Generation.  
**PAW-AW-MBS-H**  
Modbus interface for H Generation.  
**PAW-AW-KNX-1i\***  
KNX interface.  
**PAW-AW-MBS-1\***  
Modbus interface.  
**PA-AW-WIFI-1TE\***  
IntesisHome interface with temperature sensor accessory.



\* Not compatible with H Generation.

**H Generation sensors**

**PAW-A2W-TSOD**  
Outdoor ambient sensor.  
**PAW-A2W-TSRT**  
Zone room sensor.  
**PAW-A2W-TSBU**  
Buffer tank sensor.  
**PAW-A2W-TSHC**  
Zone water sensor.  
**PAW-A2W-TSSO**  
Solar sensor.



**H Generation tools**

**PAW-A2WLOGGER**  
Data Logger: With this tool we can log data during a long period.  
**PAW-A2WCHECKER**  
Service checker: With this tool we will have a life monitoring at our PC.

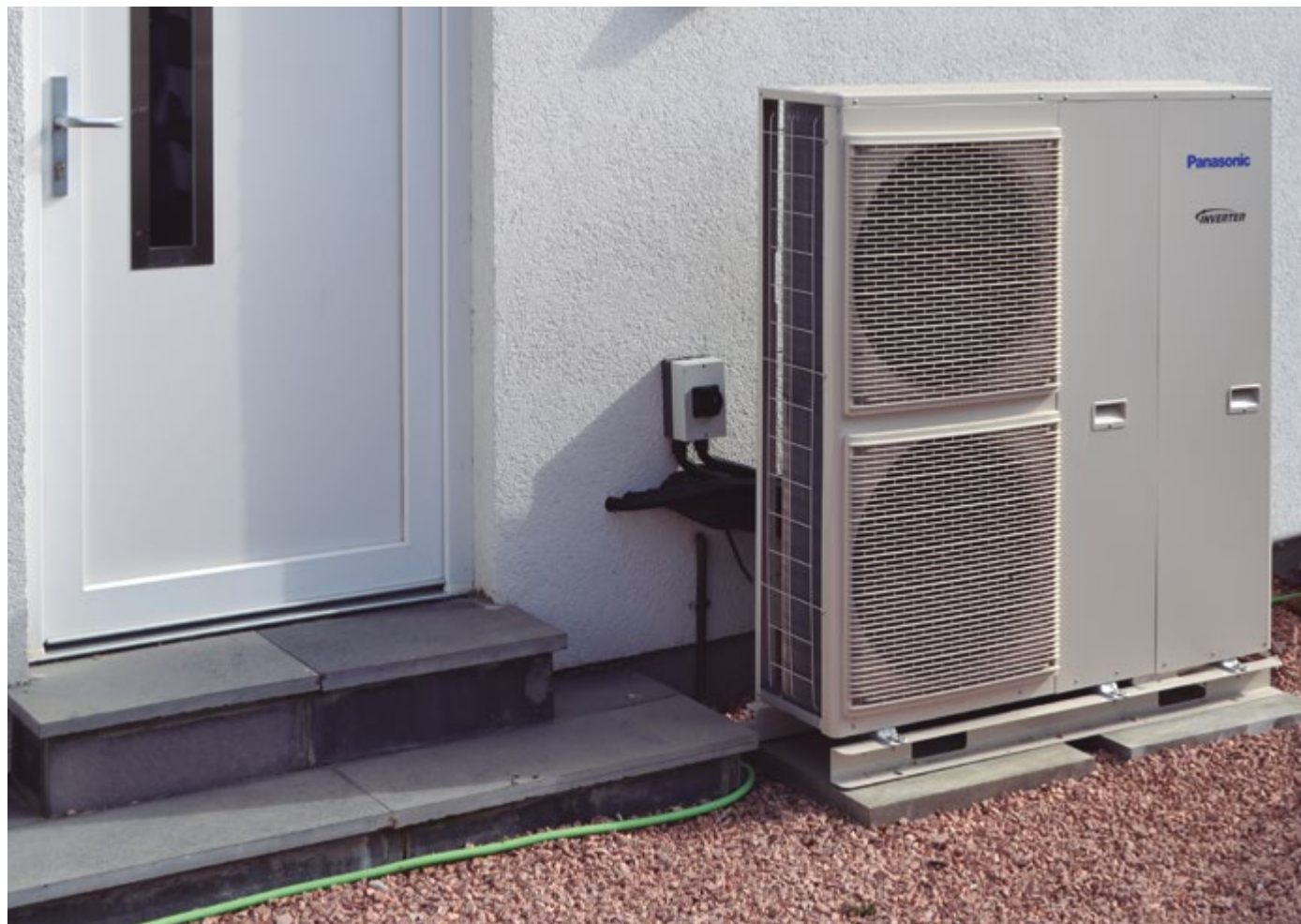

# HEATING & COOLING CAPACITY TABLES

Based on outlet temperature and outside temperature.

## Heating capacity table

Aquarea H Generation High Performance Bi-bloc Single Phase. Heating and Cooling

WH-UD03HE5-1 / WH-UD03HE5

Tamb	HC	IP	COP	HC	IP	COP	HC	IP	COP	HC	IP	COP	HC	IP	COP	HC	IP	COP
LWC	30	30	30	35	35	35	40	40	40	45	45	45	50	50	50	55	55	55
-15	3,20	1,26	2,54	3,20	1,39	2,30	3,10	1,52	2,04	3,00	1,64	1,83	2,80	1,78	1,57	2,75	1,92	1,43
-7	3,20	1,08	2,96	3,20	1,19	2,69	3,20	1,34	2,39	3,20	1,48	2,16	3,20	1,67	1,92	3,20	1,86	1,72
2	3,20	0,82	3,90	3,20	0,90	3,56	3,20	1,03	3,11	3,20	1,16	2,76	3,20	1,33	2,41	3,20	1,49	2,15
7	3,20	0,58	5,52	3,20	0,64	5,00	3,20	0,77	4,16	3,20	0,89	3,60	3,20	1,05	3,05	3,20	1,20	2,67
16	3,20	0,50	6,40	3,20	0,55	5,82	3,20	0,64	5,00	3,20	0,72	4,44	3,20	0,86	3,72	3,20	0,99	3,23
25	3,20	0,42	7,62	3,20	0,46	6,96	3,20	0,55	5,82	3,20	0,63	5,08	3,20	0,73	4,38	3,20	0,82	3,90

WH-UD05HE5-1 / WH-UD05HE5

Tamb	HC	IP	COP	HC	IP	COP	HC	IP	COP	HC	IP	COP	HC	IP	COP	HC	IP	COP
LWC	30	30	30	35	35	35	40	40	40	45	45	45	50	50	50	55	55	55
-15	4,20	1,75	2,40	4,20	1,94	2,16	3,80	1,96	1,94	3,40	1,98	1,72	3,20	2,05	1,56	3,00	2,12	1,42
-7	4,20	1,46	2,88	4,20	1,62	2,59	4,00	1,72	2,33	3,80	1,82	2,09	3,70	1,95	1,90	3,55	2,08	1,71
2	4,20	1,22	3,44	4,20	1,35	3,11	4,20	1,50	2,80	4,20	1,65	2,55	4,15	1,86	2,23	4,10	2,07	1,98
7	5,00	0,97	5,15	5,00	1,08	4,63	5,00	1,28	3,91	5,00	1,48	3,38	5,00	1,68	2,98	5,00	1,89	2,65
16	5,00	0,83	6,02	5,00	0,92	5,43	5,00	1,15	4,35	5,00	1,38	3,62	5,00	1,53	3,27	5,00	1,68	2,98
25	5,00	0,74	6,76	5,00	0,82	6,10	5,00	1,02	4,90	5,00	1,22	4,10	5,00	1,35	3,70	5,00	1,49	3,36

WH-UD07HE5-1 / WH-UD07HE5

Tamb	HC	IP	COP	HC	IP	COP	HC	IP	COP	HC	IP	COP	HC	IP	COP	HC	IP	COP
LWC	30	30	30	35	35	35	40	40	40	45	45	45	50	50	50	55	55	55
-15	—	—	—	4,60	1,98	2,32	4,60	2,19	2,10	4,60	2,40	1,92	4,55	2,63	1,73	4,50	2,86	1,57
-7	—	—	—	5,15	1,92	2,68	5,08	2,14	2,37	5,00	2,36	2,12	4,90	2,45	2,00	4,80	2,54	1,89
2	—	—	—	6,55	1,96	3,34	6,58	2,29	2,87	6,60	2,62	2,52	6,30	2,82	2,23	6,00	3,01	1,99
7	—	—	—	7,00	1,57	4,46	7,00	1,84	3,80	7,00	2,10	3,33	6,90	2,35	2,94	6,80	2,59	2,63
25	—	—	—	7,00	0,97	7,22	6,74	1,14	5,91	6,48	1,31	4,95	6,24	1,43	4,36	6,00	1,55	3,87

WH-UD09HE5-1 / WH-UD09HE5

Tamb	HC	IP	COP	HC	IP	COP	HC	IP	COP	HC	IP	COP	HC	IP	COP	HC	IP	COP
LWC	30	30	30	35	35	35	40	40	40	45	45	45	50	50	50	55	55	55
-15	—	—	—	5,90	2,66	2,22	5,65	2,82	2,00	5,40	2,98	1,81	5,20	3,08	1,69	5,00	3,18	1,57
-7	—	—	—	5,90	2,34	2,52	5,85	2,61	2,24	5,80	2,88	2,01	5,80	2,98	1,95	5,80	3,08	1,88
2	—	—	—	6,70	2,14	3,13	6,65	2,38	2,79	6,60	2,62	2,52	6,30	2,82	2,23	6,00	3,01	1,99
7	—	—	—	9,00	2,18	4,13	9,00	2,49	3,61	9,00	2,79	3,23	8,95	3,25	2,75	8,90	3,70	2,41
25	—	—	—	9,00	1,26	7,14	8,66	1,48	5,85	8,32	1,69	4,92	8,03	1,85	4,34	7,74	2,01	3,85

## Cooling capacity table

Aquarea H Generation High Performance Bi-bloc Single Phase. Heating and Cooling

WH-UD03HE5-1 / WH-UD03HE5

Tamb	CC	IP	EER	CC	IP	EER	CC	IP	EER
LWC	7	7	7	14	14	14	18	18	18
18	2,40	0,42	5,71	4,40	0,73	6,03	3,70	0,49	7,55
25	3,20	0,73	4,38	4,10	0,86	4,77	3,50	0,59	5,93
35	3,20	1,04	3,08	3,90	1,07	3,64	3,30	0,74	4,46
43	2,90	1,20	2,42	3,50	1,20	2,92	3,00	0,88	3,41

WH-UD05HE5-1 / WH-UD05HE5

Tamb	CC	IP	EER	CC	IP	EER	CC	IP	EER
LWC	7	7	7	14	14	14	18	18	18
18	4,50	0,89	5,06	5,00	0,90	5,56	5,70	0,90	6,33
25	5,00	1,43	3,50	6,30	1,50	4,20	5,40	1,06	5,09
35	4,50	1,67	2,69	5,50	1,68	3,27	5,00	1,33	3,76
43	3,30	1,53	2,16	4,10	1,52	2,70	4,40	1,53	2,88

WH-UD07HE5-1 / WH-UD07HE5

Tamb	CC	IP	EER	CC	IP	EER	CC	IP	EER
LWC	7	7	7	14	14	14	18	18	18
18	4,80	0,80	6,00	7,20	1,16	6,21	6,00	1,13	5,31
25	7,00	1,90	3,68	8,47	1,78	4,76	6,00	1,27	4,72
35	6,00	2,28	2,63	6,60	2,48	2,66	6,00	1,68	3,57
43	4,85	2,65	1,83	6,00	2,82	2,13	4,80	1,98	2,42

WH-UD09HE5-1 / WH-UD09HE5

Tamb	CC	IP	EER	CC	IP	EER	CC	IP	EER
LWC	7	7	7	14	14	14	18	18	18
18	5,40	1,00	5,40	8,40	1,62	5,19	7,00	1,61	4,35
25	7,85	2,40	3,27	10,20	2,46	4,15	7,00	1,77	3,95
35	7,00	2,88	2,43	7,60	3,20	2,38	7,00	2,15	3,26
43	5,20	2,85	1,82	6,99	3,84	1,82	5,60	2,55	2,20

Tamb: Ambient Temperature (°C). LWC: Leaving Water Condenser Temperature (°C). HC: Heating Capacity (kW). CC: Cooling Capacity (kW). IP: Power Input (kW)  
This data is measured by Panasonic in accordance with EN14511-2 standard. This data is for reference purpose only, and does not guarantee the performance.

### Heating capacity table

Aquarea H Generation High Performance Bi-bloc Three Phase. Heating and Cooling

WH-UD09HE8																			
Tamb	HC	IP	COP	HC	IP	COP	HC	IP	COP	HC	IP	COP	HC	IP	COP	HC	IP	COP	
LWC	30	30	30	35	35	35	40	40	40	45	45	45	50	50	50	55	55	55	
-15	8,65	3,06	2,83	8,30	3,21	2,59	7,95	3,41	2,33	7,60	3,61	2,11	7,15	3,71	1,93	6,70	3,81	1,76	
-7	9,35	2,91	3,21	9,00	3,16	2,85	8,85	3,54	2,50	8,70	3,92	2,22	8,30	3,89	2,13	7,90	3,86	2,05	
2	9,31	2,35	3,96	9,00	2,51	3,59	9,00	2,78	3,24	9,00	3,05	2,95	8,90	3,49	2,55	8,80	3,94	2,23	
7	9,00	1,54	5,84	9,00	1,86	4,84	9,00	2,16	4,17	9,00	2,46	3,66	9,00	2,76	3,26	9,00	3,06	2,94	
25	9,00	1,05	8,57	9,00	1,24	7,26	8,73	1,44	6,06	8,46	1,64	5,16	8,28	1,82	4,55	8,10	2,00	4,05	
WH-UD12HE8																			
Tamb	HC	IP	COP	HC	IP	COP	HC	IP	COP	HC	IP	COP	HC	IP	COP	HC	IP	COP	
LWC	30	30	30	35	35	35	40	40	40	45	45	45	50	50	50	55	55	55	
-15	9,30	3,46	2,69	8,90	3,62	2,46	8,50	3,79	2,24	8,10	3,95	2,05	7,50	4,05	1,85	7,00	4,16	1,68	
-7	10,40	3,37	3,09	10,00	3,66	2,73	9,60	3,95	2,43	9,20	4,24	2,17	8,70	4,26	2,04	8,20	4,27	1,92	
2	11,80	3,10	3,81	11,40	3,31	3,44	11,00	3,53	3,12	10,60	3,74	2,83	9,80	3,94	2,49	9,10	4,14	2,20	
7	12,00	2,10	5,71	12,00	2,53	4,74	12,00	2,96	4,05	12,00	3,39	3,54	12,00	3,78	3,17	12,00	4,16	2,88	
25	12,00	1,38	8,70	12,00	1,66	7,23	11,80	1,94	6,08	11,70	2,23	5,25	11,50	2,49	4,62	11,40	2,74	4,16	
WH-UD16HE8																			
Tamb	HC	IP	COP	HC	IP	COP	HC	IP	COP	HC	IP	COP	HC	IP	COP	HC	IP	COP	
LWC	30	30	30	35	35	35	40	40	40	45	45	45	50	50	50	55	55	55	
-15	10,60	4,09	2,59	10,30	4,38	2,35	10,00	4,67	2,14	9,70	4,96	1,96	8,80	4,94	1,78	7,90	4,91	1,61	
-7	11,90	4,03	2,95	11,40	4,43	2,57	10,80	4,83	2,24	10,30	5,22	1,97	9,60	5,09	1,89	9,00	4,95	1,82	
2	13,50	3,74	3,61	13,00	3,96	3,28	12,40	4,18	2,97	11,90	4,40	2,70	10,80	4,46	2,42	9,80	4,51	2,17	
7	16,00	3,21	4,98	16,00	3,74	4,28	16,00	4,27	3,75	16,00	4,80	3,33	15,20	5,11	2,97	14,50	5,41	2,68	
25	16,00	2,31	6,93	16,00	2,69	5,95	16,00	3,07	5,21	16,00	3,45	4,64	16,00	3,67	4,36	15,90	3,89	4,09	

### Cooling capacity table

Aquarea H Generation High Performance Bi-bloc Three Phase. Heating and Cooling

WH-UD09HE8									
Tamb	CC	IP	EER	CC	IP	EER	CC	IP	EER
LWC	7	7	7	14	14	14	18	18	18
16	7,50	1,15	6,52	9,10	1,20	7,58	7,00	1,13	6,19
25	8,35	1,77	4,72	10,90	1,78	6,12	7,00	1,24	5,65
35	7,00	2,23	3,14	8,30	2,32	3,58	7,00	1,52	4,61
43	5,52	2,54	2,17	7,69	2,77	2,78	5,60	1,80	3,11
WH-UD12HE8									
Tamb	CC	IP	EER	CC	IP	EER	CC	IP	EER
LWC	7	7	7	14	14	14	18	18	18
16	7,86	1,18	6,66	13,15	1,40	9,39	10,00	1,73	5,78
25	12,08	2,90	4,17	15,70	2,05	7,66	10,00	1,97	5,08
35	10,00	2,56	3,91	12,00	2,67	4,49	10,00	2,40	4,17
43	7,80	3,80	2,05	11,10	3,19	3,48	8,00	2,85	2,81
WH-UD16HE8									
Tamb	CC	IP	EER	CC	IP	EER	CC	IP	EER
LWC	7	7	7	14	14	14	18	18	18
16	9,20	1,62	5,68	16,40	2,58	6,36	12,20	2,45	4,98
25	14,40	3,92	3,67	19,20	3,83	5,01	12,20	2,79	4,37
35	12,20	4,76	2,56	15,00	4,98	3,01	12,20	2,96	4,12
43	7,75	3,40	2,28	13,80	5,95	2,32	9,70	4,00	2,43

Tamb: Ambient Temperature (°C). LWC: Leaving Water Condenser Temperature (°C). HC: Heating Capacity (kW). CC: Cooling Capacity (kW). IP: Power Input (kW). This data is measured by Panasonic in accordance with EN14511-2 standard. This data is for reference purpose only, and does not guarantee the performance.

# HEATING & COOLING CAPACITY TABLES

Based on outlet temperature and outside temperature.

## Heating capacity table

Aquarea All in One H Generation T-CAP Bi-bloc Three Phase. Heating and Cooling

WH-UX09HE8																			
Tamb	HC	IP	COP	HC	IP	COP	HC	IP	COP	HC	IP	COP	HC	IP	COP	HC	IP	COP	
LWC	30	30	30	35	35	35	40	40	40	45	45	45	50	50	50	55	55	55	
-15	9,00	3,24	2,78	9,00	3,51	2,56	9,00	3,91	2,30	9,00	4,30	2,09	9,00	4,73	1,90	9,00	5,16	1,74	
-7	9,00	2,71	3,32	9,00	3,16	2,85	9,00	3,62	2,49	9,00	4,07	2,21	9,00	4,27	2,11	9,00	4,46	2,02	
2	9,00	2,36	3,81	9,00	2,51	3,59	9,00	2,78	3,24	9,00	3,05	2,95	9,00	3,56	2,53	9,00	4,07	2,21	
7	9,00	1,64	5,49	9,00	1,86	4,84	9,00	2,16	4,17	9,00	2,46	3,66	9,00	2,76	3,26	9,00	3,06	2,94	
25	13,60	1,50	9,07	13,60	1,71	7,95	13,20	1,93	6,84	12,80	2,14	5,98	12,00	2,41	4,98	11,20	2,67	4,19	

WH-UX12HE8																			
Tamb	HC	IP	COP	HC	IP	COP	HC	IP	COP	HC	IP	COP	HC	IP	COP	HC	IP	COP	
LWC	30	30	30	35	35	35	40	40	40	45	45	45	50	50	50	55	55	55	
-15	12,00	4,75	2,53	12,00	4,96	2,42	12,00	5,41	2,22	12,00	5,86	2,05	11,80	6,24	1,89	11,60	6,62	1,75	
-7	12,00	3,85	3,12	12,00	4,41	2,72	12,00	4,98	2,41	12,00	5,54	2,17	12,00	5,90	2,03	12,00	6,26	1,92	
2	12,00	3,19	3,76	12,00	3,49	3,44	12,00	3,87	3,10	12,00	4,25	2,82	12,00	4,86	2,47	12,00	5,47	2,19	
7	12,00	2,18	5,50	12,00	2,53	4,74	12,00	2,96	4,05	12,00	3,39	3,54	12,00	3,78	3,17	12,00	4,16	2,88	
25	13,60	1,55	8,77	13,60	1,76	7,73	13,40	2,10	6,38	13,20	2,43	5,43	12,60	2,66	4,74	12,00	2,89	4,15	

WH-UX16HE8																			
Tamb	HC	IP	COP	HC	IP	COP	HC	IP	COP	HC	IP	COP	HC	IP	COP	HC	IP	COP	
LWC	30	30	30	35	35	35	40	40	40	45	45	45	50	50	50	55	55	55	
-15	16,00	6,30	2,54	16,00	6,89	2,32	16,00	7,45	2,15	16,00	8,10	1,98	16,00	8,48	1,89	15,20	8,96	1,70	
-7	16,00	5,85	2,74	16,00	6,42	2,49	16,00	7,00	2,29	16,00	7,57	2,11	16,00	8,10	1,98	16,00	8,62	1,86	
2	16,00	4,67	3,43	16,00	5,21	3,07	16,00	5,74	2,79	16,00	6,31	2,54	16,00	6,90	2,32	16,00	7,50	2,13	
7	16,00	3,35	4,78	16,00	3,74	4,28	16,00	4,30	3,72	16,00	4,80	3,33	16,00	5,43	2,95	16,00	5,91	2,71	
16	16,00	2,59	6,18	16,00	3,18	5,03	16,00	3,71	4,31	16,00	4,27	3,75	16,00	4,86	3,29	16,00	5,22	3,07	
25	16,00	2,02	7,92	16,00	2,58	6,20	16,00	2,91	5,50	16,00	3,36	4,76	16,00	3,74	4,28	16,00	4,00	4,00	

## Cooling capacity table

Aquarea All in One H Generation T-CAP Bi-bloc Three Phase. Heating and Cooling

WH-UX09HE8						
Tamb	CC	IP	EER	CC	IP	EER
LWC	7	7	7	18	18	18
18	7,00	1,36	5,15	—	—	—
25	7,65	1,91	4,01	—	—	—
35	7,00	2,21	3,17	—	—	—
43	6,25	2,66	2,35	—	—	—

WH-UX12HE8						
Tamb	CC	IP	EER	CC	IP	EER
LWC	7	7	7	18	18	18
18	7,50	1,41	5,32	—	—	—
25	8,90	2,16	4,12	—	—	—
35	10,00	3,56	2,81	—	—	—
43	8,00	3,01	2,66	—	—	—

WH-UX16HE8						
Tamb	CC	IP	EER	CC	IP	EER
LWC	7	7	7	18	18	18
18	8,50	1,70	5,00	10,00	1,70	5,88
25	14,00	4,00	3,50	14,00	2,94	4,76
35	12,20	4,76	2,56	12,20	3,50	3,49
43	7,10	3,31	2,15	9,80	3,31	2,96

Tamb: Ambient Temperature (°C). LWC: Leaving Water Condenser Temperature (°C). HC: Heating Capacity (kW). CC: Cooling Capacity (kW). IP: Power Input (kW)  
 This data is measured by Panasonic in accordance with EN14511-2 standard. This data is for reference purpose only, and does not guarantee the performance.



### Heating capacity table

Aquarea High Performance Bi-bloc Single Phase / Three Phase. Heating and Cooling

**WH-UD09FE8**

Tamb	HC	IP	COP	HC	IP	COP	HC	IP	COP	HC	IP	COP	HC	IP	COP	HC	IP	COP
LWC	30	30	30	35	35	35	40	40	40	45	45	45	50	50	50	55	55	55
-15	8,65	3,06	2,83	8,30	3,21	2,59	7,95	3,41	2,33	7,60	3,61	2,11	7,15	3,71	1,93	6,70	3,81	1,76
-7	9,35	2,91	3,21	9,00	3,16	2,85	8,85	3,54	2,50	8,70	3,92	2,21	8,30	3,89	2,13	7,90	3,86	2,05
2	9,31	2,35	3,96	9,00	2,51	3,59	9,00	2,78	3,24	9,00	3,05	2,95	8,90	3,49	2,55	8,80	3,94	2,23
7	9,00	1,54	5,84	9,00	1,86	4,84	9,00	2,16	4,17	9,00	2,46	3,66	9,00	2,76	3,26	9,00	3,06	2,94
25	9,00	1,05	8,57	9,00	1,24	7,26	8,73	1,44	6,06	8,46	1,64	5,16	8,28	1,82	4,55	8,10	2,00	4,05

**WH-UD12FE5 / WH-UD12FE8**

Tamb	HC	IP	COP	HC	IP	COP	HC	IP	COP	HC	IP	COP	HC	IP	COP	HC	IP	COP
LWC	30	30	30	35	35	35	40	40	40	45	45	45	50	50	50	55	55	55
-15	9,30	3,46	2,69	8,90	3,62	2,46	8,50	3,79	2,24	8,10	3,95	2,05	7,50	4,05	1,85	7,00	4,16	1,68
-7	10,40	3,37	3,09	10,00	3,66	2,73	9,60	3,95	2,43	9,20	4,24	2,17	8,70	4,26	2,04	8,20	4,27	1,92
2	11,80	3,10	3,81	11,40	3,31	3,44	11,00	3,53	3,12	10,60	3,74	2,83	9,80	3,94	2,49	9,10	4,14	2,20
7	12,00	2,10	5,71	12,00	2,53	4,74	12,00	2,96	4,05	12,00	3,39	3,54	12,00	3,78	3,17	12,00	4,16	2,88
25	12,00	1,38	8,70	12,00	1,66	7,23	11,80	1,94	6,08	11,70	2,23	5,25	11,50	2,49	4,62	11,40	2,74	4,16

**WH-UD16FE5 / WH-UD12FE8**

Tamb	HC	IP	COP	HC	IP	COP	HC	IP	COP	HC	IP	COP	HC	IP	COP	HC	IP	COP
LWC	30	30	30	35	35	35	40	40	40	45	45	45	50	50	50	55	55	55
-15	10,60	4,09	2,59	10,30	4,38	2,35	10,00	4,67	2,14	9,70	4,96	1,96	8,80	4,94	1,78	7,90	4,91	1,61
-7	11,90	4,03	2,95	11,40	4,43	2,57	10,80	4,83	2,24	10,30	5,22	1,97	9,60	5,09	1,89	9,00	4,95	1,82
2	13,50	3,74	3,61	13,00	3,96	3,28	12,40	4,18	2,97	11,90	4,40	2,70	10,80	4,46	2,42	9,80	4,51	2,17
7	16,00	3,21	4,98	16,00	3,74	4,28	16,00	4,27	3,75	16,00	4,80	3,33	15,20	5,11	2,97	14,50	5,41	2,68
25	16,00	2,31	6,93	16,00	2,69	5,95	16,00	3,07	5,21	16,00	3,45	4,64	16,00	3,67	4,36	15,90	3,89	4,09

### Cooling capacity table

Aquarea High Performance Bi-bloc Single Phase / Three Phase. Heating and Cooling

Models	WH-UD09FE8									WH-UD12FE5 / WH-UD12FE8								
	CC	IP	EER	CC	IP	EER	CC	IP	EER	CC	IP	EER	CC	IP	EER	CC	IP	EER
LWC	7	7	7	14	14	14	18	18	18	7	7	7	14	14	14	18	18	18
18	7,50	1,15	6,52	9,10	1,20	7,58	7,00	1,13	6,19	7,86	1,18	6,66	13,15	1,40	9,39	10,00	1,73	5,78
25	8,35	1,77	4,72	10,90	1,78	6,12	7,00	1,24	5,65	12,08	2,90	4,17	15,70	2,05	7,66	10,00	1,97	5,08
35	7,00	2,23	3,14	8,30	2,32	3,58	7,00	1,52	4,61	10,00	2,56	3,91	12,00	2,67	4,49	10,00	2,40	4,17
43	5,52	2,54	2,17	7,69	2,77	2,78	5,60	1,80	3,11	7,80	3,80	2,05	11,10	3,19	3,48	8,00	2,85	2,81

  

Models	WH-UD16FE5 / WH-UD12FE8								
	CC	IP	EER	CC	IP	EER	CC	IP	EER
LWC	7	7	7	14	14	14	18	18	18
18	9,20	1,62	5,68	16,40	2,58	6,36	12,20	2,45	4,98
25	14,40	3,92	3,67	19,20	3,83	5,01	12,20	2,79	4,37
35	12,20	4,76	2,56	15,00	4,98	3,01	12,20	2,96	4,12
43	7,75	3,40	2,28	13,80	5,95	2,32	9,70	4,00	2,43

Tamb: Ambient Temperature (°C). LWC: Leaving Water Condenser Temperature (°C). HC: Heating Capacity (kW). CC: Cooling Capacity (kW). IP: Power Input (kW)  
 This data is measured by Panasonic in accordance with EN14511-2 standard. This data is for reference purpose only, and does not guarantee the performance.

Hydraulic Pump Performance of the F type Heat Pumps: A class pump F (5kW and 16kW).

External Static Pressure (kPa)

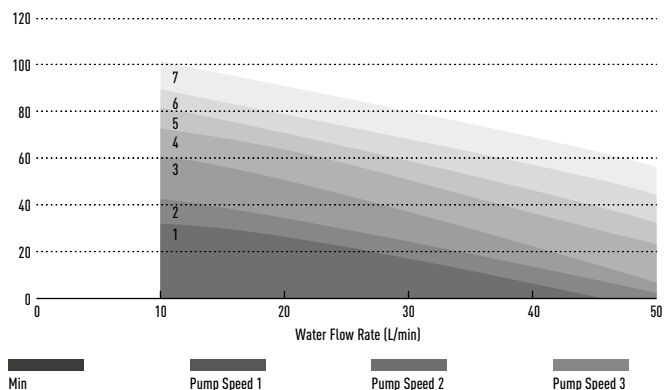

Hydraulic Pump Performance of the F type Heat Pumps: A class pump F (5kW and 16kW).

Power consumption (W)

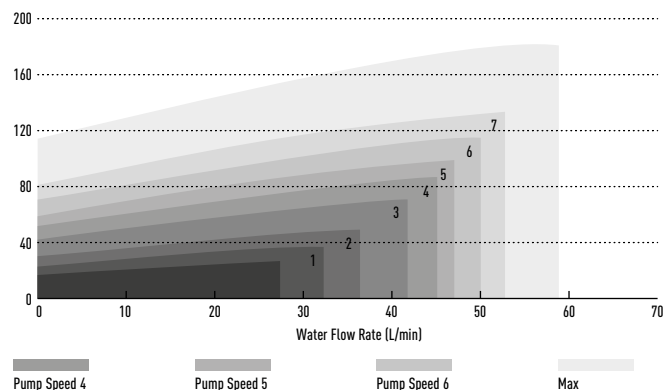

# HEATING & COOLING CAPACITY TABLES

Based on outlet temperature and outside temperature.

## Heating capacity table

Aquarea T-CAP Bi-bloc Single Phase. Heating and Cooling

WH-UX09FE5

Tamb	HC	IP	COP	HC	IP	COP	HC	IP	COP	HC	IP	COP	HC	IP	COP	HC	IP	COP
LWC	30	30	30	35	35	35	40	40	40	45	45	45	50	50	50	55	55	55
-15	9,00	3,24	2,78	9,00	3,51	2,56	9,00	3,91	2,30	9,00	4,30	2,09	9,00	4,73	1,90	9,00	5,16	1,74
-7	9,00	2,71	3,32	9,00	3,16	2,85	9,00	3,62	2,49	9,00	4,07	2,21	9,00	4,27	2,11	9,00	4,46	2,02
2	9,00	2,36	3,81	9,00	2,51	3,59	9,00	2,78	3,24	9,00	3,05	2,95	9,00	3,56	2,53	9,00	4,07	2,21
7	9,00	1,64	5,49	9,00	1,86	4,84	9,00	2,16	4,17	9,00	2,46	3,66	9,00	2,76	3,26	9,00	3,06	2,94
25	13,60	1,50	9,07	13,60	1,71	7,95	13,20	1,93	6,84	12,80	2,14	5,98	12,00	2,41	4,98	11,20	2,67	4,19

WH-UX12FE5

Tamb	HC	IP	COP	HC	IP	COP	HC	IP	COP	HC	IP	COP	HC	IP	COP	HC	IP	COP
LWC	30	30	30	35	35	35	40	40	40	45	45	45	50	50	50	55	55	55
-15	12,00	4,75	2,53	12,00	4,96	2,42	12,00	5,17	2,22	11,00	5,38	2,04	10,80	5,82	1,86	10,50	6,26	1,68
-7	12,00	3,85	3,12	12,00	4,41	2,72	12,00	4,98	2,41	12,00	5,54	2,17	12,00	5,90	2,03	12,00	6,26	1,92
2	12,00	3,19	3,76	12,00	3,49	3,44	12,00	3,87	3,10	12,00	4,25	2,82	12,00	4,86	2,47	12,00	5,47	2,19
7	12,00	2,18	5,50	12,00	2,53	4,74	12,00	2,96	4,05	12,00	3,39	3,54	12,00	3,78	3,17	12,00	4,16	2,88
25	13,60	1,55	8,77	13,60	1,76	7,73	13,40	2,10	6,38	13,20	2,43	5,43	12,60	2,66	4,74	12,00	2,89	4,15

## Cooling capacity table

Aquarea T-CAP Bi-bloc Single Phase. Heating and Cooling

WH-UX09FE5

Tamb	CC	IP	EER	CC	IP	EER	CC	IP	EER
LWC	7	7	7	14	14	14	18	18	18
18	7,00	1,36	5,15	8,55	1,41	6,06	7,00	1,00	7,00
25	7,65	1,91	4,01	11,10	1,98	5,61	7,00	1,10	6,36
35	7,00	2,21	3,17	9,23	2,37	3,89	7,00	1,35	5,19
43	6,25	2,66	2,35	8,55	2,71	3,15	5,60	1,60	3,50

WH-UX12FE5

Tamb	CC	IP	EER	CC	IP	EER	CC	IP	EER
LWC	7	7	7	14	14	14	18	18	18
18	10,00	1,75	5,71	13,20	1,96	6,73	10,00	1,40	7,14
25	11,20	2,67	4,19	16,50	3,01	5,48	10,00	1,60	6,25
35	10,00	3,56	2,81	12,55	3,63	3,46	10,00	1,95	5,13
43	8,00	3,35	2,39	10,00	3,46	2,89	8,00	2,30	3,48

Tamb: Ambient Temperature (°C). LWC: Leaving Water Condenser Temperature (°C). HC: Heating Capacity (kW). CC: Cooling Capacity (kW). IP: Power Input (kW)  
This data is measured by Panasonic in accordance with EN14511-2 standard. This data is for reference purpose only, and does not guarantee the performance.

### Heating capacity table

**Aquarea HT Bi-bloc Single Phase / Three Phase. Heating Only**

**WH-UH09FE5**

Tamb	HC	IP	COP	HC	IP	COP	HC	IP	COP	HC	IP	COP	HC	IP	COP	HC	IP	COP	HC	IP	COP	HC	IP	COP
LWC	30	30	30	35	35	35	40	40	40	45	45	45	50	50	50	55	55	55	60	60	60	65	65	65
-15	9,00	3,46	2,60	9,00	3,71	2,43	9,00	4,01	2,24	8,80	4,26	2,07	8,60	4,61	1,87	8,50	4,91	1,73	8,00	5,06	1,58	7,80	5,86	1,33
-7	9,00	3,06	2,94	9,00	3,29	2,74	9,00	3,56	2,53	8,90	3,83	2,32	8,90	4,11	2,17	8,90	4,46	2,00	8,90	4,96	1,79	8,90	5,46	1,63
2	9,00	2,43	3,70	9,00	2,61	3,45	9,00	2,91	3,09	9,00	3,21	2,80	9,00	3,55	2,54	9,00	3,88	2,32	9,00	4,35	2,07	9,00	4,76	1,89
7	9,00	1,82	4,95	9,00	1,94	4,64	9,00	2,21	4,07	9,00	2,46	3,66	9,00	2,76	3,26	9,00	3,06	2,94	9,00	3,46	2,60	9,00	3,96	2,27
16	9,00	1,46	6,16	9,00	1,56	5,77	9,00	1,81	4,97	8,90	2,02	4,41	8,80	2,31	3,81	8,60	2,52	3,41	8,20	2,77	2,96	8,20	3,18	2,58
25	12,00	1,66	7,23	12,00	1,76	6,82	12,00	2,01	5,97	10,80	2,14	5,05	10,60	2,46	4,31	10,20	2,66	3,83	9,80	2,89	3,39	9,60	3,31	2,90

**WH-UH12FE5**

Tamb	HC	IP	COP	HC	IP	COP	HC	IP	COP	HC	IP	COP	HC	IP	COP	HC	IP	COP	HC	IP	COP	HC	IP	COP
LWC	30	30	30	35	35	35	40	40	40	45	45	45	50	50	50	55	55	55	60	60	60	65	65	65
-15	12,00	5,16	2,33	12,00	5,53	2,17	11,00	5,51	2,00	10,60	5,53	1,92	10,30	5,63	1,83	9,70	5,76	1,68	9,00	6,01	1,50	8,00	6,11	1,31
-7	12,00	4,43	2,71	12,00	4,76	2,52	11,50	4,91	2,34	11,20	5,06	2,21	10,80	5,16	2,09	10,10	5,28	1,91	10,00	5,66	1,77	9,60	5,91	1,62
2	12,00	3,42	3,51	12,00	3,68	3,26	11,50	3,86	2,98	11,30	4,14	2,73	11,00	4,51	2,44	10,80	4,86	2,22	10,65	5,31	2,01	10,30	5,59	1,84
7	12,00	2,52	4,76	12,00	2,69	4,46	12,00	3,06	3,92	12,00	3,44	3,49	12,00	3,81	3,15	12,00	4,28	2,80	12,00	4,76	2,52	12,00	5,41	2,22
16	12,00	2,03	5,91	12,00	2,17	5,53	12,00	2,52	4,76	12,00	2,86	4,20	11,50	3,19	3,61	11,50	3,48	3,30	11,00	3,82	2,88	11,00	4,37	2,52
25	12,00	1,66	7,23	12,00	1,76	6,82	12,00	2,01	5,97	11,80	2,41	4,90	11,20	2,64	4,24	10,80	2,86	3,78	10,50	3,11	3,38	10,30	3,62	2,85

**WH-UH09FE8**

Tamb	HC	IP	COP	HC	IP	COP	HC	IP	COP	HC	IP	COP	HC	IP	COP	HC	IP	COP	HC	IP	COP	HC	IP	COP
LWC	30	30	30	35	35	35	40	40	40	45	45	45	50	50	50	55	55	55	60	60	60	65	65	65
-15	9,00	3,46	2,60	9,00	3,71	2,43	9,00	4,01	2,24	8,80	4,26	2,07	8,60	4,61	1,87	8,50	4,91	1,73	8,00	5,06	1,58	7,80	5,86	1,33
-7	9,00	3,06	2,94	9,00	3,29	2,74	9,00	3,56	2,53	8,90	3,83	2,32	8,90	4,11	2,17	8,90	4,46	2,00	8,90	4,96	1,79	8,90	5,46	1,63
2	9,00	2,43	3,70	9,00	2,61	3,45	9,00	2,91	3,09	9,00	3,21	2,80	9,00	3,55	2,54	9,00	3,88	2,32	9,00	4,35	2,07	9,00	4,76	1,89
7	9,00	1,82	4,95	9,00	1,94	4,64	9,00	2,21	4,07	9,00	2,46	3,66	9,00	2,76	3,26	9,00	3,06	2,94	9,00	3,46	2,60	9,00	3,96	2,27
16	9,00	1,46	6,16	9,00	1,56	5,77	9,00	1,81	4,97	8,90	2,02	4,41	8,80	2,31	3,81	8,60	2,52	3,41	8,20	2,77	2,96	8,20	3,18	2,58
25	12,00	1,66	7,23	12,00	1,76	6,82	12,00	2,01	5,97	10,80	2,14	5,05	10,60	2,46	4,31	10,20	2,66	3,83	9,80	2,89	3,39	9,60	3,31	2,90

**WH-UH12FE8**

Tamb	HC	IP	COP	HC	IP	COP	HC	IP	COP	HC	IP	COP	HC	IP	COP	HC	IP	COP	HC	IP	COP	HC	IP	COP
LWC	30	30	30	35	35	35	40	40	40	45	45	45	50	50	50	55	55	55	60	60	60	65	65	65
-15	12,00	5,16	2,33	12,00	5,53	2,17	11,00	5,51	2,00	10,60	5,53	1,92	10,30	5,63	1,83	9,70	5,76	1,68	9,00	6,01	1,50	8,00	6,11	1,31
-7	12,00	4,43	2,71	12,00	4,76	2,52	11,50	4,91	2,34	11,20	5,06	2,21	10,80	5,16	2,09	10,10	5,28	1,91	10,00	5,66	1,77	9,60	5,91	1,62
2	12,00	3,42	3,51	12,00	3,68	3,26	11,50	3,86	2,98	11,30	4,14	2,73	11,00	4,51	2,44	10,80	4,86	2,22	10,65	5,31	2,01	10,30	5,59	1,84
7	12,00	2,52	4,76	12,00	2,69	4,46	12,00	3,06	3,92	12,00	3,44	3,49	12,00	3,81	3,15	12,00	4,28	2,80	12,00	4,76	2,52	12,00	5,41	2,22
16	12,00	2,03	5,91	12,00	2,17	5,53	12,00	2,52	4,76	12,00	2,86	4,20	11,50	3,19	3,61	11,50	3,48	3,30	11,00	3,82	2,88	11,00	4,37	2,52
25	12,00	1,66	7,23	12,00	1,76	6,82	12,00	2,01	5,97	11,80	2,41	4,90	11,20	2,64	4,24	10,80	2,86	3,78	10,50	3,11	3,38	10,30	3,62	2,85

Hydraulic Pump Performance of the F type Heat Pumps: A class pump F (5kW and 16kW).

External Static Pressure (kPa)

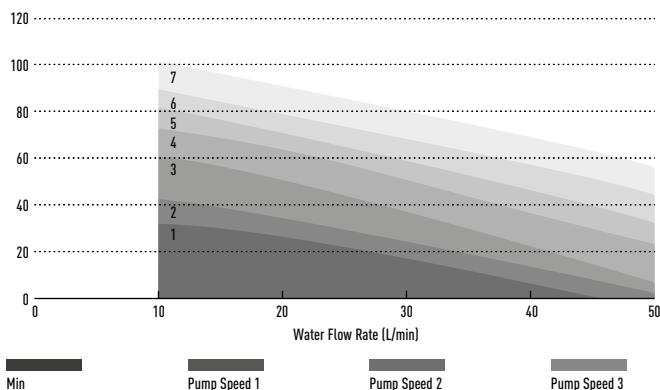

Hydraulic Pump Performance of the F type Heat Pumps: A class pump F (5kW and 16kW).

Pump consumption (W)

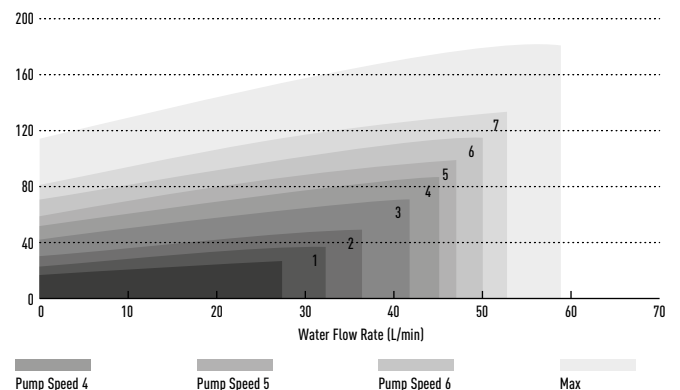

# HEATING & COOLING CAPACITY TABLES

Based on outlet temperature and outside temperature.

## Heating capacity table

Aqueara G Generation High Performance Mono-bloc Single Phase. Heating and Cooling - MDC

WH-MDC05F3E5																			
Tamb	HC	IP	COP	HC	IP	COP	HC	IP	COP	HC	IP	COP	HC	IP	COP	HC	IP	COP	
LWC	30	30	30	35	35	35	40	40	40	45	45	45	50	50	50	55	55	55	
-15	5,00	1,82	2,75	5,00	1,95	2,56	5,00	2,20	2,27	5,00	2,45	2,04	5,00	1,68	2,99	5,00	2,90	1,72	
-7	4,50	1,44	3,13	4,50	1,51	2,98	4,50	1,64	2,74	4,50	1,78	2,53	4,40	1,94	2,27	4,30	2,10	2,05	
2	4,80	1,22	3,93	4,80	1,28	3,75	4,65	1,40	3,32	4,50	1,52	2,96	4,25	1,62	2,62	4,00	1,72	2,33	
7	5,00	0,91	5,49	5,00	0,98	5,10	5,00	1,13	4,42	5,00	1,26	3,97	5,00	1,44	3,47	5,00	1,63	3,07	
25	5,00	0,67	7,46	5,00	0,71	7,04	5,00	0,78	6,41	5,00	0,86	5,81	5,00	0,98	5,10	5,00	1,10	4,55	
WH-MDC06G3E5																			
Tamb	HC	IP	COP	HC	IP	COP	HC	IP	COP	HC	IP	COP	HC	IP	COP	HC	IP	COP	
LWC	30	30	30	35	35	35	40	40	40	45	45	45	50	50	50	55	55	55	
-15	6,15	2,50	2,46	5,90	2,66	2,22	5,65	2,82	2,00	5,40	2,98	1,81	5,20	3,15	1,65	5,00	3,32	1,51	
-7	5,18	1,68	3,08	5,15	1,92	2,68	5,13	2,17	2,36	5,10	2,41	2,12	5,45	2,81	1,94	5,80	3,20	1,81	
2	5,00	1,23	4,07	5,00	1,45	3,45	5,00	1,68	2,98	5,00	1,90	2,63	5,00	2,19	2,28	5,00	2,48	2,02	
7	6,00	1,13	5,31	6,00	1,35	4,44	6,00	1,58	3,80	6,00	1,80	3,33	6,00	2,09	2,87	6,00	2,38	2,52	
25	7,30	0,78	9,36	7,10	0,93	7,63	6,90	1,09	6,33	6,70	1,24	5,40	6,50	1,41	4,61	6,30	1,58	3,99	
WH-MDC09G3E5																			
Tamb	HC	IP	COP	HC	IP	COP	HC	IP	COP	HC	IP	COP	HC	IP	COP	HC	IP	COP	
LWC	30	30	30	35	35	35	40	40	40	45	45	45	50	50	50	55	55	55	
-15	7,90	3,62	2,19	7,60	3,77	2,02	7,30	3,93	1,86	7,00	4,08	1,72	6,45	4,06	1,59	5,90	4,03	1,46	
-7	7,80	3,38	2,31	7,70	3,63	2,12	7,60	3,88	1,96	7,50	4,13	1,82	7,55	4,59	1,64	7,60	5,05	1,50	
2	7,00	2,01	3,48	7,45	2,37	3,14	7,00	2,60	2,69	7,00	2,89	2,42	7,00	3,37	2,08	7,00	3,85	1,82	
7	9,00	1,87	4,81	9,00	2,17	4,16	9,00	2,48	3,63	9,00	2,78	3,24	8,95	3,31	2,70	8,90	3,84	2,32	
25	9,00	0,99	9,09	9,00	1,31	6,87	9,00	1,63	5,52	9,00	1,95	4,62	9,00	2,20	4,09	9,00	2,45	3,67	
WH-MDC12G6E5																			
Tamb	HC	IP	COP	HC	IP	COP	HC	IP	COP	HC	IP	COP	HC	IP	COP	HC	IP	COP	
LWC	30	30	30	35	35	35	40	40	40	45	45	45	50	50	50	55	55	55	
-15	9,30	3,46	2,69	8,90	3,62	2,46	8,50	3,79	2,24	8,10	3,95	2,05	—	—	—	7,00	4,10	1,71	
-7	10,40	3,37	3,09	10,00	3,66	2,73	9,60	3,95	2,43	9,20	4,24	2,17	—	—	—	8,20	4,21	1,95	
2	11,80	3,10	3,81	11,40	3,31	3,44	11,00	3,53	3,12	10,60	3,74	2,83	—	—	—	9,10	4,08	2,23	
7	12,00	2,10	5,71	12,00	2,53	4,74	12,00	2,96	4,05	12,00	3,39	3,54	—	—	—	12,00	4,10	2,93	
25	12,00	1,38	8,70	12,00	1,66	7,23	11,80	1,94	6,08	11,70	2,23	5,25	—	—	—	11,40	2,74	4,16	
WH-MDC16G6E5																			
Tamb	HC	IP	COP	HC	IP	COP	HC	IP	COP	HC	IP	COP	HC	IP	COP	HC	IP	COP	
LWC	30	30	30	35	35	35	40	40	40	45	45	45	50	50	50	55	55	55	
-15	10,60	4,09	2,59	10,30	4,38	2,35	10,00	4,67	2,14	9,70	4,96	1,96	—	—	—	7,90	4,84	1,63	
-7	11,90	4,03	2,95	11,40	4,43	2,57	10,80	4,83	2,24	10,30	5,22	1,97	—	—	—	9,00	4,88	1,84	
2	13,50	3,74	3,61	13,00	3,96	3,28	12,40	4,18	2,97	11,90	4,40	2,70	—	—	—	9,80	4,44	2,21	
7	16,00	3,21	4,98	16,00	3,74	4,28	16,00	4,27	3,75	16,00	4,80	3,33	—	—	—	14,50	5,33	2,72	
25	16,00	2,31	6,93	16,00	2,69	5,95	16,00	3,07	5,21	16,00	3,45	4,64	—	—	—	15,90	3,89	4,09	

Tamb: Ambient Temperature (°C). LWC: Leaving Water Condenser Temperature (°C). HC: Heating Capacity (kW). CC: Cooling Capacity (kW). IP: Power Input (kW)  
 This data is measured by Panasonic in accordance with EN14511-2 standard. This data is for reference purpose only, and does not guarantee the performance.



## Cooling capacity table

### Aquarea G Generation High Performance Mono-bloc Single Phase. Heating and Cooling - MDC

#### WH-MDC05F3E5

Tamb	CC	IP	EER	CC	IP	EER	CC	IP	EER
LWC	7	7	7	14	14	14	18	18	18
18	1,95	0,45	4,33	2,20	0,45	4,89	2,45	0,50	4,90
25	5,00	1,25	4,00	6,30	1,20	5,25	6,30	0,80	7,88
35	4,50	1,35	3,33	5,10	1,50	3,40	5,00	1,00	5,00
43	3,75	1,75	2,14	4,50	1,80	2,50	4,25	1,20	3,54

#### WH-MDC06G3E5

Tamb	CC	IP	EER	CC	IP	EER	CC	IP	EER
LWC	7	7	7	14	14	14	18	18	18
18	4,64	0,91	5,10	5,83	0,99	5,89	6,74	0,94	7,17
25	5,85	1,43	4,09	9,55	1,73	5,52	9,81	1,68	5,84
35	5,50	2,03	2,71	6,70	2,06	3,25	7,30	2,05	3,56
43	4,56	2,34	1,95	6,31	2,47	2,55	7,14	2,45	2,91

#### WH-MDC09G3E5

Tamb	CC	IP	EER	CC	IP	EER	CC	IP	EER
LWC	7	7	7	14	14	14	18	18	18
18	5,36	1,05	5,10	6,12	1,08	5,67	7,02	1,08	6,50
25	6,44	1,85	3,48	10,50	2,51	4,18	11,16	2,52	4,43
35	7,00	2,90	2,41	8,40	2,95	2,85	9,00	3,00	3,00
43	5,32	3,18	1,67	6,34	2,48	2,56	6,78	2,46	2,76

#### WH-MDC12G6E5

Tamb	CC	IP	EER	CC	IP	EER	CC	IP	EER
LWC	7	7	7	14	14	14	18	18	18
18	7,86	1,18	6,66	13,15	2,05	6,41	10,00	1,73	5,78
25	12,08	2,90	4,17	15,70	3,05	5,15	10,00	1,97	5,08
35	10,00	3,56	2,81	12,00	3,67	3,27	10,00	2,15	4,65
43	7,80	3,80	2,05	11,10	3,19	3,48	8,00	2,85	2,81

#### WH-MDC16G6E5

Tamb	CC	IP	EER	CC	IP	EER	CC	IP	EER
LWC	7	7	7	14	14	14	18	18	18
18	9,20	1,62	5,68	16,40	2,58	6,36	12,20	2,45	4,98
25	14,40	3,92	3,67	19,20	3,83	5,01	12,20	2,79	4,37
35	12,20	4,76	2,56	15,00	4,98	3,01	12,20	2,96	4,12
43	7,75	3,40	2,28	13,80	5,95	2,32	9,70	4,00	2,43

Tamb: Ambient Temperature (°C). LWC: Leaving Water Condenser Temperature (°C). HC: Heating Capacity (kW). CC: Cooling Capacity (kW). IP: Power Input (kW)  
This data is measured by Panasonic in accordance with EN14511-2 standard. This data is for reference purpose only, and does not guarantee the performance.

# HEATING & COOLING CAPACITY TABLES

Based on outlet temperature and outside temperature.

## Heating capacity table

Aquarea G Generation T-CAP Mono-bloc Single Phase / Three Phase. Heating and Cooling - MXC

WH-MXC09G3E5 / WH-MXC09G3E8																			
Tamb	HC	IP	COP	HC	IP	COP	HC	IP	COP	HC	IP	COP	HC	IP	COP	HC	IP	COP	
LWC	30	30	30	35	35	35	40	40	40	45	45	45	50	50	50	55	55	55	
-15	9,00	3,24	2,78	9,00	3,51	2,56	9,00	3,91	2,30	9,00	4,30	2,09	9,00	4,73	1,90	9,00	5,16	1,74	
-7	9,00	2,71	3,32	9,00	3,16	2,85	9,00	3,62	2,49	9,00	4,07	2,21	9,00	4,27	2,11	9,00	4,46	2,02	
2	9,00	2,36	3,81	9,00	2,51	3,59	9,00	2,78	3,24	9,00	3,05	2,95	9,00	3,56	2,53	9,00	4,07	2,21	
7	9,00	1,64	5,49	9,00	1,86	4,84	9,00	2,16	4,17	9,00	2,46	3,66	9,00	2,76	3,26	9,00	3,06	2,94	
25	13,60	1,50	9,07	13,60	1,71	7,95	13,20	1,93	6,84	12,80	2,14	5,98	12,00	2,41	4,98	11,20	2,67	4,19	

WH-MXC12G6E5 / WH-MXC12G9E8																			
Tamb	HC	IP	COP	HC	IP	COP	HC	IP	COP	HC	IP	COP	HC	IP	COP	HC	IP	COP	
LWC	30	30	30	35	35	35	40	40	40	45	45	45	50	50	50	55	55	55	
-15	12,00	4,75	2,53	12,00	4,96	2,42	12,00	5,41	2,22	11,00	5,38	2,04	10,80	5,82	1,86	10,50	6,26	1,68	
-7	12,00	3,85	3,12	12,00	4,41	2,72	12,00	4,98	2,41	12,00	5,54	2,17	12,00	5,90	2,03	12,00	6,26	1,92	
2	12,00	3,19	3,76	12,00	3,49	3,44	12,00	3,87	3,10	12,00	4,25	2,82	12,00	4,86	2,47	12,00	5,47	2,19	
7	12,00	2,18	5,50	12,00	2,53	4,74	12,00	2,96	4,05	12,00	3,39	3,54	12,00	3,78	3,17	12,00	4,16	2,88	
25	13,60	1,55	8,77	13,60	1,76	7,73	13,40	2,10	6,38	13,20	2,43	5,43	12,60	2,66	4,74	12,00	2,89	4,15	

WH-MXC16G9E8																			
Tamb	HC	IP	COP	HC	IP	COP	HC	IP	COP	HC	IP	COP	HC	IP	COP	HC	IP	COP	
LWC	30	30	30	35	35	35	40	40	40	45	45	45	50	50	50	55	55	55	
-15	16,00	6,30	2,54	16,00	6,89	2,32	16,00	7,45	2,15	16,00	8,10	1,98	16,00	8,48	1,89	15,20	8,96	1,70	
-7	16,00	5,85	2,74	16,00	6,42	2,49	16,00	7,00	2,29	16,00	7,57	2,11	16,00	8,10	1,98	16,00	8,62	1,86	
2	16,00	4,67	3,43	16,00	5,21	3,07	16,00	5,74	2,79	16,00	6,31	2,54	16,00	6,90	2,32	16,00	7,50	2,13	
7	16,00	3,35	4,78	16,00	3,74	4,28	16,00	4,30	3,72	16,00	4,80	3,33	16,00	5,43	2,95	16,00	5,91	2,71	
25	16,00	2,02	7,92	16,00	2,58	6,20	16,00	2,91	5,49	16,00	3,36	4,76	16,00	3,74	4,28	16,00	4,00	4,00	

## Cooling capacity table

Aquarea G Generation T-CAP Mono-bloc Single Phase / Three Phase. Heating and Cooling - MXC

WH-MXC09G3E5 / WH-MXC09G3E8									
Tamb	CC	IP	EER	CC	IP	EER	CC	IP	EER
LWC	7	7	7	14	14	14	18	18	18
18	7,00	1,36	5,15	8,55	1,41	6,06	7,00	1,00	7,00
25	7,65	1,91	4,01	11,10	1,98	5,61	7,00	1,10	6,36
35	7,00	2,21	3,17	9,23	2,37	3,89	7,00	1,35	5,19
43	6,25	2,66	2,35	8,55	2,71	3,15	5,60	1,60	3,50

WH-MXC12G6E5 / WH-MXC12G9E8									
Tamb	CC	IP	EER	CC	IP	EER	CC	IP	EER
LWC	7	7	7	14	14	14	18	18	18
18	10,00	1,75	5,71	13,20	1,96	6,73	10,00	1,40	7,14
25	11,20	2,67	4,19	16,50	3,01	5,48	10,00	1,60	6,25
35	10,00	3,56	2,81	12,55	3,63	3,46	10,00	1,95	5,13
43	8,00	3,35	2,39	10,00	3,46	2,89	8,00	2,30	3,48

WH-MXC16G9E8									
Tamb	CC	IP	EER	CC	IP	EER	CC	IP	EER
LWC	7	7	7	14	14	14	18	18	18
18	8,50	1,70	5,00	—	—	—	10,00	1,70	5,88
25	14,00	4,00	3,50	—	—	—	14,00	2,94	4,76
35	12,20	4,76	2,56	—	—	—	12,20	3,50	3,49
43	7,10	3,31	2,15	—	—	—	9,80	3,31	2,96

Tamb: Ambient Temperature (°C). LWC: Leaving Water Condenser Temperature (°C). HC: Heating Capacity (kW). CC: Cooling Capacity (kW). IP: Power Input (kW)  
 This data is measured by Panasonic in accordance with EN14511-2 standard. This data is for reference purpose only, and does not guarantee the performance.

### Heating capacity table

Aquarea G Generation HT Mono-bloc Single Phase / Three Phase. Heating Only - MHF

**WH-MHF09G3E5**

Tamb	HC	IP	COP	HC	IP	COP	HC	IP	COP	HC	IP	COP	HC	IP	COP	HC	IP	COP
LWC	30	30	30	35	35	35	40	40	40	45	45	45	50	50	50	55	55	55
-15	9,00	3,46	2,60	9,00	3,71	2,43	9,00	4,01	2,24	8,80	4,26	2,07	8,50	4,71	1,80	7,80	5,38	1,45
-7	9,00	3,06	2,94	9,00	3,29	2,74	9,00	3,56	2,53	8,90	3,83	2,32	8,90	4,28	2,08	9,00	5,02	1,79
2	9,00	2,43	3,70	9,00	2,61	3,45	9,00	2,91	3,09	9,00	3,21	2,80	9,00	3,72	2,42	9,00	4,37	2,06
7	9,00	1,82	4,95	9,00	1,94	4,64	9,00	2,21	4,07	9,00	2,46	3,66	9,00	2,99	3,01	9,00	3,64	2,47
25	9,00	1,52	5,92	9,00	1,70	5,29	9,00	1,88	4,79	9,00	2,16	4,17	9,00	2,63	3,42	9,00	3,20	2,81

**WH-MHF12G6E5**

Tamb	HC	IP	COP	HC	IP	COP	HC	IP	COP	HC	IP	COP	HC	IP	COP	HC	IP	COP
LWC	30	30	30	35	35	35	40	40	40	45	45	45	50	50	50	55	55	55
-15	12,00	5,16	2,33	12,00	5,53	2,17	11,00	5,51	2,00	10,80	5,49	1,97	9,70	5,52	1,76	8,00	5,61	1,43
-7	12,00	4,43	2,71	12,00	4,76	2,52	11,50	4,91	2,34	11,20	5,06	2,21	10,10	5,06	2,00	9,60	5,43	1,77
2	12,00	3,42	3,51	12,00	3,68	3,26	11,50	3,86	2,98	11,30	4,14	2,73	10,80	4,66	2,32	10,30	5,13	2,01
7	12,00	2,52	4,76	12,00	2,69	4,46	12,00	3,06	3,92	12,00	3,44	3,49	12,00	4,10	2,93	12,00	4,97	2,41
25	12,00	2,03	5,91	12,00	2,36	5,08	12,00	2,69	4,46	12,00	3,02	3,97	12,00	3,61	3,32	12,00	4,37	2,75

Tamb: Ambient Temperature (°C). LWC: Leaving Water Condenser Temperature (°C). HC: Heating Capacity (kW). CC: Cooling Capacity (kW). IP: Power Input (kW)  
 This data is measured by Panasonic in accordance with EN14511-2 standard. This data is for reference purpose only, and does not guarantee the performance.

# DIMENSIONS

## All in One H Generation

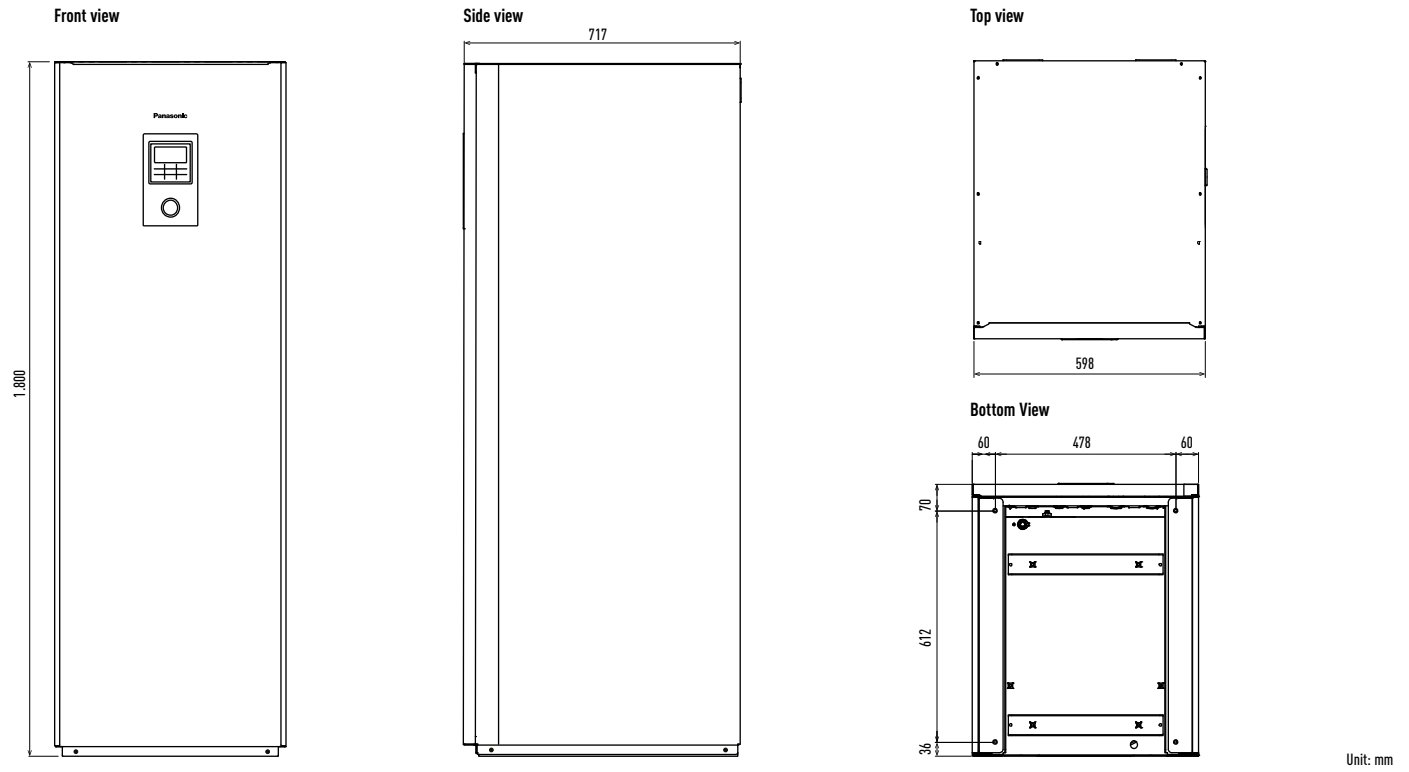

## All in One G Generation

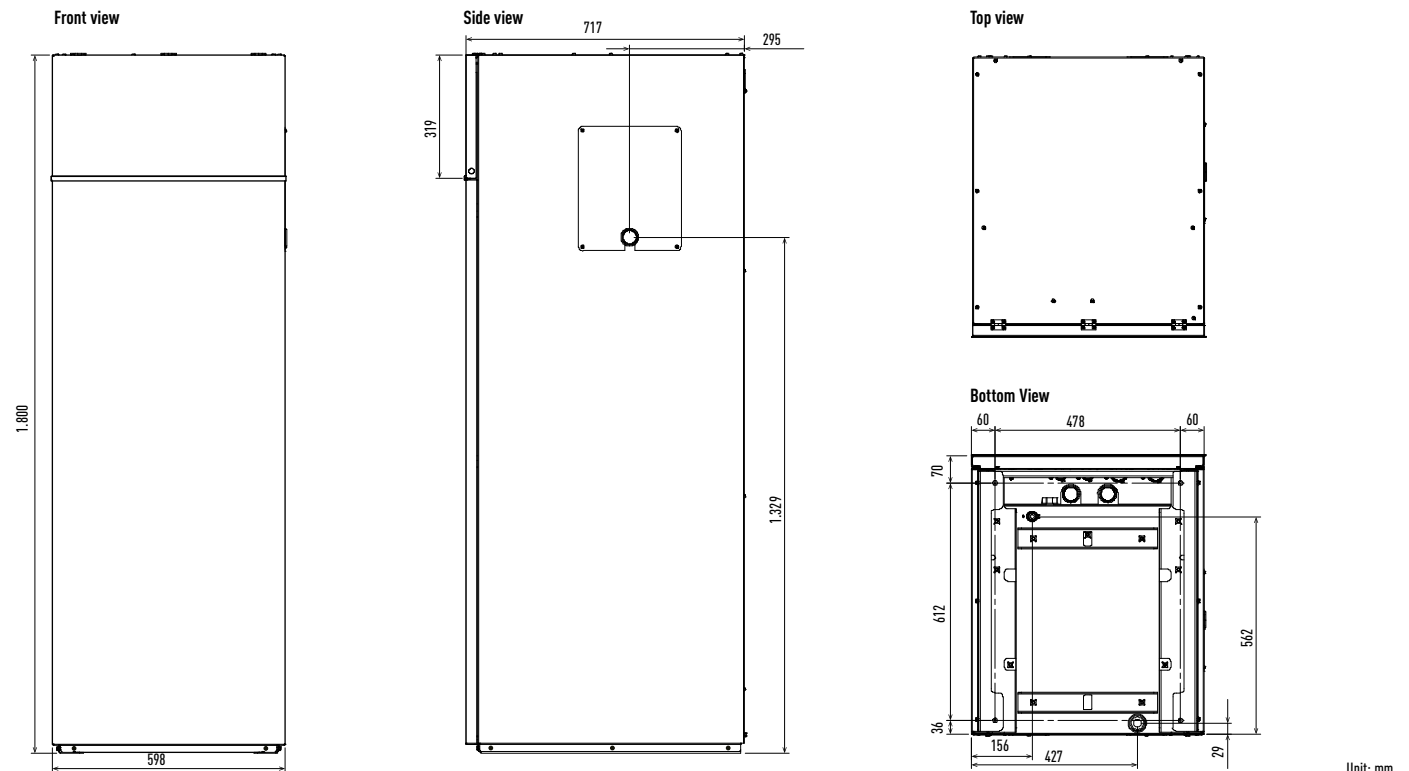





Bi-bloc outdoor unit 3 and 5kW

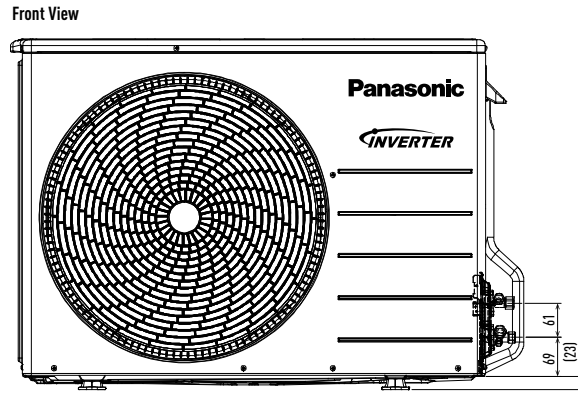
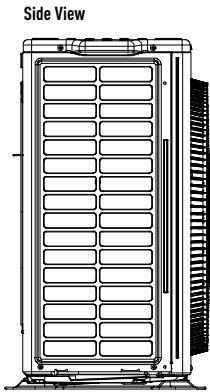
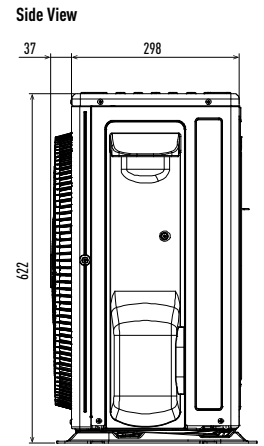
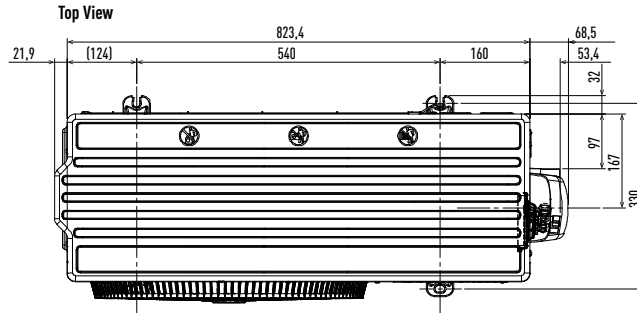
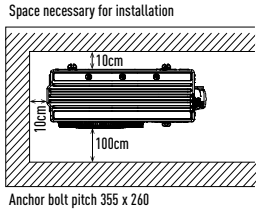

Unit: mm

Bi-bloc outdoor unit 7 and 9kW

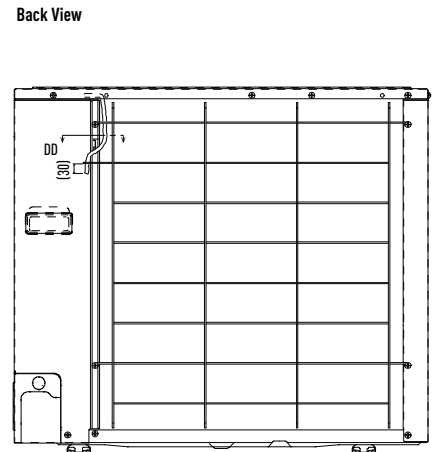
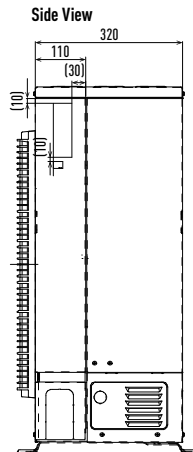
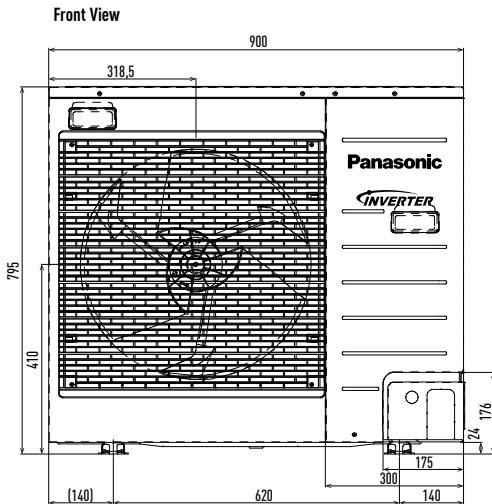
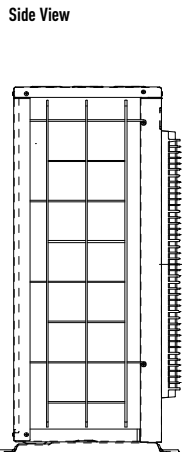
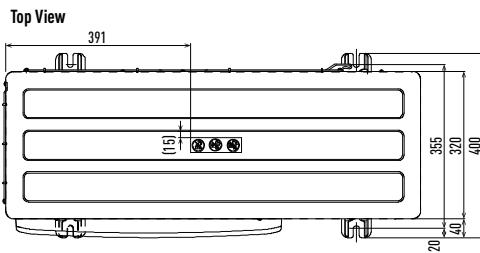

Unit: mm

Bi-bloc outdoor unit from 9 to 16kW

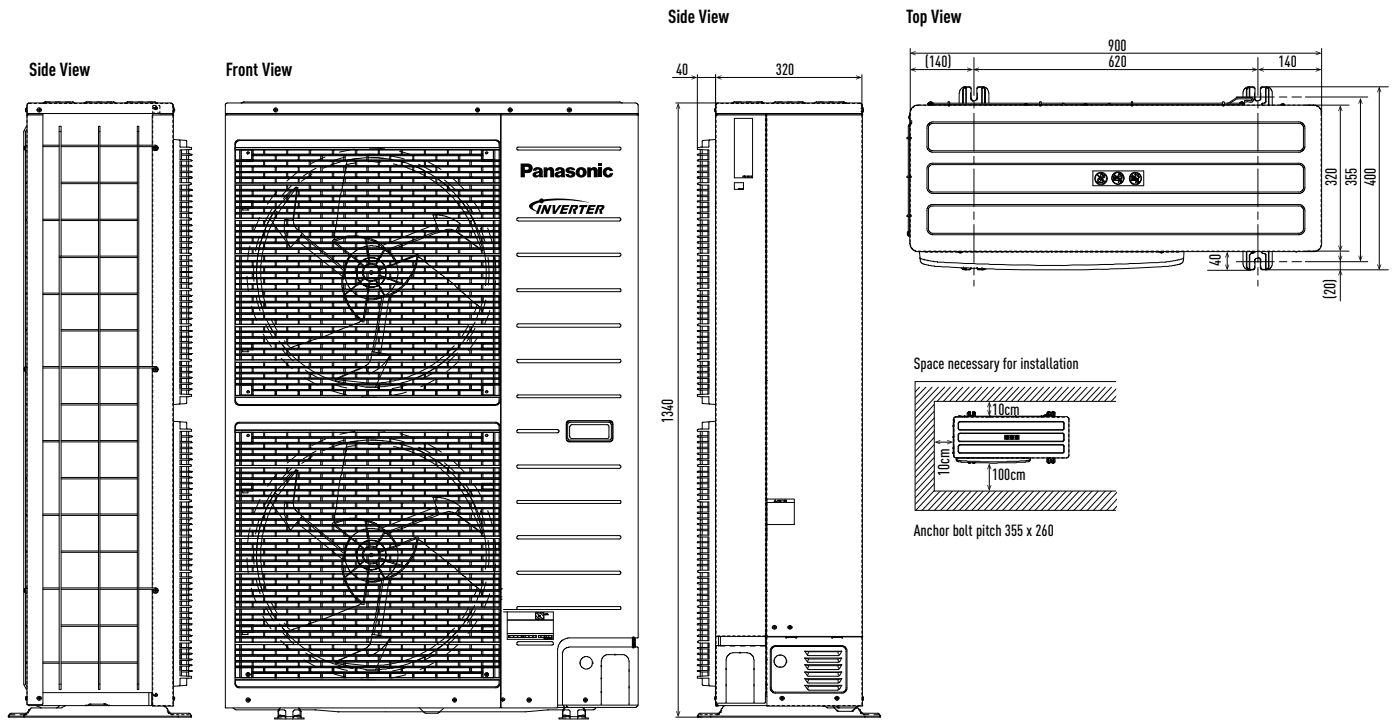

Unit: mm

Mono-bloc outdoor unit from 5 to 9kW

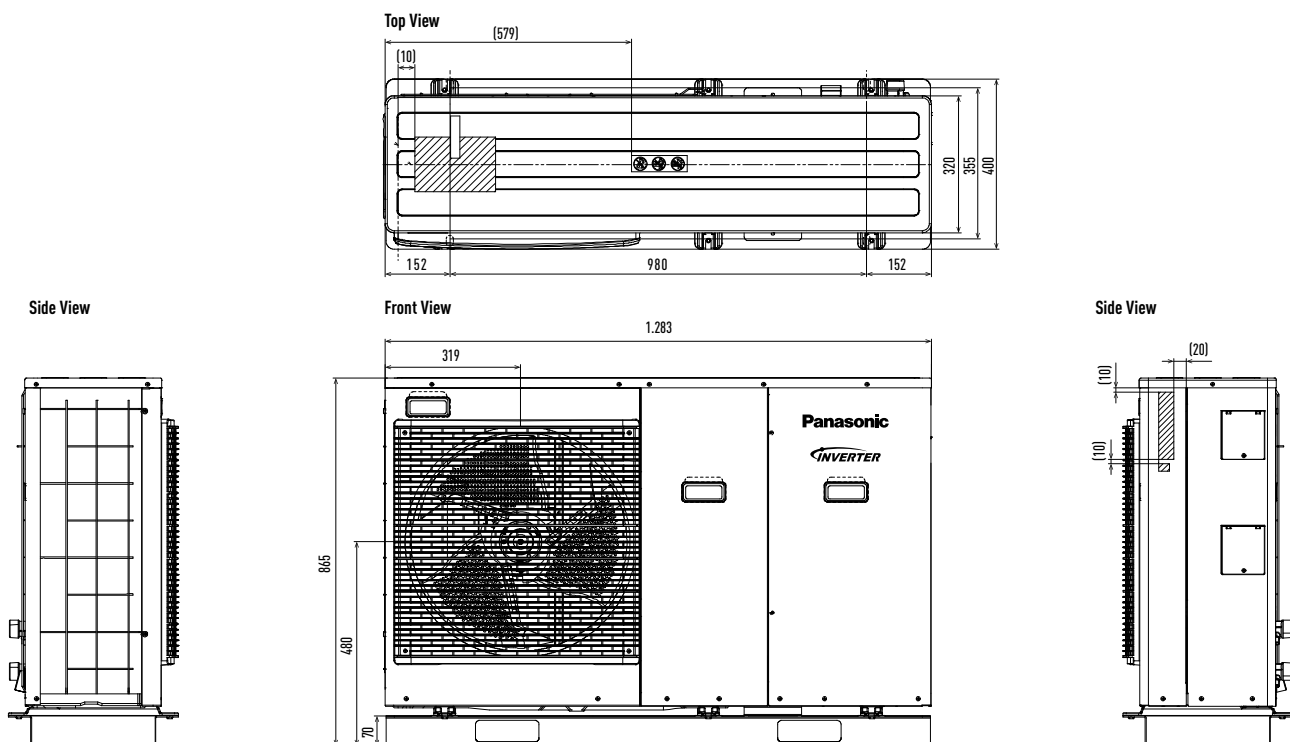

Unit: mm

Bi-bloc Super Quiet outdoor unit and Mono-bloc outdoor unit from 9 to 16kW

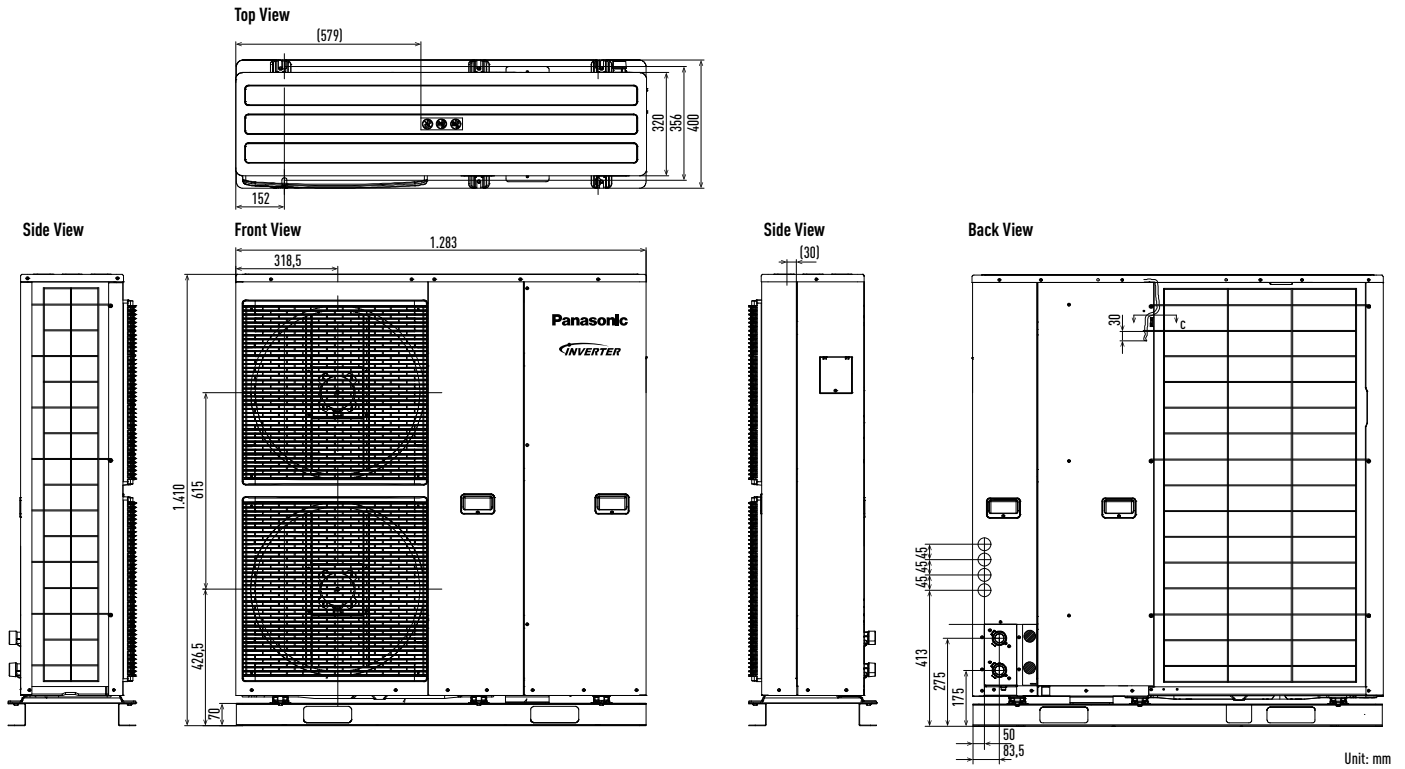

Aquarea DHW Floor standing

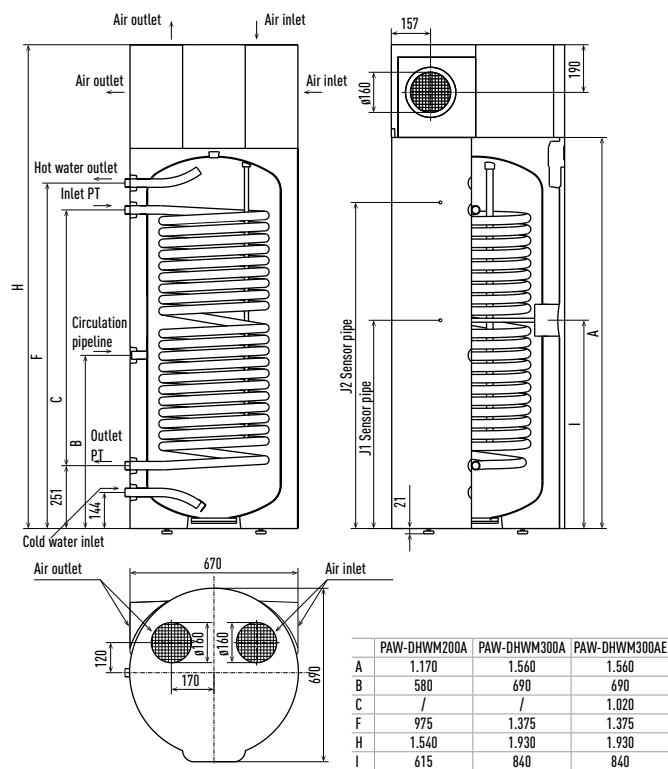

Aquarea DHW Wall mounted

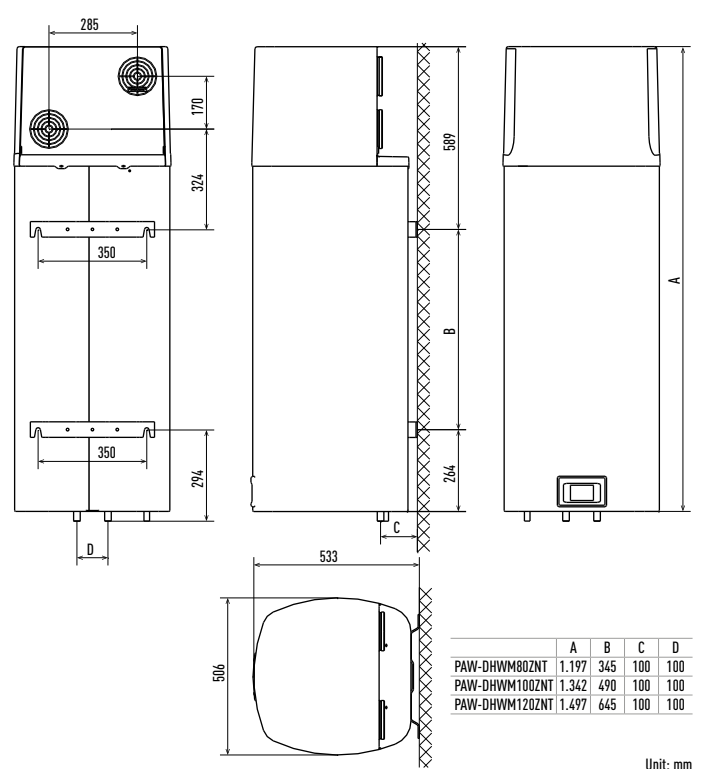





# WELCOME TO DOMESTIC RANGE

NEW DOMESTIC  
TECHNOLOGY

'17



Go green. Go clean. Go your way.

Panasonic Air Conditioners are designed to provide more than just comfort cooling to homes. They save energy. They purify your surroundings. They adjust cooling power to suit your living spaces and styles. Living an eco-lifestyle your way is now easier than ever.





# HIGHLIGHTED FEATURES





Panasonic has developed a range of products designed for you, better than ever before. With its innovative design, high efficiency and incomparable purification system, the Etherea range has been designed with your clients in mind.

**Panasonic air conditioners provide more savings and more comfort**

We believe that going green shouldn't compromise on comfort. That's why Panasonic is introducing the new Econavi system; combining human sensor and control program technology to detect and reduce energy waste by 38% . Our super silent air conditioners guarantee the purest air to take care of

you and your family. And, for a cleaner living environment, the new nanoe™ helps purify the air as well as your surroundings. Together, these breakthrough technologies define what Panasonic's Eco Clean Life Innovation is all about – innovations that improve our environment while making life as comfortable as possible.

**Energy saving**



Intelligent Human Activity Sensor and new Sunlight Sensor technologies that can detect and reduce waste by optimising air conditioner according to room conditions. With just one touch of a button, you can save energy.



Exceptional Seasonal Cooling Efficiency based on the new ErP regulation. Higher SEER ratings mean greater efficiency. Save all the year while cooling!



Exceptional Seasonal Heating Efficiency based on the new ErP regulation. Higher SCOP ratings mean greater efficiency. Save all the year while heating!



The A Inverter system provides energy savings of up to 50%. Both you and nature wins!

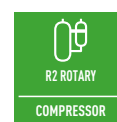

Panasonic R2 Rotary Compressor. Designed to withstand extreme conditions, it delivers high performance and efficiency.



Our heat pumps containing the new refrigerant R32 show a drastic reduction in the value of Global Warming Potential (GWP). An important step to reduce greenhouse gases. R32 is also a components refrigerant, making it easy to recycle.

**High performance and healthy air**

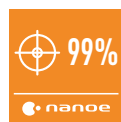

New nanoe™ utilises nano-technology fine particles to purify the air in the room. It works effectively on airborne and adhesive micro-organisms such as bacteria, viruses and mould. Seal of Approval of the British Allergy Foundation.



Particulate matter (PM2.5) can be found suspended in the air, including dust, dirt, smoke and liquid droplets. Sized at 2,5µm, these particles are said to pose health problems as they can easily enter our lungs.



With Super Quiet technology our devices are much more quiet than a library (30dB(A)).



The Perfect Humidity Air controls the humidity level in the air to prevent over-dryness.



More comfort with Aerowings. Direct airflow to ceiling to create shower cooling effect by twin flap built in indoor.



Down to -10°C in cooling only mode. The air conditioner works in cooling only mode with an outdoor temperature of -10°C.



Down to -15°C in heating mode. The air conditioner works in heat pump mode with an outdoor temperature as low as -15°C.



Summer House, this innovative function keeps the house at 7/8°C to avoid freezing pipes during the winter. This function is highly appreciated in summer house or week end houses.



The Panasonic renewal system allows good quality existing R22 pipe work to be re-used whilst installing new high efficiency R410A systems.



The Panasonic renewal system allows good quality existing R410A or R22 pipe work to be re-used whilst installing new high efficiency R32 systems.



5 Years Warranty. We guarantee the outdoor unit compressors in the entire range for five years.

**High connectivity**



New Domestic integration to P-Line - CZ-CAPRA1. Can connect all ranges to P-Line. Full control is now possible.



Internet Control is a next generation system providing a user-friendly remote controller of air conditioning or heat pump units from everywhere, using a simple Android or iOS smartphone, tablet or PC via internet.



The communication port is integrated into the indoor unit and provides easy connection to, and control of, your Panasonic heat pump to your home or building management system.

# NEW R32 REFRIGERANT GAS



### A 'small' change that changes everything

Not everyone is ready for change. Indeed, there are some who resist the future.

But at Panasonic we will keep believing in technologies that improve people's lives.

Which is why we are now presenting a new generation of air conditioners with R32, an innovative refrigerant in all ways imaginable: it is easy to install, environmentally friendly and saves energy.

The result? Greater wellbeing for people and for the planet. Because there will always be people who resist change. But we say: Goodbye yesterday. Hello R32.

### Today Panasonic. Tomorrow everyone.

European regulation CE 517/2014 makes the replacement of fluorinated gases (F-gases) compulsory, such as R410A, for environmental reasons, although it also grants a transition period from 2017 to 2030.

Must we wait? No. Our commitment to innovation is not hampered by dates.

Which is why we are jumping the gun and are now presenting our new generation of air conditioners that employ the R32 refrigerant.

#### HCFC phase-down schedule.

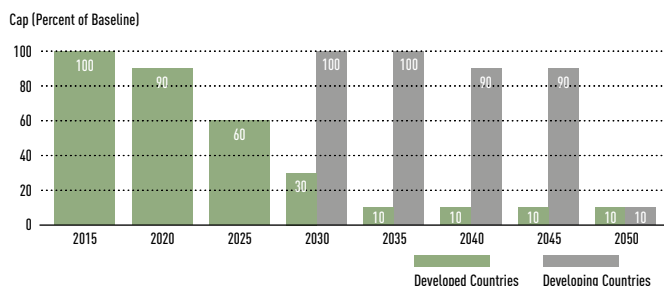

\* By replacing R22 with R32 we are significantly reducing the ozone depletion potential of our air conditioners. The use of air conditioning is rapidly increasing in developing countries thus making it increasingly necessary to use refrigerants with low global warming potential.

### Goodbye yesterday

The new generation of air conditioners with R32 represents innovation in every way.

Shall we list them?

#### 1. Installation innovation.

- Extremely easy to install, practically the same as for the R410A. (Just remember to verify that the pressure gauge and vacuum pump are compatible with the R32)
- This refrigerant is 100% pure, which makes it easier to recycle and reuse

#### 2. Environmental innovation.

- Zero impact on the ozone layer
- 75% less impact on global warming

	R410A	R32
Composition	Blend of 50% R32 + 50% R125	Pure R32. (No blend)
GWP (Global Warming Potential)	2.087,5	675
ODP (Ozone Depletion Potential)	0	0

R32 is a refrigerant with just one-third the global warming potential of R410A, meaning less risk of damage to the environment.

#### 3. Economic and energy consumption innovation.

- Lower cost and greater savings:
  - 30% less refrigerant
- Higher energy efficiency A+++ than R410A
- R32 consumes less energy when there are extreme temperatures outside

LCCP: Life Cycle Climate Performance (lower global warming impact). Safety: Low toxicity level.

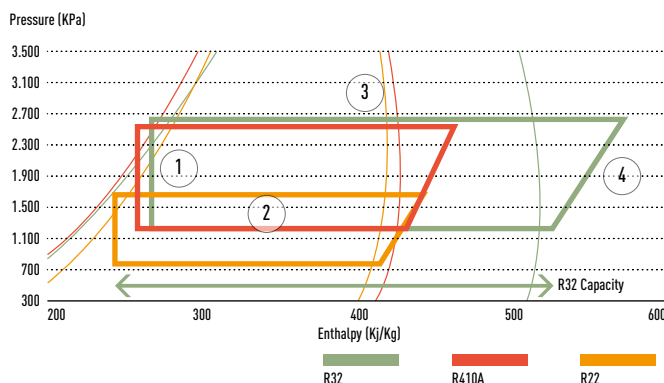

1. Expansion. 2. Evaporation. 3. Condensation. 4. Compression.

#### 100 Year global warming potential of different refrigerants.

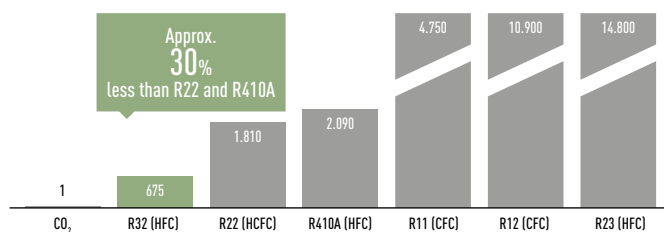

IPCC Fourth Assessment Report. Values for 100 years warming potential.

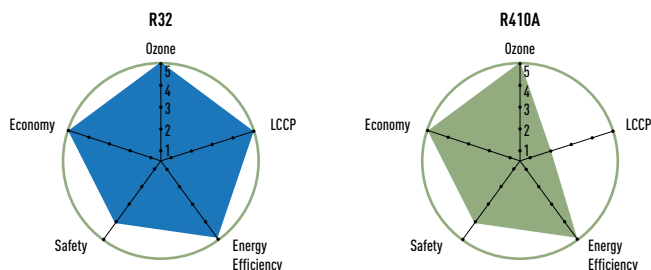

NEW ETHEREA.  
NEW TECHNOLOGY '17





New Etherea with Econavi intelligent sensor and new nanoe™ air-purifying system: outstanding efficiency A+++, comfort (Super Quiet technology only 19dB(A)) and healthy air combined with a breakthrough design.

**New Etherea 2017. Perfect outside, perfect inside**

**The new Etherea has an astonishingly slim design.**

A breakthrough design that combines perfectly with the most modern environments. We have selected the best materials and processes for a refined design. And now they're available in an elegant metallic or matt silver and matt or gloss white.



**Discover how to achieve energy savings with the new Etherea A+++.**

Econavi Sensor technology reduce waste by adjusting the operation of the air conditioner to suit the requirements of the room. With just one touch of a button, you can save energy efficiently with uninterrupted cooling, comfort and convenience.

**Get the best for your health with Etherea and nanoe™.**

Using nanoe™ with nano-technology, fine particles purify the air in the room. It works effectively on airborne and adhesive micro-organisms such as bacteria, viruses and mould thus ensuring a cleaner living environment.

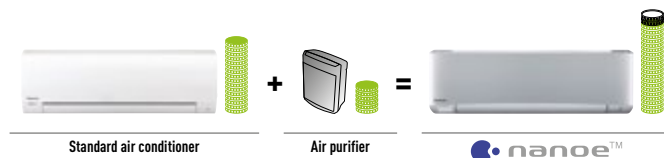

**New Etherea and Heatcharge performance: the very best SEER and SCOP available**

Etherea and Heatcharge. Economical, environment-friendly operation high SCOP (Seasonal Coefficient of Performance). Original Panasonic Inverter technology and a high performance compressor provide top-class operating efficiency. This lets you enjoy lower electricity bills while contributing to environmental protection.



**Maximum savings for your home**

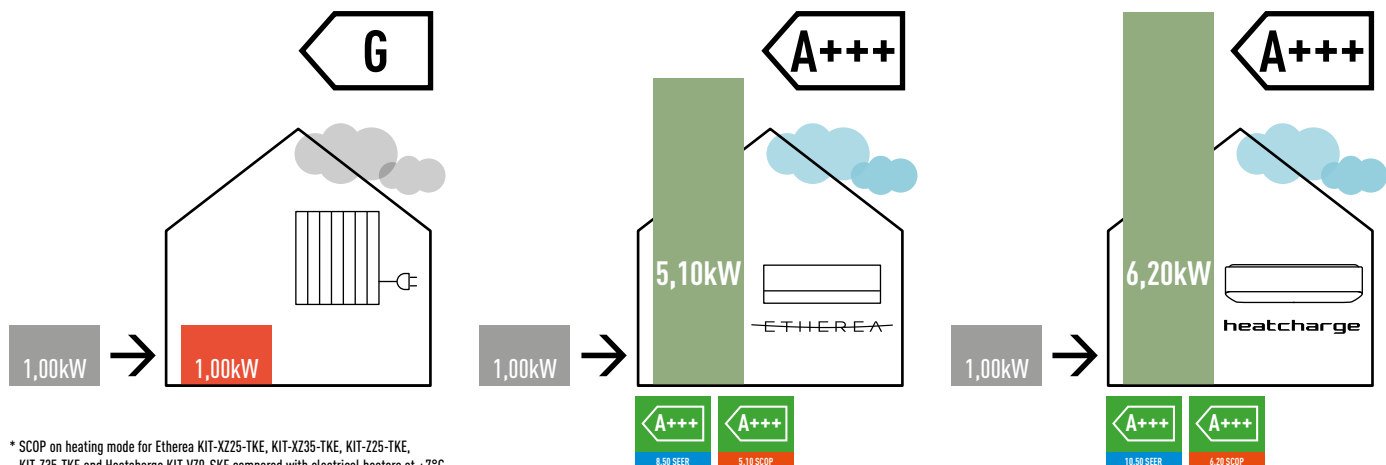

\* SCOP on heating mode for Etherea KIT-XZ25-TKE, KIT-XZ35-TKE, KIT-Z25-TKE, KIT-Z35-TKE and Heatcharge KIT-VZ9-SKE compared with electrical heaters at +7°C.

# NEW NANO-SIZED ELECTROSTATIC ATOMIZED WATER PARTICLES, NANO<sup>™</sup>, THAT IMPROVE AIR QUALITY



The world is focusing its attention on this breakthrough technology that could be the key to the air purification.

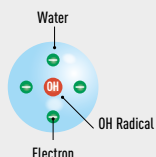
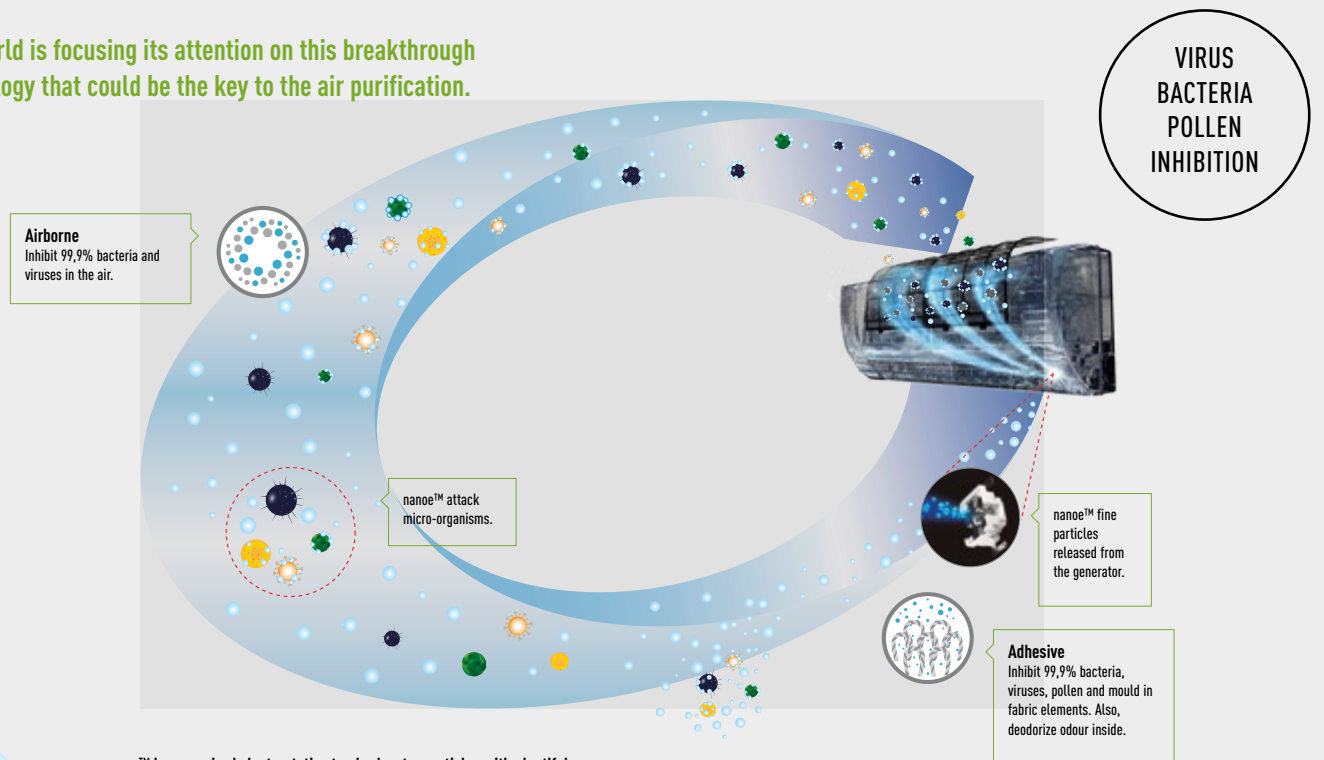

nanoe™ is nano-sized electrostatic atomized water particles with plentiful OH radicals. Its effectiveness of bacteria inhibition depends on the number of OH radical, which is generated at the rate of 480 billion per second.



Proven benefits of electrostatic atomized water particles, nanoe™, through experiments. The benefits range widely from inhibiting viruses and bacteria, inhibiting mould and allergens, moisturizing skin. Experiments by universities and research institutions have proven the effects of nanoe™.

### Characteristics of nanoe™ Technology

**1. Long Life.** 6 times longer lifespan than general negative ion. nanoe™ contains moisture around 1.000 times more than general negative ion. Being contained in water particles, it has a longer lifespan and is able to spread for a long distance.

#### Comparison of distribution in the room

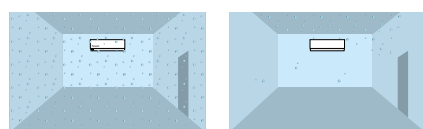

**nanoe™**  
nanoe™ spreads to every corner.

**General negative ion**  
Ions decay before spreading throughout the room.

**2. Water-originated.** nanoe™ comes from condensed moisture in the air so that water replenishment for nanoe™ generation is not required.

nanoe™ is tiny enough to penetrate into clothes for inhibiting mould and deodorizing

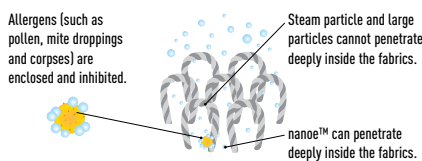

**3. Microscopic Scale.** Only one-billionth the size of a steam particle nanoe™ is much smaller than steam that can deeply penetrate into cloth fabrics to deodorize.

\* 1nm (nanometer) = one billionth of meter.

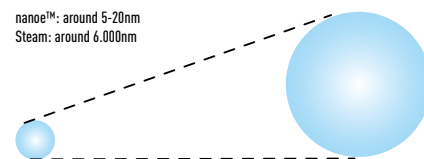

### How does nanoe™ technology help you?

**1. Virus / Bacteria / Pollen inhibition.** Inhibits virus. Influenza virus 99,9% inhibited.

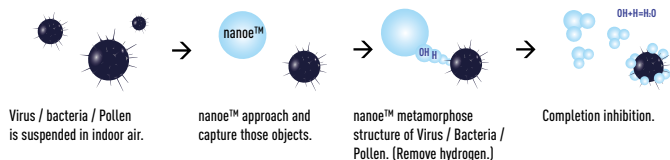

#### The effectiveness of nanoe™

Tested contents	Result (deactivate)	Testing condition		Tested laboratory / company	Report doc No.	
		Size	Time			
Airborne	Virus (Coliphage)	99,7%	10m <sup>2</sup>	6h	Kitasato research center for Environmental science	KRCES 24_0300_1
	Bacteria (Staphylococcus aureus)	99,7%	10m <sup>2</sup>	4h	Kitasato research center for Environmental science	KRCES 24_0301_1
Adhesive	Virus (Coliphage)	99,8%	10m <sup>2</sup>	8h	Japan food research laboratories	13001265005-01
	Virus (Influenza)	99,9%	1m <sup>2</sup>	2h	Kitasato research center for Environmental science	KRCES 21_0084_1
	Bacteria (Staphylococcus aureus)	99,1%	10m <sup>2</sup>	8h	Japan food research laboratories	13044083003-01
	Tobacco odour	Deodorized in 2h	10m <sup>2</sup>	2h	Panasonic analysis center	BAA33-130125-D01
	Cedar pollen	99%	45L	2h	Panasonic analysis center	ED2-080303IN-03

**2. Deodorization.** The smell adhered at curtain and sofa are deodorized. Reduce 90% Odour (tobacco smell) after 120 minutes.

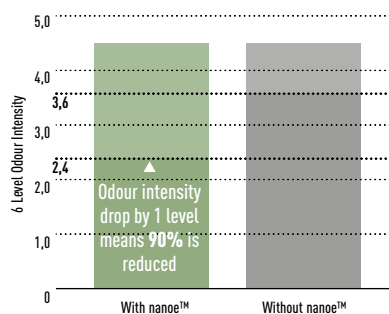

#### Deodorization Effect for Adhering Odour (Tobacco)

Odour intensity 1,2 level down.

The deodorization effect will vary subject to the surrounding environment (temperature / humidity), operation time, types of smell and clothes.

- Test Laboratory: Panasonic Corporation Analysis Center. - Test Methodology: Verifying with 6-level odour intensity indication in 10m<sup>2</sup> test room. - Deodorization Method: nanoe™ emit. - Test Subject: Adhering Tobacco Smell. - Test Result: 1,2 level of odour intensity is decreased after 120 minutes. - Report No.: BAA33-130125-D01.

**3. Moisturing Skin.** Helps retain the moisture of the skin.

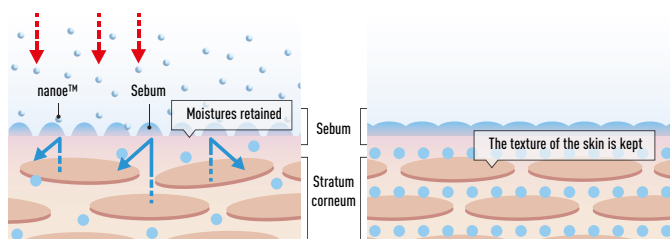

**With nanoe™**  
nanoe™ hydrate the sebum on the skin to prevent the loss of moistures.

**After 28 days**  
Skin is hydrated that nanoe™ keeps the texture of the skin.

Test Laboratory: FCG Research Institute Inc. Report no. 19104

### Reliable technology chosen by the world.

The cutting edge technology of Panasonic's nanoe™ purifying technology has been chosen by Lexus to equip its vehicles for clean indoor air.



ECONAVI INTELLIGENT SENSORS.  
DISCOVER HOW TO ACHIEVE ENERGY SAVINGS







Econavi detects and reduces this waste in all the right ways  
 Using high-tech sensors and precise control programs, it analyses room conditions and adjusts cooling power accordingly.  
 Econavi is smart enough to locate and operate in all the right places to give you more comfort and better energy savings.

**5 Features saving energy all at once: Econavi with intelligent eco sensors**

Intelligent Sensors detect potential waste of energy using the Human Activity Sensor and Sunlight Sensor. It is able to monitor human location, movements, absence and sunlight intensity. It then automatically adjusts cooling power to save energy efficiently with uninterrupted heating and cooling comfort and convenience.

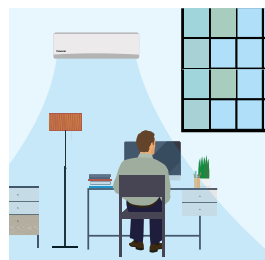

**Temperature Wave**  
 Rhythmic temperature-controlled pattern to save energy without sacrificing comfort.

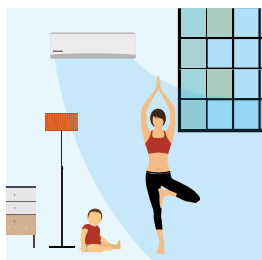

**Area Search**  
 Directs airflow to wherever you are in the room. Econavi detects changes in human movements and reduces the waste of cooling the unoccupied area of the room.

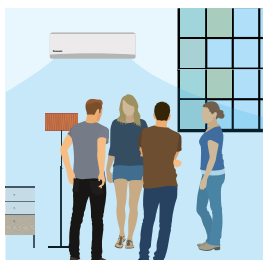

**Activity Detection**  
 Adapts cooling power to your daily activities. Econavi detects changes in activity levels and reduces the waste of cooling with unnecessary power.

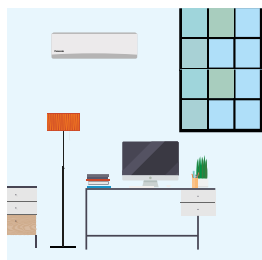

**Absence Detection**  
 Reduces cooling power when you are not around. Econavi detects human absence in the room and reduces the waste of cooling an empty room.



**Sunlight Detection**  
 Adjusts cooling power to changes in sunlight intensity.

**Econavi sunlight sensor**

**Sunlight Detection (on Cooling and Heating Mode).**

Econavi detects changes in sunlight intensity in the room and judges whether it is sunny or cloudy/night. It reduces waste energy by reducing cooling under less sunny conditions on the cooling mode or reducing heating operation under more sunnier conditions on the heating mode.

**Sunlight detection (on cooling mode)**

**Sunny**

Econavi is switched on when it is sunny.

**Detect**

Econavi detects less cooling power is required.

**Reduce waste**

Reduces cooling power by an amount equivalent to increasing the set temperature by 1°C.

**Sunlight detection (on heating mode)**

**Cloudy/Night**

Econavi is switched on when it is cloudy/night.

**Detect**

Econavi detects less heating power is required.

**Reduce waste**

Reduces heating power by an amount equivalent to decreasing the set temperature by 1°C.

**Temperature wave**

**Rhythmic temperature-controlled pattern to save energy without sacrificing comfort.**

Econavi with Temperature Wave was developed based on an understanding of Thermal Physiology; the human body adapts physiologically to changes in temperature. Taking advantage of this understanding, Panasonic's R&D Centre has developed the Rhythmic Temperature Control pattern, which offsets the air conditioner's performance against thermal physiological responses.

Hence, when Econavi detects human presence and low activity level, Temperature Wave adapts to this rhythmic temperature control to realise further energy savings without sacrificing comfort.

**How does temperature wave works?**

**When Econavi detects low activity**

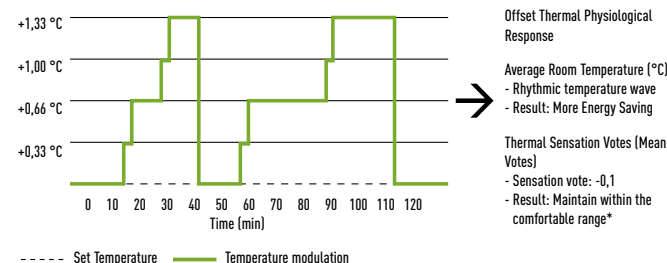

The result of the experiment showed that thermal sensation was maintained within the comfortable range\* even though average set temperature was moderately increased. Hence, when Econavi detects human presence and low activity level, Temperature Wave adapts to this rhythmic temperature control to realise further energy saving without sacrificing comfort.  
 \* The thermal condition of which PMV (Predicted Mean Value) is within -0,5 to +0,5 is recommended as comfortable condition (in the condition B) by International Standard EN ISO 7730.



So much saved with so little effort  
 Up to 38%\* energy savings for Inverter cooling model with temperature wave.

Econavi Intelligent Sensors

Econavi Intelligent Sensors are able to monitor sunlight intensity, human movements, activity levels and human absence to detect unconscious waste of energy and automatically adjusts cooling power to save energy efficiently whilst still providing uninterrupted cooling comfort and convenience.

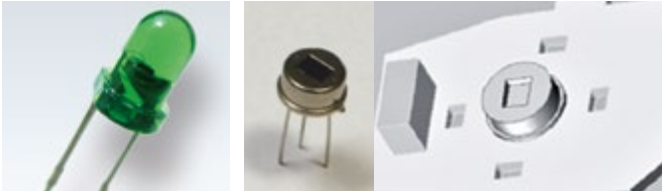

**Sunlight Sensor.**  
Detects changes in Sunlight Intensity

**Human Activity Sensor.**  
Detects human movements, changes in activity levels and human absence.

**Differentiating objects.**

Econavi's sensor technology uses factors such as speed, frequency and temperature of every object to determine if it is human.

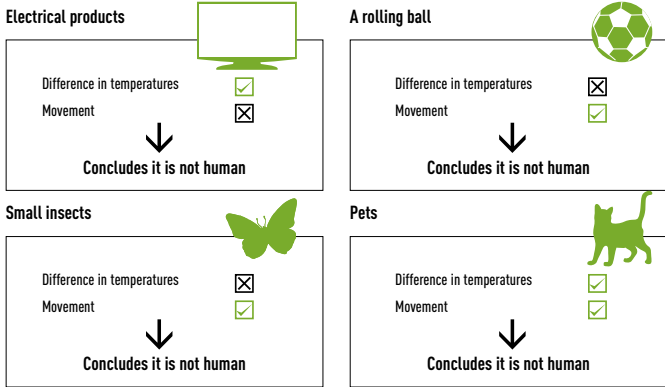

Both changes may be detected, but they are too small to have any effect on the sensor.

From the difference in temperatures and the nature of the object's movement, Econavi can determine if it's human\*.  
\* The sensor may deem pets as humans, unless it moves within the detection zone at speeds that are not humanly possible.

**Coverage capabilities.**

Human Activity Sensor covers a wider area due to its improved area detection function. The entire room is divided into 7 detection areas.

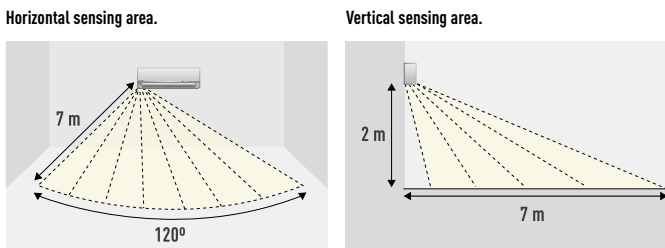

**High-precision sensing.**

All objects emit infrared rays which, although invisible, can be detected as heat by Econavi's Human Activity Sensor if it is within the detection zone. When an object moves within its detection zone, Econavi compares the object's temperature with the room temperature to determine if it is human, and level of activity based on its movement.

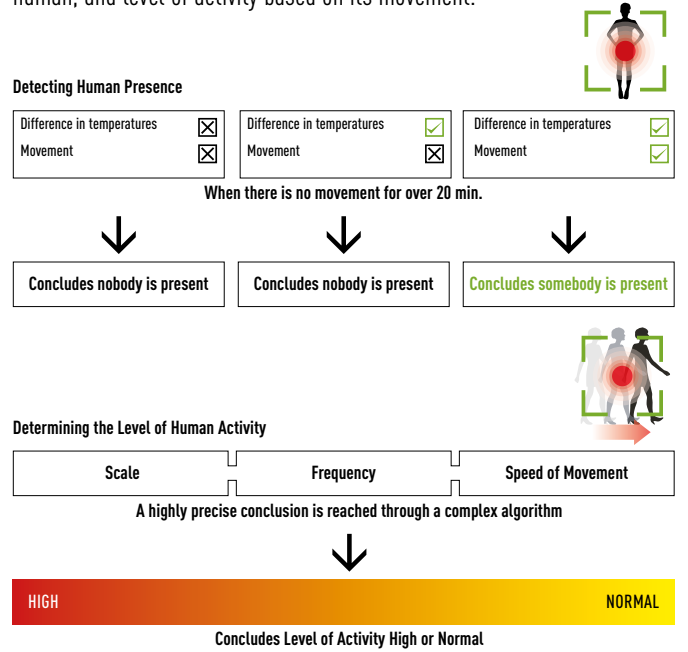

**Sensor detection principle.**

Human Activity Sensor detects human activity level and directs airflow to occupied or high activity zone.

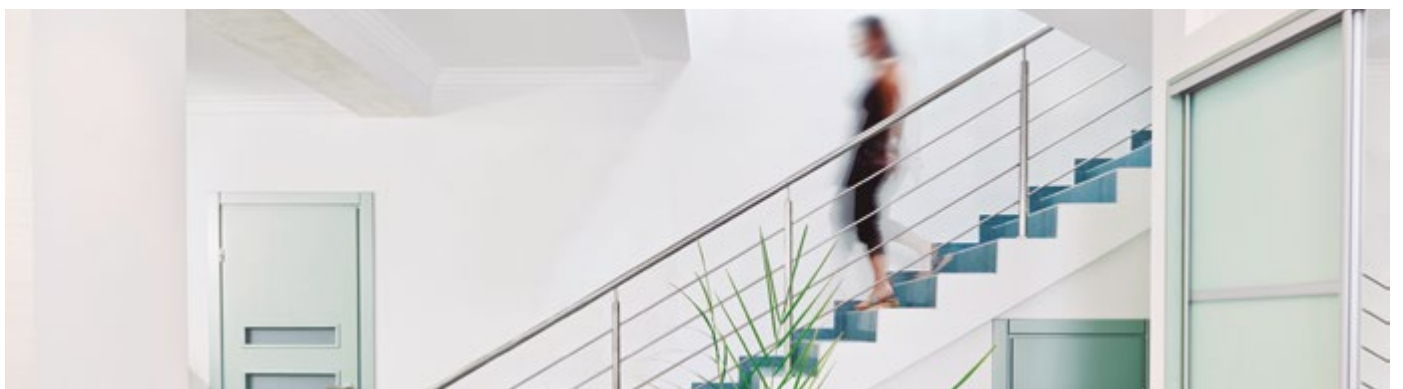
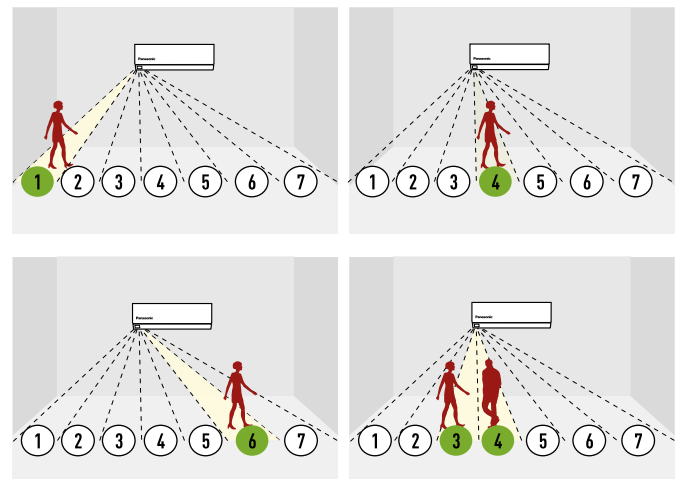

## Inverter technology

### The secret is flexibility.

Panasonic Inverter air conditioners have the flexibility to vary the rotation speed of the compressor. This allows it to use less energy to maintain the set temperature while also being able to cool the room quicker at start up.

So you can enjoy better savings on your electricity bills while maintaining cooling comfort.

The advantages of inverter heat pumps. Comparing Inverter and non-Inverter heat pumps.

#### NO INVERTER

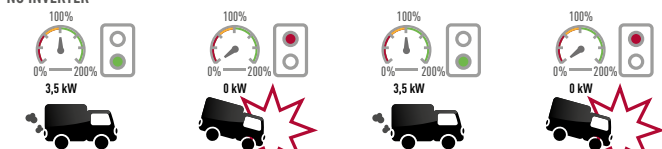

#### INVERTER

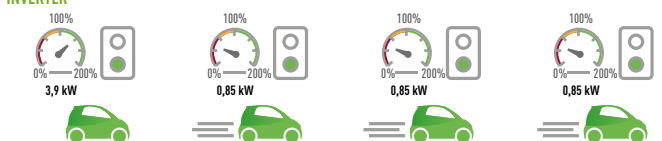

**NO INVERTER** Slow to start. Takes longer to reach the temperature set point. The temperature oscillates between the two extremes and never stabilises. The temperature falls and then rises quickly, leading to a consumption peak.

**INVERTER** Rapidly reaches the desired temperature. Adjusts the temperature: more comfort and greater savings. Keeps the temperature comfortable all the time.

### Exceptional energy-saving performance. Reduces electricity consumption.

Panasonic Inverter air conditioners are designed to give you exceptional energy savings and performance. At the start up of an air conditioner's operation, a boost in power is required to reach the set temperature. After the set temperature is reached, less power is required to maintain it. The Panasonic Inverter air conditioner varies the rotation speed of the compressor. This provides a highly precise method of maintaining the set temperature.

### Silent ambient and relaxing atmosphere 18 dB(A)

We have succeeded in making one of the most silent air conditioners on the market. Panasonic Inverter air conditioner's indoor operating noise has been reduced as the Inverter constantly varies its output power to enable more precise temperature control.

Quiet Mode reduces operation noise to a quiet 18dB(A)\* for a comfortable night's sleep.

Noise is 5dB(A) quieter than during regular operation.

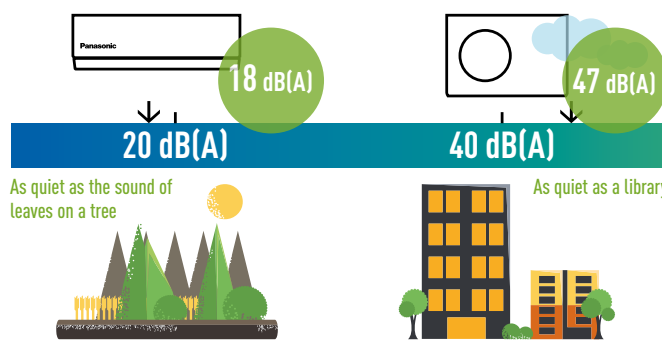

Heatcharge: In the Quiet Mode during cooling operation with low fan speed.

### Constant Comfort.

Precise temperature control with a wide power output range enables an inverter air conditioner to meet different room occupancy levels – thus ensuring constant comfort.

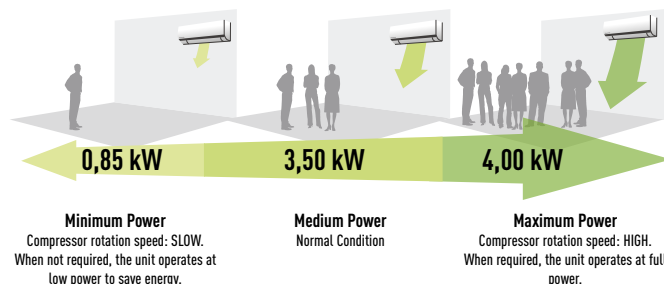

Graph shows the 1,5HP Inverter model's wide power output range during cooling./ Graph shows the 1,5HP Inverter model's wide power output range during cooling.

### Quick Comfort.

Panasonic Inverter air conditioners can operate with higher power during the start up period to cool the room 1,5 times faster and heat the room 4 times faster than non-Inverter models.

#### Comparison of Cooling Speed

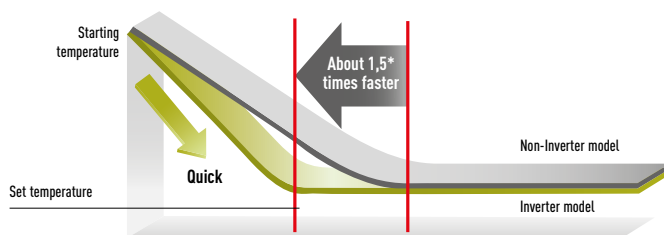

\* 1,5HP Inverter vs. non-Inverter. Outside room temperature: 35 °C; setting temperature: 25 °C

#### Comparison of Heating Speed

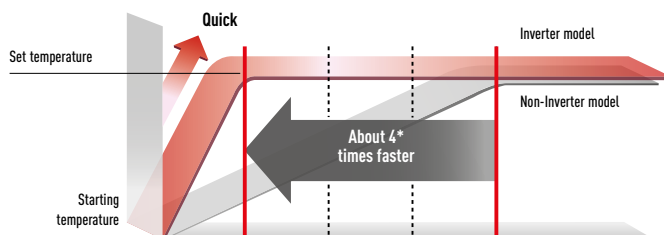

\* Comparison of 1.0HP Inverter and Non-Inverter. Outside room temperature: 2 °C ; Setting temperature: 25 °C

### Mild Dry Cooling

Mild dry cooling maintains a higher level of relative humidity of up to 10% compared to regular cooling operation. This helps to reduce skin dryness - and a dry throat.

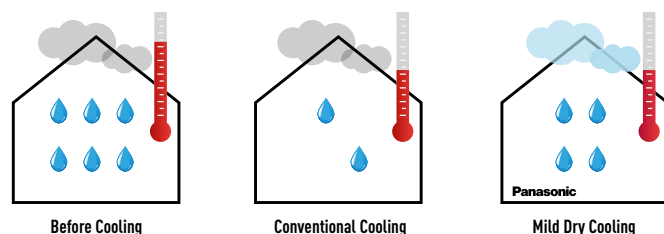

Lowers room temperature while maintaining high humidity.

# NEW WALL MOUNTED TZ/TE COMPACT STYLE

NEW DOMESTIC  
TECHNOLOGY

'17





TZ/TE compact indoor size.

The new TZ/TE indoor units have a new size. With 799mm of width, you can put the air conditioner on the top of the door.

### New TZ Inverter models powerful and efficient

#### Heating power and efficiency.

- **NEW!** New design
- R32 gas environmental friendly
- Complete line-up of standard Inverter models
- Super Quiet! Only 20dB(A)
- High energy savings
- Long connection distance (from 15m up to 30m)
- Wired Controller (optional)



### New PM2,5 Filter



Panasonic new PM2,5 purifying filter catch virus & allergen, even micro size ones, to remove from the air and create clean & comfort indoor quality.

#### What's PM2,5 and how harmful.

PM2,5 is an air pollutant that can drastically affect people's health. The size of the suspended particulate is thirty times smaller than the width of human hair, essentially making it difficult to see with the naked eye. It causes dangerous breathing problems such as acute bronchitis and lung cancer in older people and young children.



### Aerowings

Panasonic's new Aerowings feature incorporates two independent blades that concentrate airflow to cool you down in the shortest time possible. This also helps distribute cool air evenly throughout the room.

#### Superior airflow control. Indirect airflow after reaching set temperature.

New Aerowings features two independent blades that give you more control over the direction of the airflow. Without Aerowings, with direct airflow, the target never changes, so you can easily begin to feel too cold as you are subjected to the continuous icy blast.

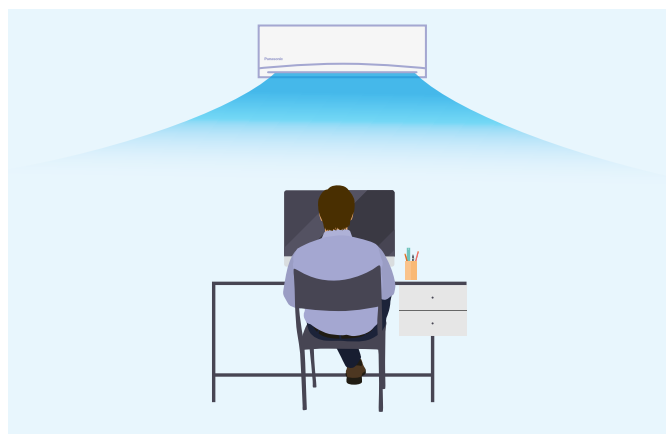

#### Comfort that goes on and on with Shower Cooling.

After reaching a set temperature, the Aerowings twin blades direct air towards the ceiling to create the Shower Cooling effect. Then, the Human Activity Sensor detects the level of activity and adjusts the temperature to keep you comfortable.

### Panasonic Air Conditioners with Aerowings feature an indoor design with wider intake grille and super-high fan speed to produce bigger air volume.

#### For Shower Cooling.

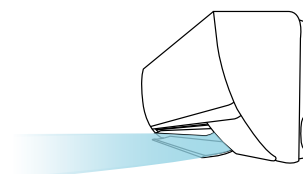

Before you feel too cold and uncomfortable, Aerowings shifts the airflow upwards to spread cool air over a wider area. This ensures cool air is evenly distributed throughout the room and you can stay comfortable without experiencing continuous direct cooling.

#### Bigger intake.

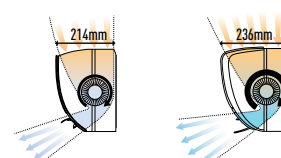

Panasonic Air Conditioners feature a new intake grille which is 22mm wider and improved indoor fan speed that goes up to a super-high fan speed at start up. The new chassis design generates bigger air volume that contributes to faster cooling.

# HEATCHARGE. ENERGY CHARGE SYSTEM



**Heating power and efficiency**

- Energy Charge System. Heat storage unit which features Non-Stop heating and fast heating function
- Maximum efficiency and comfort with Econavi sunlight detection and human activity detection
- nanoe™ air purifying system
- More powerful airflow to quickly reach the desired temperature

**Panasonic's new full line-up of A+++ heat pumps.**

In response to the Kyoto Protocol, the European Union set some challenging targets for the reduction in greenhouse-gas emissions. By the year 2020, across the member states, the EU wants to have achieved the following objectives:

- A 20% cut in greenhouse gas emissions (from 1990 base levels)
- The share of renewables in the energy mix to increase by 20%
- An overall reduction of 20% in energy consumption

**Powerful, reliable heating even at low ambient winter temperatures**

When the air conditioner is operating, the compressor, which is the power source of the unit, generates heat. Until now, this heat was released into the atmosphere. Panasonic focused on this waste heat! Heatcharge is a unique, innovative Panasonic technology that stores this waste heat in the compressor and effectively uses it as heating energy. This lets you enjoy a new level of air conditioner heating power and efficiency.

**Constant heating.**

Using stored heat provides stable heating with less drop in temperature. Even when heating operation stops during defrost operation, stored heat continues to constantly warm the room. This eliminates the previous discomfort due to the temperature dropping when heating temporarily stops to ensure stable air conditioner heating.

**Conventional. The room gradually becomes cold.**

Defrost operation: About 11 to 15 min. Fall in room temperature: About 5 to 6 °C

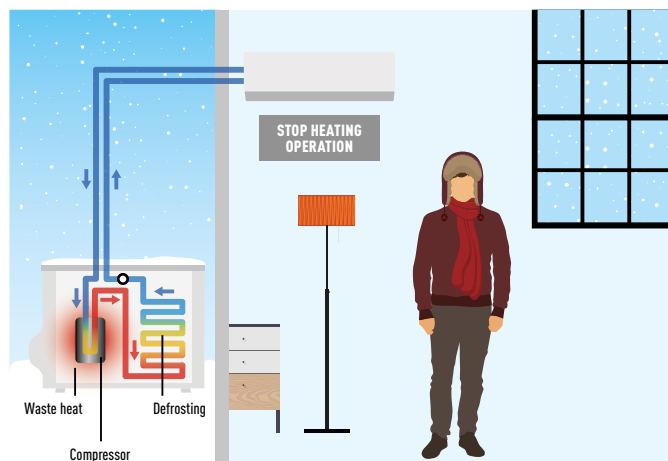

**Heatcharge. The room is thoroughly warmed.**

Defrost operation: About 5 to 6 min. Fall in room temperature: About 1 to 2 °C

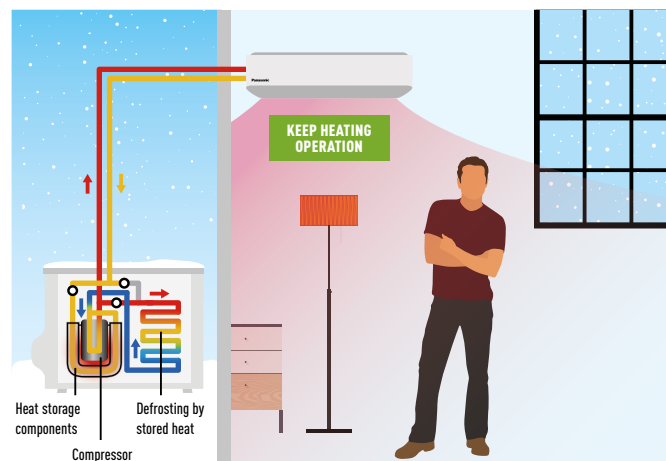

\* Defrost operation time and how low room temperature falls differ depending on the environment in which the unit is being used (how insulated and airtight and room is), operation conditions, and temperature conditions.  
 \* Output air temperature falls during defrost operation. How low room temperature falls differs depending on the environment in which the unit is being used (how insulated and airtight and room is), operation conditions, and temperature conditions.  
 \* In environments where a lot of frost accumulates, heating may stop during defrost operation.

**Conventional.**  
 During operation, heat is generated inside the compressor.

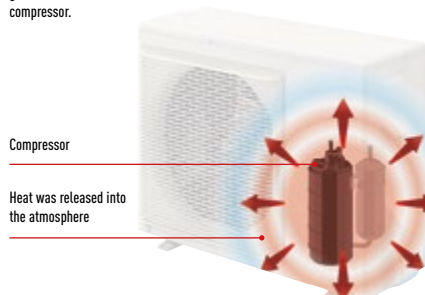

**Heatcharge.**  
 Heat generated by the compressor is stored inside and used to warm the refrigerant to efficiently increase heating power.

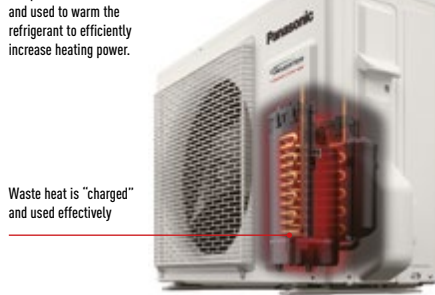

**Heatcharge.**  
 The compressor is wrapped and exhaust heat is used for charging.

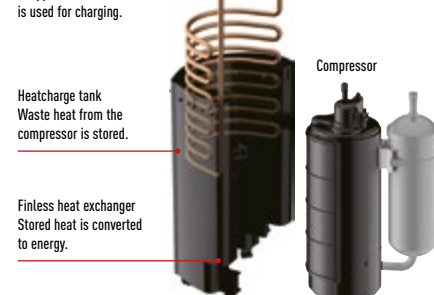

Heatcharge tank  
 Waste heat from the compressor is stored.

Finless heat exchanger  
 Stored heat is converted to energy.

# PANASONIC R2 ROTARY COMPRESSOR





R2 rotary compressors utilize rolling piston technology. The R2 compressor has been tested in extreme conditions: higher efficiency, single and dual piston, R32 / R410A refrigerant, compact size.

### Making the world a cooler place since 1978

Panasonic Rotary Compressors for Room Air Conditioners have been installed in the most demanding environments around the world. Designed to withstand extreme conditions, Panasonic Rotary delivers high performance, efficiency and reliable service, no matter where you are. Panasonic, the world's largest manufacturer of rotary compressors.

### R2 Compressor Value

#### About R2 Compressor.

Built upon 36 years of compressor design and production experience, R2 is the next generation of Rotary Compressors for residential central air conditioning. New technology improvements, enhanced materials and simple design ensure R2 compressors are reliable, efficient and quiet. The R2 Compressor delivers quality, comfort and peace of mind in homes around the world.

Panasonic's Rotary Compressors have been life tested in some of the world's most demanding environments. Proven for years many of the most demanding areas of the world, the R2 design is the compressor of choice by contractors and homeowners in these challenging climates. For the high performance that homeowners demand, R2 Rotary Compressors are the best air conditioning engines for today's residential cooling solutions.

#### Leading Technology.

Used in over 80% of cooling solutions globally, rotary is the world's dominant

### Why is the Panasonic R2 Rotary Compressor so efficient?

1. High Efficiency Motor The premium silicon steel motor meets industry efficiency requirements.
2. Improved Lubrication of High Volume Oil Pump The extended, high volume oil pump in conjunction with a larger capacity oil reservoir provides superior lubrication.
3. Accumulator has Larger Refrigerant Capacity The larger accumulator accommodates generous refrigerant amounts needed in longer line length installations.

residential air conditioning compression technology. Panasonic is the leading rotary and residential AC compressor manufacturer in the world, with over 200 million compressors produced.

#### Benefits.

Central air conditioning delivered with a Panasonic R2 Rotary Compressor ensures a superior level of comfort at an economical cost.



**Vane - Long Life.**

The special Physical Vapor Deposition (PVD) coating applied to the Vane greatly enhances the durability and life of the compressor mechanism.



**Piston - Durable.**

The piston is made of unique high-grade steel that prevents wear and extends operation life.

### FAQ

#### How does a Panasonic Rotary compressor work?

R2 compressors are rolling piston rotary compressors. The heart of the rotary compressor is the cylinder which houses the piston and the vane. The vane maintains constant contact with the piston as the piston rolls along the inside wall of the cylinder. As the piston rotates, gas is compressed into an increasingly smaller area until the discharge pressure is reached, releasing gas into the shell chamber. At the same time, more gas comes in through the suction port, enabling a continuous process of suction and discharge.

The simple design and symmetry of the cylinder components, combined with a special coating and premium materials, provide a highly durable and reliable product, rotation after rotation.

#### What SEER range does the Panasonic Rotary compressor support?

R2 compressors are found in air conditioning products featuring the very latest technology and offering the highest efficiency on the market today. Our R2 compressors are engineered specifically for this SEER efficiency requirement. Combined with the inherently simple design of the rotary, this results in a high desirable and impressively economical solution.

#### What makes Panasonic Rotary compressor so reliable?

Changes to the construction and material of internal components enables the

R2 compressor to reliably operate with an above average maximum discharge pressure. A Physical Vapor Deposition (PVD) coating on the vane, along with enhanced steel materials, significantly reduces wear and increases durability.

#### What makes a Panasonic Rotary compressor so quiet?

The structure of the R2 compressor mechanism has been redesigned to increase stability and reduce vibration. Specifically, the compressor has an upper cylinder discharge, an enhanced fixed upper bearing, and reduced friction in the cylinder parts. The lower discharge and muffler in the dual piston compressors also enables lower noise levels. As a result, this new design optimises efficiency and minimises noise.

#### How do R2 rotary compressors compare to scroll and reciprocating compressors?

R2 rotary compressors are very similar to some scroll compressors in overall performance, including efficiency and reliability. The simple and symmetrical key components contribute to the R2 compressor's reliability, light weight, compact size, and economical applied cost, without sacrificing the key performance requirements of high efficiency and low noise levels.

#### Which refrigerants can be used with Panasonic Rotary compressor?

Panasonic has R2 Rotary Compressors available for R32 and R410A applications.

# R22 RENEWAL. PANASONIC STANDARD UNITS CAN BE INSTALL ON EXISTING R22 PIPINGS



Change you old air conditioning system to a  
more efficient system!



## An important drive to further reduce the potential damage to our ozone

- All Panasonic standard NKE, PKE, QKE, RKE and SKE units can be install on existing R22 pipings
- No need of additional accessories (only pipe reduces)
- Approximately 30% energy saving compare to R22 units

### Panasonic are doing our part

We at Panasonic are also doing our part – recognising that all finances are under pressure at the moment. Panasonic has developed a clean and cost effective solution to enable this latest legislation to be introduced with as minimum an effect on businesses and cash reserves as possible.

The Panasonic renewal system allows good quality existing R22 pipe work to be re-used whilst installing new high efficiency R410A systems.

By bringing a simple solution to the problem Panasonic can renew all Split Systems and PACi systems; and depending upon certain restrictions we don't even limit the manufacturer's equipment we are replacing.

By installing a new high efficiency Panasonic R410A system you can benefit from around 30% running cost saving compared to the R22 system.

Yes...

1. Check the capacity of the system you wish to replace
  2. Select from the Panasonic range the best system to replace it with
  3. Follow the procedure detailed in the brochure and technical data
- Simple...

R22 - The reduction of Chlorine critical for a cleaner future.



### Guidance on re-using of existing R22 piping for a new R410A installation

#### 1. Precaution.

The existing R22 piping can be re-used for a R410A system installation if the following conditions are met and the piping are finally verified to be:

- Dry (no moisture remained in the piping)
- Clean (no dust remained in the piping)
- Tight (no refrigerant leak at the joining and piping)

#### 2. Conditions.

- Recover the refrigerant and oil.

Operate "force cooling" according to the recommended operation time, regardless of the piping length.

Single split: 10min.

Multi split: 30min.

After that, carry out "pump down" to recover the refrigerant and oil from the existing R22 system

\* Note: If pump down operation is not possible due to the malfunction of the system, flush and wash the existing piping to collect back the oil and dirt inside the system.

- Check the oil condition.

If the oil contains dirt, wash the existing pipes

- Check the oil color.

After pump down, use a cotton bud to wipe the oil from the existing pipe.

If the oil color is higher than ASTM3, use a new pipe as re-use of old piping is not allowed

Deterioration Criteria for Refrigerant Oil

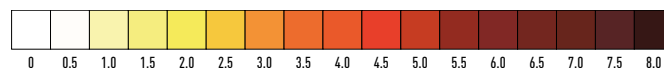

- Check pipe thickness.

Make sure that the pipe thickness is more than 0,8mm.

If the thickness is less than 0,8mm, use a new pipe

- Rework the flare for R410A connection.

Do not reuse the old flare nuts.

Make sure to use the new flare nuts attached to the R410A system

\* Note: If the existing piping size is 1/4" (6,35mm) and 1/2" (12,7mm), and the new R410A system is 1/4" (6,35mm) and 3/8" (9,52mm), use a pipe reducer connected at indoor and outdoor unit.

#### 3. Applicable Model.

Panasonic single split room air conditioner from CS/CU-RE/UE/YE/XE/CE/NE/E\*NKE and PKE series onwards.

Panasonic multi split room air conditioner from CU-2E/3E/4E/5PBE series onwards.

# CONTROL & CONNECTIVITY



## New Domestic integration to P-Line - CZ-CAPRA1

Can connect all ranges to P-Line. Full control is now possible.

### Integrates any unit in big system control.

- PKEA Server room integration
- Small offices with Domestic indoors
- Tender for refurbishment (old system Domestic and VRF in one installation)

**Centralized Control Systems: 64 Indoor Units**

**Intelligent Controller / Web Server: 256 Indoor Units**

**P-AIMS: 1.024 Indoor Units**

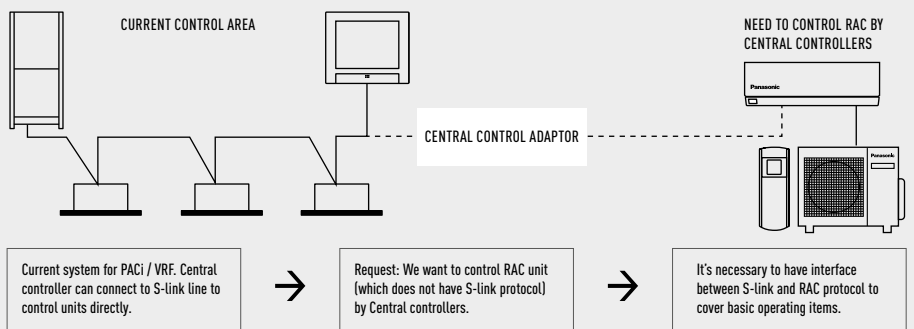

#### Basic operation items

ON/OFF	✓
Mode select	✓
Temperature setting	✓
Fan speed	✓
Flap setting	✓
Remote control prohibit	✓
Econavi ON/OFF	✓

#### External input

ON/OFF control signal	✓
Abnormal stop signal	✓

#### External output for Relay<sup>1</sup>

Operation status (ON/OFF)	✓
Alarm status output	✓

1) Because current CN-CNT connector can not provide the power for external output relay, additional Input power for external relay is necessary.



Panasonic offers its customers cutting-edge technology, specially designed to ensure our air conditioning systems deliver maximum performance. You can properly manage the air conditioning and perform comprehensive monitoring and control, with all of the features the remote controller provides at home, from anywhere in the world thanks to the internet applications Panasonic has created for you.

## Internet Control

Control your air conditioning from wherever you are. Control your comfort and efficiency with the lowest energy consumption.

### PAW-IR-WIFI-1

IntesisHome IS-IR-WIFI-1 device is an easy to install and small device which allows connectivity with the IntesisHome application and connects with your climate system using Infrared (IR). The device enables the control of the Panasonic RAC units without CN-CNT connector (RE, UE, GFE and Free Multi lines).

Specific features: • ON/OFF, mode, set point, fan speed, vanes and room temperature • Easy installation (no special electrical work needed) • Feedback to the IntesisHome system when changes are made from the infrared remote controller.



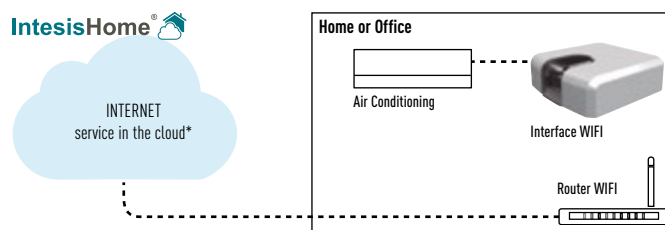

General IntesisHome features: • Calendar scheduler • Scenes • Several languages • Control from anywhere.



\* Functionalities depend on the license. The information indicated above is subject to changes and updates.  
Reference: PA-AC-WIFI-1 For Etherea and Heatcharge, with full communication.  
Reference: PAW-IR-WIFI-1 by Infra red sensor, only ON/OFF and temperature setting.

## Connectivity. Control by BMS

Great flexibility for integration into your IntesisHome, KNX, EnOcean, Modbus and BacNet projects allows fully bi-directional monitoring and control of all the functioning parameters.

Reference	 PAW-AC-KNX-1i	 PAW-AC-MBS-1	 PAW-AC-ENO-1i	 PAW-AC-BAC-1 <sup>1)</sup>
Quick installation and possibility of hidden installation	✓	✓	✓	✓
External power not required	✓	✓	✓	
Direct connection to the AC indoor unit	✓ (split unit or Multi split unit)	✓ (split unit or Multi split unit)	✓ (split unit)	✓
Control and monitoring, from sensors or gateways, of the internal variables of the indoor unit and error codes and indication	✓ Fully KNX compatible	✓ Fully Modbus compatible	✓ Fully EnOcean compatible	
Use the air conditioner ambient temperature or the one measured by	A KNX temperature sensor or Thermostat	A Modbus temperature sensor or Thermostat	An EnOcean temperature sensor or Thermostat	
AC unit can be controlled simultaneously by the remote controller of the AC unit and	by KNX devices	by Modbus devices	by EnOcean devices	
Advanced control functions: use it as a room controller	✓	✓	✓	
4 binary inputs	They work as standard KNX binary inputs as well as being used to control the AC directly	They work as standard Modbus binary inputs as well as being used to control the AC directly	They work as standard EnOcean binary inputs as well as being used to control the AC directly	
Total Control and Supervision. Real states of the AC unit's internal variables				✓
Allows using simultaneously the IR and wired remote controls				and BACnet

1) This interface allows a complete and natural integration of Panasonic air conditioners into either BACnet IP or MS/TP networks.

### PAW-AC-DIO

Dry contact ON/OFF Interface. Panasonic has developed for hotels applications a dry contact PCB which works with Etherea, RE, UE and YE indoor units in order to control simply the unit centrally.

- ON/OFF signal by 3rd party BMS
- PCB connected to CN-RMT port on Indoor Unit PCB

## Easy connectivity















CN-CNT easy to access. Previous Etherea indoor unit had to be dismantle to reach connector.





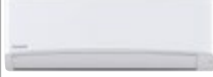
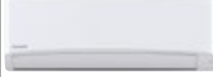

Can easier connect: Wi-Fi accessory / KNX / Modbus / New CZ-CAPRA1 to integrate to PACi control.



Model name	Interface
<b>CZ-CAPRA1</b>	Domestic with CZ-CNT port integration to PACi and ECOi
<b>PA-AC-WIFI-1</b>	Interface for IntesisHome for Etherea, Heatcharge and Flagship, with full communication
<b>PAW-IR-WIFI-1</b>	Interface for IntesisHome by Infra red sensor, only ON/OFF and temperature setting
<b>PAW-AC-ENO-1i</b>	Interface for En-ocean (Etherea, 4-Way 60x60 cassette and Low static pressure hide away)
<b>PAW-AC-KNX-1i</b>	Interface for KNX (Etherea, 4-Way 60x60 cassette and Low static pressure hide away)
<b>PAW-AC-MBS-1</b>	Interface for Modbus (Etherea, 4-Way 60x60 cassette and Low static pressure hide away)
<b>PAW-AC-BAC-1</b>	Interface for BacNet (Etherea, 4-Way 60x60 cassette and Low static pressure hide away)
<b>PAW-AC-HEAT-1</b>	Heating only PCB for Etherea, 4-Way 60x60 cassette and Low static pressure hide away
<b>PAW-AC-DIO</b>	PCB for wall mounted with dry contacts, On/Off, Error message (all OKE and RKE wall mounted)
<b>PAW-SMSCONTROL</b>	Control of the Etherea, Flagship and Heatcharge by SMS (need additional SIM card)

# DOMESTIC AIR CONDITIONER RANGE

1x1 Kits	2,0kW	2,5kW	3,5kW
Wall Mounted Heatcharge VZ Inverter+ • R32 GAS		 KIT-VZ9-SKE	 KIT-VZ12-SKE
Wall Mounted Etherea Inverter+ Silver • R32 GAS	 KIT-XZ7-SKE	 KIT-XZ9-SKE	 KIT-XZ12-SKE
Wall Mounted Etherea Inverter+ Matt Pearl White • R32 GAS	 KIT-Z7-SKEM	 KIT-Z9-SKEM	 KIT-Z12-SKEM
New Wall Mounted TZ Compact Style • R32 GAS	 KIT-TZ20-TKE	 KIT-TZ25-TKE	 KIT-TZ35-TKE
New Wall Mounted TE Compact Style • R410A GAS		 KIT-TE25-TKE	 KIT-TE35-TKE
Wall Mounted KE Type Standard Inverter • R410A GAS		 KIT-KE25-TKE	 KIT-KE35-TKE
Wall Mounted UZ Type Standard Inverter • R32 GAS		 KIT-UZ9-SKE	 KIT-UZ12-SKE

4,2kW	5,0kW	6,0kW	7,1kW
	 KIT-XZ18-SKE		
 KIT-Z15-SKEM	 KIT-Z18-SKEM		 KIT-Z71-TKE
 KIT-TZ42-TKE	 KIT-TZ50-TKE	 KIT-TZ60-TKE	 KIT-TZ71-TKE
	 KIT-KE50-TKE		
	 KIT-UZ18-SKE	 KIT-UZ60-TKE	

# FEATURES EXPLAINED

## Energy saving

**38% ECONAVI**  
Econavi. The sensor determines the human activity level and the position in the room and adjust the air flow orientation for maximum comfort and maximum savings, and detects changes in sunlight intensity and judges whether it is sunny or cloudy/night. It reduces unnecessary heating under more sunlight conditions.

**INVERTER+**  
Inverter Plus System. Inverter plus products improve on the characteristics of standard Inverter air conditioners by over 20%. This means 20% less consumption and 20% off your electric bill. Inverter plus is also A class on cooling and heating mode.

**INVERTER**  
Inverter system. The Inverter range provides greater efficiency, more comfort. Provides more precise temperature control, without highs and lows, and keeps the ambient temperature constant with lower energy consumption and a significant reduction in noise and vibration levels.

**R2 ROTARY COMPRESSOR**  
R2 Rotary Compressor. Panasonic R2 Rotary Compressor. Designed to withstand extreme conditions, it delivers high performance and efficiency.

**R32**  
Refrigerant R32. Our heat pumps containing the new refrigerant R32 show a drastic reduction in the value of Global Warming Potential (GWP). An important step to reduce greenhouse gases. R32 is also a components refrigerant, making it easy to recycle.

## High performance and healthy air

**99% nanoe™**  
nanoe™. nanoe™ utilises nano-technology fine particles to purify the air in the room. It works effectively on airborne and adhesive micro-organisms such as bacteria, viruses and mould thus ensuring a cleaner living environment. Seal of Approval of the British Allergy Foundation.

**PM2.5 FILTER**  
PM2.5 Filter. Particulate matter (PM2.5) can be found suspended in the air, including dust, dirt, smoke and liquid droplets. Sized at 2.5µm, these particles are said to pose health problems as they can easily enter our lungs.

**ANTIALLERGY PROPERTIES**  
Antiallergy Properties. System is equipped with antiallergy properties filter.

**18dB(A) SUPER QUIET**  
Super Quiet. Thanks to its latest generation compressor and its twin blade fan, our outdoor unit is one of the most silent on the market. The indoor unit emits an almost imperceptible 18 dB(A).

**MILD DRY HUMIDITY CONTROL**  
Mild Dry Cooling. Fine control helps prevent a rapid decrease in room humidity while maintaining the set temperature. Maintains an RH\* up to 10% higher than cooling operation [\*RH: Relative Humidity].  
Ideal when sleeping with the air conditioner on.

**AEROWINGS**  
Aerowings. More comfort with Aerowings. Direct airflow to ceiling to create shower cooling effect by twin flap built in indoor.

**-10°C COOLING MODE**  
Down to -10°C in cooling only mode. The air conditioner works in cooling only mode with an outdoor temperature of -10°C.

**-15°C HEATING MODE**  
Down to -15°C in heating mode. The air conditioner works in heat pump mode with an outdoor temperature as low as -15°C.

**SUMMER HOUSE**  
Summer House. This innovative function keeps the house at 7/8°C to avoid freezing pipes during the winter. This function is highly appreciated in summer house or week end houses.

**R22 RENEWAL**  
R22 Renewal. The Panasonic renewal system allows good quality existing R22 pipe work to be re-used whilst installing new high efficiency R410A systems.

**R410A/R22 RENEWAL**  
R410A/R22 Renewal. The Panasonic renewal system allows good quality existing R410A or R22 pipe work to be re-used whilst installing new high efficiency R32 systems.

**ODOUR-REMOVING FUNCTION**  
Odour-removing function. Allows the exchanger to be cleaned, preventing possible odours. While this function is connected, the fan also remains off momentarily to avoid unpleasant odours while the exchanger is being cleaned.

**REMOVABLE, WASHABLE PANEL**  
Removable, washable panel. The front panel is easy to keep clean. It can be removed quickly in one single step and can be washed in water. A clean front panel ensures smoother, more efficient operation, which can save energy.

**POWERFUL MODE**  
Powerful Mode. The rapid and effective powerful mode is ideal for when you come home on the hottest or coldest days. It works at maximum power to reach the desired temperature in just 15 minutes.

**SOFT DRY OPERATION MODE**  
Soft Dry Operation Mode. The soft dry mode eliminates excess moisture with a soft breeze and provides a sense of wellbeing without much change in temperature.

**PERSONAL AIRFLOW CREATION**  
Personal Airflow Creation. Permits the air direction to be adjusted vertically and horizontally. This feature can be conveniently selected by remote controller.

**AUTOMATIC VERTICAL AIRFLOW CONTROL**  
Automatic Vertical Airflow Control. The flap swings up and down automatically. The flow can also be set at a fixed angle with the remote controller.

**MANUAL HORIZONTAL AIRFLOW CONTROL**

**AUTO MODE (INVERTER)**  
Auto Mode (Inverter). Automatically changes from cooling to heating depending on the set temperature for the room.

**SIMPLE AUTO CHANGEOVER**  
Simple Auto Changeover. When the difference between the measured temperature and the set temperature is 3°C or more, it automatically switches the current operation mode to heating or cooling mode necessary to keep the temperature at a constantly comfortable level.

**HOT START MODE**  
Hot Start Mode. At the start of heating cycle and after defrost cycle, the indoor fan will start up once the indoor heat exchanger is warm.

**24 DUAL**  
Real time clock with dual ON&OFF timer. This feature enables you to preset two different sets of start/stop operation timer (hour and minute) within a 24-hour time frame.

**24**  
Real time clock with single ON&OFF timer. The exact operating time (hour and minute) can be set in advance. From here on, the unit will operate in accordance to these preset hours every day until the system is reset.

**LCD WIRELESS REMOTE CONTROLLER**

**AUTOMATIC RESTART**  
Automatic Restart. This function permits automatic restarting if safe mode operation has stopped for some unusual reason, such as after a power cut. As soon as the power is back, the unit restarts with the parameters selected before it stopped.

**LONG PIPING**  
Long Piping. Indicates the maximum length of pipe between the outdoor unit and the indoor unit(s). The distances permitted, demonstrate the installations possible.

**TOP-PANEL MAINTENANCE ACCESS**  
Top-Panel Maintenance Access. Maintenance of an outdoor unit used to be quite a tedious task. Now, with the possibility of removing the top cover, maintenance is quick and easy.

**SELF-DIAGNOSIS FUNCTION**  
Self-Diagnosis Function. With this function the unit carries out a process self-diagnosis when a particular function does not work correctly. This allows faster servicing.

## High connectivity

**INTEGRATION P-LINE**  
CZ-CAPRA1: CZ-CNT port integration to PACi and ECOi. New Domestic integration to P-Line. Can connect ranges to P-Line. Full control is now possible.

**INTERNET CONTROL**  
Internet Control. Internet Control is a next generation system providing user-friendly remote controller of air conditioning or heat pump units from everywhere, using a simple Android or iOS smartphone, tablet or PC via internet.

**BMS CONNECTIVITY**  
Easy control by BMS. The communication port is integrated into the indoor unit and provides easy connection to, and control of, your Panasonic heat pump to your home or building management system.

**5 YEARS WARRANTY**  
5 Years Warranty. Panasonic guarantees the compressors in the entire range for five years.



# FEATURE COMPARISON

MODELS	WALL MOUNTED HEATCHARGE VZ INVERTER+ • R32 GAS	WALL MOUNTED ETHEREA INVERTER+ SILVER / WHITE • R32 GAS	WALL MOUNTED ETHEREA INVERTER+ SILVER / MATT PEARL WHITE • R32 GAS	WALL MOUNTED ETHEREA INVERTER+ SILVER / MATT PEARL WHITE • R410A GAS	NEW WALL MOUNTED TZ COMPACT STYLE • R32 GAS	NEW WALL MOUNTED TE COMPACT STYLE • R410A GAS	WALL MOUNTED KE TYPE STANDARD INVERTER • R410A GAS	WALL MOUNTED BE TYPE STANDARD INVERTER • R410A GAS	WALL MOUNTED DE TYPE STANDARD INVERTER • R410A GAS	WALL MOUNTED UZ TYPE STANDARD INVERTER • R32 GAS	WALL MOUNTED PZ TYPE STANDARD INVERTER • R32 GAS	WALL MOUNTED PROFESSIONAL INVERTER -20°C • R410A GAS	FLOOR CONSOLE TYPE INVERTER+ • R410A GAS	4-WAY 60x60 CASSETTE STANDARD INVERTER • R410A GAS	LOW STATIC PRESSURE HIDE AWAY STANDARD INVERTER • R410A GAS
38% Econavi	✓ Sunlight Detection	✓	✓	✓											
Inverter+ system	✓	✓	✓	✓								✓	✓		
Inverter system					✓	✓				✓	✓			✓	✓
R2 Rotary Compressor	✓	✓	✓	✓		✓	✓	✓	✓	✓	✓	✓	✓	✓	✓
Refrigerant R32	✓	✓	✓		✓					✓	✓				
nanoe™	✓	✓	✓	✓											
PM2.5 Filter					✓	✓	✓			✓					
Antiallergy properties	✓	✓	✓	✓											
Super Quiet*	✓	✓ 19dB(A) for XZ/Z20, XZ/Z25 and XZ/Z35	✓ 19dB(A) for XZ/Z7, XZ/Z9 and XZ/Z12	✓ 20dB(A) for KE/E7, KE/E9 and KE/E12	✓ 20dB(A) for TZ25 and TZ35	✓ 20dB(A) for TE25 and TE35	✓ 20dB(A) for KE25 and KE35	✓ 20dB(A) for BE25 and BE35	✓ 20dB(A) for DE25 and DE35	✓ 20dB(A) for UZ9 and UZ12	✓ 20dB(A) for PZ9 and PZ12	✓ 23dB(A) for E9	✓ 23dB(A) for E9	✓ 23dB(A) for E9 and E12	
Mild Dry Cooling		✓	✓	✓											
Aerowings		✓	✓	✓		✓									
Down to -10°C in cooling only	✓	✓	✓	✓	✓	✓						✓ -15°C		✓	✓
Down to -15°C in heating mode	✓ -35°C	✓	✓	✓	✓	✓	✓	✓	✓	✓	✓	✓	✓ -20°C	✓ -10°C	✓ -10°C
Summer House	✓														
R22 renewal	✓	✓	✓	✓	✓	✓	✓	✓	✓	✓	✓	✓	✓	✓	✓
R410A/R22 Renewal	✓	✓	✓		✓					✓	✓				
Odour-removing function	✓	✓	✓	✓	✓	✓	✓	✓	✓	✓	✓	✓	✓	✓	✓
Removable, washable panel	✓	✓	✓	✓	✓	✓	✓	✓	✓	✓	✓	✓	✓	✓	✓
Powerful mode	✓	✓	✓	✓	✓	✓	✓	✓	✓	✓	✓	✓	✓	✓	✓
Soft dry operation mode	✓	✓	✓	✓	✓	✓	✓	✓	✓	✓	✓	✓	✓	✓	✓
Personal airflow creation	✓	✓	✓	✓	✓ For TZ50, TZ60 and TZ71	✓ For TE50 and TE60									
Automatic vertical airflow control					✓ For TZ20, TZ25, TZ35 and TZ42	✓ For TE20, TE25, TE35 and TE42			✓	✓		✓	✓		
Manual horizontal airflow control					✓ For TZ20, TZ25, TZ35 and TZ42	✓ For TE20, TE25, TE35 and TE42			✓	✓		✓	✓		
AUTO mode (Inverter)	✓	✓	✓	✓	✓	✓	✓	✓	✓	✓	✓	✓	✓	✓	✓
Simple Auto Changeover	✓	✓	✓	✓	✓	✓	✓	✓	✓	✓	✓	✓	✓	✓	✓
Hot start mode	✓	✓	✓	✓	✓	✓	✓	✓	✓	✓	✓	✓	✓	✓	✓
Real time clock with dual ON&OFF timer	✓	✓	✓	✓								✓			
Real time clock with single ON&OFF timer					✓	✓	✓	✓	✓	✓	✓		✓	✓	✓
LCD Wireless remote controller	✓	✓	✓	✓	✓	✓	✓	✓	✓	✓	✓	✓	✓	✓	✓
Automatic restart	✓	✓	✓	✓	✓	✓	✓	✓	✓	✓	✓	✓	✓	✓	✓
Long piping	✓ 15 m	✓ 15 m 20 m (XZ/Z50)	✓ 15 m 20 m (XZ/Z18)	✓ 15 m 20 m (XE/E18-21) 30 m (XE/E24-28)	✓ 15 m 20 m (TZ50) 30 m (TZ71)	✓ 15 m 20 m (TE50) 30 m (TE71)	✓ 15 m	✓ 15 m	✓ 15 m	✓ 15 m	✓ 15 m	✓ 15 m 20 m (E18)	✓ 15 m 20 m (E18)	✓ 20 m 30 m (E18-21)	✓ 20 m 30 m (E18)
Top-Panel maintenance access	✓	✓	✓	✓	✓	✓	✓	✓	✓	✓	✓	✓	✓	✓	✓
Self-diagnosis function	✓	✓	✓	✓	✓	✓	✓	✓	✓	✓	✓	✓	✓	✓	✓
CZ-CAPRA1: CZ-CNT port integration to PACI and ECOi	✓	✓	✓	✓	✓	✓	✓	✓	✓	✓	✓	✓	✓	✓	✓
Internet Control	✓	✓	✓	✓	✓	✓	✓	✓	✓	✓	✓	✓	✓	✓	✓
Easy control by BMS	✓	✓	✓	✓	✓	✓	✓	✓	✓	✓	✓	✓	✓	✓	✓
Warranty on the compressor	✓	✓	✓	✓	✓	✓	✓	✓	✓	✓	✓	✓	✓	✓	✓

\* At the lowest fan speed.

# WALL MOUNTED HEATCHARGE VZ INVERTER+ • R32 GAS



## heatcharge

The new Heatcharge from Panasonic has the capacity to store heat on the outdoor unit which allows heating to start quickly just after turning on the heat pump. It also ensures maximum comfort and heat in the house even during defrost operation as Heat charge also stores heat to prevent cool air during defrost.

Econavi builds-in a new Sunlight Detection technology to adjust output ideally thereby giving you the best comfort at anytime whilst saving energy.

Furthermore, the nanoe™ revolutionary air-purifying system utilises nano technology fine particles to remove and deactivate 99% of both airborne and adhesive micro-organisms like bacteria, viruses and mould.

### Technical focus

- R32 gas environmental friendly
- Performance tested at -35°C Outdoor temperature
- Energy Charge System. Heat storage unit which realizes NON-STOP heating and fast heating function
- Maximum efficiency and comfort with Econavi sensor
- nanoe™ air purifying system, 99% effective on both airborne and adhesive mould, viruses and bacteria
- Super Quiet! Only 18dB(A), equivalent to night-time in the country
- More powerful airflow to quickly reach the desired temperature

Kit			KIT-VZ9-SKE	KIT-VZ12-SKE
Cooling capacity	Nominal (Min - Max)	kW	2,50 (0,60 - 3,00)	3,50 (0,60 - 4,00)
<b>SEER</b>		<b>W/W</b>	<b>10,50</b> A+++	<b>10,00</b> A+++
Pdesign (cooling)		kW	2,5	3,5
Input power cooling	Nominal (Min - Max)	kW	0,43 (0,14 - 0,61)	0,80 (0,14 - 1,01)
Annual electricity consumption (cooling) <sup>2)</sup>		kWh/a		
Heating capacity	Nominal (Min - Max)	kW	3,60 (0,60 - 7,80)	4,20 (0,60 - 9,20)
COP <sup>1)</sup>		W/W	5,63 A	5,04 A
Heating capacity at -7°C		kW	5,00	5,60
COP at -7°C <sup>1)</sup>		W/W	2,07	2,00
<b>SCOP</b>		<b>W/W</b>	<b>6,20</b> A+++	<b>5,90</b> A+++
Pdesign at -10°C		kW	3,6	4,2
Input power heating	Nominal (Min - Max)	kW	0,64 (0,14 - 2,72)	0,83 (0,14 - 3,16)
Annual electricity consumption (heating) <sup>2)</sup>		kWh/a		
<b>Indoor Unit</b>			<b>CS-VZ9SKE</b>	<b>CS-VZ12SKE</b>
Power source		V	230	230
Recommended fuse		A	16	16
Connection		mm <sup>2</sup>	4 x 1,5	4 x 1,5
Air volume	Cooling / Heating	m <sup>3</sup> /min	17,0	17,5
Sound pressure <sup>3)</sup>	Cooling (Hi / Lo / Q-Lo)	dB(A)	44 / 27 / 18	45 / 33 / 18
	Heating (Hi / Lo / Q-Lo)	dB(A)	44 / 26 / 18	45 / 29 / 18
Dimensions / Net weight	H x W x D	mm / kg	295 x 798 x 375 / 14,5	295 x 798 x 375 / 14,5
<b>Outdoor Unit</b>			<b>CU-VZ9SKE</b>	<b>CU-VZ12SKE</b>
Air volume	Cooling / Heating	m <sup>3</sup> /min	33,0 / 31,5	34,2 / 31,5
Sound pressure <sup>3)</sup>	Cooling / Heating (Hi)	dB(A)	49 / 49	50 / 50
Dimensions <sup>4)</sup> / Net weight	H x W x D	mm / kg	630 x 799 x 299 / 39,5	630 x 799 x 299 / 39,5
Piping connections	Liquid pipe / Gas pipe	Inch (mm)	1/4 (6,35) / 3/8 (9,52)	1/4 (6,35) / 3/8 (9,52)
Piping length range / Elevation difference (in/out)		m	3 - 15 / 12	3 - 15 / 12
Pipe length for additional gas / Additional gas amount		m / g/m	7,5 / 20	7,5 / 20
Refrigerant (R32)		kg / TCO <sub>2</sub> Eq.	1,05 / 0,70875	1,10 / 0,7425
Operating range	Cooling Min - Max	°C	-10 ~ +43	-10 ~ +43
	Heating Min - Max	°C	-35 / +24	-35 / +24

Accessories	
<b>PA-AC-WIFI-1</b>	Full bidirectional Wifi interface for Internet control
<b>PAW-IR-WIFI-1</b>	IR Wifi interface for Internet control

Accessories	
<b>PAW-SMSCONTROL</b>	Control by SMS (need additional SIM card)

1) EER and COP classification is at 230 V in accordance with EU directive 2002/31/EC. 2) The annual energy consumption is calculated in accordance with the ErP directive. 3) The Sound pressure level of the units shows the value measured of a position 1 meter in front of the main body and 0,8 m below the unit. The sound pressure is measured in accordance with Eurovent 6/C/006-97 specification. 4) Add 70mm for piping port.



R32

38%  
ECONAVI

A+++  
10,50 SEER

A+++  
6,20 SCOP

INVERTER+

R2 ROTARY  
COMPRESSOR

99%  
nanoe™

18dB(A)  
SUPER QUIET

-35°C  
HEATING MODE

SUMMER HOUSE

R410A/R32 RENEWAL

INTERNET CONTROL

CONNECTIVITY

5 YEARS WARRANTY

SEER and SCOP: For KIT-VZ9-SKE. -35°C HEATING MODE: Heating performance tested at -35°C by SP, European third party laboratory. INTERNET CONTROL: Optional.



# WALL MOUNTED ETHEREA INVERTER+ SILVER / MATT PEARL WHITE • R32 GAS

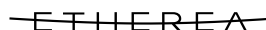

Etherea with enhanced Econavi sensor and new nanoe™ air-purifying system.

## Outstanding efficiency, comfort and healthy air combined with state-of-the-art design.

Econavi features an in-built human activity sensor and a new sunlight detection technology to adjust output thereby giving you the best comfort at anytime whilst saving energy. Econavi not only optimizes air flow orientation and volume according to human presence, it also reduces cooling power automatically by no/less sunshine. With Econavi, energy savings of up to 38% are possible, whilst increasing your comfort. Furthermore, the nanoe™ revolutionary air-purifying system utilises nano technology fine particles to remove and deactivate 99% of both airborne and adhesive micro-organisms like bacteria, viruses and mould.

## Technical focus

- R32 gas environmental friendly
- Maximum efficiency and comfort with Econavi sensor
- nanoe™ air purifying system, 99% effective on both airborne and adhesive mould, viruses, bacteria and pollen allergen
- Aerowings to control air draft direction
- Mild Dry Cooling: prevent a rapid decrease in room humidity
- Super Quiet! Only 19dB(A), equivalent to night-time in the countryside
- More powerful airflow to quickly reach the desired temperature
- Wired control (Optional)
- Smartphone control (Optional)

Wall Mounted Etherea  
Matt Pearl White

Kit Silver			KIT-XZ7-SKE	KIT-XZ9-SKE	KIT-XZ12-SKE	—	KIT-XZ18-SKE	—
Kit Matt Pearl White			KIT-Z7-SKEM	KIT-Z9-SKEM	KIT-Z12-SKEM	KIT-Z15-SKEM	KIT-Z18-SKEM	KIT-Z71-TKE
Cooling capacity	Nominal (Min - Max)	kW	2,05 (0,75 - 2,40)	2,50 (0,85 - 3,00)	3,50 (0,85 - 4,00)	4,20 (0,85 - 5,00)	5,00 (0,98 - 5,60)	7,10 (0,98 - 8,50)
EER <sup>1)</sup>	Nominal (Min - Max)	W/W	4,56 (3,13 - 4,32) A	4,76 (3,54 - 4,20) A	4,17 (3,54 - 3,77) A	3,39 (3,27 - 3,18) A	3,33 (3,50 - 3,26) A	3,27 (2,33 - 2,93) A
<b>SEER</b>		<b>W/W</b>	<b>7,50 A++</b>	<b>8,50 A+++</b>	<b>8,50 A+++</b>	<b>6,90 A+++</b>	<b>7,30 A+++</b>	<b>6,50 A+++</b>
Pdesign (cooling)		kW	2,1	2,5	3,5	4,2	5,0	7,1
Input power cooling	Nominal (Min - Max)	kW	0,45 (0,24 - 0,56)	0,53 (0,24 - 0,72)	0,84 (0,24 - 1,06)	1,24 (0,26 - 1,57)	1,50 (0,28 - 1,72)	2,17 (0,42 - 2,90)
Annual electricity consumption (cooling) <sup>2)</sup>		kWh/a	225	263	420	620	750	382
Heating capacity	Nominal (Min - Max)	kW	2,80 (0,70 - 4,00)	3,40 (0,80 - 5,00)	4,00 (0,80 - 5,80)	5,30 (0,80 - 6,80)	5,80 (0,98 - 7,50)	8,60 (0,98 - 10,200)
Heating capacity at -7°C		kW	2,38	2,95	3,40	4,11	4,66	6,31
COP <sup>1)</sup>	Nominal (Min - Max)	W/W	4,52 (3,89 - 4,04) A	4,72 (4,44 - 3,94) A	4,35 (4,44 - 3,82) A	3,68 (4,21 - 3,51) A	3,41 (2,88 - 3,19) B	3,66 (2,45 - 3,46) A
<b>SCOP</b>		<b>W/W</b>	<b>4,70 A++</b>	<b>4,90 A+++</b>	<b>4,90 A+++</b>	<b>4,00 A++</b>	<b>4,40 A++</b>	<b>4,20 A++</b>
Pdesign at -10°C		kW	2,1	2,7	3,2	3,6	4,2	5,5
Input power heating	Nominal (Min - Max)	kW	0,62 (0,18 - 0,99)	0,72 (0,18 - 1,27)	0,92 (0,18 - 1,52)	1,44 (0,19 - 1,94)	1,70 (0,34 - 2,35)	2,35 (0,40 - 2,95)
Annual electricity consumption (heating) <sup>2)</sup>		kWh/a	626	771	914	1.260	1.336	1.833
<b>Indoor Unit Silver</b>			<b>CS-XZ7SKEW</b>	<b>CS-XZ9SKEW</b>	<b>CS-XZ12SKEW</b>	—	<b>CS-XZ18SKEW</b>	—
<b>Indoor Unit White Matt</b>			<b>CS-Z7SKEW-M</b>	<b>CS-Z9SKEW-M</b>	<b>CS-Z12SKEW-M</b>	<b>CS-Z15SKEW-M</b>	<b>CS-Z18SKEW-M</b>	<b>CS-Z71TKEW</b>
Power source		V	230	230	230	230	230	230
Recommended fuse		A	16	16	16	16	16	—
Connection indoor / outdoor		mm <sup>2</sup>	4 x 1,5	4 x 1,5	4 x 1,5	4 x 1,5	4 x 2,5	—
Air volume	Cooling / Heating	m <sup>3</sup> /min	9,9 / 10,8	10,0 / 11,3	10,7 / 12,0	11,2 / 12,2	11,7 / 12,4	19,8 / 21,5
Moisture removal volume		L/h	1,3	1,5	2,0	2,4	2,8	4,1
Sound pressure <sup>3)</sup>	Cooling (Hi / Lo / Q-Lo)	dB(A)	37 / 24 / 19	39 / 25 / 19	42 / 28 / 19	43 / 31 / 25	44 / 37 / 34	47 / 38 / 30
	Heating (Hi / Lo / Q-Lo)	dB(A)	38 / 25 / 19	40 / 27 / 19	42 / 33 / 19	43 / 35 / 29	44 / 37 / 34	47 / 38 / 30
Dimensions / Net weight	H x W x D	mm / kg	295 x 919 x 194 / 9	295 x 919 x 194 / 10	295 x 919 x 194 / 10	295 x 919 x 194 / 10	295 x 919 x 194 / 10	299 x 1.120 x 236 / 13
<b>Outdoor</b>			<b>CU-Z7SKE</b>	<b>CU-Z9SKE</b>	<b>CU-Z12SKE</b>	<b>CU-Z15SKE</b>	<b>CU-Z18SKE</b>	<b>CU-Z71TKE</b>
Air volume	Cooling / Heating	m <sup>3</sup> /min	26,9 / 26,9	28,7 / 28,7	34,4 / 35,6	33,3 / 33,7	39,2 / 37,9	44,7 / 45,8
Sound pressure <sup>3)</sup>	Cooling / Heating (Hi)	dB(A)	45 / 46	46 / 47	48 / 50	49 / 51	47 / 47	52 / 54
Dimensions <sup>4)</sup> / Net weight	H x W x D	mm / kg	542 x 780 x 289 / 30	542 x 780 x 289 / 33	619 x 824 x 299 / 35	619 x 824 x 299 / 32	695 x 875 x 320 / 46	695 x 875 x 320 / 49
Piping connections	Liquid pipe / Gas pipe	Inch (mm)	1/4 (6,35) / 3/8 (9,52)	1/4 (6,35) / 3/8 (9,52)	1/4 (6,35) / 3/8 (9,52)	1/4 (6,35) / 1/2 (12,70)	1/4 (6,35) / 1/2 (12,70)	1/4 (6,35) / 5/8 (15,88)
Piping length range / Elevation difference (in/out) <sup>5)</sup>		m	3 - 15 / 15	3 - 15 / 15	3 - 15 / 15	3 - 15 / 15	3 - 20 / 15	3 - 30 / 20
Pipe length for additional gas / Additional gas amount		m / g/m	7,5 / 10	7,5 / 10	7,5 / 10	7,5 / 10	7,5 / 15	10 / 25
Refrigerant (R32)		kg / TCO: Eq.	0,76 / —	0,85 / —	0,91 / —	0,87 / —	1,03 / —	1,37 / —
Operating range	Cooling Min - Max	°C	-10 ~ +43	-10 ~ +43	-10 ~ +43	-10 ~ +43	-10 ~ +43	-15 ~ +24
	Heating Min - Max	°C	-15 ~ +24	-15 ~ +24	-15 ~ +24	-15 ~ +24	-15 ~ +24	10 ~ +43

### Accessories

<b>PA-AC-WIFI-1</b>	Full bidirectional Wifi interface for Internet control
<b>PAW-IR-WIFI-1</b>	IR Wifi interface for Internet control

### Accessories

<b>CZ-RD514C</b>	Wired remote controller for wall type
<b>CZ-CAPRA1</b>	H Generation interface to ECOi control integration

1) EER and COP classification is at 230V in accordance with EU directive 2002/31/EC. 2) The annual energy consumption is calculated in accordance with the ErP directive. 3) The Sound pressure of the units shows the value measured of a position 1m in front of the main body and 0,8m below the unit. The sound pressure is measured in accordance with Eurovent 6/C/006-97 specification. Q-Lo: Quiet mode. Lo: The lowest fan speed. 4) Add 70mm for piping port. 5) When installing the outdoor unit at a higher position than the indoor unit.



SEER and SCOP: For KIT-XZ9-SKE and KIT-Z9-SKE. SUPER QUIET: For KIT-XZ7-SKE, KIT-XZ9-SKE, KIT-XZ12-SKE, KIT-Z7-SKE, KIT-Z9-SKE and KIT-Z12-SKE. INTERNET CONTROL: Optional.

# WALL MOUNTED TZ COMPACT STYLE INVERTER • R32 GAS



## TZ compact indoor size.

The new TZ indoor units have a new size. With 799mm of width, you can put the air conditioner on the top of the door. New TZ Inverter models are powerful and efficient, with an outstanding energy ranking of A++/A+, unique in the market! The TZ works up to an outdoor temperature of -15°C in heating mode and -10°C up to an outdoor temperature of -15°C in heating and -10°C in cooling and still with a high efficiency and capacity! Furthermore, the annual energy consumption has never been so low.



## Technical focus

- **NEW!** New compact design with 799mm
- R32 gas environmental friendly
- Aerowings to control air draft direction
- PM2,5 Filter to create clean and comfort indoor quality
- Complete line-up of standard Inverter models
- Super Quiet! Only 20dB(A)
- High energy savings
- This units can be installed on R410A and R22 pipings
- Long connection distance (from 15m up to 30m)
- Wired control (Optional)
- Smartphone control (Optional)

Kit			KIT-TZ20-TKE	KIT-TZ25-TKE	KIT-TZ35-TKE	KIT-TZ42-TKE	KIT-TZ50-TKE	KIT-TZ60-TKE	KIT-TZ71-TKE
Cooling capacity	Nominal (Min - Max)	kW	2,00 (0,75 - 2,40)	2,50 (0,85 - 3,00)	3,50 (0,85 - 3,90)	4,20 (0,85 - 4,60)	5,00 (0,98 - 5,60)	6,30 (0,98 - 7,10)	7,10 (0,98 - 8,10)
EER <sup>1)</sup>	Nominal (Min - Max)	W/W	3,92 (3,00 - 3,87) A	3,79 (3,40 - 3,37) A	3,50 (3,33 - 3,28) A	3,33 (3,21 - 2,79) A	3,40 (3,44 - 3,24) A	3,26 (3,50 - 2,98) A	3,17 (2,33 - 3,03)
<b>SEER</b>		<b>W/W</b>	<b>6,40</b> ◀A++	<b>6,40</b> ◀A++	<b>6,20</b> ◀A++	<b>5,80</b> ◀A+	<b>6,80</b> ◀A++	<b>6,50</b> ◀A++	<b>6,10</b> ◀A++
Pdesign (cooling)		kW	2,0	2,5	3,5	4,2	5,0	6,3	7,1
Input power cooling	Nominal (Min - Max)	kW	0,51 (0,25 - 0,62)	0,66 (0,25 - 0,89)	1,00 (0,26 - 1,19)	1,26 (0,265 - 1,65)	1,47 (0,29 - 1,73)	1,93 (0,28 - 2,38)	2,24 (0,42 - 2,67)
Annual electricity consumption (cooling) <sup>2)</sup>		kWh/a	255	330	500	630	735	339	407
Heating capacity	Nominal (Min - Max)	kW	2,70 (0,70 - 3,60)	3,30 (0,80 - 4,10)	4,00 (0,80 - 5,10)	5,00 (0,80 - 6,80)	5,80 (0,98 - 7,80)	7,20 (0,98 - 8,50)	8,60 (0,98 - 9,90)
Heating capacity at -7°C		kW	2,14	2,70	3,30	3,90	4,79	5,24	6,13
COP <sup>1)</sup>	Nominal (Min - Max)	W/W	4,03 (3,78 - 3,46) A	4,13 (4,10 - 3,63) A	3,81 (4,00 - 3,59) A	3,70 (4,00 - 3,32) A	3,77 (2,88 - 3,39) A	3,44 (2,88 - 3,15) B	3,51 (2,45 - 3,47) B
<b>SCOP</b>		<b>W/W</b>	<b>4,10</b> ◀A+	<b>4,20</b> ◀A+	<b>4,20</b> ◀A+	<b>3,80</b> ◀A	<b>4,30</b> ◀A+	<b>4,20</b> ◀A+	<b>4,00</b> ◀A+
Pdesign at -10°C		kW	1,9	2,4	2,8	3,6	4,0	4,6	5,5
Input power heating	Nominal (Min - Max)	kW	0,67 (0,19 - 1,04)	0,80 (0,20 - 1,13)	1,05 (0,20 - 1,42)	1,35 (0,20 - 2,05)	1,54 (0,34 - 2,30)	2,09 (0,34 - 2,70)	2,45 (0,40 - 2,85)
Annual electricity consumption (heating) <sup>2)</sup>		kWh/a	649	800	933	1.326	1.302	1.533	1.925
<b>Indoor Unit</b>			<b>CS-TZ20TKEW</b>	<b>CS-TZ25TKEW</b>	<b>CS-TZ35TKEW</b>	<b>CS-TZ42TKEW</b>	<b>CS-TZ50TKEW</b>	<b>CS-TZ60TKEW</b>	<b>CS-TZ71TKEW</b>
Air volume	Cooling / Heating	m³/min	10,0 / 10,9	10,9 / 11,6	11,8 / 12,5	12,3 / 12,9	19,9 / 20,8	20,8 / 21,4	20,0 / 22,0
Moisture removal volume		L/h	1,3	1,5	2,0	2,4	2,8	3,5	4,1
Sound pressure <sup>3)</sup>	Cooling (Hi / Lo / Q-Lo)	dB(A)	37 / 25 / 20	40 / 26 / 20	42 / 30 / 20	44 / 31 / 29	44 / 37 / 34	45 / 37 / 34	47 / 38 / 35
	Heating (Hi / Lo / Q-Lo)	dB(A)	38 / 26 / 22	40 / 27 / 22	42 / 33 / 22	44 / 35 / 28	44 / 37 / 34	45 / 37 / 34	47 / 38 / 35
Dimensions / Net weight	H x W x D	mm / kg	290 x 799 x 197 / 8	290 x 799 x 197 / 8	290 x 799 x 197 / 8	290 x 799 x 197 / 8	302 x 1.102 x 244 / 12	302 x 1.102 x 244 / 12	302 x 1.102 x 244 / 13
<b>Outdoor Unit</b>			<b>CU-TZ20TKE</b>	<b>CU-TZ25TKE</b>	<b>CU-TZ35TKE</b>	<b>CU-TZ42TKE</b>	<b>CU-TZ50TKE</b>	<b>CU-TZ60TKE</b>	<b>CU-TZ71TKE</b>
Power source		V	230	230	230	230	230	230	230
Recommended fuse		A	16	16	16	16	16	20	—
Connection (indoor/outdoor)		mm²	4 x 1,5	4 x 1,5	4 x 1,5	4 x 1,5	4 x 2,5	4 x 2,5	—
Air volume	Cooling / Heating	m³/min	31,2 / 29,7	30,0 / 28,9	28,7 / 30,4	33,6 / 34,0	33,0 / 32,2	42,6 / 41,5	44,7 / 48,1
Sound pressure <sup>3)</sup>	Cooling / Heating (Hi)	dB(A)	46 / 47	47 / 48	48 / 50	49 / 51	48 / 49	49 / 49	52 / 54
Dimensions <sup>4)</sup> / Net weight	H x W x D	mm / kg	542 x 780 x 289 / 26	542 x 780 x 289 / 27	542 x 780 x 289 / 32	619 x 824 x 299 / 32	619 x 824 x 299 / 40	695 x 875 x 320 / 42	695 x 875 x 320 / 49
Piping connections	Liquid pipe / Gas pipe	Inch (mm)	1/4 (6,35) / 3/8 (9,52)	1/4 (6,35) / 3/8 (9,52)	1/4 (6,35) / 3/8 (9,52)	1/4 (6,35) / 1/2 (12,70)	1/4 (6,35) / 1/2 (12,70)	1/4 (6,35) / 1/2 (12,70)	1/4 (6,35) / 5/8 (15,88)
Piping length range / Elevation difference (in/out)		m	3 - 15 / 15	3 - 15 / 15	3 - 15 / 15	3 - 15 / 15	3 - 20 / 15	3 - 30 / 15	3 - 30 / 25
Pipe length for additional gas / Additional gas amount		m / g/m	7,5 / 10	7,5 / 10	7,5 / 10	7,5 / 10	7,5 / 15	7,5 / 15	10 / 25
Refrigerant (R32)		kg / TCO <sub>2</sub> Eq.	0,58 / 0,392	0,67 / 0,452	0,77 / 0,520	0,86 / 0,581	1,14 / —	1,11 / 0,749	1,32 / 0,891
Operating range	Cooling Min - Max	°C	-10 ~ +43	-10 ~ +43	-10 ~ +43	-10 ~ +43	-10 ~ +43	-10 ~ +43	-10 ~ +43
	Heating Min - Max	°C	-15 ~ +24	-15 ~ +24	-15 ~ +24	-15 ~ +24	-15 ~ +24	-15 ~ +24	-15 ~ +24

Accessories	
<b>PA-AC-WIFI-1</b>	Full bidirectional Wifi interface for Internet control
<b>PAW-IR-WIFI-1</b>	IR Wifi interface for Internet control

Accessories	
<b>CZ-RD514C</b>	Wired remote controller for wall type
<b>CZ-CAPRA1</b>	H Generation interface to ECOi control integration

1) EER and COP classification is at 230V in accordance with EU directive 2002/31/EC. 2) The annual energy consumption is calculated in accordance with the ErP directive. 3) The Sound pressure of the units shows the value measured of a position 1m in front of the main body and 0,8m below the unit. The sound pressure is measured in accordance with Eurovent 6/C/006-97 specification. Q-Lo: The lowest fan speed. Lo: The second lowest fan speed (the lowest fan speed for TZ50/60). 4) Add 70mm for piping port. \* Tentative values.



R32

6,80 SEER

4,30 SCOP

INVERTER

R2 ROTARY COMPRESSOR

PM2.5 FILTER

20dB(A)

AEROWINGS

R410A/R22 RENEWAL

INTEGRATION P-LINE

INTERNET CONTROL

CONNECTIVITY

5 YEARS WARRANTY

SEER and SCOP: For KIT-TZ50-TKE. SUPER QUIET: For KIT-TZ20-TKE, KIT-TZ25-TKE and KIT-TZ35-TKE. INTERNET CONTROL: Optional.





# WALL MOUNTED TE COMPACT STYLE INVERTER • R410A GAS

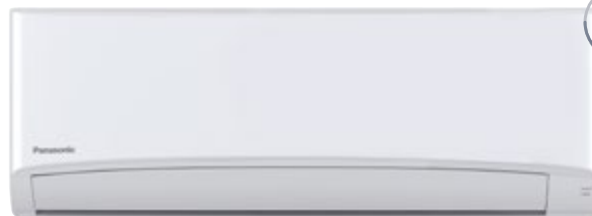

## TE compact indoor size.

The new TE indoor units have a new size. With 799mm of width, you can put the air conditioner on the top of the door. New TE Inverter models are powerful and efficient, with an outstanding energy ranking of A++/A+, unique in the market! The TE works up to an outdoor temperature of -15°C in heating mode and -10°C up to an outdoor temperature of -15°C in heating and -10°C in cooling and still with a high efficiency and capacity! Furthermore, the annual energy consumption has never been so low.

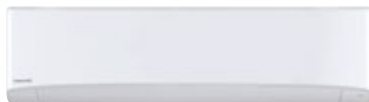

CS-TE50TKEW  
CS-TE60TKEW

## Technical focus

- **NEW!** New compact design with 799mm
- Aerowings to control air draft direction
- PM2,5 Filter to create clean and comfort indoor quality
- Complete line-up of standard Inverter models
- Super Quiet! Only 20dB(A)
- High energy savings
- This units can be installed on R22 pipings
- Long connection distance (from 15m up to 30m)
- Wired control (Optional)
- Smartphone control (Optional)

Kit			KIT-TE25-TKE	KIT-TE35-TKE
Cooling capacity	Nominal (Min - Max)	kW	2,50 (0,85 - 3,00)	3,50 (0,85 - 3,90)
EER <sup>1)</sup>	Nominal (Min - Max)	W/W	3,73 (3,40 - 3,30) A	3,43 (3,33 - 3,22) A
<b>SEER</b>		<b>W/W</b>	<b>6,10</b> ◀ <b>A++</b>	<b>6,10</b> ◀ <b>A++</b>
Pdesign (cooling)		kW	2,5	3,5
Input power cooling	Nominal (Min - Max)	kW	0,67 (0,25 - 0,91)	1,02 (0,26 - 1,21)
Annual electricity consumption (cooling) <sup>2)</sup>		kWh/a	143	201
Heating capacity	Nominal (Min - Max)	kW	3,30 (0,80 - 4,10)	4,00 (0,80 - 5,10)
Heating capacity at -7°C		kW	2,70	3,30
COP <sup>1)</sup>	Nominal (Min - Max)	W/W	4,07 (4,10 - 3,57) A	3,74 (4,00 - 3,54) A
<b>SCOP</b>		<b>W/W</b>	<b>4,10</b> ◀ <b>A+</b>	<b>4,10</b> ◀ <b>A+</b>
Pdesign at -10°C		kW	2,4	2,8
Input power heating	Nominal (Min - Max)	kW	0,81 (0,20 - 1,15)	1,07 (0,20 - 1,44)
Annual electricity consumption (heating) <sup>2)</sup>		kWh/a	820	956
<b>Indoor Unit</b>			<b>CS-TE25TKEW</b>	<b>CS-TE35TKEW</b>
Air volume	Cooling / Heating	m <sup>3</sup> /min	10,9 / 11,6	11,8 / 12,5
Moisture removal volume		L/h	1,5	2,0
Sound pressure <sup>3)</sup>	Cooling (Hi / Lo / Q-Lo)	dB(A)	40 / 26 / 20	42 / 30 / 20
	Heating (Hi / Lo / Q-Lo)	dB(A)	40 / 27 / 22	42 / 33 / 22
Dimensions / Net weight	H x W x D	mm / kg	290 x 799 x 197 / 8	290 x 799 x 197 / 8
<b>Outdoor Unit</b>			<b>CU-TE25TKE</b>	<b>CU-TE35TKE</b>
Power source		V	230	230
Recommended fuse		A	16	16
Connection (indoor/outdoor)		mm <sup>2</sup>	4 x 1,5	4 x 1,5
Air volume	Cooling / Heating	m <sup>3</sup> /min	30,0 / 28,9	28,7 / 30,4
Sound pressure <sup>3)</sup>	Cooling / Heating (Hi)	dB(A)	47 / 48	48 / 50
Dimensions <sup>4)</sup> / Net weight	H x W x D	mm / kg	542 x 780 x 289 / 27	542 x 780 x 289 / 32
Piping connections	Liquid pipe / Gas pipe	Inch (mm)	1/4 (6,35) / 3/8 (9,52)	1/4 (6,35) / 3/8 (9,52)
Piping length range / Elevation difference (in/out)		m	3 ~ 15 / 15	3 ~ 15 / 15
Pipe length for additional gas / Additional gas amount		m / g/m	7,5 / 15	7,5 / 20
Refrigerant (R410A)		kg / TCO <sub>2</sub> Eq.	0,77 / 1,608	0,95 / 1,984
Operating range	Cooling Min ~ Max	°C	-10 ~ +43	-10 ~ +43
	Heating Min ~ Max	°C	-15 ~ +24	-15 ~ +24

### Accessories

PA-AC-WIFI-1	Full bidirectional Wifi interface for Internet control
PAW-IR-WIFI-1	IR Wifi interface for Internet control

### Accessories

CZ-RD514C	Wired remote controller for wall type
CZ-CAPRA1	H Generation interface to ECOi control integration

1) EER and COP classification is at 230V in accordance with EU directive 2002/31/EC. 2) The annual energy consumption is calculated in accordance with the ErP directive. 3) The Sound pressure of the units shows the value measured of a position 1m in front of the main body and 0,8m below the unit. The sound pressure is measured in accordance with Eurovent 6/C/006-97 specification. Q-Lo: The lowest fan speed. Lo: The second lowest fan speed (the lowest fan speed for TE50/60). 4) Add 70mm for piping port. \* Tentative values.



CU-TE20TKE  
CU-TE25TKE  
CU-TE35TKE



CU-TE42TKE  
CU-TE50TKE



CU-TE60TKE



Included for  
TE20, TE25, TE35  
and TE42



Included for  
TE50 and TE60



Optional wired  
remote  
controller  
CZ-RD514C

<b>A++</b> 6,50 SEER	<b>A+</b> 4,10 SCOP	<b>INVERTER</b>	<b>R2 ROTARY COMPRESSOR</b>	<b>PM2.5 FILTER</b>	<b>20dB(A) SUPER QUIET</b>	<b>AEROWINGS</b>	<b>R22 RENEWAL R410A</b>	<b>INTEGRATION P-LINE</b>	<b>INTERNET CONTROL</b>	<b>BMS CONNECTIVITY</b>	<b>5 YEARS WARRANTY</b>
-------------------------	------------------------	-----------------	-----------------------------	---------------------	----------------------------	------------------	--------------------------	---------------------------	-------------------------	-------------------------	-------------------------

SEER and SCOP: For KIT-TE50-TKE. SUPER QUIET: For KIT-TE25-TKE, KIT-TE25-TKE and KIT-TE35-TKE. INTERNET CONTROL: Optional.  
Rating Conditions: Cooling Indoor 27°C DB / 19°C WB. Cooling Outdoor 35°C DB / 24°C WB. Heating Indoor 20°C DB. Heating Outdoor 7°C DB / 6°C WB. (DB: Dry Bulb; WB: Wet Bulb)  
Specifications subject to change without notice. For detailed information about ErP, please visit our websites www.aircon.panasonic.eu or www.ptc.panasonic.eu.

# WALL MOUNTED KE TYPE STANDARD INVERTER • R410A GAS



New KE series inverter powerful and efficient.



### Technical focus

- **NEW!** New design
- PM2,5 Filter to create clean and comfort indoor quality
- Super Quiet! Only 20dB(A)
- High energy savings
- This units can be installed on R22 pipings
- Long connection distance
- Wired control (Optional)
- Smartphone control (Optional)



CS-KE50TKE

Kit*			KIT-KE25-TKE	KIT-KE35-TKE	KIT-KE50-TKE
Cooling capacity	Nominal (Min - Max)	kW	2,50 (0,85 - 3,00)	3,40 (0,85 - 3,90)	5,00 (0,98 - 5,40)
EER <sup>1)</sup>	Nominal (Min - Max)	W/W	3,57 (3,40 - 3,26) A	3,12 (3,33 - 3,00) B	2,98 (3,44 - 2,86) C
<b>SEER</b>		<b>W/W</b>	<b>6,20</b> ◀A++	<b>6,10</b> ◀A++	<b>6,20</b> ◀A++
Pdesign (cooling)		kW	2,5	3,4	5,0
Input power cooling	Nominal (Min - Max)	kW	0,70 (0,25 - 0,92)	1,09 (0,26 - 1,30)	1,68 (0,29 - 1,89)
Annual electricity consumption (cooling) <sup>2)</sup>		kWh/a	350	545	840
Heating capacity	Nominal (Min - Max)	kW	3,15 (0,80 - 3,60)	3,84 (0,80 - 4,40)	5,40 (0,98 - 7,50)
Heating capacity at -7°C		kW	2,14	2,60	4,58
COP <sup>1)</sup>	Nominal (Min - Max)	W/W	3,99 (4,10 - 3,43) A	3,66 (4,10 - 3,41) A	3,38 (2,80 - 3,04) C
<b>SCOP</b>		<b>W/W</b>	<b>3,80</b> ◀A	<b>3,80</b> ◀A	<b>3,90</b> ◀A
Pdesign at -10°C		kW	1,9	2,4	4,0
Input power heating	Nominal (Min - Max)	kW	0,79 (0,20 - 1,05)	1,05 (0,20 - 1,29)	1,60 (0,35 - 2,47)
Annual electricity consumption (heating) <sup>2)</sup>		kWh/a	700	884	1.436
<b>Indoor Unit</b>			<b>CS-KE25TKE</b>	<b>CS-KE35TKE</b>	<b>CS-KE50TKE</b>
Power source		V	230	230	230
Recommended fuse		A	16	16	16
Connection indoor / outdoor		mm <sup>2</sup>	4 x 1,5	4 x 1,5	4 x 1,5
Air volume	Cooling / Heating	m <sup>3</sup> /min	10,3 / 11,0	10,7 / 11,2	11,6 / 12,5
Moisture removal volume		L/h	1,5	2,0	2,8
Sound pressure <sup>3)</sup>	Cooling (Hi / Lo / Q-Lo)	dB(A)	37 / 26 / 20	38 / 30 / 20	44 / 37 / 34
	Heating (Hi / Lo / Q-Lo)	dB(A)	37 / 27 / 24	38 / 33 / 25	44 / 37 / 34
Dimensions / Net weight	H x W x D	mm / kg	290 x 850 x 199 / 8	290 x 850 x 199 / 8	290 x 870 x 214 / 9
<b>Outdoor Unit</b>			<b>CU-KE25TKE</b>	<b>CU-KE35TKE</b>	<b>CU-KE50TKE</b>
Air volume	Cooling / Heating	m <sup>3</sup> /min	30,5 / 30,5	31,1 / 31,1	32,7 / 32,7
Sound pressure <sup>3)</sup>	Cooling / Heating (Hi)	dB(A)	48 / 49	48 / 50	48 / 49
Dimensions <sup>4)</sup> / Net weight	H x W x D	mm / kg	542 x 780 x 289 / 26	542 x 780 x 289 / 29	619 x 824 x 299 / 38
Piping connections	Liquid pipe / Gas pipe	Inch (mm)	1/4 (6,35) / 3/8 (9,52)	1/4 (6,35) / 3/8 (9,52)	1/4 (6,35) / 1/2 (12,70)
Piping length range / Elevation difference (in/out) <sup>5)</sup>		m	3 - 15 / 15	3 - 15 / 15	3 - 15 / 15
Pipe length for additional gas / Additional gas amount		m / g/m	7,5 / 15	7,5 / 20	7,5 / 20
Refrigerant (R410A)		kg / TCO <sub>2</sub> Eq.	0,66 / 1,378	0,91 / 1,900	1,34 / 2,798
Operating range	Cooling Min - Max	°C	+5 ~ +43	+5 ~ +43	+5 ~ +43
	Heating Min - Max	°C	-15 ~ +24	-15 ~ +24	-15 ~ +24

Accessories	
<b>PA-AC-WIFI-1</b>	Full bidirectional Wifi interface for Internet control
<b>PAW-IR-WIFI-1</b>	IR Wifi interface for Internet control

Accessories	
<b>CZ-RD514C</b>	Wired remote controller for wall type
<b>CZ-CAPRA1</b>	H Generation interface to ECOi control integration

1) EER and COP classification is at 230V in accordance with EU directive 2002/31/EC. 2) The annual energy consumption is calculated in accordance with the ErP directive. 3) The Sound pressure of the units shows the value measured of a position 1m in front of the main body and 0,8m below the unit. The sound pressure is measured in accordance with Eurovent 6/C/006-97 specification. Q-Lo: The lowest fan speed. Lo: The second lowest fan speed (the lowest fan speed for KE50) 4) Add 70mm for piping port. 5) When installing the outdoor unit at a higher position than the indoor unit. \* Tentative data.



SEER and SCOP: For KIT-KE50-TKE. SUPER QUIET: For KIT-KE25-TKE and KIT-KE35-TKE. INTERNET CONTROL: Optional.



# WALL MOUNTED UZ TYPE STANDARD INVERTER • R32 GAS



New UZ series inverter powerful and efficient.



### Technical focus

- **NEW!** New design
- R32 gas environmental friendly
- PM2,5 Filter to create clean and comfort indoor quality
- Super Quiet! Only 20dB(A)
- High energy savings
- This units can be installed on R22 pipings
- Long connection distance
- Wired control (Optional)
- Smartphone control (Optional)



Kit*			KIT-UZ9-SKE	KIT-UZ12-SKE	KIT-UZ18-SKE	KIT-UZ60-TKE
Cooling capacity	Nominal (Min - Max)	kW	2,50 (0,85 - 3,00)	3,40 (0,85 - 3,90)	5,00 (0,98 - 5,40)	6,25 (0,98 - 7,10)
EER <sup>1)</sup>	Nominal (Min - Max)	W/W	3,68 (3,40 - 3,33) A	3,18 (3,33 - 3,05) B	3,03 (3,44 - 2,90) B	3,24 (3,50 - 2,96) A
<b>SEER</b>		<b>W/W</b>	<b>6,20</b> ◀A++	<b>6,10</b> ◀A++	<b>6,50</b> ◀A++	<b>6,20</b> ◀A++
Pdesign (cooling)		kW	2,5	3,4	5,0	6,3
Input power cooling	Nominal (Min - Max)	kW	0,68 (0,25 - 0,90)	1,07 (0,26 - 1,28)	1,65 (0,29 - 1,86)	1,93 (0,28 - 2,40)
Annual electricity consumption (cooling) <sup>2)</sup>		kWh/a	340	535	825	965
Heating capacity	Nominal (Min - Max)	kW	3,15 (0,80 - 3,60)	3,84 (0,80 - 4,40)	5,40 (0,98 - 7,50)	6,80 (0,98 - 8,50)
Heating capacity at -7°C		kW	2,14	2,60	4,58	5,24
COP <sup>1)</sup>	Nominal (Min - Max)	W/W	4,04 (4,10 - 3,46) A	3,66 (4,10 - 3,41) A	3,42 (2,80 - 3,06) B	3,51 (2,88 - 3,11) B
<b>SCOP</b>		<b>W/W</b>	<b>3,80</b> ◀A	<b>3,80</b> ◀A	<b>3,90</b> ◀A	<b>3,90</b> ◀A
Pdesign at -10°C		kW	1,9	2,4	4,0	4,6
Input power heating	Nominal (Min - Max)	kW	0,78 (0,20 - 1,04)	1,05 (0,20 - 1,29)	1,58 (0,35 - 2,45)	1,94 (0,34 - 2,73)
Annual electricity consumption (heating) <sup>2)</sup>		kWh/a	700	884	1.436	1.651
<b>Indoor Unit</b>			<b>CS-UZ9SKE</b>	<b>CS-UZ12SKE</b>	<b>CS-UZ18SKE</b>	<b>CS-UZ60TKE</b>
Power source		V	230	230	230	230
Recommended fuse		A	16	16	16	—
Connection indoor / outdoor		mm <sup>2</sup>	4 x 1,5	4 x 1,5	4 x 2,5	—
Air volume	Cooling / Heating	m <sup>3</sup> /min	10,3 / 11,0	10,7 / 11,2	11,3 / 12,0	16,9 / 18,7
Moisture removal volume		L/h	1,5	2,0	2,8	3,5
Sound pressure <sup>3)</sup>	Cooling (Hi / Lo / Q-Lo)	dB(A)	37 / 26 / 20	38 / 30 / 20	44 / 37 / 34	45 / 37 / 31
	Heating (Hi / Lo / Q-Lo)	dB(A)	37 / 27 / 24	38 / 33 / 25	44 / 37 / 34	45 / 37 / 34
Dimensions / Net weight	H x W x D	mm / kg	290 x 850 x 199 / 8	290 x 850 x 199 / 8	290 x 870 x 214 / 9	290 x 1.070 x 240 / 12
<b>Outdoor Unit</b>			<b>CU-UZ9SKE</b>	<b>CU-UZ12SKE</b>	<b>CU-UZ18SKE</b>	<b>CU-UZ60TKE</b>
Air volume	Cooling / Heating	m <sup>3</sup> /min	31,2 / 31,2	31,1 / 31,1	34,4 / 34,0	42,6 / 41,5
Sound pressure <sup>3)</sup>	Cooling / Heating (Hi)	dB(A)	48 / 49	48 / 50	48 / 49	49 / 49
Dimensions <sup>4)</sup> / Net weight	H x W x D	mm / kg	542 x 780 x 289 / 26	542 x 780 x 289 / 27	619 x 824 x 299 / 38	695 x 875 x 320 / 43
Piping connections	Liquid pipe / Gas pipe	Inch (mm)	1/4 (6,35) / 3/8 (9,52)	1/4 (6,35) / 3/8 (9,52)	1/4 (6,35) / 1/2 (12,70)	1/4 (6,35) / 1/2 (12,70)
Piping length range / Elevation difference (in/out)		m	3 - 15 / 15	3 - 15 / 15	3 - 15 / 15	3 - 30 / 15
Pipe length for additional gas / Additional gas amount		m / g/m	7,5 / 10	7,5 / 10	7,5 / 15	7,5 / 15
Refrigerant (R32)		kg / TCO <sub>2</sub> Eq.	0,58 / 0,392	0,67 / 0,452	1,14 / 0,770	1,15 / 0,776
Operating range	Cooling Min ~ Max	°C	+5 ~ +43	+5 ~ +43	+5 ~ +43	+5 ~ +43
	Heating Min ~ Max	°C	-15 ~ +24	-15 ~ +24	-15 ~ +24	-15 ~ +24

Accessories	
PA-AC-WIFI-1	Full bidirectional Wifi interface for Internet control
PAW-IR-WIFI-1	IR Wifi interface for Internet control

Accessories	
CZ-RD514C	Wired remote controller for wall type
CZ-CAPRA1	H Generation interface to ECOi control integration

1) EER and COP classification is at 230V in accordance with EU directive 2002/31/EC. 2) The annual energy consumption is calculated in accordance with the ErP directive. 3) The Sound pressure of the units shows the value measured of a position 1m in front of the main body and 0,8m below the unit. The sound pressure is measured in accordance with Eurovent 6/C/006-97 specification. Q-Lo: The lowest fan speed. Lo: The second lowest fan speed (the lowest fan speed for UZ18/60) 4) Add 70mm for piping port. 5) When installing the outdoor unit at a higher position than the indoor unit.



SEER and SCOP: For KIT-UZ18-SKE. SUPER QUIET: For KIT-UZ9-SKE and KIT-UZ12-SKE. INTERNET CONTROL: Optional.  
 Rating Conditions: Cooling Indoor 27°C DB / 19°C WB. Cooling Outdoor 35°C DB / 24°C WB. Heating Indoor 20°C DB. Heating Outdoor 7°C DB / 6°C WB. (DB: Dry Bulb; WB: Wet Bulb)  
 Specifications subject to change without notice. For detailed information about ErP, please visit our websites www.aircon.panasonic.eu or www.ptc.panasonic.eu.

# WALL MOUNTED PROFESSIONAL INVERTER -20°C • R410A GAS



Complete line-up with high efficiency even at -20°C.

This Wall Mounted air conditioner is especially designed for professional applications such as computer rooms where cooling inside the room is necessary even when the outside temperature is low. Furthermore this air conditioner has an automatic changeover system, in order to maintain the inside temperature even when sharp outside temperature changes occur.

### Technical focus

- This units can be installed on R22 pipings
- Designed for 24h/7d a week operation
- Highly efficient even at -20°C
- High durability rolling bearings
- Additional piping sensors to prevent freezing

Kit			KIT-E9-PKEA	KIT-E12-PKEA	KIT-E15-PKEA	KIT-E18-PKEA
Cooling capacity	Nominal (Min - Max)	kW	2,50 (0,85 - 3,00)	3,50 (0,85 - 4,00)	4,20 (0,98 - 5,00)	5,00 (0,98 - 6,00)
EER <sup>1)</sup>	Nominal (Min - Max)	W/W	4,85 (4,23 - 5,00) A	4,02 (3,57 - 5,00) A	3,50 (3,50 - 3,16) A	3,47 (3,50 - 3,02) A
Cooling capacity at -10°C / -20°C		kW	2,63 / 2,61	3,69 / 3,66	5,04 / 4,06	6,00 / 5,82
EER at -10°C / -20°C		W/W	7,19 / 6,71	5,96 / 5,56	6,01 / 4,39	6,00 / 5,39
<b>SEER<sup>2)</sup></b>		<b>W/W</b>	<b>7,10</b> <b>A++</b>	<b>6,70</b> <b>A++</b>	<b>6,30</b> <b>A++</b>	<b>6,90</b> <b>A++</b>
Pdesign		kW	2,5	3,5	4,2	5,0
Input power cooling	Nominal (Min - Max)	kW	0,52 (0,17 - 0,71)	0,87 (0,17 - 1,12)	1,20 (0,28 - 1,58)	1,44 (0,28 - 1,99)
Annual electricity consumption (cooling) <sup>3)</sup>		kWh/a	123	183	233	254
Heating capacity	Nominal (Min - Max)	kW	3,40 (0,85 - 5,40)	4,00 (0,85 - 6,60)	5,40 (0,98 - 7,10)	5,80 (0,98 - 8,00)
Heating capacity at -7°C <sup>4)</sup>		kW	3,33	4,07	4,10	4,98
COP <sup>1)</sup>	Nominal (Min - Max)	W/W	4,86 (4,12 - 5,15) A	4,35 (3,63 - 5,15) A	3,75 (2,88 - 3,24) A	3,82 (2,88 - 3,11) A
<b>SCOP<sup>5)</sup></b>		<b>W/W</b>	<b>4,40</b> <b>A+</b>	<b>4,10</b> <b>A+</b>	<b>3,90</b> <b>A</b>	<b>4,20</b> <b>A+</b>
Pdesign at -10°C		kW	2,8	3,6	3,6	4,4
Input power heating	Nominal (Min - Max)	kW	0,70 (0,17 - 1,31)	0,92 (0,17 - 1,82)	1,44 (0,34 - 2,19)	1,52 (0,34 - 2,57)
Annual electricity consumption (heating) <sup>3)</sup>		kWh/a	891	1,229	1,292	1,467
<b>Indoor Unit</b>			<b>CS-E9PKEA</b>	<b>CS-E12PKEA</b>	<b>CS-E15PKEA</b>	<b>CS-E18PKEA</b>
Power source		V	230	230	230	230
Recommended fuse		A	16	16	16	16
Connection indoor / outdoor		mm	4 x 1,5	4 x 1,5	4 x 1,5	4 x 2,5
Air Volume	Cooling / Heating	m <sup>3</sup> /min	13,3 / 14,6	13,6 / 14,7	14,1 / 15,0	17,9 / 19,3
Moisture removal volume		L/h	1,5	2,0	2,4	2,8
Sound pressure <sup>6)</sup>	Cooling — Heating (Hi / Lo / S-Lo)	dB(A)	39 / 26 / 23 — 40 / 27 / 24	42 / 29 / 26 — 42 / 33 / 29	43 / 32 / 29 — 43 / 35 / 29	44 / 37 / 34 — 44 / 37 / 34
Dimensions / Net weight	H x W x D	mm / kg	295 x 870 x 255 / 10	295 x 870 x 255 / 10	295 x 870 x 255 / 10	295 x 1.070 x 255 / 13
<b>Outdoor Unit</b>			<b>CU-E9PKEA</b>	<b>CU-E12PKEA</b>	<b>CU-E15PKEA</b>	<b>CU-E18PKEA</b>
Sound pressure <sup>6)</sup>	Cooling / Heating (Hi)	dB(A)	46 / 47	48 / 50	46 / 46	47 / 47
Dimensions <sup>7)</sup> / Net weight	H x W x D	mm / kg	622 x 824 x 299 / 36	622 x 824 x 299 / 36	695 x 875 x 320 / 45	695 x 875 x 320 / 46
Piping connections	Liquid pipe / Gas pipe	Inch (mm)	1/4 (6,35) / 3/8 (9,52)	1/4 (6,35) / 3/8 (9,52)	1/4 (6,35) / 1/2 (12,70)	1/4 (6,35) / 1/2 (12,70)
Piping length range / Elevation difference (in/out) <sup>8)</sup>		m	3 - 15 / 5	3 - 15 / 5	3 - 15 / 15	3 - 20 / 15
Pipe length for additional gas / Additional gas amount		m / g/m	7,5 / 20	7,5 / 20	7,5 / 20	7,5 / 20
Operating range	Cooling / Heating Min - Max	°C	-20 ~ +43 / -15 ~ +24	-20 ~ +43 / -15 ~ +24	-20 ~ +43 / -15 ~ +24	-20 ~ +43 / -15 ~ +24

### Accessories

<b>PAW-GRDSTD40</b>	Outdoor elevation platform
<b>PAW-WTRAY</b>	Tray for condenser water compatible with base ground support

### Accessories

<b>PAW-GRDBSE20</b>	Outdoor base ground support for noise and vibration absorption
<b>PAW-SERVER-PKEA</b>	PCB for installation in server rooms with security
<b>CZ-CAPRA1</b>	H Generation interface to ECOi control integration

Rating Conditions for cooling capacity at low temperature: Cooling Indoor 27°C DB / 19°C WB. Cooling Outdoor 0°C DB / -10°C WB. 1) EER and COP, Energy Saving Classification, is at 220 / 240 V (380 / 415 V) only in accordance with EU directive 2002/31/EC. 2) SEER is calculated in base Eurovent IPLV for SBEM for U1 indoor unit SEER=a(EER25)+b(EER50)+c(EER75)+d(EER100) where EER25, EER50, EER75 and EER100 are the EER measured value at 25%, 50%, 75% and 100% part load for temperatures 20, 25, 30 and 35°C DB, respectively. a, b, c and d are values assigned for an office type. These values are given as a=0,2, b=0,36, c=0,32 and d=0,03. The internal temperatures are taken at 27°C DB and 19°C WB. 3) The annual consumption (ErP) is calculated by formula determined by ErP regulation. 4) Heating capacity is calculated including defrost factor correction. 5) SCOP is calculated in base Eurovent IPLV for SBEM with U1 indoor unit including defrost correction factor. 6) The Sound pressure level of the units shows the value measured at a position 1 meter in front of the main body and 1,5m from the ground. The sound pressure is measured in accordance with Eurovent 6/C/006-97 specification. 7) Add 70mm for piping port. 8) When installing the outdoor unit at a higher position than the indoor unit. // Recommended fuse for the indoor 3A.



A++  
7,10 SEER

A+  
4,40 SCOP

INVERTER+

R2 ROTARY COMPRESSOR

23dB(A)  
SUPER QUIET

-20°C  
COOLING MODE

-15°C  
HEATING MODE

R22 RENEWAL  
R22 R410A

INTEGRATION P-LINE

INTERNET CONTROL

BMS CONNECTIVITY

5 YEARS WARRANTY

SEER and SCOP: For KIT-Z25-TKEA. SUPER QUIET: For KIT-Z25-TKEA. INTERNET CONTROL: Optional.



# MORE FOR YOUR HOME



# FLOOR CONSOLE TYPE INVERTER+

## • R410A GAS



Console designed for discreet integration on walls, and for high performance, specifically in heat mode even when the outside temperature is as low as -15°C.

Double airflow for improved comfort and temperature dispersion: through the top for an efficient cooling mode, through the bottom for quick heating.

### Technical focus

- This units can be installed on R22 pipings
- More efficient than ever for improved energy consumption and higher savings
- Heating mode down to -15°C with high efficiency
- Double airflow for better efficiency
- Powerful mode for quick temperature setting
- R410A refrigerant gas

Kit			KIT-E9-PFE	KIT-E12-PFE	KIT-E18-PFE
Cooling capacity	Nominal (Min - Max)	kW	2,50 (0,85 - 3,00)	3,50 (0,85 - 3,80)	5,00 (0,98 - 5,60)
EER <sup>1)</sup>		W/W	4,50 A	3,72 A	3,25 A
<b>SEER</b>		<b>W/W</b>	<b>6,10</b> <b>A++</b>	<b>5,80</b> <b>A++</b>	<b>6,20</b> <b>A++</b>
Pdesign (cooling)		kW	<b>2,50</b>	<b>3,50</b>	<b>5,00</b>
Input power cooling		kW	0,56	0,94	1,54
Annual electricity consumption (cooling) <sup>2)</sup>		kWh/a	143	211	282
Heating capacity	Nominal (Min - Max)	kW	3,40 (0,85 - 5,00)	4,00 (0,85 - 6,00)	5,80 (0,98 - 7,10)
Heating capacity at -7°C		kW	2,35	2,86	3,87
COP <sup>1)</sup>		W/W	4,20 A	4,00 A	3,63 A
<b>SCOP</b>		<b>W/W</b>	<b>3,80</b> <b>A</b>	<b>3,80</b> <b>A</b>	<b>3,90</b> <b>A</b>
Pdesign at -10°C		kW	<b>2,7</b>	<b>3,2</b>	<b>4,4</b>
Input power heating		kW	0,81	1,00	1,60
Annual electricity consumption (heating) <sup>2)</sup>		kWh/a	995	1.179	1.579
<b>Indoor Unit</b>			<b>CS-E9GFEW</b>	<b>CS-E12GFEW</b>	<b>CS-E18GFEW</b>
Recommended fuse		A	16	16	16
Connection		mm <sup>2</sup>	3 x 1,5	3 x 1,5	3 x 2,5
Air volume	Cooling / Heating	m <sup>3</sup> /min	9,3 / 9,6	9,5 / 10,0	11,0 / 13,0
Moisture removal volume		L/h	1,4	2,0	2,8
Sound pressure <sup>3)</sup>	Cooling (Hi / Lo / Q-Lo)	dB(A)	38 / 27 / 23	39 / 28 / 24	44 / 36 / 32
	Heating (Hi / Lo / Q-Lo)	dB(A)	38 / 27 / 23	39 / 27 / 23	46 / 36 / 32
Dimensions / Net weight	H x W x D	mm / kg	600 x 700 x 210 / 14	600 x 700 x 210 / 14	600 x 700 x 210 / 14
<b>Outdoor Unit</b>			<b>CU-E9PFE</b>	<b>CU-E12PFE</b>	<b>CU-E18PFE</b>
Power source		V	230	230	230
Sound pressure <sup>3)</sup>	Cooling / Heating (Hi)	dB(A)	46 / 47	48 / 50	47 / 48
Dimensions <sup>4)</sup> / Net weight	H x W x D	mm / kg	542 x 780 x 289 / 33	619 x 824 x 299 / 34	695 x 875 x 320 / 46
Piping connections	Liquid pipe / Gas pipe	Inch (mm)	1/4 (6,35) / 3/8 (9,52)	1/4 (6,35) / 3/8 (9,52)	1/4 (6,35) / 1/2 (12,70)
Piping length range / Elevation difference (in/out)		m	3 - 15 / 5	3 - 15 / 5	3 - 20 / 15
Pipe length for additional gas / Additional gas amount		m / g/m	7,5 / 20	7,5 / 20	7,5 / 20
Refrigerant (R410A)		kg / TCO: Eq.	0,97 / 2,025	1,00 / 2,088	1,12 / 2,339
Operating range	Cooling Min - Max	°C	+16 ~ +43	+16 ~ +43	+16 ~ +43
	Heating Min - Max	°C	-15 ~ +24	-15 ~ +24	-15 ~ +24

### Accessories

<b>PAW-IR-WIFI-1</b>	IR Wifi interface for Internet control
----------------------	--

1) EER and COP classification is at 230 V in accordance with EU directive 2002/31/EC. 2) The annual energy consumption is calculated in accordance with the ErP directive. 3) The Sound pressure level of the units shows the value measured of a position 1 metre in front of the main body and 1 m below the unit. The sound pressure is measured in accordance with Eurovent 6/C/006-97 specification. 4) Add 70mm for piping port.



SEER and SCOP: For KIT-E18-PFE. SUPER QUIET: For KIT-E9-PFE. INTERNET CONTROL: Optional.

## 4 WAY 60x60 CASSETTE STANDARD INVERTER • R410A GAS

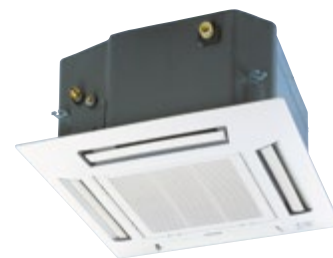

Specially designed for offices, retail and restaurant applications, this cassette fits perfectly into 60x60 or 70x70 ceiling grids.

Featuring the best efficiency in its category (heating and cooling up to -10°C, this new cassette in 9 and 12kW versions can also be connected to KNX, Modbus, EnOcean interfaces for easy integration with your BMS systems. Interfaces have dry contacts (ON/OFF, error message) to enable easy integration.

With the new IntesisHome interface, you can also control the cassette from your smartphone and internet very easily!

Fit Panasonic's Cassette Type, and start to save all year round!

### Technical focus

- Cassettes can be controlled by IntesisHome, KNX, EnOcean and Modbus
- This units can be installed on R22 pipingss
- Designed for easy installation in the standard European 60x60 ceiling grid
- Operation down to -10°C in cooling and heating modes
- Piping length up to 30m
- Maximum elevation difference up to 20m
- Ultra compact outdoor units for easy installation
- High pressure selector in case of high ceilings (higher than 2,7m)
- Drain pump included (maximum 750mm high)
- Air fresh entry available on the cassette

KIT			KIT-E9-PB4EA	KIT-E12-PB4EA	KIT-E18-RB4EA	KIT-E21-RB4EA
Cooling capacity	Nominal (Min - Max)	kW	2,50 (0,85 - 3,00)	3,40 (0,85 - 4,00)	5,00 (0,90 - 5,80)	5,90 (0,90 - 6,30)
EER <sup>1)</sup>	Nominal (Min - Max)	W/W	4,55 (3,54 - 4,05) A	3,82 (3,54 - 3,33) A	3,13 (3,53 - 2,97) B	2,88 (3,53 - 2,86) C
<b>SEER</b>		<b>W/W</b>	<b>5,80</b> <b>A+</b>	<b>5,60</b> <b>A+</b>	<b>5,80</b> <b>A+</b>	<b>5,60</b> <b>A+</b>
Pdesign (cooling)		kW	2,50	3,40	5,00	5,90
Input power cooling	Nominal (Min - Max)	kW	0,55 (0,24 - 0,74)	0,89 (0,24 - 1,20)	1,60 (0,26 - 1,95)	2,05 (0,26 - 2,20)
Annual electricity consumption (cooling) <sup>2)</sup>		kWh/a	151	213	302	369
Heating capacity	Nominal (Min - Max)	kW	3,20 (0,85 - 4,80)	4,50 (0,85 - 5,60)	5,60 (0,90 - 7,10)	7,00 (0,90 - 8,00)
Heating capacity at -7°C		kW	2,60	3,00		
COP <sup>1)</sup>	Nominal (Min - Max)	W/W	4,00 (3,70 - 3,56) A	3,17 (3,7 - 2,80) D	3,01 (3,46 - 2,92) D	2,86 (3,46 - 2,84) D
<b>SCOP</b>		<b>W/W</b>	<b>4,00</b> <b>A+</b>	<b>3,80</b> <b>A</b>	<b>4,10</b> <b>A+</b>	<b>4,10</b> <b>A+</b>
Pdesign at -10°C		kW	2,70	3,00	3,80	4,00
Input power heating	Nominal (Min - Max)	kW	0,80 (0,23 - 1,35)	1,42 (0,23 - 2,00)	1,86 (0,26 - 2,43)	2,45 (0,26 - 2,82)
Annual electricity consumption (heating) <sup>2)</sup>		kWh/a	945	1.105	1.298	1.366
<b>Indoor Unit</b>			<b>CS-E9PB4EA</b>	<b>CS-E12PB4EA</b>	<b>CS-E18RB4EAW</b>	<b>CS-E21RB4EAW</b>
Power source		V	230	230	230	230
Recommended fuse		A	16	16	16	16
Connection		mm <sup>2</sup>	4 x 1,5 to 2,5	4 x 1,5 to 2,5	4 x 1,5 to 2,5	4 x 1,5 to 2,5
Air volume	Cooling / Heating	m <sup>3</sup> /min	10,5 / 10,8	10,5 / 10,8	11,5 / 11,8	12,4 / 14,6
Moisture removal volume		L/h	1,5	2,3	2,8	3,3
Sound pressure <sup>3)</sup>	Cooling (Hi / Lo / O-Lo)	dB(A)	34 / 26 / 23	34 / 26 / 23	37 / 28 / 25	42 / 33 / 30
	Heating (Hi / Lo / O-Lo)	dB(A)	35 / 28 / 25	35 / 28 / 25	38 / 29 / 26	43 / 34 / 31
Dimensions (H x W x D)	Indoor / Panel	mm	260 x 575 x 575 / 51 x 700 x 700	260 x 575 x 575 / 51 x 700 x 700	260 x 575 x 575 / 51 x 700 x 700	260 x 575 x 575 / 51 x 700 x 700
Net weight	Indoor / Panel	kg	18 / 2,5	18 / 2,5	18 / 2,5	18 / 2,5
<b>Outdoor Unit</b>			<b>CU-E9PB4EA</b>	<b>CU-E12PB4EA</b>	<b>CU-E18RBEA</b>	<b>CU-E21RBEA</b>
Sound pressure <sup>3)</sup>	Cooling / Heating (Hi)	dB(A)	45 / 46	45 / 47	47 / 48	49 / 50
Dimensions <sup>4)</sup> / Net weight	H x W x D	mm / kg	622 x 824 x 299 / 36	695 x 875 x 320 / 45	695 x 875 x 320 / 47	695 x 875 x 320 / 47
Piping connections	Liquid pipe / Gas pipe	Inch (mm)	1/4 (6,35) / 3/8 (9,52)	1/4 (6,35) / 3/8 (9,52)	1/4 (6,35) / 1/2 (12,70)	1/4 (6,35) / 1/2 (12,70)
Piping length range / Elevation difference (in/out)		m	3 - 20 / 15	3 - 20 / 15	3 - 30 / 20	3 - 30 / 20
Pipe length for additional gas / Additional gas amount		m / g/m	10 / 20	10 / 20	10 / 20	10 / 20
Operating range	Cooling Min ~ Max	°C	-10 ~ +43	-10 ~ +43	-10 ~ +43	-10 ~ +43
	Heating Min ~ Max	°C	-10 ~ +24	-10 ~ +24	-10 ~ +24	-10 ~ +24

### Accessories

<b>PA-AC-WIFI-1</b>	Full bidirectional Wifi interface for Internet control
<b>PAW-IR-WIFI-1</b>	IR Wifi interface for Internet control

### Accessories

<b>CZ-RD514C</b>	Wired remote controller for wall type
<b>CZ-CAPRA1</b>	H Generation interface to ECOi control integration

1) EER and COP classification is at 230 V in accordance with EU directive 2002/31/EC. 2) The annual energy consumption is calculated in accordance with the ErP directive. 3) The Sound pressure level of the units shows the value measured of a position 1 metre in front of the main body and 1,5m below the ceiling in the centre of the unit. The sound pressure is measured in accordance with Eurovent 6/C/006-97 specification. 4) Add 70mm for piping port.

CU-E9PB4EA

CU-E12PB4EA

CU-E18RBEA

CU-E21RBEA

Included

Optional wired remote controller CZ-RD514C

Panel CZ-BT20E

A+

A+

INVERTER

R2 ROTARY COMPRESSOR

23dB(A) SUPER QUIET

-10°C COOLING MODE

-10°C HEATING MODE

R22 RENEWAL

R22 R410A

INTEGRATION P-LINE

INTERNET CONTROL

BMS CONNECTIVITY

5 YEARS WARRANTY

SEER and SCOP: For KIT-E18-RB4EA. SUPER QUIET: For KIT-E9-PB4EA and KIT-E12-PB4EA. INTERNET CONTROL and INTEGRATION P-LINE: Optional.

# LOW STATIC PRESSURE HIDE AWAY STANDARD INVERTER • R410A GAS



Designed for homes, offices, retail and restaurants, this duct is ideal for small rooms where the air conditioning and the heating should be nicely integrated and where high comfort and efficiency is needed.

The 9 and 12kW duct can also be connected to KNX, Modbus, EnOcean interfaces for easy integration with your BMS systems. This interfaces have dry contacts (ON/OFF, error message) for easy integration. With the new IntesisHome interface, you can control the Duct also from your smartphone and internet very easily!

### Technical focus

- Duct type can be controlled by IntesisHome, KNX, EnOcean and Modbus
- This units can be installed on R22 pipingss
- Eco mode for 20% energy saving
- Extremely compact indoor units without losing static pressure (only 235mm high)
- Weekly timer, 42 settings per week
- Easy check mode for failure detection
- Drain pump included (maximum 200mm)

KIT			KIT-E9-PD3EA	KIT-E12-QD3EA	KIT-E18-RD3EA
Cooling capacity	Nominal (Min - Max)	kW	2,50 (0,85 - 3,00)	3,40 (0,85 - 4,00)	5,10 (0,90 - 5,70)
EER <sup>1)</sup>		W/W	4,24 (3,54 - 3,95) A	3,86 (3,54 - 3,45) A	3,19 (3,53 - 3,13) B
SEER		W/W	5,80 <b>A+</b>	5,60 <b>A</b>	5,80 <b>A+</b>
Pdesign (cooling)		kW	2,50	3,40	5,10
Input power cooling	Nominal (Min - Max)	kW	0,59 (0,24 - 0,76)	0,88 (0,24 - 1,16)	1,60 (0,26 - 1,82)
Annual electricity consumption (cooling) <sup>2)</sup>		kWh/a	151	213	308
Heating capacity	Nominal (Min - Max)	kW	3,20 (0,85 - 4,60)	4,00 (0,85 - 5,10)	6,10 (0,90 - 7,10)
Heating capacity at -7°C		kW	2,60	3,00	4,30
COP <sup>1)</sup>		W/W	3,72 (3,7 - 3,33) A	3,54 (3,7 - 3,29) B	3,33 (3,46 - 3,26) C
SCOP		W/W	4,20 <b>A+</b>	3,80 <b>A</b>	3,90 <b>A</b>
Pdesign at -10°C		kW	2,60	2,90	4,00
Input power heating	Nominal (Min - Max)	kW	0,86 (0,23 - 1,38)	1,13 (0,23 - 1,55)	1,83 (0,26 - 2,18)
Annual electricity consumption (heating) <sup>2)</sup>		kWh/a	867	1.068	1.436
<b>Indoor Unit</b>			<b>CS-E9PD3EA</b>	<b>CS-E12QD3EAW</b>	<b>CS-E18RD3EAW</b>
Power source		V	230	230	230
Recommended fuse		A	16	16	16
Connection		mm <sup>2</sup>	4 x 1,5 to 2,5	4 x 1,5 to 2,5	4 x 1,5 to 2,5
External static pressure <sup>3)</sup>	S-Hi / Hi / Me / Lo	Pa	N/A	N/A	N/A
Air volume	Cooling / Heating	m <sup>3</sup> /min	6,9 / 8,1	9,3 / 10,4	15,3 / 15,3
Moisture removal volume		L/h	1,50	2,30	2,80
Sound pressure <sup>4)</sup>	Cooling (Hi / Lo / Q-Lo)	dB(A)	33 / 27 / 24	34 / 27 / 24	41 / 30 / 27
	Heating (Hi / Lo / Q-Lo)	dB(A)	35 / 28 / 25	36 / 28 / 25	41 / 32 / 29
Dimensions	H x W x D	mm	235 x 750 x 370	235 x 750 x 370	200 x 750 x 640
Net weight		kg	17	17	19
<b>Outdoor Unit</b>			<b>CU-E9PD3EA</b>	<b>CU-E12QD3EA</b>	<b>CU-E18RBEA</b>
Sound pressure <sup>4)</sup>	Cooling / Heating (Hi)	dB(A)	47 / 47	47 / 48	47 / 48
Dimensions <sup>5)</sup>	H x W x D	mm	622 x 824 x 299	695 x 875 x 320	695 x 875 x 320
Net weight		kg	36	45	47
Piping connections	Liquid pipe / Gas pipe	Inch (mm)	1/4 (6,35) / 3/8 (9,52)	1/4 (6,35) / 3/8 (9,52)	1/4 (6,35) / 1/2 (12,70)
Piping length range / Elevation difference (in/out)		m	3 - 20 / 15	3 - 20 / 15	3 - 30 / 20
Pipe length for additional gas / Additional gas amount		m / g/m	7,5 / 20	7,5 / 20	10 / 20
Operating range	Cooling Min - Max	°C	-10 - +43	-10 - +43	-10 - +43
	Heating Min - Max	°C	-10 - +24	-10 - +24	-10 - +24

Accessories	
PA-AC-WIFI-1	Full bidirectional Wifi interface for Internet control
PAW-IR-WIFI-1	IR Wifi interface for Internet control

Accessories	
CZ-CAPRA1	H Generation interface to ECOi control integration

1) EER and COP classification is at 230 V in accordance with EU directive 2002/31/EC. 2) The annual energy consumption is calculated in accordance with the ErP directive. 3) The specification listed on the table indicates values under the condition of 29 Pa (3,0 mmAq) which are applied for factory default setting. Change switch on PCB from Hi to Shi to have more than 6,0 mmAq. 4) The Sound pressure level of the units shows the value measured of a position of 1,5m below the unit with 1 m duct on the suction side and 2 m duct on the discharge side. The sound pressure is measured in accordance with Eurovent 6/C/006-97 specification. 5) Add 100 mm for indoor unit or 70mm for outdoor unit for piping port.



A+  
5,80 SEER

A+  
4,80 SCOP

INVERTER

R2 ROTARY  
COMPRESSOR

UP TO 7mmAq  
STATIC PRESSURE

-10°C  
COOLING MODE

-10°C  
HEATING MODE

R22  
R410A  
R32 RENEWAL

INTEGRATION P-LINE

INTERNET CONTROL

BMS  
CONNECTIVITY

5 YEARS  
LIMITED WARRANTY

SEER and SCOP: For KIT-E9-PD3EA. INTERNET CONTROL and INTEGRATION P-LINE: Optional.

Rating Conditions: Cooling Indoor 27°C DB / 19°C WB. Cooling Outdoor 35°C DB / 24°C WB. Heating Indoor 20°C DB. Heating Outdoor 7°C DB / 6°C WB. (DB: Dry Bulb; WB: Wet Bulb) Specifications subject to change without notice. For detailed information about ErP, please visit our websites [www.aircon.panasonic.eu](http://www.aircon.panasonic.eu) or [www.plc.panasonic.eu](http://www.plc.panasonic.eu).



# MULTI SPLIT SYSTEM



## Panasonic offers widest range in Multi split systems

3 types of Multi split range from 3,5 to 10kW for 5 indoor units with one outdoor unit.

New Multi Z with R32	Multi E with R410A	Multi RE Compact Style
Full flexibility up to 10kW and up to 5 ports with wide range of indoor units including high performance Etherea indoor units, reaching up to A+++/A++ and using new generation refrigerant R32	Full flexibility up to 10kW and up to 5 ports with wide range of indoor units including high performance Etherea indoor units, reaching up to A++/A+	From 4,4 to 5,2kW for wall Compact Style unit (TZ/TE), reaches A++/A+

Line up	Refrigerant	Capacities	Indoor Unit ports	Efficiency up to	Indoor units				
					Etherea	Compact Style	Duct	Cassette	Floor Console
Multi Z	R32	8 units (3,5 ~ 10kW)	2-5	A+++/A++	Yes	Yes	Yes	Yes	
Multi E	R410A	8 units (3,5 ~ 10kW)	2-5	A++/A+	Yes	Yes	Yes	Yes	Yes
Multi RE	R410A	3 units (4,4 ~ 5,2kW)	2-3	A++/A+		Yes			

## Multi split systems

Day & Night	Simultaneous
Ideal for 2 day and night areas. Simultaneous use possible.	When indoor units are most time working at same time.



**Why a Multi Split is better than several separate split units**

**Up to 5 indoor units with a single outdoor unit.**

- Just one compact outdoor unit
- Increased comfort in the house since every room has its own indoor unit for heating

- Much more powerful than a single split
- More efficient since the units are always operating at full capacity
- You can connect all types of indoor units, such as wall types and consoles, depending on what suits your house best

**Solution with single split.**

One indoor unit is connected to one outdoor unit. The indoor unit is placed in the main hallway and heats the entire house. Certain rooms may not be perfectly heated, which causes inadequate comfort.

**Solution with Multi Split.**

With one outdoor unit, you can connect up to five indoor units. There is one indoor unit per room or area. It gives an extreme increase in comfort levels. On the roof, there is only one outdoor unit.

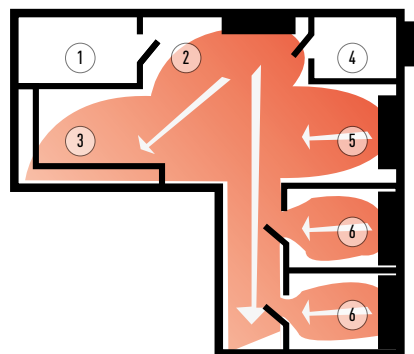
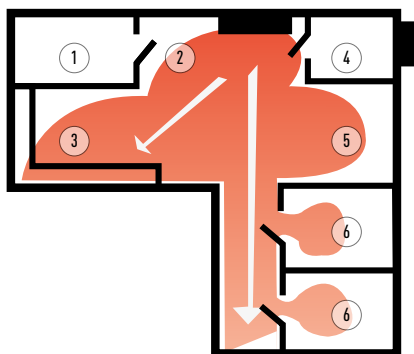

1. Laundry room
2. Entrance
3. Kitchen/dining area
4. Bathroom
5. Living room
6. Bedroom

# FREE MULTI SYSTEM E • R410A GAS

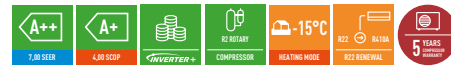

## Outdoor Unit Free Multi System E • R410A GAS

System Capacity (Min - Max Indoor Cooling Capacity Nominal)			3,2 to 5,7kW	3,2 to 5,7kW	3,2 to 7,5kW	4,5 to 9,0kW	4,5 to 11,0kW	4,5 to 11,0kW	4,5 to 13,6kW	4,5 to 17,5kW
Unit			CU-2E12SBE	CU-2E15SBE	CU-2E18SBE	CU-3E18PBE	CU-3E23SBE	CU-4E23PBE	CU-4E27PBE	CU-5E34PBE
Cooling capacity	Nominal (Min - Max)	kW	3,60 (1,50 - 4,50)	4,50 (1,50 - 5,20)	5,20 (1,50 - 5,40)	5,20 (1,80 - 7,30)	6,80 (1,90 - 8,00)	6,80 (1,90 - 8,00)	8,00 (3,00 - 9,20)	10,00 (2,90 - 11,50)
EER <sup>1)</sup>		W/W	4,50 (6,00 - 4,09)	3,66 (6,00 - 3,42)	3,42 (6,00 - 3,42)	4,33 (5,00 - 3,24)	3,56 (7,04 - 3,38)	4,05 (5,59 - 3,56)	4,04 (5,66 - 3,21) A	3,5 (5,27 - 2,98) A
<b>SEER</b>		<b>W/W</b>	<b>6,50 A++</b>	<b>6,50 A++</b>	<b>6,50 A++</b>	<b>7,00 A++</b>	<b>7,00 A++</b>	<b>7,00 A++</b>	<b>7,00 A++</b>	<b>6,50 A++</b>
Pdesign (cooling)		kW	3,6	4,5	5,2	5,2	6,8	6,8	8,0	10,0
Input power cooling	Nominal (Min - Max)	kW	0,80 (0,25 - 1,10)	1,23 (0,25 - 1,52)	1,52 (0,25 - 1,58)	1,27 (0,36 - 2,25)	1,91 (0,27 - 2,37)	1,68 (0,34 - 2,47)	1,98 (0,53 - 2,87)	2,86 (0,55 - 3,86)
Annual electricity consumption (cooling) <sup>2)</sup>		kWh/a	194	242	280	260	955	340	400	538
Heating capacity	Nominal (Min - Max)	kW	4,40 (1,10 - 5,60)	5,40 (1,10 - 7,00)	5,60 (1,10 - 7,20)	6,80 (1,60 - 8,30)	8,50 (3,30 - 10,40)	8,50 (3,00 - 10,40)	9,40 (4,20 - 10,60)	12,00 (3,40 - 14,50)
Heating capacity at -7°C		kW	3,54	3,54	3,65	4,90	6,05	6,05	7,08	8,85
COP <sup>3)</sup>		W/W	4,63 (5,24 - 4,41)	4,62 (5,24 - 4,19)	4,63 (5,24 - 4,24)	4,69 (3,93 - 5,00)	4,07 (5,32 - 3,74)	4,47 (4,08 - 5,17)	4,52 (6,00 - 3,46) A	4,20 (6,42 - 3,42) A
<b>SCOP</b>		<b>W/W</b>	<b>4,00 A+</b>	<b>4,00 A+</b>	<b>4,00 A+</b>	<b>4,00 A+</b>	<b>4,00 A+</b>	<b>4,00 A+</b>	<b>4,00 A+</b>	<b>4,00 A+</b>
Pdesign at -10°C		kW	4,0	4,0	4,2	4,8	5,2	5,5	8,0	10,0
Input power heating	Nominal (Min - Max)	kW	0,95 (0,21 - 1,27)	1,17 (0,21 - 1,67)	1,21 (0,21 - 1,70)	1,41 (0,32 - 2,18)	2,09 (0,62 - 2,78)	1,85 (0,58 - 2,60)	2,08 (0,70 - 3,06)	2,86 (0,53 - 4,24)
Annual electricity consumption (heating) <sup>2)</sup>		kWh/a	1.400	1.400	1.470	1.680	1.820	1.925	2.800	3.500
Current	Cooling / Heating	A	3,75 / 4,20	5,75 / 5,20	7,10 / 5,35	5,30 / 6,70	8,40 / 9,60	7,50 / 8,80	9,40 / 9,80	13,20 / 13,40
Power source		V	230	230	230	230	230	230	230	230
Recommended fuse		A	16	16	16	16	16	20	20	25
Recommended power cable section		mm <sup>2</sup>	2,5	2,5	2,5	2,5	2,5	2,5	2,5	3,5
Sound pressure <sup>3)</sup>	Cooling / Heating (Hi)	dB(A)	47 / 49	47 / 49	49 / 51	46 / 47	50 / 51	50 / 51	51 / 52	53 / 54
Dimensions <sup>4)</sup>	H x W x D	mm	619 x 824 x 299	619 x 824 x 299	619 x 824 x 229	795 x 875 x 320	795 x 875 x 320	795 x 875 x 320	999 x 940 x 340	999 x 940 x 340
Net weight		kg	39	39	39	71	71	72	80	81
Piping connections	Liquid pipe	Inch (mm)	1/4 (6,35)	1/4 (6,35)	1/4 (6,35)	1/4 (6,35)	1/4 (6,35)	1/4 (6,35)	1/4 (6,35)	1/4 (6,35)
	Gas pipe	Inch (mm)	3/8 (9,52)	3/8 (9,52)	3/8 (9,52)	3/8 (9,52)	3/8 (9,52)	3/8 (9,52)	3/8 (9,52)	3/8 (9,52)
Elevation difference (in/out)	Max	m	10	10	10	15	15	15	15	15
Piping length total	Min - Max	m	3 - 30	3 - 30	3 - 30	3 - 50	- - 60	- - 60	- - 80	- - 80
Piping length to one unit	Min - Max	m	3 - 20	3 - 20	3 - 20	3 - 25	3 - 25	3 - 25	3 - 25	3 - 25
Pipe length for additional gas / Additional gas amount	m / g/m		20 / 15	20 / 15	20 / 15	30 / 20	30 / 20	30 / 20	45 / 20	45 / 20
Operating range	Cooling Min - Max	°C	-10 - +46	-10 - +46	-10 - +46	-10 - +46	-10 - +46	-10 - +46	-10 - +46	-10 - +46
	Heating Min - Max	°C	-15 - +24	-15 - +24	-15 - +24	-15 - +24	-15 - +24	-15 - +24	-15 - +24	-15 - +24

1) EER and COP classification is at 230V in accordance with EU directive 2002/31/EC. 2) The annual energy consumption is calculated in accordance with the ErP directive. 3) The Sound pressure of the units shows the value measured of a position 1m in front of the main body and 0,8m below the unit. The sound pressure is measured in accordance with Eurovent 6/C/006-97 specification. 4) Add 70 or 95mm for piping port. Minimum quantity of connection: 2 indoor units.

## Possible outdoor / indoor units combinations • R410A GAS

	Etherea Silver							Etherea Pure White Matt							Wall Mounted TZ / TE Compact Style							Floor Console							Low Static Pressure Hide Away							4 Way 60x60 Cassette												
	16	20	25	35	42	50	60	71	16	20	25	35	42	50	60	71	16	20	25	35	42	50	60	71	16	20	25	35	42	50	60	71	16	20	25	35	42	50	60	71	16	20	25	35	42	50	60	71
CU-2E12SBE // 3,2 - 5,7kW // 2 Rooms	✓	✓	✓						✓	✓	✓						✓	✓	✓						✓	✓							✓	✓							✓	✓						
CU-2E15SBE // 3,2 - 5,7kW // 2 Rooms	✓	✓	✓						✓	✓	✓						✓	✓	✓						✓	✓							✓	✓							✓	✓						
CU-2E18SBE // 3,2 - 7,5kW // 2 Rooms	✓	✓	✓	✓	✓				✓	✓	✓	✓	✓				✓	✓	✓	✓	✓				✓	✓	✓						✓	✓	✓						✓	✓	✓					
CU-3E18PBE // 4,5 - 9,0kW // 3 Rooms	✓	✓	✓	✓	✓	✓			✓	✓	✓	✓	✓	✓			✓	✓	✓	✓	✓	✓			✓	✓	✓	✓					✓	✓	✓	✓					✓	✓	✓	✓				
CU-3E23SBE // 4,5 - 11,0kW // 3 Rooms	✓	✓	✓	✓	✓	✓	✓		✓	✓	✓	✓	✓	✓	✓		✓	✓	✓	✓	✓	✓	✓		✓	✓	✓	✓	✓				✓	✓	✓	✓	✓				✓	✓	✓	✓	✓			
CU-4E23PBE // 4,5 - 11,0kW // 4 Rooms	✓	✓	✓	✓	✓	✓	✓	✓	✓	✓	✓	✓	✓	✓	✓	✓	✓	✓	✓	✓	✓	✓	✓	✓	✓	✓	✓	✓	✓	✓			✓	✓	✓	✓	✓	✓			✓	✓	✓	✓	✓	✓		
CU-4E27PBE // 4,5 - 13,6kW // 4 Rooms	✓	✓	✓	✓	✓	✓	✓	✓	✓	✓	✓	✓	✓	✓	✓	✓	✓	✓	✓	✓	✓	✓	✓	✓	✓	✓	✓	✓	✓	✓	✓		✓	✓	✓	✓	✓	✓	✓		✓	✓	✓	✓	✓	✓	✓	
CU-5E34PBE // 4,5 - 17,5kW // 5 Rooms	✓	✓	✓	✓	✓	✓	✓	✓	✓	✓	✓	✓	✓	✓	✓	✓	✓	✓	✓	✓	✓	✓	✓	✓	✓	✓	✓	✓	✓	✓	✓	✓	✓	✓	✓	✓	✓	✓	✓	✓	✓	✓	✓	✓	✓	✓	✓	✓

1) A CZ-MA1P pipe reducer is needed on the 42 and 50, a CZ-MA2P pipe expander is needed on the 60 and CZ-MA3P pipe reducer on the 71.

### Outdoor Multi combination model

CS-MZ16TKE / CS-MZ16TKE	CU-2E12SBE / CU-2E15SBE / CU-2E18SBE / CU-3E18PBE / CU-3E23SBE / CU-4E23PBE / CU-4E27PBE / CU-5E34PBE	Accessory
CS-XZ20TKEW / CS-ZZ20TKEW / CS-TZ20TKEW / CS-TE20TKEW		
CS-XZ25TKEW / CS-ZZ25TKEW / CS-TZ25TKEW / CS-TE25TKEW / CS-E9PD3EA / CS-E9PB4EA	CU-3E18PBE / CU-3E23SBE / CU-4E23PBE / CU-4E27PBE / CU-5E34PBE	CZ-MA1P
CS-XZ35TKEW / CS-ZZ35TKEW / CS-TZ35TKEW / CS-TE35TKEW / CS-E12QD3EAW / CS-E12PB4EA		
CS-Z42TKEW / CS-E15QKEW / CS-TZ42TKEW / CS-TE42TKEW	CU-3E18PBE / CU-3E23SBE / CU-4E23PBE / CU-4E27PBE / CU-5E34PBE	CZ-MA1P
CS-XZ50TKEW / CS-Z50TKEW / CS-TZ50TKEW / CS-TE50TKEW / CS-E18RD3EAW / CS-E18RB4EAW		
CS-E21RB4EAW	CU-4E23PBE / CU-4E27PBE / CU-5E34PBE	CZ-MA2P
CS-Z71TKEW / CS-TZ71TKEW	CU-4E27PBE / CU-5E34PBE	CZ-MA3P



CZ-MA1P is to be used to reduce the connection size on the indoor unit from 1/2" to 3/8". CZ-MA2P is to be used to increase the connection size on the outdoor unit from 3/8" to 1/2". CZ-MA3P is to be used to reduce the connection size on the indoor unit from 5/8" to 1/2".

NEW TECHNOLOGY '17



		1,6kW	2,0kW	2,5kW	3,2kW	4,0kW	5,0kW	7,1kW	
<b>Etherea Silver Indoor Unit</b>		—	CS-XZ7-SKE	CS-XZ9-SKE	CS-XZ12-SKE	—	CS-XZ18-SKE	—	
<b>Etherea Matt Pearl White Indoor Unit</b>		CS-MZ16TKE	CS-Z7-SKEM	CS-Z9-SKEM	CS-Z12-SKEM	CS-Z15-SKEM	CS-Z18-SKEM	CS-Z17TKEW	
Cooling capacity	kW / kCal/h	1,60 / 1.380	2,05 / 1.720	2,50 / 2.150	3,20 / 2.750	4,00 / 3.440	5,00 / 4.300	7,10 / 6.105	
Heating capacity	kW / kCal/h	2,60 / 2.240	2,80 / 2.750	3,60 / 3.010	4,50 / 3.870	5,60 / 4.820	6,80 / 5.850	8,60 / 7.395	
Sound pressure level <sup>1</sup>	Cooling — Heating (Hi / Lo / S-Lo)	dB(A) 39 / 29 / 23 — 39 / 29 / 23		37 / 24 / 19 — 38 / 25 / 19		39 / 25 / 19 — 41 / 27 / 19		42 / 28 / 19 — 43 / 33 / 19	
Dimensions / Net weight	H x W x D TZ / TE	mm / kg 295 x 919 x 194 / 9		295 x 919 x 194 / 9		295 x 919 x 194 / 10		295 x 919 x 194 / 10	
Piping connections	Liquid pipe / Gas pipe	Inch (mm) 1/4 (6,35) / 3/8 (9,52)		1/4 (6,35) / 3/8 (9,52)		1/4 (6,35) / 3/8 (9,52)		1/4 (6,35) / 1/2 (12,70)	

NEW TECHNOLOGY '17



		1,6kW	2,0kW	2,5kW	3,2kW	4,0kW	5,0kW	6,0kW	7,1kW
<b>TZ Compact Style Indoor Unit</b>		CS-MTZ16TKE*	CS-TZ20TKEW*	CS-TZ25TKEW*	CS-TZ35TKEW*	CS-TZ42TKEW*	CS-TZ50TKEW**	CS-TZ60TKEW***	CS-TZ17TKES
Cooling capacity	kW / kCal/h	1,60 / 1.380	2,00 / 1.720	2,50 / 2.150	3,20 / 2.750	4,00 / 3.440	5,00 / 4.300	7,00 / 6.580	7,10 / 6.105
Heating capacity	kW / kCal/h	2,60 / 2.240	3,20 / 2.750	3,60 / 3.010	4,50 / 3.870	5,60 / 4.820	6,80 / 5.850	8,70 / 8.260	8,60 / 7.395
Sound pressure level <sup>1</sup>	Cooling — Heating (Hi / Lo / S-Lo)	dB(A) —		37 / 25 / 20 — 38 / 26 / 23		40 / 26 / 20 — 40 / 27 / 24		42 / 30 / 20 — 42 / 33 / 25	
Dimensions / Net weight	H x W x D TZ / TE	mm / kg 290 x 799 x 197 / 8		290 x 799 x 197 / 8		290 x 799 x 197 / 8		290 x 799 x 197 / 8	
Piping connections	Liquid pipe / Gas pipe	Inch (mm) 1/4 (6,35) / 3/8 (9,52)		1/4 (6,35) / 3/8 (9,52)		1/4 (6,35) / 3/8 (9,52)		1/4 (6,35) / 1/2 (12,70)	

\* Available in February 2017. \*\* Available in March 2017. \*\*\* Available in April 2017.



		2,8kW	3,2kW	5,0kW
<b>Floor Console Indoor</b>		CS-E9GFEW	CS-E12GFEW	CS-E18GFEW
Cooling capacity	kW / kCal/h	2,80 / 2.410	3,20 / 2.750	5,00 / 4.300
Heating capacity	kW / kCal/h	4,00 / 3.440	4,50 / 3.870	6,80 / 5.850
Connection	mm <sup>2</sup>	4 x 1,5		
Sound pressure <sup>1</sup>	Cooling — Heating (Hi / Lo / S-Lo)	dB(A) 38 / 27 / 23 — 38 / 27 / 23		44 / 36 / 32 — 46 / 36 / 32
Dimensions / Net weight	H x W x D	mm / kg 600 x 700 x 210 / 14		600 x 700 x 210 / 14
Piping connections	Liquid pipe / Gas pipe	Inch (mm) 1/4 (6,35) / 3/8 (9,52)		1/4 (6,35) / 1/2 (12,70)



		2,5kW	3,2kW	5,0kW
<b>Low Static Pressure Hide Away Indoor</b>		CS-E9PD3EA	CS-E12OD3EAW	CS-E18RD3EAW
Cooling capacity	kW / kCal/h	2,50 / 2.150	3,40 / 2.920	5,10
Heating capacity	kW / kCal/h	3,20 / 2.752	4,00 / 3.440	6,10
Connection	mm <sup>2</sup>	4 x 1,5 to 2,5		
Sound pressure <sup>1</sup>	Cooling — Heating (Hi / Lo / S-Lo)	dB(A) 33 / 27 / 24 — 35 / 28 / 25		34 / 27 / 24 — 36 / 28 / 25
Dimensions / Net weight	H x W x D	mm / kg 235 x 750 x 370 / 17		200 x 750 x 640 / 19
Piping connections	Liquid pipe / Gas pipe	Inch (mm) 1/4 (6,35) / 3/8 (9,52)		1/4 (6,35) / 1/2 (12,70)



		2,5kW	3,2kW	5,0kW	6,0kW
<b>4 Way 60x60 Cassette Indoor / Panel</b>		CS-E9PB4EA / CZ-BT20E	CS-E12PB4EA / CZ-BT20E	CS-E18RB4EAW / CZ-BT20E	CS-E21RB4EAW / CZ-BT20E
Cooling capacity	kW / kCal/h	2,50 / 2.150	3,40 / 2.920	5,00 / 4.300	5,90 / 5.070
Heating capacity	kW / kCal/h	3,20 / 2.752	4,50 / 3.870	5,60 / 4.820	7,00 / 6.020
Connection	mm <sup>2</sup>	4 x 1,5 to 2,5			
Sound pressure <sup>1</sup>	Cooling — Heating (Hi / Lo / S-Lo)	dB(A) 34 / 26 / 23 — 35 / 28 / 25		37 / 28 / 25 — 38 / 29 / 26	
Dimensions / Net weight	Indoor (Panel) H x W x D	mm / kg 260 x 575 x 575 / 18 (51 x 700 x 700 / 2,5)		260 x 575 x 575 / 18 (51 x 700 x 700 / 2,5)	
Piping connections	Liquid pipe / Gas pipe	Inch (mm) 1/4 (6,35) / 3/8 (9,52)		1/4 (6,35) / 1/2 (12,70)	

1) The Sound pressure of the units shows the value measured of a position 1m in front of the main body. The sound pressure is measured in accordance with Eurovent 6/C/006-97 specification. 2) The specification listed on the table indicates values under the condition of 29 Pa (3,0 mmAq) which are applied for factory default setting. Change switch on PCB from Hi to S-Hi to have more than 6,0 mmAq.



# FREE MULTI 2X1 COMBINATIONS TABLE

Free Multi 2x1 CU-2E12SBE. Minimum capacity connected: 3,2kW. Maximum capacity connected: 5,7kW • R410 GAS

Indoor unit capacity	Cooling capacity (kW)			EER	Input power rating		A.E.C.	Current	Heating capacity (kW)			COP	Input power rating		A.E.C.	Current
	Rooms				W/W	W			kWh	230V	Rooms			W/W		
	A	B	Total (Min - Max)						A	B	Total (Min - Max)					
<b>1 Room</b>																
16	1,60		1,60 (1,10 - 2,30)	3,90 A	410 (220 - 600)	205	1,95	2,60	2,60 (0,70 - 3,80)			3,77 A	690 (170 - 1.110)	345	3,05	
20	2,00		2,00 (1,10 - 2,90)	3,85 A	520 (220 - 750)	260	2,45	3,20	3,20 (0,70 - 4,80)			3,76 A	850 (170 - 1.410)	425	3,75	
25	2,50		2,50 (1,10 - 3,50)	3,73 A	670 (220 - 1.000)	335	3,15	3,60	3,60 (0,70 - 5,50)			3,50 B	1.030 (170 - 1.700)	515	4,55	
35	3,20		3,20 (1,10 - 4,00)	3,48 A	920 (220 - 1.220)	460	4,30	4,40	4,40 (0,70 - 5,60)			3,61 A	1.220 (170 - 1.680)	610	5,40	
<b>2 Rooms</b>																
16 + 16	1,60	1,60	3,20 (1,50 - 4,00)	4,27 A	750 (250 - 1.000)	375	3,50	2,20	2,20	4,40 (1,10 - 5,60)		4,63 A	950 (210 - 1.270)	475	4,20	
16 + 20	1,60	2,00	3,60 (1,50 - 4,50)	4,50 A	800 (250 - 1.100)	400	3,75	1,95	2,45	4,40 (1,10 - 5,60)		4,63 A	950 (210 - 1.270)	475	4,20	
16 + 25	1,40	2,20	3,60 (1,50 - 4,50)	4,50 A	800 (250 - 1.100)	400	3,75	1,70	2,70	4,40 (1,10 - 5,60)		4,63 A	950 (210 - 1.270)	475	4,20	
16 + 35	1,20	2,40	3,60 (1,50 - 4,50)	4,50 A	800 (250 - 1.100)	400	3,75	1,45	2,95	4,40 (1,10 - 5,60)		4,63 A	950 (210 - 1.270)	475	4,20	
20 + 20	1,80	1,80	3,60 (1,50 - 4,50)	4,50 A	800 (250 - 1.100)	400	3,75	2,20	2,20	4,40 (1,10 - 5,60)		4,63 A	950 (210 - 1.270)	475	4,20	
20 + 25	1,60	2,00	3,60 (1,50 - 4,50)	4,50 A	800 (250 - 1.100)	400	3,75	1,95	2,45	4,40 (1,10 - 5,60)		4,63 A	950 (210 - 1.270)	475	4,20	
20 + 35	1,40	2,20	3,60 (1,50 - 4,50)	4,68 A	770 (250 - 1.050)	385	3,60	1,70	2,70	4,40 (1,10 - 5,60)		4,78 A	920 (210 - 1.220)	460	4,10	
25 + 25	1,80	1,80	3,60 (1,50 - 4,50)	4,68 A	770 (250 - 1.050)	385	3,60	2,20	2,20	4,40 (1,10 - 5,60)		4,78 A	920 (210 - 1.220)	460	4,10	
25 + 35	1,60	2,00	3,60 (1,50 - 4,50)	4,68 A	770 (250 - 1.050)	385	3,60	1,95	2,45	4,40 (1,10 - 5,60)		4,78 A	920 (210 - 1.220)	460	4,10	

1) Showing SEER and Pdesign (kWh) / SCOP and Pdesign at -10°C (kWh): Using EN 14825. Other: A.E.C. using internal procedure (only for reference).  
 \* EER, COP, SEER, SCOP, Input Power, Annual consumption is show following the ErP directive only on the 100% capacity combination as requested by the ErP directive.  
 \* Data for not simultaneous operation.

Free Multi 2x1 CU-2E15SBE. Minimum capacity connected: 3,2kW. Maximum capacity connected: 5,7kW • R410 GAS

Indoor unit capacity	Cooling capacity (kW)			EER	Input power rating		A.E.C.	Current	Heating capacity (kW)			COP	Input power rating		A.E.C.	Current
	Rooms				W/W	W			kWh	230V	Rooms			W/W		
	A	B	Total (Min - Max)						A	B	Total (Min - Max)					
<b>1 Room</b>																
16	1,60		1,60 (1,10 - 2,30)	3,90 A	410 (220 - 600)	205	1,95	2,60	2,60 (0,70 - 3,80)			3,77 A	690 (170 - 1.110)	345	3,05	
20	2,00		2,00 (1,10 - 2,90)	3,85 A	520 (220 - 750)	260	2,45	3,20	3,20 (0,70 - 4,80)			3,76 A	850 (170 - 1.410)	425	3,75	
25	2,50		2,50 (1,10 - 3,50)	3,73 A	670 (220 - 1.000)	335	3,15	3,60	3,60 (0,70 - 5,50)			3,50 B	1.030 (170 - 1.700)	515	4,55	
35	3,20		3,20 (1,10 - 4,00)	3,48 A	920 (220 - 1.220)	460	4,30	4,50	4,50 (0,70 - 6,20)			3,60 B	1.250 (170 - 1.810)	625	5,55	
<b>2 Rooms</b>																
16 + 16	1,60	1,60	3,20 (1,50 - 4,00)	3,76 A	850 (250 - 1.100)	425	4,00	2,60	2,60	5,20 (1,10 - 7,00)		4,60 A	1.130 (210 - 1.710)	565	5,00	
16 + 20	1,60	2,00	3,60 (1,50 - 4,50)	3,71 A	970 (250 - 1.280)	485	4,55	2,40	3,00	5,40 (1,10 - 7,00)		4,58 A	1.180 (210 - 1.690)	590	5,25	
16 + 25	1,60	2,50	4,10 (1,50 - 5,10)	3,63 A	1.130 (250 - 1.480)	565	5,30	2,11	3,29	5,40 (1,10 - 7,00)		4,58 A	1.180 (210 - 1.690)	590	5,25	
16 + 35	1,50	3,00	4,50 (1,50 - 5,20)	3,66 A	1.230 (250 - 1.520)	615	5,75	1,80	3,60	5,40 (1,10 - 7,00)		4,58 A	1.180 (210 - 1.690)	590	5,25	
20 + 20	2,00	2,00	4,00 (1,50 - 5,00)	3,67 A	1.090 (250 - 1.460)	545	5,10	2,70	2,70	5,40 (1,10 - 7,00)		4,62 A	1.170 (210 - 1.670)	585	5,20	
20 + 25	2,00	2,50	4,50 (1,50 - 5,20)	3,66 A	1.230 (250 - 1.520)	615	5,75	2,40	3,00	5,40 (1,10 - 7,00)		4,62 A	1.170 (210 - 1.670)	585	5,20	
20 + 35	1,75	2,75	4,50 (1,50 - 5,20)	3,66 A	1.230 (250 - 1.520)	615	5,75	2,10	3,30	5,40 (1,10 - 7,00)		4,62 A	1.170 (210 - 1.670)	585	5,20	
25 + 25	2,25	2,25	4,50 (1,50 - 5,20)	3,66 A	1.230 (250 - 1.520)	615	5,75	2,70	2,70	5,40 (1,10 - 7,00)		4,62 A	1.170 (210 - 1.670)	585	5,20	
25 + 35	2,00	2,50	4,50 (1,50 - 5,20)	3,66 A	1.230 (250 - 1.520)	615	5,75	2,40	3,00	5,40 (1,10 - 7,00)		4,62 A	1.170 (210 - 1.670)	585	5,20	

1) Showing SEER and Pdesign (kWh) / SCOP and Pdesign at -10°C (kWh): Using EN 14825. Other: A.E.C. using internal procedure (only for reference).  
 \* EER, COP, SEER, SCOP, Input Power, Annual consumption is show following the ErP directive only on the 100% capacity combination as requested by the ErP directive.  
 \* Data for not simultaneous operation.

Free Multi 2x1 CU-2E18SBE. Minimum capacity connected: 3,2kW. Maximum capacity connected: 7,5kW • R410 GAS

Indoor unit capacity	Cooling capacity (kW)			EER	Input power rating		A.E.C.	Current	Heating capacity (kW)			COP	Input power rating		A.E.C.	Current
	Rooms				W/W	W			kWh	230V	Rooms			W/W		
	A	B	Total (Min - Max)						A	B	Total (Min - Max)					
<b>1 Room</b>																
16	1,60		1,60 (1,10 - 2,30)	3,90 A	410 (220 - 600)	205	1,95	2,60	2,60 (0,70 - 3,80)			3,77 A	690 (170 - 1.110)	345	3,05	
20	2,00		2,00 (1,10 - 2,90)	3,85 A	520 (220 - 750)	260	2,45	3,20	3,20 (0,70 - 4,80)			3,76 A	850 (170 - 1.410)	425	3,75	
25	2,50		2,50 (1,10 - 3,50)	3,73 A	670 (220 - 1.000)	335	3,15	3,60	3,60 (0,70 - 5,50)			3,50 B	1.030 (170 - 1.700)	515	4,55	
35	3,20		3,20 (1,10 - 4,00)	3,48 A	920 (220 - 1.220)	460	4,30	4,50	4,50 (0,70 - 6,20)			3,60 B	1.250 (170 - 1.810)	625	5,55	
42	4,00		4,00 (1,10 - 4,20)	3,13 B	1.280 (220 - 1.390)	640	6,00	5,00	5,00 (1,10 - 6,40)			3,23 C	1.550 (210 - 2.180)	775	6,90	
50	5,00		5,00 (1,20 - 5,10)	2,96 C	1.690 (230 - 1.790)	845	7,80	5,30	5,30 (1,10 - 6,80)			3,23 C	1.640 (210 - 2.290)	820	7,30	
<b>2 Rooms</b>																
16 + 16	1,60	1,60	3,20 (1,50 - 4,00)	3,76 A	850 (250 - 1.100)	425	4,00	2,60	2,60	5,20 (1,10 - 7,00)		4,60 A	1.130 (210 - 1.710)	565	5,00	
16 + 20	1,60	2,00	3,60 (1,50 - 4,50)	3,71 A	970 (250 - 1.280)	485	4,55	2,40	3,00	5,40 (1,10 - 7,00)		4,58 A	1.180 (210 - 1.690)	590	5,25	
16 + 25	1,60	2,50	4,10 (1,50 - 5,10)	3,63 A	1.130 (250 - 1.480)	565	5,30	2,11	3,29	5,40 (1,10 - 7,00)		4,58 A	1.180 (210 - 1.690)	590	5,25	
16 + 35	1,50	3,00	4,50 (1,50 - 5,20)	3,66 A	1.230 (250 - 1.520)	615	5,75	1,80	3,60	5,40 (1,10 - 7,00)		4,58 A	1.180 (210 - 1.690)	590	5,25	
16 + 42	1,50	3,70	5,20 (1,50 - 5,40)	3,42 A	1.520 (250 - 1.580)	760	7,10	1,60	4,00	5,60 (1,10 - 7,20)		4,63 A	1.210 (210 - 1.700)	605	5,35	
16 + 50	1,25	3,95	5,20 (1,50 - 5,40)	3,42 A	1.520 (250 - 1.580)	760	7,10	1,35	4,25	5,60 (1,10 - 7,20)		4,63 A	1.210 (210 - 1.700)	605	5,35	
20 + 20	2,00	2,00	4,00 (1,50 - 5,00)	3,67 A	1.090 (250 - 1.460)	545	5,10	2,70	2,70	5,40 (1,10 - 7,00)		4,62 A	1.170 (210 - 1.670)	585	5,20	
20 + 25	2,00	2,50	4,50 (1,50 - 5,20)	3,66 A	1.230 (250 - 1.520)	615	5,75	2,40	3,00	5,40 (1,10 - 7,00)		4,62 A	1.170 (210 - 1.670)	585	5,20	
20 + 35	2,00	3,20	5,20 (1,50 - 5,40)	3,42 A	1.520 (250 - 1.580)	760	7,10	2,15	3,45	5,60 (1,10 - 7,20)		4,63 A	1.210 (210 - 1.700)	605	5,35	
20 + 42	1,75	3,45	5,20 (1,50 - 5,40)	3,42 A	1.520 (250 - 1.580)	760	7,10	1,85	3,75	5,60 (1,10 - 7,20)		4,63 A	1.210 (210 - 1.700)	605	5,35	
20 + 50	1,50	3,70	5,20 (1,50 - 5,40)	3,42 A	1.520 (250 - 1.580)	760	7,10	1,60	4,00	5,60 (1,10 - 7,20)		4,63 A	1.210 (210 - 1.700)	605	5,35	
25 + 25	2,50	2,50	5,00 (1,50 - 5,20)	3,47 A	1.440 (250 - 1.520)	720	6,70	2,80	2,80	5,60 (1,10 - 7,20)		4,63 A	1.210 (210 - 1.700)	605	5,35	
25 + 35	2,30	2,90	5,20 (1,50 - 5,40)	3,42 A	1.520 (250 - 1.580)	760	7,10	2,45	3,15	5,60 (1,10 - 7,20)		4,63 A	1.210 (210 - 1.700)	605	5,35	
25 + 42	2,00	3,20	5,20 (1,50 - 5,40)	3,42 A	1.520 (250 - 1.580)	760	7,10	2,15	3,45	5,60 (1,10 - 7,20)		4,63 A	1.210 (210 - 1.700)	605	5,35	
25 + 50	1,75	3,45	5,20 (1,50 - 5,40)	3,42 A	1.520 (250 - 1.580)	760	7,10	1,85	3,75	5,60 (1,10 - 7,20)		4,63 A	1.210 (210 - 1.700)	605	5,35	
35 + 35	2,60	2,60	5,20 (1,50 - 5,40)	3,42 A	1.520 (250 - 1.580)	760	7,10	2,80	2,80	5,60 (1,10 - 7,20)		4,63 A	1.210 (210 - 1.700)	605	5,35	
35 + 42	2,30	2,90	5,20 (1,50 - 5,40)	3,42 A	1.520 (250 - 1.580)	760	7,10	2,50	3,10	5,60 (1,10 - 7,20)		4,63 A	1.210 (210 - 1.700)	605	5,35	

1) Showing SEER and Pdesign (kWh) / SCOP and Pdesign at -10°C (kWh): Using EN 14825. Other: A.E.C. using internal procedure (only for reference).  
 \* EER, COP, SEER, SCOP, Input Power, Annual consumption is show following the ErP directive only on the 100% capacity combination as requested by the ErP directive.  
 \* Data for not simultaneous operation.

# FREE MULTI 3X1 COMBINATIONS TABLE

Free Multi 3x1 CU-3E18PBE. Minimum capacity connected: 4,5kW. Maximum capacity connected: 9,0kW = R410 GAS

Indoor unit capacity	Cooling capacity (kW)				EER	Input power rating		A.E.C.	Current	Heating capacity (kW)				COP	Input power rating		A.E.C.	Current				
	Rooms					W/W	W			kWh	230V	Rooms				W/W			W	kWh	230V	
	A	B	C	Total (Min - Max)								A	B		C	Total (Min - Max)						
<b>1 Room</b>																						
16	1,60			1,60 (1,30 - 2,30)	3,40 A	470 (250 - 710)	235	2,30	2,60			2,60 (1,20 - 3,20)	3,88 A	670 (300 - 1030)	335	3,20						
20	2,00			2,00 (1,80 - 2,90)	3,51 A	570 (340 - 880)	285	2,80	3,20			3,20 (1,20 - 4,10)	3,95 A	810 (300 - 1300)	405	4,00						
25	2,50			2,50 (1,80 - 2,90)	3,57 A	700 (340 - 880)	350	3,30	3,60			3,60 (1,20 - 4,30)	3,56 B	1.010 (300 - 1300)	505	4,80						
35	3,20			3,20 (1,80 - 3,80)	3,68 A	870 (340 - 1.430)	435	4,00	4,50			4,50 (1,20 - 5,80)	3,46 B	1.300 (300 - 2170)	650	6,20						
42	4,00			4,00 (1,80 - 4,30)	3,05 B	1.310 (340 - 2.060)	655	5,90	5,60			5,60 (1,20 - 6,80)	3,13 D	1.790 (300 - 3000)	895	7,90						
50	5,00			5,00 (1,90 - 5,70)	2,90 C	1.725 (340 - 2.305)	863	7,60	6,80			6,80 (1,20 - 6,90)	2,99 D	2.275 (300 - 2.695)	1.138	10,00						
<b>2 Rooms</b>																						
16 + 16	1,60	1,60		3,20 (1,80 - 6,20)	4,05 A	790 (330 - 2.230)	395	3,60	2,60	2,60		5,20 (1,40 - 7,00)	3,77 A	1.380 (340 - 2070)	690	6,40						
16 + 20	1,60	2,00		3,60 (1,80 - 6,20)	3,83 A	940 (330 - 2.190)	470	4,20	2,49	3,11		5,60 (1,40 - 7,00)	3,73 A	1.500 (330 - 2040)	750	6,90						
16 + 25	1,60	2,50		4,10 (1,80 - 6,20)	3,73 A	1.100 (330 - 2.190)	550	4,90	2,42	3,78		6,20 (1,40 - 7,00)	3,69 A	1.680 (330 - 2040)	840	7,80						
16 + 35	1,60	3,20		4,80 (1,80 - 6,30)	3,36 A	1.430 (330 - 2.200)	715	6,30	2,13	4,27		6,40 (1,40 - 7,30)	3,76 A	1.700 (310 - 2130)	850	7,80						
16 + 42	1,49	3,71		5,20 (1,90 - 6,40)	3,21 A	1.620 (350 - 2.240)	810	7,10	1,94	4,86		6,80 (1,40 - 7,30)	3,74 A	1.820 (310 - 2120)	910	8,30						
16 + 50	1,26	3,94		5,20 (1,90 - 6,80)	3,41 A	1.525 (340 - 2.285)	763	6,70	1,65	5,15		6,80 (1,40 - 8,00)	3,81 A	1.785 (240 - 2335)	893	8,20						
20 + 20	2,00	2,00		4,00 (1,80 - 6,20)	3,74 A	1.070 (330 - 2.150)	535	4,70	2,90	2,90		5,80 (1,40 - 7,00)	3,82 A	1.520 (320 - 2030)	760	7,00						
20 + 25	2,00	2,50		4,50 (1,80 - 6,20)	3,52 A	1.280 (330 - 2.150)	640	5,60	2,84	3,56		6,40 (1,40 - 7,00)	3,68 A	1.740 (320 - 2030)	870	8,00						
20 + 35	2,00	3,20		5,20 (1,80 - 6,30)	3,21 A	1.620 (330 - 2.160)	810	7,10	2,62	4,18		6,80 (1,40 - 7,30)	3,74 A	1.820 (310 - 2120)	910	8,30						
20 + 42	1,73	3,47		5,20 (1,90 - 6,40)	3,29 A	1.580 (350 - 2.200)	790	6,90	2,27	4,53		6,80 (1,40 - 7,30)	3,74 A	1.820 (280 - 2080)	910	8,30						
20 + 50	1,49	3,71		5,20 (1,90 - 6,80)	3,41 A	1.525 (340 - 2.285)	763	6,70	1,94	4,86		6,80 (1,40 - 8,00)	3,83 A	1.775 (240 - 2325)	888	8,10						
25 + 25	2,50	2,50		5,00 (1,80 - 7,30)	3,25 A	1.540 (330 - 2.150)	770	6,80	3,40	3,40		6,80 (1,40 - 7,00)	3,64 A	1.870 (320 - 2030)	935	8,50						
25 + 35	2,28	2,92		5,20 (1,90 - 6,30)	3,21 A	1.620 (350 - 2.160)	810	7,10	2,98	3,82		6,80 (1,40 - 7,30)	3,74 A	1.820 (310 - 2120)	910	8,30						
25 + 42	2,00	3,20		5,20 (1,90 - 6,40)	3,29 A	1.580 (350 - 2.200)	790	6,90	2,62	4,18		6,80 (1,40 - 7,30)	3,74 A	1.820 (280 - 2080)	910	8,30						
25 + 50	1,73	3,47		5,20 (1,90 - 6,80)	3,41 A	1.525 (340 - 2.285)	763	6,70	2,27	4,53		6,80 (1,40 - 8,00)	3,83 A	1.775 (240 - 2325)	888	8,10						
35 + 35	2,60	2,60		5,20 (1,90 - 6,40)	3,38 A	1.540 (350 - 2.160)	770	6,80	3,40	3,40		6,80 (1,40 - 7,50)	3,76 A	1.810 (270 - 2140)	905	8,30						
35 + 42	2,31	2,89		5,20 (1,90 - 6,50)	3,38 A	1.540 (350 - 2.160)	770	6,80	3,02	3,78		6,80 (1,40 - 7,50)	3,78 A	1.870 (260 - 2140)	900	8,20						
35 + 50	2,03	3,17		5,20 (1,90 - 6,90)	3,50 A	1.485 (360 - 2.285)	743	6,50	2,65	4,15		6,80 (1,40 - 8,00)	3,87 A	1.755 (240 - 2265)	878	8,00						
42 + 42	2,60	2,60		5,20 (1,90 - 6,50)	3,38 A	1.540 (350 - 2.160)	770	6,80	3,40	3,40		6,80 (1,40 - 7,60)	3,86 A	1.760 (260 - 2170)	880	8,00						
42 + 50	2,31	2,89		5,20 (1,90 - 6,90)	3,50 A	1.485 (360 - 2.285)	743	6,50	3,02	3,78		6,80 (1,40 - 8,00)	3,90 A	1.745 (240 - 2265)	873	8,10						
<b>3 Rooms</b>																						
16 + 16 + 16	1,60	1,60	1,60	4,80 (1,80 - 7,20)	3,81 A	1.260 (360 - 2.340)	630	5,50	2,26	2,26	2,26	6,78 (1,50 - 8,10)	4,06 A	1.670 (290 - 2250)	835	7,70						
16 + 16 + 20	1,60	1,60	2,00	5,20 (1,80 - 7,30)	3,69 A	1.410 (360 - 2.390)	705	6,20	2,09	2,09	2,62	6,80 (1,60 - 8,30)	4,10 A	1.660 (320 - 2320)	830	7,70						
16 + 16 + 25	1,46	1,46	2,28	5,20 (1,90 - 7,20)	3,69 A	1.410 (390 - 2.300)	705	6,20	1,91	1,91	2,98	6,80 (1,60 - 8,30)	4,10 A	1.660 (320 - 2320)	830	7,70						
16 + 16 + 35	1,30	1,30	2,60	5,20 (1,90 - 7,20)	3,69 A	1.410 (390 - 2.250)	705	6,20	1,70	1,70	3,40	6,80 (1,60 - 8,30)	4,15 A	1.640 (310 - 2250)	820	7,60						
16 + 16 + 42	1,16	1,16	2,88	5,20 (1,80 - 7,30)	3,69 A	1.410 (390 - 2.300)	705	6,20	1,51	1,51	3,78	6,80 (1,60 - 8,30)	4,17 A	1.630 (310 - 2250)	815	7,50						
16 + 16 + 50	1,01	1,01	3,18	5,20 (1,80 - 7,30)	3,62 A	1.435 (420 - 2.225)	718	6,30	1,33	1,33	4,14	6,80 (1,60 - 8,30)	4,16 A	1.635 (360 - 2215)	818	7,50						
16 + 20 + 20	1,48	1,86	1,86	5,20 (1,90 - 7,20)	3,69 A	1.410 (390 - 2.300)	705	6,20	1,94	2,43	2,43	6,80 (1,60 - 8,30)	4,12 A	1.650 (310 - 2270)	825	7,60						
16 + 20 + 25	1,36	1,70	2,14	5,20 (1,90 - 7,20)	3,69 A	1.410 (390 - 2.300)	705	6,20	1,78	2,23	2,79	6,80 (1,60 - 8,30)	4,12 A	1.650 (310 - 2270)	825	7,60						
16 + 20 + 35	1,22	1,53	2,45	5,20 (1,90 - 7,20)	3,69 A	1.410 (390 - 2.210)	705	6,20	1,60	2,00	3,20	6,80 (1,60 - 8,30)	4,17 A	1.630 (310 - 2250)	815	7,50						
16 + 20 + 42	1,09	1,37	2,74	5,20 (1,80 - 7,30)	3,69 A	1.410 (390 - 2.300)	705	6,20	1,43	1,79	3,58	6,80 (1,60 - 8,30)	4,17 A	1.630 (310 - 2240)	815	7,50						
16 + 20 + 50	0,97	1,21	3,02	5,20 (1,80 - 7,30)	3,62 A	1.435 (420 - 2.175)	718	6,30	1,27	1,58	3,95	6,80 (1,60 - 8,30)	4,18 A	1.625 (360 - 2215)	813	7,50						
16 + 25 + 25	1,26	1,97	1,97	5,20 (1,90 - 7,20)	3,69 A	1.410 (390 - 2.300)	705	6,20	1,64	2,58	2,58	6,80 (1,60 - 8,30)	4,12 A	1.650 (310 - 2270)	825	7,60						
16 + 25 + 35	1,14	1,78	2,28	5,20 (1,80 - 7,30)	3,69 A	1.410 (390 - 2.300)	705	6,20	1,49	2,33	2,98	6,80 (1,60 - 8,30)	4,17 A	1.630 (310 - 2250)	815	7,50						
16 + 25 + 42	1,03	1,60	2,57	5,20 (1,80 - 7,30)	3,69 A	1.410 (390 - 2.300)	705	6,20	1,34	2,10	3,36	6,80 (1,60 - 8,30)	4,17 A	1.630 (310 - 2240)	815	7,50						
16 + 35 + 35	1,04	2,08	2,08	5,20 (1,80 - 7,30)	3,80 A	1.370 (390 - 2.250)	685	6,00	1,36	2,72	2,72	6,80 (1,60 - 8,30)	4,22 A	1.610 (320 - 2220)	805	7,40						
16 + 35 + 42	0,95	1,89	2,36	5,20 (1,80 - 7,30)	3,80 A	1.370 (390 - 2.250)	685	6,00	1,24	2,47	3,09	6,80 (1,60 - 8,30)	4,22 A	1.610 (320 - 2210)	805	7,40						
20 + 20 + 20	1,73	1,73	1,73	5,19 (1,90 - 7,20)	3,68 A	1.410 (390 - 2.250)	705	6,20	2,26	2,26	2,26	6,78 (1,60 - 8,30)	4,11 A	1.650 (310 - 2260)	825	7,60						
20 + 20 + 25	1,60	1,60	2,00	5,20 (1,90 - 7,20)	3,69 A	1.410 (390 - 2.250)	705	6,20	2,09	2,09	2,62	6,80 (1,60 - 8,30)	4,12 A	1.650 (310 - 2260)	825	7,60						
20 + 20 + 35	1,44	1,44	2,32	5,20 (1,90 - 7,20)	3,80 A	1.370 (390 - 2.210)	685	6,00	1,89	1,89	3,02	6,80 (1,60 - 8,30)	4,17 A	1.630 (310 - 2240)	815	7,50						
20 + 20 + 42	1,30	1,30	2,60	5,20 (1,80 - 7,30)	3,80 A	1.370 (390 - 2.250)	685	6,00	1,70	1,70	3,40	6,80 (1,60 - 8,30)	4,20 A	1.620 (320 - 2230)	810	7,50						
20 + 20 + 50	1,16	1,16	2,88	5,20 (1,80 - 7,30)	3,62 A	1.435 (420 - 2.175)	718	6,30	1,51	1,51	3,78	6,80 (1,60 - 8,30)	4,18 A	1.625 (360 - 2205)	813	7,50						
20 + 25 + 25	1,48	1,86	1,86	5,20 (1,90 - 7,20)	3,69 A	1.410 (390 - 2.250)	705	6,20	1,94	2,43	2,43	6,80 (1,60 - 8,30)	4,12 A	1.650 (310 - 2260)	825	7,60						
20 + 25 + 35	1,35	1,69	2,16	5,20 (1,90 - 7,20)	3,80 A	1.370 (390 - 2.210)	685	6,00	1,76	2,21	2,83	6,80 (1,60 - 8,30)	4,17 A	1.630 (310 - 2240)	815	7,50						
20 + 25 + 42	1,22	1,53	2,45	5,20 (1,80 - 7,30)	3,80 A	1.370 (390 - 2.250)	685	6,00	1,60	2,00	3,20	6,80 (1,60 - 8,30)	4,20 A	1.620 (320 - 2230)	810	7,50						
20 + 35 + 35	1,24	1,98	1,98	5,20 (1,80 - 7,30)	3,80 A	1.370 (390 - 2.210)	685	6,00	1,62	2,59	2,59	6,80 (1,60 - 8,30)	4,22 A	1.610 (320 - 2210)	805	7,40						
25 + 25 + 25	1,73	1,73	1,73	5,19 (1,90 - 7,20)	3,68 A	1.410 (390 - 2.250)	705	6,20	2,26	2,26	2,26	6,78 (1,60 - 8,30)	4,11 A	1.650 (310 - 2260)	825	7,60						
25 + 25 + 35	1,59	1,59	2,02	5,20 (1,90 - 7,20)	3,80 A	1.370 (390 - 2.210)	685	6,00	2,07	2,07	2,66	6,80 (1,60 - 8,30)	4,17 A	1.630 (310 - 2240)	815	7,50						
25 + 25 + 42	1,44	1,44	2,32	5,20 (1,80 - 7,30)	3,80 A	1.370 (390 - 2.250)	685	6,00	1,89	1,89	3,02											

Free Multi 3x1 CU-3E23SBE. Minimum capacity connected: 4,5kW. Maximum capacity connected: 11,0kW • R410 GAS

Indoor unit capacity	Cooling capacity (kW)				EER	Input power rating	A.E.C.	Current	Heating capacity (kW)				COP	Input power rating	A.E.C.	Current
	Rooms								Rooms							
	A	B	C	Total (Min - Max)	W/W	W	kWh	230V	A	B	C	Total (Min - Max)	W/W	W	kWh	230V
<b>1 Room</b>																
16	1,60			1,60 (1,30 - 2,30)	3,40 A	470 (250 - 710)	235	2,30	2,60			2,60 (1,20 - 3,20)	3,88 A	670 (300 - 960)	335	3,20
20	2,00			2,00 (1,80 - 2,90)	3,51 A	570 (340 - 880)	285	2,80	3,20			3,20 (1,20 - 4,10)	3,95 A	810 (300 - 1.300)	405	4,00
25	2,50			2,50 (1,80 - 2,90)	3,57 A	700 (340 - 880)	350	3,40	3,60			3,60 (1,20 - 4,30)	3,56 B	1.010 (300 - 1.300)	505	5,00
35	3,20			3,20 (1,80 - 3,80)	3,68 A	870 (340 - 1.430)	435	4,20	4,50			4,50 (1,20 - 5,80)	3,66 B	1.300 (300 - 2.170)	650	6,30
42	4,00			4,00 (1,80 - 4,30)	3,05 B	1.310 (340 - 2.060)	655	6,10	5,60			5,60 (1,20 - 6,80)	3,13 D	1.790 (300 - 3.000)	895	8,30
50	5,00			5,00 (1,90 - 5,70)	2,90 C	1.725 (340 - 2.305)	863	8,00	6,80			6,80 (1,20 - 6,90)	2,99 D	2.275 (300 - 2.695)	1.138	10,50
<b>2 Rooms</b>																
16 + 16	1,60	1,60		3,20 (1,90 - 6,40)	4,16 A	770 (270 - 2.150)	385	3,60	2,60	2,60		5,20 (2,70 - 9,80)	3,61 A	1.440 (660 - 3.060)	720	6,70
16 + 20	1,60	2,00		3,60 (1,90 - 6,40)	3,96 A	910 (270 - 2.110)	455	4,10	2,58	3,22		5,80 (2,70 - 9,80)	3,58 B	1.620 (650 - 3.060)	810	7,50
16 + 25	1,60	2,50		4,10 (1,90 - 6,40)	3,83 A	1.070 (270 - 2.110)	535	4,80	2,38	3,72		6,10 (2,70 - 9,80)	3,55 B	1.720 (650 - 3.060)	860	8,00
16 + 35	1,60	3,20		4,80 (1,90 - 6,90)	3,48 A	1.380 (270 - 2.500)	690	6,10	2,13	4,27		6,40 (2,70 - 9,90)	3,64 A	1.760 (630 - 3.070)	880	8,10
16 + 42	1,60	4,00		5,60 (1,90 - 6,90)	3,08 B	1.820 (270 - 2.460)	910	8,00	2,29	5,71		8,00 (2,70 - 9,90)	3,39 C	2.360 (630 - 3.070)	1.180	10,90
16 + 50	1,60	5,00		6,60 (2,00 - 7,50)	2,89 C	2.285 (280 - 2.645)	1.143	10,00	2,06	6,44		8,50 (2,80 - 10,20)	3,39 C	2.505 (560 - 3.145)	1.253	11,60
20 + 20	2,00	2,00		4,00 (1,90 - 6,40)	3,85 A	1.040 (270 - 2.080)	520	4,70	2,90	2,90		5,80 (2,70 - 9,80)	3,67 A	1.580 (640 - 3.070)	790	7,40
20 + 25	2,00	2,50		4,50 (1,90 - 6,40)	3,63 A	1.240 (270 - 2.080)	620	5,50	2,71	3,39		6,10 (2,70 - 9,80)	3,57 B	1.710 (640 - 3.070)	855	8,00
20 + 35	2,00	3,20		5,20 (1,90 - 6,90)	3,29 A	1.580 (270 - 2.460)	790	7,00	2,69	4,31		7,00 (2,70 - 9,90)	3,50 B	2.000 (630 - 3.070)	1.000	9,20
20 + 42	2,00	4,00		6,00 (1,90 - 6,90)	2,96 C	2.030 (270 - 2.420)	1.015	8,90	2,73	5,47		8,20 (2,70 - 9,90)	3,37 C	2.430 (620 - 3.070)	1.215	11,20
20 + 50	1,94	4,86		6,80 (2,00 - 7,50)	2,80 C	2.425 (280 - 2.595)	1.213	10,60	2,43	6,07		8,50 (2,80 - 10,20)	3,39 C	2.505 (560 - 3.135)	1.253	11,60
25 + 25	2,50	2,50		5,00 (1,90 - 6,80)	3,33 A	1.500 (270 - 2.450)	750	6,70	3,20	3,20		6,40 (2,70 - 9,80)	3,54 B	1.810 (640 - 3.070)	905	8,30
25 + 35	2,50	3,20		5,70 (1,90 - 6,90)	3,06 B	1.860 (270 - 2.460)	930	8,20	3,55	4,55		8,10 (2,70 - 9,90)	3,39 C	2.390 (630 - 3.070)	1.195	11,00
25 + 42	2,50	4,00		6,50 (1,90 - 6,90)	2,65 D	2.450 (270 - 2.460)	1.225	10,80	3,27	5,23		8,50 (2,70 - 9,90)	3,29 C	2.580 (620 - 3.070)	1.290	11,90
25 + 50	2,27	4,53		6,80 (1,90 - 7,50)	2,80 C	2.425 (260 - 2.595)	1.213	10,60	2,83	5,67		8,50 (2,80 - 10,20)	3,39 C	2.505 (560 - 3.135)	1.253	11,60
35 + 35	3,20	3,20		6,40 (1,90 - 7,00)	2,77 D	2.310 (270 - 2.420)	1.155	10,10	4,25	4,25		8,50 (2,80 - 10,00)	3,36 C	2.530 (640 - 3.070)	1.265	11,70
35 + 42	3,02	3,78		6,80 (1,90 - 7,10)	2,57 E	2.650 (270 - 2.660)	1.325	11,60	3,78	4,72		8,50 (2,80 - 10,00)	3,36 C	2.530 (640 - 3.070)	1.265	11,70
35 + 50	2,65	4,15		6,80 (2,00 - 7,60)	2,91 C	2.335 (280 - 2.605)	1.168	10,30	3,32	5,18		8,50 (2,80 - 10,30)	3,48 B	2.445 (630 - 3.125)	1.223	11,30
42 + 42	3,40	3,40		6,80 (1,90 - 7,10)	2,57 E	2.650 (260 - 2.660)	1.325	11,60	4,25	4,25		8,50 (2,80 - 10,00)	3,37 C	2.520 (600 - 3.030)	1.260	11,60
42 + 50	3,02	3,78		6,80 (2,00 - 7,60)	2,91 C	2.335 (280 - 2.555)	1.168	10,30	3,78	4,72		8,50 (2,80 - 10,30)	3,49 B	2.435 (560 - 3.115)	1.218	11,20
50 + 50	3,40	3,40		6,80 (2,10 - 8,10)	3,08 B	2.210 (320 - 2.720)	1.105	9,70	4,25	4,25		8,50 (2,80 - 10,50)	3,54 B	2.400 (510 - 3.130)	1.200	11,10
<b>3 Rooms</b>																
16 + 16 + 16	1,60	1,60	1,60	4,80 (1,90 - 8,00)	3,90 A	1.230 (270 - 2.710)	615	5,50	2,60	2,60	2,60	7,80 (3,30 - 10,40)	3,70 A	2.110 (640 - 3.070)	1.055	9,70
16 + 16 + 20	1,60	1,60	2,00	5,20 (1,90 - 8,00)	3,80 A	1.370 (270 - 2.670)	685	6,10	2,58	2,58	3,24	8,40 (3,30 - 10,40)	3,61 A	2.330 (640 - 3.060)	1.165	10,70
16 + 16 + 25	1,60	1,60	2,50	5,70 (1,90 - 8,00)	3,56 A	1.600 (270 - 2.670)	800	7,10	2,39	2,39	3,72	8,50 (3,30 - 10,40)	3,59 B	2.370 (640 - 3.060)	1.185	10,90
16 + 16 + 35	1,60	1,60	3,20	6,40 (1,90 - 8,00)	3,39 A	1.890 (270 - 2.580)	945	8,30	2,13	2,13	4,24	8,50 (3,30 - 10,40)	3,68 A	2.310 (630 - 3.040)	1.155	10,70
16 + 16 + 42	1,51	1,51	3,78	6,80 (1,90 - 8,10)	3,21 A	2.120 (270 - 2.670)	1.060	9,30	1,89	1,89	4,72	8,50 (3,30 - 10,50)	3,70 A	2.300 (620 - 3.070)	1.150	10,60
16 + 16 + 50	1,33	1,33	4,14	6,80 (2,00 - 8,50)	3,26 A	2.085 (320 - 2.735)	1.043	9,20	1,66	1,66	5,18	8,50 (3,30 - 10,60)	3,74 A	2.275 (600 - 3.035)	1.138	10,50
16 + 20 + 20	1,60	2,00	2,00	5,60 (1,90 - 8,00)	3,68 A	1.520 (270 - 2.670)	760	6,70	2,42	3,04	3,04	8,50 (3,30 - 10,40)	3,60 A	2.360 (630 - 3.050)	1.180	10,90
16 + 20 + 25	1,60	2,00	2,50	6,10 (1,90 - 8,00)	3,45 A	1.770 (270 - 2.670)	885	7,80	2,23	2,79	3,48	8,50 (3,30 - 10,40)	3,60 A	2.360 (630 - 3.050)	1.180	10,90
16 + 20 + 35	1,60	2,00	3,20	6,80 (1,90 - 8,00)	3,21 A	2.120 (270 - 2.580)	1.060	9,30	2,00	2,50	4,00	8,50 (3,30 - 10,40)	3,70 A	2.300 (620 - 2.990)	1.150	10,60
16 + 20 + 42	1,43	1,79	3,58	6,80 (1,90 - 8,10)	3,21 A	2.120 (270 - 2.630)	1.060	9,30	1,79	2,24	4,47	8,50 (3,30 - 10,50)	3,71 A	2.290 (620 - 3.020)	1.145	10,60
16 + 20 + 50	1,27	1,58	3,95	6,80 (2,00 - 8,50)	3,34 A	2.035 (320 - 2.735)	1.018	8,90	1,58	1,98	4,94	8,50 (3,30 - 10,60)	3,75 A	2.265 (600 - 3.025)	1.133	10,40
16 + 25 + 25	1,60	2,50	2,50	6,60 (1,90 - 8,00)	3,25 A	2.030 (270 - 2.670)	1.015	8,90	2,06	3,22	3,22	8,50 (3,30 - 10,40)	3,60 A	2.360 (630 - 3.060)	1.180	10,90
16 + 25 + 35	1,49	2,33	2,98	6,80 (1,90 - 8,00)	3,21 A	2.120 (270 - 2.580)	1.060	9,30	1,86	2,91	3,73	8,50 (3,30 - 10,40)	3,70 A	2.300 (620 - 2.990)	1.150	10,60
16 + 25 + 42	1,34	2,10	3,36	6,80 (1,90 - 8,10)	3,21 A	2.120 (270 - 2.630)	1.060	9,30	1,68	2,62	4,20	8,50 (3,30 - 10,50)	3,71 A	2.290 (620 - 3.020)	1.145	10,60
16 + 25 + 50	1,19	1,87	3,74	6,80 (2,00 - 8,50)	3,34 A	2.035 (320 - 2.735)	1.018	8,90	1,49	2,34	4,67	8,50 (3,30 - 10,60)	3,75 A	2.265 (600 - 3.025)	1.133	10,40
16 + 35 + 35	1,36	2,72	2,72	6,80 (1,90 - 8,10)	3,29 A	2.070 (290 - 2.580)	1.035	9,10	1,70	3,40	3,40	8,50 (3,30 - 10,50)	3,73 A	2.280 (640 - 3.000)	1.140	10,50
16 + 35 + 42	1,24	2,47	3,09	6,80 (1,90 - 8,20)	3,29 A	2.070 (290 - 2.630)	1.035	9,10	1,55	3,09	3,86	8,50 (3,30 - 10,50)	3,74 A	2.270 (640 - 3.000)	1.135	10,50
16 + 35 + 50	1,11	2,22	3,47	6,80 (2,00 - 8,50)	3,34 A	2.035 (340 - 2.695)	1.018	8,90	1,38	2,78	4,34	8,50 (3,30 - 10,60)	3,79 A	2.245 (600 - 2.995)	1.123	10,40
16 + 42 + 42	1,14	2,83	2,83	6,80 (1,90 - 8,20)	3,29 A	2.070 (290 - 2.630)	1.035	9,10	1,42	3,54	3,54	8,50 (3,30 - 10,50)	3,76 A	2.260 (640 - 2.990)	1.130	10,40
16 + 42 + 50	1,02	2,57	3,21	6,80 (2,00 - 8,50)	3,34 A	2.035 (340 - 2.645)	1.018	8,90	1,28	3,21	4,01	8,50 (3,30 - 10,60)	3,80 A	2.235 (600 - 2.985)	1.118	10,30
20 + 20 + 20	2,00	2,00	2,00	6,00 (1,90 - 8,00)	3,49 A	1.720 (270 - 2.620)	860	7,60	2,83	2,83	2,83	8,49 (3,30 - 10,40)	3,66 A	2.320 (630 - 3.040)	1.160	10,70
20 + 20 + 25	2,00	2,00	2,50	6,50 (1,90 - 8,00)	3,28 A	1.980 (270 - 2.620)	990	8,70	2,62	2,62	3,26	8,50 (3,30 - 10,40)	3,66 A	2.320 (630 - 3.040)	1.160	10,70
20 + 20 + 35	1,89	1,89	3,02	6,80 (1,90 - 8,00)	3,21 A	2.120 (270 - 2.530)	1.060	9,30	2,36	2,36	3,78	8,50 (3,30 - 10,40)	3,71 A	2.290 (620 - 2.980)	1.145	10,60
20 + 20 + 42	1,70	1,70	3,40	6,80 (1,90 - 8,10)	3,29 A	2.070 (290 - 2.630)	1.035	9,10	2,13	2,13	4,24	8,50 (3,30 - 10,50)	3,73 A	2.280 (620 - 3.010)	1.140	10,50
20 + 20 + 50	1,51	1,51	3,78	6,80 (2,00 - 8,50)	3,34 A	2.035 (340 - 2.695)	1.018	8,90	1,89	1,89	4,72	8,50 (3,30 - 10,60)	3,77 A	2.255 (600 - 3.015)	1.128	10,40
20 + 25 + 25	1,94	2,43	2,43	6,80 (1,90 - 8,00)	3,21 A	2.120 (270 - 2.620)	1.060	9,30	2,42	3,04	3,04	8,50 (3,30 - 10,40)	3,66 A	2.320 (630 - 3.040)	1	

# FREE MULTI 4X1 COMBINATIONS TABLE

Free Multi 4x1 CU-4E23PBE. Minimum capacity connected: 4.5kW. Maximum capacity connected: 11.0kW • R410 GAS

Indoor unit capacity	Cooling capacity (kW)					EER	Input power rating	A.E.C.			Current	Heating capacity (kW)					COP	Input power rating	A.E.C.			Current		
	Rooms							W/W	W	kWh		230V	Rooms						W/W	W	kWh		230V	
	A	B	C	D	Total (Min - Max)								A	B	C	D								Total (Min - Max)
<b>1 Room</b>																								
16	1,60				1,60 (1,30 - 2,30)	3,40 A	470 (250 - 710)	235	2,30	2,60				2,60 (1,20 - 3,20)	3,88 A	670 (300 - 1.030)	335	3,20						
20	2,00				2,00 (1,80 - 2,90)	3,51 A	570 (340 - 880)	285	2,80	3,20				3,20 (1,20 - 4,10)	3,95 A	810 (300 - 1.300)	405	4,00						
25	2,50				2,50 (1,80 - 2,90)	3,57 A	700 (340 - 880)	350	3,40	3,60				3,60 (1,20 - 4,30)	3,56 B	1.010 (300 - 1.300)	505	5,00						
35	3,20				3,20 (1,80 - 3,80)	3,68 A	870 (340 - 1.430)	435	4,20	4,50				4,50 (1,20 - 5,80)	3,46 B	1.300 (300 - 2.170)	650	6,30						
42	4,00				4,00 (1,80 - 4,30)	3,05 B	1.310 (340 - 2.060)	655	6,10	5,60				5,60 (1,20 - 6,80)	3,13 D	1.790 (300 - 3.000)	895	8,30						
50	5,00				5,00 (1,90 - 5,70)	2,90 C	1.725 (340 - 2.305)	863	8,00	6,80				6,80 (1,20 - 6,90)	2,99 D	2.275 (300 - 2.695)	1.138	10,50						
<b>2 Rooms</b>																								
16 + 16	1,60	1,60			3,20 (1,90 - 6,40)	4,16 A	770 (270 - 2.150)	385	3,60	2,60	2,60			5,20 (2,70 - 9,80)	3,61 A	1.440 (660 - 3.060)	720	6,70						
16 + 20	1,60	2,00			3,60 (1,90 - 6,40)	3,96 A	910 (270 - 2.110)	455	4,10	2,58	3,22			5,80 (2,70 - 9,80)	3,58 B	1.620 (650 - 3.060)	810	7,50						
16 + 25	1,60	2,50			4,10 (1,90 - 6,40)	3,83 A	1.070 (270 - 2.110)	535	4,80	2,38	3,72			6,10 (2,70 - 9,80)	3,55 B	1.720 (650 - 3.060)	860	8,00						
16 + 35	1,60	3,20			4,80 (1,90 - 6,90)	3,48 A	1.380 (270 - 2.500)	690	6,10	2,13	4,27			6,40 (2,70 - 9,90)	3,44 A	1.760 (630 - 3.070)	880	8,10						
16 + 42	1,60	4,00			5,60 (1,90 - 6,90)	3,08 B	1.820 (270 - 2.460)	910	8,00	2,29	5,71			8,00 (2,70 - 9,90)	3,39 C	2.360 (630 - 3.070)	1.180	10,90						
16 + 50	1,60	5,00			6,60 (2,00 - 7,50)	2,89 C	2.285 (280 - 2.645)	1.143	10,00	2,06	6,44			8,50 (2,80 - 10,20)	3,39 C	2.505 (560 - 3.145)	1.253	11,60						
20 + 20	2,00	2,00			4,00 (1,90 - 6,40)	3,85 A	1.040 (270 - 2.080)	520	4,70	2,90	2,90			5,80 (2,70 - 9,80)	3,67 A	1.580 (640 - 3.070)	790	7,40						
20 + 25	2,00	2,50			4,50 (1,90 - 6,40)	3,63 A	1.240 (270 - 2.080)	620	5,50	2,71	3,39			6,10 (2,70 - 9,80)	3,57 B	1.710 (640 - 3.070)	855	8,00						
20 + 35	2,00	3,20			5,20 (1,90 - 6,90)	3,29 A	1.580 (270 - 2.460)	790	7,00	2,69	4,31			7,00 (2,70 - 9,90)	3,50 B	2.000 (630 - 3.070)	1.000	9,20						
20 + 42	2,00	4,00			6,00 (1,90 - 6,90)	2,96 C	2.030 (270 - 2.420)	1.015	8,90	2,73	5,47			8,20 (2,70 - 9,90)	3,37 C	2.430 (620 - 3.070)	1.215	11,20						
20 + 50	1,94	4,86			6,80 (2,00 - 7,50)	2,80 C	2.425 (280 - 2.595)	1.213	10,60	2,43	6,07			8,50 (2,80 - 10,20)	3,39 C	2.505 (560 - 3.135)	1.253	11,60						
25 + 25					5,00 (1,90 - 6,80)	5,80 (6,80)¹	1.500 (270 - 2.450)	750	6,70	3,20	3,20			6,40 (2,70 - 9,80)	3,80 (5,50)¹	1.810 (640 - 3.070)	905	8,30						
25 + 35	2,50	2,50			5,00 (1,90 - 6,90)	3,33 A	1.860 (270 - 2.460)	930	8,20	3,55	5,55			8,10 (2,70 - 9,90)	3,54 B	2.390 (620 - 3.070)	1.195	11,00						
25 + 42	2,50	3,20			5,70 (1,90 - 6,90)	3,06 B	2.450 (270 - 2.460)	1.225	10,80	3,27	5,23			8,50 (2,70 - 9,90)	3,39 C	2.580 (620 - 3.070)	1.290	11,90						
25 + 50	2,27	4,53			6,80 (1,90 - 7,50)	2,65 D	2.425 (260 - 2.595)	1.213	10,60	2,83	5,67			8,50 (2,80 - 10,20)	3,29 C	2.505 (560 - 3.135)	1.253	11,60						
35 + 35	3,20	3,20			6,40 (1,90 - 7,00)	2,77 D	2.310 (270 - 2.420)	1.155	10,10	4,25	4,25			8,50 (2,80 - 10,00)	3,36 C	2.530 (640 - 3.070)	1.265	11,70						
35 + 42	3,02	3,78			6,80 (1,90 - 7,10)	2,57 E	2.650 (270 - 2.660)	1.325	11,60	3,78	4,72			8,50 (2,80 - 10,00)	3,36 C	2.530 (640 - 3.070)	1.265	11,70						
35 + 50	2,65	4,15			6,80 (2,00 - 7,60)	2,91 C	2.335 (280 - 2.605)	1.168	10,30	3,32	5,18			8,50 (2,80 - 10,30)	3,48 B	2.445 (540 - 3.125)	1.223	11,30						
42 + 42	3,40	3,40			6,80 (1,90 - 7,10)	2,57 E	2.650 (260 - 2.660)	1.325	11,60	4,25	4,25			8,50 (2,80 - 10,00)	3,37 C	2.520 (600 - 3.050)	1.260	11,60						
42 + 50	3,02	3,78			6,80 (2,00 - 7,60)	2,91 C	2.335 (280 - 2.555)	1.168	10,30	3,78	4,72			8,50 (2,80 - 10,30)	3,49 B	2.435 (540 - 3.115)	1.218	11,20						
50 + 50	3,40	3,40			6,80 (2,10 - 8,10)	3,08 B	2.210 (320 - 2.720)	1.105	9,70	4,25	4,25			8,50 (2,80 - 10,50)	3,54 B	2.400 (510 - 3.130)	1.200	11,10						
<b>3 Rooms</b>																								
16 + 16 + 16	1,60	1,60	1,60		4,80 (1,90 - 8,00)	3,90 A	1.230 (270 - 2.710)	615	5,50	2,60	2,60			7,80 (3,30 - 10,40)	3,70 A	2.110 (640 - 3.070)	1.055	9,70						
16 + 16 + 20	1,60	1,60	2,00		5,20 (1,90 - 8,00)	3,80 A	1.370 (270 - 2.670)	685	6,10	2,58	2,58			8,40 (3,30 - 10,60)	3,61 A	2.330 (640 - 3.060)	1.165	10,70						
16 + 16 + 25	1,60	1,60	2,50		5,70 (1,90 - 8,00)	3,56 A	1.600 (270 - 2.670)	800	7,10	2,39	2,39			8,50 (3,30 - 10,40)	3,59 B	2.370 (640 - 3.060)	1.185	10,90						
16 + 16 + 35	1,60	1,60	3,20		6,40 (1,90 - 8,00)	3,39 A	1.890 (270 - 2.580)	945	8,30	2,13	2,13			8,50 (3,30 - 10,40)	3,68 A	2.310 (630 - 3.040)	1.155	10,70						
16 + 16 + 42	1,51	1,51	3,78		6,80 (1,90 - 8,10)	3,21 A	2.120 (270 - 2.670)	1.060	9,30	1,89	1,89			8,50 (3,30 - 10,50)	3,70 A	2.300 (620 - 3.070)	1.150	10,60						
16 + 16 + 50	1,33	1,33	4,14		6,80 (2,00 - 8,50)	3,26 A	2.085 (320 - 2.735)	1.043	9,20	1,66	1,66			8,50 (3,20 - 10,60)	3,74 A	2.275 (600 - 3.035)	1.138	10,50						
16 + 20 + 20	1,60	2,00	2,00		5,60 (1,90 - 8,00)	3,68 A	1.520 (270 - 2.670)	760	6,70	2,42	3,04			8,50 (3,30 - 10,40)	3,60 A	2.360 (630 - 3.050)	1.180	10,90						
16 + 20 + 25	1,60	2,00	2,50		6,10 (1,90 - 8,00)	3,45 A	1.770 (270 - 2.670)	885	7,80	2,23	2,79			8,50 (3,30 - 10,40)	3,60 A	2.360 (630 - 3.050)	1.180	10,90						
16 + 20 + 35	1,60	2,00	3,20		6,80 (1,90 - 8,00)	3,21 A	2.120 (270 - 2.580)	1.060	9,30	2,00	2,50			8,50 (3,30 - 10,40)	3,70 A	2.300 (620 - 2.990)	1.150	10,60						
16 + 20 + 42	1,43	1,79	3,58		6,80 (1,90 - 8,10)	6,40 (6,80)¹	2.120 (270 - 2.630)	1.060	9,30	1,79	2,24			8,50 (3,30 - 10,50)	3,71 A	2.290 (620 - 3.020)	1.145	10,60						
16 + 20 + 50	1,27	1,58	3,95		6,80 (2,00 - 8,50)	3,34 A	2.035 (320 - 2.735)	1.018	8,90	1,58	1,98			8,50 (3,20 - 10,60)	3,75 A	2.265 (600 - 3.025)	1.133	10,40						
16 + 25 + 25	1,60	2,50	2,50		6,60 (1,90 - 8,00)	3,25 A	2.030 (270 - 2.670)	1.015	8,90	2,06	3,22			8,50 (3,30 - 10,40)	3,60 A	2.360 (630 - 3.050)	1.180	10,90						
16 + 25 + 35	1,49	2,33	2,98		6,80 (1,90 - 8,00)	3,21 A	2.120 (270 - 2.580)	1.060	9,30	1,86	2,91			8,50 (3,30 - 10,40)	3,70 A	2.300 (620 - 2.990)	1.150	10,60						
16 + 25 + 42	1,34	2,10	3,36		6,80 (1,90 - 8,10)	3,21 A	2.120 (270 - 2.630)	1.060	9,30	1,68	2,62			8,50 (3,30 - 10,50)	3,71 A	2.290 (620 - 3.020)	1.145	10,60						
16 + 25 + 50	1,19	1,87	3,74		6,80 (2,00 - 8,50)	3,34 A	2.035 (320 - 2.735)	1.018	8,90	1,49	3,44			8,50 (3,20 - 10,60)	3,75 A	2.265 (600 - 3.025)	1.133	10,40						
16 + 35 + 35	1,36	2,72	2,72		6,80 (1,90 - 8,10)	3,29 A	2.070 (290 - 2.580)	1.035	9,10	1,70	3,40			8,50 (3,30 - 10,50)	3,73 A	2.280 (640 - 3.000)	1.140	10,50						
16 + 35 + 42	1,24	2,47	3,09		6,80 (1,90 - 8,20)	3,29 A	2.070 (290 - 2.630)	1.035	9,10	1,55	3,09			8,50 (3,30 - 10,50)	3,74 A	2.270 (640 - 3.000)	1.135	10,50						
16 + 35 + 50	1,11	2,22	3,47		6,80 (2,00 - 8,50)	3,34 A	2.035 (340 - 2.695)	1.018	8,90	1,38	2,78			8,50 (3,20 - 10,60)	3,79 A	2.245 (600 - 2.995)	1.123	10,40						
16 + 42 + 42	1,14	2,83	2,83		6,80 (1,90 - 8,20)	3,29 A	2.070 (290 - 2.630)	1.035	9,10	1,42	3,54			8,50 (3,30 - 10,50)	3,76 A	2.260 (640 - 2.990)	1.130	10,40						
16 + 42 + 50	1,02	2,57	3,21		6,80 (2,00 - 8,50)	3,34 A	2.035 (340 - 2.645)	1.018	8,90	1,28	3,21			8,50 (3,20 - 10,60)	3,80 A	2.235 (600 - 2.985)	1.118	10,30			</			





# FREE MULTI 4X1 COMBINATIONS TABLE

Free Multi 4x1 CU-4E27PBE. Minimum capacity connected: 4.5kW. Maximum capacity connected: 13.6 kW • R410 GAS

Indoor unit capacity	Cooling capacity (kW)					EER	Input power rating		A.E.C.	Current	Heating capacity (kW)					COP	Input power rating		A.E.C.	Current			
	Rooms						W/W	W			kWh	Rooms					W/W	W			kWh	230V	
	A	B	C	D	Total (Min - Max)							A	B	C	D								Total (Min - Max)
16 + 25 + 42	1.58	2.47	3.95		8,00 (3.00 - 8.60)	3,20 B	2.500 (480 - 3.240)	1.250	11,90	1,70	2.66	4.25		8,61 (3.20 - 10.40)	3,90 A	2.210 (500 - 3.490)	1.105	10,40					
16 + 25 + 50	1.40	2.20	4.40		8,00 (3.00 - 8.60)	3,31 A	2.415 (520 - 3.045)	1.208	11,50	1,51	2.37	4.73		8,61 (3.20 - 10.50)	3,89 A	2.215 (520 - 3.435)	1.108	10,40					
16 + 25 + 71	1.15	1.80	5.05		8,00 (3.00 - 8.80)	3,40 A	2.355 (520 - 3.115)	1.178	11,20	1,24	1.94	5.43		8,61 (3.20 - 10.60)	3,90 A	2.205 (520 - 3.485)	1.103	10,40					
16 + 35 + 35	1.60	3.20	3.20		8,00 (3.00 - 8.60)	3,28 A	2.440 (480 - 3.160)	1.220	11,60	1,73	3.44	3.44		8,61 (3.20 - 10.40)	3,93 A	2.190 (500 - 3.460)	1.095	10,30					
16 + 35 + 42	1.45	2.91	3.64		8,00 (3.00 - 8.60)	3,28 A	2.440 (480 - 3.160)	1.220	11,60	1,57	3.13	3.91		8,61 (3.20 - 10.50)	3,95 A	2.180 (490 - 3.450)	1.090	10,20					
16 + 35 + 50	1.31	2.61	4.08		8,00 (3.00 - 8.60)	3,40 A	2.355 (520 - 2.965)	1.178	11,20	1,41	2.81	4.39		8,61 (3.20 - 10.50)	3,94 A	2.185 (520 - 3.405)	1.093	10,30					
16 + 35 + 71	1.08	2.17	4.75		8,00 (3.00 - 9.00)	3,40 A	2.355 (520 - 3.185)	1.178	11,20	1,17	2.33	5.11		8,61 (3.20 - 10.60)	3,96 A	2.175 (520 - 3.445)	1.088	10,20					
16 + 42 + 42	1.34	3.33	3.33		8,00 (3.00 - 8.60)	3,28 A	2.440 (480 - 3.160)	1.220	11,60	1,43	3.59	3.59		8,61 (3.20 - 10.50)	3,95 A	2.180 (490 - 3.440)	1.090	10,20					
16 + 42 + 50	1.21	3.02	3.77		8,00 (3.00 - 8.80)	3,40 A	2.355 (520 - 3.115)	1.178	11,20	1,30	3.25	4.06		8,61 (3.20 - 10.50)	3,94 A	2.185 (520 - 3.385)	1.093	10,30					
16 + 42 + 71	1.02	2.54	4.44		8,00 (3.00 - 9.00)	3,49 A	2.295 (520 - 3.115)	1.148	10,90	1,09	2.73	4.79		8,61 (3.20 - 10.60)	3,96 A	2.175 (530 - 3.435)	1.088	10,20					
16 + 50 + 50	1.10	3.45	3.45		8,00 (3.00 - 8.80)	3,42 A	2.340 (570 - 3.000)	1.170	11,10	1,19	3.71	3.71		8,61 (3.20 - 10.60)	3,90 A	2.210 (580 - 3.420)	1.105	10,40					
16 + 50 + 71	0.94	2.94	4.12		8,00 (3.00 - 9.00)	3,42 A	2.340 (570 - 3.070)	1.170	11,10	1,01	3.17	4.43		8,61 (3.20 - 10.60)	3,84 A	2.240 (610 - 3.410)	1.120	10,50					
20 + 20 + 20	2.00	2.00	2.00		6,00 (3.00 - 8.50)	3,51 A	1.710 (480 - 3.240)	855	8,20	2,87	2,87	2,87		8,61 (3.20 - 10.40)	3,84 A	2.240 (500 - 3.530)	1.120	10,50					
20 + 20 + 25	2.00	2.00	2.50		6,50 (3.00 - 8.50)	3,35 A	1.940 (480 - 3.240)	970	9,20	2,77	2,77	3,46		9,00 (3.20 - 10.40)	3,78 A	2.380 (500 - 3.530)	1.190	11,20					
20 + 20 + 35	2.00	2.00	3.20		7,20 (3.00 - 8.50)	3,35 A	2.150 (480 - 3.160)	1.075	10,20	2,61	2,61	4,18		9,40 (3.20 - 10.40)	3,76 A	2.500 (500 - 3.490)	1.250	11,70					
20 + 20 + 42	2.00	2.00	4.00		8,00 (3.00 - 8.60)	3,20 B	2.500 (480 - 3.240)	1.250	11,90	2,35	2,35	4,70		9,40 (3.20 - 10.40)	3,78 A	2.490 (500 - 3.470)	1.245	11,70					
20 + 20 + 50	1.78	1.78	4.44		8,00 (3.00 - 8.60)	3,40 A	2.355 (520 - 2.965)	1.178	11,20	2,09	2,09	5,22		9,40 (3.20 - 10.50)	3,80 A	2.475 (520 - 3.425)	1.238	11,60					
20 + 20 + 71	1.45	1.45	5.10		8,00 (3.00 - 8.80)	3,40 A	2.355 (520 - 3.035)	1.178	11,20	1,71	1,71	5,98		9,40 (3.20 - 10.50)	3,81 A	2.465 (520 - 3.405)	1.233	11,60					
20 + 25 + 25	2.00	2.50	2.50		7,00 (3.00 - 8.50)	3,33 A	2.100 (480 - 3.240)	1.050	10,00	2,68	3,36	3,36		9,40 (3.20 - 10.40)	3,72 A	2.530 (500 - 3.530)	1.265	11,90					
20 + 25 + 35	2.00	2.50	3.20		7,70 (3.00 - 8.50)	3,32 A	2.320 (480 - 3.160)	1.160	11,00	2,44	3,05	3,91		9,40 (3.20 - 10.40)	3,76 A	2.500 (500 - 3.490)	1.250	11,70					
20 + 25 + 42	1.88	2.35	3.77		8,00 (3.00 - 8.60)	3,20 B	2.500 (480 - 3.240)	1.250	11,90	2,21	2,76	4,43		9,40 (3.20 - 10.40)	3,78 A	2.490 (500 - 3.470)	1.245	11,70					
20 + 25 + 50	1.68	2.11	4.21		8,00 (3.00 - 8.60)	3,40 A	2.355 (520 - 2.965)	1.178	11,20	1,98	2,47	4,95		9,40 (3.20 - 10.50)	3,80 A	2.475 (520 - 3.420)	1.238	11,60					
20 + 25 + 71	1.39	1.74	4.87		8,00 (3.00 - 8.80)	3,40 A	2.355 (520 - 3.035)	1.178	11,20	1,63	2,04	5,73		9,40 (3.20 - 10.60)	3,81 A	2.465 (520 - 3.465)	1.233	11,60					
20 + 35 + 35	1.90	3.05	3.05		8,00 (3.00 - 8.60)	3,28 A	2.440 (480 - 3.160)	1.220	11,60	2,24	3,58	3,58		9,40 (3.20 - 10.40)	3,81 A	2.470 (490 - 3.450)	1.235	11,60					
20 + 35 + 42	1.74	2.78	3.48		8,00 (3.00 - 8.60)	3,28 A	2.440 (480 - 3.160)	1.220	11,60	2,04	3,27	4,09		9,40 (3.20 - 10.50)	3,82 A	2.460 (490 - 3.440)	1.230	11,60					
20 + 35 + 50	1.57	2.51	3.92		8,00 (3.00 - 8.80)	3,40 A	2.355 (520 - 3.115)	1.178	11,20	1,84	2,95	4,61		9,40 (3.20 - 10.50)	3,83 A	2.455 (520 - 3.385)	1.228	11,50					
20 + 35 + 71	1.31	2.10	4.59		8,00 (3.00 - 9.00)	3,49 A	2.295 (520 - 3.115)	1.148	10,90	1,54	2,47	5,39		9,40 (3.20 - 10.60)	3,86 A	2.435 (530 - 3.435)	1.218	11,40					
20 + 42 + 42	1.60	3.20	3.20		8,00 (3.00 - 8.80)	3,28 A	2.440 (480 - 3.240)	1.220	11,60	1,88	3,76	3,76		9,40 (3.20 - 10.50)	3,84 A	2.450 (490 - 3.420)	1.225	11,50					
20 + 42 + 50	1.45	2.91	3.64		8,00 (3.00 - 8.60)	3,40 A	2.355 (520 - 3.035)	1.178	11,20	1,71	3,42	4,27		9,40 (3.20 - 10.50)	3,84 A	2.445 (530 - 3.375)	1.223	11,50					
20 + 42 + 71	1.23	2.46	4.31		8,00 (3.00 - 9.00)	3,49 A	2.295 (520 - 3.115)	1.148	10,90	1,45	2,89	5,06		9,40 (3.20 - 10.60)	3,86 A	2.435 (530 - 3.425)	1.218	11,40					
20 + 50 + 50	1.34	3.33	3.33		8,00 (3.00 - 9.00)	3,42 A	2.340 (570 - 3.070)	1.170	11,10	1,56	3,92	3,92		9,40 (3.20 - 10.60)	3,82 A	2.460 (600 - 3.410)	1.230	11,60					
25 + 25 + 25	2.50	2.50	2.50		7,50 (3.00 - 8.50)	3,21 A	2.340 (480 - 3.240)	1.170	11,10	3,13	3,13	3,13		9,39 (3.20 - 10.40)	3,71 A	2.530 (500 - 3.530)	1.265	11,90					
25 + 25 + 35	2.44	2.44	3.12		8,00 (3.00 - 8.60)	3,20 B	2.500 (480 - 3.240)	1.250	11,90	2,87	2,87	3,66		9,40 (3.20 - 10.40)	3,76 A	2.500 (500 - 3.490)	1.250	11,70					
25 + 25 + 42	2.22	2.22	3.56		8,00 (3.00 - 8.60)	3,20 B	2.500 (480 - 3.240)	1.250	11,90	2,61	2,61	4,18		9,40 (3.20 - 10.50)	3,78 A	2.490 (500 - 3.540)	1.245	11,70					
25 + 25 + 50	2.00	2.00	4.00		8,00 (3.00 - 8.80)	3,40 A	2.355 (520 - 3.115)	1.178	11,20	2,35	2,35	4,70		9,40 (3.20 - 10.50)	3,80 A	2.475 (520 - 3.425)	1.238	11,60					
25 + 25 + 71	1.67	1.67	4.66		8,00 (3.00 - 9.00)	3,40 A	2.355 (520 - 3.185)	1.178	11,20	1,96	1,96	5,48		9,40 (3.20 - 10.60)	3,81 A	2.465 (520 - 3.465)	1.233	11,60					
25 + 35 + 35	2.24	2.88	2.88		8,00 (3.00 - 8.60)	3,28 A	2.440 (480 - 3.160)	1.220	11,60	2,64	3,38	3,38		9,40 (3.20 - 10.50)	3,81 A	2.470 (490 - 3.450)	1.235	11,60					
25 + 35 + 42	2.06	2.64	3.30		8,00 (3.00 - 8.60)	3,28 A	2.440 (480 - 3.160)	1.220	11,60	2,42	3,10	3,88		9,40 (3.20 - 10.50)	3,82 A	2.460 (490 - 3.440)	1.230	11,60					
25 + 35 + 50	1.87	2.39	3.74		8,00 (3.00 - 8.80)	3,40 A	2.355 (520 - 3.115)	1.178	11,20	2,20	2,81	4,39		9,40 (3.20 - 10.50)	3,83 A	2.455 (520 - 3.385)	1.228	11,50					
25 + 35 + 71	1.57	2.02	4.41		8,00 (3.00 - 9.00)	3,49 A	2.295 (520 - 3.115)	1.148	10,90	1,85	3,37	5,18		9,40 (3.20 - 10.60)	3,86 A	2.435 (530 - 3.435)	1.218	11,40					
25 + 42 + 42	1.90	3.05	3.05		8,00 (3.00 - 8.80)	3,28 A	2.440 (480 - 3.240)	1.220	11,60	2,24	3,58	3,58		9,40 (3.20 - 10.50)	3,84 A	2.450 (490 - 3.420)	1.225	11,50					
25 + 42 + 50	1.74	2.78	3.48		8,00 (3.00 - 8.60)	3,40 A	2.355 (520 - 3.035)	1.178	11,20	2,04	3,27	4,09		9,40 (3.20 - 10.60)	3,84 A	2.445 (530 - 3.425)	1.223	11,50					
25 + 42 + 71	1.48	2.37	4.15		8,00 (3.00 - 9.00)	3,49 A	2.295 (520 - 3.115)	1.148	10,90	1,74	2,79	4,87		9,40 (3.20 - 10.60)	3,86 A	2.435 (530 - 3.425)	1.218	11,40					
25 + 50 + 50	1.60	3.20	3.20		8,00 (3.00 - 9.00)	3,42 A	2.340 (570 - 3.070)	1.170	11,10	1,88	3,76	3,76		9,40 (3.20 - 10.60)	3,82 A	2.460 (600 - 3.410)	1.230	11,60					
35 + 35 + 35	2.66	2.66	2.66		7,98 (3.00 - 8.60)	3,35 A	2.380 (480 - 3.090)	1.190	11,30	3,13	3,13	3,13		9,39 (3.20 - 10.50)	3,85 A	2.440 (490 - 3.410)	1.220	11,50					
35 + 35 + 42	2.46	2.46	3.08		8,00 (3.00 - 8.80)	3,36 A	2.380 (480 - 3.240)	1.190	11,30	2,89	2,89	3,62		9,40 (3.20 - 10.50)	3,87 A	2.430 (490 - 3.400)	1.215	11,40					
35 + 35 + 50	2.25	2.25	3.50		8,00 (3.00 - 8.60)	3,49 A	2.295 (520 - 3.035)	1.148	10,90	2,64	2,64	4,12		9,40 (3.20 - 10.60)	3,88 A	2.425 (530 - 3.415)	1.213	11,40					
35 + 35 + 71	1.91	1.91	4.18		8,00 (3.00 - 9.00)	3,49 A	2.295 (520 - 3.115)	1.148	10,90	2,24	2,24	4,92		9,40 (3.20 - 10.60)	3,89 A	2.415 (530 - 3.405)	1.208	11,30					
35 + 42 + 42	2.28	2.86	2.86																				

Free Multi 4x1 CU-4E27PBE. Minimum capacity connected: 4,5kW. Maximum capacity connected: 13,6 kW = R410 GAS

Indoor unit capacity	Cooling capacity (kW)					EER	Input power rating		A.E.C.	Current	Heating capacity (kW)					COP	Input power rating		A.E.C.	Current			
	Rooms						W/W	W			kWh	Rooms					W/W	W			kWh	230V	
	A	B	C	D	Total (Min - Max)							A	B	C	D								Total (Min - Max)
16 + 20 + 42 + 50	1,02	1,27	2,54	3,17	8,00 (3,00 - 9,20)	3,55 A	2.255 (630 - 3.045)	1.128	10,70	1,19	1,49	2,98	3,74	9,40 (4,20 - 10,60)	3,91 A	2.405 (830 - 3.325)	1.203	11,30					
16 + 20 + 50 + 50	0,94	1,18	2,94	2,94	8,00 (3,00 - 9,20)	3,36 A	2.380 (690 - 3.090)	1.190	11,30	1,10	1,38	3,46	3,46	9,40 (4,20 - 10,60)	3,69 A	2.550 (950 - 3.460)	1.275	12,00					
16 + 25 + 25 + 25	1,40	2,20	2,20	2,20	8,00 (3,00 - 9,20)	3,54 A	2.260 (530 - 3.150)	1.130	10,70	1,66	2,58	2,58	2,58	9,40 (4,20 - 10,60)	3,97 A	2.370 (700 - 3.350)	1.185	11,10					
16 + 25 + 25 + 35	1,31	2,04	2,04	2,61	8,00 (3,00 - 9,20)	3,64 A	2.200 (570 - 3.080)	1.100	10,40	1,53	2,40	2,40	2,40	9,40 (4,20 - 10,60)	4,00 A	2.350 (730 - 3.320)	1.175	11,00					
16 + 25 + 25 + 42	1,20	1,89	1,89	3,02	8,00 (3,00 - 9,20)	3,64 A	2.200 (570 - 3.080)	1.100	10,40	1,41	2,22	2,22	3,55	9,40 (4,20 - 10,60)	4,02 A	2.340 (730 - 3.310)	1.170	11,00					
16 + 25 + 25 + 50	1,10	1,72	1,72	3,46	8,00 (3,00 - 9,20)	3,55 A	2.255 (620 - 3.035)	1.128	10,70	1,29	2,03	2,03	4,05	9,40 (4,20 - 10,60)	3,89 A	2.415 (810 - 3.350)	1.208	11,30					
16 + 25 + 25 + 71	0,94	1,47	1,47	4,12	8,00 (3,00 - 9,20)	3,55 A	2.255 (630 - 3.045)	1.128	10,70	1,10	1,73	1,73	4,84	9,40 (4,20 - 10,60)	3,89 A	2.415 (820 - 3.345)	1.208	11,30					
16 + 25 + 35 + 35	1,22	1,90	2,44	2,44	8,00 (3,00 - 9,20)	3,64 A	2.200 (570 - 3.080)	1.100	10,40	1,43	2,25	2,86	2,86	9,40 (4,20 - 10,60)	4,03 A	2.330 (740 - 3.290)	1.165	10,90					
16 + 25 + 35 + 42	1,13	1,77	2,27	2,83	8,00 (3,00 - 9,20)	3,64 A	2.200 (570 - 3.080)	1.100	10,40	1,33	2,08	2,66	3,33	9,40 (4,20 - 10,60)	4,05 A	2.320 (740 - 3.280)	1.160	10,90					
16 + 25 + 35 + 50	1,04	1,63	2,08	3,25	8,00 (3,00 - 9,20)	3,55 A	2.255 (630 - 3.045)	1.128	10,70	1,22	1,91	2,45	3,82	9,40 (4,20 - 10,60)	3,91 A	2.405 (820 - 3.335)	1.203	11,30					
16 + 25 + 42 + 42	1,06	1,66	2,64	2,64	8,00 (3,00 - 9,20)	3,64 A	2.200 (570 - 3.080)	1.100	10,40	1,24	1,94	3,11	3,11	9,40 (4,20 - 10,60)	4,05 A	2.320 (740 - 3.270)	1.160	10,90					
16 + 25 + 42 + 50	0,98	1,53	2,44	3,05	8,00 (3,00 - 9,20)	3,55 A	2.255 (630 - 3.045)	1.128	10,70	1,15	1,79	2,87	3,59	9,40 (4,20 - 10,60)	3,91 A	2.405 (830 - 3.325)	1.203	11,30					
16 + 35 + 35 + 35	1,13	2,29	2,29	2,29	8,00 (3,00 - 9,20)	3,64 A	2.200 (570 - 3.080)	1.100	10,40	1,33	2,69	2,69	2,69	9,40 (4,20 - 10,60)	4,07 A	2.310 (740 - 3.260)	1.155	10,90					
16 + 35 + 35 + 42	1,07	2,13	2,13	2,67	8,00 (3,00 - 9,20)	3,64 A	2.200 (570 - 3.080)	1.100	10,40	1,25	2,51	2,51	3,13	9,40 (4,20 - 10,60)	4,07 A	2.310 (770 - 3.280)	1.155	10,90					
16 + 35 + 35 + 50	0,98	1,97	1,97	3,08	8,00 (3,00 - 9,20)	3,55 A	2.255 (630 - 3.045)	1.128	10,70	1,16	2,31	2,31	3,62	9,40 (4,20 - 10,60)	3,86 A	2.435 (860 - 3.315)	1.218	11,40					
16 + 35 + 42 + 42	1,00	2,00	2,50	2,50	8,00 (3,00 - 9,20)	3,64 A	2.200 (570 - 3.080)	1.100	10,40	1,17	2,35	2,94	2,94	9,40 (4,20 - 10,60)	4,09 A	2.300 (770 - 3.240)	1.150	10,80					
16 + 42 + 42 + 42	0,95	2,35	2,35	2,35	8,00 (3,00 - 9,20)	3,64 A	2.200 (570 - 3.080)	1.100	10,40	1,12	2,76	2,76	2,76	9,40 (4,20 - 10,60)	4,10 A	2.290 (770 - 3.230)	1.145	10,80					
20 + 20 + 20 + 20	2,00	2,00	2,00	2,00	8,00 (3,00 - 9,20)	3,54 A	2.260 (530 - 3.150)	1.130	10,70	2,35	2,35	2,35	2,35	9,40 (4,20 - 10,60)	3,98 A	2.360 (700 - 3.340)	1.180	11,10					
20 + 20 + 20 + 25	1,88	1,88	1,88	2,36	8,00 (3,00 - 9,20)	3,54 A	2.260 (530 - 3.150)	1.130	10,70	2,21	2,21	2,21	2,77	9,40 (4,20 - 10,60)	3,98 A	2.360 (700 - 3.340)	1.180	11,10					
20 + 20 + 20 + 35	1,74	1,74	1,74	2,78	8,00 (3,00 - 9,20)	3,64 A	2.200 (570 - 3.080)	1.100	10,40	2,04	2,04	2,04	3,28	9,40 (4,20 - 10,60)	4,02 A	2.340 (730 - 3.310)	1.170	11,00					
20 + 20 + 20 + 42	1,60	1,60	1,60	3,20	8,00 (3,00 - 9,20)	3,64 A	2.200 (570 - 3.080)	1.100	10,40	1,88	1,88	1,88	3,76	9,40 (4,20 - 10,60)	4,02 A	2.340 (730 - 3.300)	1.170	11,00					
20 + 20 + 20 + 50	1,45	1,45	1,45	3,65	8,00 (3,00 - 9,20)	3,55 A	2.255 (620 - 3.035)	1.128	10,70	1,71	1,71	1,71	4,27	9,40 (4,20 - 10,60)	3,89 A	2.415 (810 - 3.345)	1.208	11,30					
20 + 20 + 20 + 71	1,23	1,23	1,23	4,31	8,00 (3,00 - 9,20)	3,55 A	2.255 (630 - 3.045)	1.128	10,70	1,45	1,45	1,45	5,05	9,40 (4,20 - 10,60)	3,91 A	2.405 (820 - 3.335)	1.203	11,30					
20 + 20 + 25 + 25	1,78	1,78	2,22	2,22	8,00 (3,00 - 9,20)	3,54 A	2.260 (530 - 3.150)	1.130	10,70	2,09	2,09	2,61	2,61	9,40 (4,20 - 10,60)	3,98 A	2.360 (700 - 3.340)	1.180	11,10					
20 + 20 + 25 + 35	1,65	1,65	2,06	2,64	8,00 (3,00 - 9,20)	3,64 A	2.200 (570 - 3.080)	1.100	10,40	1,94	1,94	2,42	3,10	9,40 (4,20 - 10,60)	4,02 A	2.340 (730 - 3.310)	1.170	11,10					
20 + 20 + 25 + 42	1,52	1,52	1,90	3,06	8,00 (3,00 - 9,20)	3,64 A	2.200 (570 - 3.080)	1.100	10,40	1,79	1,79	2,24	3,58	9,40 (4,20 - 10,60)	4,02 A	2.340 (730 - 3.300)	1.170	11,10					
20 + 20 + 25 + 50	1,39	1,39	1,74	3,48	8,00 (3,00 - 9,20)	3,55 A	2.255 (620 - 3.035)	1.128	10,70	1,63	1,63	2,04	4,10	9,40 (4,20 - 10,60)	3,89 A	2.415 (810 - 3.345)	1.208	11,30					
20 + 20 + 25 + 71	1,19	1,19	1,47	4,15	8,00 (3,00 - 9,20)	3,55 A	2.255 (630 - 3.045)	1.128	10,70	1,39	1,39	1,74	4,88	9,40 (4,20 - 10,60)	3,91 A	2.405 (820 - 3.335)	1.203	11,30					
20 + 20 + 35 + 35	1,54	1,54	2,46	2,46	8,00 (3,00 - 9,20)	3,64 A	2.200 (570 - 3.080)	1.100	10,40	1,81	1,81	2,89	2,89	9,40 (4,20 - 10,60)	4,05 A	2.320 (740 - 3.280)	1.160	10,90					
20 + 20 + 35 + 42	1,43	1,43	2,28	2,86	8,00 (3,00 - 9,20)	3,64 A	2.200 (570 - 3.080)	1.100	10,40	1,68	1,68	2,68	3,36	9,40 (4,20 - 10,60)	4,05 A	2.320 (740 - 3.270)	1.160	10,90					
20 + 20 + 35 + 50	1,31	1,31	2,10	3,28	8,00 (3,00 - 9,20)	3,55 A	2.255 (630 - 3.045)	1.128	10,70	1,54	1,54	2,47	3,85	9,40 (4,20 - 10,60)	3,91 A	2.405 (830 - 3.325)	1.203	11,30					
20 + 20 + 42 + 42	1,33	1,33	2,67	2,67	8,00 (3,00 - 9,20)	3,64 A	2.200 (570 - 3.080)	1.100	10,40	1,57	1,57	3,13	3,13	9,40 (4,20 - 10,60)	4,07 A	2.310 (740 - 3.260)	1.155	10,90					
20 + 20 + 42 + 50	1,23	1,23	2,46	3,08	8,00 (3,00 - 9,20)	3,55 A	2.255 (630 - 3.045)	1.128	10,70	1,45	1,45	2,88	3,62	9,40 (4,20 - 10,60)	3,86 A	2.435 (830 - 3.315)	1.218	11,40					
20 + 25 + 25 + 25	1,67	2,11	2,11	2,11	8,00 (3,00 - 9,20)	3,54 A	2.260 (530 - 3.150)	1.130	10,70	1,99	2,47	2,47	2,47	9,40 (4,20 - 10,60)	3,98 A	2.360 (700 - 3.340)	1.180	11,10					
20 + 25 + 25 + 35	1,57	1,96	1,96	2,51	8,00 (3,00 - 9,20)	3,64 A	2.200 (570 - 3.080)	1.100	10,40	1,84	2,30	2,30	2,96	9,40 (4,20 - 10,60)	4,02 A	2.340 (730 - 3.310)	1.170	11,00					
20 + 25 + 25 + 42	1,45	1,82	1,82	2,91	8,00 (3,00 - 9,20)	3,64 A	2.200 (570 - 3.080)	1.100	10,40	1,70	2,14	2,14	3,42	9,40 (4,20 - 10,60)	4,02 A	2.340 (730 - 3.300)	1.170	11,00					
20 + 25 + 25 + 50	1,33	1,67	1,67	3,33	8,00 (3,00 - 9,20)	3,55 A	2.255 (620 - 3.035)	1.128	10,70	1,56	1,96	1,96	3,92	9,40 (4,20 - 10,60)	3,89 A	2.415 (810 - 3.345)	1.208	11,30					
20 + 25 + 35 + 35	1,47	1,83	2,35	2,35	8,00 (3,00 - 9,20)	3,64 A	2.200 (570 - 3.080)	1.100	10,40	1,72	2,16	2,76	2,76	9,40 (4,20 - 10,60)	4,05 A	2.320 (740 - 3.280)	1.160	10,90					
20 + 25 + 35 + 42	1,36	1,71	2,19	2,74	8,00 (3,00 - 9,20)	3,64 A	2.200 (570 - 3.080)	1.100	10,40	1,61	2,01	2,57	3,21	9,40 (4,20 - 10,60)	4,05 A	2.320 (740 - 3.270)	1.160	10,90					
20 + 25 + 35 + 50	1,26	1,57	2,02	3,15	8,00 (3,00 - 9,20)	3,55 A	2.255 (630 - 3.045)	1.128	10,70	1,48	1,85	2,37	3,70	9,40 (4,20 - 10,60)	3,91 A	2.405 (830 - 3.325)	1.203	11,30					
20 + 25 + 42 + 42	1,28	1,60	2,56	2,56	8,00 (3,00 - 9,20)	3,64 A	2.200 (570 - 3.080)	1.100	10,40	1,50	1,88	3,01	3,01	9,40 (4,20 - 10,60)	4,07 A	2.310 (740 - 3.260)	1.155	10,90					
20 + 25 + 42 + 50	1,19	1,48	2,37	2,96	8,00 (3,00 - 9,20)	3,55 A	2.255 (630 - 3.045)	1.128	10,70	1,39	1,74	2,79	3,48	9,40 (4,20 - 10,60)	3,86 A	2.435 (830 - 3.315)	1.218	11,40					
20 + 35 + 35 + 35	1,37	2,21	2,21	2,21	8,00 (3,00 - 9,20)	3,64 A	2.200 (570 - 3.080)	1.100	10,40	1,63	2,59	2,59	2,59	9,40 (4,20 - 10,60)	4,07 A	2.310 (770 - 3.250)	1.155	10,90					
20 + 35 + 35 + 42	1,29	2,06	2,06	2,59	8,00 (3,00 - 9,20)	3,64 A	2.200 (570 - 3.080)	1.100	10,40	1,51	2,43	2,43	3,03	9,40 (4,20 - 10,60)	4,09 A	2.300 (770 - 3.240)	1.150	10,80					
20 + 35 + 35 + 50	1,19	1,91	1,91	2,99	8,00 (3,00 - 9,20)	3,55 A	2.255 (630 - 3.045)	1.128	10,70	1,40	2,24	2,24	3,52	9,40 (4,20 - 10,60)	3,86 A	2.435 (860 - 3.305)	1.218	11,40					
20 + 35 + 42 + 42	1,21	1,95	2,42	2,42	8,00 (3,00 - 9,20)	3,64 A	2.200 (570 - 3.080)	1.100	10,40	1,42	2,28	2,85	2,85	9,40 (4,20 - 10,60)									

# FREE MULTI 5X1 COMBINATIONS TABLE

Free Multi 5x1 CU-5E34PBE. Minimum capacity connected: 4.5kW. Maximum capacity connected: 17.5kW • R410 GAS

Indoor unit capacity	Cooling capacity (kW)						EER	Input power rating	A.E.C.	Current	Heating capacity (kW)						COP	Input power rating	A.E.C.	Current
	Rooms										Rooms									
	A	B	C	D	E	Total (Min - Max)					W/W	W	kWh	230V	A	B				
<b>1 Room</b>																				
16	1.60					1.60 (1.30 - 2.30)	3.40 A	470 (250 - 710)	235	2.30	2.60					2.60 (1.20 - 3.20)	3.88 A	670 (300 - 1.030)	335	3.20
20	2.00					2.00 (1.80 - 2.90)	3.51 A	570 (340 - 880)	285	2.80	3.20					3.20 (1.20 - 4.10)	4.21 A	760 (300 - 1.250)	380	3.70
25	2.50					2.50 (1.80 - 2.90)	3.57 A	700 (340 - 880)	350	3.40	3.60					3.60 (1.20 - 4.30)	3.75 A	960 (300 - 1.250)	480	4.80
35	3.20					3.20 (1.80 - 3.80)	3.68 A	870 (340 - 1.430)	435	4.20	4.50					4.50 (1.20 - 5.80)	3.60 B	1.250 (300 - 2.120)	625	6.10
42	4.00					4.00 (1.80 - 4.30)	3.05 B	1.310 (340 - 2.060)	655	6.10	5.60					5.60 (1.20 - 6.80)	3.22 C	1.740 (300 - 2.950)	870	8.10
50	5.00					5.00 (1.90 - 5.70)	2.90 C	1.725 (340 - 2.305)	863	8.00	6.80					6.80 (1.20 - 6.90)	3.16 D	2.150 (300 - 2.570)	1.075	9.90
71	7.00					7.00 (2.00 - 7.20)	2.63 D	2.665 (370 - 2.945)	1.333	12.10	8.70					8.70 (1.40 - 9.20)	3.35 C	2.600 (680 - 2.770)	1.300	12.00
<b>2 Rooms</b>																				
16 + 16	1.60	1.60				3.20 (2.40 - 5.80)	3.68 A	870 (300 - 2.060)	435	4.20	2.35	2.35				4.70 (2.00 - 8.20)	3.05 D	1.540 (260 - 2.920)	770	7.30
16 + 20	1.60	2.00				3.60 (2.40 - 5.80)	3.56 A	1.010 (300 - 2.060)	505	4.80	2.31	2.89				5.20 (2.00 - 8.20)	3.11 D	1.670 (250 - 2.860)	835	7.90
16 + 25	1.60	2.50				4.10 (2.40 - 5.80)	3.39 A	1.210 (300 - 2.060)	605	5.70	2.19	3.41				5.60 (2.00 - 8.20)	3.08 D	1.820 (250 - 2.860)	910	8.60
16 + 35	1.60	3.20				4.80 (2.40 - 5.80)	3.24 A	1.480 (300 - 2.000)	740	6.90	2.13	4.27				6.40 (2.00 - 8.20)	3.14 D	2.040 (240 - 2.780)	1.020	9.60
16 + 42	1.60	4.00				5.60 (2.40 - 5.80)	3.08 B	1.820 (300 - 1.940)	910	8.40	2.11	5.29				7.40 (2.00 - 8.60)	3.11 D	2.380 (240 - 2.890)	1.190	11.20
16 + 50	1.60	5.00				6.60 (2.40 - 7.20)	2.90 C	2.275 (280 - 2.605)	1.138	10.50	2.06	6.44				8.50 (2.00 - 11.00)	3.21 C	2.650 (190 - 3.630)	1.325	12.50
16 + 71	1.60	7.00				8.60 (2.50 - 9.10)	2.45 E	3.505 (310 - 3.735)	1.753	16.20	1.90	3.80				10.20 (2.00 - 13.00)	3.19 D	3.200 (190 - 4.540)	1.600	15.00
20 + 20	2.00	2.00				4.00 (2.40 - 5.80)	3.48 A	1.150 (300 - 2.000)	575	5.40	2.90	2.90				5.80 (2.00 - 8.20)	3.20 C	1.810 (250 - 2.800)	905	8.50
20 + 25	2.00	2.50				4.50 (2.40 - 5.80)	3.26 A	1.380 (300 - 2.000)	690	6.40	2.71	3.39				6.10 (2.00 - 8.20)	3.19 D	1.910 (250 - 2.800)	955	9.00
20 + 35	2.00	3.20				5.20 (2.40 - 5.80)	3.25 A	1.600 (300 - 1.940)	800	7.50	2.65	4.25				6.90 (2.00 - 8.60)	3.25 C	2.120 (240 - 2.840)	1.060	10.00
20 + 42	2.00	4.00				6.00 (2.40 - 6.70)	2.91 C	2.060 (300 - 2.500)	1.030	9.50	2.63	5.27				7.90 (2.00 - 10.10)	3.12 D	2.530 (230 - 3.530)	1.265	11.90
20 + 50	2.00	5.00				7.00 (2.40 - 8.10)	2.91 C	2.405 (280 - 3.135)	1.203	11.10	2.57	6.43				9.00 (2.00 - 11.00)	3.36 C	2.680 (190 - 3.510)	1.340	12.60
20 + 71	2.00	7.00				9.00 (2.50 - 10.00)	2.43 E	3.705 (310 - 4.705)	1.853	17.10	2.38	8.32				10.70 (2.00 - 13.00)	3.28 C	3.260 (190 - 4.480)	1.630	15.30
25 + 25	2.50	2.50				5.00 (2.40 - 5.80)	3.23 A	1.550 (300 - 2.000)	775	7.20	3.25	3.25				6.50 (2.00 - 8.60)	3.25 C	2.000 (250 - 2.920)	1.000	9.40
25 + 35	2.50	3.20				5.70 (2.40 - 6.70)	3.03 B	1.880 (300 - 2.500)	940	8.70	3.20	4.10				7.30 (2.00 - 10.10)	3.20 C	2.280 (240 - 3.530)	1.140	10.70
25 + 42	2.50	4.00				6.50 (2.40 - 7.20)	2.74 D	2.370 (300 - 2.900)	1.185	10.90	3.19	5.11				8.30 (2.00 - 11.00)	3.07 D	2.700 (230 - 3.760)	1.350	12.70
25 + 50	2.50	5.00				7.50 (2.40 - 8.60)	2.74 D	2.735 (280 - 3.135)	1.368	12.60	3.13	6.27				9.40 (2.00 - 11.00)	3.24 C	2.900 (190 - 3.510)	1.450	13.60
25 + 71	2.50	7.00				9.50 (2.50 - 10.10)	2.30 F	4.125 (310 - 4.840)	2.063	19.00	2.92	8.18				11.10 (2.00 - 13.00)	3.33 C	3.330 (190 - 4.480)	1.665	15.60
35 + 35	3.20	3.20				6.40 (2.40 - 7.20)	2.86 C	2.240 (290 - 2.760)	1.120	10.30	4.05	4.05				8.10 (2.00 - 11.00)	3.15 D	2.570 (230 - 3.750)	1.285	12.10
35 + 42	3.20	4.00				7.20 (2.40 - 8.10)	2.61 D	2.760 (290 - 3.530)	1.380	12.70	4.04	5.06				9.10 (2.00 - 11.00)	3.12 D	2.920 (230 - 3.680)	1.460	13.70
35 + 50	3.20	5.00				8.20 (2.50 - 9.10)	2.62 F	3.135 (310 - 3.735)	1.568	14.50	3.98	6.22				10.20 (2.00 - 11.90)	3.33 C	3.060 (180 - 3.820)	1.530	14.40
35 + 71	3.20	6.86				10.00 (2.50 - 10.40)	2.24 D	4.465 (310 - 4.840)	2.233	20.60	3.76	8.24				12.00 (2.00 - 13.80)	3.35 C	3.580 (180 - 4.840)	1.790	16.80
42 + 42	4.00	4.00				8.00 (2.50 - 8.60)	5.60 <b>▲</b> (10.00)†	2.37 F	3.380 (320 - 4.070)	1.690	15.60	5.05	5.05			10.10 (2.00 - 11.90)	3.10 D	3.260 (220 - 4.080)	1.630	15.30
42 + 50	4.00	5.00				9.00 (2.50 - 10.00)	2.43 E	3.705 (310 - 4.705)	1.853	17.10	4.98	6.22				11.20 (2.00 - 13.00)	3.51 B	3.190 (180 - 4.380)	1.595	15.00
42 + 60	4.00	6.00				10.00 (2.50 - 10.40)	5.60 <b>▲</b> (10.00)†	2.28 F	4.395 (310 - 4.840)	2.198	20.30	4.36	7.64			12.00 (2.00 - 13.80)	3.80 <b>▲</b> (10.00)†	3.570 (180 - 4.840)	1.780	16.70
42 + 71	4.00	7.00				10.00 (2.50 - 10.40)	2.53 E	3.960 (300 - 4.350)	1.980	18.30	6.00	6.00				12.00 (2.00 - 13.80)	3.57 B	3.360 (200 - 4.600)	1.680	15.80
50 + 50	5.00	5.00				10.00 (2.50 - 10.40)	5.60 <b>▲</b> (10.00)†	2.62 D	3.820 (300 - 4.200)	1.910	17.60	5.00	7.00			12.00 (2.00 - 13.80)	3.59 B	3.340 (200 - 4.580)	1.670	15.70
71 + 71	5.00	5.00				10.00 (2.50 - 10.40)	2.72 D	3.670 (330 - 4.040)	1.835	16.90	6.00	6.00				12.00 (2.00 - 13.80)	3.60 A	3.330 (200 - 4.560)	1.665	15.60
<b>3 Rooms</b>																				
16 + 16 + 16	1.60	1.60	1.60			4.80 (2.90 - 8.50)	3.66 A	1.310 (360 - 3.100)	655	6.10	2.33	2.33	2.33			6.99 (2.70 - 12.30)	3.53 B	1.980 (270 - 4.110)	990	9.30
16 + 16 + 20	1.60	1.60	2.00			5.20 (2.90 - 8.50)	3.64 A	1.430 (360 - 3.100)	715	6.70	2.34	2.34	2.92			7.60 (2.70 - 12.30)	3.50 B	2.170 (270 - 4.050)	1.085	10.20
16 + 16 + 25	1.60	1.60	2.50			5.70 (2.90 - 8.50)	3.48 A	1.640 (360 - 3.100)	820	7.60	2.22	2.22	3.46			7.90 (2.70 - 12.30)	3.46 B	2.280 (270 - 4.050)	1.140	10.70
16 + 16 + 35	1.60	1.60	3.20			6.40 (2.90 - 8.50)	3.32 A	1.930 (360 - 3.030)	965	8.90	2.18	2.18	4.34			8.70 (2.70 - 12.30)	3.49 B	2.490 (270 - 3.950)	1.245	11.70
16 + 16 + 42	1.60	1.60	4.00			7.20 (2.90 - 8.50)	3.21 A	2.240 (390 - 2.960)	1.120	10.30	2.16	2.16	5.38			9.70 (2.70 - 12.30)	3.32 C	2.920 (270 - 3.940)	1.460	13.70
16 + 16 + 50	1.60	1.60	5.00			8.20 (2.90 - 8.70)	3.09 C	2.655 (390 - 2.845)	1.328	12.20	2.11	2.11	6.58			10.80 (2.70 - 12.90)	3.70 A	2.920 (290 - 4.060)	1.460	13.70
16 + 16 + 71	1.57	1.57	6.86			10.00 (2.90 - 10.70)	2.92 C	3.425 (390 - 1.015)	1.713	15.80	1.88	1.88	8.24			12.00 (2.70 - 13.60)	3.58 B	3.350 (290 - 4.370)	1.675	15.70
16 + 20 + 20	1.60	2.00	2.00			5.60 (2.90 - 8.50)	3.52 A	1.590 (360 - 3.030)	795	7.40	2.32	2.89	2.89			8.10 (2.70 - 12.30)	3.57 B	2.270 (270 - 3.990)	1.135	10.70
16 + 20 + 25	1.60	2.00	2.50			6.10 (2.90 - 8.50)	3.37 A	1.810 (360 - 3.030)	905	8.30	2.23	2.79	3.48			8.50 (2.70 - 12.30)	3.43 B	2.480 (270 - 3.990)	1.240	11.70
16 + 20 + 35	1.60	2.00	3.20			6.80 (2.90 - 8.50)	3.32 A	2.050 (390 - 2.960)	1.025	9.50	2.18	2.74	4.38			9.30 (2.70 - 12.30)	3.52 B	2.640 (270 - 3.890)	1.320	12.40
16 + 20 + 42	1.60	2.00	4.00			7.60 (2.90 - 8.50)	3.13 B	2.430 (390 - 2.960)	1.215	11.20	2.17	2.71	5.42			10.30 (2.70 - 12.30)	3.55 B	2.900 (270 - 3.870)	1.450	13.60
16 + 20 + 50	1.60	2.00	5.00			8.60 (2.90 - 9.60)	3.01 B	2.855 (390 - 3.215)	1.428	13.20	2.10	2.63	6.57			11.30 (2.70 - 13.60)	3.79 A	2.980 (290 - 4.330)	1.490	14.00
16 + 20 + 71	1.51	1.89	6.60			10.00 (2.90 - 10.70)	2.92 C	3.425 (390 - 4.015)	1.713	15.80	1.81	2.26	7.93			12.00 (2.70 - 13.80)	3.65 A	3.290 (290 - 4.440)	1.645	15.50
16 + 25 + 25	1.60	2.50	2.50			6.60 (2.90 - 8.50)	3.22 A	2.050 (360 - 3.030)	1.025											



Free Multi 5x1 CU-5E34PBE. Minimum capacity connected: 4,5kW. Maximum capacity connected: 17,5kW • R410 GAS

Indoor unit capacity	Cooling capacity (kW)					EER	Input power rating		A.E.C.	Current	Heating capacity (kW)					COP	Input power rating		A.E.C.	Current				
	Rooms						W/W	W			kWh	230V	Rooms					W/W			W	kWh	230V	
	A	B	C	D	E								Total (Min - Max)	A	B		C							D
25 + 25 + 50	2,50	2,50	5,00			10,00 (2,90 - 10,70)	5,60	2,86 C	3,495 (390 - 4,085)	1,748	16,10	3,00	3,00	6,00			12,00 (2,70 - 13,60)	3,80	3,70 A	3,240 (290 - 4,260)	1,620	15,20		
25 + 25 + 71	2,08	2,08	5,84			10,00 (2,90 - 10,70)	2,92 C	3,425 (390 - 3,935)	1,713	15,80	2,50	2,50	7,00			12,00 (2,70 - 13,80)	3,79 A	3,170 (290 - 4,380)	1,585	14,90				
25 + 35 + 35	2,50	3,20	3,20			8,90 (2,90 - 9,60)	2,88 C	3,090 (390 - 3,460)	1,545	14,20	3,18	4,06	4,06			11,30 (2,70 - 13,60)	3,70 A	3,050 (280 - 4,510)	1,525	14,30				
25 + 35 + 42	2,50	3,20	4,00			9,70 (2,90 - 10,70)	2,80 C	3,460 (390 - 4,530)	1,730	16,00	3,09	3,96	4,95			12,00 (2,70 - 13,60)	3,61 A	3,320 (280 - 4,420)	1,660	15,60				
25 + 35 + 50	2,34	2,99	4,67			10,00 (2,90 - 10,70)	2,92 C	3,425 (390 - 4,015)	1,713	15,80	2,80	3,59	5,61			12,00 (2,70 - 13,80)	3,81 A	3,150 (310 - 4,360)	1,575	14,80				
25 + 35 + 71	1,97	2,52	5,51			10,00 (2,90 - 10,70)	2,98 C	3,355 (420 - 3,855)	1,678	15,50	2,36	3,02	6,62			12,00 (2,70 - 14,10)	3,82 A	3,140 (310 - 4,470)	1,570	14,80				
25 + 42 + 42	2,38	3,81	3,81			10,00 (2,90 - 10,70)	2,67 D	3,750 (390 - 4,530)	1,875	17,30	2,86	4,57	4,57			12,00 (2,70 - 13,80)	3,63 A	3,310 (280 - 4,550)	1,655	15,60				
25 + 42 + 50	2,17	3,48	4,35			10,00 (2,90 - 10,70)	2,92 C	3,425 (390 - 3,935)	1,713	15,80	2,61	4,17	5,22			12,00 (2,70 - 13,80)	3,82 A	3,140 (310 - 4,340)	1,570	14,80				
25 + 42 + 71	1,85	2,96	5,19			10,00 (2,90 - 10,70)	3,04 B	3,285 (420 - 3,855)	1,643	15,10	2,22	3,56	6,22			12,00 (2,70 - 14,10)	3,85 A	3,120 (310 - 4,460)	1,560	14,70				
25 + 50 + 50	2,00	4,00	4,00			10,00 (2,90 - 10,70)	3,08 B	3,250 (430 - 3,670)	1,625	15,00	2,40	4,80	4,80			12,00 (2,70 - 13,80)	3,95 A	3,040 (350 - 4,140)	1,520	14,30				
25 + 50 + 71	1,72	3,45	4,83			10,00 (2,90 - 10,70)	3,14 B	3,180 (460 - 3,600)	1,590	14,70	2,07	4,14	5,79			12,00 (2,70 - 14,10)	3,96 A	3,030 (370 - 4,320)	1,515	14,20				
25 + 71 + 71	1,52	4,24	4,24			10,00 (2,90 - 10,70)	3,22 A	3,110 (460 - 3,530)	1,555	14,30	1,82	5,09	5,09			12,00 (2,70 - 14,40)	3,91 A	3,070 (380 - 4,430)	1,535	14,40				
35 + 35 + 35	3,20	3,20	3,20			9,60 (2,90 - 10,10)	2,89 C	3,320 (390 - 3,750)	1,660	15,30	4,00	4,00	4,00			12,00 (2,70 - 13,60)	3,64 A	3,300 (280 - 4,400)	1,650	15,50				
35 + 35 + 42	3,08	3,08	3,84			10,00 (2,90 - 10,70)	2,72 D	3,680 (390 - 4,370)	1,840	17,00	3,69	3,69	4,62			12,00 (2,70 - 13,60)	3,66 A	3,280 (280 - 4,390)	1,640	15,40				
35 + 35 + 50	2,81	2,81	4,38			10,00 (2,90 - 10,70)	2,98 C	3,355 (390 - 3,855)	1,678	15,50	3,37	3,37	5,26			12,00 (2,70 - 13,80)	3,85 A	3,120 (310 - 4,320)	1,560	14,70				
35 + 35 + 71	2,39	2,39	5,22			10,00 (2,90 - 10,70)	3,04 B	3,285 (420 - 3,785)	1,643	15,10	2,87	2,87	6,26			12,00 (2,70 - 14,10)	3,86 A	3,110 (320 - 4,430)	1,555	14,60				
35 + 42 + 42	2,86	3,57	3,57			10,00 (2,90 - 10,70)	2,78 D	3,600 (390 - 4,370)	1,800	16,60	3,42	4,29	4,29			12,00 (2,70 - 13,80)	3,67 A	3,270 (280 - 4,510)	1,635	15,40				
35 + 42 + 50	2,62	3,28	4,10			10,00 (2,90 - 10,70)	2,98 C	3,355 (420 - 3,855)	1,678	15,50	3,15	3,93	4,92			12,00 (2,70 - 13,80)	3,86 A	3,110 (320 - 4,300)	1,555	14,60				
35 + 42 + 71	2,25	2,82	4,93			10,00 (2,90 - 10,70)	3,04 B	3,285 (420 - 3,785)	1,643	15,10	2,70	3,38	5,92			12,00 (2,70 - 14,10)	3,88 A	3,090 (320 - 4,410)	1,545	14,50				
35 + 50 + 50	2,42	3,79	3,79			10,00 (2,90 - 10,70)	3,14 B	3,180 (460 - 3,600)	1,590	14,70	2,90	4,55	4,55			12,00 (2,70 - 14,10)	3,91 A	3,070 (380 - 4,300)	1,535	14,40				
35 + 50 + 71	2,10	3,29	4,61			10,00 (2,90 - 10,70)	3,22 A	3,110 (460 - 3,530)	1,555	14,30	2,52	3,95	5,53			12,00 (2,70 - 14,40)	3,93 A	3,050 (380 - 4,410)	1,525	14,40				
35 + 71 + 71	1,86	4,07	4,07			10,00 (2,90 - 10,70)	3,21 A	3,120 (470 - 3,530)	1,560	14,40	2,24	4,88	4,88			12,00 (2,70 - 14,40)	3,95 A	3,040 (390 - 4,390)	1,520	14,40				
42 + 42 + 42	3,33	3,33	3,33			9,99 (2,90 - 10,70)	2,78 D	3,600 (390 - 4,290)	1,800	16,60	4,00	4,00	4,00			12,00 (2,70 - 13,80)	3,68 A	3,260 (280 - 4,420)	1,630	15,30				
42 + 42 + 50	3,08	3,08	3,84			10,00 (2,90 - 10,70)	3,04 B	3,285 (420 - 3,855)	1,643	15,10	3,69	3,69	4,62			12,00 (2,70 - 14,10)	3,87 A	3,100 (320 - 4,420)	1,550	14,60				
42 + 42 + 71	2,67	2,67	4,66			10,00 (2,90 - 10,70)	3,11 B	3,215 (420 - 3,715)	1,608	14,80	3,20	3,20	5,60			12,00 (2,70 - 14,40)	3,90 A	3,080 (320 - 4,540)	1,540	14,50				
42 + 50 + 50	2,86	3,57	3,57			10,00 (2,90 - 10,70)	3,14 B	3,180 (460 - 3,600)	1,590	14,70	3,42	4,29	4,29			12,00 (2,70 - 14,10)	3,92 A	3,060 (380 - 4,280)	1,530	14,40				
42 + 50 + 71	2,49	3,13	4,38			10,00 (2,90 - 10,70)	3,22 A	3,110 (460 - 3,530)	1,555	14,30	3,00	3,75	5,25			12,00 (2,70 - 14,40)	3,95 A	3,040 (390 - 4,400)	1,520	14,30				
50 + 50 + 50	3,33	3,33	3,33			9,99 (2,90 - 10,70)	3,23 A	3,095 (510 - 3,495)	1,548	14,30	4,00	4,00	4,00			12,00 (2,70 - 14,40)	3,96 A	3,030 (460 - 4,350)	1,515	14,20				
50 + 50 + 71	2,94	2,94	4,12			10,00 (2,90 - 10,70)	3,23 A	3,095 (510 - 3,495)	1,548	14,30	3,53	3,53	4,94			12,00 (2,70 - 14,40)	3,97 A	3,020 (480 - 4,340)	1,510	14,20				
<b>4 Rooms</b>																								
16 + 16 + 16 + 16	1,60	1,60	1,60	1,60		6,40 (2,90 - 10,60)	3,50 A	1,830 (420 - 4,130)	915	8,40	2,88	2,88	2,88	2,88			11,52 (3,40 - 14,20)	3,65 A	3,160 (390 - 4,720)	1,580	14,80			
16 + 16 + 16 + 20	1,60	1,60	1,60	2,00		6,80 (2,90 - 10,60)	3,43 A	1,980 (420 - 4,130)	990	9,10	2,71	2,71	2,71	3,39			11,52 (3,40 - 14,20)	3,73 A	3,090 (390 - 4,650)	1,545	14,50			
16 + 16 + 16 + 25	1,60	1,60	1,60	2,50		7,30 (2,90 - 10,60)	3,36 A	2,170 (420 - 4,130)	1,080	10,00	2,52	2,52	2,52	3,96			11,52 (3,40 - 14,20)	3,73 A	3,090 (390 - 4,650)	1,545	14,50			
16 + 16 + 16 + 30	1,60	1,60	1,60	3,20		8,00 (2,90 - 10,60)	3,25 A	2,460 (420 - 4,050)	1,230	11,30	2,30	2,30	2,30	4,62			11,52 (3,40 - 14,20)	3,76 A	3,060 (390 - 4,610)	1,530	14,40			
16 + 16 + 16 + 42	1,60	1,60	1,60	4,20		8,80 (2,90 - 10,60)	3,10 B	2,840 (420 - 4,050)	1,420	13,10	2,09	2,09	2,09	5,25			11,52 (3,40 - 14,20)	3,78 A	3,050 (400 - 4,600)	1,525	14,30			
16 + 16 + 16 + 50	1,60	1,60	1,60	5,00		9,80 (2,90 - 10,60)	3,03 B	3,235 (470 - 3,825)	1,618	14,90	1,88	1,88	1,88	5,88			11,52 (3,40 - 14,20)	3,88 A	2,970 (460 - 4,460)	1,485	14,40			
16 + 16 + 16 + 71	1,36	1,36	1,36	5,92		10,00 (2,90 - 10,60)	3,02 B	3,315 (470 - 3,745)	1,658	15,30	1,56	1,56	1,56	6,84			11,52 (3,40 - 14,20)	3,89 A	2,960 (460 - 4,440)	1,480	13,90			
16 + 16 + 20 + 20	1,60	1,60	2,00	2,00		7,20 (2,90 - 10,60)	3,43 A	2,100 (420 - 4,040)	1,050	9,70	2,56	2,56	3,20	3,20			11,52 (3,40 - 14,20)	3,80 A	3,030 (390 - 4,590)	1,515	14,20			
16 + 16 + 20 + 25	1,60	1,60	2,00	2,50		7,70 (2,90 - 10,60)	3,30 A	2,330 (420 - 4,040)	1,165	10,70	2,39	2,39	2,99	3,75			11,52 (3,40 - 14,20)	3,80 A	3,030 (390 - 4,590)	1,515	14,20			
16 + 16 + 20 + 35	1,60	1,60	2,00	3,20		8,40 (2,90 - 10,60)	3,24 A	2,590 (420 - 3,960)	1,295	11,90	2,19	2,19	2,74	4,40			11,52 (3,40 - 14,20)	3,84 A	3,000 (400 - 4,550)	1,500	14,10			
16 + 16 + 20 + 42	1,60	1,60	2,00	4,00		9,20 (2,90 - 10,60)	3,05 B	3,020 (420 - 3,960)	1,510	13,90	2,00	2,00	2,50	5,02			11,52 (3,40 - 14,20)	3,85 A	2,990 (400 - 4,530)	1,495	14,10			
16 + 16 + 20 + 50	1,57	1,57	1,96	4,90		10,00 (2,90 - 10,60)	2,95 C	3,385 (470 - 3,825)	1,693	15,60	1,81	1,81	2,25	5,65			11,52 (3,40 - 14,20)	3,96 A	2,910 (460 - 4,400)	1,455	13,70			
16 + 16 + 20 + 71	1,31	1,31	1,64	5,74		10,00 (2,90 - 10,80)	3,02 B	3,315 (470 - 3,905)	1,658	15,30	1,51	1,51	1,89	6,61			11,52 (3,40 - 14,20)	3,97 A	2,900 (460 - 4,380)	1,450	13,60			
16 + 16 + 25 + 25	1,60	1,60	2,50	2,50		8,20 (2,90 - 10,60)	3,24 A	2,530 (420 - 4,040)	1,265	11,70	2,25	2,25	3,51	3,51			11,52 (3,40 - 14,20)	3,80 A	3,030 (390 - 4,590)	1,515	14,20			
16 + 16 + 25 + 35	1,60	1,60	2,50	3,20		8,90 (2,90 - 10,60)	3,13 B	2,840 (420 - 3,960)	1,420	13,10	2,07	2,07	3,24	4,14			11,52 (3,40 - 14,20)	3,84 A	3,000 (400 - 4,550)	1,500	14,10			
16 + 16 + 25 + 42	1,60	1,60	2,50	4,00		9,70 (2,90 - 10,60)	2,96 C	3,280 (420 - 3,960)	1,640	15,10	1,90	2,97	4,75	4,										

FREE MULTI 5X1 COMBINATIONS TABLE

Free Multi 5x1 CU-5E34PBE. Minimum capacity connected: 4,5kW. Maximum capacity connected: 17,5kW • R410 GAS

Table with columns: Indoor unit capacity, Cooling capacity (kW) Rooms, EER, Input power rating, A.E.C., Current, Heating capacity (kW) Rooms, COP, Input power rating, A.E.C., Current. Rows list various combinations of indoor unit capacities and room counts, providing detailed performance metrics for each configuration.

Free Multi 5x1 CU-5E34PBE. Minimum capacity connected: 4,5kW. Maximum capacity connected: 17,5kW • R410 GAS

Indoor unit capacity	Cooling capacity (kW)						EER	Input power rating				A.E.C.	Current	Heating capacity (kW)						COP	Input power rating				A.E.C.	Current
	Rooms							W/W	W	kWh	230V			Rooms							W/W	W	kWh	230V		
	A	B	C	D	E	Total (Min - Max)								A	B	C	D	E	Total (Min - Max)							
35 + 35 + 35 + 50	2,19	2,19	2,19	3,43		10,00 (2,90 - 11,00)	3,08 B	3,245 (510 - 3,915)	1,623	15,00	2,63	2,63	2,63	4,11	12,00 (3,40 - 14,40)	4,03 A	2,980 (530 - 4,290)	1,490	14,00							
35 + 35 + 35 + 71	1,93	1,93	1,93	4,21		10,00 (2,90 - 11,20)	3,08 B	3,245 (520 - 3,995)	1,623	15,00	2,31	2,31	2,31	5,07	12,00 (3,40 - 14,40)	4,04 A	2,970 (550 - 4,270)	1,485	14,00							
35 + 35 + 42 + 42	2,22	2,22	2,78	2,78		10,00 (2,90 - 11,00)	3,05 B	3,280 (460 - 4,050)	1,640	15,10	2,67	2,67	3,33	3,33	12,00 (3,40 - 14,40)	4,01 A	2,990 (460 - 4,330)	1,495	14,10							
35 + 35 + 42 + 50	2,08	2,08	2,59	3,25		10,00 (2,90 - 11,00)	3,08 B	3,245 (510 - 3,915)	1,623	15,00	2,49	2,49	3,12	3,90	12,00 (3,40 - 14,40)	4,04 A	2,970 (540 - 4,280)	1,485	14,10							
35 + 35 + 42 + 71	1,84	1,84	2,30	4,02		10,00 (2,90 - 11,20)	3,08 B	3,245 (550 - 3,995)	1,623	15,00	2,21	2,21	2,75	4,83	12,00 (3,40 - 14,40)	4,05 A	2,960 (550 - 4,260)	1,480	13,90							
35 + 35 + 50 + 50	1,95	1,95	3,05	3,05		10,00 (2,90 - 11,20)	3,04 B	3,290 (600 - 4,030)	1,645	15,20	2,34	2,34	3,66	3,66	12,00 (3,40 - 14,40)	3,97 A	3,020 (630 - 4,240)	1,510	14,20							
35 + 42 + 42 + 42	2,11	2,63	2,63	2,63		10,00 (2,90 - 11,00)	3,05 B	3,280 (460 - 4,050)	1,640	15,10	2,52	3,16	3,16	3,16	12,00 (3,40 - 14,40)	4,03 A	2,980 (460 - 4,320)	1,490	14,00							
35 + 42 + 42 + 50	1,97	2,47	2,47	3,09		10,00 (2,90 - 11,20)	3,08 B	3,245 (510 - 4,075)	1,623	15,00	2,37	2,96	2,96	3,71	12,00 (3,40 - 14,40)	4,05 A	2,960 (550 - 4,260)	1,480	13,90							
35 + 42 + 50 + 50	1,85	2,33	2,91	2,91		10,00 (2,90 - 11,20)	3,05 B	3,300 (600 - 4,030)	1,650	15,20	2,23	2,79	3,49	3,49	12,00 (3,40 - 14,40)	3,99 A	3,010 (650 - 4,220)	1,505	14,10							
42 + 42 + 42 + 42	2,50	2,50	2,50	2,50		10,00 (2,90 - 11,20)	3,05 B	3,280 (470 - 4,130)	1,640	15,10	3,00	3,00	3,00	3,00	12,00 (3,40 - 14,40)	4,04 A	2,970 (470 - 4,310)	1,485	14,00							
42 + 42 + 42 + 50	2,35	2,35	2,35	2,95		10,00 (2,90 - 11,20)	3,08 B	3,245 (520 - 3,995)	1,623	15,00	2,82	2,82	3,54	3,54	12,00 (3,40 - 14,40)	4,07 A	2,950 (550 - 4,250)	1,475	13,90							
<b>16 Rooms</b>																										
16 + 16 + 16 + 16 + 16	1,60	1,60	1,60	1,60	1,60	8,00 (2,90 - 11,50)	3,31 A	2,420 (510 - 4,290)	1,210	11,20	2,34	2,34	2,34	2,34	11,70 (3,40 - 14,50)	3,77 A	3,100 (500 - 4,590)	1,550	14,60							
16 + 16 + 16 + 16 + 20	1,60	1,60	1,60	1,60	2,00	8,40 (2,90 - 11,50)	3,29 A	2,550 (510 - 4,290)	1,275	11,80	2,29	2,29	2,29	2,29	12,00 (3,40 - 14,50)	3,82 A	3,140 (510 - 4,520)	1,570	14,80							
16 + 16 + 16 + 16 + 25	1,60	1,60	1,60	1,60	2,50	8,90 (2,90 - 11,50)	3,27 A	2,720 (510 - 4,290)	1,360	12,50	2,16	2,16	2,16	2,16	12,00 (3,40 - 14,50)	3,82 A	3,140 (510 - 4,520)	1,570	14,80							
16 + 16 + 16 + 16 + 35	1,60	1,60	1,60	1,60	3,20	9,60 (2,90 - 11,50)	3,20 B	3,000 (520 - 4,210)	1,500	13,80	2,00	2,00	2,00	2,00	12,00 (3,40 - 14,50)	3,79 A	3,170 (520 - 4,490)	1,585	14,90							
16 + 16 + 16 + 16 + 42	1,54	1,54	1,54	1,54	3,84	10,00 (2,90 - 11,50)	3,12 B	3,210 (520 - 4,210)	1,605	14,80	1,85	1,85	1,85	1,85	12,00 (3,40 - 14,50)	3,80 A	3,160 (530 - 4,540)	1,580	14,80							
16 + 16 + 16 + 16 + 50	1,40	1,40	1,40	1,40	4,40	10,00 (2,90 - 11,50)	3,06 B	3,265 (600 - 4,165)	1,633	15,10	1,68	1,68	1,68	1,68	12,00 (3,40 - 14,50)	3,74 A	3,210 (630 - 4,490)	1,605	15,10							
16 + 16 + 16 + 16 + 71	1,19	1,19	1,19	1,19	5,24	10,00 (2,90 - 11,50)	3,06 B	3,265 (610 - 4,085)	1,633	15,10	1,43	1,43	1,43	1,43	12,00 (3,40 - 14,50)	3,75 A	3,200 (650 - 4,480)	1,600	15,10							
16 + 16 + 16 + 20 + 20	1,60	1,60	1,60	2,00	2,00	8,80 (2,90 - 11,50)	3,24 A	2,720 (510 - 4,210)	1,360	12,50	2,18	2,18	2,18	2,73	12,00 (3,40 - 14,50)	3,88 A	3,090 (520 - 4,460)	1,545	14,50							
16 + 16 + 16 + 20 + 25	1,60	1,60	1,60	2,00	2,50	9,30 (2,90 - 11,50)	3,22 A	2,890 (510 - 4,210)	1,445	13,30	2,06	2,06	2,06	2,58	12,00 (3,40 - 14,50)	3,88 A	3,090 (520 - 4,460)	1,545	14,50							
16 + 16 + 16 + 20 + 35	1,60	1,60	1,60	2,00	3,20	10,00 (2,90 - 11,50)	3,12 B	3,210 (520 - 4,210)	1,605	14,80	1,92	1,92	1,92	2,42	12,00 (3,40 - 14,50)	3,86 A	3,110 (530 - 4,490)	1,555	14,60							
16 + 16 + 16 + 20 + 42	1,48	1,48	1,48	1,85	3,70	10,00 (2,90 - 11,50)	3,12 B	3,210 (550 - 4,210)	1,605	14,80	1,78	1,78	1,78	2,22	12,00 (3,40 - 14,50)	3,86 A	3,110 (550 - 4,490)	1,555	14,60							
16 + 16 + 16 + 20 + 50	1,36	1,36	1,36	1,68	4,24	10,00 (2,90 - 11,50)	3,06 B	3,265 (610 - 4,165)	1,633	15,10	1,63	1,63	1,63	2,03	12,00 (3,40 - 14,50)	3,80 A	3,160 (650 - 4,430)	1,580	14,80							
16 + 16 + 16 + 20 + 71	1,16	1,16	1,16	1,45	5,07	10,00 (2,90 - 11,50)	3,05 B	3,275 (620 - 4,085)	1,638	15,10	1,39	1,39	1,39	1,74	12,00 (3,40 - 14,50)	3,81 A	3,150 (650 - 4,420)	1,575	14,80							
16 + 16 + 16 + 25 + 25	1,60	1,60	1,60	2,50	2,50	9,80 (2,90 - 11,50)	3,12 B	3,140 (510 - 4,210)	1,570	14,50	1,96	1,96	1,96	3,06	12,00 (3,40 - 14,50)	3,88 A	3,090 (520 - 4,460)	1,545	14,50							
16 + 16 + 16 + 25 + 35	1,52	1,52	1,52	2,38	3,06	10,00 (2,90 - 11,50)	3,12 B	3,210 (520 - 4,210)	1,605	14,80	1,83	1,83	1,83	2,85	12,00 (3,40 - 14,50)	3,86 A	3,110 (530 - 4,490)	1,555	14,60							
16 + 16 + 16 + 25 + 42	1,42	1,42	1,42	2,20	3,54	10,00 (2,90 - 11,50)	3,12 B	3,210 (550 - 4,210)	1,605	14,80	1,70	1,70	1,70	2,65	12,00 (3,40 - 14,50)	3,86 A	3,110 (550 - 4,490)	1,555	14,60							
16 + 16 + 16 + 25 + 50	1,30	1,30	1,30	2,03	4,07	10,00 (2,90 - 11,50)	3,06 B	3,265 (610 - 4,165)	1,633	15,10	1,56	1,56	1,56	2,44	12,00 (3,40 - 14,50)	3,80 A	3,160 (650 - 4,430)	1,580	14,80							
16 + 16 + 16 + 25 + 71	1,12	1,12	1,12	1,74	4,90	10,00 (2,90 - 11,50)	3,05 B	3,275 (620 - 4,085)	1,638	15,10	1,34	1,34	1,34	2,10	12,00 (3,40 - 14,50)	3,81 A	3,150 (650 - 4,420)	1,575	14,80							
16 + 16 + 16 + 35 + 35	1,43	1,43	1,43	2,85	2,85	9,99 (2,90 - 11,50)	3,17 B	3,150 (550 - 4,130)	1,575	14,50	1,71	1,71	1,71	3,43	12,00 (3,40 - 14,50)	3,88 A	3,090 (560 - 4,450)	1,545	14,50							
16 + 16 + 16 + 35 + 42	1,33	1,33	1,33	2,67	3,34	10,00 (2,90 - 11,50)	3,17 B	3,150 (550 - 4,130)	1,575	14,50	1,60	1,60	1,60	3,20	12,00 (3,40 - 14,50)	3,88 A	3,090 (560 - 4,450)	1,545	14,50							
16 + 16 + 16 + 35 + 50	1,23	1,23	1,23	2,46	3,85	10,00 (2,90 - 11,50)	3,06 B	3,265 (610 - 4,085)	1,633	15,10	1,48	1,48	1,48	2,94	12,00 (3,40 - 14,50)	3,82 A	3,140 (660 - 4,470)	1,570	14,80							
16 + 16 + 16 + 35 + 71	1,07	1,07	1,07	2,12	4,67	10,00 (2,90 - 11,50)	3,12 B	3,205 (650 - 4,085)	1,603	14,80	1,28	1,28	1,28	2,56	12,00 (3,40 - 14,50)	3,77 A	3,180 (680 - 4,450)	1,590	14,90							
16 + 16 + 16 + 42 + 42	1,25	1,25	1,25	3,12	3,12	9,99 (2,90 - 11,50)	3,17 B	3,150 (550 - 4,130)	1,575	14,50	1,50	1,50	1,50	3,75	12,00 (3,40 - 14,50)	3,90 A	3,080 (580 - 4,430)	1,540	14,50							
16 + 16 + 16 + 42 + 50	1,16	1,16	1,16	2,90	3,62	10,00 (2,90 - 11,50)	3,05 B	3,275 (620 - 4,085)	1,638	15,10	1,39	1,39	1,39	3,48	12,00 (3,40 - 14,50)	3,83 A	3,130 (680 - 4,460)	1,565	14,70							
16 + 16 + 16 + 42 + 71	1,01	1,01	1,01	2,53	4,44	10,00 (2,90 - 11,50)	3,12 B	3,205 (650 - 4,095)	1,603	14,80	1,22	1,22	1,22	3,32	12,00 (3,40 - 14,50)	3,79 A	3,170 (690 - 4,440)	1,585	14,90							
16 + 16 + 16 + 50 + 50	1,08	1,08	1,08	3,38	3,38	10,00 (2,90 - 11,50)	3,00 B	3,330 (710 - 4,130)	1,665	15,40	1,30	1,30	1,30	4,05	12,00 (3,40 - 14,50)	3,69 A	3,250 (790 - 4,500)	1,625	15,30							
16 + 16 + 16 + 50 + 71	0,95	0,95	0,95	2,98	4,17	10,00 (2,90 - 11,50)	2,99 C	3,340 (750 - 4,140)	1,670	15,40	1,14	1,14	1,14	3,57	12,00 (3,40 - 14,50)	3,69 A	3,250 (810 - 4,490)	1,625	15,30							
16 + 16 + 20 + 20 + 20	1,60	1,60	2,00	2,00	2,00	9,20 (2,90 - 11,50)	3,26 A	2,820 (510 - 4,210)	1,410	13,00	2,09	2,09	2,09	2,61	12,00 (3,40 - 14,50)	3,89 A	3,080 (520 - 4,400)	1,540	14,50							
16 + 16 + 20 + 20 + 25	1,60	1,60	2,00	2,00	2,50	9,70 (2,90 - 11,50)	3,16 B	3,070 (510 - 4,210)	1,535	14,20	1,98	1,98	2,47	2,47	12,00 (3,40 - 14,50)	3,90 A	3,080 (520 - 4,400)	1,540	14,50							
16 + 16 + 20 + 20 + 35	1,54	1,54	1,92	1,92	3,08	10,00 (2,90 - 11,50)	3,12 B	3,210 (550 - 4,210)	1,605	14,80	1,85	1,85	2,31	2,31	12,00 (3,40 - 14,50)	3,92 A	3,060 (550 - 4,430)	1,530	14,40							
16 + 16 + 20 + 20 + 42	1,43	1,43	1,79	1,79	3,56	10,00 (2,90 - 11,50)	3,11 B	3,220 (550 - 4,130)	1,610	14,80	1,71	1,71	2,14	2,14	12,00 (3,40 - 14,50)	3,93 A	3,050 (550 - 4,410)	1,525	14,30							
16 + 16 + 20 + 20 + 50	1,31	1,31	1,64	1,64	4,10	10,00 (2,90 - 11,50)	3,06 B	3,265 (610 - 4,085)	1,633	15,10	1,57	1,57	1,97	1,97	12,00 (3,40 - 14,50)	3,87 A	3,100 (650 - 4,370)	1,550	14,60							
16 + 16 + 20 + 20 + 71	1,13	1,13	1,4																							

FREE MULTI 5X1 COMBINATIONS TABLE

Free Multi 5x1 CU-5E34PBE. Minimum capacity connected: 4.5kW. Maximum capacity connected: 17.5kW • R410 GAS

Table with columns: Indoor unit capacity, Cooling capacity (kW) Rooms, EER, Input power rating, A.E.C., Current, Heating capacity (kW) Rooms, COP, Input power rating, A.E.C., Current. Rows include various room configurations like 16+20+20+35+71, 20+20+20+20+20, etc.



Free Multi 5x1 CU-5E34PBE. Minimum capacity connected: 4,5kW. Maximum capacity connected: 17,5kW • R410 GAS

Indoor unit capacity	Cooling capacity (kW)						EER	Input power rating	A.E.C.	Current	Heating capacity (kW)						COP	Input power rating	A.E.C.	Current
	Rooms										Rooms									
	A	B	C	D	E	Total (Min - Max)					W/W	W	kWh	230V	A	B				
20 + 25 + 25 + 25 + 25	1,68	2,08	2,08	2,08	2,08	10,00 (2,90 - 11,50)	3,12 B	3.210 (550 - 4.210)	1.605	14,80	2,00	2,50	2,50	2,50	2,50	12,00 (3,40 - 14,50)	4,05 A	2.960 (530 - 4.340)	1.480	13,90
20 + 25 + 25 + 25 + 35	1,57	1,97	1,97	1,97	2,52	10,00 (2,90 - 11,50)	3,17 B	3.150 (550 - 4.130)	1.575	14,50	1,89	2,36	2,36	2,36	3,03	12,00 (3,40 - 14,50)	4,08 A	2.940 (560 - 4.300)	1.470	13,80
20 + 25 + 25 + 25 + 42	1,48	1,85	1,85	1,85	2,97	10,00 (2,90 - 11,50)	3,17 B	3.150 (550 - 4.130)	1.575	14,50	1,78	2,22	2,22	2,22	3,56	12,00 (3,40 - 14,50)	4,10 A	2.930 (560 - 4.290)	1.465	13,80
20 + 25 + 25 + 25 + 50	1,38	1,72	1,72	1,72	3,46	10,00 (2,90 - 11,50)	3,06 B	3.265 (610 - 4.085)	1.633	15,10	1,65	2,07	2,07	2,07	4,14	12,00 (3,40 - 14,50)	4,01 A	2.990 (670 - 4.310)	1.495	14,10
20 + 25 + 25 + 25 + 71	1,20	1,52	1,52	1,52	4,24	10,00 (2,90 - 11,50)	3,12 B	3.205 (650 - 4.095)	1.603	14,80	1,45	1,82	1,82	1,82	5,09	12,00 (3,40 - 14,50)	3,96 A	3.030 (680 - 4.300)	1.515	14,20
20 + 25 + 25 + 35 + 35	1,48	1,87	1,87	2,39	2,39	10,00 (2,90 - 11,50)	3,17 B	3.150 (560 - 4.130)	1.575	14,50	1,78	2,24	2,24	2,87	2,87	12,00 (3,40 - 14,50)	4,04 A	2.970 (560 - 4.270)	1.485	14,00
20 + 25 + 25 + 35 + 42	1,41	1,76	1,76	2,25	2,82	10,00 (2,90 - 11,50)	3,17 B	3.150 (560 - 4.130)	1.575	14,50	1,69	2,11	2,11	2,70	3,39	12,00 (3,40 - 14,50)	4,05 A	2.960 (590 - 4.260)	1.480	13,90
20 + 25 + 25 + 35 + 50	1,32	1,64	1,64	2,11	3,29	10,00 (2,90 - 11,50)	3,12 B	3.205 (650 - 4.085)	1.603	14,80	1,58	1,97	1,97	2,53	3,95	12,00 (3,40 - 14,50)	3,97 A	3.020 (690 - 4.280)	1.510	14,20
20 + 25 + 25 + 35 + 71	1,16	1,45	1,45	1,86	4,08	10,00 (2,90 - 11,50)	3,11 B	3.215 (660 - 4.095)	1.608	14,80	1,40	1,74	1,74	2,23	4,89	12,00 (3,40 - 14,50)	3,99 A	3.010 (710 - 4.270)	1.505	14,10
20 + 25 + 25 + 42 + 42	1,32	1,67	1,67	2,67	2,67	10,00 (2,90 - 11,50)	3,17 B	3.150 (560 - 4.130)	1.575	14,50	1,60	2,00	2,00	3,20	3,20	12,00 (3,40 - 14,50)	4,05 A	2.960 (600 - 4.240)	1.480	13,90
20 + 25 + 25 + 42 + 50	1,25	1,56	1,56	2,50	3,13	10,00 (2,90 - 11,50)	3,12 B	3.205 (650 - 4.095)	1.603	14,80	1,49	1,88	1,88	3,00	3,75	12,00 (3,40 - 14,50)	3,97 A	3.020 (700 - 4.270)	1.510	14,20
20 + 25 + 25 + 50 + 50	1,18	1,47	1,47	2,94	2,94	10,00 (2,90 - 11,50)	2,99 C	3.340 (750 - 4.140)	1.670	15,40	1,42	1,76	1,76	3,53	3,53	12,00 (3,40 - 14,50)	3,82 A	3.140 (830 - 4.380)	1.570	14,80
20 + 25 + 35 + 35 + 35	1,42	1,77	2,27	2,27	2,27	10,00 (2,90 - 11,50)	3,17 B	3.150 (560 - 4.050)	1.575	14,50	1,70	2,14	2,72	2,72	2,72	12,00 (3,40 - 14,50)	4,07 A	2.950 (600 - 4.300)	1.475	13,90
20 + 25 + 35 + 35 + 42	1,34	1,68	2,15	2,15	2,68	10,00 (2,90 - 11,50)	3,17 B	3.150 (570 - 4.050)	1.575	14,50	1,61	2,01	2,58	2,58	3,22	12,00 (3,40 - 14,50)	4,07 A	2.950 (620 - 4.290)	1.475	13,90
20 + 25 + 35 + 35 + 50	1,26	1,57	2,01	2,01	3,15	10,00 (2,90 - 11,50)	3,12 B	3.205 (660 - 4.095)	1.603	14,80	1,50	1,89	2,42	2,42	3,77	12,00 (3,40 - 14,50)	3,92 A	3.060 (720 - 4.320)	1.530	14,40
20 + 25 + 35 + 42 + 42	1,27	1,59	2,04	2,04	2,55	10,00 (2,90 - 11,50)	3,17 B	3.150 (600 - 4.050)	1.575	14,50	1,52	1,91	2,45	3,06	3,06	12,00 (3,40 - 14,50)	4,08 A	2.940 (620 - 4.280)	1.470	13,80
20 + 25 + 35 + 42 + 50	1,19	1,50	1,92	2,40	2,99	10,00 (2,90 - 11,50)	3,11 B	3.215 (660 - 4.095)	1.608	14,80	1,44	1,80	2,30	2,87	3,59	12,00 (3,40 - 14,50)	3,93 A	3.050 (730 - 4.310)	1.525	14,30
20 + 25 + 42 + 42 + 42	1,21	1,53	2,42	2,42	2,42	10,00 (2,90 - 11,50)	3,17 B	3.150 (600 - 4.050)	1.575	14,50	1,45	1,82	2,91	2,91	2,91	12,00 (3,40 - 14,50)	4,03 A	2.980 (630 - 4.260)	1.490	14,00
20 + 25 + 42 + 42 + 50	1,13	1,43	2,29	2,29	2,86	10,00 (2,90 - 11,50)	3,11 B	3.215 (660 - 4.095)	1.608	14,80	1,37	1,71	2,74	2,74	3,44	12,00 (3,40 - 14,50)	3,93 A	3.050 (750 - 4.300)	1.525	14,30
20 + 35 + 35 + 35 + 35	1,36	2,16	2,16	2,16	2,16	10,00 (2,90 - 11,50)	3,16 B	3.160 (600 - 4.050)	1.580	14,60	1,64	2,59	2,59	2,59	2,59	12,00 (3,40 - 14,50)	4,03 A	2.980 (630 - 4.270)	1.490	14,00
20 + 35 + 35 + 35 + 42	1,28	2,05	2,05	2,05	2,57	10,00 (2,90 - 11,50)	3,16 B	3.160 (600 - 4.050)	1.580	14,60	1,54	2,46	2,46	2,46	3,08	12,00 (3,40 - 14,50)	4,03 A	2.980 (630 - 4.260)	1.490	14,00
20 + 35 + 35 + 35 + 50	1,20	1,93	1,93	1,93	3,01	10,00 (2,90 - 11,50)	3,11 B	3.215 (670 - 4.095)	1.608	14,80	1,45	2,31	2,31	3,62	3,62	12,00 (3,40 - 14,50)	3,95 A	3.040 (750 - 4.290)	1.520	14,30
20 + 35 + 35 + 42 + 42	1,22	1,95	1,95	2,44	2,44	10,00 (2,90 - 11,50)	3,16 B	3.160 (600 - 4.060)	1.580	14,60	1,46	2,34	2,34	2,93	2,93	12,00 (3,40 - 14,50)	4,04 A	2.970 (650 - 4.240)	1.485	14,00
20 + 35 + 35 + 42 + 50	1,15	1,84	1,84	2,30	2,87	10,00 (2,90 - 11,50)	3,11 B	3.215 (670 - 4.095)	1.608	14,80	1,37	2,21	2,21	2,76	3,45	12,00 (3,40 - 14,50)	3,95 A	3.040 (760 - 4.280)	1.520	14,30
20 + 35 + 42 + 42 + 42	1,15	1,86	2,33	2,33	2,33	10,00 (2,90 - 11,50)	3,16 B	3.160 (600 - 4.060)	1.580	14,60	1,40	2,23	2,79	2,79	2,79	12,00 (3,40 - 14,50)	4,05 A	2.960 (660 - 4.230)	1.480	13,90
25 + 25 + 25 + 25 + 25	2,00	2,00	2,00	2,00	2,00	10,00 (2,90 - 11,50)	3,12 B	3.210 (550 - 4.210)	1.605	14,80	2,40	2,40	2,40	2,40	2,40	12,00 (3,40 - 14,50)	4,05 A	2.960 (530 - 4.340)	1.480	13,90
25 + 25 + 25 + 25 + 35	1,89	1,89	1,89	1,89	2,44	10,00 (2,90 - 11,50)	3,17 B	3.150 (550 - 4.130)	1.575	14,50	2,27	2,27	2,27	2,27	2,92	12,00 (3,40 - 14,50)	4,08 A	2.940 (560 - 4.300)	1.470	13,80
25 + 25 + 25 + 25 + 42	1,79	1,79	1,79	1,79	2,84	10,00 (2,90 - 11,50)	3,17 B	3.150 (550 - 4.130)	1.575	14,50	2,14	2,14	2,14	2,14	3,44	12,00 (3,40 - 14,50)	4,10 A	2.930 (560 - 4.290)	1.465	13,80
25 + 25 + 25 + 25 + 50	1,67	1,67	1,67	1,67	3,32	10,00 (2,90 - 11,50)	3,06 B	3.265 (610 - 4.085)	1.633	15,10	2,00	2,00	2,00	2,00	4,00	12,00 (3,40 - 14,50)	4,01 A	2.990 (670 - 4.310)	1.495	14,10
25 + 25 + 25 + 25 + 71	1,47	1,47	1,47	1,47	4,12	10,00 (2,90 - 11,50)	3,12 B	3.205 (650 - 4.095)	1.603	14,80	1,76	1,76	1,76	1,76	4,96	12,00 (3,40 - 14,50)	3,96 A	3.030 (680 - 4.300)	1.515	14,20
25 + 25 + 25 + 35 + 35	1,80	1,80	1,80	2,30	2,30	10,00 (2,90 - 11,50)	3,17 B	3.150 (560 - 4.130)	1.575	14,50	2,16	2,16	2,16	2,16	2,76	12,00 (3,40 - 14,50)	4,04 A	2.970 (580 - 4.270)	1.485	14,00
25 + 25 + 25 + 35 + 42	1,70	1,70	1,70	2,18	2,72	10,00 (2,90 - 11,50)	3,17 B	3.150 (560 - 4.130)	1.575	14,50	2,04	2,04	2,04	2,61	3,27	12,00 (3,40 - 14,50)	4,05 A	2.960 (590 - 4.260)	1.480	13,90
25 + 25 + 25 + 35 + 50	1,59	1,59	1,59	2,04	3,19	10,00 (2,90 - 11,50)	3,12 B	3.205 (650 - 4.085)	1.603	14,80	1,91	1,91	1,91	2,45	3,82	12,00 (3,40 - 14,50)	3,97 A	3.020 (690 - 4.280)	1.510	14,20
25 + 25 + 25 + 42 + 42	1,62	1,62	1,62	2,57	2,57	10,00 (2,90 - 11,50)	3,17 B	3.150 (560 - 4.130)	1.575	14,50	1,94	1,94	1,94	3,09	3,09	12,00 (3,40 - 14,50)	4,05 A	2.960 (600 - 4.240)	1.480	13,90
25 + 25 + 25 + 42 + 50	1,52	1,52	1,52	2,41	3,03	10,00 (2,90 - 11,50)	3,12 B	3.205 (650 - 4.095)	1.603	14,80	1,82	1,82	1,82	2,90	3,64	12,00 (3,40 - 14,50)	3,97 A	3.020 (700 - 4.270)	1.510	14,20
25 + 25 + 25 + 50 + 50	1,42	1,42	1,42	2,87	2,87	10,00 (2,90 - 11,50)	2,99 C	3.340 (750 - 4.140)	1.670	15,40	1,72	1,72	1,72	3,42	3,42	12,00 (3,40 - 14,50)	3,82 A	3.140 (830 - 4.380)	1.570	14,80
25 + 25 + 35 + 35 + 35	1,70	1,70	2,20	2,20	2,20	10,00 (2,90 - 11,50)	3,17 B	3.150 (560 - 4.050)	1.575	14,50	2,04	2,04	2,64	2,64	2,64	12,00 (3,40 - 14,50)	4,07 A	2.950 (600 - 4.300)	1.475	13,90
25 + 25 + 35 + 35 + 42	1,62	1,62	2,08	2,08	2,60	10,00 (2,90 - 11,50)	3,12 B	3.150 (570 - 4.050)	1.575	14,50	1,95	1,95	2,49	2,49	3,12	12,00 (3,40 - 14,50)	4,07 A	2.950 (620 - 4.290)	1.475	13,90
25 + 25 + 35 + 35 + 50	1,52	1,52	1,95	1,95	3,06	10,00 (2,90 - 11,50)	3,12 B	3.205 (660 - 4.095)	1.603	14,80	1,83	1,83	2,34	2,34	3,66	12,00 (3,40 - 14,50)	3,92 A	3.060 (720 - 4.320)	1.530	14,40
25 + 25 + 35 + 42 + 42	1,54	1,54	1,98	2,47	2,47	10,00 (2,90 - 11,50)	3,17 B	3.150 (600 - 4.050)	1.575	14,50	1,85	1,85	2,38	2,96	2,96	12,00 (3,40 - 14,50)	4,08 A	2.940 (620 - 4.280)	1.470	13,80
25 + 25 + 35 + 42 + 50	1,45	1,45	1,86	2,33	2,91	10,00 (2,90 - 11,50)	3,11 B	3.215 (660 - 4.095)	1.608	14,80	1,74	1,74	2,23	2,79	3,50	12,00 (3,40 - 14,50)	3,93 A	3.050 (730 - 4.310)	1.525	14,30
25 + 25 + 42 + 42 + 42	1,46	1,46	2,36	2,36	2,36	10,00 (2,90 - 11,50)	3,17 B	3.150 (600 - 4.050)	1.575	14,50	1,77	1,77	2,82	2,82	2,82	12,00 (3,40 - 14,50)	4,03 A	2.980 (630 - 4.260)	1.490	14,00
25 + 25 + 42 + 42 + 50	1,64	2,09	2,09	2,09	2,09	10,00 (2,90 - 11,50)	3,16 B	3.160 (600 - 4.050)	1.580	14,60	1,96	2,51	2,51	2,51	2,51	12,00 (3,40 - 14,50)	4,03 A	2.980 (630 - 4.270)	1.490	14,00
25 + 35 + 35 + 35 + 35	1,55	1,99	1,99	1,99	2,48	10,00 (2,90 - 11,50)	3,16 B	3.160 (600 - 4.050)	1.580	14,60	1,85	2,39	2,39	2,98	2,98	12,00 (3,40 - 14,50)	4,03 A	2.980 (630 - 4.260)	1.490	14,00
25 + 35 + 35 + 35 + 50	1,46	1,87	1,87	1,87	2,93	10,00 (2,90 - 11,50)	3,11 B	3.215 (670 - 4.095)	1.608	14,80	1,74	2,25	2,25	2,25	3,51	12,00 (3,40 - 14,50)	3,95 A	3.040 (750 - 4.290)	1.520	14,30
25 + 35 + 35 + 42 + 42																				





# WELCOME TO THE COMMERCIAL RANGE





Here are some of your new air conditioner's major features. Panasonic has developed an impressive range of highly efficient Commercial Air Conditioners. This range confirms our commitment to the environment. Our Inverter compressors optimise performance and thus reduce energy costs.



# HIGHLIGHTED FEATURES





PACi: Commercial air to air. The full solution for shops, restaurants, offices or residential applications with outstanding efficiency and compact in size.

### Commercial benefits

#### Great savings and improved wellness.

Panasonic has developed an impressive range of highly efficient Commercial Air Conditioners. Our Inverter compressors optimise performance and thus reduce energy costs.

#### A wide range for the commerce, office or residence.

From the smaller 1X1 to the more complete 4x1 solutions, it doesn't

matter which your need is. Panasonic can offers you the best solution to get the best clima.

#### High connectivity.

The new control systems allows you to have complete control of all your installations. All your units from several locations, receive status updates in real-time, preventing breakdowns and optimizing costs.

### Energy saving



Intelligent Human Activity Sensor and new Sunlight Sensor technologies that can detect and reduce waste by optimising air conditioner operation according to room conditions. With just one touch of a button, you can save energy.



Exceptional Seasonal Cooling Efficiency based on the new ErP regulation. Higher SEER ratings mean greater efficiency. Save all the year while cooling!



Exceptional Seasonal Heating Efficiency based on the new ErP regulation. Higher SCOP ratings mean greater efficiency. Save all the year while heating!



Inverter plus products improve on the characteristics of standard Inverter range by over 20%. This means 20% less consumption and 20% off your electric bill. A Inverter plus is also A class on cooling and heating mode.



Wider operation Hz range of compressor realize more high efficient operation through the year. For Big PACi Series PE2.

### High performance

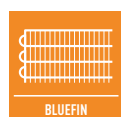

Panasonic has extended the life of its condensers with an original anti-rust coating. For Big PACi Series PE2.



Big size Fan makes larger airflow rate and very silent operation at low speed. For Big PACi Series PE2.



DC Fan: Save and precise.



The air conditioner works in cooling only mode with an outdoor temperature of -15°C.



The air conditioner works in heat pump mode even when outdoor temperatures are as low as -20°C or -15°C.



The Panasonic renewal system allows good quality existing R22 pipe work to be re-used whilst installing new high efficiency R410A systems.



5 years warranty. We guarantee the outdoor unit compressors in the entire range for five years.

### High connectivity



The new AC Smart Cloud from Panasonic allows you to have complete control of all your installations. In a simple click, all your units from several locations, receive status updates in real-time of all your installations, preventing breakdowns and optimizing costs.



Internet Control is a next generation system providing a user-friendly remote control of air conditioning or heat pump units from everywhere, using a simple Android or iOS smartphone, tablet or PC via internet.



The communication port is integrated into the indoor unit and provides easy connection to, and control of, your Panasonic heat pump to your home or building management system.



# PACi OUTDOOR UNITS ENERGY SAVING CONCEPT





Product quality and safety. All Panasonic air conditioners undergo strict quality and safety tests before sale. This rigorous process includes obtaining all necessary safety approvals, to ensure that all air conditioners we sell are not only built to the highest market standards, but are also completely safe.

### New Panasonic Mini PACi Series PE2

New outdoor PACi Elite from 3,6kW to 6,0kW and PACi Standard 6,0kW to 7,1kW, all made in Japan.

Fully new outdoor design with last generation compressor. Higher performance and better partial load. Includes control consumption, 0-10V demand control and all latest remote controller's functionalities.

#### Higher efficiency:

- New heat exchanger
- New and bigger fan
- New Panasonic Compressor
- New chassis



### PACi Standard: For economy and value

With high quality design and engineering, the PACi Standard is the perfect solution for projects which demand quality on a limited budget. In addition, its compact size and light weight make it ideal for installations with limited space including small commercial and residential applications.

The outdoor unit is much more compact than the previous model. The slim and lightweight design means the PACi outdoor unit can be installed in a number of situations. On the 12,5kW (996 x 940 x 340mm).

#### PACi Standard. From 6,0 to 14,0kW.

- Good balance, system cost vs energy efficiency
- Top class SEER/SCOP as a Standard Inverter category  
SEER: A++ / SCOP: A+ at 10,0kW (in 90x90 Cassette)
- Interchangeable controller with ECOi
- Compact outdoor units
- Twin connection possible
- Cooling operation up to -10°C
- Heating operation up to -15°C

### PACi Elite: Newly designed next generation of commercial air conditioning

Outstanding performance at low temperatures, high energy efficiency, power consumption in remote control display. Energy-saving concept. The use of energy saving design for the structure of fans, fan motors, compressors and heat exchangers resulted in high COP value which ranked as one the top class in the industry. In addition, use of highly efficient R410A refrigerant reduces CO<sub>2</sub> emission and lowers operating costs.

#### PACi Elite. From 3,6 to 25,0kW.

- Meeting all necessary safety approvals to ensure quality and safety
- Top-class SEER: A++ / SCOP: A++ at 10,0kW (in 90x90 Cassette)
- Cooling operation is possible when outdoor temperature as high as 46°C
- DC inverter technology combined with R410A for excellent efficiency
- Cooling operation is possible when outdoor temperature as low as -15°C
- Heating operation is possible when outdoor temperature as low as -20°C
- Compact outdoor units
- Auto restart from outdoor unit
- Twin, Triple and Doble-Twin connection possible

### New Big PACi Elite

New PACi 8 and 10HP are designed to adapt to current and most demanding commercial needs. Ready to connect to 1 big ducted indoor unit up to 4 indoor units.

#### Large capacity PACi Elite. Trusted power and high efficiency:

- Higher efficiency
- Better partial load (10% ~ 100%)
- More flexible piping
- Bluefin anti-rust coating
- 0-10V control demand
- Energy saving functions
- AHU connection kit
- From 1 to 4 indoor units



# PACi ELITE: EXCELLENT SEER AND SCOP VALUES

SEASONAL  
EFFICIENCY  
SEER — SCOP  
A++ / A++



Operating efficiency has been improved using highly efficient R410A refrigerant, new DC inverter compressor, new DC motor and a new heat exchanger design.

### Improved energy saving

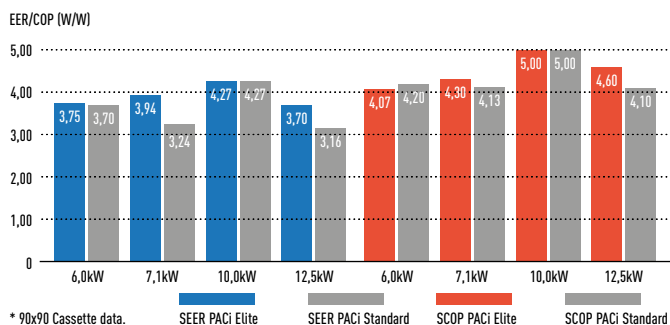

### Design operation conditions

Cooling operation is possible when outdoor temperature as low as -15°C or as high as 46°C. Heating operation is possible when outdoor temperature as low as -20°C. The remote control temperature setting offers a range from 18°C to 30°C.

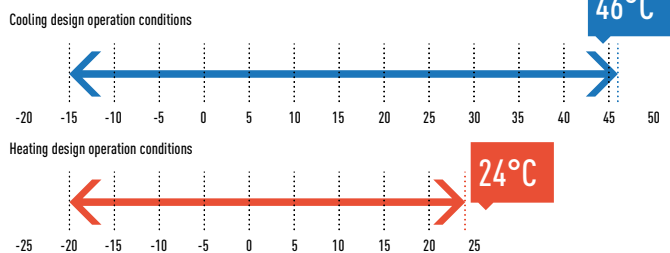

### Compact & Flexible-design

The slim and lightweight design means the PACi outdoor unit can be installed in a number of compact situations. As the unit only weighs 98kg, it is easy to carry and easy to install.

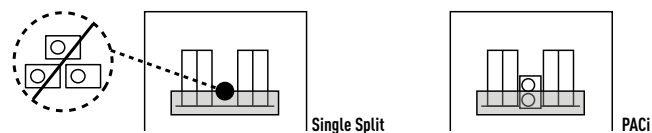

### Energy consumption monitoring display with the CZ-RTC5A

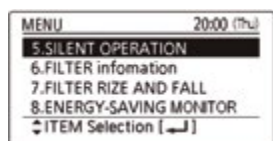

Menu selection: 3 types (Day/Week/Year) of display are available.

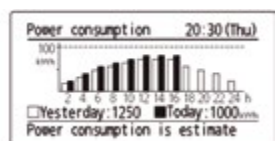

Daily Energy consumption: Data is shown with Yesterday's record. (Graph starts from 0 o'clock to 24 o'clock only.)

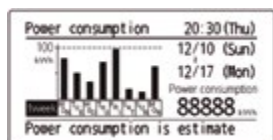

Weekly Energy consumption: Power consumption of each day of the week can be checked.

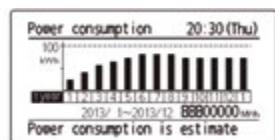

Annual Energy consumption: Power consumption of each month can be checked.

### Increased piping length for greater design flexibility

Adaptable to various building types and sizes. Maximum piping length: 75m (10.0, 12.5, 14.0kW). 50m (6.0, 7.1kW).

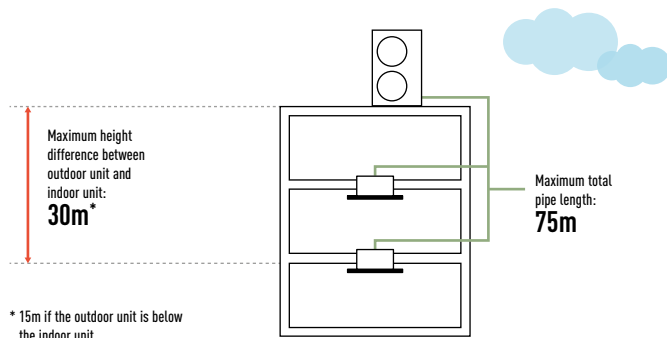

### Excellent SEER and SCOP values

Panasonic have an extremely high SEER and SCOP values following the SBEM method (some other manufacturers may use another non official calculation method). Developed by BRE, SBEM (Simplified Building Energy Model) is the basis of non-domestic building energy calculations. Based on the National calculation method (NCM), it is used to determine compliance with Part L of the Building Regulations and is also used to provide Energy Performance Certification.

Non-Domestic Building Services Compliance Guide provides information on various aspects of the calculation method, including those of Heat Pumps (Section 3), and Comfort Cooling (Section 9).

Part Load COP	SCOP - Seasonal Coefficient of Performance SEER - Seasonal Energy Efficiency Rating							
	25%	50%	75%	100%	25%	50%	75%	100%
Ambient conditions	15°C	7°C	1°C	-5°C	20°C	25°C	30°C	35°C
Weighting factor	0,20 (a)	0,36 (b)	0,32 (c)	0,12 (d)	0,20 (a)	0,36 (b)	0,32 (c)	0,12 (d)

UK winter -5°C DB (outdoor temp.), 20°C WB (indoor temp.). UK summer 21°C DB (outdoor temp.), 16°C WB (indoor temp.).

ESEER calculation corresponds with below conditions and power input of indoor units is not included.  
 - Indoor temperature: 27°C DB / 19°C WB - Outdoor temperature conditions

Part load ratio	25%	50%	75%	100%
Outdoor air temperature (°C DB)	20	25	30	35
Weighting coefficients	0,23	0,41	0,33	0,03

- Formula : 0,23 x EER<sub>25%</sub> + 0,41 x EER<sub>50%</sub> + 0,33 x EER<sub>75%</sub> + 0,03 x EER<sub>100%</sub>.

### Demand response compliant (CZ-CAPDC3)

This optional part allows demand control of the outdoor unit.

Several level of settings are available:

- Level-1, 2, 3 : 75 / 50 / 0 %
- Level-1, 2 can be set in 40 - 100% (40, 45, 50...95, 100: each 5%)

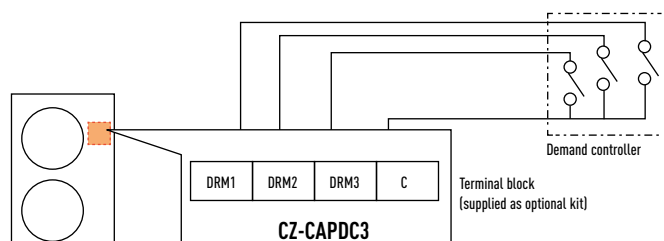

Demand control terminal is available to control 0-50-75% of capacities.



# SOLUTIONS FOR SERVER ROOMS





High efficiency products for 24/7 applications. Panasonic has developed a complete range of solutions for server rooms which efficiently protect your servers, keeping them at an appropriate temperature even when the outdoor temperature is below -20°C.



**High efficiency all the year**

On 24/7 operation, the performance of the air conditioning is a key factor. When the efficiency is high, the return on investment of such units is quickly reached.

**Key points**

- From 2,8 to 5kW with PKEA units, from 3,6 to 14kW with PACi units
- Backup function
- Redundancy function
- Alternative run function
- Error information by dry contact
- Operation even at -20°C outdoor temperature
- Excellent performance with excellent SEER
- Product design for 24/7 operation

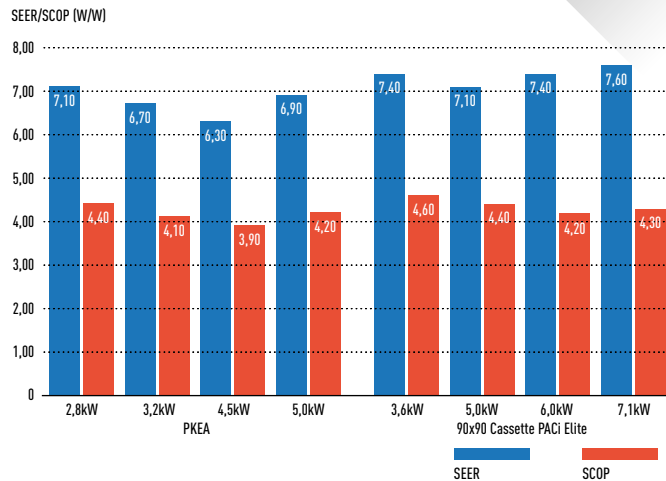

**Interface to run 2 PKEA. PAW-SERVER-PKEA**

The PAW-SERVER-PKEA server room interface manages redundancy and backup of two PKEA units with two different selectable modes:

- Plug and play by embedded redundancy and backup algorithm (no external signal needed. Further details please refer to operation manual)
- External (third party PLC) redundancy and backup management by dry contact

All settings are possible without the need for a computer connection. A special Energy Saving Mode is selectable by deep switch (available only in plug and play mode). The level of remote control input prohibition can be set when external management is by dry contact.

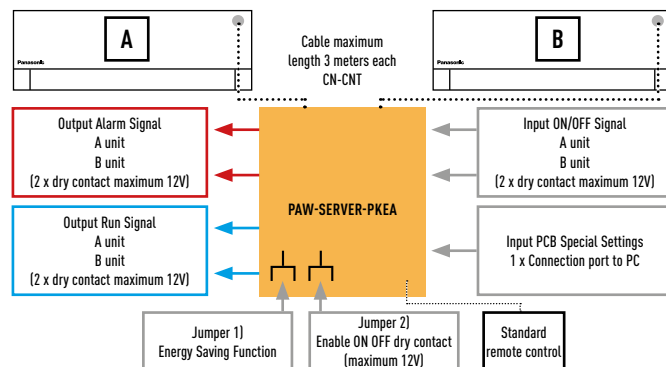

**Interfaces to run 2 or up to 3 PACi and VRF Range**

**PAW-PACR3**

In combination with one PAW-T10V on each indoor unit, allows the redundant operation of 2 (or 3) PACi or VRF indoor units. All units will be operated by programmable turns in order to achieve the same operating time (example turn every 8 hours with 24 hours). If the room temperature exceeds a freely set value, the 2nd (or 3rd) unit will be switched ON and an alarm will be activated.

**Backup control by using CZ-RTC5A.**

Group wiring of 2 systems of PACi can do auto individual control.

- Rotation operation
- Backup operation
- Support operation

**CZ-CAPRA1**

New Domestic with CZ-CNT port integration to PACi and ECOi.

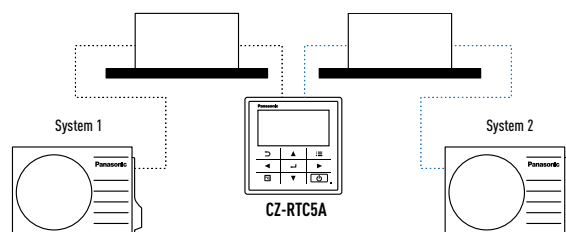
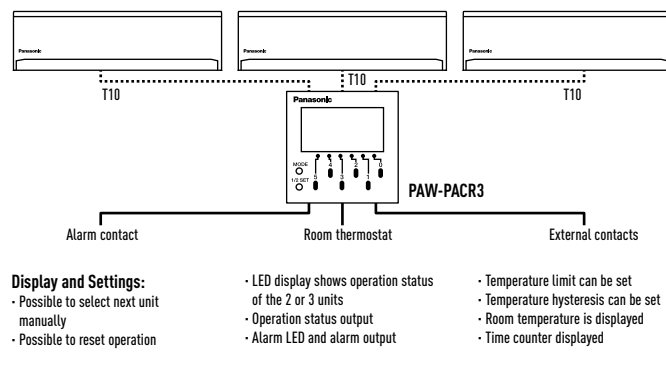

# NEW GENERATION PACi 90x90 CASSETTE



Panasonic introduces new flat panel design which is modern and matching well with your space. These cassettes have developed to satisfy today's customer needs such as highest energy saving, maximum comfort and healthier air.

**New PACi Cassette Panasonic**

- New flat panel design
- Better SCOP & SEER (up to 15%)
- Advanced comfort and energy saving by new Econavi sensor
- Air purification nanoe™ system
- Super quiet operation from 28dB(A)

These cassettes offer upgraded Econavi and nanoe™ purification system as accessories for making application space more comfortable, healthy and efficient.

**Always fresh and clean air with nanoe™**

- New nanoe™ is available by the advanced technology of room air conditioning.
- Purifying operation can work simultaneously or independently from heating/cooling operation.
  - Inhibiting viruses, bacteria & deodorisation (bacteria, fungus, pollen, virus and cigarette smoke). OH radicals in nanoe™ pull bacteria's hydrogen out and it is effectively deodorised be sterilised
  - Clean inside by nanoe™ + Dry control: inside of indoor unit can be cleaned by short operation circuit with nanoe™ and drying

CZ-RTC5A and optional accessory CZ-CNEXU1 are required to use nanoe™ function.

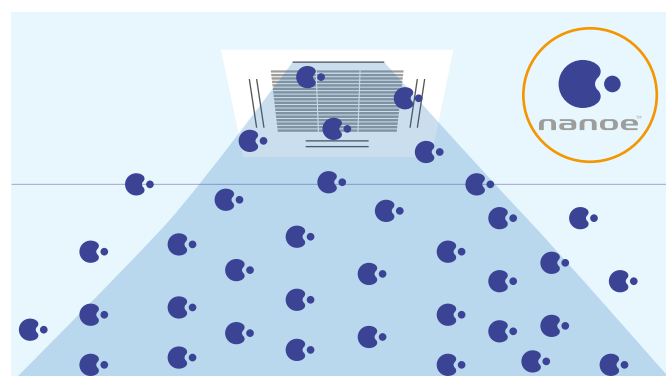

**Econavi intelligent sensor**

Human activity sensor and floor temperature sensor can reduce waste by optimising air conditioner operation.



**Advanced Econavi functions.**

2 sensors (movement and floor temperature) can find waste of energy and control effectively. Floor temperature can detect up to 5m ceiling height.

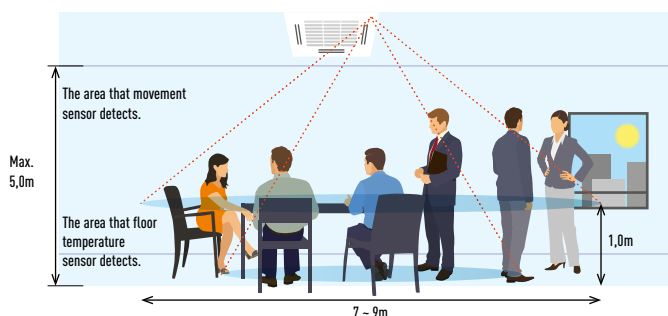

**Econavi exclusive panel. Optional (CZ-KPU3A)**

**Movement sensor.**  
This sensor detects the amount of human activity, and operates effectively.

**Floor temperature sensor.**  
This sensor detects average floor temperature and operates circulation if floor is low temperature.

**Wired remote controller CZ-RTC5A is required.**

**Humidity sensor.**

New humidity sensor has added on air suction part, and realises comfort and energy saving based on temperature and humidity.

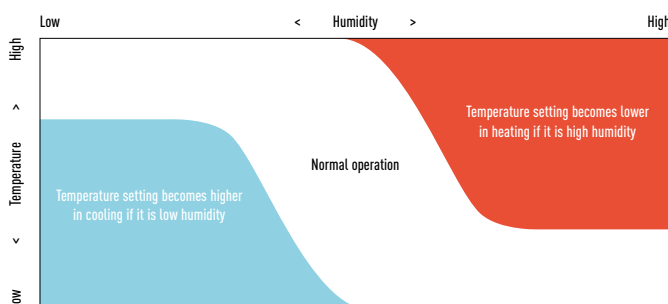





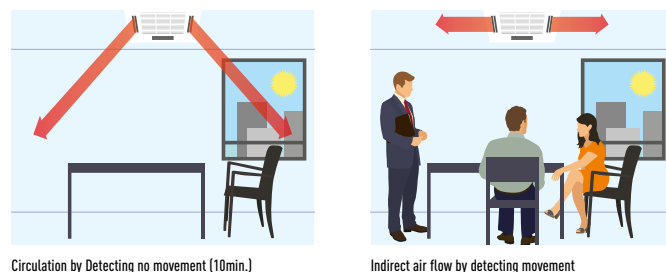





















**Group control, circulation function.**

Circulating operation is activated when nobody is there, and mix air in the whole room. Minimize temperature gap in both heating and cooling operation.



# RANGE OF COMMERCIAL UNITS

Indoor Units PACi Standard and Elite	3,6kW <sup>1</sup>	4,5kW <sup>1</sup>	5,0kW	6,0kW
New 4 Way 90x90 Cassette PACi Inverter+	 S-36PU2E5A	 S-45PU2E5A	 S-50PU2E5A	 S-60PU2E5A
4 Way 60x60 Cassette PACi Inverter+	 S-36PY2E5A	 S-45PY2E5A	 S-50PY2E5A	
Ceiling PACi Inverter+	 S-36PT2E5A	 S-45PT2E5A	 S-50PT2E5A	 S-60PT2E5A
High Static Pressure Hide Away PACi Inverter+	 S-36PF1E5A	 S-45PF1E5A	 S-50PF1E5A	 S-60PF1E5A
Low Static Pressure Hide Away PACi Inverter+	 S-36PN1E5A	 S-45PN1E5A	 S-50PN1E5A	 S-60PN1E5A
Wall PACi Inverter+	 S-36PK1E5A	 S-45PK1E5A	 S-50PK1E5A	 S-60PK1E5A
High Static Pressure Hide Away 20,0 - 25,0kW PACi Inverter+				
Air Curtain with DX Coil Jet-Flow // Standard				

Outdoor Units PACi Standard and Elite	3,6kW		5,0kW	6,0kW
PACi Standard				 U-60PE2E5A <sup>1</sup>
PACi Elite	 U-36PE2E5A <sup>1</sup>		 U-50PE2E5A <sup>1</sup>	 U-60PE2E5A <sup>1</sup>

1) The indoor units from 3,6 to 4,5kW are only available only for Twin, Triple and Doble-Twin combinations. <sup>1</sup> Single Phase <sup>2</sup> Three Phase.

Wall Mounted for professional applications	2,8kW	3,2kW	4,5kW	5,0kW
Wall Mounted PKEA Professional Inverter -20°C	 KIT-E9-PKEA	 KIT-E12-PKEA	 KIT-E15-PKEA	 KIT-E18-PKEA



7,1kW	10,0kW	12,5kW	14,0kW	20,0kW	25,0kW
 S-71PU2E5A	 S-100PU2E5A	 S-125PU2E5A	 S-140PU2E5A		
 S-71PT2E5A	 S-100PT2E5A	 S-125PT2E5A	 S-140PT2E5A		
 S-71PF1E5A	 S-100PF1E5A	 S-125PF1E5A	 S-140PF1E5A		
 S-71PN1E5A	 S-100PN1E5A	 S-125PN1E5A	 S-140PN1E5A		
 S-71PK1E5A	 S-100PK1E5A (9,5kW)				
				 S-200PE2E5	 S-250PE2E5
	 PAW-10PAIRC-MJ // PAW-10PAIRC-MS (9,2kW)		 PAW-15PAIRC-MJ // PAW-20PAIRC-MS (17,5kW)	 PAW-20PAIRC-MJ (23,1kW)	

7,1kW	10,0kW	12,5kW	14,0kW	20,0kW	25,0kW
 U-71PEY2E5 <sup>1</sup>	 U-100PEY1E5 <sup>1</sup> // U-100PEY1E8 <sup>III</sup>	 U-125PEY1E5 <sup>1</sup> // U-125PEY1E8 <sup>III</sup>	 U-140PEY1E8 <sup>III</sup>		
 U-71PE1E5A <sup>1</sup> // U-71PE1E8A <sup>III</sup>	 U-100PE1E5A <sup>1</sup> // U-100PE1E8A <sup>III</sup>	 U-125PE1E5A <sup>1</sup> // U-125PE1E8A <sup>III</sup>	 U-140PE1E5A <sup>1</sup> // U-140PE1E8A <sup>III</sup>	 U-200PE2E8A <sup>III</sup>	 U-250PE2E8A <sup>III</sup>

**Air Handling Unit**

3 types of AHU Kit: Deluxe, Medium and Light.  
Up to 28kW (Common use for all outdoor units. Only 1 by 1 connection is allowed.)

**28,0kW**



PAW-280PAH2 // PAW-280PAH2M // PAW-280PAH2L

# WALL MOUNTED PKEA PROFESSIONAL INVERTER -20°C

SERVER ROOM SOLUTION WITH THE HIGHEST EFFICIENCY OF THE MARKET  
24/7 OPERATION

Complete line-up with high efficiency even at -20°C

### High durability for 24/7 operation

#### Indoor Fan. Cross-Flow-Fan.

- High durability rolling bearings, large size (105mm) fan
- High efficiency blade
- Random pitch blade (low sound)

#### Compressor.

DC2P Panasonic original compressor, with high efficiency and reliability.

### Why is the Panasonic R2 Rotary Compressor so efficient?

1. High efficiency motor: the premium silicon steel motor meets industry efficiency requirements
2. Improved lubrication of high volume oil pump: the extended, high volume oil pump in conjunction with a larger capacity oil reservoir provides superior lubrication
3. Accumulator has larger refrigerant capacity: the larger accumulator accommodates generous refrigerant amounts needed in longer line length installations

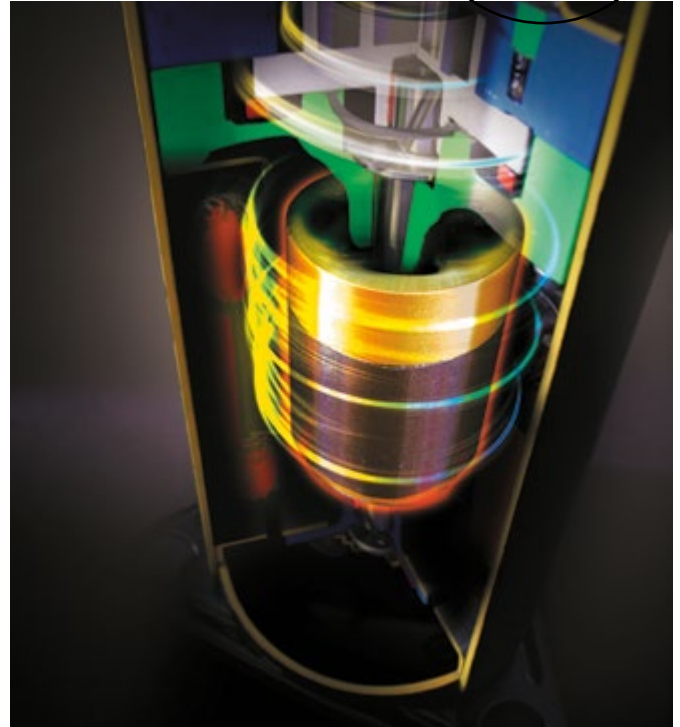

### PKEA provides high capacity at -20°C!

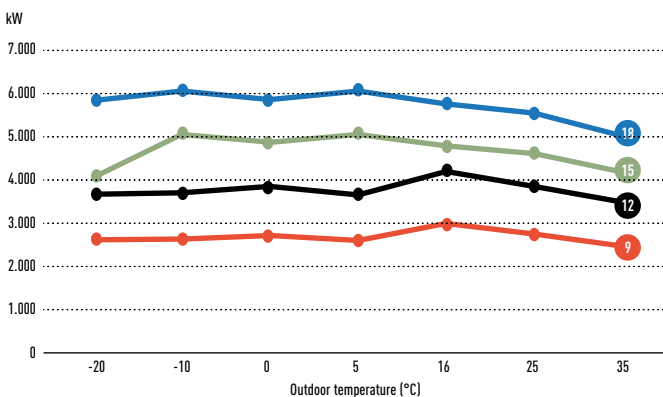

### Interface option to manage server room operation

The PAW-SERVER-PKEA server room interface manages redundancy and backup of two PKEA units with two different selectable modes:

- Plug and play by embedded redundancy and backup algorithm (no external signal needed. Further details please refer to operation manual)
- External (third party PLC) redundancy and backup management by dry contact

All settings are possible without the need for a computer connection. A special Energy Saving Mode is selectable by deep switch (available only in plug and play mode). The level of remote control input prohibition can be set when external management is by dry contact.

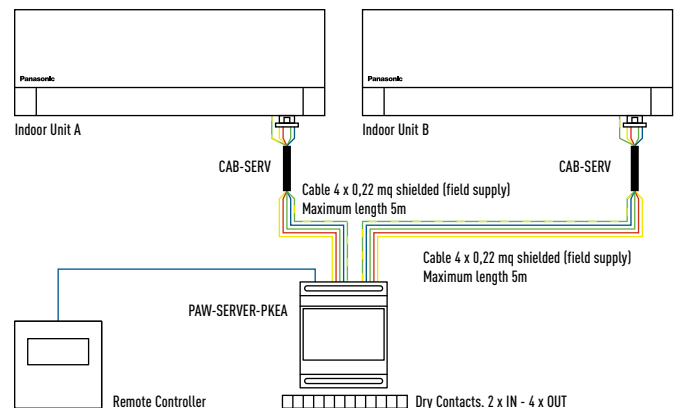

#### Main Features

- Cascade management
- Back Up system
- Overheating prevention

- ECO function
- BMS management available

#### Only available

- CS.ZXXTKEA
- CS.EXXOKE / PKE / NKE



Included on the kit.  
Timer remote controller



This Wall Mounted air conditioner is especially designed for professional applications such as computer rooms where cooling inside the room is necessary even when the outside temperature is low. Furthermore this air conditioner has an automatic changeover system, in order to maintain the inside temperature even when sharp outside temperature changes occur.

**Technical focus**

- This units can be installed on R22 pipings
- Designed for 24h/7d a week operation

- Highly efficient even at -20°C
- High durability rolling bearings
- Additional piping sensors to prevent freezing

**Outdoor Features**

- Cooling even when ambient temperature is as low as -20°C
- Electronic expansion valve (accurate sub-cooling and adjustable refrigerant flow)
- Outdoor DC fan motor to provide flexible air-flow to ensure optimum condensation pressure (works on outdoor pipe temperature sensor)

**WALL MOUNTED PKEA**

			Single Phase			
			2,8kW	3,2kW	4,5kW	5,0kW
KIT			KIT-E9-PKEA	KIT-E12-PKEA	KIT-E15-PKEA	KIT-E18-PKEA
Cooling capacity	Nominal (Min - Max)	kW	2,50 (0,85 - 3,00)	3,50 (0,85 - 4,00)	4,20 (0,98 - 5,00)	5,00 (0,98 - 6,00)
EER <sup>1)</sup>	Nominal (Min - Max)	W/W	4,85 (4,23 - 5,00) A	4,02 (3,57 - 5,00) A	3,50 (3,50 - 3,16) A	3,47 (3,50 - 3,02) A
Cooling capacity at -10°C		kW	2,63	3,69	5,04	6,00
EER at -10°C		W/W	7,19	5,96	6,01	6,00
Cooling capacity at -20°C		kW	2,61	3,66	4,06	5,82
EER at -20°C		W/W	6,71	5,56	4,39	5,39
SEER <sup>2)</sup>		W/W	7,10 <b>A++</b>	6,70 <b>A++</b>	6,30 <b>A++</b>	6,90 <b>A++</b>
Pdesign		kW	2,5	3,5	4,2	5,0
Input power cooling	Nominal (Min - Max)	kW	0,52 (0,17 - 0,71)	0,87 (0,17 - 1,12)	1,20 (0,28 - 1,58)	1,44 (0,28 - 1,99)
Annual electricity consumption (cooling) <sup>3)</sup>		kWh/a	123	183	233	254
Heating capacity	Nominal (Min - Max)	kW	3,40 (0,85 - 5,40)	4,00 (0,85 - 6,60)	5,40 (0,98 - 7,10)	5,80 (0,98 - 8,00)
Heating capacity at -7°C <sup>4)</sup>		kW	3,33	4,07	4,10	4,98
COP <sup>5)</sup>	Nominal (Min - Max)	W/W	4,86 (4,12 - 5,15) A	4,35 (3,63 - 5,15) A	3,75 (2,88 - 3,24) A	3,82 (2,88 - 3,11) A
SCOP <sup>5)</sup>		W/W	4,40 <b>A+</b>	4,10 <b>A+</b>	3,90 <b>A</b>	4,20 <b>A+</b>
Pdesign at -10°C		kW	2,8	3,6	3,6	4,4
Input power heating	Nominal (Min - Max)	kW	0,70 (0,165 - 1,31)	0,92 (0,17 - 1,82)	1,44 (0,34 - 2,19)	1,52 (0,34 - 2,57)
Annual electricity consumption (heating) <sup>3)</sup>		kWh/a	891	1.229	1.292	1.467
<b>Indoor Unit</b>			<b>CS-E9PKEA</b>	<b>CS-E12PKEA</b>	<b>CS-E15PKEA</b>	<b>CS-E18PKEA</b>
Power source		V	230	230	230	230
Recommended fuse		A	16	16	16	16
Connection indoor / outdoor		mm	4 x 1,5	4 x 1,5	4 x 1,5	4 x 2,5
Current	Cooling / Heating	A	2,5 / 3,3	4,0 / 4,2	5,4 / 6,5	6,4 / 6,8
Max. Current		A	7,8	8,4	9,6	11,3
Air Volume	Cooling / Heating	m³/min	13,3 / 14,6	13,6 / 14,7	14,1 / 15,0	17,9 / 19,3
Moisture removal volume		L/h	1,5	2,0	2,4	2,8
Sound pressure <sup>6)</sup>	Cooling (Hi / Lo / S-Lo)	dB(A)	39 / 26 / 23	42 / 29 / 26	43 / 32 / 29	44 / 37 / 34
	Heating (Hi / Lo / S-Lo)	dB(A)	40 / 27 / 24	42 / 33 / 29	43 / 35 / 29	44 / 37 / 34
Sound power	Cooling / Heating (Hi)	dB	55 / 56	58 / 58	59 / 59	60 / 60
Dimensions / Net weight	H x W x D	mm / kg	295 x 870 x 255 / 10	295 x 870 x 255 / 10	295 x 870 x 255 / 10	295 x 1.070 x 255 / 13
<b>Outdoor Unit</b>			<b>CU-E9PKEA</b>	<b>CU-E12PKEA</b>	<b>CU-E15PKEA</b>	<b>CU-E18PKEA</b>
Air Volume	Cooling / Heating	m³/min	31,3 / 29,7	32,9 / 32,1	34,2 / 33,0	39,2 / 37,9
Sound pressure <sup>6)</sup>	Cooling / Heating (Hi)	dB(A)	46 / 47	48 / 50	46 / 46	47 / 47
Sound power	Cooling / Heating (Hi)	dB	61 / 62	63 / 65	61 / 61	61 / 61
Dimensions <sup>7)</sup> / Net weight	H x W x D	mm / kg	622 x 824 x 299 / 36	622 x 824 x 299 / 36	695 x 875 x 320 / 45	695 x 875 x 320 / 46
Piping connections	Liquid pipe / Gas pipe	Inch (mm)	1/4 (6,35) / 3/8 (9,52)	1/4 (6,35) / 3/8 (9,52)	1/4 (6,35) / 1/2 (12,70)	1/4 (6,35) / 1/2 (12,70)
Piping length range / Elevation difference (in/out) <sup>8)</sup>		m	3 - 15 / 5	3 - 15 / 5	3 - 15 / 15	3 - 20 / 15
Pipe length for additional gas / Additional gas amount		m / g/m	7,5 / 20	7,5 / 20	7,5 / 20	7,5 / 20
Refrigerant loading		kg	1,10	1,10	1,06	1,24
Operating range	Cooling Min / Max	°C	-20 ~ +43	-20 ~ +43	-20 ~ +43	-20 ~ +43
	Heating Min / Max	°C	-15 ~ +24	-15 ~ +24	-15 ~ +24	-15 ~ +24

Rating Conditions for cooling capacity at low temperature: Cooling Indoor 27°C DB / 19°C WB. Cooling Outdoor 0°C DB / -10°C WB.

1) EER and COP, Energy Saving Classification, is at 220 / 240V (380 / 415V) only in accordance with EU directive 2002/31/EC. 2) SEER is calculated in base Eurovent IPLV for SBEM for U1 indoor unit SEER=a(EER25)+b(EER50)+c(EER75)+d(EER100) where EER25, EER50, EER75 and EER100 are the EER measured value at 25%, 50%, 75% and 100% part load for temperatures 20, 25, 30 and 35°C DB, respectively. a, b, c and d are values assigned for an office type. These values are given as a=0,2, b=0,36, c=0,32 and d=0,03. The internal temperatures are taken at 27°C DB and 19°C WB. 3) The annual consumption (ErP) is calculated by formula determined by ErP regulation. 4) Heating capacity is calculated including defrost factor correction. 5) SCOP is calculated in base Eurovent IPLV for SBEM with U1 indoor unit including defrost correction factor. 6) The Sound pressure of the units shows the value measured of a position 1 meter in front of the main body and 1,5m from the ground. The sound pressure is measured in accordance with Eurovent 6/C/006-97 specification. 7) Add 70mm for piping port. 8) When installing the outdoor unit at a higher position than the indoor unit. // Recommended fuse for the indoor 3A.

A++  
7,10 SEER

A+  
4,48 SCOP

INVERTER+

R2 ROTARY COMPRESSOR

23dB(A) SUPER QUIET

-20°C COOLING MODE

-15°C HEATING MODE

R22 RENEWAL

INTEGRATION P-LINE

INTERNET CONTROL

CONNECTIVITY

5 YEARS WARRANTY

SEER and SCOP: For KIT-E9-PKEA. SUPER QUIET: For KIT-Z25-TXEA. INTERNET CONTROL: Optional. Compatible with all Panasonic connectivity solutions. For detailed information go to the Control Systems section.

Rating Conditions: Cooling Indoor 27°C DB / 19°C WB. Cooling Outdoor 35°C DB / 24°C WB. Heating Indoor 20°C DB. Heating Outdoor 7°C DB / 6°C WB. (DB: Dry Bulb; WB: Wet Bulb) Specifications subject to change without notice. For detailed information about ErP, please visit our websites www.aircon.panasonic.eu or www.ptc.panasonic.eu.



# 4 WAY 90x90 CASSETTE PACi INVERTER+

Large capacity PACi. Trusted power and high efficiency.

Thanks to advances in design and technology such as the new high performance turbo fan, more efficient and silent, the nanoe™ air cleaner, for total healthy and the floor temperature & humidity sensor to more control, the new U2 Panasonic 90x90 4 way cassette is the best Industry in energy savings, healthy and comfort.

### Technical focus

- New high performance turbo fan, new path system for heat exchanger
- Lower noise in slow fan operation
- Industry top light weight, easy piping
- Easy installation structure of the panel
- Econavi: Floor temperature and humidity sensor added. Activity amount detection and new circulator
- Nanoe™: The first 10x for CAC (10 times more purification power). Inside cleaning by 10x nanoe™ + dry control

			PACi STANDARD							
			Single Phase				Three Phase			
			6,0kW	7,1kW	10,0kW	12,5kW	10,0kW	12,5kW	14,0kW	
KIT			KIT-60PUY2E5B	KIT-71PUY2E5B	KIT-100PUY2E5A	KIT-125PUY2E5A	KIT-100PUY2E8A	KIT-125PUY2E8A	KIT-140PUY2E8A	
Panel			CZ-KPU3	CZ-KPU3	CZ-KPU3	CZ-KPU3	CZ-KPU3	CZ-KPU3	CZ-KPU3	
Timer remote controller			CZ-RTC5A	CZ-RTC5A	CZ-RTC5A	CZ-RTC5A	CZ-RTC5A	CZ-RTC5A	CZ-RTC5A	
Cooling capacity	Nominal (Min - Max)	kW	6,0 (2,0 - 7,1)	7,1 (2,0 - 7,7)	10,0 (3,3 - 12,5)	12,5 (3,8 - 15,5)	10,0 (2,7 - 11,5)	12,5 (3,8 - 13,5)	14,0 (3,3 - 15,5)	
EER <sup>1)</sup>	Nominal (Min - Max)	W/W	3,70 (8,00 - 3,23) A	3,24 (8,00 - 2,91) A	4,27 (4,29 - 3,38) A	3,16 (4,22 - 2,77) B	3,16 (5,09 - 2,74) B	3,16 (4,22 - 2,77) B	3,25 (3,93 - 2,67) A	
SEER <sup>2)</sup>		W/W	7,00 <b>A++</b>	6,50 <b>A++</b>	7,60 <b>A++</b>	—	6,60 <b>A++</b>	—	—	
Pdesign		kW	6,0	7,1	10,0	—	10,0	—	—	
Input power cooling	Nominal (Min - Max)	kW	1,62 (0,25 - 2,20)	2,19 (0,25 - 2,65)	2,34 (0,77 - 3,70)	3,96 (0,90 - 4,88)	3,16 (0,53 - 4,20)	3,96 (0,90 - 4,88)	4,31 (0,84 - 5,81)	
Annual energy consumption (ErP) <sup>3)</sup>		kWh/a	300	382	461	—	530	—	—	
Heating capacity	Nominal (Min - Max)	kW	6,0 (1,8 - 7,0)	7,1 (1,8 - 8,1)	11,2 (4,1 - 14,0)	12,5 (3,4 - 15,0)	10,0 (2,1 - 13,8)	12,5 (3,4 - 15,0)	14,0 (4,1 - 16,0)	
Heating capacity at -7/-15°C <sup>4)</sup>		kW	— / —	— / —	— / —	— / —	— / —	— / —	— / —	
COP <sup>1)</sup>	Nominal (Min - Max)	W/W	4,20 (9,00 - 4,24) A	4,13 (9,00 - 3,68) A	5,00 (5,19 - 3,18) A	4,10 (4,66 - 3,41) A	4,15 (5,12 - 3,45) A	4,10 (4,66 - 3,41) A	4,15 (4,56 - 3,08) A	
SCOP <sup>5)</sup>		W/W	4,10 <b>A+</b>	4,20 <b>A+</b>	4,80 <b>A++</b>	—	4,30 <b>A+</b>	—	—	
Pdesign at -10°C		kW	6,0	6,0	10,0	—	10,0	—	—	
Input power heating	Nominal (Min - Max)	kW	1,43 (0,20 - 1,65)	1,72 (0,20 - 2,20)	2,24 (0,79 - 4,40)	3,05 (0,73 - 4,40)	2,41 (0,41 - 4,00)	3,05 (0,73 - 4,40)	3,37 (0,90 - 5,20)	
Annual energy consumption (ErP) <sup>3)</sup>		kWh/a	2,047	2,002	2,917	—	3,256	—	—	
<b>Indoor Unit</b>			<b>S-60PU2E5A</b>	<b>S-71PU2E5A</b>	<b>S-100PU2E5A</b>	<b>S-125PU2E5A</b>	<b>S-100PU2E5A</b>	<b>S-125PU2E5A</b>	<b>S-140PU2E5A</b>	
Air volume	Hi / Med / Lo	m³/min	21,0 / 16,0 / 13,0	22,0 / 16,0 / 13,0	36,0 / 26,0 / 18,0	37,0 / 27,0 / 19,0	36,0 / 26,0 / 18,0	37,0 / 27,0 / 19,0	38,0 / 29,0 / 20,0	
Moisture removal volume		L/h	1,7	2,5	2,7	4,8	2,7	4,8	6,0	
Sound pressure <sup>6)</sup>	Hi / Med / Lo	dB(A)	36 / 31 / 28	37 / 31 / 28	45 / 38 / 32	46 / 39 / 33	45 / 38 / 32	46 / 39 / 33	47 / 40 / 34	
Sound power	Hi / Med / Lo	dB	51 / 46 / 43	52 / 46 / 43	60 / 53 / 47	61 / 54 / 48	60 / 53 / 47	61 / 54 / 48	62 / 55 / 49	
Dimensions (H x W x D)	Indoor	mm / kg	256 x 840 x 840 / 20	256 x 840 x 840 / 20	319 x 840 x 840 / 25	319 x 840 x 840 / 25	319 x 840 x 840 / 25	319 x 840 x 840 / 25	319 x 840 x 840 / 25	
Net weight	Panel	mm / kg	33,5 x 950 x 950 / 5	33,5 x 950 x 950 / 5	33,5 x 950 x 950 / 5	33,5 x 950 x 950 / 5	33,5 x 950 x 950 / 5	33,5 x 950 x 950 / 5	33,5 x 950 x 950 / 5	
<b>Outdoor Unit</b>			<b>U-60PEY2E5</b>	<b>U-71PEY2E5</b>	<b>U-100PEY1E5</b>	<b>U-125PEY1E5</b>	<b>U-100PEY1E8</b>	<b>U-125PEY1E8</b>	<b>U-140PEY1E8</b>	
Power source		V	220 / 230 / 240	220 / 230 / 240	220 / 230 / 240	220 / 230 / 240	380 / 400 / 415	380 / 400 / 415	380 / 400 / 415	
Recommended fuse		A	—	—	—	30	16	16	16	
Connection		mm²	—	—	—	6,0	2,5	2,5	2,5	
Current	Cooling	A	8,00 / 7,60 / 7,30	10,70 / 10,30 / 9,85	0,82 / 0,79 / 0,76	19,2 / 18,4 / 17,6	5,10 / 4,85 / 4,70	6,35 / 6,05 / 5,80	6,85 / 6,50 / 6,25	
	Heating	A	7,05 / 6,75 / 6,45	8,50 / 8,10 / 7,80	0,81 / 0,78 / 0,75	15,4 / 14,8 / 14,2	4,15 / 3,95 / 3,80	5,15 / 4,90 / 4,70	5,65 / 5,35 / 5,20	
Air volume	Cooling / Heating	m³/min	38 / 41	44 / 41	110 / 95	80 / 73	76 / 67	80 / 73	135 / 120	
Sound pressure	Cooling / Heating (Hi)	dB(A)	46 / 48	49 / 49	52 / 52	56 / 56	54 / 54	56 / 56	54 / 53	
Sound power	Cooling / Heating (Hi)	dB	65 / 68	69 / 69	69 / 69	73 / 73	70 / 70	73 / 73	71 / 70	
Dimensions	H x W x D	mm	619 x 799 x 299	619 x 799 x 299	996 x 940 x 340	996 x 940 x 340	996 x 940 x 340	996 x 940 x 340	1.416 x 940 x 340	
Net weight		kg	40	40	73	85	73	85	98	
Piping connections	Liquid pipe	Inch (mm)	3/8 (9,52)	3/8 (9,52)	3/8 (9,52)	3/8 (9,52)	3/8 (9,52)	3/8 (9,52)	3/8 (9,52)	
	Gas pipe	Inch (mm)	5/8 (15,88)	5/8 (15,88)	5/8 (15,88)	5/8 (15,88)	5/8 (15,88)	5/8 (15,88)	5/8 (15,88)	
Piping length range / Elevation difference (in/out) <sup>7)</sup>		m	3 - 40 / 30	3 - 40 / 30	5 - 50 / 30	5 - 50 / 30	5 - 50 / 30	5 - 50 / 30	5 - 50 / 30	
Pipe length for additional gas / Additional gas amount		m / g/m	30 / 40	30 / 40	30 / 50	30 / 50	30 / 50	30 / 50	30 / 50	
Refrigerant (R410A)		kg / TCO: Eq.	1,95 / 4,0716	1,95 / 4,0716	2,60 / 5,4288	3,20 / 6,6816	2,60 / 5,4288	3,20 / 6,6816	3,40 / 7,0992	
Operating range	Cooling Min - Max	°C	-10 ~ +43	-10 ~ +43	-10 ~ +43	-10 ~ +43	-10 ~ +43	-10 ~ +43	-10 ~ +43	
	Heating Min - Max	°C	-15 ~ +24	-15 ~ +24	-15 ~ +24	-15 ~ +24	-15 ~ +24	-15 ~ +24	-15 ~ +24	

1) EER and COP, Energy Saving Classification, is at 220 / 240V (380 / 415V) only in accordance with EU directive 2002/31/EC. 2) SEER is calculated in base Eurovent IPLV for SBEM for U1 indoor unit SEER=a(EER25)+b(EER50)+c(EER75)+d(EER100) where EER25, EER50, EER75 and EER100 are the EER measured value at 25%, 50%, 75% and 100% part load for temperatures 20, 25, 30 and 35°C DB, respectively. a, b, c and d are values assigned for an office type. These values are given as a=0,2, b=0,36, c=0,32 and d=0,03. The internal temperatures are taken at 27°C DB and 19°C WB. 3) The annual consumption(ErP) is calculated by formula determined by ErP regulation. 4) Heating capacity is calculated including defrost factor correction. 5) SCOP is calculated in base Eurovent IPLV for SBEM with U1 indoor unit including defrost correction factor. 6) The Sound pressure of the units shows the value measured of a position 1 meter in front of the main body and 1,5 m from the ground. The sound pressure is measured in accordance with Eurovent 6/C/006-97 specification. 7) When installing the outdoor unit at a higher position than the indoor unit. // Recommended fuse for the indoor 3A.

### STANDARD

### ELITE

<b>A++</b> 7,60 SEER	<b>A++</b> 4,80 SCOP	<b>-10°C</b> COOLING MODE	<b>-15°C</b> HEATING MODE	<b>A++</b> 7,60 SEER	<b>A++</b> 4,80 SCOP	<b>-15°C</b> COOLING MODE	<b>-20°C</b> HEATING MODE	<b>INVERTER+</b>	<b>28%</b> ECONAVI	<b>99%</b> nanoe	<b>DC FAN</b>	<b>R32 RENEWAL</b>	<b>RAIR4</b>	<b>INTERNET CONTROL</b>	<b>BMS CONNECTIVITY</b>	<b>5 YEARS WARRANTY</b>
-------------------------	-------------------------	------------------------------	------------------------------	-------------------------	-------------------------	------------------------------	------------------------------	------------------	-----------------------	---------------------	---------------	--------------------	--------------	-------------------------	-------------------------	-------------------------

SEER and SCOP: For KIT-100PU2E5A.

SEER and SCOP: For KIT-100PU2E5A.

ECONAVI and INTERNET CONTROL: Optional. Compatible with all Panasonic connectivity solutions. For detailed information go to the Control Systems section.





-  **Included Controller:**  
Wired remote controller  
CZ-RTC5A  
Compatible with Econavi and nanoe™
-  **Optional Controller:**  
Timer remote controller  
CZ-RTC4  
Compatible with Econavi
-  **Optional Controller:**  
Wireless remote control  
CZ-RWSU3
-  **Optional Controller:**  
Simplified remote controller  
CZ-REZC2
-  **Econavi panel: CZ-KPU3A**  
(CZ-RTC5A is required)
-  **Optional nanoe™ kit:**  
CZ-CNEXU1 (CZ-RTC5A is required)

**Group control, new circulation function**

Do circulating operation when nobody there, and mix air in the whole room. Minimize temperature gap in both heating and cooling operation.

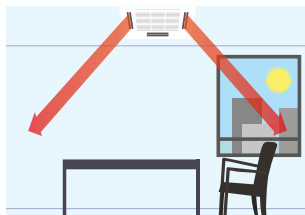

Circulation by Detecting no movement (10min.)



Indirect air flow by detecting movement

**2 types of body with height difference (same as current ones)**

25,6cm and 31,9cm.

**Always fresh and clean air with nanoe™**

New nanoe™ is newly developed for PACi cassette by the advanced technology of Room Air conditioning.

CZ-RTC5A and optional accessory CZ-CNEXU1 are required to use nanoe™ function.

**PACi ELITE**

Single Phase						Three Phase					
3,6kW	5,0kW	6,0kW	7,1kW	10,0kW	12,5kW	14,0kW	7,1kW	10,0kW	12,5kW	14,0kW	
KIT-36PU2E5B	KIT-50PU2E5B	KIT-60PU2E5B	KIT-71PU2E5A	KIT-100PU2E5A	KIT-125PU2E5A	KIT-140PU2E5A	KIT-71PU1E8A	KIT-100PU1E8A	KIT-125PU1E8A	KIT-140PU1E8A	
CZ-KPU3	CZ-KPU3	CZ-KPU3	CZ-KPU3	CZ-KPU3	CZ-KPU3	CZ-KPU3	CZ-KPU3	CZ-KPU3	CZ-KPU3	CZ-KPU3	
CZ-RTCSA	CZ-RTCSA	CZ-RTCSA	CZ-RTCSA	CZ-RTCSA	CZ-RTCSA	CZ-RTCSA	CZ-RTCSA	CZ-RTCSA	CZ-RTCSA	CZ-RTCSA	
3.6 (1.5 - 4.0)	5.0 (1.5 - 5.6)	6.0 (2.0 - 7.1)	7.1 (2.5 - 8.0)	10.0 (3.03 - 12.5)	12.5 (3.3 - 14.0)	14.0 (3.3 - 15.5)	7.1 (3.2 - 8.0)	10.0 (3.3 - 12.5)	12.5 (3.3 - 14.0)	14.0 (3.3 - 15.0)	
4.68 (6.25 - 4.40) A	3.79 (6.25 - 3.46) A	3.75 (8.00 - 3.23) A	3.94 (5.56 - 3.02) A	4.27 (4.29 - 3.38) A	3.70 (4.29 - 3.04) A	3.30 (4.29 - 2.70) A	3.94 (5.71 - 3.02) A	4.27 (4.29 - 3.38) A	3.70 (4.29 - 3.04) A	3.30 (4.29 - 2.70) A	
<b>7,40</b> <b>A+++</b>	<b>7,10</b> <b>A+++</b>	<b>7,40</b> <b>A+++</b>	<b>7,60</b> <b>A+++</b>	<b>7,60</b> <b>A+++</b>	—	—	<b>7,30</b> <b>A+++</b>	<b>7,40</b> <b>A+++</b>	—	—	
3,6	5,0	6,0	7,1	10,0	—	—	7,1	10,0	—	—	
0.77 (0.24 - 0.91)	1.32 (0.24 - 1.62)	1.60 (0.25 - 2.20)	1.80 (0.45 - 2.65)	2.34 (0.77 - 3.70)	3.37 (0.77 - 4.60)	4.24 (0.77 - 5.74)	1.80 (0.56 - 2.65)	2.34 (0.77 - 3.70)	3.37 (0.77 - 4.60)	4.24 (0.77 - 5.74)	
170	246	284	327	461	—	—	340	473	—	—	
4.0 (1.5 - 5.0)	5.6 (1.5 - 6.5)	7.0 (1.8 - 8.0)	8.0 (2.0 - 9.0)	11.2 (4.1 - 14.0)	14.0 (4.1 - 16.0)	16.0 (4.1 - 18.0)	8.0 (2.8 - 9.0)	11.2 (4.1 - 14.0)	14.0 (4.1 - 16.0)	16.0 (4.1 - 18.0)	
— / —	— / —	— / —	— / —	— / —	— / —	— / —	— / —	— / —	— / —	— / —	
5.13 (7.89 - 4.63) A	4.44 (7.89 - 4.01) A	4.07 (9.00 - 3.90) A	4.30 (5.00 - 3.16) A	5.00 (5.19 - 3.18) A	4.60 (5.19 - 3.17) A	4.30 (5.19 - 3.15) A	4.30 (5.60 - 3.16) A	5.00 (5.19 - 3.18) A	4.60 (5.19 - 3.17) A	4.30 (5.19 - 3.15) A	
<b>4,60</b> <b>A+++</b>	<b>4,40</b> <b>A++</b>	<b>4,20</b> <b>A+</b>	<b>4,30</b> <b>A+</b>	<b>4,80</b> <b>A+++</b>	—	—	<b>4,30</b> <b>A+</b>	<b>4,80</b> <b>A+++</b>	—	—	
3,6	5,0	6,0	7,1	10,0	—	—	7,1	10,0	—	—	
0.78 (0.19 - 1.08)	1.26 (0.19 - 1.62)	1.72 (0.20 - 2.05)	1.86 (0.40 - 285)	2.24 (0.79 - 4.40)	3.04 (0.79 - 5.04)	3.72 (0.79 - 5.72)	1.86 (0.50 - 2.85)	2.24 (0.79 - 4.40)	3.04 (0.79 - 5.04)	3.72 (0.79 - 5.72)	
1.095	1.591	1.999	2.312	2.917	—	—	2.312	2.917	—	—	
<b>S-36PU2E5A</b>	<b>S-50PU2E5A</b>	<b>S-60PU2E5A</b>	<b>S-71PU2E5A</b>	<b>S-100PU2E5A</b>	<b>S-125PU2E5A</b>	<b>S-140PU2E5A</b>	<b>S-71PU2E5A</b>	<b>S-100PU2E5A</b>	<b>S-125PU2E5A</b>	<b>S-140PU2E5A</b>	
14.5 / 13.0 / 11.5	16.5 / 13.5 / 11.5	21.0 / 16.0 / 13.0	22.0 / 16.0 / 13.0	36.0 / 26.0 / 18.0	37.0 / 27.0 / 19.0	38.0 / 29.0 / 20.0	22.0 / 16.0 / 13.0	36.0 / 26.0 / 18.0	37.0 / 27.0 / 19.0	38.0 / 29.0 / 20.0	
0.7	1.6	1.7	2.5	2.7	4.8	6.0	2.5	2.7	4.8	6.0	
30 / 28 / 27	32 / 29 / 27	36 / 31 / 28	37 / 31 / 28	45 / 38 / 32	46 / 39 / 33	47 / 40 / 34	37 / 31 / 28	45 / 38 / 32	46 / 39 / 33	47 / 40 / 34	
45 / 43 / 42	47 / 44 / 42	51 / 46 / 43	52 / 46 / 43	60 / 53 / 47	61 / 54 / 48	62 / 55 / 49	52 / 46 / 43	60 / 53 / 47	61 / 54 / 48	62 / 55 / 49	
256 x 840 x 840 / 19	256 x 840 x 840 / 19	256 x 840 x 840 / 20	256 x 840 x 840 / 20	319 x 840 x 840 / 25	319 x 840 x 840 / 25	319 x 840 x 840 / 25	256 x 840 x 840 / 20	319 x 840 x 840 / 25	319 x 840 x 840 / 25	319 x 840 x 840 / 25	
33.5 x 950 x 950 / 5	33.5 x 950 x 950 / 5	33.5 x 950 x 950 / 5	33.5 x 950 x 950 / 5	33.5 x 950 x 950 / 5	33.5 x 950 x 950 / 5	33.5 x 950 x 950 / 5	33.5 x 950 x 950 / 5	33.5 x 950 x 950 / 5	33.5 x 950 x 950 / 5	33.5 x 950 x 950 / 5	
<b>U-36PE2E5A</b>	<b>U-50PE2E5A</b>	<b>U-60PE2E5A</b>	<b>U-71PE1E5A</b>	<b>U-100PE1E5A</b>	<b>U-125PE1E5A</b>	<b>U-140PE1E5A</b>	<b>U-71PE1E8A</b>	<b>U-100PE1E8A</b>	<b>U-125PE1E8A</b>	<b>U-140PE1E8A</b>	
220 / 230 / 240	220 / 230 / 240	220 / 230 / 240	220 / 230 / 240	220 / 230 / 240	220 / 230 / 240	220 / 230 / 240	380 / 400 / 415	380 / 400 / 415	380 / 400 / 415	380 / 400 / 415	
—	—	—	20	25	30	16	16	16	16	16	
—	—	—	2.5	4.0	6.0	2.5	2.5	2.5	2.5	2.5	
3.75 / 3.55 / 3.40	6.25 / 5.95 / 5.70	7.90 / 7.50 / 7.25	8.40 / 8.10 / 7.90	10.7 / 10.3 / 9.90	15.8 / 15.3 / 14.8	19.6 / 19.0 / 18.4	2.80 / 2.70 / 2.60	3.70 / 3.50 / 3.40	5.45 / 5.15 / 5.00	6.75 / 6.45 / 6.20	
3.80 / 3.60 / 3.45	6.05 / 5.75 / 5.50	8.50 / 8.15 / 7.80	9.30 / 9.00 / 8.70	11.8 / 11.4 / 11.0	15.9 / 15.4 / 14.9	19.8 / 19.2 / 18.6	3.10 / 3.00 / 2.90	4.05 / 3.85 / 3.75	5.50 / 5.20 / 5.05	6.85 / 6.50 / 6.25	
38 / 38	38 / 41	38 / 41	60 / 60	110 / 95	130 / 110	135 / 120	60 / 60	110 / 95	130 / 110	135 / 120	
45 / 46	46 / 48	46 / 49	48 / 50	52 / 52	53 / 53	54 / 55	48 / 50	52 / 52	53 / 53	54 / 55	
64 / 66	65 / 68	65 / 69	65 / 67	69 / 69	70 / 70	71 / 71	65 / 67	69 / 69	70 / 70	71 / 71	
619 x 799 x 299	619 x 799 x 299	619 x 799 x 299	996 x 940 x 340	1.416 x 940 x 340	1.416 x 940 x 340	1.416 x 940 x 340	996 x 940 x 340	1.416 x 940 x 340	1.416 x 940 x 340	1.416 x 940 x 340	
39	39	40	69	98	98	98	71	98	98	98	
1/4 (6.35)	1/4 (6.35)	3/8 (9.52)	3/8 (9.52)	3/8 (9.52)	3/8 (9.52)	3/8 (9.52)	3/8 (9.52)	3/8 (9.52)	3/8 (9.52)	3/8 (9.52)	
1/2 (12.7)	1/2 (12.7)	5/8 (15.88)	5/8 (15.88)	5/8 (15.88)	5/8 (15.88)	5/8 (15.88)	5/8 (15.88)	5/8 (15.88)	5/8 (15.88)	5/8 (15.88)	
3 - 40 / 30	3 - 40 / 30	3 - 40 / 30	5 - 50 / 30	5 - 75 / 30	5 - 75 / 30	5 - 75 / 30	5 - 50 / 30	5 - 75 / 30	5 - 75 / 30	5 - 75 / 30	
30 / 20	30 / 20	30 / 40	30 / 50	30 / 50	30 / 50	30 / 50	30 / 50	30 / 50	30 / 50	30 / 50	
1.40 / 2.9232	1.40 / 2.9232	1.95 / 4.0716	2.35 / 4.9068	3.40 / 7.0992	3.40 / 7.0992	3.40 / 7.0992	2.35 / 4.9068	3.40 / 7.0992	3.40 / 7.0992	3.40 / 7.0992	
-15 ~ +46	-15 ~ +46	-15 ~ +46	-15 ~ +46	-15 ~ +46	-15 ~ +46	-15 ~ +46	-15 ~ +46	-15 ~ +46	-15 ~ +46	-15 ~ +46	
-20 ~ +24	-20 ~ +24	-20 ~ +24	-20 ~ +24	-20 ~ +24	-20 ~ +24	-20 ~ +24	-20 ~ +24	-20 ~ +24	-20 ~ +24	-20 ~ +24	

**Accessories**

- CZ-RTC4** Standard Wired remote control with Econavi
- CZ-RWSU3** Wireless remote control
- CZ-REZC2** Simplified remote control
- CZ-CNEXU1** Nanoe™ air purifying system for Cassette 90x90 PUZ
- CZ-KPU3A** Econavi exclusive panel
- PAW-WTRAY** Tray for condenser water compatible with base ground support
- PAW-GRDBSE20** Outdoor base ground support for noise and vibration absorption (600 x 95 x 130mm, 500kg)
- PAW-WPH7** Wind protection shield for U-50PE2E5A
- PAW-WPH9** Wind protection shield for U-60PE2E5A, U-71PE1E5A/8A, U-100PE1E5/8, U-125PE1E5/8
- PAW-WPH10** Wind protection shield for U-100PE1E5A/8A, U-125PE1E5A/8A, U-140PE1E5A/8A, U-140PE1E8



Rating Conditions: Cooling Indoor 27°C DB / 19°C WB. Cooling Outdoor 35°C DB / 24°C WB. Heating Indoor 20°C DB. Heating Outdoor 7°C DB / 6°C WB. (DB: Dry Bulb; WB: Wet Bulb)  
Specifications subject to change without notice. For detailed information about ErP, please visit our websites www.aircon.panasonic.eu or www.ptc.panasonic.eu.

# 4 WAY 60x60 CASSETTE PACi INVERTER+

Small and powerful, ideal for offices and restaurants. Standard units only for Twin, Triple and Double-twin combinations.

High heating capacity at -7°C.

Special designed flap.

The flap can be removed easily for washing with water.

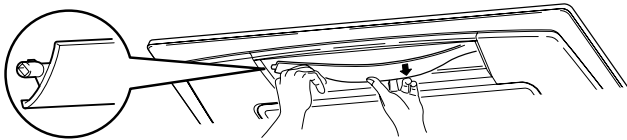

### Technical focus

- Fresh air knock out
- Multidirectional air flow
- Integrated drain pump gives 850mm lift
- 3 speed centrifugal fan
- DC FAN for better efficiency and control
- Easy connection and control of external fan or ERV using the connector PAW-FDC on the indoor unit PCB. The external device can be control by the remote control of the Panasonic indoor unit

### PACi STANDARD\*

			3,6kW	4,5kW	5,0kW
Cooling capacity		kW	3,6	4,5	5,0
Heating capacity		kW	4,2	5,2	5,6
<b>Indoor Unit</b>			<b>S-36PY2E5A</b>	<b>S-45PY2E5A</b>	<b>S-50PY2E5A</b>
Current	Cooling	A	0,30	0,32	0,35
	Heating	A	0,30	0,30	0,35
Input power	Cooling	kW	0,40	0,40	0,45
	Heating	kW	0,35	0,35	0,40
Air volume	Cooling / Heating	m <sup>3</sup> /min	10 / 10	10 / 10	11 / 11
Moisture removal volume		L/h	2,1	2,5	2,8
Sound pressure <sup>4)</sup>	Cooling (Hi / Med / Lo)	dB(A)	36 / 32 / 26	38 / 34 / 28	40 / 37 / 33
	Heating (Hi / Med / Lo)	dB(A)	36 / 32 / 26	38 / 34 / 28	40 / 37 / 33
Sound power level	Cooling (Hi)	dB	51 / 47 / 41	53 / 49 / 43	55 / 52 / 48
	Heating (Hi)	dB	51 / 47 / 41	53 / 49 / 43	55 / 52 / 48
Dimensions (H x W x D)	Indoor	mm	288 x 583 x 583	288 x 583 x 583	288 x 583 x 583
	Panel CZ-KPY3A	mm	31 x 700 x 700	31 x 700 x 700	31 x 700 x 700
	Panel CZ-KPY3B	mm	31 x 625 x 625	31 x 625 x 625	31 x 625 x 625
Net weight	Indoor	kg	18	18	18
	Panel	kg	2,4	2,4	2,4
Piping connections	Liquid pipe	Inch (mm)	1/4 (6,35)	1/4 (6,35)	1/4 (6,35)
	Gas pipe	Inch (mm)	1/2 (12,7)	1/2 (12,7)	1/2 (12,7)
Operating range	Cooling Min - Max	°C	+18 ~ +32	+18 ~ +32	+18 ~ +32
	Heating Min - Max	°C	+16 ~ +30	+16 ~ +30	+16 ~ +30

1) EER and COP, Energy Saving Classification, is at 220 / 240V (380 / 415V) only in accordance with EU directive 2002/31/EC. 2) SEER is calculated in base Eurovent IPLV for SBEM for U1 indoor unit SEER=a(EER25)+b(EER50)+c(EER75)+d(EER100) where EER25, EER50, EER75 and EER100 are the EER measured value at 25%, 50%, 75% and 100% part load for temperatures 20, 25, 30 and 35°C DB, respectively. a, b, c and d are values assigned for an office type. These values are given as a=0,2, b=0,36, c=0,32 and d=0,03. The internal temperatures are taken at 27°C DB and 19°C WB. 3) The annual consumption (ErP) is calculated by formula determined by ErP regulation. 4) Heating capacity is calculated including defrost factor correction. 5) SCOP is calculated in base Eurovent IPLV for SBEM with U1 indoor unit including defrost correction factor. 6) The Sound pressure of the units shows the value measured of a position 1 meter in front of the main body and 1,5 m from the ground. The sound pressure is measured in accordance with Eurovent 6/C/006-97 specification. 7) When installing the outdoor unit at a higher position than the indoor unit. // Recommended fuse for the indoor 3A. \* Only for multi combinations.

### ELITE



SEER and SCOP: For KIT-36PY2E5B. INTERNET CONTROL: Optional. Compatible with all Panasonic connectivity solutions. For detailed information go to the Control Systems section.



Included Controller:  
Wired remote controller  
CZ-RTCSA  
Compatible with Econavi



Optional Controller:  
Timer remote controller  
CZ-RTCA  
Compatible with Econavi



Optional Controller:  
Wireless remote controller  
CZ-RWSK2



Optional Controller:  
Simplified remote controller  
CZ-RE2C2



Panel  
CZ-KPY3A (size 700 x 700mm)  
CZ-KPY3B (size 625 x 625mm)



### A drain height of approximately 850mm from the ceiling surface

The drain height can be increased by approx. 350mm over the conventional value by using a high-lift drain pump, and long horizontal piping is possible.

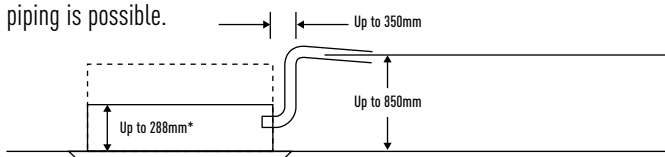

A lightweight unit at 18kg the unit is also very slim with a height of only 288mm, making installation possible even in narrow ceilings.

### Lighter and slimmer, easier installation

Lightweight and very slim which makes installation possible even in narrow ceilings.

Designed to fit exactly into a 600 x 600mm ceiling grid without the need to alter the bar configuration.

Significant reduction of power consumption by using highly developed DC fan motors with variable speed, special heat exchangers, etc.

### PACi ELITE

			3,6kW	5,0kW
			KIT-36PY2E5B	KIT-50PY2E5B
Panel			CZ-KPY3A	CZ-KPY3A
Timer remote controller			CZ-RTCSA	CZ-RTCSA
Cooling capacity	Nominal (Min - Max)	kW	3,6 (1,5 - 4,0)	5,0 (1,5 - 5,6)
EER <sup>1)</sup>	Nominal (Min - Max)	W/W	4,50 (6,25 - 421) A	3,47 (6,25 - 3,16) A
SEER <sup>2)</sup>		W/W	6,30 <b>A++</b>	6,10 <b>A++</b>
Pdesign		kW	3,6	5,0
Input power cooling	Nominal (Min - Max)	kW	0,80 (0,24 - 0,95)	1,44 (0,24 - 1,77)
Annual energy consumption (ErP) <sup>3)</sup>		kWh/a	200	287
Heating capacity	Nominal (Min - Max)	kW	4,0 (1,5 - 5,0)	5,6 (1,5 - 6,5)
Heating capacity at -7°C <sup>4)</sup>		kW		
Heating capacity at -15°C <sup>4)</sup>		kW		
COP <sup>1)</sup>	Nominal (Min - Max)	W/W	4,08 (7,89 - 3,68) A	3,31 (7,89 - 3,00) C
SCOP <sup>3)</sup>		W/W	4,10 <b>A+</b>	3,90 <b>A</b>
Pdesign at -10°C		kW	3,6	5,0
Input power heating	Nominal (Min - Max)	kW	0,98 (0,19 - 1,36)	1,69 (0,19 - 2,17)
Annual energy consumption (ErP) <sup>3)</sup>		kWh/a	1.229	1.795
Indoor Unit			S-36PY2E5A	S-50PY2E5A
Air volume	Cooling (Hi / Med / Lo)	m³/min	9,7 / 8,0 / 6,0	11,1 / 9,8 / 8,5
	Heating (Hi / Med / Lo)	m³/min	9,9 / 8,2 / 6,0	11,1 / 9,8 / 8,7
Moisture removal volume		L/h	2,1	2,8
Sound pressure <sup>4)</sup>	Hi / Me / Lo	dB(A)	36 / 32 / 26	40 / 37 / 33
Sound power level	Hi / Me / Lo	dB	51 / 47 / 41	55 / 52 / 48
Dimensions (H x W x D)	Indoor	mm	260 x 575 x 575	260 x 575 x 575
	Panel	mm	31 x 700 x 700	31 x 700 x 700
Net weight	Indoor (Panel)	kg	18 (2,4)	18 (2,4)
Outdoor Unit			U-36PE2E5A	U-50PE2E5A
Power source		V	220 / 230 / 240	220 / 230 / 240
Recommended fuse		A	—	—
Connection		mm²	—	—
Current	Cooling	A	3,80 / 3,60 / 3,50	6,70 / 6,50 / 6,20
	Heating	A	4,70 / 4,50 / 4,35	8,05 / 7,70 / 7,40
Air volume	Cooling / Heating	m³/min	38 / 38	38 / 41
Sound pressure	Cooling / Heating (Hi)	dB(A)	45 / 46	46 / 48
Sound power level	Cooling / Heating (Hi)	dB	64 / 66	65 / 68
Dimensions	H x W x D	mm	619 x 799 x 299	619 x 799 x 299
Net weight		kg	39	39
Piping connections	Liquid pipe	Inch (mm)	1/4 (6,35)	1/4 (6,35)
	Gas pipe	Inch (mm)	1/2 (12,7)	1/2 (12,7)
Piping length range / Elevation difference (in/out) <sup>7)</sup>		m	3 ~ 40 / 30	3 ~ 40 / 30
Pipe length for additional gas / Additional gas amount		m / g/m	30 / 20	30 / 20
Refrigerant (R410A)		kg / TCO <sub>2</sub> Eq.	1,40 / 2,9232	1,40 / 2,9232
Operating range	Cooling Min ~ Max	°C	-15 ~ +46	-15 ~ +46
	Heating Min ~ Max	°C	-20 ~ +24	-20 ~ +24

### Accessories

CZ-RTCA	Standard Wired remote control with Econavi
CZ-RWSK2	Wireless remote control
CZ-RE2C2	Simplified remote control
PAW-GRDSTD40	Outdoor elevation platform 400 x 900 x 400mm
PAW-WTRAY	Tray for condenser water compatible with base ground support
PAW-GRDBSE20	Outdoor base ground support for noise and vibration absorption (600 x 95 x 130mm, 500kg)
PAW-WPH7	Wind protection shield for U-50PE2E5A
PAW-WPH9	Wind protection shield for U-60PE2E5A, U-71PE1E5A/8A, U-100PE1E5/8, U-125PE1E5/8
PAW-WPH10	Wind protection shield for U-100PE1E5A/8A, U-125PE1E5A/8A, U-140PE1E5A/8A, U-140PE1E5/8



Rating Conditions: Cooling Indoor 27°C DB / 19°C WB, Cooling Outdoor 35°C DB / 24°C WB, Heating Indoor 20°C DB, Heating Outdoor 7°C DB / 6°C WB. (DB: Dry Bulb; WB: Wet Bulb)  
Specifications subject to change without notice. For detailed information about ErP, please visit our websites www.aircon.panasonic.eu or www.ptc.panasonic.eu.

# CEILING PACi INVERTER+

This range of ceiling mounted units feature a DC fan motor for increased efficiency and reduced operating sound levels.

All the units are the same height and depth for a uniform appearance in mixed installations. A knock out is provided to allow for supplementary fresh air for improved air quality.

### Technical focus

- Fresh air connection possible (Outside intake duct connection port of

100mm diameter is available on the unit)

- All units just 235mm high
- Twin rotary compressor dramatically reduces vibration and noise
- DC inverter control
- Large and wide air distribution
- Industry-leading low sound levels
- Twin, Triple and Double-twin split options
- Easy connection and control of external fan or ERV using the connector PAW-FDC on the indoor unit PCB. The external device can be control by the remote control of the Panasonic indoor unit

### High heating capacity at -7°C.

		PACi STANDARD						
		Single Phase				Three Phase		
		6,0kW	7,1kW	10,0kW	12,5kW	10,0kW	12,5kW	14,0kW
KIT		KIT-60PTY2E5B	KIT-71PTY2E5B	KIT-100PTY2E5A	KIT-125PTY2E5A	KIT-100PTY2E8A	KIT-125PTY2E8A	KIT-140PTY2E8A
Timer remote controller		CZ-RTC5A	CZ-RTC5A	CZ-RTC5A	CZ-RTC5A	CZ-RTC5A	CZ-RTC5A	CZ-RTC5A
Cooling capacity	Nominal (Min - Max)	kW 6,0 (2,0 - 7,1)	7,1 (2,0 - 7,7)	10,0 (2,7 - 11,5)	12,5 (3,8 - 13,5)	10,0 (2,7 - 11,5)	12,5 (3,8 - 13,5)	14,0 (3,3 - 15,0)
EER <sup>1)</sup>	Nominal (Min - Max)	W/W 3,68 (8,00 - 3,16) A	3,21 (8,00 - 2,91) A	3,01(5,09 - 2,65) B	3,01 (4,22 - 2,62) B	3,01 (5,09 - 2,65) B	3,01 (4,22 - 2,62) B	2,98 (3,93 - 2,63) C
SEER <sup>2)</sup>	W/W	6,70 <b>A++</b>	6,10 <b>A++</b>	6,10 <b>A++</b>	—	6,00 <b>A+</b>	—	—
Pdesign	kW	6,0	7,1	10,0	—	10,0	—	—
Input power cooling	Nominal (Min - Max)	kW 1,63 (0,25 - 2,25)	2,21 (0,25 - 2,65)	3,32 (0,53 - 4,34)	4,15 (0,90 - 5,16)	3,32 (0,53 - 4,34)	4,15 (0,90 - 5,16)	4,70 (0,84 - 5,70)
Annual energy consumption (ErP) <sup>3)</sup>	kWh/a	313	407	574	—	584	—	—
Heating capacity	Nominal (Min - Max)	kW 6,0 (1,8 - 7,0)	7,1 (1,8 - 8,1)	10,0 (2,1 - 13,8)	12,5 (3,4 - 15,0)	10,0 (2,1 - 13,8)	12,5 (3,4 - 15,0)	14,0 (4,1 - 16,0)
Heating capacity at -7/-15°C <sup>4)</sup>	kW	— / —	— / —	9,97 / 8,43	10,97 / 9,03	9,97 / 8,43	10,97 / 9,03	13,35 / 12,38
COP <sup>1)</sup>	Nominal (Min - Max)	W/W 4,35 (9,00 - 4,38) A	4,23 (9,00 - 3,77) A	3,85 (5,12 - 3,45) A	3,85 (4,66 - 3,41) A	3,85 (5,12 - 3,45) A	3,85 (4,66 - 3,41) A	3,88 (4,56 - 3,07) A
SCOP <sup>5)</sup>	W/W	4,00 <b>A+</b>	4,00 <b>A+</b>	3,90 <b>A</b>	3,40 <sup>4)</sup>	3,90 <b>A</b>	3,40 <sup>4)</sup>	3,52 <sup>4)</sup>
Pdesign at -10°C	kW	6,0	6,0	10,0	—	10,0	—	—
Input power heating	Nominal (Min - Max)	kW 1,38 (0,20 - 1,60)	1,68 (0,20 - 2,15)	2,60 (0,41 - 4,00)	3,25 (0,73 - 4,40)	2,60 (0,41 - 4,00)	3,25 (0,73 - 4,40)	3,61 (0,90 - 5,21)
Annual energy consumption (ErP) <sup>3)</sup>	kWh/a	2,100	2,100	3,590	—	3,590	—	—
<b>Indoor Unit</b>		<b>S-60PT2E5A</b>	<b>S-71PT2E5A</b>	<b>S-100PT2E5A</b>	<b>S-125PT2E5A</b>	<b>S-100PT2E5A</b>	<b>S-125PT2E5A</b>	<b>S-140PT2E5A</b>
Air volume	Hi / Med / Lo	m <sup>3</sup> /min 20,0 / 17,0 / 14,5	21,0 / 18,0 / 15,5	30,0 / 25,0 / 23,0	34,0 / 28,0 / 24,0	30,0 / 25,0 / 23,0	34,0 / 28,0 / 24,0	35,0 / 29,0 / 25,0
Moisture removal volume	L/h	3,4	4,2	6,0	7,9	6,0	7,9	9,0
Sound pressure <sup>6)</sup>	Hi / Med / Lo	dB(A) 38 / 34 / 30	39 / 35 / 31	42 / 37 / 35	46 / 40 / 36	42 / 37 / 35	46 / 40 / 36	47 / 41 / 37
Sound power	Hi / Med / Lo	dB 56 / 52 / 48	57 / 53 / 49	60 / 55 / 53	64 / 58 / 54	60 / 55 / 53	64 / 58 / 54	65 / 59 / 55
Dimensions	H x W x D	mm 235 x 1.275 x 690	235 x 1.275 x 690	235 x 1.590 x 690	235 x 1.590 x 690	235 x 1.590 x 690	235 x 1.590 x 690	235 x 1.590 x 690
Net weight	kg	33	33	40	40	40	40	40
<b>Outdoor Unit</b>		<b>U-60PEY2E5</b>	<b>U-71PEY2E5</b>	<b>U-100PEY1E5</b>	<b>U-125PEY1E5</b>	<b>U-100PEY1E8</b>	<b>U-125PEY1E8</b>	<b>U-140PEY1E8</b>
Power source	V	220 / 230 / 240	220 / 230 / 240	220 / 230 / 240	220 / 230 / 240	380 / 400 / 415	380 / 400 / 415	380 / 400 / 415
Recommended fuse	A	—	—	25	30	16	16	16
Connection	mm <sup>2</sup>	—	—	4	6	2,5	2,5	2,5
Current	Cooling	A 8,00 / 7,60 / 7,30	10,80 / 10,30 / 9,85	0,82 / 0,79 / 0,76	19,2 / 18,4 / 17,6	5,10 / 4,85 / 4,70	6,35 / 6,05 / 5,80	6,85 / 6,50 / 6,25
	Heating	A 6,70 / 6,45 / 6,15	8,20 / 7,85 / 7,50	0,81 / 0,78 / 0,75	15,4 / 14,8 / 14,2	4,15 / 3,95 / 3,80	5,15 / 4,90 / 4,70	5,65 / 5,35 / 5,20
Air volume	Cooling / Heating	m <sup>3</sup> /min 38 / 41	44 / 41	110 / 95	80 / 73	76 / 67	80 / 73	135 / 120
Sound pressure	Cooling / Heating (Hi)	dB(A) 46 / 48	49 / 49	52 / 52	56 / 56	54 / 54	56 / 56	54 / 53
Sound power	Cooling / Heating (Hi)	dB 65 / 68	69 / 69	69 / 69	73 / 73	70 / 70	73 / 73	71 / 70
Dimensions	H x W x D	mm 619 x 799 x 299	619 x 799 x 299	996 x 940 x 340	996 x 940 x 340	996 x 940 x 340	996 x 940 x 340	1.416 x 940 x 340
Net weight	kg	40	40	73	85	73	85	98
Piping connections	Liquid pipe	Inch (mm) 3/8 (9,52)	3/8 (9,52)	3/8 (9,52)	3/8 (9,52)	3/8 (9,52)	3/8 (9,52)	3/8 (9,52)
	Gas pipe	Inch (mm) 5/8 (15,88)	5/8 (15,88)	5/8 (15,88)	5/8 (15,88)	5/8 (15,88)	5/8 (15,88)	5/8 (15,88)
Piping length range / Elevation difference (in/out) <sup>7)</sup>	m	3 ~ 40 / 30	3 ~ 40 / 30	5 ~ 50 / 30	5 ~ 50 / 30	5 ~ 50 / 30	5 ~ 50 / 30	5 ~ 50 / 30
Pipe length for additional gas / Additional gas amount	m / g/m	30 / 40	30 / 40	30 / 50	30 / 50	30 / 50	30 / 50	30 / 50
Refrigerant (R410A)	kg / TCO <sub>2</sub> Eq.	1,95 / 4,0716	1,95 / 4,0716	2,60 / 5,4288	3,20 / 6,6816	2,60 / 5,4288	3,20 / 6,6816	3,40 / 7,0992
Operating range	Cooling Min ~ Max	°C -10 ~ +43	-10 ~ +43	-10 ~ +43	-10 ~ +43	-10 ~ +43	-10 ~ +43	-10 ~ +43
	Heating Min ~ Max	°C -15 ~ +24	-15 ~ +24	-15 ~ +24	-15 ~ +24	-15 ~ +24	-15 ~ +24	-15 ~ +24

1) EER and COP, Energy Saving Classification, is at 220 / 240V (380 / 415V) only in accordance with EU directive 2002/31/EC. 2) SEER is calculated in base Eurovent IPLV for SBEM for U1 indoor unit SEER=a(EER25)+b(EER50)+c(EER75)+d(EER100) where EER25, EER50, EER75 and EER100 are the EER measured value at 25%, 50%, 75% and 100% part load for temperatures 20, 25, 30 and 35°C DB, respectively. a, b, c and d are values assigned for an office type. These values are given as a=0,2, b=0,36, c=0,32 and d=0,03. The internal temperatures are taken at 27°C DB and 19°C WB. 3) The annual consumption(ErP) is calculated by formula determined by ErP regulation. 4) Heating capacity is calculated including defrost factor correction. 5) SCOP is calculated in base Eurovent IPLV for SBEM with U1 indoor unit including defrost correction factor. 6) The Sound pressure of the units shows the value measured of a position 1 meter in front of the main body and 1,5 m from the ground. The sound pressure is measured in accordance with Eurovent 6/C/006-97 specification. 7) When installing the outdoor unit at a higher position than the indoor unit. // Recommended fuse for the indoor 3A.

### STANDARD

### ELITE

<b>A++</b> 4,70 SEER	<b>A+</b> 4,00 SCOP	<b>-10°C</b> COOLING MODE	<b>-15°C</b> HEATING MODE	<b>A++</b> 4,80 SEER	<b>A+</b> 4,10 SCOP	<b>-15°C</b> COOLING MODE	<b>-20°C</b> HEATING MODE	<b>INVERTER+</b>	<b>R32 RENEWAL</b> R32 RENEWAL	<b>INTERNET CONTROL</b> INTERNET CONTROL	<b>CONNECTIVITY</b> CONNECTIVITY	<b>5 YEARS WARRANTY</b> 5 YEARS WARRANTY
-------------------------	------------------------	------------------------------	------------------------------	-------------------------	------------------------	------------------------------	------------------------------	------------------	-----------------------------------	---	-------------------------------------	---

SEER and SCOP: For KIT-60PTY2E5B.

SEER and SCOP: For KIT-60PT2E5B.

INTERNET CONTROL: Optional. Compatible with all Panasonic connectivity solutions. For detailed information go to the Control Systems section.





Included Controller: Wired remote controller CZ-RTCSA Compatible with Econavi  
 Optional Controller: Timer remote controller CZ-RTCA Compatible with Econavi  
 Optional Econavi Sensor: CZ-CENSC1  
 Optional Controller: Wireless remote controller CZ-RWST3N  
 Optional Controller: Simplified remote controller CZ-REZC2



**Further comfort improvement**

The wide air discharge opening expands the air flow to the left and the right. The unpleasant feeling caused when the air flow directly hits the human body is prevented by the "Draft prevention position", which changes the swing width, so that the degree of comfort is increased.

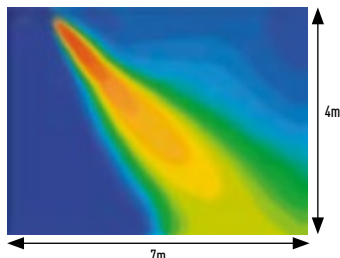

**Further comfort improvement with airflow distribution**

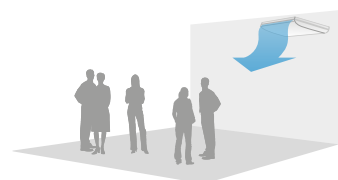

**Air distribution is altered depending on the operational mode of the unit**

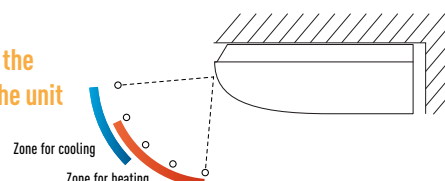

**PACi ELITE**

	Single Phase						Three Phase				
	3,6kW	5,0kW	6,0kW	7,1kW	10,0kW	12,5kW	14,0kW	7,1kW	10,0kW	12,5kW	14,0kW
	KIT-36PT2E5B	KIT-50PT2E5B	KIT-60PT2E5B	KIT-71PT2E5A	KIT-100PT2E5A	KIT-125PT2E5A	KIT-140PT2E5A	KIT-71PT2E8A	KIT-100PT2E8A	KIT-125PT2E8A	KIT-140PT2E8A
	CZ-RTCSA	CZ-RTCSA	CZ-RTCSA	CZ-RTCSA	CZ-RTCSA	CZ-RTCSA	CZ-RTCSA	CZ-RTCSA	CZ-RTCSA	CZ-RTCSA	CZ-RTCSA
	3,6 (1,5 - 4,0)	5,0 (1,5 - 5,6)	6,0 (2,0 - 7,1)	7,1 (2,5 - 8,0)	10,0 (3,3 - 12,5)	12,5 (3,3 - 14,0)	14,0 (3,3 - 15,0)	7,1 (2,5 - 8,0)	10,0 (3,3 - 12,5)	12,5 (3,3 - 14,0)	14,0 (3,3 - 15,0)
	4,80 (6,25 - 4,49) A	3,73 (6,25 - 3,41) A	3,73 (8,00 - 3,16) A	3,68 (5,56 - 2,88) A	3,95 (3,93 - 3,25) A	3,35 (3,93 - 2,88) A	3,01 (3,93 - 2,65) B	3,68 (5,56 - 2,88) A	3,95 (3,93 - 3,25) A	3,35 (3,93 - 2,88) A	3,01 (3,93 - 2,65) B
	<b>6,70</b> ◀A++	<b>6,50</b> ◀A++	<b>6,80</b> ◀A++	<b>6,20</b> ◀A++	<b>6,70</b> ◀A++	—	—	<b>5,90</b> ◀A+	<b>6,60</b> ◀A++	—	—
	3,6	5,0	6,0	7,1	10,0	—	—	7,1	10,0	—	—
	0,75 (0,24 - 0,89)	1,34 (0,24 - 1,64)	1,61 (0,25 - 2,25)	1,93 (0,45 - 2,78)	2,53 (0,84 - 3,85)	3,73 (0,84 - 4,86)	4,65 (0,84 - 5,65)	1,93 (0,45 - 2,78)	2,53 (0,84 - 3,85)	3,73 (0,84 - 4,86)	4,65 (0,84 - 5,65)
	188	269	309	965	523	—	—	421	531	—	—
	4,0 (1,5 - 5,0)	5,6 (1,5 - 6,5)	7,0 (1,8 - 8,0)	8,0 (2,0 - 9,0)	11,2 (4,1 - 14,0)	14,0 (4,1 - 16,0)	16,0 (4,1 - 18,0)	8,0 (2,0 - 9,0)	11,2 (4,1 - 14,0)	14,0 (4,1 - 16,0)	16,0 (4,1 - 18,0)
	— / —	— / —	— / —	7,52 / 7,65	12,04 / 11,20	13,48 / 12,38	14,24 / 12,69	7,52 / 7,65	12,04 / 11,20	13,48 / 12,38	14,24 / 12,69
	5,00 (7,89 - 4,50) A	4,18 (7,89 - 3,78) A	4,22 (9,00 - 4,10) A	4,15 (5,00 - 3,10) A	4,31 (4,56 - 3,18) A	3,99 (4,56 - 3,07) A	3,67 (4,56 - 3,04) A	4,15 (5,00 - 3,10) A	4,31 (4,56 - 3,18) A	3,99 (4,56 - 3,07) A	3,67 (4,56 - 3,04) A
	<b>4,30</b> ◀A+	<b>4,10</b> ◀A+	<b>4,10</b> ◀A+	<b>4,00</b> ◀A+	<b>4,30</b> ◀A+	<b>3,63</b> <sup>4)</sup>	<b>3,41</b> <sup>4)</sup>	<b>4,00</b> ◀A+	<b>4,30</b> ◀A+	<b>3,63</b> <sup>4)</sup>	<b>3,41</b> <sup>4)</sup>
	3,6	5,0	6,0	7,1	10,0	—	—	7,1	10,0	—	—
	0,80 (0,19 - 1,11)	1,34 (0,19 - 1,72)	1,66 (0,20 - 1,95)	1,93 (0,40 - 2,90)	2,60 (0,90 - 4,40)	3,51 (0,90 - 5,21)	4,36 (0,90 - 5,93)	1,93 (0,40 - 2,90)	2,60 (0,90 - 4,40)	3,51 (0,90 - 5,21)	4,36 (0,90 - 5,93)
	1,172	1,707	2,050	2,485	3,256	—	—	2,485	3,256	—	—
	<b>S-36PT2E5A</b>	<b>S-50PT2E5A</b>	<b>S-60PT2E5A</b>	<b>S-71PT2E5A</b>	<b>S-100PT2E5A</b>	<b>S-125PT2E5A</b>	<b>S-140PT2E5A</b>	<b>S-71PT2E5A</b>	<b>S-100PT2E5A</b>	<b>S-125PT2E5A</b>	<b>S-140PT2E5A</b>
	14,0 / 12,0 / 10,5	15,0 / 12,5 / 10,5	20,0 / 17,0 / 14,5	21,0 / 18,0 / 15,5	30,0 / 25,0 / 23,0	34,0 / 28,0 / 24,0	35,0 / 29,0 / 25,0	21,0 / 18,0 / 15,5	30,0 / 25,0 / 23,0	34,0 / 28,0 / 24,0	35,0 / 29,0 / 25,0
	2,1	2,8	3,4	4,2	6,0	7,9	9,0	4,2	6,0	7,9	9,0
	36 / 32 / 29	37 / 33 / 29	38 / 34 / 30	39 / 35 / 31	42 / 37 / 35	46 / 40 / 36	47 / 41 / 37	39 / 35 / 31	42 / 37 / 35	46 / 40 / 36	47 / 41 / 37
	54 / 50 / 47	55 / 51 / 47	56 / 52 / 48	57 / 53 / 49	60 / 55 / 53	64 / 58 / 54	65 / 59 / 55	57 / 53 / 49	60 / 55 / 53	64 / 58 / 54	65 / 59 / 55
	235 x 960 x 690	235 x 960 x 690	235 x 1.275 x 690	235 x 1.275 x 690	235 x 1.590 x 690	235 x 1.590 x 690	235 x 1.590 x 690	235 x 1.275 x 690	235 x 1.590 x 690	235 x 1.590 x 690	235 x 1.590 x 690
	27	27	33	33	40	40	33	40	40	40	40
	<b>U-36PE2E5A</b>	<b>U-50PE2E5A</b>	<b>U-60PE2E5A</b>	<b>U-71PE1E5A</b>	<b>U-100PE1E5A</b>	<b>U-125PE1E5A</b>	<b>U-140PE1E5A</b>	<b>U-71PE1E8A</b>	<b>U-100PE1E8A</b>	<b>U-125PE1E8A</b>	<b>U-140PE1E8A</b>
	220 / 230 / 240	220 / 230 / 240	220 / 230 / 240	220 / 230 / 240	220 / 230 / 240	220 / 230 / 240	220 / 230 / 240	380 / 400 / 415	380 / 400 / 415	380 / 400 / 415	380 / 400 / 415
	—	—	—	2,5	4,0	6,0	2,5	2,5	2,5	2,5	2,5
	3,75 / 3,55 / 3,40	6,25 / 5,95 / 5,70	7,90 / 7,50 / 7,25	9,00 / 8,70 / 8,40	11,5 / 11,1 / 10,6	17,0 / 16,4 / 15,8	21,2 / 20,5 / 19,8	3,00 / 2,90 / 2,80	3,95 / 3,75 / 3,65	5,85 / 5,55 / 5,35	7,30 / 6,95 / 6,70
	3,80 / 3,60 / 3,45	6,05 / 5,75 / 5,50	8,50 / 8,15 / 7,80	8,90 / 8,60 / 8,30	11,8 / 11,4 / 11,0	16,0 / 15,4 / 14,9	19,8 / 19,2 / 18,5	3,00 / 2,90 / 2,80	4,05 / 3,85 / 3,75	5,50 / 5,20 / 5,05	6,85 / 6,50 / 6,25
	38 / 38	38 / 41	38 / 41	60 / 60	110 / 95	130 / 110	135 / 120	60 / 60	110 / 95	130 / 110	135 / 120
	45 / 46	46 / 48	46 / 49	48 / 50	52 / 52	53 / 53	54 / 55	48 / 50	52 / 52	53 / 53	54 / 55
	64 / 66	65 / 68	65 / 69	65 / 67	69 / 69	70 / 70	71 / 71	65 / 67	69 / 69	70 / 70	71 / 71
	619 x 799 x 299	619 x 799 x 299	619 x 799 x 299	996 x 940 x 340	1.416 x 940 x 340	1.416 x 940 x 340	1.416 x 940 x 340	996 x 940 x 340	1.416 x 940 x 340	1.416 x 940 x 340	1.416 x 940 x 340
	39	39	40	69	98	98	98	71	98	98	98
	1/4 (6,35)	1/4 (6,35)	3/8 (9,52)	3/8 (9,52)	3/8 (9,52)	3/8 (9,52)	3/8 (9,52)	3/8 (9,52)	3/8 (9,52)	3/8 (9,52)	3/8 (9,52)
	1/2 (12,7)	1/2 (12,7)	5/8 (15,88)	5/8 (15,88)	5/8 (15,88)	5/8 (15,88)	5/8 (15,88)	5/8 (15,88)	5/8 (15,88)	5/8 (15,88)	5/8 (15,88)
	3 - 40 / 30	3 - 40 / 30	3 - 40 / 30	5 - 50 / 30	5 - 75 / 30	5 - 75 / 30	5 - 75 / 30	5 - 50 / 30	5 - 75 / 30	5 - 75 / 30	5 - 75 / 30
	30 / 20	30 / 20	30 / 40	30 / 50	30 / 50	30 / 50	30 / 50	30 / 50	30 / 50	30 / 50	30 / 50
	1,40 / 2,9232	1,40 / 2,9232	1,95 / 4,0716	2,35 / 4,9068	3,40 / 7,0992	3,40 / 7,0992	3,40 / 7,0992	2,35 / 4,9068	3,40 / 7,0992	3,40 / 7,0992	3,40 / 7,0992
	-15 - +46	-15 - +46	-15 - +46	-15 - +46	-15 - +46	-15 - +46	-15 - +46	-15 - +46	-15 - +46	-15 - +46	-15 - +46
	-20 - +24	-20 - +24	-20 - +24	-20 - +24	-20 - +24	-20 - +24	-20 - +24	-20 - +24	-20 - +24	-20 - +24	-20 - +24

**Accessories**

<b>CZ-RTC4</b>	Standard Wired remote control with Econavi
<b>CZ-RWST3N</b>	Wireless remote control
<b>CZ-REZC2</b>	Simplified remote control
<b>PAW-GRDSTD40</b>	Outdoor elevation platform 400 x 900 x 400mm
<b>PAW-WTRAY</b>	Tray for condenser water compatible with base ground support
<b>PAW-GRDBSE20</b>	Outdoor base ground support for noise and vibration absorption (600 x 95 x 130mm, 500kg)
<b>PAW-WPH7</b>	Wind protection shield for U-50PE2E5A
<b>PAW-WPH9</b>	Wind protection shield for U-60PE2E5A, U-71PE1E5A/8A, U-100PE1E5/8, U-125PE1E5/8
<b>PAW-WPH10</b>	Wind protection shield for U-100PE1E5A/8A, U-125PE1E5A/8A, U-140PE1E5A/8A, U-140PE1E8

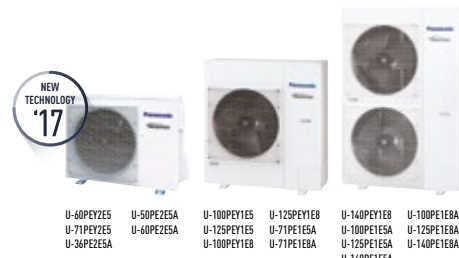

Rating Conditions: Cooling Indoor 27°C DB / 19°C WB. Cooling Outdoor 35°C DB / 24°C WB. Heating Indoor 20°C DB. Heating Outdoor 7°C DB / 6°C WB. (DB: Dry Bulb; WB: Wet Bulb)  
 Specifications subject to change without notice. For detailed information about ErP, please visit our websites www.aircon.panasonic.eu or www.ptc.panasonic.eu.

# HIGH STATIC PRESSURE HIDE AWAY PACi INVERTER+

The ducted systems are the ideal solution for flexible, concealed air conditioning and the optional 200mm spigots ensure simple, hassle-free connection to spiral ductwork.

High heating capacity at -7°C.

## Technical focus

- Extremely quiet operation from 26dB(A)
- Auto restart after power failure
- Auto changeover
- Twin, triple and double-twin split options
- DC FAN for better efficiency and control
- Built in drain pump
- Easy connection and control of external fan or ERV using the connector PAW-FDC on the indoor unit PCB. The external device can be control by the remote control of the Panasonic indoor unit

			PacI STANDARD							
			Single Phase				Three Phase			
			6,0kW	7,1kW	10,0kW	12,5kW	10,0kW	12,5kW	14,0kW	
KIT			KIT-60PFY1E5B	KIT-71PFY1E5B	KIT-100PFY1E5A	KIT-125PFY1E5A	KIT-100PFY1E8A	KIT-125PFY1E8A	KIT-140PFY1E8A	
Timer remote controller			CZ-RTC5A	CZ-RTC5A	CZ-RTC5A	CZ-RTC5A	CZ-RTC5A	CZ-RTC5A	CZ-RTC5A	
Cooling capacity	Nominal (Min - Max)	kW	6,0 (2,0 - 7,1)	7,1 (2,0 - 7,7)	10,0 (2,7 - 11,5)	12,5 (3,8 - 13,5)	10,0 (2,7 - 11,5)	12,5 (3,8 - 13,5)	14,0 (3,3 - 15,5)	
EER <sup>1)</sup>	Nominal (Min - Max)	W/W	3,35 (5,97 - 2,85) A	2,76 (5,97 - 2,48) D	3,01 (5,09 - 2,74) B	3,05 (4,22 - 2,70) B	3,01 (5,09 - 2,74) B	3,05 (4,22 - 2,70) B	3,22 (3,93 - 2,58) A	
SEER <sup>2)</sup>		W/W	5,50 <b>A+</b>	5,40 <b>A</b>	5,40 <b>A</b>	—	5,20 <b>A</b>	—	—	
Pdesign		kW	6,0	7,1	10,0	—	10,0	—	—	
Input power cooling	Nominal (Min - Max)	kW	1,79 (0,35 - 2,49)	2,57 (0,34 - 3,21)	3,32 (0,53 - 4,20)	4,10 (0,90 - 5,00)	3,32 (0,53 - 4,20)	4,10 (0,90 - 5,00)	4,35 (0,84 - 6,00)	
Annual energy consumption (ErP) <sup>3)</sup>		kWh/a	382	460	648	—	673	—	—	
Heating capacity	Nominal (Min - Max)	kW	6,0 (1,8 - 7,0)	7,1 (1,8 - 8,1)	10,0 (2,1 - 13,8)	12,5 (3,4 - 15,0)	10,0 (2,1 - 13,8)	12,5 (3,4 - 15,0)	14,0 (4,1 - 16,0)	
Heating capacity at -7/-15°C <sup>4)</sup>		kW	— / —	— / —	9,97 / 8,43	10,97 / 9,03	9,97 / 8,43	10,97 / 9,03	13,35 / 12,38	
COP <sup>1)</sup>	Nominal (Min - Max)	W/W	4,38 (6,32 - 4,12) A	4,10 (6,32 - 3,68) A	3,80 (5,12 - 3,45) A	3,82 (4,66 - 3,41) A	3,80 (5,12 - 3,45) A	3,82 (4,66 - 3,41) A	3,91 (4,56 - 3,08) A	
SCOP <sup>5)</sup>		W/W	4,00 <b>A+</b>	4,00 <b>A+</b>	3,80 <b>A</b>	—	3,80 <b>A</b>	—	—	
Pdesign at -10°C		kW	6,0	6,0	9,5	—	9,5	—	—	
Input power heating	Nominal (Min - Max)	kW	1,37 (0,29 - 1,70)	1,73 (0,29 - 2,20)	2,63 (0,41 - 4,00)	3,27 (0,73 - 4,40)	2,63 (0,41 - 4,00)	3,27 (0,73 - 4,40)	3,58 (0,90 - 5,20)	
Annual energy consumption (ErP) <sup>3)</sup>		kWh/a	2,100	2,100	3,500	—	3,500	—	—	
<b>Indoor Unit</b>			<b>S-60PF1E5A</b>	<b>S-71PF1E5A</b>	<b>S-100PF1E5A</b>	<b>S-125PF1E5A</b>	<b>S-100PF1E8A</b>	<b>S-125PF1E8A</b>	<b>S-140PF1E8A</b>	
External static pressure <sup>6)</sup>	Nominal (Min - Max)	Pa	70 (10 - 150)	70 (10 - 150)	100 (10 - 150)	100 (10 - 150)	100 (10 - 150)	100 (10 - 150)	100 (10 - 150)	
Air volume	Hi / Med / Lo	m³/min	21 / 19 / 15	21 / 19 / 15	32 / 26 / 21	34 / 29 / 23	32 / 26 / 21	34 / 29 / 23	36 / 32 / 25	
Moisture removal volume		L/h	3,4	4,2	6,0	7,9	6,0	7,9	9,0	
Sound pressure <sup>7)</sup>	Hi / Med / Lo	dB(A)	35 / 32 / 26	35 / 32 / 26	38 / 34 / 31	39 / 35 / 32	38 / 34 / 31	39 / 35 / 32	40 / 36 / 33	
Sound power	Hi / Med / Lo	dB	57 / 54 / 48	57 / 54 / 48	60 / 56 / 53	61 / 57 / 54	60 / 56 / 53	61 / 57 / 54	62 / 58 / 55	
Dimensions	H x W x D	mm	290 x 1.000 x 700	290 x 1.000 x 700	290 x 1.400 x 700	290 x 1.400 x 700	290 x 1.400 x 700	290 x 1.400 x 700	290 x 1.400 x 700	
Net weight		kg	33	33	45	45	45	45	45	
<b>Outdoor Unit</b>			<b>U-60PEY2E5</b>	<b>U-71PEY2E5</b>	<b>U-100PEY1E5</b>	<b>U-125PEY1E5</b>	<b>U-100PEY1E8</b>	<b>U-125PEY1E8</b>	<b>U-140PEY1E8</b>	
Power source		V	220 / 230 / 240	220 / 230 / 240	220 / 230 / 240	220 / 230 / 240	380 / 400 / 415	380 / 400 / 415	380 / 400 / 415	
Recommended fuse		A	—	—	25	30	16	16	16	
Connection		mm²	—	—	4	6	2,5	2,5	2,5	
Current	Cooling	A	8,00 / 7,60 / 7,30	10,70 / 10,30 / 9,85	0,82 / 0,79 / 0,76	19,2 / 18,4 / 17,6	5,10 / 4,85 / 4,70	6,35 / 6,05 / 5,80	6,85 / 6,50 / 6,25	
	Heating	A	7,05 / 6,75 / 6,45	8,50 / 8,10 / 7,80	0,81 / 0,78 / 0,75	15,4 / 14,8 / 14,2	4,15 / 3,95 / 3,80	5,15 / 4,90 / 4,70	5,65 / 5,35 / 5,20	
Air volume	Cooling / Heating	m³/min	38 / 41	44 / 41	110 / 95	80 / 73	76 / 67	80 / 73	135 / 120	
Sound pressure	Cooling / Heating (Hi)	dB(A)	46 / 48	49 / 49	52 / 52	56 / 56	54 / 54	56 / 56	54 / 53	
Sound power	Cooling / Heating (Hi)	dB	65 / 68	69 / 69	69 / 69	73 / 73	70 / 70	73 / 73	71 / 70	
Dimensions	H x W x D	mm	619 x 799 x 299	619 x 799 x 299	996 x 940 x 340	996 x 940 x 340	996 x 940 x 340	996 x 940 x 340	1.416 x 940 x 340	
Net weight		kg	40	40	73	85	73	85	98	
Piping connections	Liquid pipe	Inch (mm)	3/8 (9,52)	3/8 (9,52)	3/8 (9,52)	3/8 (9,52)	3/8 (9,52)	3/8 (9,52)	3/8 (9,52)	
	Gas pipe	Inch (mm)	5/8 (15,88)	5/8 (15,88)	5/8 (15,88)	5/8 (15,88)	5/8 (15,88)	5/8 (15,88)	5/8 (15,88)	
Piping length range / Elevation difference (in/out) <sup>7)</sup>		m	3 ~ 40 / 30	3 ~ 40 / 30	5 ~ 50 / 30	5 ~ 50 / 30	5 ~ 50 / 30	5 ~ 50 / 30	5 ~ 50 / 30	
Pipe length for additional gas / Additional gas amount		m / g/m	30 / 40	30 / 40	30 / 50	30 / 50	30 / 50	30 / 50	30 / 50	
Refrigerant (R410A)		kg / TCO <sub>2</sub> Eq.	1,95 / 4,0716	1,95 / 4,0716	2,60 / 5,4288	3,20 / 6,6816	2,60 / 5,4288	3,20 / 6,6816	3,40 / 7,0992	
Operating range	Cooling Min - Max	°C	-10 ~ +43	-10 ~ +43	-10 ~ +43	-10 ~ +43	-10 ~ +43	-10 ~ +43	-10 ~ +43	
	Heating Min - Max	°C	-15 ~ +24	-15 ~ +24	-15 ~ +24	-15 ~ +24	-15 ~ +24	-15 ~ +24	-15 ~ +24	

1) EER and COP, Energy Saving Classification, is at 220 / 240V (380 / 415V) only in accordance with EU directive 2002/31/EC. 2) SEER is calculated in base Eurovent IPLV for SBEM for U1 indoor unit SEER=a(EER25)+b(EER50)+c(EER75)+d(EER100) where EER25, EER50, EER75 and EER100 are the EER measured value at 25%, 50%, 75% and 100% part load for temperatures 20, 25, 30 and 35°C DB, respectively. a, b, c and d are values assigned for an office type. These values are given as a=0,2, b=0,36, c=0,32 and d=0,03. The internal temperatures are taken at 27°C DB and 19°C WB. 3) The annual consumption(ErP) is calculated by formula determined by ErP regulation. 4) Heating capacity is calculated including defrost factor correction. 5) SCOP is calculated in base Eurovent IPLV for SBEM with U1 indoor unit including defrost correction factor. 6) Medium External static pressure setting from factory. 7) The Sound pressure of the units shows the value measured of a position 1 meter in front of the main body and 1,5 m from the ground. The sound pressure is measured in accordance with Eurovent 6/C/006-97 specification. 8) When installing the outdoor unit at a higher position than the indoor unit. // Recommended fuse for the indoor 3A.

## STANDARD

## ELITE

<b>A+</b> 5,50 SEER 4,00 SCOP	<b>-10°C</b> COOLING MODE	<b>-15°C</b> HEATING MODE	<b>A++</b> 4,40 SEER 4,00 SCOP	<b>A+</b> 4,00 SEER 4,00 SCOP	<b>-15°C</b> COOLING MODE	<b>-20°C</b> HEATING MODE	<b>INVERTER+</b>	<b>DC FAN</b>	<b>R22 RENEWAL</b>	<b>INTERNET CONTROL</b>	<b>BMS CONNECTIVITY</b>	<b>5 YEARS WARRANTY</b>
-------------------------------------	------------------------------	------------------------------	--------------------------------------	-------------------------------------	------------------------------	------------------------------	------------------	---------------	--------------------	-------------------------	-------------------------	-------------------------

SEER and SCOP: For KIT-60PFY1E5B.

SEER and SCOP: For KIT-71PFY1E5A.

INTERNET CONTROL: Optional. Compatible with all Panasonic connectivity solutions. For detailed information go to the Control Systems section.



Included Controller:  
Wired remote controller  
CZ-RTC5A  
Compatible with Econavi



Optional Controller:  
Timer remote controller  
CZ-RTC4  
Compatible with Econavi



Optional Econavi Sensor:  
CZ-CENSC1



Optional Controller:  
Wireless remote controller  
CZ-RWSK2 + CZ-RWSC3



Optional Controller:  
Simplified remote controller  
CZ-RE2C2



**Air Outlet Plenum (without regulation adaptor)**

	Diameters	Model
36, 45 & 50	2 x Ø 200	CZ-56DAF2
60 & 71	3 x Ø 200	CZ-90DAF2
100, 125 & 140	4 x Ø 200	CZ-160DAF2

**Air Inlet Plenum**

	Diameters	Model
60 & 71	2 x Ø 250	CZ-DUMPA90MF2
100, 125 & 140	4 x Ø 200	CZ-DUMPA160MF2

Standardized height of 290mm for all models.

Height standardization enables easy and uniform installation for models with different capacities.

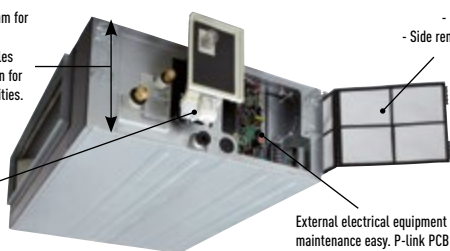

Built-in Drain pump (DC motor pump)

External electrical equipment box makes maintenance easy. P-link PCB

The static pressure outside the unit can be increased up to 150 Pa

Type		36	45	50	60	71	100	125	140
Standard	Pa	70	70	70	70	70	100	100	100
Maximum available setting	Pa	150	150	150	150	150	150	150	150

More powerful drain pump

Using a high-lift drain pump, drain piping can be elevated up to 785mm from the base of the unit.

**PACi ELITE**

	Single Phase						Three Phase				
	3,6kW	5,0kW	6,0kW	7,1kW	10,0kW	12,5kW	14,0kW	7,1kW	10,0kW	12,5kW	14,0kW
<b>KIT-36PF1E5B</b>	<b>KIT-50PF1E5B</b>	<b>KIT-60PF1E5B</b>	<b>KIT-71PF1E5A</b>	<b>KIT-100PF1E5A</b>	<b>KIT-125PF1E5A</b>	<b>KIT-140PF1E5A</b>	<b>KIT-71PF1E8A</b>	<b>KIT-100PF1E8A</b>	<b>KIT-125PF1E8A</b>	<b>KIT-140PF1E8A</b>	
<b>CZ-RTC5A</b>	<b>CZ-RTC5A</b>	<b>CZ-RTC5A</b>	<b>CZ-RTC5A</b>	<b>CZ-RTC5A</b>	<b>CZ-RTC5A</b>	<b>CZ-RTC5A</b>	<b>CZ-RTC5A</b>	<b>CZ-RTC5A</b>	<b>CZ-RTC5A</b>	<b>CZ-RTC5A</b>	
3,6 (1,5 - 4,0)	5,0 (1,5 - 5,6)	6,0 (2,0 - 7,1)	7,1 (2,5 - 8,0)	10,0 (3,3 - 12,5)	12,5 (3,3 - 14,0)	14,0 (3,3 - 15,5)	7,1 (3,2 - 8,0)	10,0 (3,3 - 12,5)	12,5 (3,3 - 14,0)	14,0 (3,3 - 15,5)	
4,44 (5,17 - 4,00) A	3,85 (5,17 - 3,50) A	3,64 (5,97 - 3,02) A	3,84 (4,72 - 3,02) A	4,10 (3,93 - 3,38) A	3,50 (3,93 - 3,04) A	3,25 (3,93 - 2,58) A	3,84 (5,0 - 3,02) A	4,10 (3,93 - 3,38) A	3,50 (3,93 - 3,04) A	3,25 (3,93 - 2,58) A	
<b>5,70 A+</b>	<b>5,70 A+</b>	<b>6,10 A++</b>	<b>6,40 A++</b>	<b>5,80 A+</b>	—	—	<b>6,00 A+</b>	<b>5,70 A+</b>	—	—	
3,6	5,0	6,0	7,1	10,0	—	—	7,1	10,0	—	—	
0,81 (0,29 - 1,00)	1,30 (0,29 - 1,60)	1,65 (0,34 - 2,35)	1,85 (0,53 - 2,65)	2,44 (0,84 - 3,70)	3,57 (0,84 - 4,60)	4,31 (0,84 - 6,00)	1,85 (0,64 - 2,65)	2,44 (0,84 - 3,70)	3,57 (0,84 - 4,60)	4,31 (0,84 - 6,00)	
221	307	344	388	603	—	—	414	614	—	—	
4,0 (1,5 - 5,0)	5,6 (1,5 - 6,5)	7,0 (1,8 - 8,0)	8,0 (2,0 - 9,0)	11,2 (4,1 - 14,0)	14,0 (4,1 - 16,0)	16,0 (4,1 - 18,0)	8,0 (2,8 - 9,0)	11,2 (4,1 - 14,0)	14,0 (4,1 - 16,0)	16,0 (4,1 - 18,0)	
— / —	— / —	— / —	7,52 / 7,65	12,04 / 11,20	13,48 / 12,38	14,24 / 12,69	7,52 / 7,65	12,04 / 11,20	13,48 / 12,38	14,24 / 12,69	
4,55 (6,25 - 4,17) A	4,03 (6,25 - 3,71) A	4,00 (6,32 - 3,81) A	3,85 (4,17 - 3,10) A	4,31 (4,56 - 3,18) A	4,02 (4,56 - 3,08) A	3,60 (4,56 - 3,05) A	3,85 (4,83 - 3,10) A	4,31 (4,56 - 3,18) A	4,02 (4,56 - 3,08) A	3,60 (4,56 - 3,05) A	
<b>3,90 A</b>	<b>3,90 A</b>	<b>4,00 A+</b>	<b>4,00 A+</b>	<b>3,80 A</b>	—	—	<b>3,90 A</b>	<b>3,80 A</b>	—	—	
3,6	4,0	6,0	7,1	10,0	—	—	7,1	10,0	—	—	
0,88 (0,24 - 1,20)	1,39 (0,24 - 1,75)	1,75 (0,29 - 2,10)	2,08 (0,48 - 2,90)	2,60 (0,90 - 4,40)	3,48 (0,90 - 5,20)	4,44 (0,90 - 5,90)	2,08 (0,58 - 2,90)	2,60 (0,90 - 4,40)	3,48 (0,90 - 5,20)	4,44 (0,90 - 5,90)	
1,292	1,436	2,100	2,485	3,684	—	—	2,548	3,684	—	—	
<b>S-36PF1E5A</b>	<b>S-50PF1E5A</b>	<b>S-60PF1E5A</b>	<b>S-71PF1E5A</b>	<b>S-100PF1E5A</b>	<b>S-125PF1E5A</b>	<b>S-140PF1E5A</b>	<b>S-71PF1E8A</b>	<b>S-100PF1E8A</b>	<b>S-125PF1E8A</b>	<b>S-140PF1E8A</b>	
70 (10 - 150)	70 (10 - 150)	70 (10 - 150)	70 (10 - 150)	100 (10 - 150)	100 (10 - 150)	100 (10 - 150)	70 (10 - 150)	100 (10 - 150)	100 (10 - 150)	100 (10 - 150)	
14 / 13 / 10	16 / 15 / 12	21 / 19 / 15	21 / 19 / 15	32 / 26 / 21	34 / 29 / 23	36 / 32 / 25	21 / 19 / 15	32 / 26 / 21	34 / 29 / 23	36 / 32 / 25	
2,1	2,8	3,4	4,2	6,0	7,9	9,0	4,2	6,0	7,9	9,0	
33 / 29 / 25	34 / 30 / 26	35 / 32 / 26	35 / 32 / 26	38 / 34 / 31	39 / 35 / 32	40 / 36 / 33	35 / 32 / 26	38 / 34 / 31	39 / 35 / 32	40 / 36 / 33	
55 / 51 / 47	56 / 52 / 48	57 / 54 / 48	57 / 54 / 48	60 / 56 / 53	61 / 57 / 54	62 / 58 / 55	57 / 54 / 48	60 / 56 / 53	61 / 57 / 54	62 / 58 / 55	
290 x 800 x 700	290 x 800 x 700	290 x 1.000 x 700	290 x 1.000 x 700	290 x 1.400 x 700	290 x 1.400 x 700	290 x 1.400 x 700	290 x 1.000 x 700	290 x 1.400 x 700	290 x 1.400 x 700	290 x 1.400 x 700	
28	28	33	33	45	45	45	33	45	45	45	
<b>U-36PE2E5A</b>	<b>U-50PE2E5A</b>	<b>U-60PE2E5A</b>	<b>U-71PE1E5A</b>	<b>U-100PE1E5A</b>	<b>U-125PE1E5A</b>	<b>U-140PE1E5A</b>	<b>U-71PE1E8A</b>	<b>U-100PE1E8A</b>	<b>U-125PE1E8A</b>	<b>U-140PE1E8A</b>	
220 / 230 / 240	220 / 230 / 240	220 / 230 / 240	220 / 230 / 240	220 / 230 / 240	220 / 230 / 240	220 / 230 / 240	380 / 400 / 415	380 / 400 / 415	380 / 400 / 415	380 / 400 / 415	
—	—	—	20	25	30	16	16	16	16	16	
—	—	—	2,5	4,0	6,0	2,5	2,5	2,5	2,5	2,5	
3,75 / 3,55 / 3,40	6,25 / 5,95 / 5,70	7,90 / 7,50 / 7,25	9,00 / 8,70 / 8,40	11,5 / 11,1 / 10,6	17,0 / 16,4 / 15,8	21,2 / 20,5 / 19,8	3,00 / 2,90 / 2,80	3,95 / 3,75 / 3,65	5,85 / 5,55 / 5,35	7,30 / 6,95 / 6,70	
3,80 / 3,60 / 3,45	6,05 / 5,75 / 5,50	8,50 / 8,15 / 7,80	8,90 / 8,60 / 8,30	11,8 / 11,4 / 11,0	16,0 / 15,4 / 14,9	19,8 / 19,2 / 18,5	3,00 / 2,90 / 2,80	4,05 / 3,85 / 3,75	5,50 / 5,20 / 5,05	6,85 / 6,50 / 6,25	
38 / 38	38 / 41	38 / 41	60 / 60	110 / 95	130 / 110	135 / 120	60 / 60	110 / 95	130 / 110	135 / 120	
45 / 46	46 / 48	46 / 49	48 / 50	52 / 52	53 / 53	54 / 55	48 / 50	52 / 52	53 / 53	54 / 55	
64 / 66	65 / 68	65 / 69	65 / 67	69 / 69	70 / 70	71 / 71	65 / 67	69 / 69	70 / 70	71 / 71	
619 x 799 x 299	619 x 799 x 299	619 x 799 x 299	996 x 940 x 340	1.416 x 940 x 340	1.416 x 940 x 340	1.416 x 940 x 340	996 x 940 x 340	1.416 x 940 x 340	1.416 x 940 x 340	1.416 x 940 x 340	
39	39	40	69	98	98	98	71	98	98	98	
1/4 (6,35)	1/4 (6,35)	3/8 (9,52)	3/8 (9,52)	3/8 (9,52)	3/8 (9,52)	3/8 (9,52)	3/8 (9,52)	3/8 (9,52)	3/8 (9,52)	3/8 (9,52)	
1/2 (12,7)	1/2 (12,7)	5/8 (15,88)	5/8 (15,88)	5/8 (15,88)	5/8 (15,88)	5/8 (15,88)	5/8 (15,88)	5/8 (15,88)	5/8 (15,88)	5/8 (15,88)	
3 - 40 / 30	3 - 40 / 30	3 - 40 / 30	5 - 50 / 30	5 - 75 / 30	5 - 75 / 30	5 - 75 / 30	5 - 50 / 30	5 - 75 / 30	5 - 75 / 30	5 - 75 / 30	
30 / 20	30 / 20	30 / 40	30 / 50	30 / 50	30 / 50	30 / 50	30 / 50	30 / 50	30 / 50	30 / 50	
1,40 / 2,9232	1,40 / 2,9232	1,95 / 4,0716	2,35 / 4,9068	3,40 / 7,0992	3,40 / 7,0992	3,40 / 7,0992	2,35 / 4,9068	3,40 / 7,0992	3,40 / 7,0992	3,40 / 7,0992	
-15 ~ +46	-15 ~ +46	-15 ~ +46	-15 ~ +46	-15 ~ +46	-15 ~ +46	-15 ~ +46	-15 ~ +46	-15 ~ +46	-15 ~ +46	-15 ~ +46	
-20 ~ +24	-20 ~ +24	-20 ~ +24	-20 ~ +24	-20 ~ +24	-20 ~ +24	-20 ~ +24	-20 ~ +24	-20 ~ +24	-20 ~ +24	-20 ~ +24	

**Accessories**

<b>CZ-RTC4</b>	Standard Wired remote control with Econavi
<b>CZ-RWSK2 + CZ-RWSC3</b>	Wireless remote control
<b>CZ-RE2C2</b>	Simplified remote control
<b>PAW-GRDSTD40</b>	Outdoor elevation platform 400 x 900 x 400mm
<b>PAW-WTRAY</b>	Tray for condenser water compatible with base ground support
<b>PAW-GRDBSE20</b>	Outdoor base ground support for noise and vibration absorption (600 x 95 x 130mm, 500kg)
<b>CZ-56DAF2</b>	Air Outlet Plenum S...PF1E5A 36, 45 & 50
<b>CZ-90DAF2</b>	Air Outlet Plenum S...PF1E5A 60 & 71
<b>CZ-160DAF2</b>	Air Outlet Plenum S...PF1E5A 100, 125 & 140
<b>CZ-DUMPA90MF2</b>	Air Inlet Plenum S...PF1E5A 60 & 71
<b>CZ-DUMPA160MF2</b>	Air Inlet Plenum S...PF1E5A 100, 125 & 140

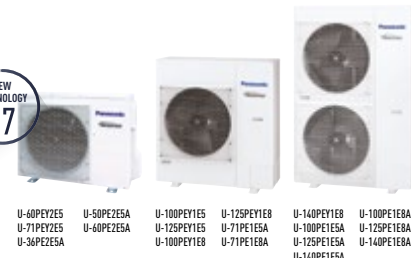

U-60PE2E5 U-71PE2E5 U-36PE2E5A U-100PE1E5 U-125PE1E5 U-100PE1E8 U-71PE1E8A U-140PE1E8 U-100PE1E8A U-125PE1E8A U-140PE1E8A U-100PE1E8A

Rating Conditions: Cooling Indoor 27°C DB / 19°C WB. Cooling Outdoor 35°C DB / 24°C WB. Heating Indoor 20°C DB. Heating Outdoor 7°C DB / 6°C WB. (DB: Dry Bulb; WB: Wet Bulb) Specifications subject to change without notice. For detailed information about ErP, please visit our websites www.aircon.panasonic.eu or www.ptc.panasonic.eu.

# LOW STATIC PRESSURE HIDE AWAY PACi INVERTER+

The depth of only 250mm provides greater installation flexibility and the unit can be used in more applications. Ideal for sites with narrow ceiling voids.

High heating capacity at -7°C.

Ultra-slim profile: 250mm height for all models.

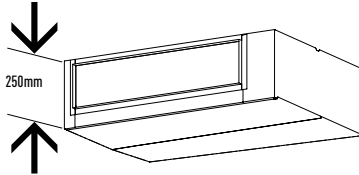

### Technical focus

- Compact indoor units without losing static pressure (Only 250mm high)
- 50 Pa static pressure
- Easy maintenance and service via external electrical box
- 3 speed centrifugal fan through wired or wireless remote control
- DC FAN for better efficiency and control
- Easy connection and control of external fan or ERV using the connector PAW-FDC on the indoor unit PCB. The external device can be control by the remote control of the Panasonic indoor unit

		PACi STANDARD							
		Single Phase				Three Phase			
		6,0kW	7,1kW	10,0kW	12,5kW	10,0kW	12,5kW	14,0kW	
KIT		KIT-60PNY1E5B	KIT-71PNY1E5B	KIT-100PNY1E5A	KIT-125PNY1E5A	KIT-100PNY1E8A	KIT-125PNY1E8A	KIT-140PNY1E8A	
Timer remote controller		CZ-RTC5A	CZ-RTC5A	CZ-RTC5A	CZ-RTC5A	CZ-RTC5A	CZ-RTC5A	CZ-RTC5A	
Cooling capacity	Nominal (Min - Max)	kW	6,0 (2,0 - 7,1)	7,1 (2,0 - 7,7)	10,0 (2,7 - 11,5)	12,5 (3,8 - 13,5)	10,0 (2,7 - 11,5)	12,5 (3,8 - 13,5)	14,0 (3,3 - 15,5)
EER <sup>1)</sup>	Nominal (Min - Max)	W/W	3,21 (5,00 - 2,78) A	2,76 (5,00 - 2,48) D	2,81 (4,74 - 2,67) C	2,81 (4,00 - 2,60) C	2,81 (4,74 - 2,67) C	2,81 (4,00 - 2,60) C	2,98 (3,93 - 2,58) C
SEER <sup>2)</sup>		W/W	<b>4,80</b> <b>B</b>	<b>5,10</b> <b>A</b>	<b>5,30</b> <b>A</b>	—	<b>5,20</b> <b>A</b>	—	
Pdesign		kW	6,0	7,1	10,0	—	10,0	—	
Input power cooling	Nominal (Min - Max)	kW	1,87 (0,40 - 2,55)	2,57 (0,40 - 3,10)	3,56 (0,57 - 4,30)	4,45 (0,95 - 5,20)	3,56 (0,57 - 4,30)	4,45 (0,95 - 5,20)	4,70 (0,84 - 6,00)
Annual energy consumption (ErP) <sup>3)</sup>		kWh/a	437	487	660	—	673	—	
Heating capacity	Nominal (Min - Max)	kW	6,0 (1,8 - 7,0)	7,1 (1,8 - 8,1)	10,0 (2,1 - 13,8)	12,5 (3,4 - 15,0)	10,0 (2,1 - 13,8)	12,5 (3,4 - 15,0)	14,0 (4,1 - 16,0)
Heating capacity at -7/-15°C <sup>4)</sup>		kW	— / —	— / —	9,97	10,97	9,97	10,97	13,35
COP <sup>5)</sup>	Nominal (Min - Max)	W/W	3,73 (5,14 - 3,78) A	3,70 (5,14 - 3,31) A	3,41 (4,67 - 3,37) B	3,41 (4,36 - 3,26) B	3,41 (4,67 - 3,37) B	3,41 (4,36 - 3,26) B	3,52 (4,56 - 3,08) B
SCOP <sup>5)</sup>		W/W	<b>3,80</b> <b>A</b>	<b>3,80</b> <b>A</b>	<b>3,80</b> <b>A</b>	—	<b>3,80</b> <b>A</b>	—	
Pdesign at -10°C		kW	5,6	5,6	7,6	—	7,6	—	
Input power heating	Nominal (Min - Max)	kW	1,61 (0,35 - 1,85)	1,92 (0,35 - 2,45)	2,94 (0,45 - 4,10)	3,67 (0,78 - 4,60)	2,94 (0,45 - 4,10)	3,67 (0,78 - 4,60)	3,88 (1,05 - 5,40)
Annual energy consumption (ErP) <sup>3)</sup>		kWh/a	2,061	2,061	2,800	—	2,800	—	
<b>Indoor Unit</b>			<b>S-60PN1E5A</b>	<b>S-71PN1E5A</b>	<b>S-100PN1E5A</b>	<b>S-125PN1E5A</b>	<b>S-100PN1E8A</b>	<b>S-125PN1E8A</b>	<b>S-140PN1E8A</b>
External static pressure <sup>6)</sup>	Nominal (Min - Max)	Pa	50 (10 - 80)	50 (10 - 80)	50 (10 - 80)	50 (10 - 80)	50 (10 - 80)	50 (10 - 80)	50 (10 - 80)
Air volume	Hi / Med / Lo	m³/min	22 / 20 / 16	22 / 20 / 16	36 / 33 / 26	38 / 35 / 28	36 / 33 / 26	38 / 35 / 28	40 / 37 / 30
Moisture removal volume		L/h	3,4	4,2	6,0	7,9	6,0	7,9	9,0
Sound pressure <sup>7)</sup>	Hi / Med / Lo	dB(A)	43 / 41 / 36	43 / 41 / 36	44 / 42 / 37	45 / 43 / 38	44 / 42 / 37	45 / 43 / 38	46 / 44 / 39
Sound power	Hi / Med / Lo	dB	60 / 58 / 53	60 / 58 / 53	65 / 63 / 58	66 / 64 / 59	65 / 63 / 58	66 / 64 / 59	67 / 65 / 60
Dimensions <sup>8)</sup>	H x W x D	mm	250 x 1.000 x 650	250 x 1.000 x 650	250 x 1.200 x 650	250 x 1.200 x 650	250 x 1.200 x 650	250 x 1.200 x 650	250 x 1.200 x 650
Net weight		kg	32	32	41	41	41	41	41
<b>Outdoor Unit</b>			<b>U-60PEY2E5</b>	<b>U-71PEY2E5</b>	<b>U-100PEY1E5</b>	<b>U-125PEY1E5</b>	<b>U-100PEY1E8</b>	<b>U-125PEY1E8</b>	<b>U-140PEY1E8</b>
Power source		V	220 / 230 / 240	220 / 230 / 240	220 / 230 / 240	220 / 230 / 240	380 / 400 / 415	380 / 400 / 415	380 / 400 / 415
Recommended fuse		A	—	—	25	30	16	16	16
Connection		mm²	—	—	4	6	2,5	2,5	2,5
Current	Cooling	A	8,00 / 7,60 / 7,30	10,70 / 10,30 / 9,85	0,82 / 0,79 / 0,76	19,2 / 18,4 / 17,6	5,10 / 4,85 / 4,70	6,35 / 6,05 / 5,80	6,85 / 6,50 / 6,25
	Heating	A	7,05 / 6,75 / 6,45	8,50 / 8,10 / 7,80	0,81 / 0,78 / 0,75	15,4 / 14,8 / 14,2	4,15 / 3,95 / 3,80	5,15 / 4,90 / 4,70	5,65 / 5,35 / 5,20
Air volume	Cooling / Heating	m³/min	38 / 41	44 / 41	110 / 95	80 / 73	76 / 67	80 / 73	135 / 120
Sound pressure	Cooling / Heating (Hi)	dB(A)	46 / 48	49 / 49	52 / 52	56 / 56	54 / 54	56 / 56	54 / 53
Sound power	Cooling / Heating (Hi)	dB	65 / 68	69 / 69	69 / 69	73 / 73	70 / 70	73 / 73	71 / 70
Dimensions	H x W x D	mm	619 x 799 x 299	619 x 799 x 299	996 x 940 x 340	996 x 940 x 340	996 x 940 x 340	996 x 940 x 340	1.416 x 940 x 340
Net weight		kg	40	40	73	85	73	85	98
Piping connections	Liquid pipe	Inch (mm)	3/8 (9,52)	3/8 (9,52)	3/8 (9,52)	3/8 (9,52)	3/8 (9,52)	3/8 (9,52)	3/8 (9,52)
	Gas pipe	Inch (mm)	5/8 (15,88)	5/8 (15,88)	5/8 (15,88)	5/8 (15,88)	5/8 (15,88)	5/8 (15,88)	5/8 (15,88)
Piping length range / Elevation difference (in/out) <sup>9)</sup>		m	3 - 40 / 30	3 - 40 / 30	5 - 50 / 30	5 - 50 / 30	5 - 50 / 30	5 - 50 / 30	5 - 50 / 30
Pipe length for additional gas / Additional gas amount		m / g/m	30 / 40	30 / 40	30 / 50	30 / 50	30 / 50	30 / 50	30 / 50
Refrigerant (R410A)		kg / TCO: Eq.	1,95 / 4,0716	1,95 / 4,0716	2,60 / 5,4288	3,20 / 6,6816	2,60 / 5,4288	3,20 / 6,6816	3,40 / 7,0992
Operating range	Cooling Min - Max	°C	-10 ~ +43	-10 ~ +43	-10 ~ +43	-10 ~ +43	-10 ~ +43	-10 ~ +43	-10 ~ +43
	Heating Min - Max	°C	-15 ~ +24	-15 ~ +24	-15 ~ +24	-15 ~ +24	-15 ~ +24	-15 ~ +24	-15 ~ +24

1) EER and COP, Energy Saving Classification, is at 220 / 240V (380 / 415V) only in accordance with EU directive 2002/31/EC. 2) SEER is calculated in base Eurovent IPLV for SBEM for U1 indoor unit SEER=a(EER25)+b(EER50)+c(EER75)+d(EER100) where EER25, EER50, EER75 and EER100 are the EER measured value at 25%, 50%, 75% and 100% part load for temperatures 20, 25, 30 and 35°C DB, respectively. a, b, c and d are values assigned for an office type. These values are given as a=0,2, b=0,36, c=0,32 and d=0,03. The internal temperatures are taken at 27°C DB and 19°C WB. 3) The annual consumption(ErP) is calculated by formula determined by ErP regulation. 4) Heating capacity is calculated including defrost factor correction. 5) SCOP is calculated in base Eurovent IPLV for SBEM with U1 indoor unit including defrost correction factor. 6) Medium External static pressure setting from factory. 7) The Sound pressure of the units shows the value measured of a position 1 meter in front of the main body and 1,5 m from the ground. The sound pressure is measured in accordance with Eurovent 6/C/006-97 specification. 8) Add 100mm for piping port. 9) When installing the outdoor unit at a higher position than the indoor unit. // Recommended fuse for the indoor 3A.

### STANDARD

### ELITE

<b>A</b>	<b>A</b>	<b>-10°C</b>	<b>-15°C</b>	<b>A+</b>	<b>A</b>	<b>-15°C</b>	<b>-20°C</b>	<b>INVERTER+</b>	<b>DC FAN</b>	<b>R22 R410A</b>	<b>INTERNET CONTROL</b>	<b>BMS</b>	<b>CONNECTIVITY</b>	<b>5 YEARS WARRANTY</b>
5,30 SEER	3,80 SCOP	COOLING MODE	HEATING MODE	4,00 SEER	3,90 SCOP	COOLING MODE	HEATING MODE							

SEER and SCOP: For KIT-100PNY1E5A.

SEER and SCOP: For KIT-100PNY1E8A.

INTERNET CONTROL: Optional. Compatible with all Panasonic connectivity solutions. For detailed information go to the Control Systems section.





Included Controller. Wired remote controller CZ-RTC5A Compatible with Econavi



Optional Controller. Timer remote controller CZ-RTCA Compatible with Econavi



Optional Econavi Sensor. CZ-CENSC1



Optional Controller. Wireless remote controller CZ-RWSK2 + CZ-RWSC3



Optional Controller. Simplified remote controller CZ-REZC2



### System Example

An inspection port (450mm x 450mm or more) is required at the control-box side of the indoor unit body.

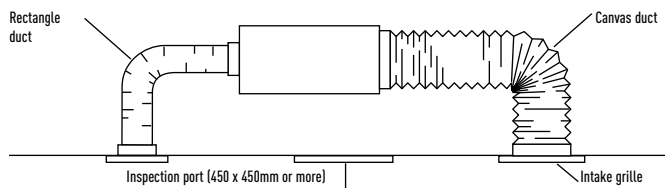

### Cold Drafts Reduction at Heating

Accurate DX Coil temperature measurement by E1 and E2 sensor to reduce cold drafts at heating and increasing efficiency and comfort.

Before spec-in, please consult with an authorized Panasonic dealer.

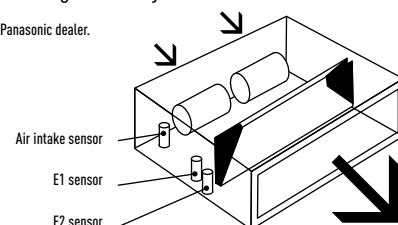

### PACI ELITE

Single Phase							Three Phase				
3,6kW	5,0kW	6,0kW	7,1kW	10,0kW	12,5kW	14,0kW	7,1kW	10,0kW	12,5kW	14,0kW	
KIT-36PN1E5B	KIT-50PN1E5B	KIT-60PN1E5B	KIT-71PN1E5A	KIT-100PN1E5A	KIT-125PN1E5A	KIT-140PN1E5A	KIT-71PN1E8A	KIT-100PN1E8A	KIT-125PN1E8A	KIT-140PN1E8A	
CZ-RTC5A	CZ-RTC5A	CZ-RTC5A	CZ-RTC5A	CZ-RTC5A	CZ-RTC5A	CZ-RTC5A	CZ-RTC5A	CZ-RTC5A	CZ-RTC5A	CZ-RTC5A	
3,6 (1,5 - 4,0)	5,0 (1,5 - 5,6)	6,0 (2,0 - 7,1)	7,1 (2,5 - 8,0)	10,0 (3,3 - 12,5)	12,5 (3,3 - 14,0)	14,0 (3,3 - 15,5)	7,1 (2,5 - 8,0)	10,0 (3,3 - 12,5)	12,5 (3,3 - 14,0)	14,0 (3,3 - 15,5)	
3,75 (4,41 - 3,57) A	3,21 (4,41 - 2,96) A	3,24 (5,00 - 2,78) A	3,30 (4,55 - 2,91) A	3,75 (3,79 - 3,29) A	3,21 (3,30 - 2,92) A	3,01 (3,30 - 2,50) B	3,30 (3,79 - 2,91) A	3,75 (3,79 - 3,29) A	3,21 (3,30 - 2,92) A	3,01 (3,30 - 2,50) A	
4,60 <b>B</b>	4,60 <b>B</b>	5,50 <b>A</b>	5,50 <b>A</b>	6,00 <b>A+</b>	-	-	5,20 <b>A</b>	5,80 <b>A+</b>	-	-	
3,6	5,0	6,0	7,1	10,0	-	-	7,1	10,0	-	-	
0,96 (0,34 - 1,12)	1,56 (0,34 - 1,89)	1,85 (0,40 - 2,55)	2,15 (0,55 - 2,75)	2,67 (0,87 - 3,80)	3,89 (1,00 - 4,80)	4,65 (1,00 - 6,20)	2,15 (0,66 - 2,75)	2,67 (0,87 - 3,80)	3,89 (1,00 - 4,80)	4,65 (1,00 - 6,20)	
274	380	382	452	583	-	-	477	603	-	-	
4,0 (1,5 - 5,0)	5,6 (1,5 - 6,5)	7,0 (1,8 - 8,0)	8,0 (2,0 - 9,0)	11,2 (4,1 - 14,0)	14,0 (4,1 - 16,0)	16,0 (4,1 - 18,0)	8,0 (2,0 - 9,0)	11,2 (4,1 - 14,0)	14,0 (4,1 - 16,0)	16,0 (4,1 - 18,0)	
- / -	- / -	- / -	7,52	12,04	13,48	14,24	7,52	12,04	13,48	14,24	
4,30 (5,17 - 4,00) A	3,81 (5,17 - 3,49) A	3,74 (5,14 - 3,64) A	3,54 (4,00 - 3,08) B	3,80 (4,18 - 3,11) A	3,61 (3,90 - 2,96) A	3,41 (3,90 - 2,95) B	3,54 (3,33 - 3,00) B	3,80 (4,18 - 3,11) A	3,61 (3,90 - 2,96) A	3,41 (3,90 - 2,95) B	
3,80 <b>A</b>	3,80 <b>A</b>	3,80 <b>A</b>	3,70 <b>A</b>	3,90 <b>A</b>	-	-	3,70 <b>A</b>	3,80 <b>A</b>	-	-	
3,6	3,8	5,6	6,5	10,0	-	-	6,5	10,0	-	-	
0,93 (0,29 - 1,25)	1,47 (0,29 - 1,86)	1,87 (0,35 - 2,20)	2,26 (0,50 - 2,92)	2,95 (0,98 - 4,50)	3,88 (1,05 - 5,40)	4,69 (1,05 - 6,10)	2,26 (0,60 - 3,00)	2,95 (0,98 - 4,50)	3,88 (1,05 - 5,40)	4,69 (1,05 - 6,10)	
1,326	-	2,061	2,458	3,590	-	-	2,458	3,684	-	-	
<b>S-36PN1E5A</b>	<b>S-50PN1E5A</b>	<b>S-60PN1E5A</b>	<b>S-71PN1E5A</b>	<b>S-100PN1E5A</b>	<b>S-125PN1E5A</b>	<b>S-140PN1E5A</b>	<b>S-71PN1E5A</b>	<b>S-100PN1E5A</b>	<b>S-125PN1E5A</b>	<b>S-140PN1E5A</b>	
50 (10 - 80)	50 (10 - 80)	50 (10 - 80)	50 (10 - 80)	50 (10 - 80)	50 (10 - 80)	50 (10 - 80)	50 (10 - 80)	50 (10 - 80)	50 (10 - 80)	50 (10 - 80)	
14 / 12 / 10	16 / 13 / 11	22 / 20 / 16	22 / 20 / 16	36 / 33 / 26	38 / 35 / 28	40 / 37 / 30	22 / 20 / 16	36 / 33 / 26	38 / 35 / 28	40 / 37 / 30	
2,1	2,8	3,4	4,2	6,0	7,9	9,0	4,2	6,0	7,9	9,0	
40 / 38 / 35	41 / 39 / 35	43 / 41 / 36	43 / 41 / 36	44 / 42 / 37	45 / 43 / 38	46 / 44 / 39	43 / 41 / 36	44 / 42 / 37	45 / 43 / 38	46 / 44 / 39	
57 / 55 / 52	58 / 56 / 52	60 / 58 / 53	60 / 58 / 53	65 / 63 / 58	66 / 64 / 59	67 / 65 / 60	60 / 58 / 53	65 / 63 / 58	66 / 64 / 59	67 / 65 / 60	
250 x 780 x 650	250 x 780 x 650	250 x 1.000 x 650	250 x 1.000 x 650	250 x 1.200 x 650	250 x 1.200 x 650	250 x 1.200 x 650	250 x 1.200 x 650	250 x 1.200 x 650	250 x 1.200 x 650	250 x 1.200 x 650	
29	29	32	32	41	41	41	32	41	41	41	
<b>U-36PE2E5A</b>	<b>U-50PE2E5A</b>	<b>U-60PE2E5A</b>	<b>U-71PE1E5A</b>	<b>U-100PE1E5A</b>	<b>U-125PE1E5A</b>	<b>U-140PE1E5A</b>	<b>U-71PE1E8A</b>	<b>U-100PE1E8A</b>	<b>U-125PE1E8A</b>	<b>U-140PE1E8A</b>	
220 / 230 / 240	220 / 230 / 240	220 / 230 / 240	220 / 230 / 240	220 / 230 / 240	220 / 230 / 240	220 / 230 / 240	380 / 400 / 415	380 / 400 / 415	380 / 400 / 415	380 / 400 / 415	
-	-	-	20	25	30	16	16	16	16	16	
-	-	-	2,5	4	6	2,5	2,5	2,5	2,5	2,5	
3,75 / 3,55 / 3,40	6,25 / 5,95 / 5,70	7,90 / 7,50 / 7,25	9,70 / 9,40 / 9,20	11,6 / 11,2 / 10,9	17,4 / 16,9 / 16,4	20,5 / 20,1 / 19,5	3,25 / 3,10 / 3,00	3,95 / 3,75 / 3,60	5,80 / 5,50 / 5,30	6,95 / 6,60 / 6,35	
3,80 / 3,60 / 3,45	6,05 / 5,75 / 5,50	8,50 / 8,15 / 7,80	10,2 / 9,90 / 9,70	12,8 / 12,5 / 12,2	17,3 / 16,8 / 16,3	20,6 / 20,2 / 19,6	3,35 / 3,20 / 3,10	4,35 / 4,15 / 4,00	5,80 / 5,50 / 5,30	7,00 / 6,65 / 6,45	
38 / 38	38 / 41	38 / 41	60 / 60	110 / 95	130 / 110	135 / 120	60 / 60	110 / 95	130 / 110	135 / 120	
45 / 46	46 / 48	46 / 49	48 / 50	52 / 52	53 / 53	54 / 55	48 / 50	52 / 52	53 / 53	54 / 55	
64 / 66	65 / 68	65 / 69	65 / 67	69 / 69	70 / 70	71 / 71	65 / 67	69 / 69	70 / 70	71 / 71	
619 x 799 x 299	619 x 799 x 299	619 x 799 x 299	996 x 940 x 340	1.416 x 940 x 340	1.416 x 940 x 340	1.416 x 940 x 340	996 x 940 x 340	1.416 x 940 x 340	1.416 x 940 x 340	1.416 x 940 x 340	
39	39	40	69	98	98	98	71	98	98	98	
1/4 (6,35)	1/4 (6,35)	3/8 (9,52)	3/8 (9,52)	3/8 (9,52)	3/8 (9,52)	3/8 (9,52)	3/8 (9,52)	3/8 (9,52)	3/8 (9,52)	3/8 (9,52)	
1/2 (12,7)	1/2 (12,7)	5/8 (15,88)	5/8 (15,88)	5/8 (15,88)	5/8 (15,88)	5/8 (15,88)	5/8 (15,88)	5/8 (15,88)	5/8 (15,88)	5/8 (15,88)	
3 - 40 / 30	3 - 40 / 30	3 - 40 / 30	5 - 50 / 30	5 - 75 / 30	5 - 75 / 30	5 - 75 / 30	5 - 50 / 30	5 - 75 / 30	5 - 75 / 30	5 - 75 / 30	
30 / 20	30 / 20	30 / 40	30 / 50	30 / 50	30 / 50	30 / 50	30 / 50	30 / 50	30 / 50	30 / 50	
1,40 / 2,9232	1,40 / 2,9232	1,95 / 4,0716	2,35 / 4,9068	3,40 / 7,0992	3,40 / 7,0992	3,40 / 7,0992	2,35 / 4,9068	3,40 / 7,0992	3,40 / 7,0992	3,40 / 7,0992	
-15 ~ +46	-15 ~ +46	-15 ~ +46	-15 ~ +46	-15 ~ +46	-15 ~ +46	-15 ~ +46	-15 ~ +46	-15 ~ +46	-15 ~ +46	-15 ~ +46	
-20 ~ +24	-20 ~ +24	-20 ~ +24	-20 ~ +24	-20 ~ +24	-20 ~ +24	-20 ~ +24	-20 ~ +24	-20 ~ +24	-20 ~ +24	-20 ~ +24	

### Accessories

<b>CZ-RTC4</b>	Standard Wired remote control with Econavi
<b>CZ-RWSK2 + CZ-RWSC3</b>	Wireless remote control
<b>CZ-REZC2</b>	Simplified remote control
<b>PAW-GRDSTD40</b>	Outdoor elevation platform 400 x 900 x 400mm
<b>PAW-WTRAY</b>	Tray for condenser water compatible with base ground support
<b>PAW-GRDBSE20</b>	Outdoor base ground support for noise and vibration absorption (600 x 95 x 130mm, 500kg)
<b>PAW-WPH7</b>	Wind protection shield for U-50PE2E5A
<b>PAW-WPH9</b>	Wind protection shield for U-60PE2E5A, U-71PE1E5A/8A, U-100PE1E5/8, U-125PE1E5/8
<b>PAW-WPH10</b>	Wind protection shield for U-100PE1E5A/8A, U-125PE1E5A/8A, U-140PE1E5A/8A, U-140PE1E8

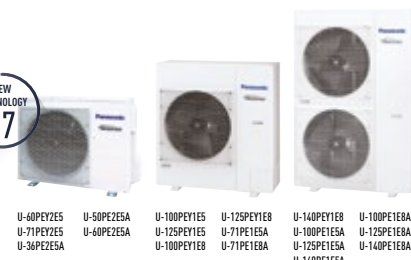

# WALL MOUNTED PACi INVERTER+

The extension of the range to include a 10kW unit allows for many more applications such as studios, gyms, high ceiling areas and even computer server rooms.

The unit's compact design and flat face ensure discreet installation, even in a small space.

## High heating capacity at -7°C.

### Technical focus

- 10,0kW capacity unit
- Flat face design for modern appearance
- Compact design offers over 15% reduction in overall size
- Washable front panel
- DC FAN for better efficiency and control
- Three directional piping outlet
- Easy connection and control of external fan or ERV using the connector PAW-FDC on the indoor unit PCB. The external device can be control by the remote control of the Panasonic indoor unit

			PACi STANDARD			
			Single Phase		Three Phase	
			6,0kW	7,1kW	10,0kW	10,0kW
			KIT-60PKY1E5B	KIT-71PKY1E5B	KIT-100PKY1E5A	KIT-100PKY1E8A
			CZ-RTC5A	CZ-RTC5A	CZ-RTC5A	CZ-RTC5A
<b>KIT</b>						
<b>Timer remote controller</b>						
Cooling capacity	Nominal (Min - Max)	kW	6,0 (2,0 - 7,1)	7,1 (2,0 - 7,7)	9,0 (2,7 - 9,7)	9,0 (2,7 - 9,7)
EER <sup>1)</sup>	Nominal (Min - Max)	W/W	3,53 (6,67 - 3,09) A	2,90 (6,67 - 2,61) C	2,67 (5,09 - 2,55) D	2,67 (5,09 - 2,55) D
<b>SEER<sup>2)</sup></b>		<b>W/W</b>	<b>5,50</b>	<b>5,20</b>	<b>5,80</b>	<b>5,70</b>
Pdesign		kW	6,0	7,1	9,0	9,0
Input power cooling	Nominal (Min - Max)	kW	1,70 (0,30 - 2,35)	2,45 (0,30 - 2,95)	3,37 (0,53 - 3,80)	3,37 (0,53 - 3,80)
Annual energy consumption (ErP) <sup>3)</sup>		kWh/a	382	478	543	553
Heating capacity	Nominal (Min - Max)	kW	6,0 (1,8 - 7,0)	7,1 (1,8 - 8,1)	9,0 (2,1 - 10,5)	9,0 (2,1 - 10,5)
Heating capacity at -7/-15°C <sup>4)</sup>		kW	- / -	- / -	9,97 / 8,43	9,97 / 8,43
COP <sup>1)</sup>	Nominal (Min - Max)	W/W	4,14 (9,00 - 4,12) A	4,08 (9,00 - 3,60) A	3,70 (5,12 - 3,50) A	3,70 (5,12 - 3,50) A
<b>SCOP<sup>5)</sup></b>		<b>W/W</b>	<b>3,90</b>	<b>3,90</b>	<b>3,80</b>	<b>3,80</b>
Pdesign at -10°C		kW	6,0	6,0	9,0	9,0
Input power heating	Nominal (Min - Max)	kW	1,45 (0,20 - 1,70)	1,74 (0,20 - 2,25)	2,43 (0,41 - 3,00)	2,43 (0,41 - 3,00)
Annual energy consumption (ErP) <sup>3)</sup>		kWh/a	2.153	2.151	3.316	3.316
<b>Indoor Unit</b>			<b>S-60PK1E5A</b>	<b>S-71PK1E5A</b>	<b>S-100PK1E5A</b>	<b>S-100PK1E5A</b>
Air volume	Hi / Med / Lo	m³/min	18,0 / 14,5 / 11,5	18,0 / 14,5 / 11,5	19,0 / 16,5 / 13,0	19,0 / 16,5 / 13,0
Moisture removal volume		L/h	3,4	4,2	5,4	5,4
Sound pressure <sup>6)</sup>	Hi / Med / Lo	dB(A)	47 / 44 / 40	47 / 44 / 40	49 / 45 / 41	49 / 45 / 41
Sound power	Hi / Med / Lo	dB	64 / 59 / 54	64 / 59 / 54	65 / - / -	65 / - / -
Dimensions	H x W x D	mm	300 x 1.065 x 230	300 x 1.065 x 230	300 x 1.065 x 230	300 x 1.065 x 230
Net weight		kg	14,5	14,5	14,5	14,5
<b>Outdoor Unit</b>			<b>U-60PEY2E5</b>	<b>U-71PEY2E5</b>	<b>U-100PEY1E5</b>	<b>U-100PEY1E8</b>
Power source		V	220 / 230 / 240	220 / 230 / 240	220 / 230 / 240	380 / 400 / 415
Recommended fuse		A	-	-	25	16
Connection		mm²	-	-	4,0	2,5
Current	Cooling	A	8,00 / 7,60 / 7,30	10,70 / 10,30 / 9,85	16,0 / 15,3 / 14,8	5,45 / 5,20 / 5,05
	Heating	A	7,05 / 6,75 / 6,45	8,50 / 8,10 / 7,80	13,0 / 12,5 / 12,1	4,45 / 4,25 / 4,10
Air volume	Cooling / Heating	m³/min	38 / 41	44 / 41	76 / 67	76 / 67
Sound pressure	Cooling / Heating (Hi)	dB(A)	46 / 48	49 / 49	54 / 54	54 / 54
Sound power	Cooling / Heating (Hi)	dB	65 / 68	69 / 69	70 / 70	70 / 70
Dimensions	H x W x D	mm	619 x 799 x 299	619 x 799 x 299	996 x 940 x 340	996 x 940 x 340
Net weight		kg	40	40	73	73
Piping connections	Liquid pipe	Inch (mm)	3/8 (9,52)	3/8 (9,52)	3/8 (9,52)	3/8 (9,52)
	Gas pipe	Inch (mm)	5/8 (15,88)	5/8 (15,88)	5/8 (15,88)	5/8 (15,88)
Piping length range / Elevation difference (in/out) <sup>7)</sup>		m	3 - 40 / 30	3 - 40 / 30	5 - 50 / 30	5 - 50 / 30
Pipe length for additional gas / Additional gas amount		m / g/m	30 / 40	30 / 40	30 / 50	30 / 50
Refrigerant (R410A)		kg / TCO <sub>2</sub> Eq.	1,95 / 4,0716	1,95 / 4,0716	2,60 / 5,4288	2,60 / 5,4288
Operating range	Cooling Min - Max	°C	-10 - +43	-10 - +43	-10 / +43	-10 / +43
	Heating Min - Max	°C	-15 - +24	-15 - +24	-15 / +24	-15 / +24

1) EER and COP, Energy Saving Classification, is at 220 / 240V (380 / 415V) only in accordance with EU directive 2002/31/EC. 2) SEER is calculated in base Eurovent IPLV for SBEM for U1 indoor unit SEER=a(EER25)+b(EER50)+c(EER75)+d(EER100) where EER25, EER50, EER75 and EER100 are the EER measured value at 25%, 50%, 75% and 100% part load for temperatures 20, 25, 30 and 35°C DB, respectively. a, b, c and d are values assigned for an office type. These values are given as a=0,2, b=0,36, c=0,32 and d=0,03. The internal temperatures are taken at 27°C DB and 19°C WB. 3) The annual consumption (ErP) is calculated by formula determined by ErP regulation. 4) Heating capacity is calculated including defrost factor correction. 5) SCOP is calculated in base Eurovent IPLV for SBEM with U1 indoor unit including defrost correction factor. 6) The Sound pressure of the units shows the value measured of a position 1 meter in front of the main body and 1,5 m from the ground. The sound pressure is measured in accordance with Eurovent 6/C/006-97 specification. 7) When installing the outdoor unit at a higher position than the indoor unit. // Recommended fuse for the indoor 3A.

### STANDARD

### ELITE

--	--	--	--	--	--	--	--	--	--	--	--	--	--	--

SEER and SCOP: For KIT-100PKY1E5A.

SEER and SCOP: For KIT-60PKY1E5B.

INTERNET CONTROL: Optional. Compatible with all Panasonic connectivity solutions. For detailed information go to the Control Systems section.



Included Controller.  
Wired remote controller  
CZ-RTC5A  
Compatible with Econavi



Optional Controller.  
Timer remote controller  
CZ-RTC4  
Compatible with Econavi



Optional Econavi Sensor.  
CZ-CENSCT1



Optional Controller.  
Wireless remote controller  
CZ-RWSK2



Optional Controller.  
Simplified remote controller  
CZ-REZC2



**Washable front panel.**

The indoor unit's front panel can be easily removed and washed for trouble-free cleaning.

**Closed discharge port.**

When the unit is turned OFF, the flap closes completely to prevent dust getting into the unit and to keep the equipment clean.

**Quiet operation.**

These units are among the quietest in the industry, making them ideal for hotels and hospitals.

**Smooth and durable design.**

The sleek, compact design ensures a discreet installation - even where space is limited.

**Piping outlet in three directions.**

With three options for pipe outlets-rear, right and left - installation is made easy.

**Air distribution is altered depending on the operational mode of the unit.**

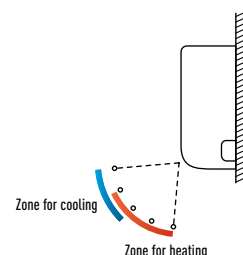

**PACI ELITE**

Single Phase				Three Phase			
3,6kW	5,0kW	6,0kW	7,1kW	10,0kW	7,1kW	10,0kW	
KIT-36PK1E5B	KIT-50PK1E5B	KIT-60PK1E5B	KIT-71PK1E5A	KIT-100PK1E5A	KIT-71PK1E8A	KIT-100PK1E8A	
CZ-RTC5A	CZ-RTC5A	CZ-RTC5A	CZ-RTC5A	CZ-RTC5A	CZ-RTC5A	CZ-RTC5A	
3,6 (1,5 - 4,0)	5,0 (1,5 - 5,6)	6,0 (2,0 - 7,1)	7,1 (2,5 - 8,0)	9,5 (3,3 - 10,5)	7,1 (3,2 - 8,0)	9,5 (3,3 - 10,5)	
4,56 (6,25 - 4,30) A	3,57 (6,25 - 3,26) A	3,57 (6,67 - 3,02) A	3,40 (5,56 - 3,02) A	3,25(3,93 - 3,09) A	3,40 (5,71 - 3,09) A	3,25(3,93 - 3,09) A	
<b>6,30</b> A++	<b>6,10</b> A++	<b>6,60</b> A++	<b>6,60</b> A++	<b>6,20</b> A++	<b>6,10</b> A++	<b>6,00</b> A+	
3,6	5,0	6,0	7,1	9,5	7,1	9,5	
0,79 (0,24 - 0,93)	1,40 (0,24 - 1,72)	1,68 (0,30 - 2,35)	2,09 (0,45 - 2,65)	2,92 (0,84 - 3,40)	2,09 (0,56 - 2,65)	2,92 (0,84 - 3,40)	
200	287	318	376	536	407	554	
4,0 (1,5 - 5,0)	5,6 (1,5 - 6,5)	7,0 (1,8 - 8,0)	8,0 (2,0 - 9,0)	9,5 (4,1 - 11,5)	8,0 (2,8 - 9,0)	9,5 (4,1 - 11,5)	
- / -	- / -	- / -	7,52 / 7,65	12,04 / 11,20	7,52 / 7,65	12,04 / 11,20	
4,65 (7,89 - 4,20) A	3,76 (7,89 - 3,39) A	4,02 (9,00 - 3,90) A	3,76 (5,00 - 3,10) A	3,85 (4,56 - 3,43) A	3,76 (5,60 - 3,10) A	3,85 (4,56 - 3,43) A	
<b>4,20</b> A+	<b>4,00</b> A+	<b>4,00</b> A+	<b>3,90</b> A	<b>3,80</b> A	<b>3,80</b> A	<b>3,80</b> A	
3,6	5,0	6,0	7,1	9,5	7,1	9,5	
0,86 (0,19 - 1,19)	1,49 (0,19 - 1,92)	1,74 (0,20 - 2,05)	2,13 (0,40 - 2,90)	2,47 (0,90 - 3,35)	2,13 (0,50 - 2,90)	2,47 (0,90 - 3,35)	
1.200	1.749	2.101	2.548	3.500	2.616	3.500	
S-36PK1E5A	S-50PK1E5A	S-60PK1E5A	S-71PK1E5A	S-100PK1E5A	S-71PK1E5A	S-100PK1E5A	
11,0 / 9,5 / 7,5	14,0 / 12,0 / 10,5	18,0 / 14,5 / 11,5	18,0 / 14,5 / 11,5	19,0 / 16,5 / 13,0	18,0 / 14,5 / 11,5	19,0 / 16,5 / 13,0	
2,1	2,8	3,4	4,2	5,7	4,2	5,7	
35 / 31 / 27	40 / 36 / 32	47 / 44 / 40	47 / 44 / 40	49 / 45 / 41	47 / 44 / 40	49 / 45 / 41	
52 / 46 / 41	57 / 51 / 46	64 / 59 / 54	64 / - / -	65 / - / -	64 / - / -	65 / - / -	
300 x 1.065 x 230	300 x 1.065 x 230	300 x 1.065 x 230	300 x 1.065 x 230	300 x 1.065 x 230	300 x 1.065 x 230	300 x 1.065 x 230	
13,0	14,5	14,5	14,5	14,5	14,5	14,5	
U-36PE2E5A	U-50PE2E5A	U-60PE2E5A	U-71PE1E5A	U-100PE1E5A	U-71PE1E8A	U-100PE1E8A	
220 / 230 / 240	220 / 230 / 240	220 / 230 / 240	220 / 230 / 240	220 / 230 / 240	380 / 400 / 415	380 / 400 / 415	
-	-	-	20	25	16	16	
-	-	-	2,5	4,0	2,5	2,5	
3,75 / 3,55 / 3,40	6,25 / 5,95 / 5,70	7,90 / 7,50 / 7,25	9,70 / 9,40 / 9,20	11,6 / 11,2 / 10,9	3,25 / 3,10 / 3,00	3,95 / 3,75 / 3,60	
3,80 / 3,60 / 3,45	6,05 / 5,75 / 5,50	8,50 / 8,15 / 7,80	10,2 / 9,90 / 9,70	12,8 / 12,5 / 12,2	3,35 / 3,20 / 3,10	4,35 / 4,15 / 4,00	
38 / 38	38 / 41	38 / 41	60 / 60	110 / 95	60 / 60	110 / 95	
45 / 46	46 / 48	46 / 49	48 / 50	52 / 52	48 / 50	52 / 52	
64 / 66	65 / 68	65 / 69	65 / 67	69 / 69	65 / 67	69 / 69	
619 x 799 x 299	619 x 799 x 299	619 x 799 x 299	996 x 940 x 340	1.416 x 940 x 340	996 x 940 x 340	1.416 x 940 x 340	
39	39	40	69	98	71	98	
1/4 (6,35)	1/4 (6,35)	3/8 (9,52)	3/8 (9,52)	3/8 (9,52)	3/8 (9,52)	3/8 (9,52)	
1/2 (12,7)	1/2 (12,7)	5/8 (15,88)	5/8 (15,88)	5/8 (15,88)	5/8 (15,88)	5/8 (15,88)	
3 - 40 / 30	3 - 40 / 30	3 - 40 / 30	5 - 50 / 30	5 - 75 / 30	5 - 50 / 30	5 - 75 / 30	
30 / 20	30 / 20	30 / 40	30 / 50	30 / 50	30 / 50	30 / 50	
1,40 / 2,9232	1,40 / 2,9232	1,95 / 4,0716	2,35 / 4,9068	3,40 / 7,0992	2,35 / 4,9068	3,40 / 7,0992	
-15 ~ +46	-15 ~ +46	-15 ~ +46	-15 ~ +46	-15 ~ +46	-15 ~ +46	-15 ~ +46	
-20 ~ +24	-20 ~ +24	-20 ~ +24	-20 ~ +24	-20 ~ +24	-20 ~ +24	-20 ~ +24	

**Accessories**

<b>CZ-RTC4</b>	Standard Wired remote control with Econavi
<b>CZ-RWSK2</b>	Wireless remote control
<b>CZ-REZC2</b>	Simplified remote control
<b>PAW-GRDSTD40</b>	Outdoor elevation platform 400 x 900 x 400mm
<b>PAW-WTRAY</b>	Tray for condenser water compatible with base ground support
<b>PAW-GRDBSE20</b>	Outdoor base ground support for noise and vibration absorption (600 x 95 x 130mm, 500kg)
<b>PAW-WPH7</b>	Wind protection shield for U-50PE2E5A
<b>PAW-WPH9</b>	Wind protection shield for U-60PE2E5A, U-71PE1E5A/8A, U-100PE1E5/8, U-125PE1E5/8
<b>PAW-WPH10</b>	Wind protection shield for U-100PE1E5A/8A, U-125PE1E5A/8A, U-140PE1E5A/8A, U-140PE1E8
<b>PAW-PACR3</b>	Interfaces to run 3 units on Backup and alternative run



## HIGH STATIC PRESSURE HIDE AWAY 20-25kW BIG PACi INVERTER+

The 8-10HP from Panasonic is ideally suited for large retail applications and other large areas not needing the higher capacities of VRF systems.

### All New "A" Functions

- Control demand 0-10V via CZ-CAPBC2
- Schedule peak cut
- Advanced Energy Saving Functionalities available in Elite series
- Compact design: Good size to install balcony
- Suitable for Mid, Small Project

### PE2 vs. PE1 series

1. New heat exchanger: better performance 8% higher than PE1
2. New fan: 27% higher air flow rate than PE1
3. New Panasonic compressor: 50% wider capacity range than PE1, better performance. Best partial load ever. 120m maximum piping

### New Panasonic Compressor

Best inverter control providing better partial load in industry\* 10%-100% Frequency Hz.

Wider operation Hz range of compressor realize more high efficient operation through the year.

\* Compared current model is the unit for European market.



### Enlarged heat exchanger surface area

The new heat exchanger has been designed with 8% bigger surface than conventional model. This enlarged surface provides high performance of heat exchange effect. Also, highly efficient piping pattern increases heat exchange performance by 5%.



### Bluefin

An air conditioner's performance depends largely on its condenser, which can take a beating from exposure to salty air, wind, dust and other corrosive factors. Panasonic has found a way to expand the life of our condensers, using a layer of our original anti-rust coating. This special coating lets you enjoy more years of reliable comfort plus extra economy over the long run.

Compatible with all Panasonic connectivity solutions.





### Panasonic breaks new ground in offering high performance and power in a small space

The 8-10HP from Panasonic is ideally suited for large retail applications and other large areas not needing the higher capacities of VRF systems. The lightweight and compact design enables easier installation in any commercial space. The twin fan system saves valuable footprint compared to traditional 8-10HP systems which are larger and therefore require more space.

### High heating capacity at -7°C.

### Technical focus

- Higher efficiency:
  - New heat exchanger
  - New and bigger fan
  - New Panasonic compressor
  - New chassis
- Better partial load
- More flexible
- Bluefin anti-rust coating
- 0-10V control demand

### BIG PACI

			Three Phase	
			20,0kW	25,0kW
KIT			KIT-200PE2E5B	KIT-250PE2E5B
Timer remote controller			CZ-RTCSA	CZ-RTCSA
Cooling capacity	Nominal (Min - Max)	kW	19,50 (5,40 - 22,40)	25,00 (6,30 - 28,00)
EER <sup>1)</sup>		W/W	3,11 B	2,91 C
Input power cooling		kW	5,97	8,04
Heating capacity	Nominal (Min - Max)	kW	22,40 (5,60 - 25,00)	28,00 (7,10 - 31,50)
Heating capacity at -7°C <sup>2)</sup>		kW	20,00	25,20
Heating capacity at -15°C <sup>2)</sup>		kW	17,00	21,42
COP <sup>1)</sup>		W/W	3,54 B	3,64 A
Input power heating		kW	6,02	7,14
Indoor Unit			S-200PE2E5	S-250PE2E5
Power source		V / ph / Hz	220 - 230 - 240 / 1 / 50	220 - 230 - 240 / 1 / 50
External static pressure at shipment (with booster cable)		Pa	60 - 140 - 270	72 - 140 - 270
Air volume	Hi / Med / Lo	m <sup>3</sup> /min	56,0 / 51,0 / 44,0	72,0 / 63,0 / 53,0
Sound pressure <sup>3)</sup>	Hi / Med / Lo	dB(A)	43 / 41 / 38	47 / 45 / 42
Sound power	Hi / Med / Lo	dB	75 / 73 / 70	79 / 77 / 74
Dimensions / Net weight	H x W x D	mm / kg	479 x 1.453 x 1.205 / 100	479 x 1.453 x 1.205 / 104
Outdoor Unit			U-200PE2E8A	U-250PE2E8A
Power source		V / ph / Hz	380 - 400 - 415 / 3 / 50	380 - 400 - 415 / 3 / 50
Recommended fuse		A	15	20
Air volume	Cooling / Heating	m <sup>3</sup> /min	164,0	160,0
Sound pressure <sup>3)</sup>	Cooling / Heating (Hi)	dB(A)	60 / 62	61 / 63
Sound power		dB	72	72
Dimensions <sup>4)</sup> / Net weight	H x W x D	mm / kg	1.500 x 980 x 370 / 127	1.500 x 980 x 370 / 138
Piping connections	Liquid pipe / Gas pipe	Inch (mm)	3/8 (9,52) / 1 (25,4)	1/2 (12,7) / 1 (25,4)
Piping length range / Elevation difference (in/out) <sup>5)</sup>		m	5 - 120 / 30	5 - 120 / 30
Pipe length for additional gas / Additional gas amount		m / g/m	30 / 50	30 / 80
Refrigerant (R410A)		kg / TCO <sub>2</sub> Eq.	5,60 / 11,6928	6,40 / 13,3632
Operating range	Cooling Min ~ Max	°C	-15 ~ +46	-15 ~ +46
	Heating Min ~ Max	°C	-20 ~ +24	-20 ~ +24

1) EER and COP, Energy Saving Classification, is at 220 / 240V (380 / 415V) only in accordance with EU directive 2002/31/EC. 2) SEER is calculated in base Eurovent IPLV for SBEM for U1 indoor unit SEER=a(EER25)+b(EER50)+c(EER75)+d(EER100) where EER25, EER50, EER75 and EER100 are the EER measured value at 25%, 50%, 75% and 100% part load for temperatures 20, 25, 30 and 35°C DB, respectively. a, b, c and d are values assigned for an office type. These values are given as a=0,2, b=0,36, c=0,32 and d=0,03. The internal temperatures are taken at 27°C DB and 19°C WB. 3) Heating capacity is calculated including defrost factor correction. 4) SCOP is calculated in base Eurovent IPLV for SBEM with U1 indoor unit including defrost correction factor. 5) The Sound pressure of the units shows the value measured of a position 1 meter in front of the main body and 1,5 m from the ground. The sound pressure is measured in accordance with Eurovent 6/C/006-97 specification. 6) Add 100mm for indoor unit or 70mm for outdoor unit for piping port. 7) When installing the outdoor unit at a higher position than the indoor unit.

### Accessories

CZ-RTC4	Standard Wired remote control with Econavi
CZ-RWSK2 + CZ-RWSC3	Wireless remote control
CZ-RE2C2	Simplified remote control
PAW-GRDSTD40	Outdoor elevation platform 400 x 900 x 400mm
PAW-WPH8	Wind protection shield for U-200PE2E8A and U-250PE2E8A
CZ-TREMIESPW706	Air Outlet Plenum (suitable for rigid + flexible duct) for S-250PE2E5
CZ-TREMIESPW705	Air Outlet Plenum (suitable for rigid + flexible duct) for S-200PE2E5



INTERNET CONTROL: Optional. Compatible with all Panasonic connectivity solutions. For detailed information go to the Control Systems section.  
 Rating Conditions: Cooling Indoor 27°C DB / 19°C WB. Cooling Outdoor 35°C DB / 24°C WB. Heating Indoor 20°C DB. Heating Outdoor 7°C DB / 6°C WB. (DB: Dry Bulb; WB: Wet Bulb)  
 Specifications subject to change without notice. For detailed information about ErP, please visit our websites www.aircon.panasonic.eu or www.ptc.panasonic.eu.



# PACi SINGLE, TWIN, TRIPLE AND DOUBLE-TWIN SYSTEM



With this system, a single outdoor unit can split capacity for up to 4 indoor areas simultaneously. This makes the system particularly apt for common areas. It reduces noise concentration and enables the same temperature to be reached around the room. A mix of indoor units can be installed (wall, cassette, duct, ceiling) in one system.

**PACi Standard Single and Twin System from 6,0 to 14,0 kW.**

Up to 2 indoor units connectable on the same outdoor. Panasonic's PACi units can be installed as single and twin systems. The indoor units can be combined following the selection table. The operation will always be simultaneous. All the indoor units will work with the same settings.

**PACi Elite Twin, Triple and Double-Twin System from 7,1 to 14,0kW.**

Up to 4 indoor units can be connected to the same outdoor unit. Panasonic's PACi units 71, 100, 125 and 140 can be installed as twin, triple and double-twin systems. The indoor units can be combined as per the selection table. The operation will always be simultaneous. All the indoor units will work with the same settings.

**Big PACi Elite Twin, Triple and Double-Twin System from 20,0 to 25,0kW.**

Up to 4 indoor units can be connected to the same outdoor unit. Panasonic's PACi units 200 and 250 can be installed as twin, triple and double-twin systems. The indoor units can be combined as per the selection table. The operation will always be simultaneous. All the indoor units will work with the same settings.

**PACi Standard Single/Simultaneous operation system combinations.**

kW	Outdoor			
Indoor	7,1	10,0	12,5	14,0
3,6				
5,0		Twin U-100 S-50 S-50		
6,0			Twin U-125 S-60 S-60	
7,1	Single <sup>1</sup> U-71 S-71			Twin U-140 S-71 S-71
10,0		Single <sup>1</sup> U-100 S-100		
12,5			Single <sup>1</sup> U-125 S-125	
14,0				Single <sup>1</sup> U-140 S-140

**PACi Elite from 7,1 to 14,0kW Single/Simultaneous operation system combinations.**

kW	Outdoor			
Indoor	7,1	10,0	12,5	14,0
3,6	Twin U-71 S-36 S-36	Triple U-100 S-36 S-36 S-36	Double-Twin U-125 S-36 S-36 S-36 S-36	
4,5			Triple U-125 S-45 S-45 S-45	
5,0		Twin U-100 S-50 S-50		Triple U-140 S-50 S-50 S-50
6,0			Twin U-125 S-60 S-60	
7,1	Single <sup>1</sup> U-71 S-71			Twin U-140 S-71 S-71
10,0		Single <sup>1</sup> U-100 S-100		
12,5			Single <sup>1</sup> U-125 S-125	
14,0				Single <sup>1</sup> U-140 S-140

**PACi Elite from 20,0 to 25,0kW Single/Simultaneous operation system combinations.**

kW	Outdoor	
Indoor	20,0	25,0
5,0	Double-Twin U-200 S-50 S-50 S-50 S-50	
6,0		Double-Twin U-250 S-60 S-60 S-60 S-60
7,1	Triple U-200 S-71 S-71 S-71	
10,0	Twin U-200 S-100 S-100	
12,5		Twin U-250 S-125 S-125
20,0	Single <sup>1</sup> U-200 S-200	
25,0		Single <sup>1</sup> U-250 S-250

Indoor unit capacities	4 Way 90x90 Cassette	4 Way 60x60 Cassette	Ceiling	High Static Pressure Hide Away	Low Static Pressure Hide Away	Wall
3,6kW	S-36PU2E5A	S-36PY2E5A	S-36PT2E5A	S-36PF1E5A	S-36PN1E5A	S-36PK1E5A
4,5kW	S-45PU2E5A	S-45PY2E5A	S-45PT2E5A	S-45PF1E5A	S-45PN1E5A	S-45PK1E5A
5,0kW	S-50PU2E5A	S-50PY2E5A	S-50PT2E5A	S-50PF1E5A	S-50PN1E5A	S-50PK1E5A
6,0kW	S-60PU2E5A		S-60PT2E5A	S-60PF1E5A	S-60PN1E5A	S-60PK1E5A
7,1kW	S-71PU2E5A		S-71PT2E5A	S-71PF1E5A	S-71PN1E5A	S-71PK1E5A
10,0kW	S-100PU2E5A		S-100PT2E5A	S-100PF1E5A	S-100PN1E5A	S-100PK1E5A
12,5kW	S-125PU2E5A		S-125PT2E5A	S-125PF1E5A	S-125PN1E5A	

Outdoor unit capacities	PACi Standard Single and Twin System	PACi Elite Twin, Triple and Double-Twin System from 7,1 to 14,0kW	PACi Elite Twin, Triple and Double-Twin System from 20,0 to 25,0kW
7,1kW	U-71PE2E5	U-71PE1E5A // U-71PE1E8A	
10,0kW	U-100PE1E5 // U-100PE1E8		U-100PE1E5A // U-100PE1E8A
12,5kW	U-125PE1E5 // U-125PE1E8		U-125PE1E5A // U-125PE1E8A
14,0kW	U-140PE1E8		U-140PE1E5A // U-140PE1E8A
20,0kW			U-200PE2E8A
25,0kW			U-250PE2E8A

1. PACi 1x1 Kit solution. / U-\_\_1E5 Single Phase // U-\_\_1E8 Three Phase

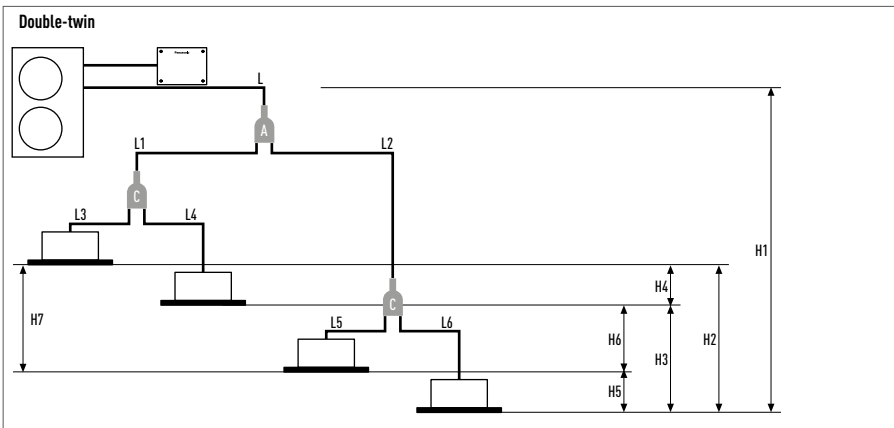
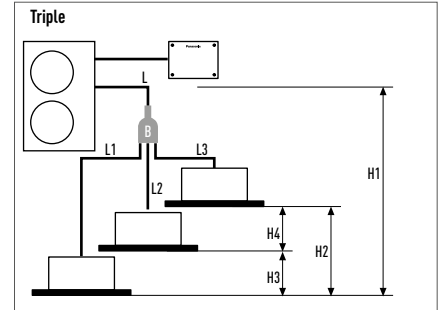
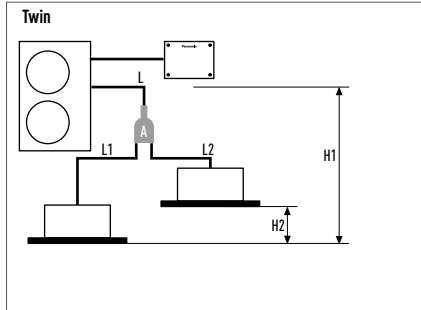
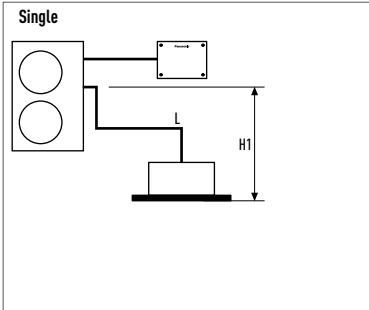

**PACi Standard Twin System from 10,0 to 14,0kW**  
 Joint distribution (sold separately)  
 A= CZ-P224BK2BM

**PACi Elite Twin, Triple and Double-Twin System from 7,1 to 14,0kW**  
 Joint distribution (sold separately)  
 A= CZ-P224BK2BM  
 B= CZ-P3HPC2BM  
 C= CZ-P224BK2BM

**PACi Elite Twin, Triple and Double-Twin System from 20,0 to 25,0kW**  
 Joint distribution (sold separately)  
 A = CZ-P680BK2BM  
 B = CZ-P3HPC2BM  
 C = CZ-P224BK2BM

Twin System	PACi Standard Single and Twin System from 10,0 to 14,0kW		Equivalent lengths and height differences (m) for outdoor unit sizes...		PACi Elite Twin, Triple and Double-Twin System from 7,1 to 25kW				Indoor unit combinations (see examples above)		Equivalent lengths and height differences (m) for outdoor unit sizes from 7,1 to 14,0kW		Equivalent lengths and height differences (m) for outdoor unit sizes from 20,0 to 25,0kW	
	Single	Twin	Single	Twin	Single	Twin	Triple	Double-Twin	Single	Twin	Triple	Double-Twin	Single	Twin
Total pipe length	L	L + L1 + L2	≤ 50m		L	L + L1 + L2	L + L1 + L2 + L3	L + L1 + L2 + L3 + L4 + L5 + L6	L	L + L1 + L2	L + L1 + L2 + L3	L + L1 + L2 + L3 + L4 + L5 + L6	U-60/U-71: ≤ 50m U-100/125/140: ≤ 75m	≤ 100m
Maximum pipe length from outdoor unit to most distant indoor unit	-	-	-	-	-	L + L1 or L + L2	L + L1 or L + L2 or L + L3	L + L1 + L3 or L + L1 + L4 or L + L2 + L5 or L + L2 + L6	-	-	-	-	-	≤ 100m
Maximum branch pipe length	-	L1 L2	≤ 15	-	-	L1 or L2	L1 or L2 or L3	L1 + L3 or L1 + L4 or L2 + L5 or L2 + L6	-	-	-	-	≤ 15m	≤ 20m
Maximum branch pipe length differences	-	L1 > L2 L1 - L2	≤ 10	-	-	L1 > L2: L1 - L2	L1 > L2 > L3: L1 - L2 L2 - L3 L1 - L3	L2 + L6 (Max.) L1 + L3 (Min.): (L2 + L6) - (L1 + L3)	≤ 10m	-	-	-	≤ 10m	≤ 10m
Maximum pipe length differences after first branch (Double-Twin)	-	-	-	-	-	-	-	L2 > L1: L2 - L1	≤ 10m	-	-	-	≤ 10m	≤ 10m
Maximum pipe length differences after second branch (Double-Twin)	-	-	-	-	-	-	-	L4 > L3: L4 - L3 L6 > L5: L6 - L5	≤ 10m	-	-	-	≤ 10m	≤ 10m
Height difference (outdoor unit located higher)	H1	H1	≤ 30	-	H1	H1	H1	H1	≤ 30m	-	-	-	≤ 30m	≤ 30m
Height difference (outdoor unit located lower)	H1	H1	≤ 15	-	H1	H1	H1	H1	≤ 15m	-	-	-	≤ 15m	≤ 15m
Height difference between indoor units	-	H2	≤ 0.5	-	-	H2	H2 or H3 or H4	H2 or H3 or H4 or H5 or H6	≤ 0.5m	-	-	-	≤ 0.5m	≤ 0.5m

Twin System	PACi Standard Single and Twin System from 10,0 to 14,0kW				PACi Elite Twin, Triple and Double-Twin System from 7,1 to 14,0kW						PACi Elite Twin, Triple and Double-Twin System from 20,0 to 25,0kW				
	Outdoor unit main pipe diameter (L)		Indoor unit connection tube (L1, L2)		Outdoor unit main pipe diameter (L)	Indoor unit connection pipe diameter (L1, L2, L3, L4) (mm)					Outdoor unit main pipe diameter (L) (mm)		Double-Twin distribution pipe (L1, L2) <sup>1</sup>	Indoor unit connection pipe diameter	
Unit type capacity	100	125	50	60	71 - 140	36	45	50	60	71	200	250	100 - 125	50	60 - 125
Liquid pipe (mm)	Ø 9,52	Ø 12,7	Ø 6,35	Ø 9,52	Ø 9,52	Ø 6,35	Ø 6,35	Ø 6,35	Ø 9,52	Ø 9,52	Ø 9,52	Ø 12,7	Ø 9,52	Ø 6,35	Ø 9,52
Gas pipe (mm)	Ø 15,88	Ø 15,88	Ø 12,7	Ø 15,88	Ø 15,88	Ø 12,70	Ø 12,70	Ø 12,70	Ø 15,88	Ø 15,88	Ø 25,4	Ø 25,4	Ø 15,88	Ø 12,7	Ø 15,88
Additional gas amount (g/m)	50	50	20	50	50	20	20	20	50	50	40	80	40	20	40

1. Total capacity of indoor unit connected after the branch

Refrigerant charging: For the twin connection, the amount of refrigerant required for pipe length 30m has been included in this unit at the factory while that required for pipe length 20 m has been included for the Triple / Double-Twin connections. No Additional gas amount is required for the first 30m pipe length in the case of the twin connection and for the first 20m in the case of the Triple / Double-Twin connections. The amount of included refrigerant for each model is listed on NAMA PLATE. Make Additional gas amounts by adding up pipe length in an order of main (L branch pipe), (L1, L2, L3 wide diameter) and then selecting the amount of refrigerant corresponding to the remaining (after 30m for the Twin connection and after 20m for the Triple / Double-Twin connections) liquid side pipe diameter and pipe length from the below table.



Compatible Indoor Units			3,6kW	4,5kW	5,0kW	6,0kW	7,1kW	10,0kW	12,5kW	14,0kW
Capacity for all indoor units	Cooling	kW	3,6	4,5	5,0	6,0	7,1	10,0	12,5	14,0
	Heating	kW	4,2	5,2	5,6	7,0	8,0	11,2	14,0	14,0
Wall			S-36PK1E5A	S-45PK1E5A	S-50PK1E5A	S-60PK1E5A	S-71PK1E5A	S-100PK1E5A		
Dimensions	H x W x D	mm	300 x 1.065 x 230	300 x 1.065 x 230	300 x 1.065 x 230	300 x 1.065 x 230	300 x 1.065 x 230	300 x 1.065 x 230	300 x 1.065 x 230	
Sound pressure	Hi / Med / Lo	dB(A)	35 / 31 / 27	38 / 34 / 30	40 / 36 / 32	47 / 44 / 40	47 / 44 / 40	47 / 44 / 40		
Air volume	Hi / Med / Lo	m³/min	11,0 / 9,5 / 7,5	12,0 / 10,5 / 8,5	14,0 / 12,0 / 10,5	18,0 / 14,5 / 11,5	18,0 / 14,5 / 11,5	19,0 / 16,5 / 13,0		

4 Way 60x60 Cassette			S-36PY2E5A	S-45PY2E5A	S-50PY2E5A
Panel			CZ-KPY3A / CZ-KPY3B	CZ-KPY3A / CZ-KPY3B	CZ-KPY3A / CZ-KPY3B
Dimensions H x W x D	Indoor	mm	260 x 575 x 575	260 x 575 x 575	260 x 575 x 575
	Panel CZ-KPY3A	mm	31 x 700 x 700	31 x 700 x 700	31 x 700 x 700
	Panel CZ-KPY3B	mm	31 x 625 x 625	31 x 625 x 625	31 x 625 x 625
Sound pressure	Hi / Me / Lo	dB(A)	36 / 32 / 26	38 / 34 / 28	40 / 37 / 33
Air volume	Hi / Lo	m³/min	9,7 / 9,9	10,0 / 10,3	11,1 / 11,1

4 Way 90x90 Cassette			S-36PU2E5A	S-45PU2E5A	S-50PU2E5A	S-60PU2E5A	S-71PU2E5A	S-100PU2E5A	S-125PU2E5A	S-140PU2E5A
Panel			CZ-KPU3	CZ-KPU3	CZ-KPU3	CZ-KPU3	CZ-KPU3	CZ-KPU3	CZ-KPU3	CZ-KPU3
Dimensions	Indoor H x W x D	mm	256 x 840 x 840	256 x 840 x 840	256 x 840 x 840	256 x 840 x 840	256 x 840 x 840	319 x 840 x 840	319 x 840 x 840	319 x 840 x 840
	Panel H x W x D	mm	33,5 x 950 x 950	33,5 x 950 x 950	33,5 x 950 x 950	33,5 x 950 x 950	33,5 x 950 x 950	33,5 x 950 x 950	33,5 x 950 x 950	33,5 x 950 x 950
Sound pressure	Hi / Me / Lo	dB(A)	30 / 28 / 27	31 / 28 / 27	32 / 29 / 27	38 / 31 / 28	37 / 31 / 28	45 / 38 / 32	46 / 39 / 33	47 / 40 / 34
Air volume	Hi / Me / Lo	m³/min	14,5 / 13,0 / 11,5	15,5 / 13,0 / 11,5	16,5 / 13,5 / 11,5	21,0 / 16,0 / 13,0	22,0 / 16,0 / 13,0	36,0 / 26,0 / 18,0	37,0 / 27,0 / 19,0	38,0 / 29,0 / 20,0

Low Static Pressure Hide Away			S-36PN1E5A	S-45PN1E5A	S-50PN1E5A	S-60PN1E5A	S-71PN1E5A	S-100PN1E5A	S-125PN1E5A	S-140PN1E5A
Dimensions	H x W x D	mm	250 x 780 x 650	250 x 780 x 650	250 x 780 x 650	250 x 1.000 x 650	250 x 1.000 x 650	250 x 1.000 x 650	250 x 1.200 x 650	250 x 1.200 x 650
Sound pressure	Hi / Me / Lo	dB(A)	40 / 38 / 35	41 / 39 / 35	41 / 39 / 35	43 / 41 / 36	43 / 41 / 36	44 / 42 / 37	46 / 44 / 39	46 / 44 / 39
External static pressure	Hi / Me / Lo	Pa	80 / 50 / 10	80 / 50 / 10	80 / 50 / 10	80 / 50 / 10	80 / 50 / 10	80 / 50 / 10	80 / 50 / 10	80 / 50 / 10
Air volume	Hi / Lo	m³/min	14,0 / 14,0	16,0 / 16,0	16,0 / 16,0	22,0 / 22,0	22,0 / 22,0	36,0 / 36,0	38,0 / 38,0	40,0 / 40,0

Hide Away High Static Pressure			S-36PF1E5A	S-45PF1E5A	S-50PF1E5A	S-60PF1E5A	S-71PF1E5A	S-100PF1E5A	S-125PF1E5A	S-140PF1E5A
Dimensions	H x W x D	mm	290 x 800 x 700	290 x 800 x 700	290 x 800 x 700	290 x 1.000 x 700	290 x 1.000 x 700	290 x 1.400 x 700	290 x 1.400 x 700	290 x 1.400 x 700
Sound pressure	Hi / Me / Lo	dB(A)	33 / 29 / 25	34 / 30 / 26	34 / 30 / 26	35 / 32 / 26	35 / 32 / 26	38 / 34 / 31	39 / 35 / 32	40 / 36 / 33
External static pressure	Hi / Me / Lo	Pa	150 / 70 / 10	150 / 70 / 10	150 / 70 / 10	150 / 70 / 10	150 / 70 / 10	150 / 100 / 10	150 / 100 / 10	150 / 100 / 10
Air volume	Hi / Me / Lo	m³/min	14,0 / 13,0 / 10,0	14,0 / 13,0 / 10,0	16,0 / 15,0 / 12,0	21,0 / 19,0 / 15,0	21,0 / 19,0 / 15,0	32,0 / 26,0 / 21,0	34,0 / 29,0 / 23,0	36,0 / 32,0 / 25,0

Ceiling			S-36PT2E5A	S-45PT2E5A	S-50PT2E5A	S-60PT2E5A	S-71PT2E5A	S-100PT2E5A	S-125PT2E5A	S-140PT2E5A
Dimensions	H x W x D	mm	235 x 960 x 690	235 x 960 x 690	235 x 960 x 690	235 x 1.275 x 690	235 x 1.275 x 690	235 x 1.590 x 690	235 x 1.590 x 690	235 x 1.590 x 690
Sound pressure	Hi / Me / Lo	dB(A)	35 / 32 / 30	38 / 33 / 30	38 / 33 / 30	39 / 36 / 33	39 / 36 / 33	42 / 38 / 35	45 / 40 / 37	47 / 41 / 37
Air volume	Hi / Me / Lo	m³/min	14,0 / 12,0 / 10,5	15,0 / 12,5 / 10,5	15,0 / 12,5 / 10,5	20,0 / 17,0 / 14,5	21,0 / 18,0 / 15,5	30,0 / 25,0 / 23,0	34,0 / 28,0 / 24,0	35,0 / 29,0 / 25,0

Compatible Outdoor Units			7,1kW	10,0kW	12,5kW	14,0kW	7,1kW	10,0kW	12,5kW	14,0kW	20,0kW	25,0kW
Outdoor Unit Single Phase			U-71PEY2E5 <sup>1</sup>	U-100PEY1E5	U-125PEY1E5	—	U-71PE1E5A	U-100PE1E5A	U-125PE1E5A	U-140PE1E5A	—	—
Outdoor Unit Three Phase			—	U-100PEY1E8	U-125PEY1E8	U-140PEY1E8	U-71PE1E8A	U-100PE1E8A	U-125PE1E8A	U-140PE1E8A	U-200PE2E8A	U-250PE2E8A
Cooling capacity	Nominal (Min - Max)	kW	7,1 (2,0 - 7,7)	10,0 (2,7 - 11,5)	12,5 (3,8 - 13,5)	14,0 (3,3 - 15,5)	7,1 (2,5 - 8,0)	10,0 (3,3 - 12,5)	12,5 (3,3 - 14,0)	14,0 (3,3 - 15,5)	20,0 (6,0 - 22,4)	25,0 (6,0 - 28,0)
Heating capacity	Nominal (Min - Max)	kW	7,1 (1,8 - 8,1)	10,0 (2,1 - 13,8)	12,5 (3,4 - 15,0)	14,0 (4,1 - 16,0)	8,0 (2,0 - 9,0)	11,2 (4,1 - 14,0)	14,0 (4,1 - 16,0)	16,0 (4,1 - 18,0)	21,8 (6,0 - 22,4)	28,0 (6,0 - 31,5)
Power source	Single Phase	V	220 / 230 / 240	220 / 230 / 240	220 / 230 / 240	—	220 / 240	220 / 240	220 / 240	220 / 240	—	—
	Three Phase	V	—	380 / 400 / 415	380 / 400 / 415	380 / 415	380 / 415	380 / 415	380 / 415	380 / 415	380 / 415	380 / 415
Connection		mm²	2,50	4,00	6,00	2,50	2 x 1,5 or 2,5	2 x 1,5 or 2,5	2 x 1,5 or 2,5	2 x 1,5 or 2,5	—	—
Air volume	Cooling / Heating	m³/min	39,0	76,0 / 67,0	80,0 / 73,0	135,0 / 120,0	60,0 / 60,0	110,0 / 95,0	130,0 / 110,0	135,0 / 120,0	129,0	118,0
Sound pressure	Cooling / Heating (Hi)	dB(A)	47 / 49	54 / 54	56 / 56	54 / 53	48 / 50	52 / 52	53 / 53	54 / 55	57 / 57	57 / 58
	Cooling / Heating (Hi)	dB	70 / 70	70 / 70	73 / 73	71 / 70	65 / 67	69 / 69	70 / 70	71 / 71	72	73
Dimensions	H x W x D	mm	619 x 799 x 299	996 x 940 x 340	996 x 940 x 340	1.416 x 940 x 340	996 x 940 x 340	1.416 x 940 x 340	1.416 x 940 x 340	1.416 x 940 x 340	1.526 x 940 x 340	1.526 x 940 x 340
Net weight		kg	40	73	85	98	69	98	98	98	118	128
Piping connections	Liquid pipe	Inch (mm)	3/8 (9,52)	3/8 (9,52)	3/8 (9,52)	3/8 (9,52)	3/8 (9,52)	3/8 (9,52)	3/8 (9,52)	3/8 (9,52)	3/8 (9,52)	1/2 (12,7)
	Gas pipe	Inch (mm)	5/8 (15,88)	5/8 (15,88)	5/8 (15,88)	5/8 (15,88)	5/8 (15,88)	5/8 (15,88)	5/8 (15,88)	5/8 (15,88)	1 (25,4)	1 (25,4)
Elevation difference (in/out)	Max	m	30	30	30	30	30	30	30	30	30	30
Piping length	Min - Max	m	5 - 50	5 - 50	5 - 50	5 - 50	5 - 50	5 - 75	5 - 75	5 - 75	5 - 100	5 - 100
Refrigerant (R410A)		kg / TCO <sub>2</sub> Eq.	1,95 / 4,0716	2,60 / 5,4288	3,20 / 6,6816	3,40 / 7,0992	2,35 / 4,9068	3,40 / 7,0992	3,40 / 7,0992	3,40 / 7,0992	5,60 / 11,6928	6,40 / 13,3632
Operating range	Cooling Min - Max	°C	-10 ~ +43	-10 ~ +43	-10 ~ +43	-10 ~ +43	-15 ~ +46	-15 ~ +46	-15 ~ +46	-15 ~ +46	-15 ~ +46	-15 ~ +46
	Heating Min - Max	°C	-15 ~ +24	-15 ~ +24	-15 ~ +24	-15 ~ +24	-20 ~ +24	-20 ~ +24	-20 ~ +24	-20 ~ +24	-20 ~ +15	-20 ~ +15

<sup>1)</sup> Tentative data.  
U-11E5 Single Phase // U-11E8 Three Phase



Optional Controller.  
Wired remote controller  
CZ-RTCA  
Compatible with Econavi



Optional Controller.  
Timer remote controller  
CZ-RTCA



Optional Controller.  
Wireless remote controller  
CZ-RWSK2



Optional Controller.  
Simplified remote controller  
CZ-RE2C2



U-71PEY2E5



U-100PEY1E5



U-125PEY1E8



U-140PEY1E8



U-125PE1E8A



U-140PE1E8A



U-200PE2E8A



U-250PE2E8A

Compatible with all Panasonic connectivity solutions. For detailed information go to the Control Systems section.

167

# PANASONIC VENTILATION SOLUTIONS



## Panasonic ventilation solutions for maximum savings and easy integration.

### AHU Kit connects PACi outdoor units to Air Handling Units system

Heat exchanger, Fan & Fan motor to be mounted in AHU Kit shall be provided in the field. AHU connection Kit (field supplied) AHU Kit system. (Contents of kit: Control for PCB, expansion valve, sensors).



Application: Hotels, offices, server rooms or all large buildings where air quality control such as humidity control and fresh air and is needed.

AHU Kit combine air conditioning and fresh air in just one solution.

The Panasonic AHU Kits offer a wealth of connectivity possibilities so can be easily integrated into many systems.

Application: Hotels, offices, server rooms or all large buildings where air quality control such as humidity control and fresh air and is needed. Besides the advantages in terms of indoor air quality, air conditioning offers also an energy saving potential. For example, while uncontrolled ventilation through open windows leads to large amounts of heat being lost to the outside during the heating season or gained from the outside during the cooling season, air conditioning systems provide possibilities to utilize the extra "free" energy in heat recovery modules so that overall operating costs will be reduced.

The larger the area of the comfort range, the better the energy saving opportunities.

### Electric Air Curtain

Air curtains can help reduce whole building heating or cooling costs by helping to stop heat escaping the building or keeping cooled air in. Panasonic offers two sizes - 900mm and 1200mm electric air curtains. Ideal for separating areas and energy saving.



#### Technical focus.

- 2 sizes: 900mm and 1.200mm
- Powerful air flow (10 m/s)
- Very low noise, only 42 dB

#### Comfort.

- Easy redirection of airflow by means of the manual deflector

#### Ease of use.

- Speed selector (high and low) on the unit itself

#### Easy installation and maintenance.

- Simple installation
- Compact dimensions improve installation and positioning in any space

### Air Curtain with DX Coil

#### Highly efficient heating effect.

The combined air stream, which has a desirable low air current induction factor (mixing factor), can carry the selected initial temperature effect over long distances, and will reach the floor area while still at room temperature. This is necessary to avoid cooling down the interior spaces.



The Panasonic range of air curtains is designed for smooth operation and efficient performance. Air curtains produce a continuous stream of air blown from the top to the bottom of an open doorway and create a barrier that people and products can flow across, but air can't. Designed to improve energy efficiency, minimise heat loss from a building, and to allow retailers to keep doors open to encourage customers, our Air Curtains are suitable for connection to both VRF and PACi Systems.

Heating capacity comparison: Electrical air curtain / Panasonic air curtain

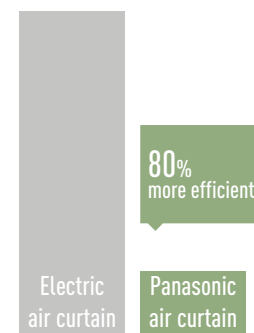

\* With the U-100PE1ESA on the PAW-20PAIRC-MS. Calculation method: Taking as consideration SCOP of the Panasonic combination of 6.0. If 100 is the energy needed for a air curtain, Panasonic Air curtain will need 1/(1-6)\*100=20.

			FY-10ESPNAH	FY-10ELPNAH
Width			900	1.200
Watts	Hi	W	71,5	96
	Lo	W	61,5	74
Current	Hi	A	0,40	0,54
	Lo	A	0,29	0,35
Air speed	Hi	m/s	13,0	13,1
	Lo	m/s	11,1	11,0
Air volume	Hi	m³/min	12,5	16,7
	Lo	m³/min	10,5	13,8
Noise lever	Hi	dB(A)	46	46
	Lo	dB(A)	42	41
Weight		kg	11	14

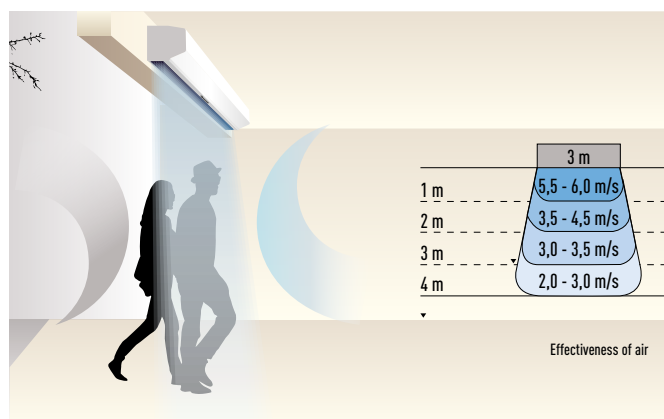

# AIR HANDLING UNIT KIT 10-25kW FOR PACi



## Panasonic AHU Kit, 10-25kW connected to PACi outdoor unit

The new Air Handling Unit Kit has been developed to better meet customer demand: IP 65 Box in order to be installed outside, 0-10V demand control\* and easy control by BMS

\* Only available with Elite PACi, up to from 6kW to 14kW.

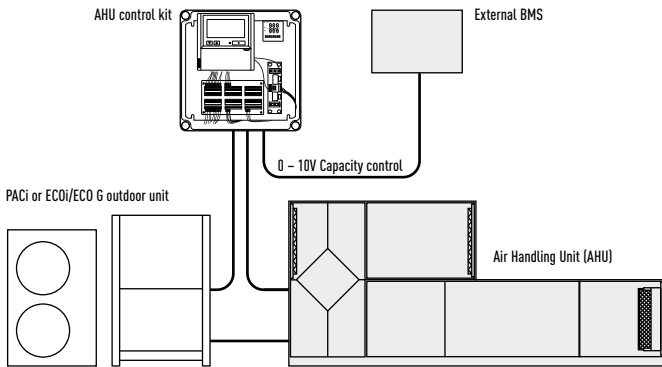

Demand control on the outdoor unit managed by external 0-10 V signal.

### Control option 1: PAW-280PAH2L

- The system's control is simple: control of actual suction temperature vs. set point
- Control works in the same way as that of any indoor unit
- Fan signal issued by the PCB (OFF while defrosting, for instance)

### Control option 2: PAW-280PAH2

- System control by probe located at air intake. Sensor works as a 0-10V control thermostat which manages the set point temperature. Control to prevent cold draughts.
- All signals as per standard

### Control option 3: PAW-280PAH2

- System control by external environment probe. Sensor works as a 0-10V control thermostat which manages the set point temperature. Enhances efficiency by adjusting capacity to the ambient temperature and enhances comfort as well.
- All signals as per standard

### Control option 4: PAW-280PAH2

- System control by a 0-10V control working from an external BMS that manages the set point for the temperature or the capacity. Enhances efficiency by adjusting capacity to the ambient temperature and enhances comfort as well.
- All signals as per standard

## Main components of mechanical ventilation systems

The main components of a mechanical ventilation system are the following: Air Handling Unit (AHU), air ducts and air distribution elements.

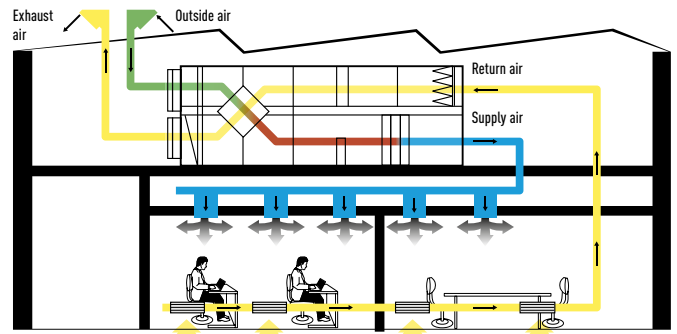

## 0-10V control

With the 0-10 v demand control the capacity of the outdoor unit can be controlled by 20 steps.

With the included resistance. 0-10V control scheme with 10V= maximum capacity

Input Voltage* (V)	0 - 0,55	1,1	1,65	2,2	2,8	3,35	3,9	4,45	5,0	5,55	6,1	6,65	7,2	7,8	8,35	8,9	9,45	10,0
Demand (% of nominal current)	Stop <sup>1</sup>	40	45	50	55	60	65	70	75	80	85	90	95	100	105	110	115	No limit / Full capacity <sup>2</sup>

When you remove the resistance. 0-10V control scheme with 10V= Thermo-Off

Input Voltage* (V)	0 - 0,5	1,0	1,5	2,0	2,5	3,0	3,5	4,0	4,5	5,0	5,5	6,0	6,5	7,0	7,5	8,0	8,5	9,0	9,5 - 10,0
Demand (% of nominal current)	Stop <sup>1</sup>	40	45	50	55	60	65	70	75	80	85	90	95	100	105	110	115	No limit <sup>2</sup>	Thermo-Off <sup>3</sup>

\* If a voltage range (0 - 0,5 or 9,5 - 10,0V) is indicated, the applied voltage must be within the given limits. However, if a single value (e.g. 1,0V) is indicated, the applied voltage must be within +/-0,1V of the given value to achieve the assigned demand setting.  
 Examples: "Stop" can be achieved with any analogue input value greater than 0V and less than or equal to 0,5 V; 40% demand can be achieved with any analogue input value greater than or equal to 0,9V and less than or equal to 1,1V etc.  
 1) Stop: AHU system / indoor unit is completely switched off.  
 2) No Limit: No restrictions applied by BMS to AHU system / indoor unit performance (equivalent to "full-load operation" of AHU system / indoor unit.  
 3) Thermo-Off: No cooling / heating operation (compressor is switched off; however, the fans may still be operating). For example, forced Thermostat-Off mode can be used for free cooling.

## Optional parts: Following functions are available by using different control accessories:

### CZ-RTC4 Timer remote controller.

- Operation-ON/OFF
- Mode select
- Temperature setting

\* Fan operation signal can be taken from the PCB.

### CZ-CAPBC2 Mini seri-para I/O unit (advanced version only).

- Easy integration in external AHU control systems and BMS
- Demand control: 40 to 115 % (5 % steps) of nominal current by 0-10 V input signal\*
- Target temperature setting by 0-10 V or 0-140 Ω input signal\*
- Room supply air temperature output by 4-20 mA signal
- Mode select or/and ON/OFF control
- Fan operation control
- Operation status output/ Alarm output
- Thermostat ON/OFF control

\* Demand control by external BMS cannot be combined with the demand control or target temperature setting accomplished by the thermostat. However, if simultaneous demand control and target temperature setting is needed, this can only be achieved by using a second (optional) CZ-CAPBC2 interface.

### PAW-OCT, DC12 V outlet. OPTION terminal.

- Output signal= Cooling/Heating/Fan status
- Defrost
- Thermostat-ON

### CZ-T10 terminal / PAW-T10 PCB to connect to T10 connector.

- A Dry contact PCB has been developed to easily control the unit
- Input signal operation ON/OFF
- Remote control prohibition
- Output signal Operation ON status maximum 230 V 5 A (NO/NC)
- Output signal alarm status max. 230 V 5 A (NO/NC)
- Alarm output (by DC12V)
- Additional available contacts:
  - External humidifier control (ON/OFF) 230 VAC 3 A
  - External fan control (ON/OFF) 12V DC
  - External filter status signal potential free
  - External float switch signal potential free
  - External leakage detection sensor or TH. OFF contact potential free (possible usage for external blow out temperature control)



### AHU Kit connects PACi outdoor units to Air Handling Units system

The Panasonic AHU Kits offer a wealth of connectivity possibilities so can be easily integrated into many systems.

Application: Hotels, offices, server rooms or all large buildings where air quality control such as humidity control and fresh air and is needed.

### 3 types of AHU Kit: Deluxe, Medium and Light.

Model Code	IP 65	0-10V demand control*	Outdoor temperature shift compensation. Cold draft prevention
PAW-280PAH2	Yes	Yes	Yes
PAW-280PAH2M	Yes	Yes	No
PAW-280PAH2L	Yes	No	No

\* With CZ-CAPBC2.

#### System & regulations. System overview

- AHU Kit equipment (Field supplied)
- AHU Kit system controller (Field supplied)
- AHU Kit controller box (with control PCB)
- Thermistor for Gas pipe (E2)
- Thermistor for Liquid pipe (E1)
- Thermistor for Suction air
- Inter-unit wiring
- Outdoor unit

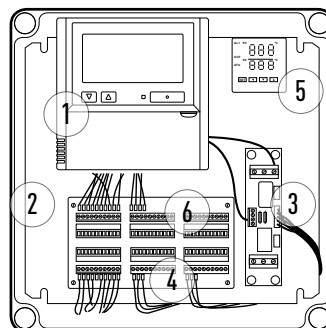
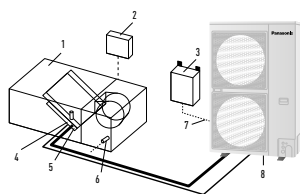

- Remote control CZ-RTC4
- New plastic IP 65 Box
- PAW-T10 PCB for dry contact
- 0-10V demand control PCB
- Intelligent thermostat for:
  - Cold draft prevention
  - Outdoor temperature shift compensation
- Terminal base for sensors and power supply

#### AHU Connection Kit

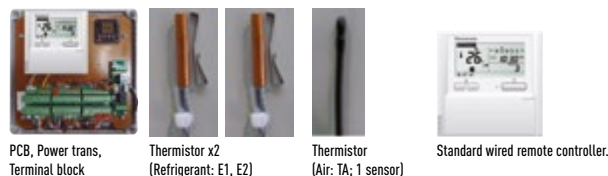

Optional Controller. Timer remote controller CZ-RTC4. Compatible with Econavi

AHU PACi Elite	Cooling capacity	Heating capacity	Air volume	Dimensions	Piping length	Elevation difference (in/out)
	Nominal kW	Nominal kW	High / Low m³/min	H x B x D mm	Min / Max m	Min / Max m
PAW-280PAH2	6 / 25	7 / 28	8,0 / 74,0	404 x 425 x 78	5 / 30*	10
PAW-280PAH2+PAW-280PAH2	50,0	56,0	38,0 / 148,0	404 x 425 x 78	5 / 30*	10

\* For U-200PE2E8A and U-250PE2E8A.

AHU connection kit / System combination		Air volume	Dimensions	Piping length	Elevation difference (in/out)	Piping connections		
Capacity kW	Outdoor unit	High / Low m³/min	H x B x D mm	Min / Max m	Min / Max m	Liquid pipe Tum (mm)	Gas pipe Tum (mm)	
5,0	U-50PE2E5A	PAW-280PAH2	8,0 / 13,0	404 x 425 x 78	5 / 30	10	1/4 (6,35)	1/2 (12,7)
6,0	U-60PE2E5A	PAW-280PAH2	9,0 / 16,0	404 x 425 x 78	5 / 30	10	3/8 (9,62)	5/8 (15,88)
7,5	U-71PE1E5A/U-71PE1E8A	PAW-280PAH2	12,0 / 25,0	404 x 425 x 78	5 / 30	10	3/8 (9,62)	5/8 (15,88)
10,0	U-100PE1E5A/U-100PE1E8A	PAW-280PAH2	14,0 / 33,0	404 x 425 x 78	5 / 30	10	3/8 (9,62)	5/8 (15,88)
12,5	U-125PE1E8A	PAW-280PAH2	19,0 / 35,0	404 x 425 x 78	5 / 30	10	3/8 (9,62)	5/8 (15,88)
14,0	U-140PE1E8A	PAW-280PAH2	19,0 / 35,0	404 x 425 x 78	5 / 30	10	3/8 (9,62)	5/8 (15,88)
20,0	U-200PE2E8A	PAW-280PAH2	28,0 / 66,0	404 x 425 x 78	5 / 70	10	3/8 (9,62)	1 (25,4)
25,0	U-250PE2E8A	PAW-280PAH2	38,0 / 74,0	404 x 425 x 78	5 / 70	10	1/2 (12,7)	1 (25,4)

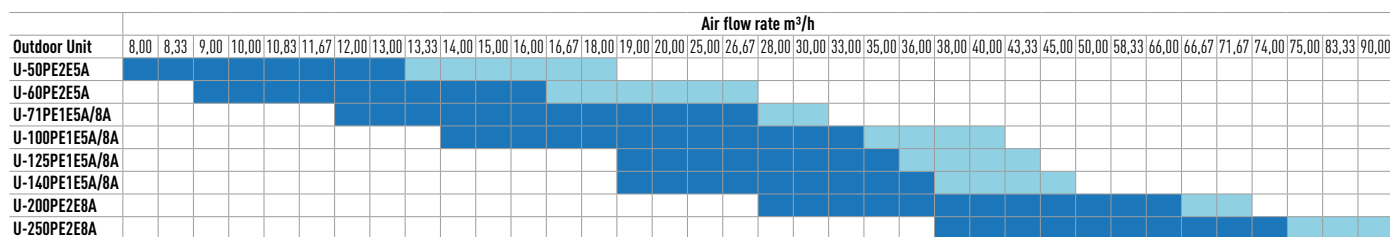

Standard condition in cooling mode intake air temperature. Rating Conditions: Cooling Indoor 27°C DB / 19°C WB.

Maximum condition in cooling mode intake air restriction temperature Min18°C DB / 13°C WB Max 32°C DB / 23°C WB

## AIR CURTAIN WITH DX COIL, CONNECTED TO THE VRF OR PACi SYSTEMS

High efficiency air curtain connected to your VRF installation. EC Fan motor for a smooth operation and efficient performance. 2 types of air flow available: Jet-Flow and Standard. Easy cleaning and servicing.

### Highly efficient heating effect

The combined air stream, which has a desirable low air current induction factor (mixing factor), can carry the selected initial temperature effect over long distances, and will reach the floor area while still at room temperature. This is necessary to avoid cooling down the interior spaces. Available in different lengths to suit requirements between 1 and 2,5 m, both air curtains have outlet grilles that can be adjusted to five different positions. The jet flow model can be installed up to a height of 3,5 m with the standard model up to 3,0 m. The outlet grilles can be easily adjusted into five positions to suit different installations requirements and the air filter can be accessed without the need for specialist tools.

- Super-efficient with new EC fan motor (40% lower running costs compared to a standard AC fan motor)
  - Easy Cleaning and Servicing
  - Can be connected to either Panasonic VRF or PACi systems
  - Built-in drain for cooling operation
  - Standard and Jet Flow air curtains can be controlled via Panasonic's range of remote internet controls
- The new standard and jet-flow models are ideal for connection to a ECOi or PACi system. With simple "plug and play" installation, both are fitted with an EC fan motor for a smooth operation and efficient performance. This new fan guarantees 40% lower running cost than with a standard AC fan motor. With air curtains often running for 12 hours a day as a minimum, this can lead to considerable savings.

### Internet Control

An app added to your tablet or smartphone or via the Internet allows you to control and manage the system remotely. There is also the option to integrate into existing BMS systems by using other Panasonic interfaces.

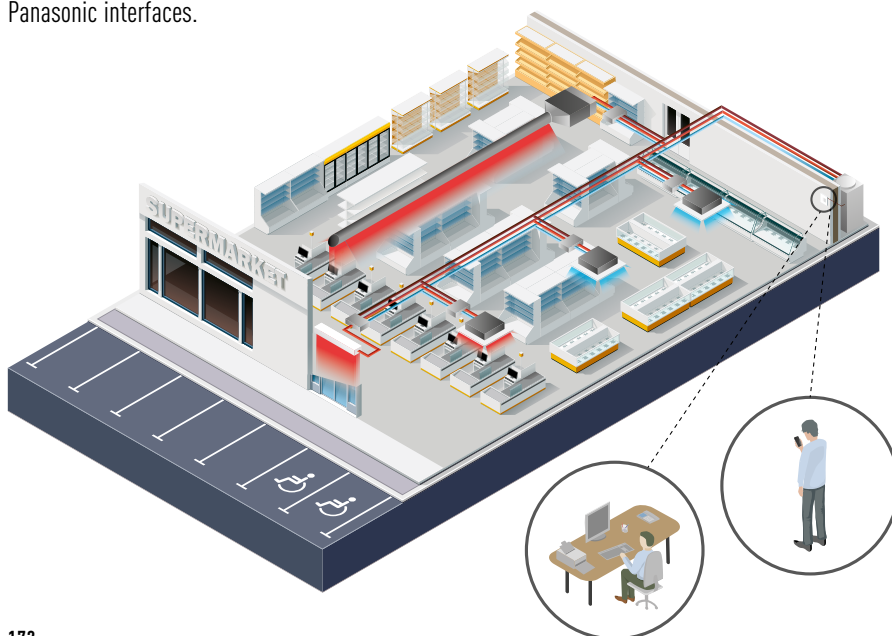

### Intelligent Operation

Our air curtains combine airflow and heating / cooling technology to ensure optimum comfort and energy efficiency whilst also creating an effective barrier between indoor and outdoor environments. Design and installation is key to achieving the correct height / temperature settings to achieve optimum performance. Our air curtains are designed to answer the demands of the retail, commercial and industrial markets.

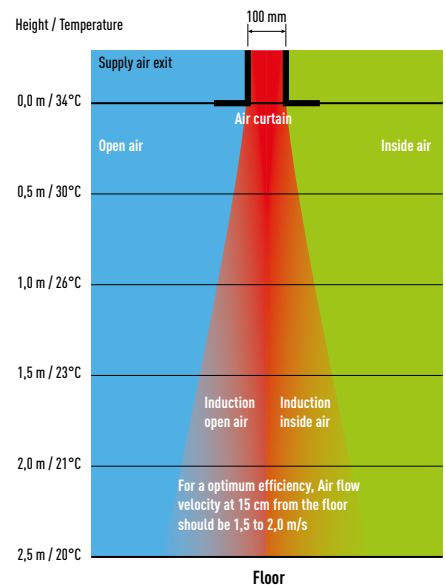

### How does it work?

Stale air from the room is taken in and ejected near the door. This creates a 'roll of air' that shields the door area, mixing with the colder incoming air. It then turns away from the door, back into the room and toward the intake screen, where it is partly drawn in again. This flow of air helps to create a barrier for heat loss yet at the same time refreshes room air

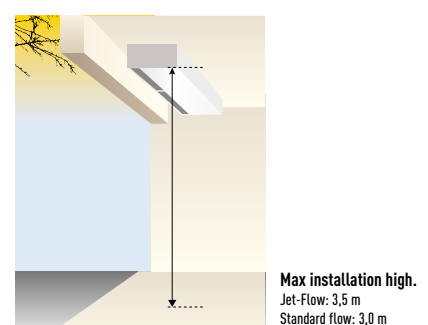

### Technical focus

- Save up to 40% Energy Costs by use of the integrated EC Fan Technology (Higher efficiency than conventional AC fan, soft start and longer motor duration)
- 3 Lengths of Air Curtains Jet-Flow, from 1,0 to 2,0 m and 2 lengths of Air Curtains Standard, 1,0 and 2,0 m
- Installation Height up to 3,5 m (Jet-Flow) and 3,0 m (Standard)
- Outlet Grilles can be adjusted in five positions, to suite different Indoor and installation requirements (Jet-Flow)
- Control with Panasonic Remote Control systems (optional)
- Direct integration to BMS by optional Panasonic Interfaces
- Drain included for cooling operation

### Features

#### Comfort.

- Easy redirection of Airflow by means of manual deflector (Jet-Flow)

#### Ease of use.

- Speed selector (high and low) on the unit itself

#### Easy installation and maintenance.

- Easy installation
- Compact dimensions improve installation and positioning (Jet-Flow)
- Easy cleaning of grid without opening of the unit

### Optimised airflow velocity

1. Energy losses, no air curtain installed
2. Too low velocity air curtain – air curtain not efficient
3. Optimum results with the Tekador air curtain connected to Panasonic VRF
4. Too high velocity air curtain – considerable turbulence, energy lost to the outside, air curtain not efficient

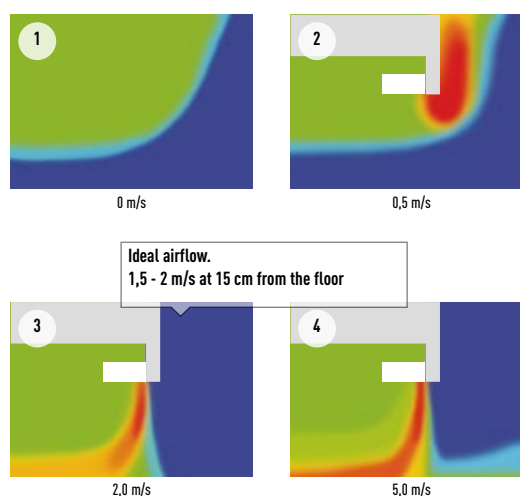

HP	4 HP			6 HP			8 HP					
Air Curtain	PAW-10PAIRC-MJ			PAW-15PAIRC-MJ			PAW-20PAIRC-MJ					
Air flow type	Jet-Flow			Jet-Flow			Standard					
Air Flow Length (A)	m			1,0			2,0					
Air volume	Hi / Med / Lo	m <sup>3</sup> /min		30,00 / 25,00 / 20,00		45,00 / 38,33 / 31,67		60,00 / 50,00 / 41,67				
Cooling capacity nominal <sup>1</sup>			kW		9,2		17,5		23,1			
Heating capacity with air in 20°C, air out 40°C			kW		11,9		17,9		23,9			
Heating capacity with air in 20°C, air out 35°C			kW		8,9		13,4		17,9			
Heating capacity with air in 20°C, air out 30°C			kW		5,9		8,9		11,9			
Max installation height	Good / Normal / Bad condition	m		3,5 / 3,1 / 2,7		3,5 / 3,1 / 2,7		3,5 / 3,1 / 2,7		3,0 / 2,7 / 2,4		
Refrigerant	R410A			R410A			R410A					
Liquid pipe / Gas pipe	Inch (mm)			3/8 (9,52) / 5/8 (15,88)			3/8 (9,52) / 3/4 (19,05)			3/8 (9,52) / 7/8 (22,22)		
Fan	230V / 50Hz / 1 / N / PE			230V / 50Hz / 1 / N / PE			230V / 50Hz / 1 / N / PE			230V / 50Hz / 1 / N / PE		
Fan type	EC			EC			EC					
Currenty	Hi / Med / Lo	A		2,1 / 0,8 / 0,3		2,8 / 1,1 / 0,4		4,2 / 1,6 / 0,6		2,1 / 0,8 / 0,3		
Electrical Consumption	Hi / Med / Lo	kW		0,44 / 0,17 / 0,06		0,59 / 0,23 / 0,08		0,89 / 0,34 / 0,12		0,44 / 0,17 / 0,06		
Protecting Fuse	A			M16A			M16A			M16A		
Noise	dB(A)			40-55			40-56			40-57		
Dimensions / Weight	W x H x D	mm / kg		1.210 x 260 x 590 / 70		1.710 x 260 x 590 / 100		2.210 x 260 x 590 / 138		1.210 x 260 x 490 / 60		
Outdoor combination with PACi Elite unit 40°C	U-100PE1E5A/8A			U-140PE1E5A/8A			U-200PE2E8A			U-100PE1E5A/8A		
Outdoor combination with PACi Standard unit 40°C	U-100PE1E5/8			—			—			U-100PE1E5/8		
Outdoor combination with PACi Elite unit 35°C	U-71PE1E5A/8A			U-100PE1E5A/8A			U-140PE1E5A/8A			U-71PE1E5A/8A		
Outdoor combination with PACi Standard unit 35°C	U-100PE1E5/8			U-100PE1E5/8			—			U-100PE1E5/8		
Outdoor combination with PACi Elite unit 30°C	U-50PE2E5A			U-100PE1E5A/8A			U-100PE1E5A/8A			U-50PE2E5A		
Outdoor combination with PACi Standard unit 30°C	U-60PE2E5			U-100PE1E5/8			U-100PE1E5/8			U-60PE2E5		

All combinations under rated conditions: Heating Outdoor +7°C DB/+6°C WB Indoor +20°C DB. In case of lower outdoor temperatures a higher capacity outdoor unit model may be necessary.

1) Rated Conditions Cooling Outdoor +35°C DB Indoor +27°C DB/+19°C WB, Discharge temperature <sup>3</sup> 16°C.



# R22 RENEWAL FAST, EASY TO INSTALL AND COST EFFECTIVE





¡An important drive to further reduce the potential damage to our ozone  
It is often said that legislation is ruling our lives but sometimes it is there to help save  
lives. R22 phase out can be described as one of these and from Jan 1st 2010 the use of  
Virgin (new) R22 refrigerant was banned within the European Community.

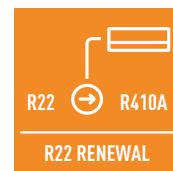

**Why renewal?**

Panasonic refrigerant oil doesn't react to the most common oil types used in air-conditioning systems. This ensures the mix of oil does not damage the units. Therefore installations are easier. All Panasonic PACi units can be installed in R22 pipings, no specific models are available. Up to 33 Bar! When there is any doubt about the strength of the piping, the maximum working pressure can be reduced to 33 Bar with a setting in the software of the outdoor unit.

**Panasonic are doing our part.**

Panasonic has developed a clean and cost effective solution to enable this latest legislation to be introduced with as minimum an effect on businesses and cash reserves as possible.

The Panasonic renewal system allows good quality existing R22 pipe work to be re-used whilst installing new high efficiency R410A systems.

By bringing a simple solution to the problem Panasonic can renew all Split Systems and PACi systems; and depending upon certain restrictions we don't even limit the manufacturer's equipment we are replacing.

By installing a new high efficiency Panasonic R410A system you can benefit from around 30% running cost saving compared to the R22 system.

1. Check the capacity of the system you wish to replace -
2. Select from the Panasonic range the best system to replace it with -
3. Follow the procedure detailed in the brochure and technical data.

**Measurement Procedure for Renewal**

Observe the following procedure when reusing the existing piping or carrying out renewal installation work.

Flowchart of existing piping measures criteria for PE1 / PE2 Type and PEY1 Type outdoor unit.

**R22 - The reduction of Chlorine critical for a cleaner future**

**Reuse of existing piping (Renewal Design & Installation)**

Notes on reuse of existing refrigerant piping. It is possible for each series of PE1 / PE2 type and PEY1 type outdoor unit to reuse the existing refrigerant piping without cleaning when obtained under certain conditions.

**Notes on renewal for simultaneous operation of multiple units**

Only main pipe is applicable for using the different diameter size. In case of different diameter size for the branch pipes, a new installation work for a standard size is necessary.

Be sure to use our genuine branch piping for refrigerant R410A.

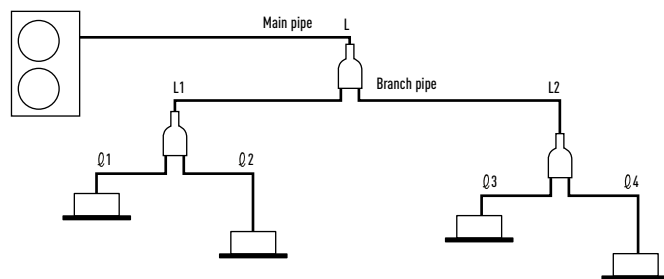

Notes on Renewal for Simultaneous Operation of Multiple Units

Capacity class	Standard liquid pipe size	Standard gas pipe size
Type 50	Ø 6,35	Ø 12,7
Type from 60 to 140	Ø 9,52	Ø 15,88
Type 200	Ø 9,52	
Type 250	Ø 12,7	Ø 25,4

- Only the main pipe L can be used among different diameter's existing piping
- Installation work as a standard size is capable for L1, L2, Q1 - Q4 piping
- Be sure to use our genuine branch piping for refrigerant R410A

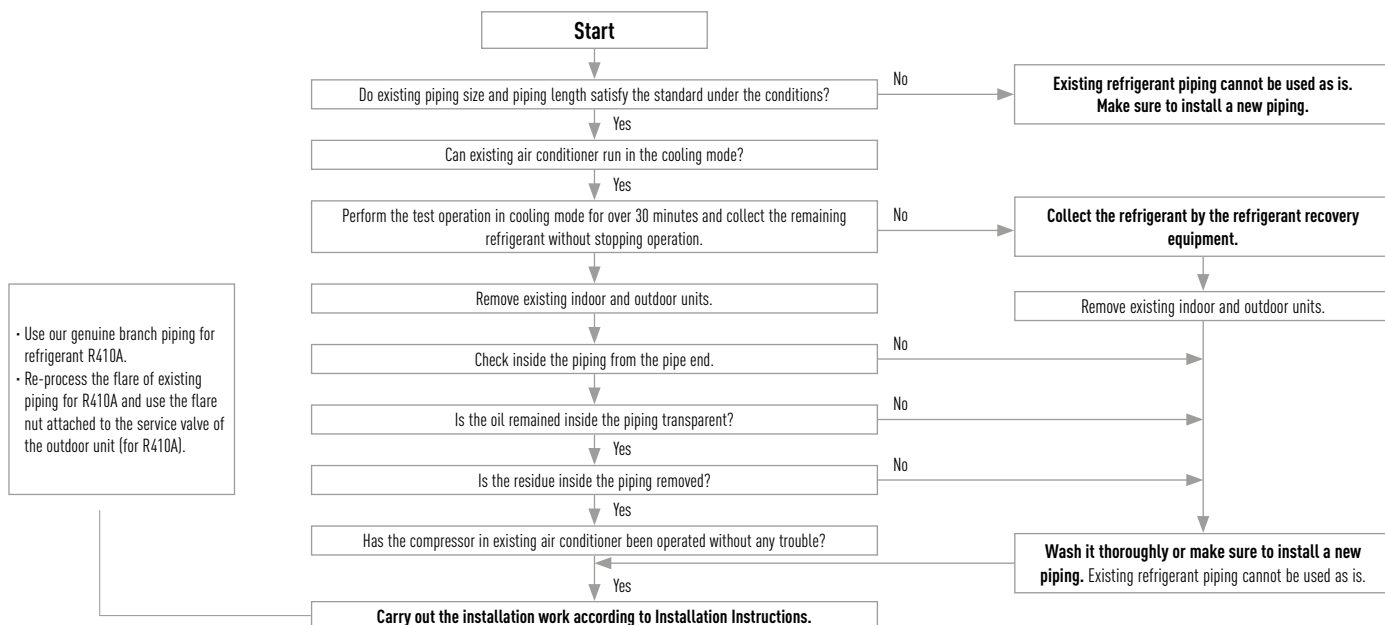

Prerequisite: • If the refrigerant used for the existing unit is other than R22, R407C and R410A, the existing refrigerant piping cannot be used. • If the existing unit has another use than air conditioning, then existing refrigerant piping cannot be used.

# ACCESSORIES & CONTROL

## Branch Pipes, Header

- CZ-P155BK1**  
Branch pipe.
- CZ-P224BK2BM**  
Branch pipe.
- CZ-P680BK2BM**  
Branch pipe (from 22.4kW to 68kW).
- CZ-P3HPC2BM**  
Header.

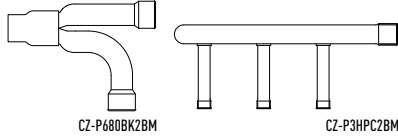

## Outdoor accessories

- PAW-WTRAY**  
Tray for condenser water compatible with base ground support.
- PAW-GRDSTD40**  
Outdoor elevation platform 400 x 900 x 400mm.
- PAW-GRDBSE20**  
Outdoor base ground support for noise and vibration absorption (600 x 95 x 130mm, 500kg).
- PAW-WPH7**  
Wind protection shield for U-50PE2E5A.
- PAW-WPH8**  
Wind protection shield for U-200PE2E8A, U-250PE2E8A.
- PAW-WPH9**  
Wind protection shield for U-.PE1E5A/8A 60 & 70, U-.PE1E5/8 100 & 125.
- PAW-WPH10**  
Wind protection shield for U-.PE1E5A/8A 100, 125 & 140, U-140PE1Y1E8.



## Panels

- CZ-KPU3**  
Normal panel for 90x90 Cassette PU2.
- CZ-KPU3A**  
Econavi panel for 90x90 Cassette PU2.
- CZ-KPY3A**  
Panel for 60x60 Cassette size 700 x 700mm.
- CZ-KPY3B**  
Panel for 60x60 Cassette size 625 x 625mm.



## Individual Controls

- CZ-RTC5A**  
Wired remote control with Econavi button.
- CZ-RTC4**  
Standard Wired remote control with Econavi button.
- CZ-RE2C2**  
Simplified remote control.
- CZ-RWSU3**  
Wireless remote control for 90x90 Cassette PU2.
- CZ-RWST3N**  
Wireless remote control for Ceiling.
- CZ-RWSK2**  
Wireless remote control for Wall mounted (and CZ-RWSC3).
- CZ-RWSC3**  
Wireless receiver kit (need CZ-RWSK2 separately).
- CZ-CSRC3**  
Temperature Remote sensor.



## Remote controller for Hotels with Dry Contacts

- PAW-RE2C3-WH**  
Stand-Alone with I/O White frame.
- PAW-RE2C3-GR**  
Stand-Alone with I/O Grey Frame.
- PAW-RE2C3-MOD-WH**  
Modbus RS-485 with I/O White frame.
- PAW-RE2C3-MOD-GR**  
Modbus RS-485 with I/O Grey frame.

- PAW-RE2C3-LON-WH**  
LonWorks TP/FT-10 with I/O White frame.
- PAW-RE2C3-LON-GR**  
LonWorks TP/FT-10 with I/O Grey frame.



## Centralised Controls

- CZ-64ESMC3**  
New System Controller with Schedule timer. Operation with various function from center station.
- CZ-ANC2**  
Central On/Off controller, up to 16 groups, 64 indoor units.
- CZ-ANC3**  
Central On/Off controller, up to 16 groups, 64 indoor units.
- CZ-256ESMC3**  
Simplified load distribution ratio (LDR) for each tenant. Intelligent Controller (Touch screen panel).

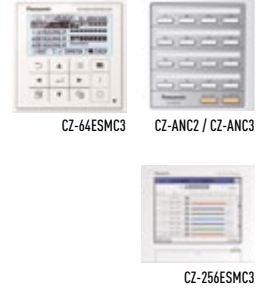

## Centralised Controls. BMS System. PC Base

- CZ-CSWKC2**  
PAIMS Basic software.
- CZ-CFUNC2**  
PAIMS Communication adaptor.
- CZ-CSWAC2**  
PAIMS Consumption calculation control.
- CZ-CSWBC2**  
PAIMS - BACnet interface.
- CZ-CSWGC2**  
PAIMS - Layout display.
- CZ-CSWWC2**  
PAIMS - Web application.



## Centralised Controls. Connection with 3rd Party Controller

- CZ-CAPDC2**  
Serial parallel device controlling outdoor units, up to 4 units.



## Centralised Controls. BMS System. PC Base

- CZ-CAPC2**  
Adaptor for On/off control of external devices.
- CZ-CAPC3**  
Adaptor for On/off control of external devices.
- CZ-CAPBC2**  
Mini series parallel device controlling indoor units, maximum 1 group and 8 indoor unit.
- CZ-CFUNC2**  
Communication Adaptor. Up to 128 groups. Controls 128 units.
- CZ-CFUSCC1**  
Panasonic AC Smart Cloud. Cloud internet control. Up to 128 groups. Controls 128 units.

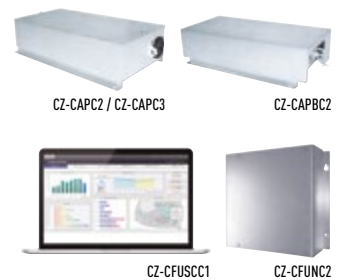

## Accessories Interfaces

- PA-RC2-WIFI-1**  
Interface for Inteshome for PACi.
- PAW-RC2-KNX-1i**  
KNX Interface.
- PAW-RC2-MBS-4**  
Modbus interface to control 4 indoor/groups.
- PAW-RC2-MBS-1**  
Modbus Interface.
- PAW-MBS-TCP2RTU**  
ModBus RTU Slave devices
- PAW-RC2-BAC-1**  
BACnet Interface.
- PAW-RC2-ENO-1i**  
EnOcean Interface.
- CZ-CAPRA1**  
Domestic with CZ-CNT port integration to PACi and ECOI.



### Accessories Cables

- CZ-T10**  
All T10 functions.
- PAW-FDC**  
Operate external EC fan.
- PAW-OCT**  
All Option monitoring signals.
- PAW-EXCT**  
Force Thermo OFF/leakage Detection.
- CZ-CAPEZ**  
Option monitoring signals wo. Fan.

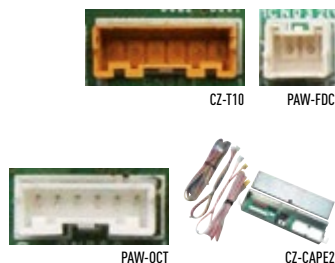

### Accessories PCB

- PAW-T10**  
All T10 functions.
- PAW-T10V**  
All T10 functions + powermonitoring.
- PAW-T10H**  
ON/OFF; Prohibit 5VDC & 230VAC.
- PAW-T10HW**  
ON/OFF; Prohibit 5VDC.
- PAW-PACR3**  
Redundancy of 2 or 3 systems; for PACi and ECOi.
- PAW-SERVER-PKEA**  
Redundancy of 2 units PKEA.

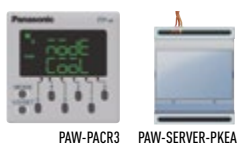

### Plenums

- CZ-DUMPA90MF2**  
Air Inlet Plenum S . .PF1E5A 60 & 71.
- CZ-DUMPA160MF2**  
Air Inlet Plenum S . .PF1E5A 100, 125 & 140.
- CZ-56DAF2**  
Air Outlet Plenum S . .PF1E5A 36, 45 & 50.
- CZ-90DAF2**  
Air Outlet Plenum S . .PF1E5A 60 & 71 .
- CZ-160DAF2**  
Air Outlet Plenum S . .PF1E5A 100, 125 & 140.
- CZ-TREMIESPW705**  
Air Outlet Plenum S-200PE2E5.
- CZ-TREMIESPW706**  
Air Outlet Plenum S-250PE2E5.



Plenum

### Other Accessory

- CZ-CNEXU1**  
Nanoe™ air purifying system for 90x90 Cassette PUZ.
- CZ-CENSC1**  
Econavi energy savings sensor.



CZ-CENSC1

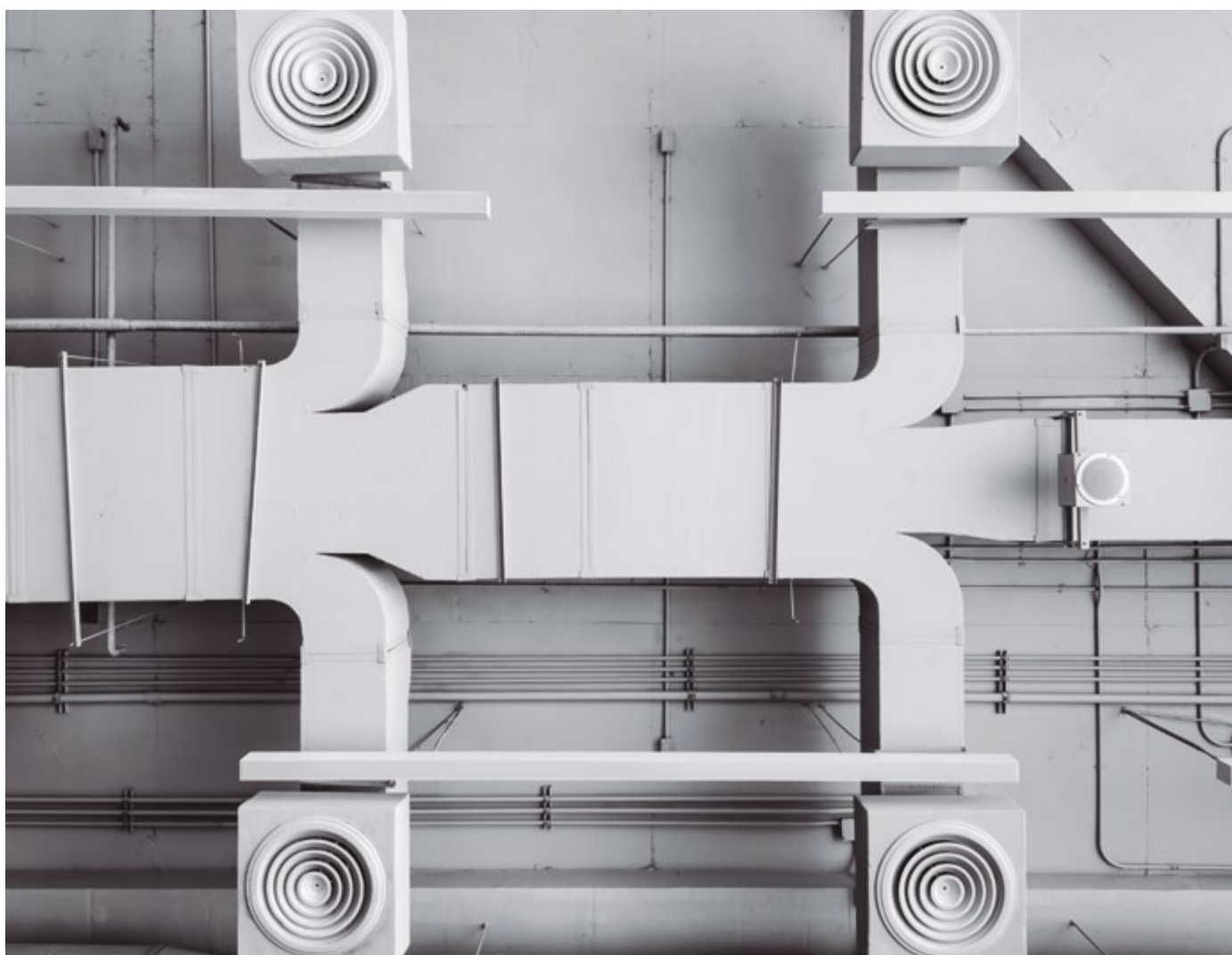

# DIMENSIONS

## Wall Mounted PKEA

CS-E9PKEA // CS-E12PKEA

CS-E15PKEA // CS-E18PKEA

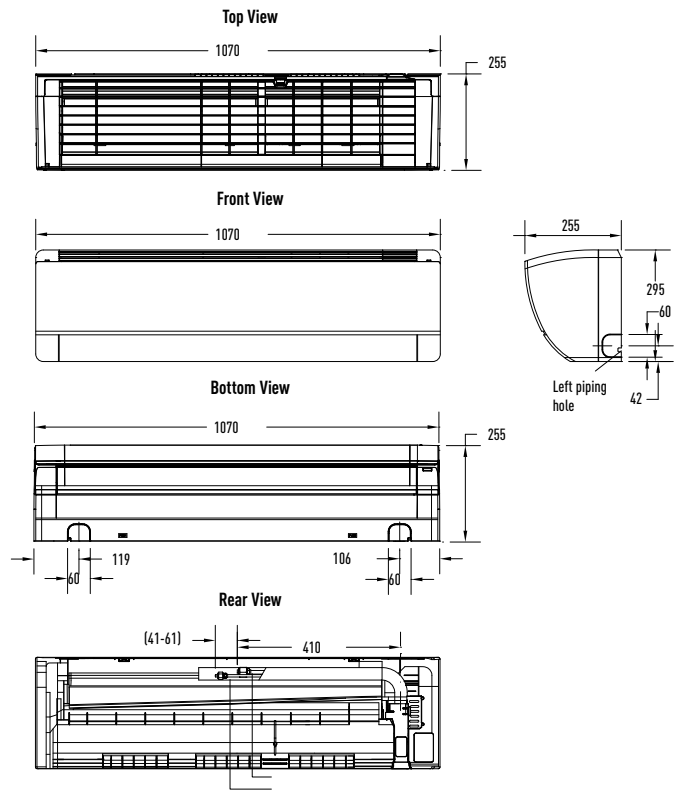
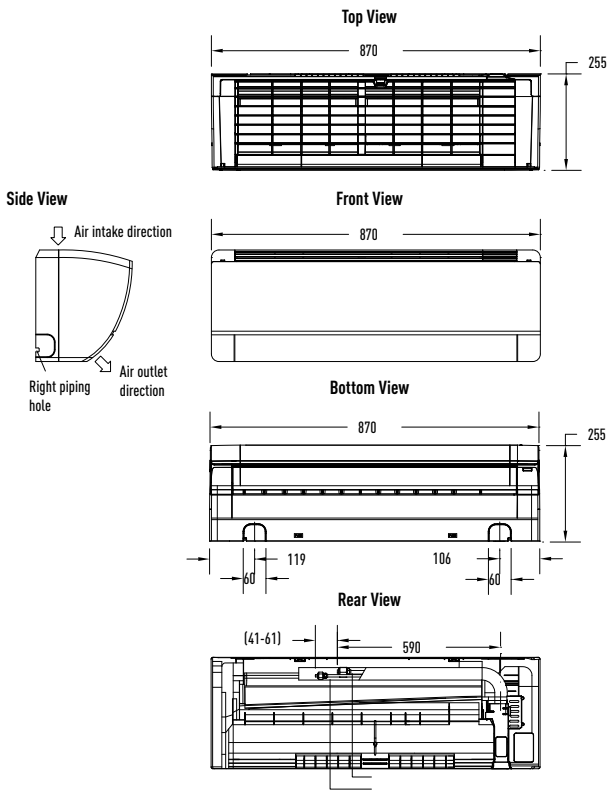

CU-E9PKEA // CU-E12PKEA

CU-E15PKEA // CU-E18PKEA

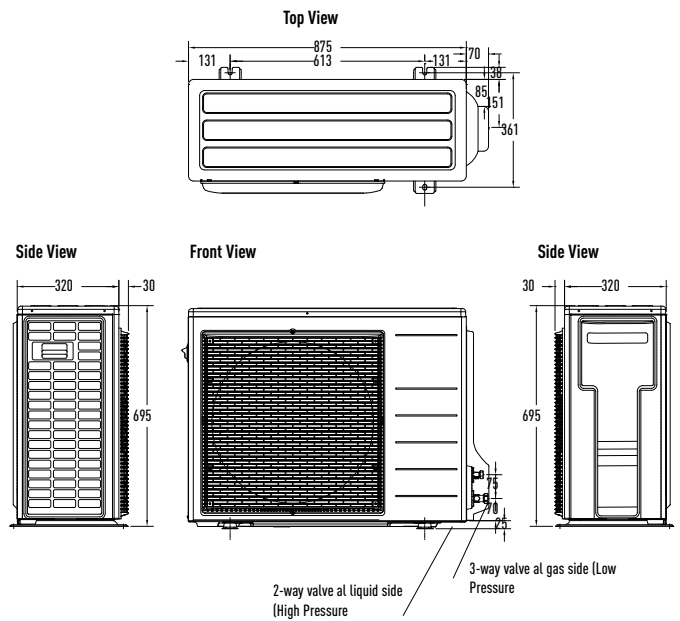
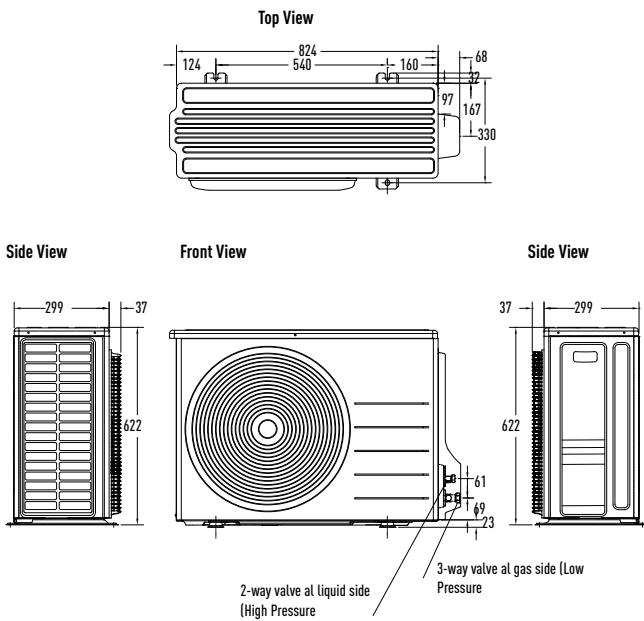

Dimensions: mm



### 4 Way 90x90 Cassette

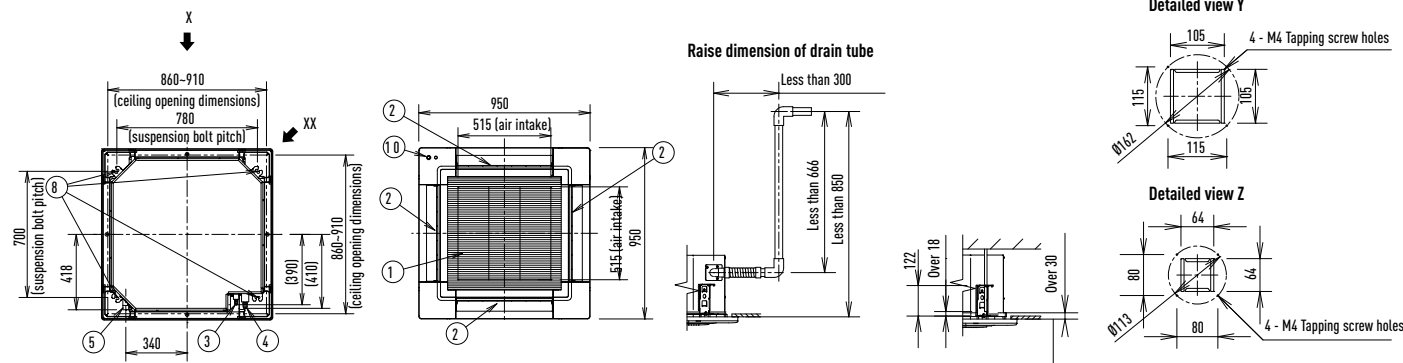

S-36PUZE5A // S-45PUZE5A // S-50PUZE5A // S-60PUZE5A // S-71PUZE5A

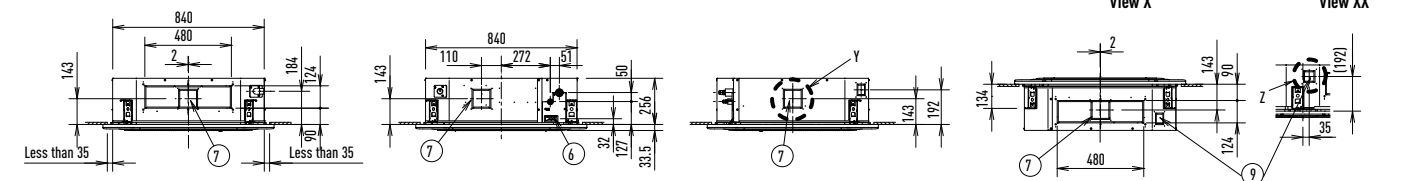

S-100PUZE5A // S-125PUZE5A // S-140PUZE5A

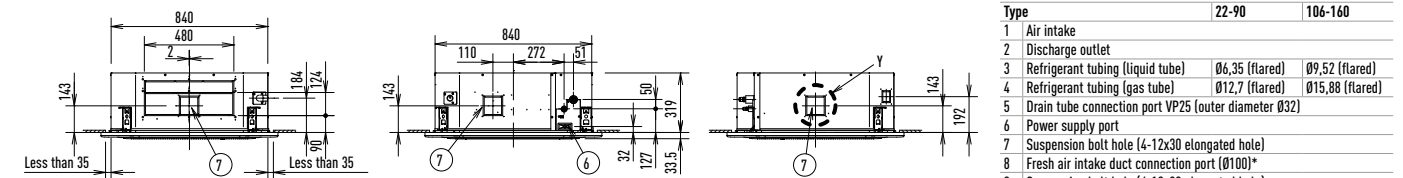

The length of the suspension bolts should be selected so that there is a gap of 30mm or more below the lower surface of the ceiling (18mm or more below the lower surface of the main unit), as shown in the figure at right. If the suspension bolt is too long, it will contact the ceiling panel and the unit cannot be installed.  
Filter dimension: 520 x 520 x 15mm.

Type	22-90	106-160
1 Air intake		
2 Discharge outlet		
3 Refrigerant tubing (liquid tube)	Ø 6,35 (flared)	Ø 9,52 (flared)
4 Refrigerant tubing (gas tube)	Ø 12,7 (flared)	Ø 15,88 (flared)
5 Drain tube connection port VP25 (outer diameter Ø32)		
6 Power supply port		
7 Suspension bolt hole (4-12x30 elongated hole)		
8 Fresh air intake duct connection port (Ø100)*		
9 Suspension bolt hole (4-12x30 elongated hole)		
10 Econavi sensor (Only CZ-KPU3A)		

\* Necessary to attach duct connecting flange(field supplied).

Unit: mm

### 4-Way 60x60 Cassette

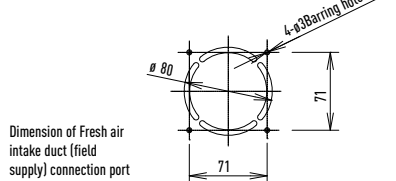
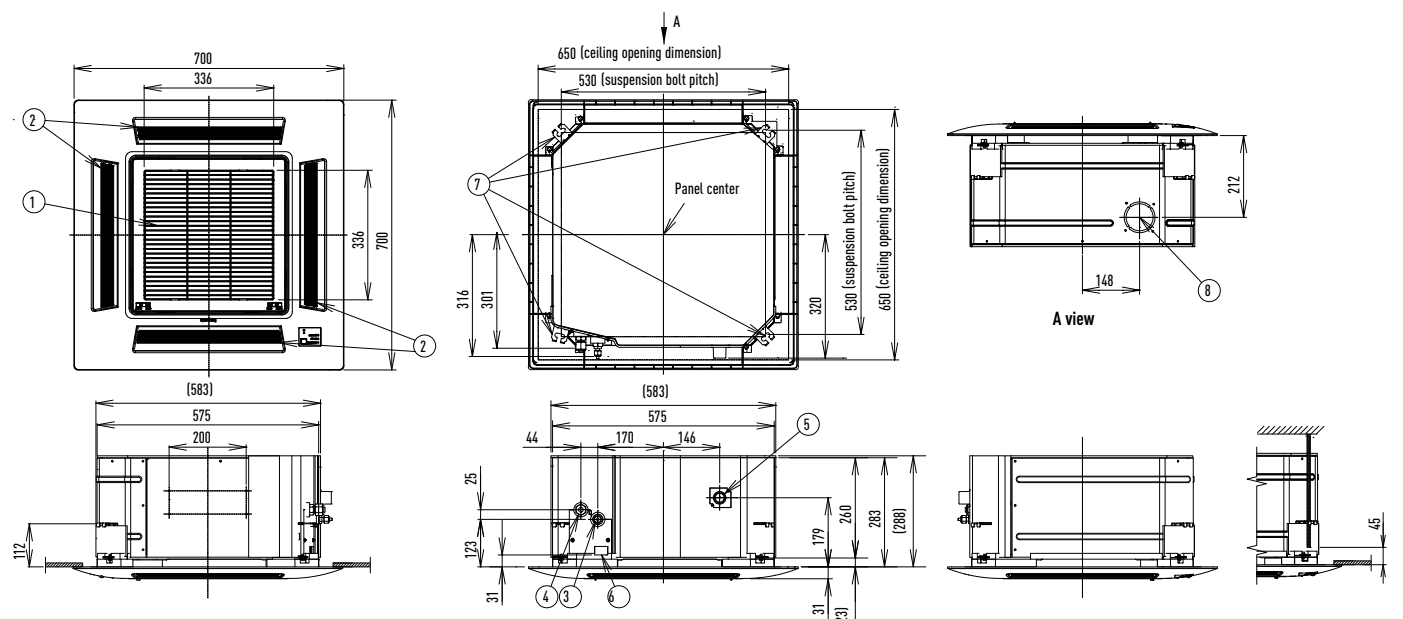

1 Air intake	
2 Discharge outlet	
3 Refrigerant tubing (liquid tube)	Ø 6,35 (flared)
4 Refrigerant tubing (gas tube)	Ø 12,7 (flared)
5 Drain tube connection port VP25	Outer dia. Ø 32
6 Power supply port	
7 Suspension bolt hole	4-11 x 26 hole
8 Fresh air intake duct connection port	Ø 80

Adjust the suspension bolt length so that the gap from the lower ceiling surface becomes 45mm or more, as shown in the figure at right. If the suspension bolts is too long, it will contact the ceiling panel and the unit cannot be installed.

Dimensions: mm

Ceiling

S-60PT2E5A // S-71PT2E5A

1	Drain port VP20	Inside diameter $\varnothing$ 26mm, drain hose supplied
2	Left drain position	
3	Refrigerant liquid tubing	$\varnothing$ 9.52, flare connection
4	Refrigerant gas tubing	$\varnothing$ 15.88, flare connection
5	Left side drain hose outlet port (cutout)	
6	Tubing hole on wall surface	$\varnothing$ 100mm
7	Upper side tubing port	
8	Right side drain hose outlet port (cutout)	
9	Wireless remote controller receiver installation location	

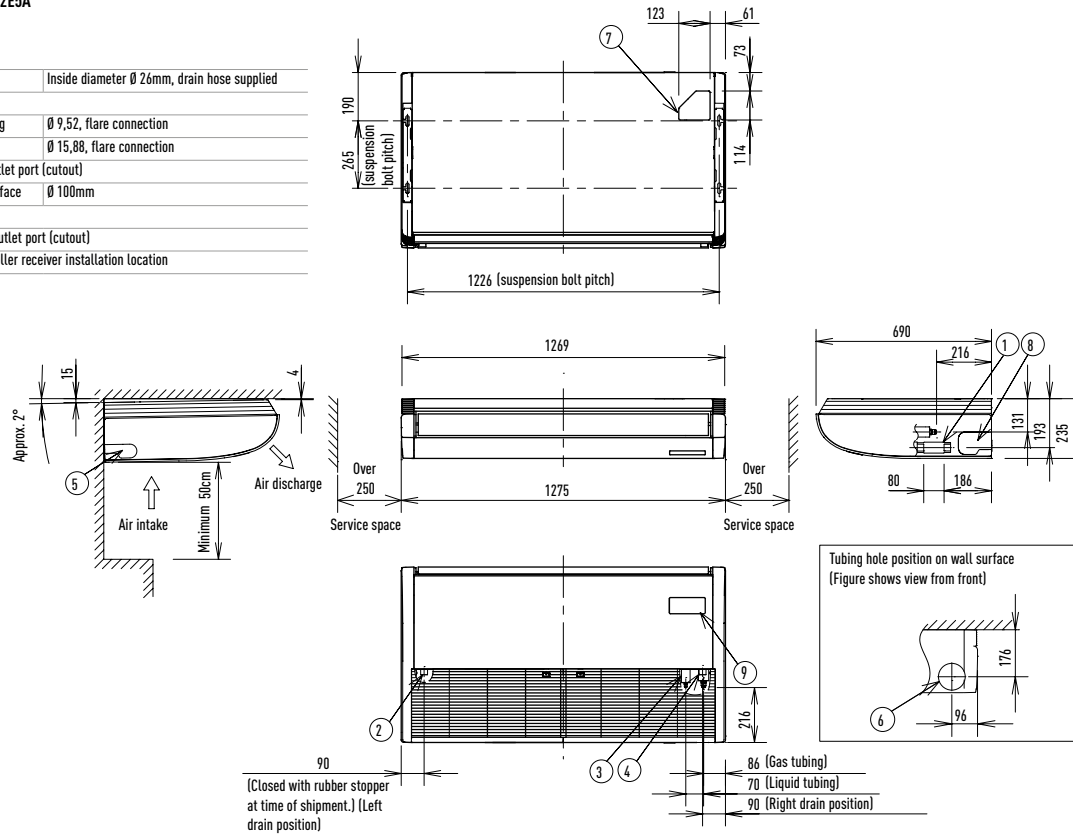

S-100PT2E5A // S-125PT2E5A // S-140PT2E5A

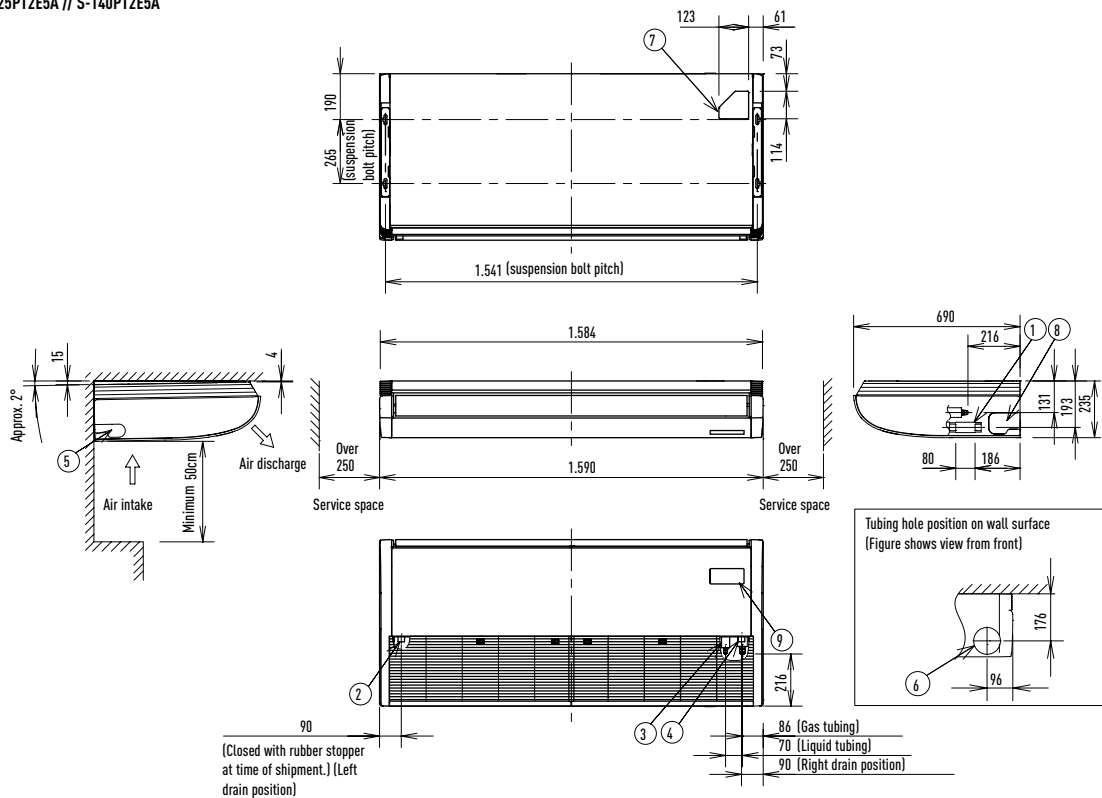

Dimensions: mm

### High Static Pressure Hide Away

S-36PF1E5A // S-45PF1E5A // S-50PF1E5A

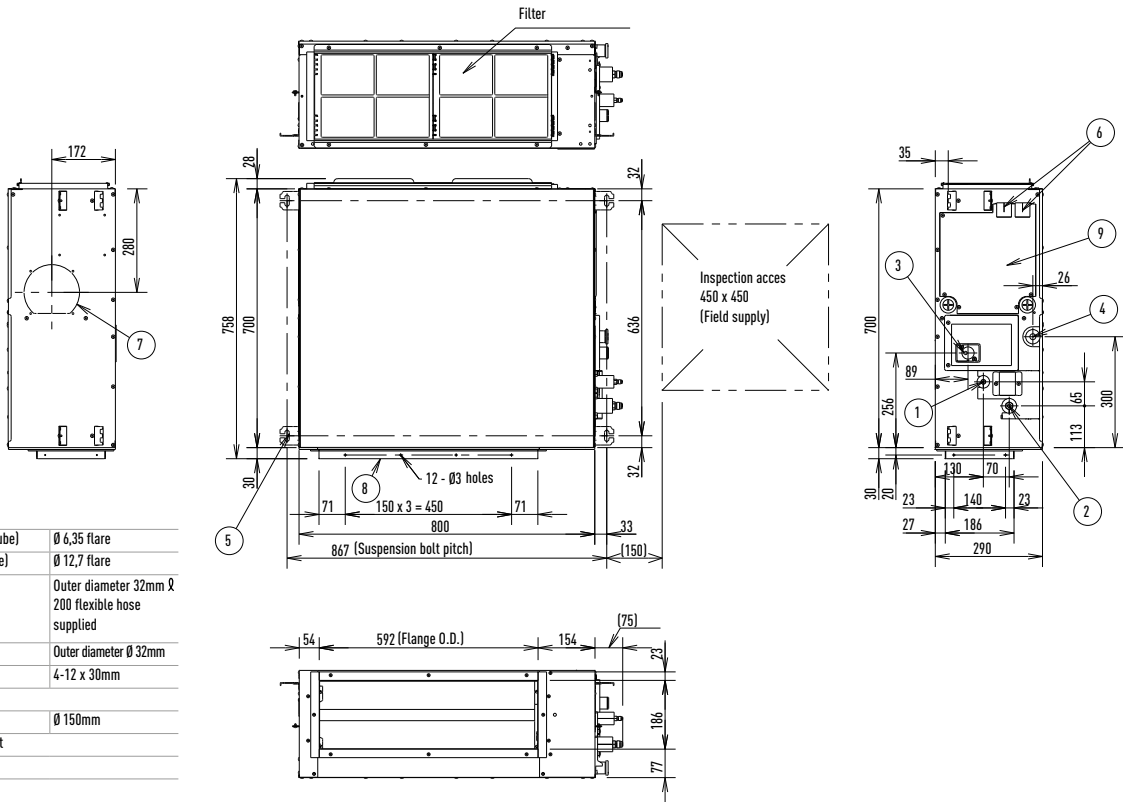

1 Refrigerant tubing joint (liquid tube)	Ø 6,35 flare
2 Refrigerant tubing joint (gas tube)	Ø 12,7 flare
3 Upper drain port VP25	Outer diameter 32mm & 200 flexible hose supplied
4 Bottom drain port VP 25	Outer diameter Ø 32mm
5 Suspension lug	4-12 x 30mm
6 Power supply outlet	
7 Fresh air intake port	Ø 150mm
8 Flange for flexible air outlet duct	
9 Electrical component box	

S-60PF1E5A // S-71PF1E5A

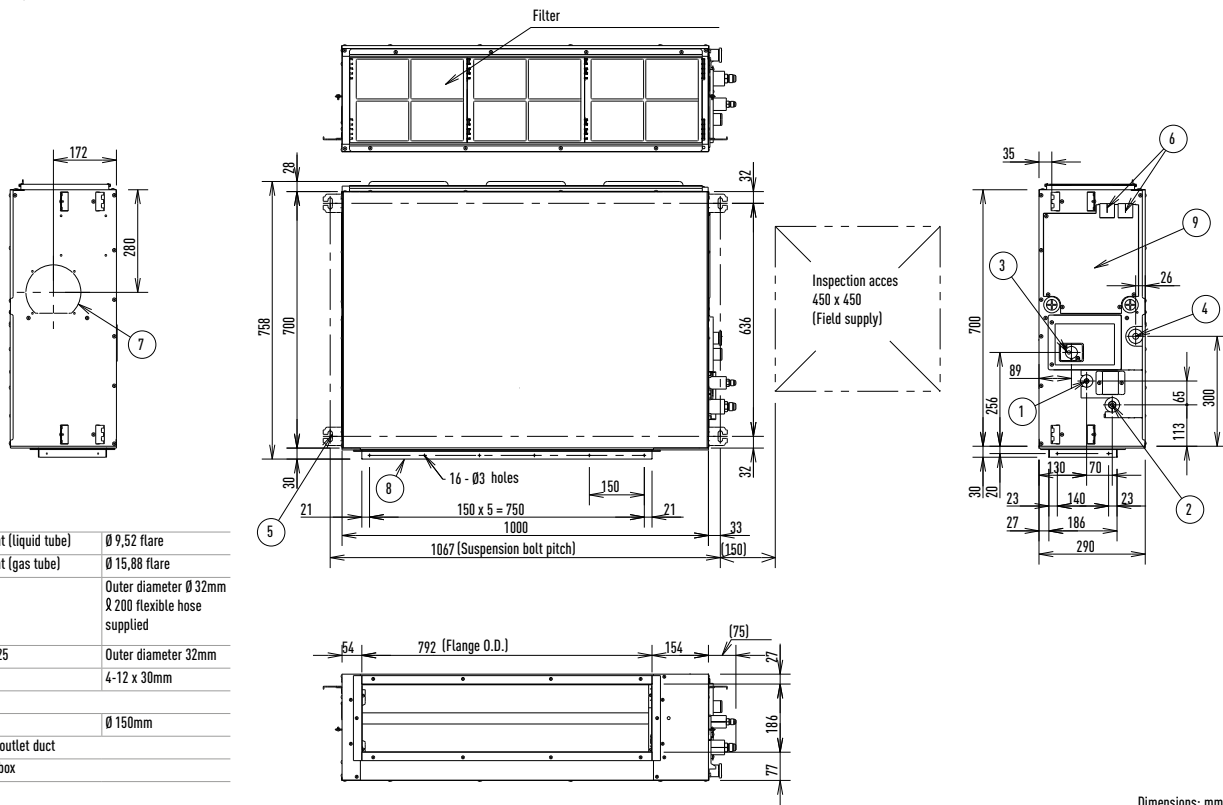

1 Refrigerant tubing joint (liquid tube)	Ø 9,52 flare
2 Refrigerant tubing joint (gas tube)	Ø 15,88 flare
3 Upper drain port VP25	Outer diameter Ø 32mm & 200 flexible hose supplied
4 Bottom drain port VP 25	Outer diameter 32mm
5 Suspension lug	4-12 x 30mm
6 Power supply outlet	
7 Fresh air intake port	Ø 150mm
8 Flange for flexible air outlet duct	
9 Electrical component box	

Dimensions: mm

High Static Pressure Hide Away (Cont.)

S-100PF1E5A // S-125PF1E5A // S-140PF1E5A

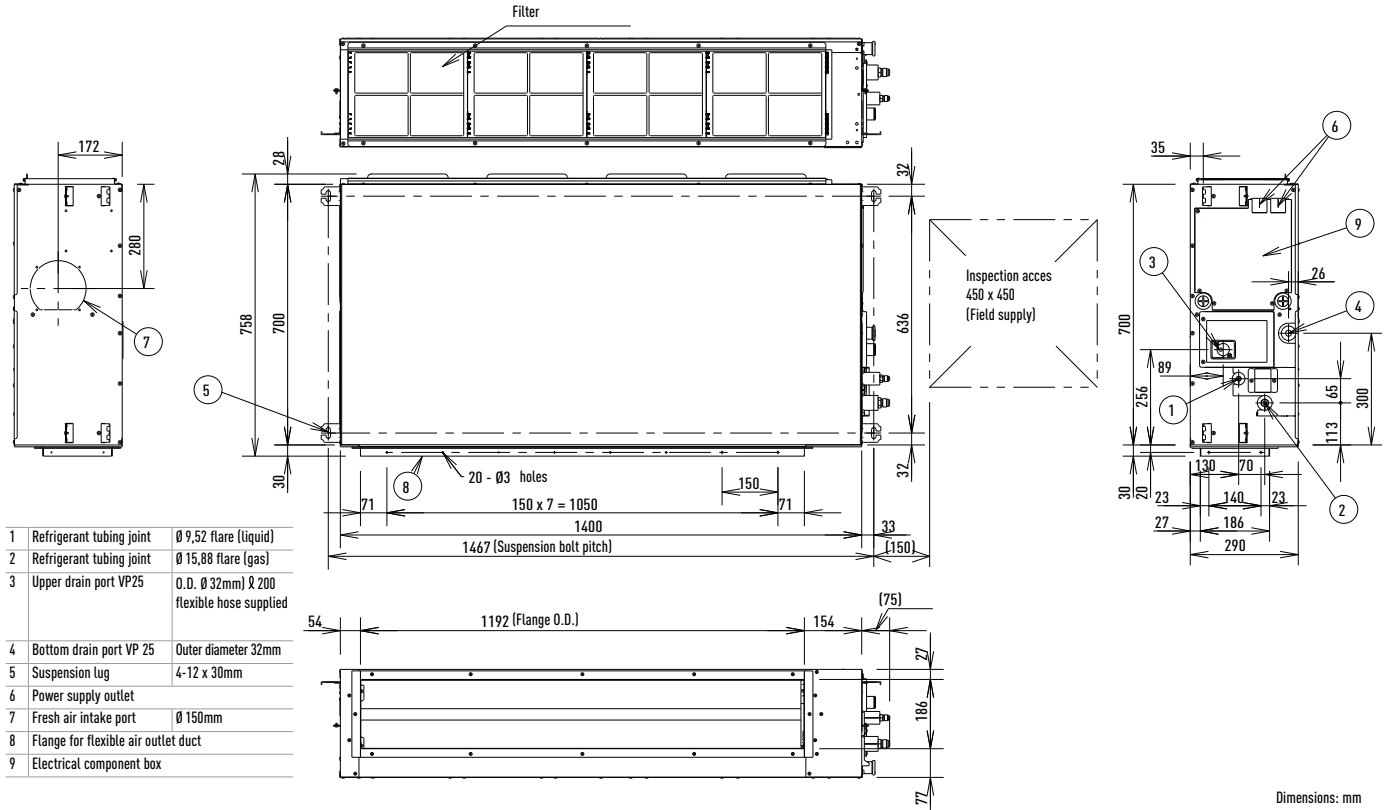

Dimensions: mm

Low Static Pressure Hide Away

S-36PN1E5A // S-45PN1E5A // S-50PN1E5A

S-60PN1E5A // S-71PN1E5A

S-100PN1E5A // S-125PN1E5A // S-140PN1E5A

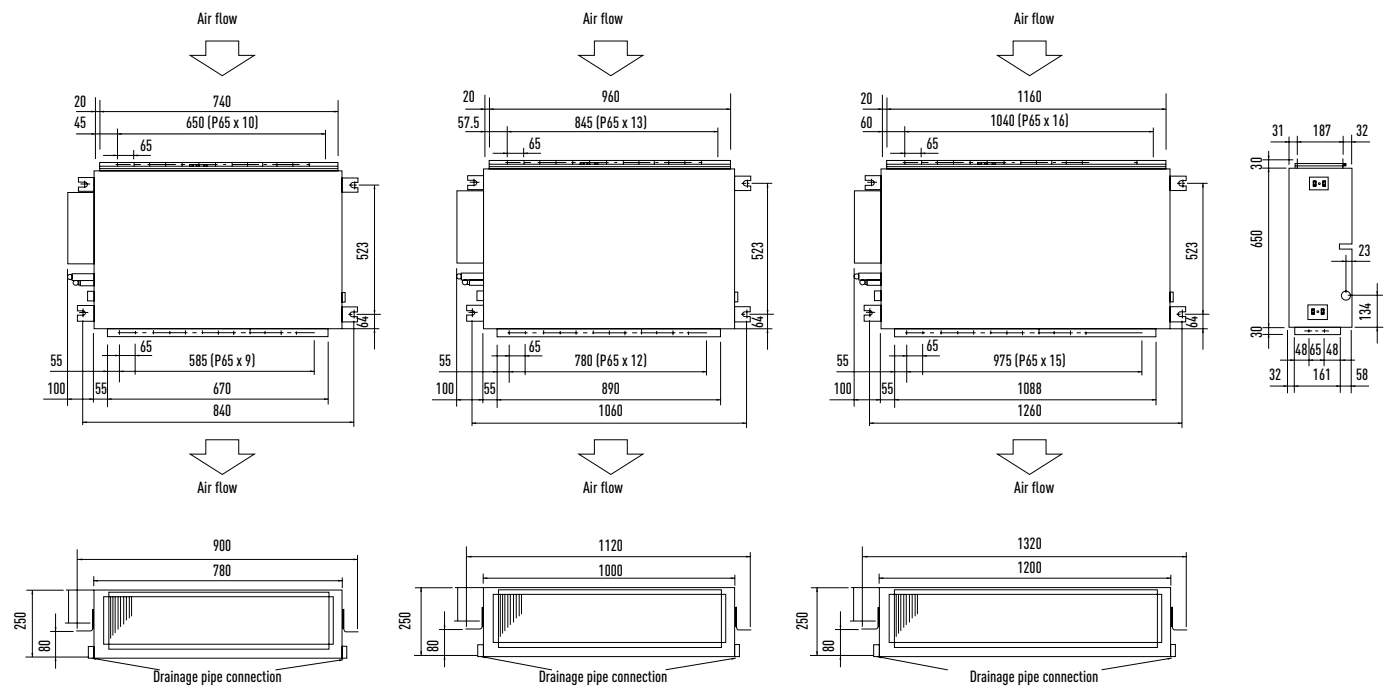

Dimensions: mm



Wall

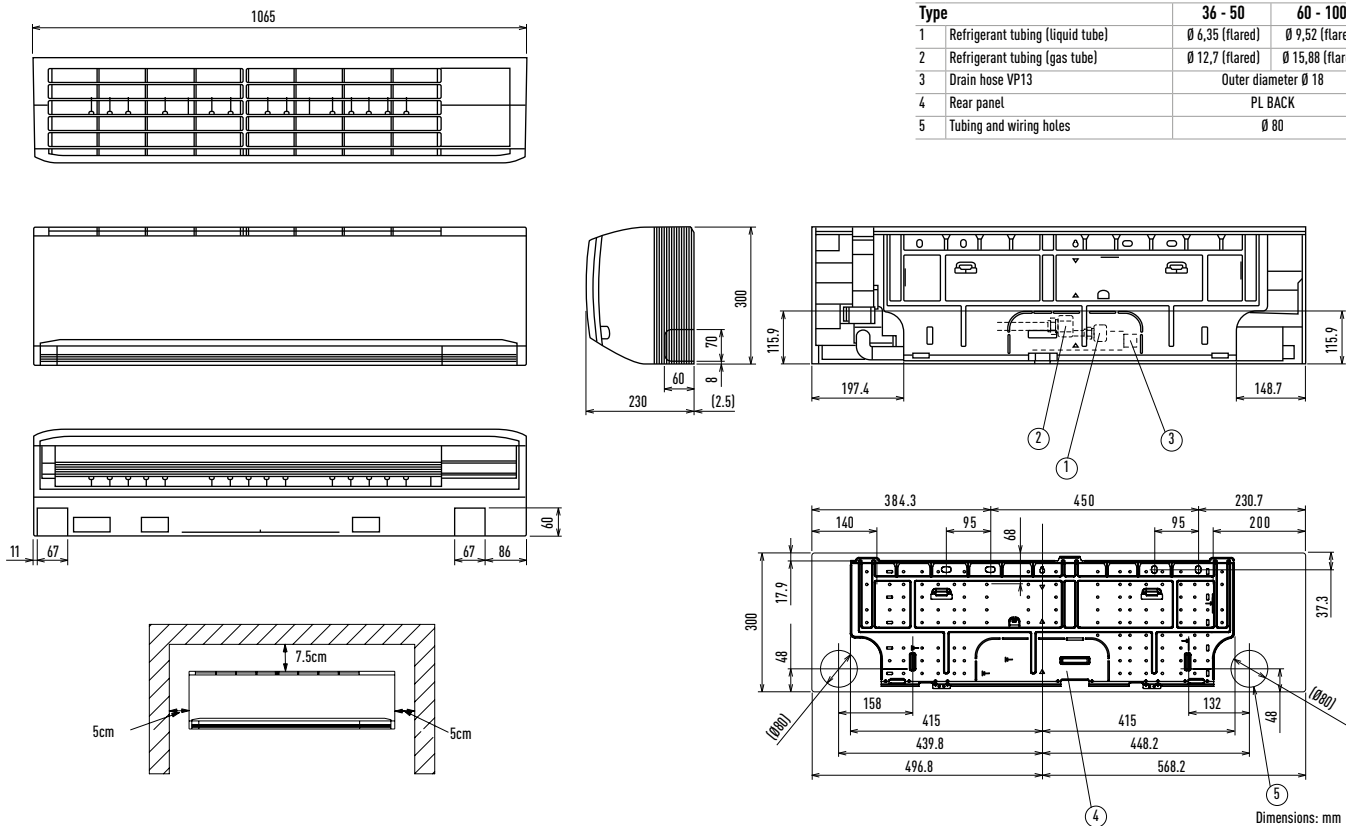

High Static Pressure Hide Away 20,0-25,0kW

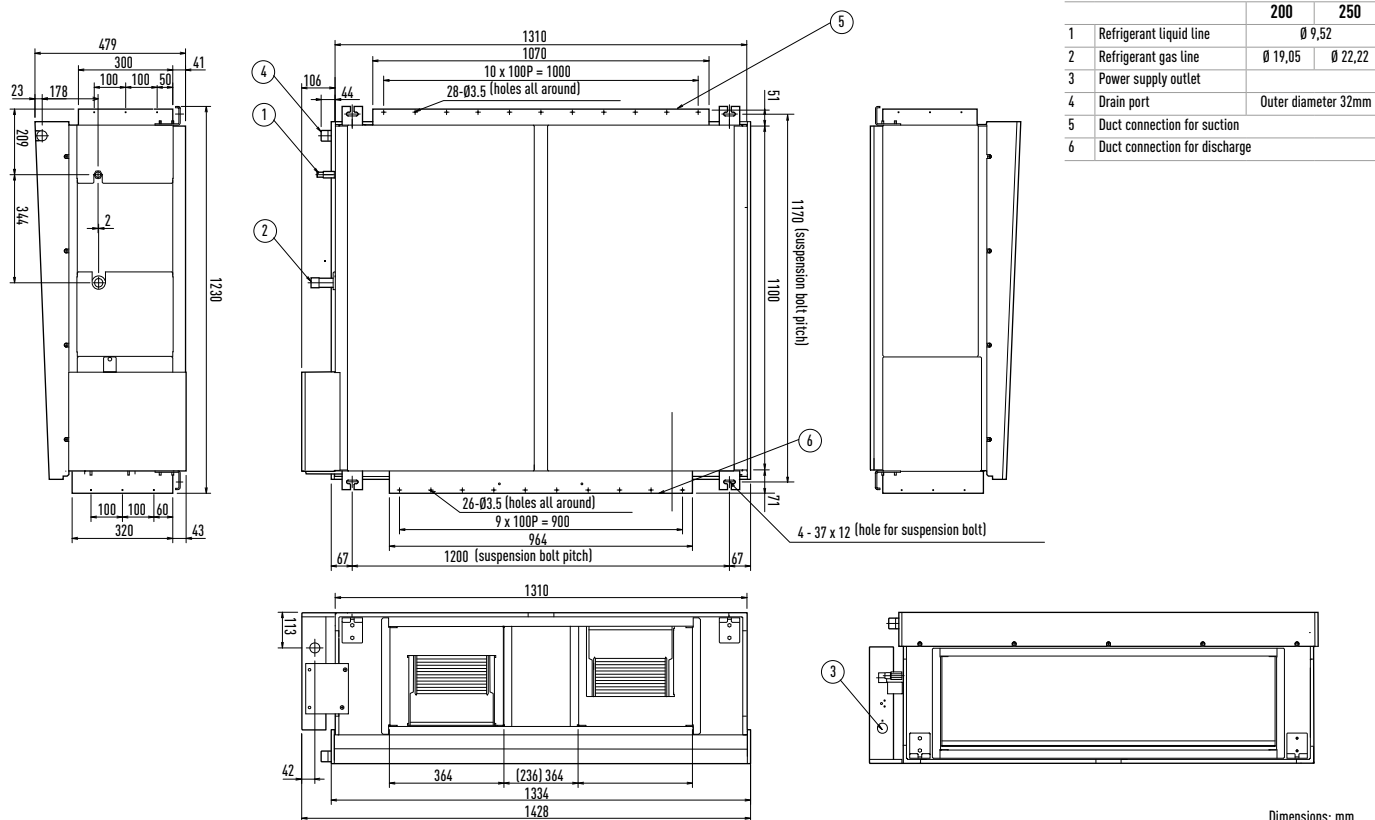

Outdoor Unit PACi Standard 6,0 and 7,1kW and PACi Elite from 3,6 to 6,0kW

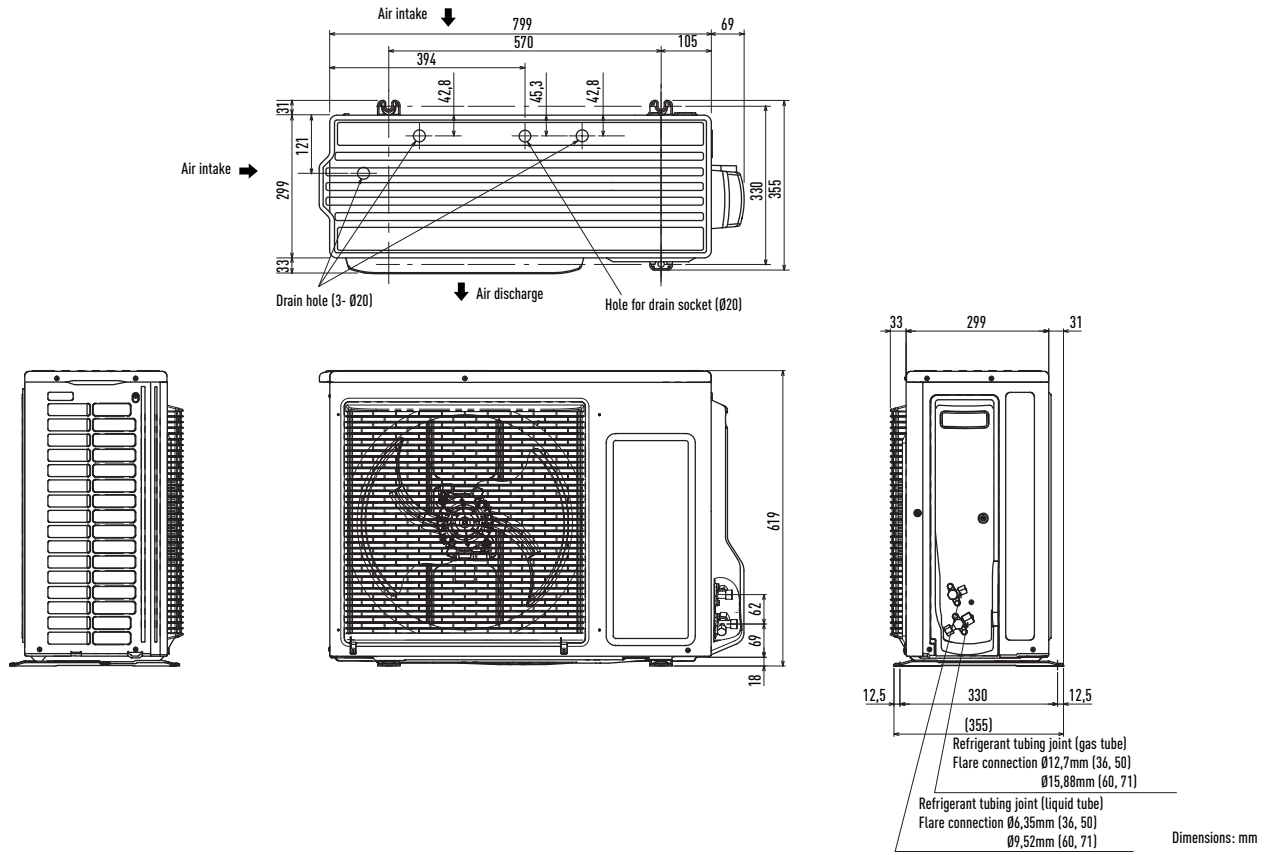

Outdoor unit PACi Standard 10,0 and 12,5kW and PACi Elite 7,1kW

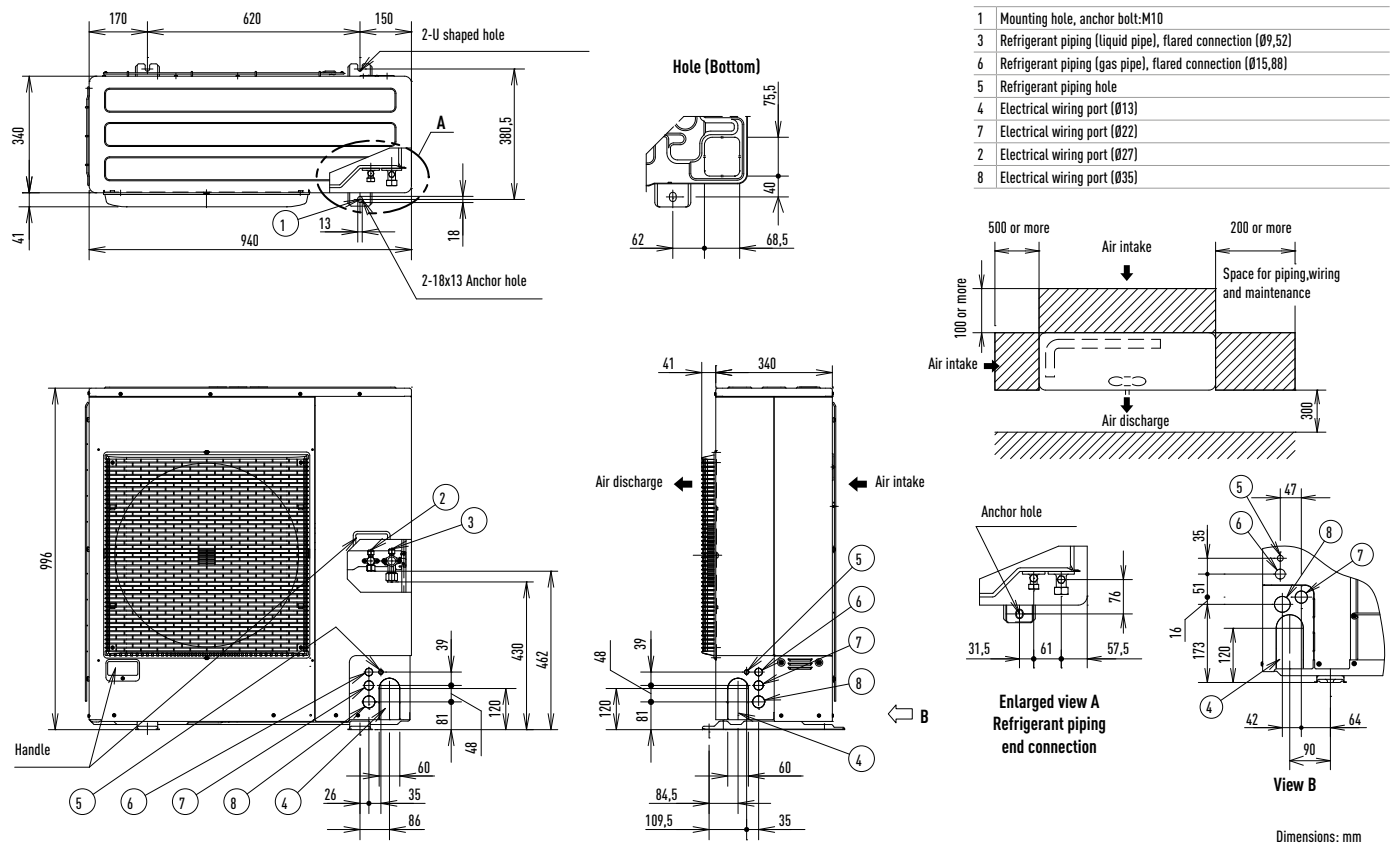

Outdoor unit PACi Standard 14,0kW and PACi Elite from 10,0 to 14,0kW

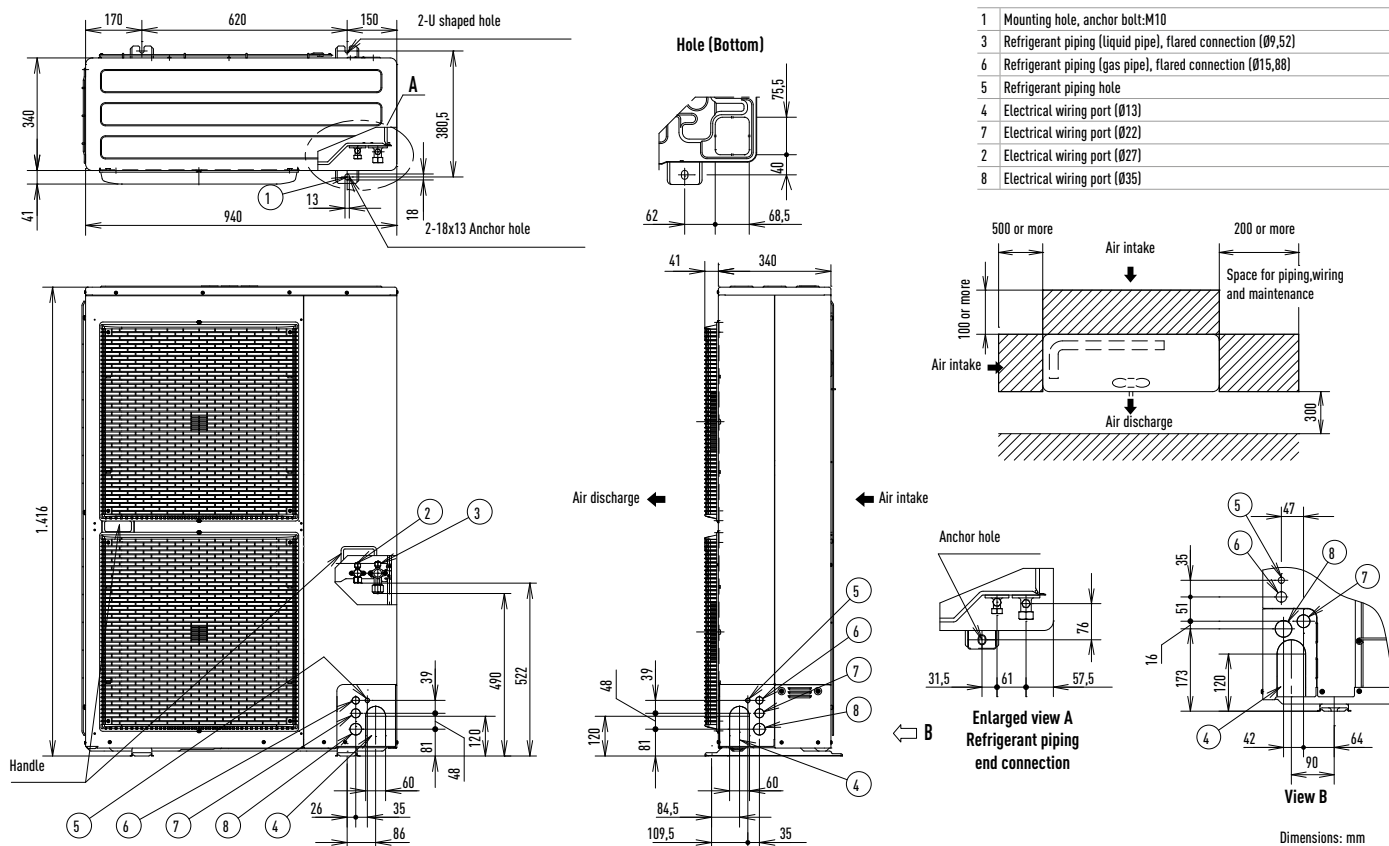

Outdoor unit Big PACi 20,0 and 25,0kW

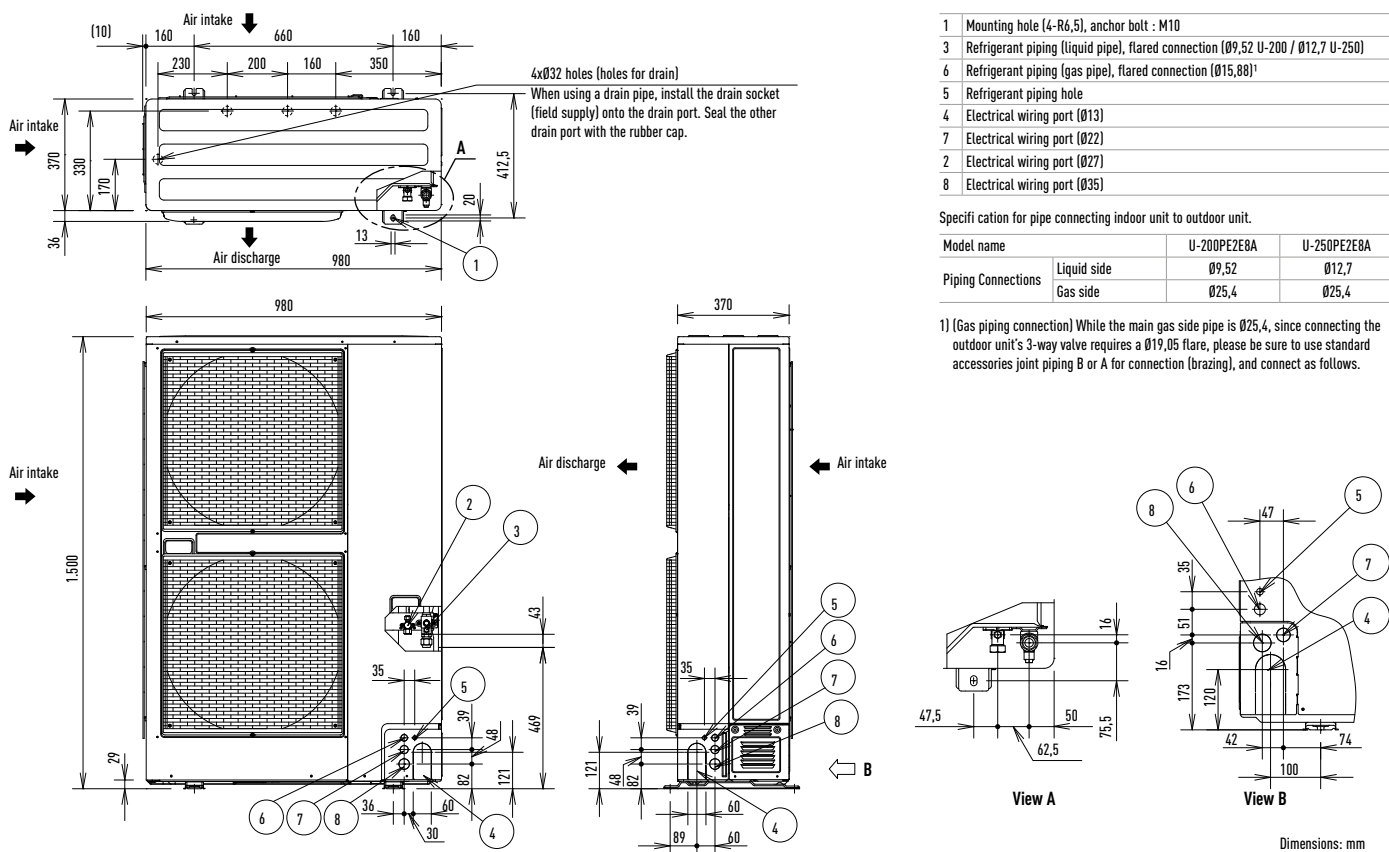

Specification for pipe connecting indoor unit to outdoor unit.

Model name	U-200PE2E8A	U-250PE2E8A
Piping Connections		
Liquid side	Ø9,52	Ø12,7
Gas side	Ø25,4	Ø25,4

1) (Gas piping connection) While the main gas side pipe is Ø25,4, since connecting the outdoor unit's 3-way valve requires a Ø19,05 flare, please be sure to use standard accessories joint piping B or A for connection (brazing), and connect as follows.

AHU Connection Kit

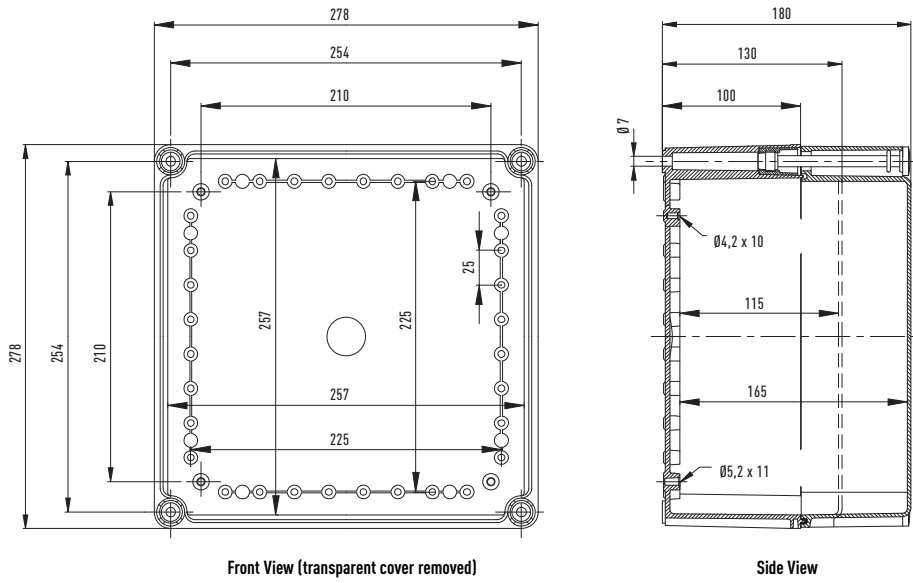

Dimensions: mm

Air Curtain with DX Coil

Jet-flow dimensions

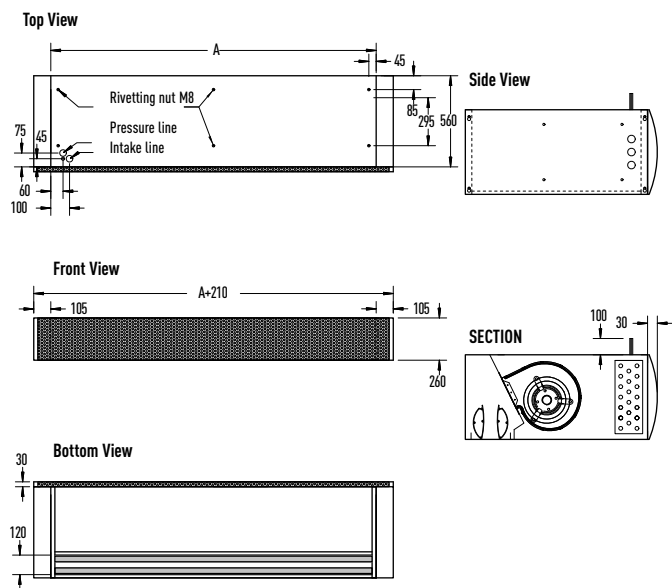

	PAW-10PAIRC-MJ	PAW-15PAIRC-MJ	PAW-20PAIRC-MJ	PAW-25EAIRC-MJ
A	1.000	1.500	2.000	2.500

Standard dimensions

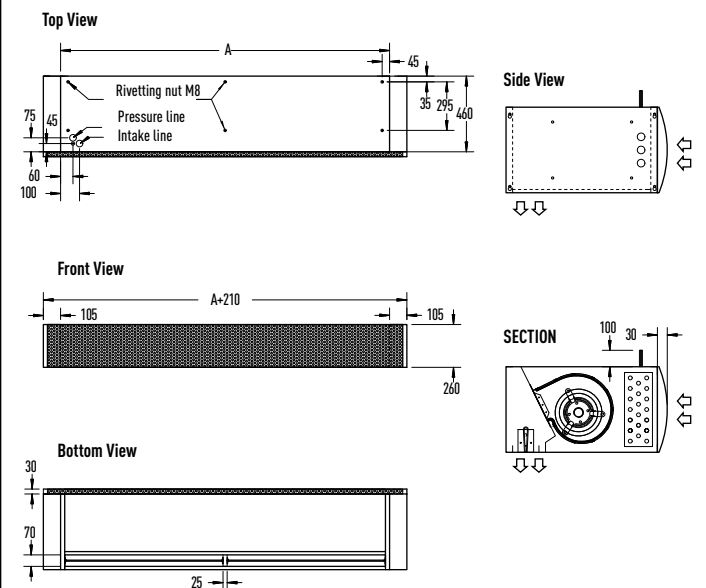

	PAW-10PAIRC-MS	PAW-20PAIRC-MS
A	1.000	2.000

Dimensions: mm



## Electric Air Curtain

### Indoor unit dimensions FY-10ESPNAH

Front View

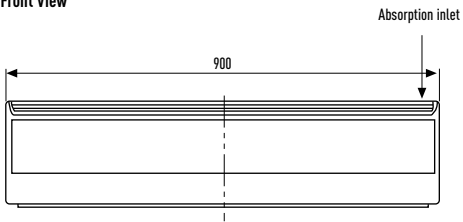

Back View

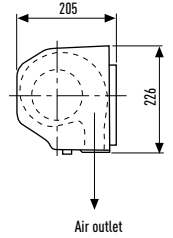
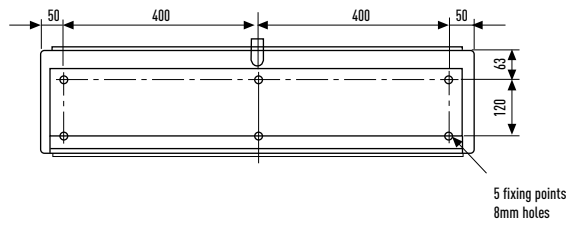

### Indoor unit dimensions FY-10ELPNAH

Front View

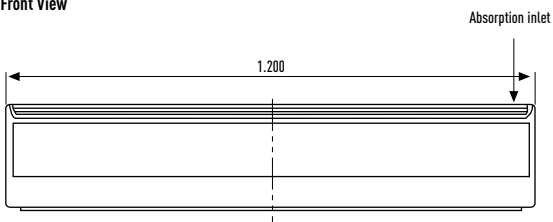

Back View

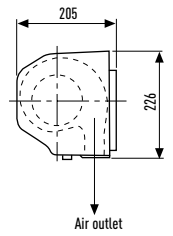
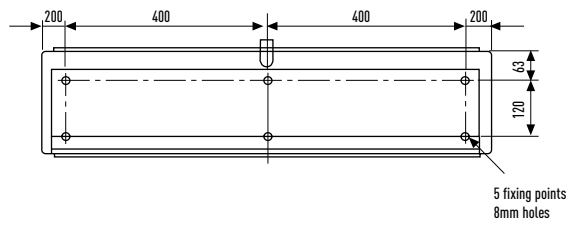

Dimensions: mm

## PAW-SERVER-PKEA for PKEA

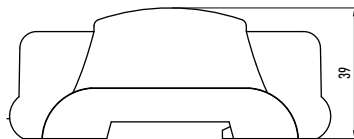
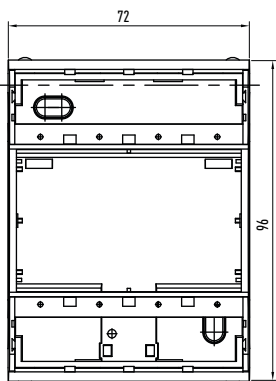

Dimensions: mm

PAW-RE2C3 Intelligent Controller

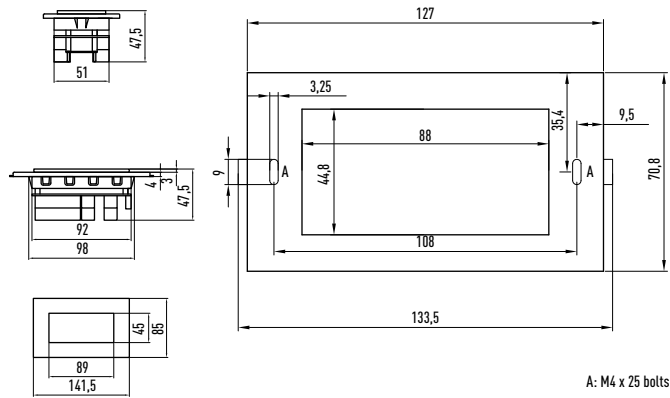

CZ-RTC4 Wired remote controller

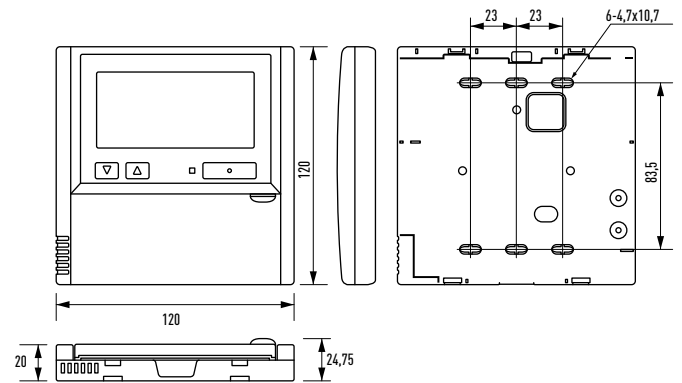

CZ-RTC5A Design wired remote controller

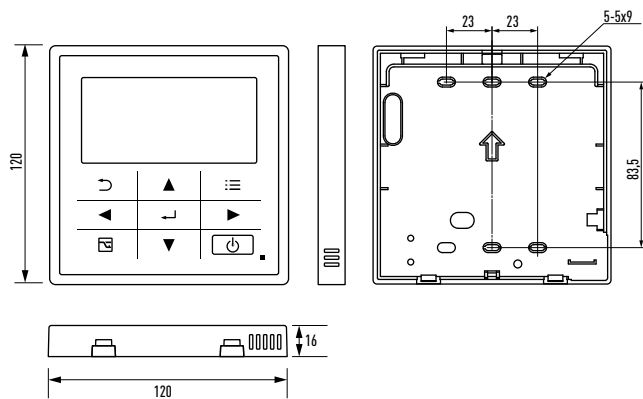

Wireless remote controller

CZ-RWSC3

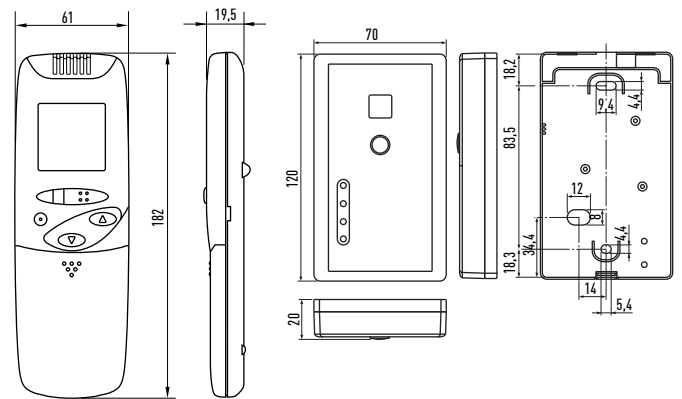

CZ-RE2C2 Simplified remote controller

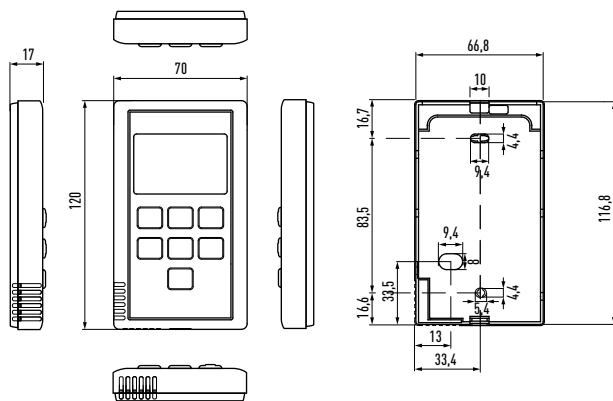

CZ-CSRC3 Remote sensor

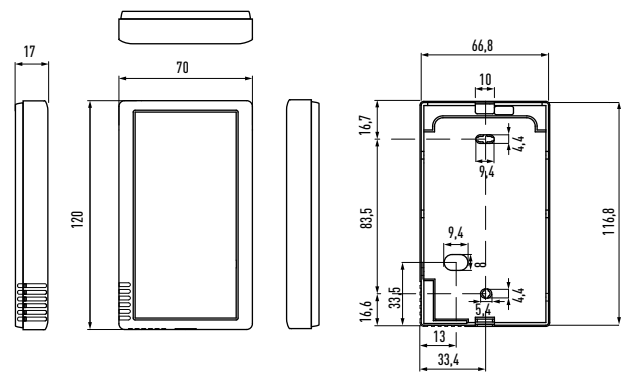

CZ-64ESMC3 System Controller with Schedule timer

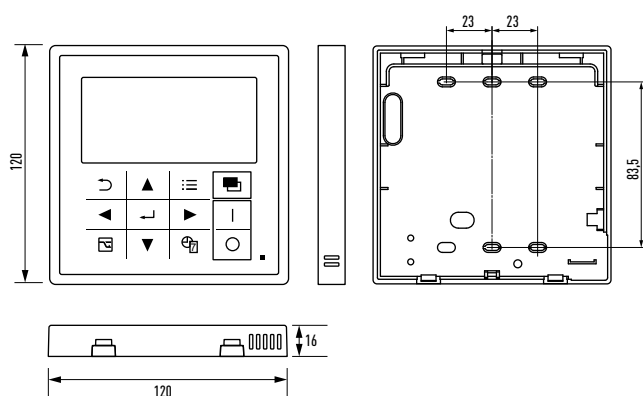

CZ-ANC2 ON/OFF Controller

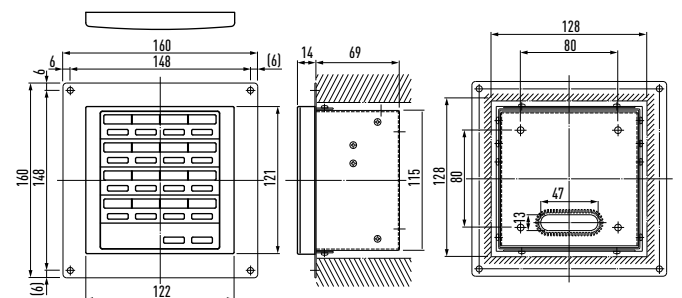

**CZ-256ESMC3 Intelligent Controller (Touch screen panel)**

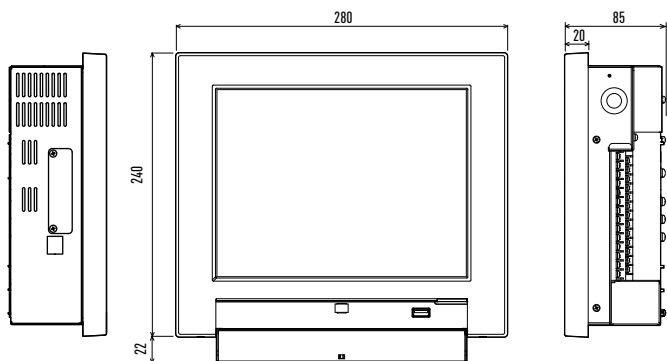

**CZ-CAPDC2 Seri-Para I/O unit for outdoor unit**

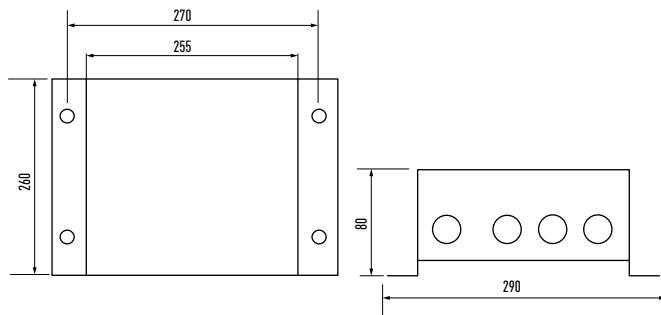

**CZ-CAPC2 Local adaptor for ON/OFF control**

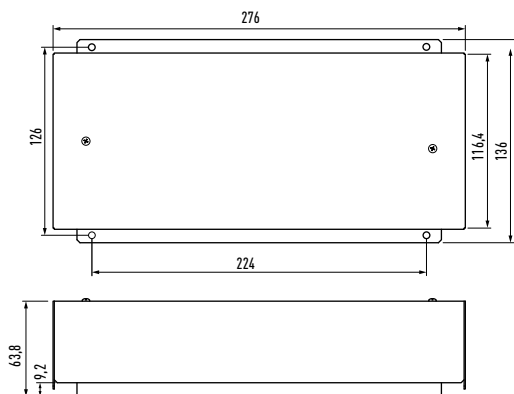

**CZ-CAPBC2 Mini Seri-Para I/O Unit 0 -10V**

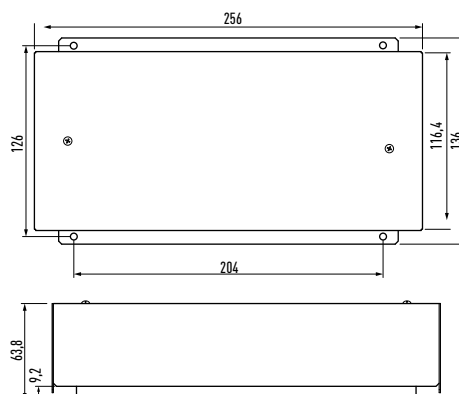

**CZ-CFUNC2 Communication Adaptor**

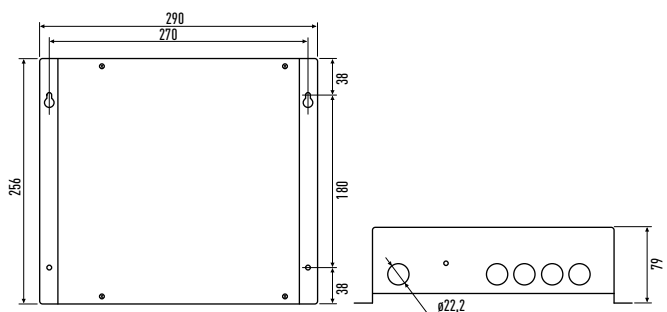

# PANASONIC INDUSTRIAL VRF SYSTEMS

NEW VRF  
TECHNOLOGY

'17





Professional solutions for all types of projects.

The new Panasonic VRF system is specifically designed for energy saving, easy installation and high efficiency performance, with a wide choice of outdoor and indoor unit models and unique features which are designed for the most demanding offices and big buildings.



# VRF HIGHLIGHTED FEATURES



## Panasonic provides an extensive range of solutions for mid and large buildings. Combining the best option to satisfy all needs and site restrictions.

The unique manufacturer that can combine both Electrical VRF and Gas powered VRF in same project, delivering best choice that makes the difference to our customers.

Providing large choice in indoor units, can connect also water heat exchangers, air handling unit and ventilation units with or without heat exchanger. All managed from simple and powerful stand alone remote control, new centralised controls or cloud connection with 3G embedded. Controls that can be managed remotely by a simple.

The cutting edge control technology is called VRF Smart Connectivity, combining the expertise of VRF communication and BEMS leading company to maximise comfort, and efficiency while reducing installation and integration costs.

	ECOi. Electrical VRF			ECO G. Gas Powered VRF	
	Mini ECOi (LE)	ECOi EX (ME2)	ECOi 3-Pipe (MF2)	ECO G GE3	ECO G GF2 3-Pipe
Capacity range	4-10HP	8-80HP	8-48HP	16-60HP	16-25HP
Extreme temperatures operation	-25°C	-25°C	-20°C	-21°C	-21°C
Number of indoor units	15	64	52	64	24
Simultaneity ratio	50 ~ 130%	200%	150%	—	50 ~ 200%
Indoor units	All (check restrictions)				
Controls	All				
Other ranges integration	PACi full control integration + Domestic integration by accessory				

### Energy saving



The Inverter range provides greater efficiency, more comfort, more precise temperature control, without highs and lows, and keeps the ambient temperature constant with lower energy consumption and a significant reduction in noise and vibration levels.



Multiple large-capacity all inverter compressors (more than 14HP). Two independently controlled inverter compressors achieve high efficiency. Redesigned components in the body provide performance improvement especially in the rated cooling condition and EER performance.



Intelligent Human Activity Sensor and new Sunlight Sensor technologies that can detect and reduce waste by optimising air conditioner operation according to room conditions. With just one touch of a button, you can save energy.



GHP technology offers the best in energy efficiency. ECO G gas VRF is specially designed for buildings where the electricity is restricted or CO<sub>2</sub> emissions must be reduced.

### High performance



The ECOi EX system works in heating mode with performance data at outdoor temperature down to -25°C.

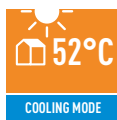

The ECOi EX system works in cooling mode with performance data at outdoor temperature up to 52°C.

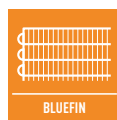

Panasonic has extended the life of its condensers with an original anti-rust coating.



Self-diagnosing function. By using electronic control valves past warnings are stored. This makes it easier to diagnose malfunctions, reducing service labour and therefore costs.



Automatic fan operation. Convenient microprocessor control automatically adjusts fan speed to High, Medium or Low, corresponding to room sensor and maintains comfortable airflow throughout the room.



By intermittent control of compressor and indoor unit's fan, "Mild Dry" gives you comfort. It realizes efficient dehumidification according to room temperature.



Comfortable auto-flap control. When the unit is first turned on, flap position is automatically adjusted in accordance with the cooling or heating operation.



Automatic restart function for power failure. Even when power failure occurs, preset programmed operation can be reactivated once power is resumed.



Air Sweep. The air sweep function moves the flap up and down in the air outlet, directing air in a "sweeping" motion around the room and providing comfort in every corner.



Built-in drain pump. Maximum head 50cm (or 75cm for U type) from the bottom of the unit.



The Panasonic renewal system allows good quality existing R22 pipe work to be re-used whilst installing new high efficiency R410A systems.



5 Years Warranty. We guarantee the outdoor unit compressors for five years.

### High connectivity



The new AC Smart Cloud from Panasonic allows you to have complete control of all your installations. In a simple click, all your units from several locations, receive status updates in real-time of all your installations, preventing breakdowns and optimizing costs.



Internet Control is a next generation system providing a user-friendly remote control of air conditioning or heat pump units from everywhere, using a simple Android or iOS smartphone, tablet or PC via internet.



The communication port is integrated into the indoor unit and provides easy connection to, and control of, your Panasonic heat pump to your home or building management system.



# PANASONIC IS DEFINITELY THE MOST EFFICIENT SYSTEM THROUGHOUT THE YEARS





**And highly adapted to retail, hotels and offices applications**

**Super high efficiency at part load conditions:**

Comparison with competitors: When many others do not declare performance data under 50% part load, Panasonic covers up to 30% part load with extremely high efficiency.

COP comparison Panasonic vs other competitors at different load						
Load %	110%	100%	60%	50%	40%	30%
Other competitors	3,52	3,38	3,45	3,50		
Panasonic VRF 6N Series 32HP Standard	3,38	3,41	4,41	4,69	4,85	4,93
Panasonic VRF 6N Series 32HP HI COP	3,91	3,94	5,14	5,54	6,03	6,51

Conditions: Outdoor temperature 0°C DB, Room temperature 20°C DB.

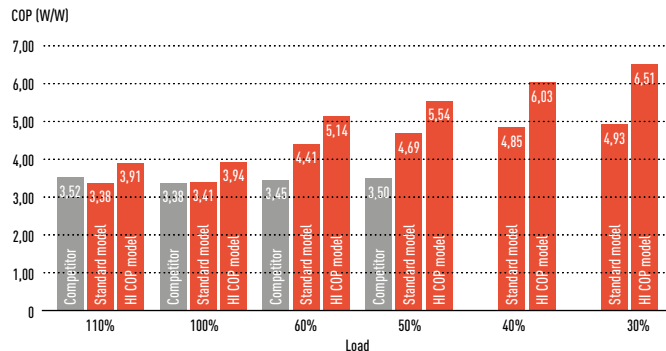

\* Data extracted by Panasonic and competitor official technical data book.

**Excellent SEER and SCOP values for 2 and 3-Pipe**

Panasonic have a extremely high SEER and SCOP values following the SBEM method (some other manufacturers may use another non official calculation method).

Mini ECOi			2-Pipe			3-Pipe		
Model	SEER	SCOP	Model	SEER	SCOP	Model	SEER	SCOP
U-4LE1E5	5,77	5,43	U-8ME2E8	7,74	5,61	U-8MF2E8	5,89	5,74
U-4LE1E8	5,76	5,43	U-10ME2E8	7,66	5,71	U-10MF2E8	5,96	5,40
U-5LE1E5	5,88	5,12	U-12ME2E8	7,32	5,84	U-12MF2E8	6,15	5,25
U-5LE1E8	5,88	5,12	U-14ME2E8	6,97	5,72	U-14MF2E8	5,87	5,63
U-6LE1E5	5,20	4,86	U-16ME2E8	6,66	5,71	U-16MF2E8	6,04	4,88
U-6LE1E8	5,29	4,86	U-18ME2E8	6,56	5,65			
			U-20ME2E8	5,98	4,88			

Developed by BRE, SBEM (Simplified Building Energy Model) is the basis of non-domestic building energy calculations. Based on the National calculation method (NCM), it is used to determine compliance with Part L of the Building Regulations and is also used to provide Energy Performance Certification.

Non-Domestic Building Services Compliance Guide provides information on various aspects of the calculation method, including those of Heat Pumps (Section 3), and Comfort Cooling (Section 9).

	SCOP - Seasonal Coefficient of Performance <sup>1</sup>				SEER - Seasonal Energy Efficiency Rating <sup>2</sup>			
	25%	50%	75%	100%	25%	50%	75%	100%
Part Load COP								
Ambient conditions	15°C	7°C	1°C	-5°C	20°C	25°C	30°C	35°C
Weighting factor	0,20 (a)	0,36 (b)	0,32 (c)	0,12 (d)	0,20 (a)	0,36 (b)	0,32 (c)	0,12 (d)

1. UK winter -5°C DB (outdoor temperature), 20°C WB (indoor temperature). 2. UK summer 21°C DB (outdoor temperature), 16°C WB (indoor temperature).

ESEER calculation corresponds with below conditions and the input power of indoor units is not included.

- Indoor temperature: 27°C DB / 19°C WB
- Outdoor temperature conditions

Part load ratio	25%	50%	75%	100%
Outdoor air temperature (°C DB)	20	25	30	35
Weighting coefficients	0,23	0,41	0,33	0,03

• Formula : 0,23 x EER25% + 0,41 x EER50% + 0,33 x EER75% + 0,03 x EER100%.

**Efficient defrost operation**

Panasonic use the second unit to defrost the first unit. This makes the system more efficient during defrost and does not affect comfort.

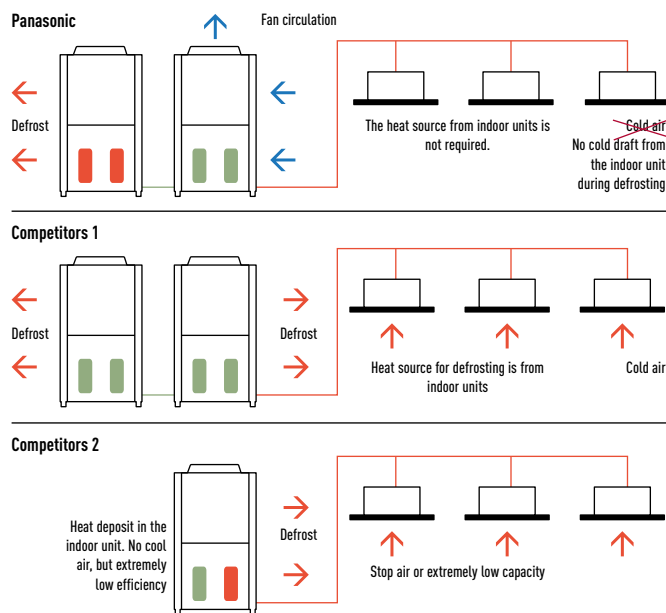

**Panasonic ECOi operates at as low as -25°C**

**This unique feature demonstrate the supremacy of Panasonic ECOi 6N Series.**

Panasonic use the second unit to defrost the first unit. This makes the system more efficient during defrost and does not affect the comfort.

Wide temperature setting range

Lowest operating outdoor temperature in the market  
**-25°C**

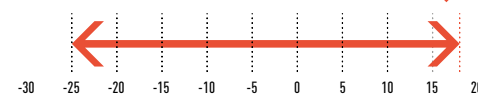

Outside air temperature (Upto 15 (°C WB))

# PANASONIC VRF TOP COMFORT



### Variable Evaporation Temperature (VET)

As a standard Panasonic includes VET in all ECOi series since 2006. This smart control logic is done every 30 minutes and depends directly on real demand and outdoor conditions giving the best performance and adapting really on time and on real needs. Panasonic also includes variable heating temperature function.

Cooling mode example (function also for heating is possible).

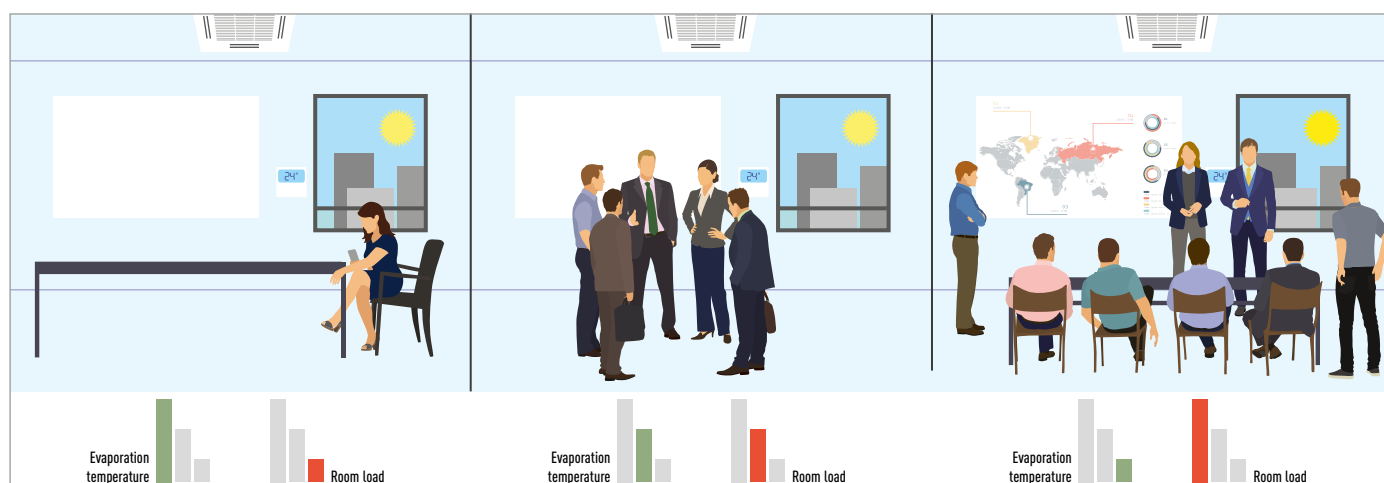
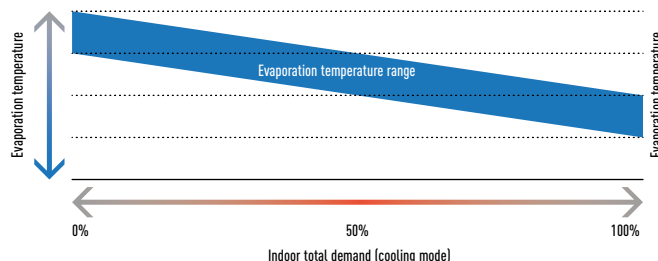

### Air discharge temperature sensor advantages

#### Air discharge application.

This technology has been applied successfully in many applications since 2016.

- Hotels. This technology increases occupant comfort and decreases energy consumption
- AHU, thanks to the perfect temperature control AHU is one of the main applications of this sensor
- Industrial applications to keep constant temperature like warehouses

We have high experience on this advantage.

- Safety
- Healthy
- Comfort
- Energy Saving

The Panasonic air discharge temperature sensor was created for security purposes. To avoid condensation in metals ducts, grilles, and in some indoor units close to high humidity areas as restaurants, retail and residential applications close to the sea, lakes and so on. This technology prevents condensation inside ducts, increasing health, because without water in ducts there is no possibility to grow mold, bacteria or other pathogens, avoiding flu, cold, etc..

This temperature sensor can be set up for cooling also for heating for healthy purposes for several application; warehouses for seeds, pharmacist warehouses, hospital, kindergarden, etc..

#### Air discharge temperature control.

Available in all VRF indoor units, this control provides excellent comfort. Discharge air at below 10°C is uncomfortable and can cause draughts. With Panasonic air discharge temperature control, air off temperature can be controlled between 7°C - 22°C.

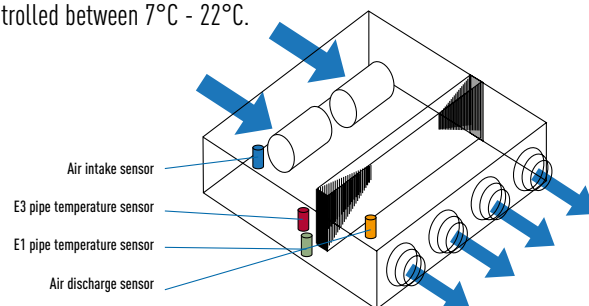

#### Big Pharmacist warehouse real case.

Big Pharmacist warehouse where total inside height were almost 10 meter and more than 2.000m<sup>2</sup>. ECOi with high static pressure indoor units ME1 was used with this setting, because they need constant temperature 19°C all year, with a difference only 1°C between top sensor at 10m and 1m height. This was perfect, because we could reduce in winter time air discharge temperature to avoid a lot of stratification, where consumption was reduced by almost 45% because just with fan in on mode and discharge temperature at 40°C was more than enough to maintain this 19°C stable.

# SOLUTIONS FOR RESTAURANTS

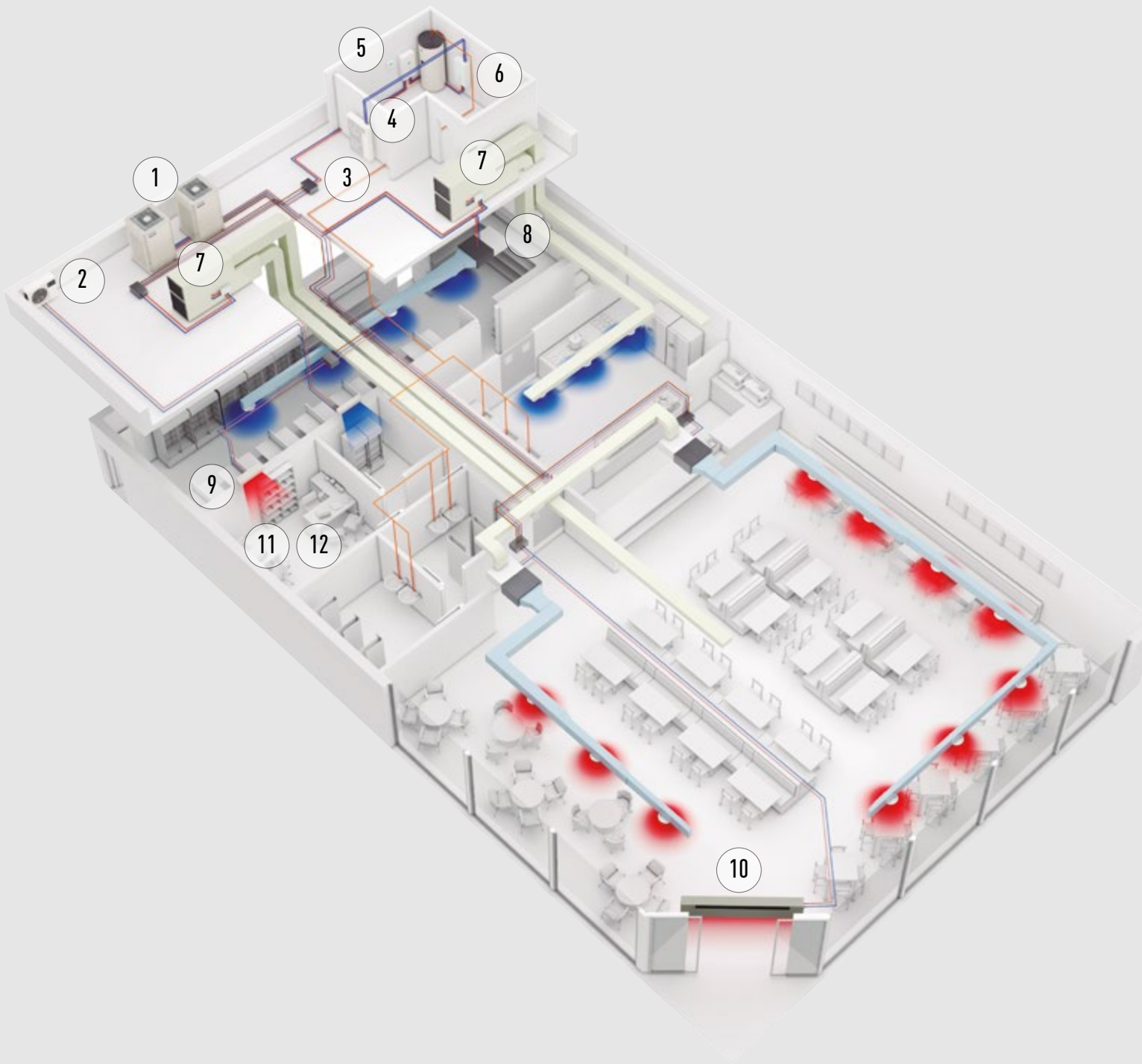



## Full heating, cooling and DHW solutions for Restaurants

### Super high efficiency at part load conditions

Panasonic has the most efficient solutions for optimising the installation of cooling, heating and DHW production. While the kitchen needs cooling, heating is needed for DHW and also for heating the public area, with the advantage of 100% fresh air that removes odours. Combining smartly all these needs with Panasonic technology, result in a simple and flexible system adaptable to any restaurant requests, with lower utility bills. Additionally, Panasonic is the unique offering solution for areas where electric power is limited, using ECO G, VRF units powered mainly by Natural Gas or Propane, bringing comfort and DHW anywhere.



#### 1 ECOi (Electric VRF).

ECOi electrical VRF is specifically designed for the most demanding hotels. High efficiency system. Extended operating range to provide heating at outdoor temperature as low as -25°C. Suitable for refurbishment projects.



#### 2 PKEA outdoor unit for server room.

Steady cooling, nonstop, even at -20°C and still with high efficiency. Ready for continuous operation and easy to connect 2 systems to automatically alternate and ensure server rooms are kept cool with maximum operating guaranteed.

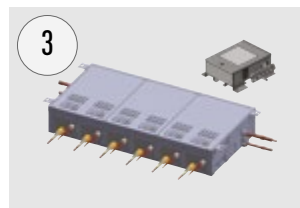

#### 3 3-Pipe control box kit.

New Heat Recovery box to connect multiple indoor units with just one box, 4, 6 and up to 8 indoor units or groups. This is good advantage specially in hotels applications, where space for connecting several boxes is limited.

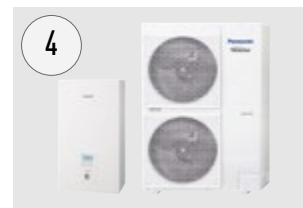

#### 4 Aquarea T-CAP.

Ideal for heating, cooling and for production of big quantities of hot water at 65°C, Aquarea have a extremely quick return on investment and a low CO<sub>2</sub> footprint.



#### 5 Control your way.

Wide variety of controls, from simple user control to full system control via remote access functionality. Touch panel, web server, consumption control, smartphone control... everything is possible.

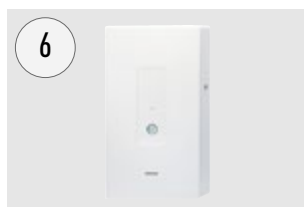

#### 6 Hydrokit for ECOi. Water at 45°C.

Produces LT hot water it is compatible with both ECOi, heat pump and heat recovery outdoors.

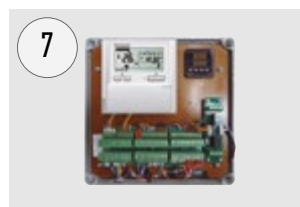

#### 7 Air Handling Unit kits for efficient ventilation.

The new AHU kit is specially designed to improve the efficiency of the pre-heating or pre-cooling process of the ventilation.



#### 8 Hide Away, for power and efficiency.

Super silent units deliver the ideal air supply. Units available from 1,5kW providing precise temperature control even in small rooms. Two models available: slim unit for height restricted areas (MM unit only 200mm deep), another which allows 100% fresh air (MF).



#### 9 Wall Mounted.

The K2/K1 Type wall mounted unit has a stylish smooth panel which not only looks good but is also easy to clean. The unit is also smaller, lighter and substantially quieter than previous models making it ideal for small offices and other commercial applications.



#### 10 Air Curtain with DX Coil.

The Panasonic range of air curtains is designed for smooth operation and efficient performance.



#### 11 Protocol friendly.

Great flexibility for integration into your KNX / Modbus / LonWorks / BACnet projects allows fully bi-directional monitoring and control of all the functioning parameters. Range of solutions to control locally or remotely the full system in bi-directional mode.



#### 12 New Aquarea Smart Cloud.

Starting with complete functions, CZ-TAW1 platform will incorporate more functions to convert Aquarea in the most saving system at home, making installer maintenance works simpler.



# YOUR ENTIRE HOTEL WITH MAXIMUM SAVINGS, CONTROL AND COMFORT

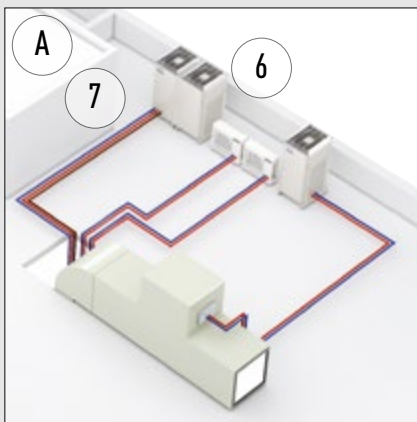
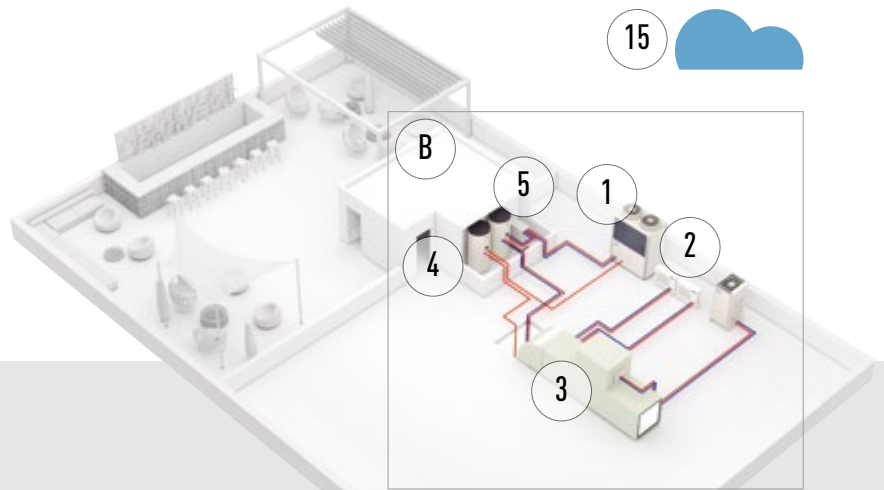

**A**

**Option A: Hybrid Solution. Gas + Electric: When large quantities of hot/cold water is needed.**

- ECO G (Gas heat pump)
- Water heat exchanger
- Aquarea HT to produce hot water up to 65°C
- Air Handling Unit kit to connect the ECO G to the Air Handling Unit
- PKEA wall mounted to cool the server rooms efficiently

**B**

**Option B: Full Electric Solution 2 and 3-Pipe. When flexibility is needed and electricity power availability is not an issue.**

- ECOi (Electric VRF)
- Direct expansion indoor units
- Air Handling Unit (AHU) kit to connect the ECOi to the AHU
- PKEA wall mounted to cool the server rooms efficiently
- New Panasonic Pump Down System: Detect refrigerant leakage and activate Pump Down solution

## Panasonic helps your entire hotel achieve maximum savings, maximum control and maximum comfort

Panasonic offers the widest range in HVAC, DHW and ventilation available. That enables us to offer the most suitable solution to ANY project. And this all with the peace of mind provided by a fast customer service which is available 24 hours a day, 365 days a year.

The energy savings provided by our solutions, plus the available choice between electricity and gas, will enable you to reduce your CO<sub>2</sub> emissions. Panasonic solutions not only ensure a higher customer satisfaction but also the peace of mind that the wide Panasonic experience brings about in this field, plus a lower energy bill.

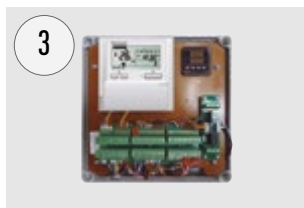

### 3 Air Handling Unit kits for efficient ventilation.

The new AHU kit is specially designed to improve the efficiency of the pre-heating or pre-cooling process of the ventilation.

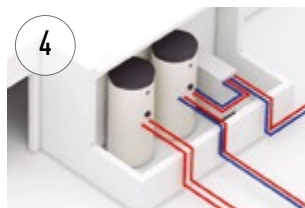

### 4 Domestic Hot Water production and buffer tanks.

Panasonic has developed a wide range of efficient domestic hot water tanks and buffer tanks.



### 1 ECO G (Gas heat pump).

ECO G gas VRF is specially designed for buildings where the electricity is restricted or CO<sub>2</sub> emissions must be reduced. Very high preliminary efficiency ratio. Very low electrical consumption. Sanitary hot water is produced freely in summer.



### 2 PKEA outdoor unit for server room.

Steady cooling, nonstop, even at -20°C and still with high efficiency. Ready for continuous operation and easy to connect 2 systems to automatically alternate and ensure server rooms are kept cool with maximum operating guaranteed.



### 5 Hydronic units.

For obtaining hot and cold water for heating and refrigeration (Aquarea Air radiators, underfloor heating, radiators...)



### 6 ECOi (Electric VRF).

ECOi electric VRF is specifically designed for the most demanding hotels. High efficiency system. Extended operating range to provide heating at outdoor temperature as low as -25°C. Suitable for refurbishment projects.



### 7 Improving security, detect refrigerant leaks early!

Panasonic's innovative Pump Down Systems help to detect refrigerant leaks that offer complete assurance and protection for end users, building occupiers and the environment.

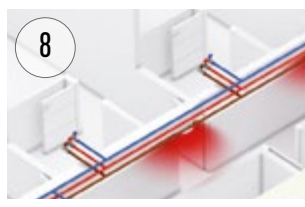

### 8 Cutoff valves.

When there are plans for future expansion, the installation can be built using the units sized for future expansion requirements.



### 9 Maximum savings on hot water production.

Hot water for swimming pool, spa and laundry for free thanks to the residual heat generated by the ECO G units.



### 10 Protocol friendly.

Great flexibility for integration into your KNX / Modbus / LonWorks / BACnet projects allows fully bi-directional monitoring and control of all the functioning parameters. Range of solutions to control locally or remotely the full system in bi-directional mode.



### 11 Control your way.

Wide variety of controls, from simple user control to full system control via remote access functionality. Touch panel, web server, consumption control, smartphone control... everything is possible.



### 12 Wide range of indoor units.

Complete range of indoor units that fits any need. All units provided with supply air temperature sensor and low operation sound level to guarantee maximum guests comfort. From 1,5kW up to 30kW.



### 14 Air Curtain with DX Coil.

The Panasonic range of air curtains is designed for smooth operation and efficient performance.



### 15 Panasonic AC Smart Cloud.

Take control of all your shops around the world from a single device. Centralise control of your business premises, from wherever you are, 24/7.



# INNOVATIVE SOLUTIONS FOR RETAIL

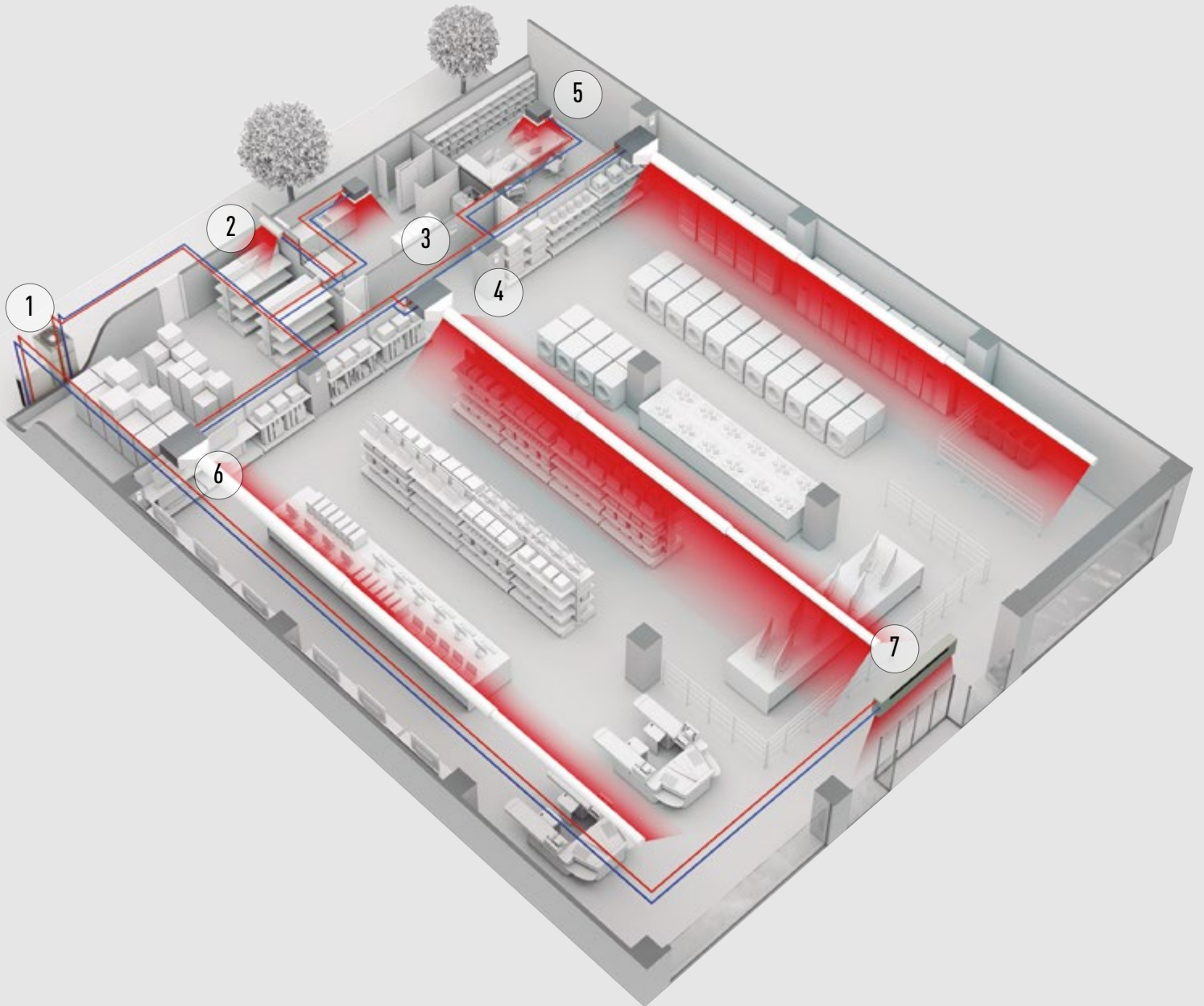



## Heating and cooling solutions for retail applications.

Panasonic has developed solutions for retail applications and office applications where return on investment is a key factor! The comfort inside the shop is key for a good customer experience in the shop. From local control or from Panasonic new cloud control system, a detail status of the heating and cooling system can be displayed, analysed and optimised in order to improve the efficiency, reduce the running time and increase the life time of the units.

## 8 reason why Panasonic is the best solution for your Retail:

- Complete solution
- Flexibility and adaptation
- Go green retail: lowest CO<sub>2</sub> emissions
- Comfort - maximum satisfaction
- Future expansion
- Panasonic is definitely the most efficient system over the years
- High quality of service with Panasonic pro-partner installation team
- The system will still operate up to 25% of the connected indoor units. System will not stop when up to 25% of indoor units have power supply breakdown when they are on mode



### Multi energy solutions, gas or electric.

The Multi energy solution (Gas and Electric) from Panasonic gives the best of the energy saving and on the flexibility of the installation. Panasonic solutions can be connect to direct expansion systems, water chiller installations and ventilation systems as air handling units.

- 1a: Gas VRF. ECO G  
 1b: Electric VRF. ECOi  
 1c: Electric VRF. Mini ECOi  
 1d: Electric 1x1. PACi  
 1e: Electric A2W. Aquarea



### PKEA outdoor unit for server room.

Steady cooling, nonstop, even at -20°C and still with high efficiency. Ready for continuous operation and easy to connect 2 systems to automatically alternate and ensure server rooms are kept cool with maximum operating guaranteed.



### Control your way.

Wide variety of controls, from simple user control to full system control via remote access functionality. Touch panel, web server, consumption control, smartphone control... everything is possible.



### Econavi Sensor.

The all new Econavi Sensor detects presence in the room, and quietly adapts the PACi or VRF air conditioning system in order to improve comfort and maximise energy savings.



### Wide range of indoor units.

Complete range of indoor units that fits any need. All units provided with supply air temperature sensor and low operation sound level to guarantee maximum guests comfort. From 1,5kW up to 30kW.



### Hide Away, for power and efficiency.

Super silent units deliver the ideal air supply. Units available from 1,5kW providing precise temperature control even in small rooms. Two models available: slim unit for height restricted areas (MM unit only 200mm deep), another which allows 100% fresh air (MF).



### Air Curtain with DX Coil.

The Panasonic range of air curtains is designed for smooth operation and efficient performance.



### Protocol friendly.

Great flexibility for integration into your KNX / Modbus / LonWorks / BACnet projects allows fully bi-directional monitoring and control of all the functioning parameters. Range of solutions to control locally or remotely the full system in bi-directional mode.



### Air Handling Unit kits for efficient ventilation.

The new AHU kit is specially designed to improve the efficiency of the pre-heating or pre-cooling process of the ventilation.

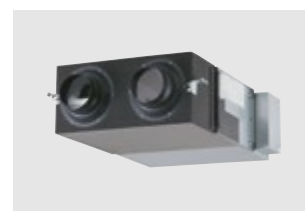

### Energy Recovery unit for high efficiency of the system.

Panasonic Energy Recovery Ventilators can reduce the outside air load because they efficiently recover the heat lost by ventilation during the heat recovery process.

# BEST EFFICIENCY ECOi SERIES FROM PANASONIC



The ECOi series is designed for energy savings, easy installation, and high efficiency. Always continuing to evolve, Panasonic uses advanced technologies to meet the requirements of diverse situations and contribute to the creation of comfortable living spaces.

**ECOi**

### Mini ECOi Series



The 2-Pipe heat pump small VRF system specifically designed for the European market.

### New 2-Pipe ECOi EX



The VRF system delivering energy-saving performance, powerful operation, reliability and comfort surpassing anything previously possible.

### 3-Pipe ECOi MF2 6N Series



The VRF system that offers high-efficiency and performance for simultaneous heating and cooling.

#### Lower running and life cycle costs.

Panasonic ECOi systems are amongst the most efficient VRF systems on the market, offering COPs in excess of 4,0 at full load conditions. The system is also designed to make sure that we reduce the running cost of each system by using our unique road map control routine to ensure that the most efficient combination of compressors are running at any one time. Improved defrost sequencing also reduces running costs by defrosting each outdoor coil in turn when conditions allow.

Up to 64 indoor units can be connected up to a capacity of 200% indexed indoor unit loads, enabling the system to be used effectively on highly

diversified building loads: this large connectability feature makes it an easy-to-design solution for schools, hotels, hospitals and other large buildings. Up to 1000m in pipe length enables the VRF ECOi series to be used in very large buildings, with maximum design flexibility. The ECOi system is also easy to control. It has more than 8 types of control from standard wired remote controls to touch screen panels or web access interfaces.

**DC-inverter control technology for rapid and powerful cooling & heating. The ever-evolving Panasonic ECOi series.**

#### ECOi Series benefits

##### Ease of installation.

R410A has a higher operating pressure with a lower pressure loss than previous refrigerants. This enables smaller pipe sizes to be used and allows reduced refrigerant charges.

##### Simple to design.

Panasonic rECO Gnise that designing, selecting and preparing a professional VRF quotation can be a time consuming and costly process, especially as it is often also a speculative exercise. So we have designed proprietary software which is quick and easy to use and produces a full schematic layout of pipework and controls, as well as a full materials list and performance data.

##### Easy to control.

A wide variety of control options are available to ensure that the ECOi system provides the user with the degree of control that they desire, from simple room controllers through to state of the art BMS controls.

##### Simple to commission.

Simple set-up procedure including automatic addressing of connected indoor units. Configuration settings can be made from an outdoor unit or via a remote controller.

##### Easy to position.

The compact design of the ECOi outdoor units means that sizes 8HP to 10HP fit into a standard lift and are easy to handle and position when on site. The small footprint and modular appearance of the units ensure a cohesive appearance to an installation.

##### Wide selection and connectability.

With 11 indoor model styles available, ECOi systems are the ideal choice for multiple small capacity indoor unit installations, with the ability to connect up to 40 indoor units to systems of 24HP or greater for 3-Pipe ECOi MF2 6N Series.

##### Easy to maintain.

Each system allows the use of prognostic and diagnostic controls routines, from refrigerant charge control through to complex fault code diagnostics, all designed to reduce the speed of maintenance calls and unit down time.

##### Lower running and life cycle costs.

Panasonic ECOi systems are amongst the most efficient VRF systems on the market. The system is also designed to make sure that we reduce the running cost of each system by using our unique road map control routine to ensure that the most efficient combination of compressors are running at any one time. Improved defrost sequencing also reduces running costs by defrosting each outdoor coil in turn when conditions allow.



## 2-PIPE MINI ECOi LE1 SERIES





Panasonic has unveiled its new, large capacity, Mini VRF side blow system. Available now from 4 to 10HP, this compact system is the ideal solution for applications where outdoor space is at a minimum, but where a quality and reliable heating and cooling solution is paramount.

**Cooling and Heating type Single Phase and Three Phase**

**For small-scale commercial and residential use.**

Panasonic 2-Pipe Mini ECOi, the 2-Pipe heat pump is specifically designed for the most demanding applications. Mini ECOi is available in 5 sizes with cooling capacities ranging from 12,1kW to 28kW and connectable up to 15 indoor units (applicable for 28kW).

An expansion from the Panasonic VRF line up, the Mini ECOi is compatible with the same indoor units and controls as the rest of the ECOi range.

**Wide design operation conditions.**

The operating range for heating operation is to -20°C, the cooling range is to -10°C. The remote controller temperature setting offers a range from 16°C to 30°C.

Cooling design operation conditions

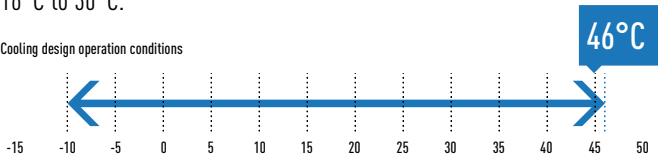

Heating design operation conditions

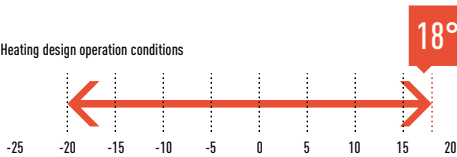

Cooling: Outside air temperature °C (DB). Heating: Outside air temperature °C (WB). Units work continuously at out of above condition until safety function starting.

**Heating and cooling solutions**

Perfect solution for small shops, offices, large residential properties or condominiums where outdoor space is minimal, as well as larger, commercial applications including hotels or larger office buildings where the outdoor system should not intrude on the exterior décor.

**Bluefin (only for 8-10HP)**

Bluefin treatment protect the coil itself against corrosion, ensuring that the unit continues to function with the same outstanding thermal exchange efficiency and performance over time.

**New Inverter compressor (only for 8-10HP)**

Thanks to its top class COP, high heat exchange performance due to its wide heat exchanger and extensive Inverter compressor range, which provides a high efficiency operation by the load, it is also incredibly energy saving.

**Silent mode**

Maximum 7dB(A) can be reduced by setting. External input signal is also available. In case of the installation at Condominium, quiet operation performance is important, especially in night time.

**Increased piping length for greater design flexibility**

Adaptable to various building types and sizes. Actual piping length: 120m (equivalent piping length 140m). Maximum piping length: 150m.

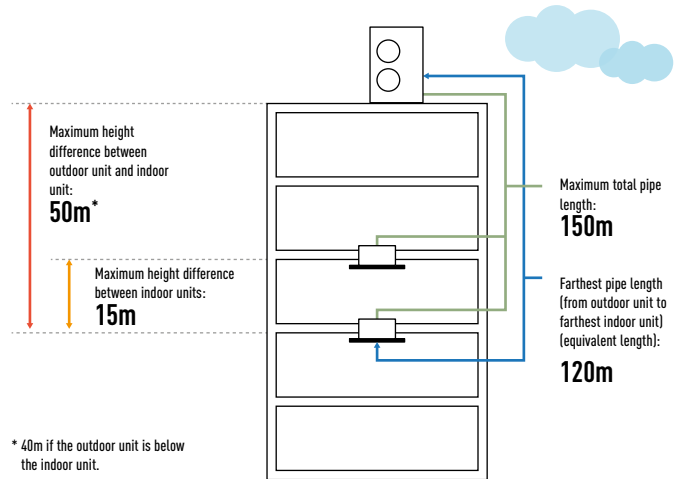

**Flexible pipework**

Category	Item	Description	Max length (m)
Allowable pipework length	L1	Maximum pipe run	Actual length 120 Equivalent length 140
		L2-L3	Difference between maximum length and minimum length from the first distribution joint
	L3 L4 Ln	Maximum length of each distribution joint	30
	L1+L3+L4	Maximum total pipe run length	150
Allowable height difference	H1	When outdoor unit installed higher When outdoor unit installer lower	50 40
	H2	Maximum difference between indoor units	15

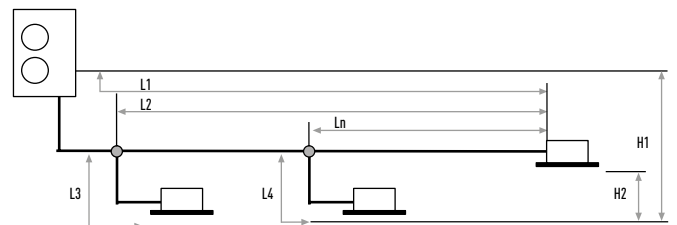

**Up to 15 indoor units per system**

System / HP	4HP	5HP	6HP	8HP	10HP
Maximum number of connectable indoor units	6	8	9	15	15

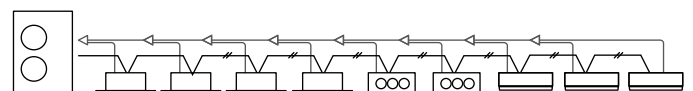

# MINI ECOi HIGH EFFICIENCY 4-6HP

Panasonic's new Mini VRF system combines a high performance to position itself as one of the most compact and powerful VRF systems available within the European market.

### For light commercial use

Panasonic's Mini ECOi, the 2-Pipe heat pump small VRF system, is specifically designed for the most demanding applications. Offering between 12,1kW and 15,5kW cooling capacity in 3 sizes and up to 9 indoor units connected, the Mini ECOi sets standards of performance and flexibility. Utilising R410A and DC inverter technology, Panasonic offers VRF to a new and growing market.

Forming a new key part of the Panasonic VRF line up, the Mini ECOi is compatible with the same indoor units and controls as the rest of the ECOi range.



### Technical focus

- Single Phase or Three Phase power supply
- One Amp start current
- DC inverter technology combined with R410A
- Diversity ratio 50~130%
- Cooling operation to -10°C
- Compact outdoor unit 1.330 x 940 x 410mm

HP			4HP						5HP						6HP					
Model			U-4LE1E5			U-4LE1E8			U-5LE1E5			U-5LE1E8			U-6LE1E5			U-6LE1E8		
Power supply	Voltage	V	220	230	240	380	400	415	220	230	240	380	400	415	220	230	240	380	400	415
	Phase		Single Phase			Three Phase			Single Phase			Three Phase			Single Phase			Three Phase		
	Frequency	Hz	50Hz			50Hz			50Hz			50Hz			50Hz			50Hz		
Cooling capacity		kW	12,1			12,1			14,0			14,0			15,5			15,5		
EER <sup>1)</sup>		W/W	4,30			4,30			4,20			4,20			3,45			3,45		
Running amperes	A		13,9	13,3	12,7	4,9	4,7	4,5	16,3	15,6	14,9	5,7	5,4	5,2	21,5	20,5	19,7	7,5	7,1	6,9
Input power cooling		kW	2,81			2,81			3,33			3,33			4,49			4,49		
Heating capacity		kW	12,5			12,5			16,0			16,0			18,0			18,0		
COP <sup>1)</sup>		W/W	4,62			4,62			4,30			4,30			3,95			3,95		
Running amperes	A		13,2	12,7	12,1	4,7	4,5	4,3	18,0	17,2	16,5	6,3	6,0	5,8	21,6	20,7	19,8	7,5	7,2	6,9
Input power heating		kW	2,71			2,71			3,72			3,72			4,56			4,56		
Starting amperes	A		1,0	1,0	1,0	1,0	1,0	1,0	1,0	1,0	1,0	1,0	1,0	1,0	1,0	1,0	1,0	1,0	1,0	1,0
Maximum amperes	A		21,0	21,0	21,0	8,5	8,5	8,5	24,5	24,5	24,5	10,0	10,0	10,0	28,0	28,0	28,0	12,0	12,0	12,0
Maximum Input power		kW	4,44	4,64	4,84	5,15	5,42	5,62	5,17	5,41	5,64	6,06	6,37	6,61	5,91	6,18	6,45	7,27	7,65	7,94
Maximum number of connectable indoor units			6			6			8			8			9			9		
Air volume	Cooling / Heating	m <sup>3</sup> /min	95			95			104			104			104			104		
Sound pressure	Cooling (Hi / Lo)	dB(A)	50 / 47			50 / 47			51 / 48			51 / 48			52 / 49			52 / 49		
	Heating (Hi / Lo)	dB(A)	52 / 49			52 / 49			53 / 50			53 / 50			55 / 52			55 / 52		
Sound power	Cooling (Hi)	dB	68			68			69			69			70			70		
	Heating (Hi)	dB	70			70			71			71			73			73		
Dimensions	H x W x D	mm	1.330 x 940 x 340			1.330 x 940 x 340			1.330 x 940 x 340			1.330 x 940 x 340			1.330 x 940 x 340			1.330 x 940 x 340		
Net weight		kg	104			103			104			103			104			103		
Piping connections	Liquid pipe	Inch (mm)	3/8 (9,52)			3/8 (9,52)			3/8 (9,52)			3/8 (9,52)			3/8 (9,52)			3/8 (9,52)		
	Gas pipe	Inch (mm)	5/8 (15,88)			5/8 (15,88)			5/8 (15,88)			5/8 (15,88)			3/4 (19,05)			3/4 (19,05)		
Refrigerant (R410A)		kg / TCO <sub>2</sub> Eq.	3,5 / 7,308			3,5 / 7,308			3,5 / 7,308			3,5 / 7,308			3,5 / 7,308			3,5 / 7,308		
Operating range	Cooling Min - Max	°C	-10 ~ +46			-10 ~ +46			-10 ~ +46			-10 ~ +46			-10 ~ +46			-10 ~ +46		
	Heating Min - Max	°C	-20 ~ +24 / -20 ~ +18			-20 ~ +24 / -20 ~ +18			-20 ~ +24 / -20 ~ +18			-20 ~ +24 / -20 ~ +18			-20 ~ +24 / -20 ~ +18			-20 ~ +24 / -20 ~ +18		

1) EER and COP classification is at 400 V in accordance with EU directive 2002/31/EC.



# MINI ECOi

## HIGH EFFICIENCY 8-10HP

Prepare to be blown away by Panasonic's New Mini VRF system. The New Mini VRF compact system is the ideal solution for minimum outdoor space. Panasonic extends the Mini VRF range by 8 and 10HP units.

### Increase external static pressure

When unit is installed at the narrow balcony, the fence at front side will be the obstacle. High external static pressure feature will keep the operating capacity and good advantage.

### High ambient temperature performance

Cooling operation range up to 46°C. The system can maintain the rated (100%) capacity up to 40°C by 8HP model & up to 37°C by 10HP model.

### Technical focus

- Piping flexibility 150m maximum piping length
- High efficiency
- 15 indoor units connectable
- Quiet operation mode (one of the lowest in the market)
- High ambient temp performance
- High static pressure 35Pa



HP			8HP			10HP		
Model			U-8LE1E8*			U-10LE1E8*		
Power supply	Voltage	V	380	400	415	380	400	415
	Phase		Three Phase			Three Phase		
	Frequency	Hz	50Hz			50Hz		
Cooling capacity		kW	22,40			28,00		
EER <sup>1)</sup>		W/W	3,80			3,11		
Running amperes		A	9,60	9,15	8,80	14,70	14,00	13,50
Input power cooling		kW	5,89			9,00		
Heating capacity		kW	25,00			28,00		
COP <sup>1)</sup>		W/W	4,02			3,93		
Running amperes		A	10,20	9,65	9,30	11,60	11,10	10,70
Input power heating		kW	6,22			7,13		
Starting amperes		A	1,00			1,00		
Maximum amperes		A	13,70			19,60		
Maximum Input power		kW	9,16			13,10		
Maximum number of connectable indoor units			15 <sup>2)</sup>			15 <sup>2)</sup>		
External static pressure		Pa	0 - 35			0 - 35		
Air volume	Cooling / Heating	m <sup>3</sup> /min	150			160		
	Cooling	dB(A)	60			63		
Sound pressure	Cooling (Silent 1 / 2 / 3)	dB(A)	57 / 55 / 53			60 / 58 / 56		
	Heating	dB(A)	64			65		
Sound power	Cooling / Heating	dB	81 / 85			84 / 86		
Dimensions / Net weight	H x W x D	mm / kg	1.500 x 980 x 370 / 132			1.500 x 980 x 370 / 133		
Piping connections	Liquid pipe	Inch (mm)	3/8 (9,52) <sup>3)</sup> / 1/2 (12,70) <sup>4)</sup>			3/8 (9,52) <sup>3)</sup> / 1/2 (12,70) <sup>4)</sup>		
	Gas pipe	Inch (mm)	3/4 (19,05) <sup>3)</sup> / 7/8 (22,22) <sup>4)</sup>			7/8 (22,22) <sup>3)</sup> / 1 (25,40) <sup>4)</sup>		
Max piping length range (total)		m	7,5 - 150 (7,5 - 300)			7,5 - 150 (7,5 - 300)		
Elevation difference (in/out)		m	50 (Outdoor unit upper) / 40 (Outdoor unit lower)			50 (Outdoor unit upper) / 40 (Outdoor unit lower)		
Refrigerant (R410A)		kg / TCO <sub>2</sub> Eq.	6,3 (24,0) / 13,1544			6,6 (24,0) / 13,7808		
Maximum allowable indoor / outdoor capacity ratio		%	50 - 130			50 - 130		
Operating range	Cooling / Heating Min - Max	°C	-10 - +46 / -20 - +18			-10 - +46 / -20 - +18		

1) EER and COP classification is at 400 V in accordance with EU directive 2002/31/EC. 2) If the heating utilized, it is necessary to increase 1 size with respect to the main liquid pipe, depending on the combination of the indoor unit. 3) Under 90m for ultimate indoor unit. 4) Over 90m for ultimate indoor unit. If the longest piping equivalent length exceeds 90m, increase the sizes of the main tubes by 1 rank for gas and liquid pipes. \* Tentative data.



# NEW 2-PIPE ECOi EX THE GAME CHANGER





VRF with extraordinary energy-saving performance and powerful operation EER 4,70 (8HP model).



A game-changing VRF system delivering energy-saving performance, powerful operation, reliability and comfort surpassing anything previously possible. It represents a true paradigm shift in air conditioning solutions. Taking quality to the extreme — that's the Panasonic challenge.

# 1

## High performance at extreme conditions

ECOi EX is highly reliable, with strong cooling & heating power, even when operating at extreme ambient temperatures. The units can operate at 100% of capacity at 43°C, reaching a great cooling operation up to 52°C and in heating -25°C.

Also, the ECOi EX features include Bluefin in newly designed heat exchanger improving efficiency as well in marine ambient. A silicone coated PCB (Printed Circuit Board) protects the unit from being damaged by environmental factors such as moisture and dust.

# 2

## TOP efficiency and comfort

The new ECOi EX system is designed to dramatically increase energy efficiency by delivering the highest ESEER rating, as well as high efficiency for part-load operations. The system has reduced energy costs thanks to "All-Inverter Compressors", with independent control to deliver highly flexible performance. Also, the ECOi EX features an enlarged heat exchanger with triple surfaces that allow for improved heat transfer and a newly designed curved air discharge bell-mouth for better aerodynamics. The three-stage oil recovery design makes it able to minimise the frequency of forced oil recovery, leading to reduced energy costs and sustained comfort.

# 3

## Superior flexibility

With its up to 1000 meters of pipeline, its maximum 30 meters height difference between indoor units and its 200 meters length, the design possibilities have grown exponentially making the new ECOi EX the ideal air conditioning option for long haul buildings, such as train stations, airports, schools or hospitals. These advantages are enhanced with the wide range of indoor unit models and capacities facilitating the perfect adaptation to all kind of projects. The careful selection of controls and peripherals such as the Pump Down, the AHU or/and the chiller, enables an optimum system use. Connectable Maximum allowable indoor / outdoor capacity ratio up to 200%.



# NEW TWIN ROTARY INVERTER COMPRESSOR

## New twin rotary inverter compressor

Two independently controlled inverter compressors achieve high efficiency. Redesigned components in the body provide performance improvement especially in the rated cooling condition and EER performance.

- Wider and flexible control on Inverter compressor
- Better oil lubrication
- Smooth start up



## Extraordinary energy-saving performance

Designed for Actual Operation Performance. Panasonic builds air conditioning systems not only with a high EER for rated operation, but also with Seasonal-EER appropriate to the customer's actual environment of use. For instance, with rated operation, outdoor temperature is constant at 35°C, but in reality the outdoor temperature is continuously changing. Consequently, required air conditioning performance also changes. That's why Panasonic implements the following kind of proprietary control.

1. Set temperature is rapidly attained; full-load operating time is kept to a minimum.
2. The frequency of forced oil recovery is minimised. The volume of oil within the compressors is monitored precisely by sensors, so forced oil recovery under full-load operation is conducted only when necessary. Since this suppresses noise due to oil recovery, comfort is maintained.
3. Panasonic pursues a high EER, of course, as well as high EER in part load, for energy saving performance under a broad range of loads. Panasonic's design concept contributes to substantial energy cost reductions.

## Compressor efficiency electric system VRF.

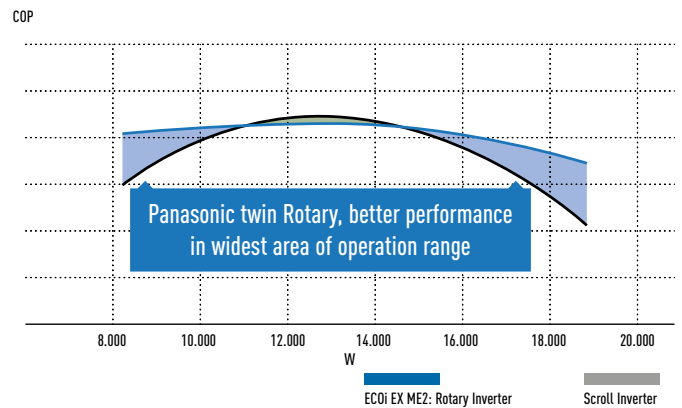

## Number of Inverter compressors

Size	Small		Medium		Large			
HP	8HP	10HP	12HP	14HP	16HP	18HP	20HP	
Number	1 pc.		1 pc.		2 pcs.		2 pcs.	

## Actual operation data graph of Panasonic VRF

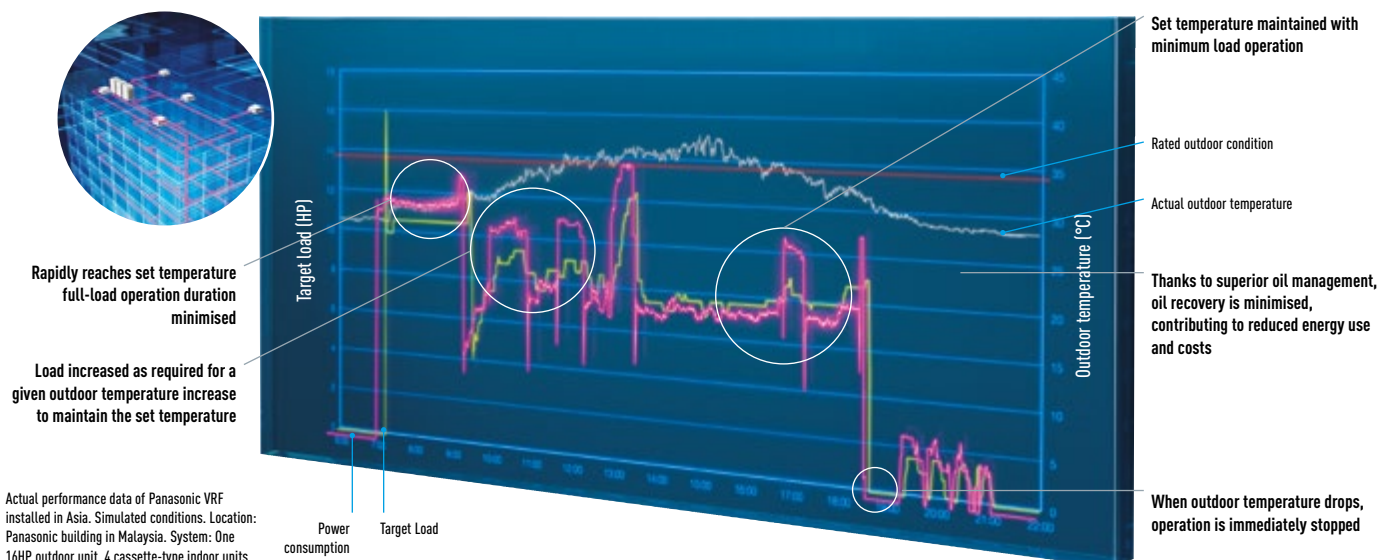

# HIGH PERFORMANCE AT EXTREME CONDITIONS

The ECOi EX can still operate at 100% capacity when the outside temperature is as high as 43°C. This high power capability enables reliable operation even under extremely high temperature conditions.

## Trusted reliability even under high and low temperature conditions

Designed to be durable enough to withstand extreme heat, ECOi EX ensures reliable cooling operation over an extended operation range up to 52°C, and heating operation also at minus -25°C.

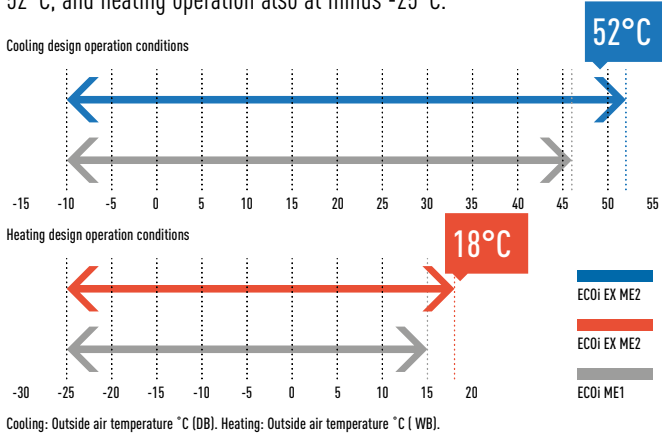

## Extremely high capacity at -20°C and unique heating capacity at -25°C

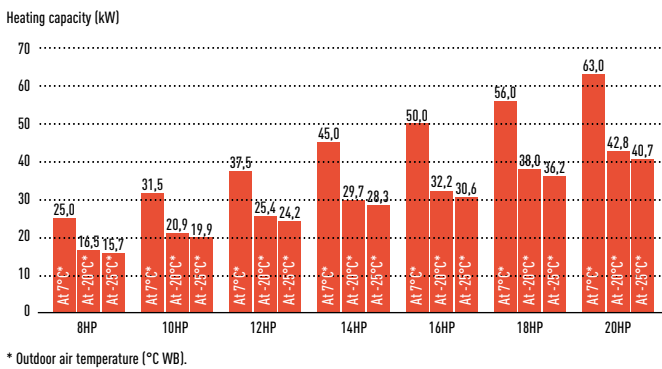

## Hi-durability outdoor unit

Corrosion-resistance treated for high resistance to rust and salty air to assure long-lasting performance.

### Specially protected parts

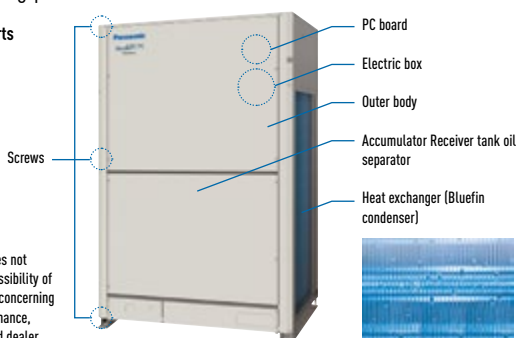

Note: Selecting this unit does not completely eliminate the possibility of rust developing. For details concerning unit installation and maintenance, please consult an authorised dealer.

## Bluefin full line up EX

### Optimised and new design heat exchanger for better surface area with triple surface\*.

The new heat exchanger features a triple-surface construction. Compared to the divided dual-surface construction in current models, there is no division of space and the area for heat exchange is larger. Also, highly efficient piping pattern increases heat exchange performance by 5%.

\* For 8 & 10HP unit, the heat exchanger is 2 row design.

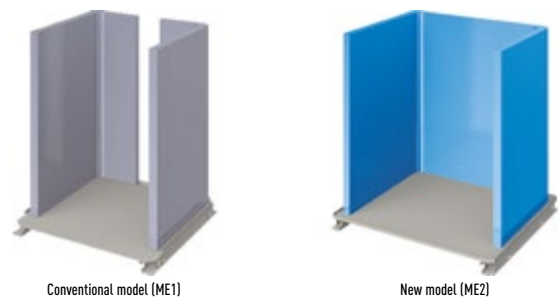

### Extreme outdoor ambient conditions.

Including Bluefin in a newly designed heat exchanger improves efficiency, especially in marine environments.

A silicone coated PCB (Printed Circuit Board) protects the unit from being damaged by environmental factors such as moisture and dust.

## High safety operation in case of breakdown!

### Automatic Back-Up operation. Ensures heating and cooling.

It is possible for the system to keep working, even if the compressors, fan motor and the temperature sensor are damaged (even when compressor fails in single unit with 2 compressor inside).

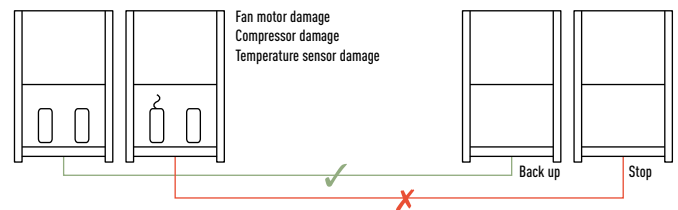

### The system will still operate up to 25% of the connected indoor units.

System will not stop when up to 25% of indoor units have power supply breakdown when they are ON Mode.

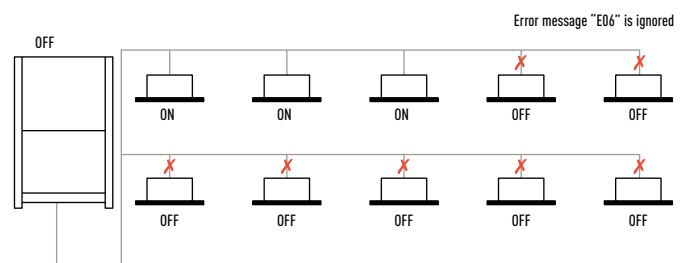

# TOP EFFICIENCY AND COMFORT

Remarkable improvement on key components: extraordinary energy-saving performance and redesigned for smooth and better air discharge.

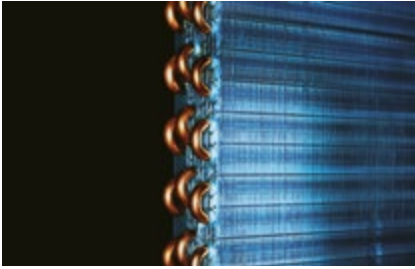

Enlarged heat exchanger surface area with triple surface.

\* For 8 & 10HP unit, the heat exchanger is 2 row design.



Multiple large-capacity all inverter compressors (more than 14HP).



Newly designed curved air discharge bell mouth for better aerodynamics.

## Improvements on refrigerant circuit

### Compressor.

Redesigned components in the body provide performance improvement especially in the rated cooling condition and AEER performance.



### Accumulator.

New oil returning circuit with control valve makes efficient oil recovery to compressor.

### Oil separator.

Modified tank design makes efficient oil separation with less pressure drop.



### Receiver tank less design.

Improved refrigerant control program recovers the remaining refrigerant gas in the system back to the accumulator tank effectively.



## Smooth exhaust flow by new bell-mouth

The new curved shape with integrated top and bottom assure smooth exhaust flow. This gives more air-volume with same sound level, less input power at same air volume.

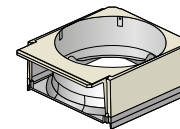

Conventional model (ME1)

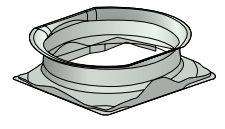

New model (ME2)

Sound pressure dB(A)

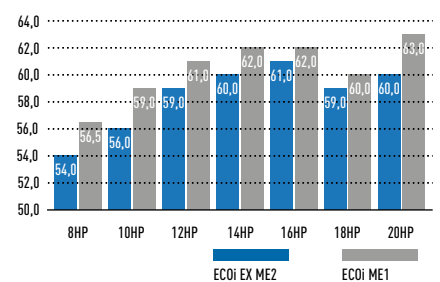

## Combined 3 surface heat exchanger

The highly efficient piping pattern increases heat exchange performance by 5%. The new heat exchanger features a 3 surface construction.

Compared to the divided dual-surface construction in current models, there is no divided space and the face area of heat exchanger becomes larger.



Conventional model (ME1)



New model (ME2)



# OIL RECOVERY INTELLIGENT CONTROL

## Intelligent 3-stage Oil Management System

In a VRF system, where lengthy piping and a large number of indoor units need to be controlled collectively, the key to maintaining the system's reliability is to ensure an appropriate amount of oil is secured in the compressors. In order to avoid oil shortage in the compressor, maximum operation is normally forcibly conducted at regular intervals to recover oil from indoor units. This method, typically employed in a standard VRF, causes the system to overheat or overcool and thus waste energy. In Panasonic VRF systems, a sensor for detecting oil levels is mounted in each compressor. In installations with multiple outdoor units, a shortage of oil in one compressor can be compensated for by recovering oil either from another compressor in the same unit, from a compressor in an adjacent outdoor unit, or from a connected indoor unit. Panasonic VRF systems provide users with a comfortable environment whilst saving energy.

## Oil recovery intelligent control advantages:

1. Higher efficiency
2. Durability
3. Comfort:
  - Continuous operation
  - Low noise
  - Low vibration

## Features of oil recovery design

### Oil sensors installed in each compressor.

Oil sensors installed in each Panasonic compressor precisely monitor oil levels, eliminating unnecessary oil recovery.

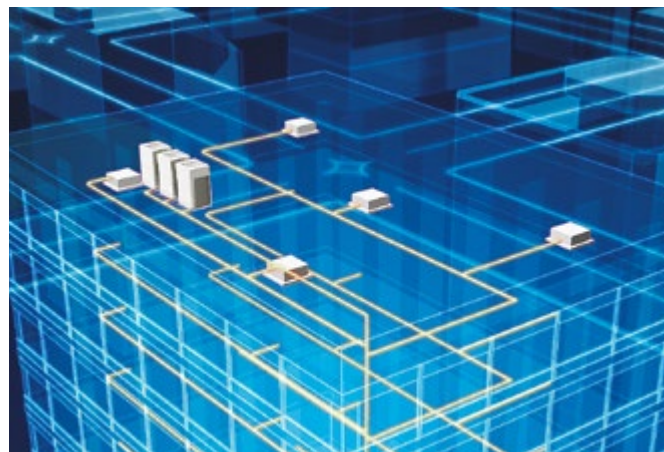
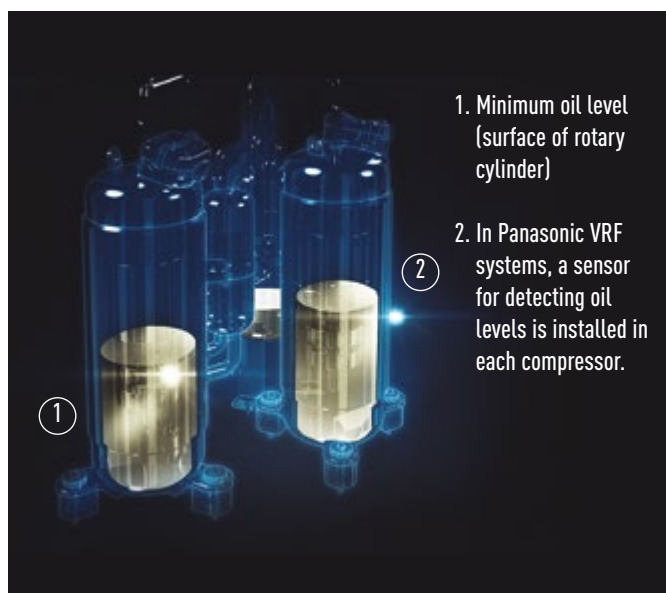

**The Panasonic system efficiently manages oil recovery in three stages; minimising the frequency of forced oil recovery while reducing energy cost and maintaining comfort.**

**STAGE-1:** Panasonic compressors are equipped with sensors which monitor oil levels precisely at all times. If oil levels fall, oil can be transferred from other compressors within the same outdoor unit.

**STAGE-2:** If oil levels in all compressors within the outdoor unit fall, oil can be replenished from adjacent outdoor units.

**STAGE-3:** Forced oil recovery is implemented only if oil levels become insufficient in spite of above measures. The Panasonic system's design concept is radically different from conventional oil systems.

### Highly functional oil separator.

Thanks to extended separate piping, oil recovery efficiency reaches 90%, minimising the oil to be discharged from the compressor.



# EXTRAORDINARY PARTIAL LOAD AND SEER/SCOP

## Efficiency in VRF systems

The only way to compare so far, was the nominal efficiency at outdoor ambient temperature of 35°C (EER) in Cooling and at 7°C in heating (COP). With new EN-14825 seasonal efficiency will be shown, the result will be SEER and SCOP. New ECOi EX is reaching excellent performance without using any additional saving functions.

## The highest EER/COP rating in most capacities

### Compared to conventional model ECOi (ME1)

The ECOi EX marks a revolutionary step forward in VRF efficiency. A look at the incredible EER/COP value clearly indicates that. What's more, this high EER/COP value is achieved even during part load operation. This shows the extraordinary energy-saving performance the ECOi EX is capable of providing.

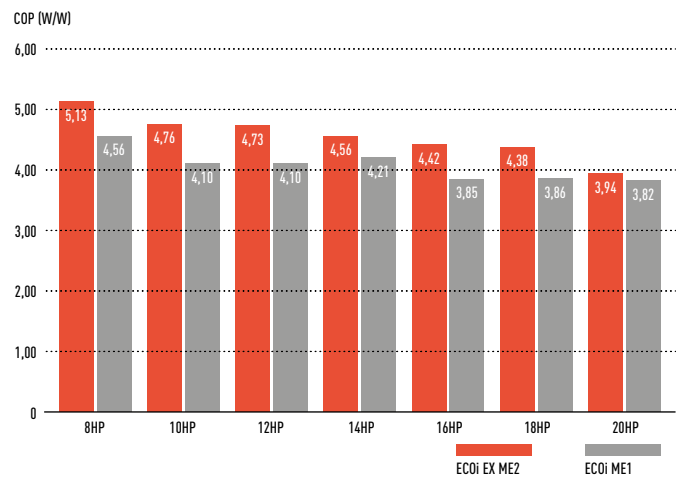
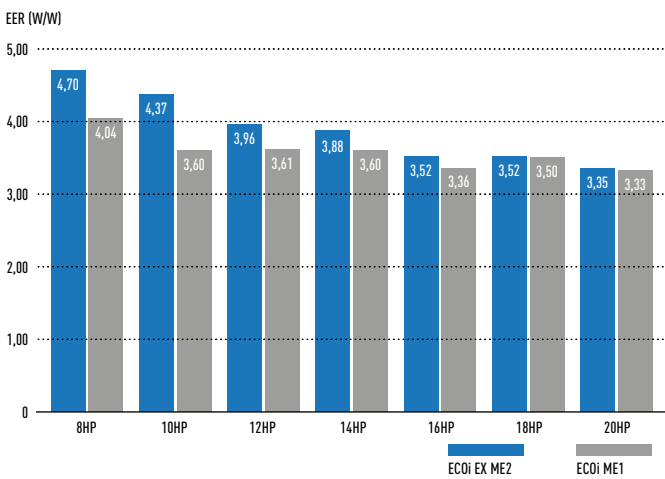

## Partial load for seasonal and real system efficiency

VRF units are designed to adapt to the heating and cooling demand, adapting its performance to different outdoor conditions. When compressor runs at lower than 100% capacity, the system is working at partial load. A wider compressor operating range results in better system performance both at full load and partial load conditions. Panasonic ECOi EX partial load is excellent, reaching a minimum of 15% of compressor capacity.

## Excellent efficiency at any condition and partial load

In both heating and cooling mode, Panasonic ECOi EX is reaching exceptional levels of efficiency.

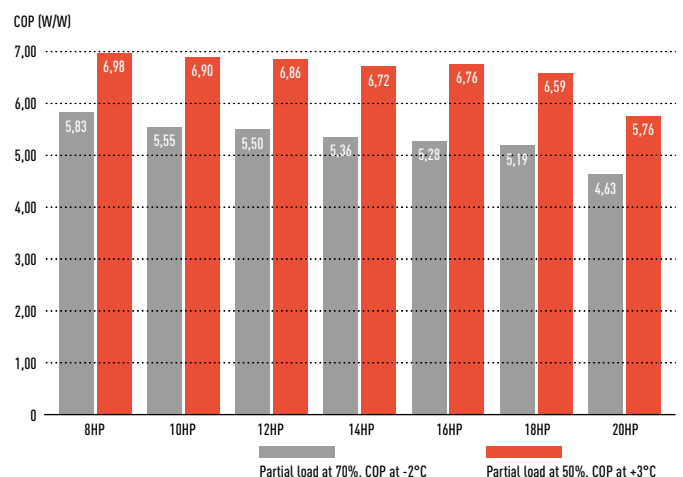
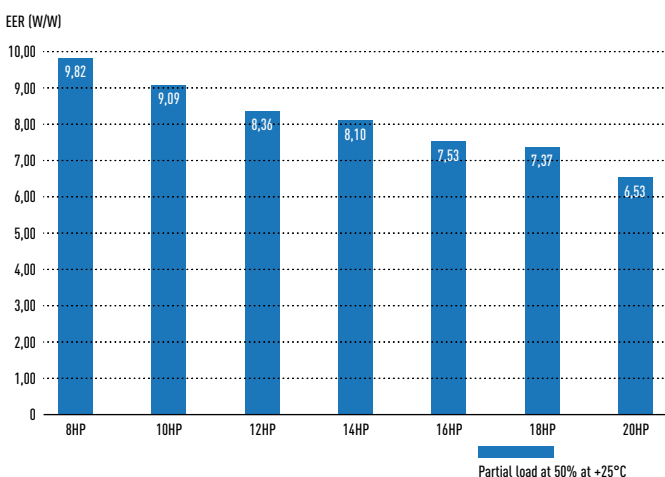

### SEER and SCOP according to EN-14825

When better partial load, better efficiency is achieved in real operation. New EN-14825 is showing the way to calculate considering full year operation hours at different conditions. New Panasonic ECOi EX is designed to save energy in any partial load conditions. Most of operation hours system is under partial load conditions, 80% of total operation hours is less than 70% of full load.

In below graphs is the example for average ambient conditions, this uses Strasbourg ambient conditions for calculation.

Outside temperature distribution

Time distribution (hours / year)

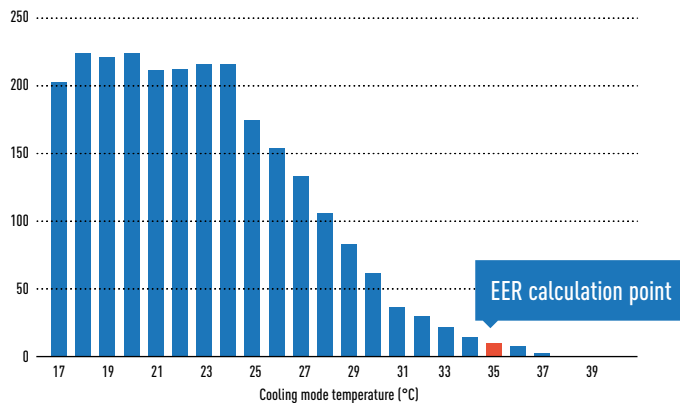

Outside temperature distribution

Time distribution (hours / year)

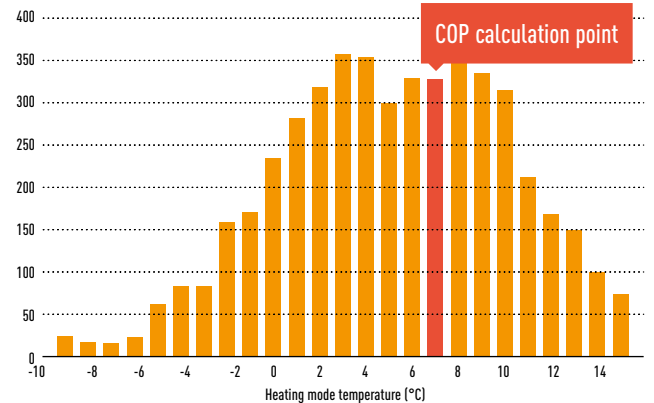

In the characteristics EER and COP only a single temperature for the assessment of the efficiency is taken as a basis in each case. Data calculated under EN-14825 conditions, not additional saving function considered for this calculation. Compressor frequency according to ambient temperature and building design.

### Pure SEER and SCOP values

Considering Strasbourg operation hours at different ambient temperatures we can calculate real SEER and SCOP under EN-14825 calculation. For this calculation Panasonic is NOT using any additional saving function that could increase the efficiency.

SEER/SCOP (W/W)

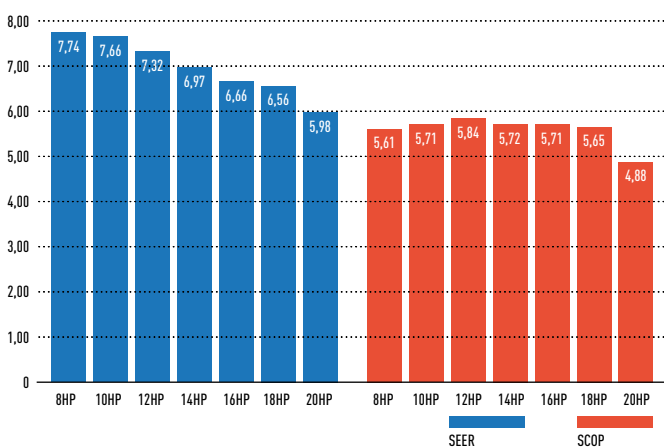

However, if it was necessary by setting on commissioning Panasonic, can increase efficiency additionally by "20%" increasing evaporation refrigerant temperature range, for a higher efficiency and lower energy consumption.

ESEER (W/W)

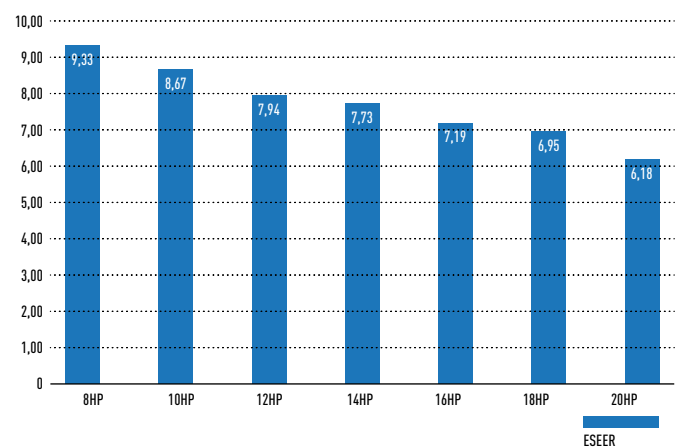

# SUPERIOR FLEXIBILITY

## Increased piping lengths and design flexibility

Adaptable to various building types and sizes. Actual piping length: 200m.  
Maximum piping length: 1.000m.

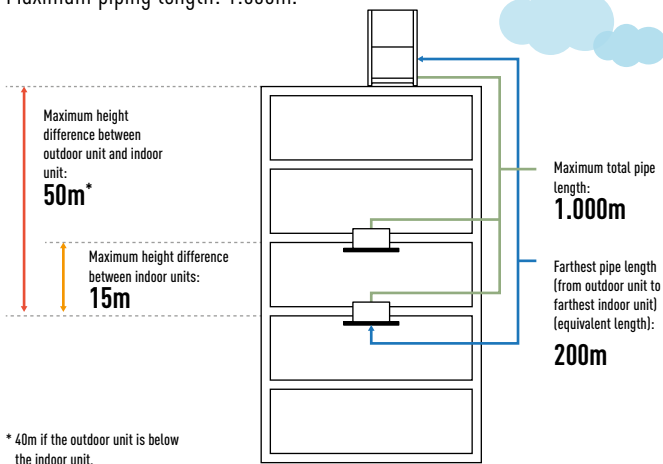

\* 40m if the outdoor unit is below the indoor unit.

Please contact to an authorized Panasonic dealer in the case  
50 < Max height length between OU and IU ≤ 90  
or 15 < Max height difference between IUs ≤ 30

## Up to 50m length difference between the longest and the shortest piping from the first branch

Flexible piping layout makes it easier to design systems for locations such as train stations, airports, schools and hospitals.

- Up to 64 units can be connected to one system
- Difference between maximum and minimum pipe runs after first branch can be a maximum of 50m
- Larger pipe runs can be up to 200m

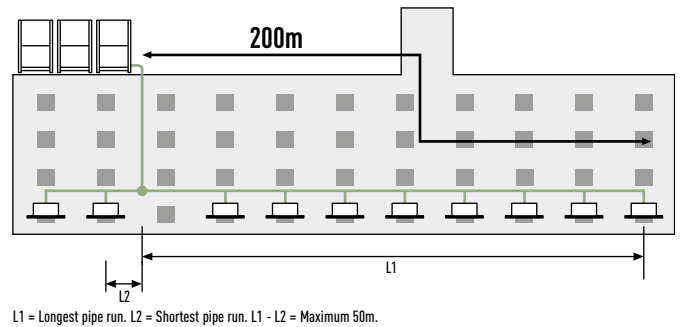

## Connectable Maximum allowable indoor / outdoor capacity ratio up to 200%\*

ECOi EX attain maximum indoor unit connection capacity of up to 130% of the unit's connection range. This limit can be overpassed and reach up to 200% if some conditions are satisfied. With this feature, ECOi EX provides an ideal air conditioning solution for locations where full cooling/heating are not always required in all spaces at same time.

System ( HP )	8	10	12	14	16	18	20	22	24	26	28	30	32	34	36	38	40	42	44	46	48	50	52	54	56	58	60	62	64	66	68	70	72	74	76	78	80
Connectable indoor units: 130%	13	16	19	23	26	29	33	36	40	43	46	50	53	56	59												64										
Connectable indoor units: 200%	20	25	30	35	40	45	50	55	60																		64										

Note: If more than 100% indoor units are operated with a high load, the units may not perform at the rated capacity. For the details, please consult with an authorised Panasonic dealer. \* If the following conditions are satisfied, the effective range is above 130 % up to 200 %. Obey the limited number of connectable indoor units. The lower limit of operating range for heating outdoor temperature is limited to -10°C WB (standard -25°C WB). Simultaneous operation is limited to less than 130% of connectable indoor units. 1.5kW capacity of Indoor Units are included.

## A large number of indoor unit models can be connected

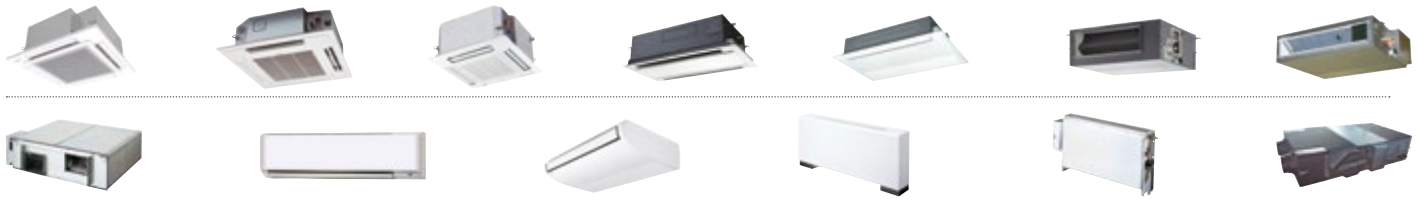

## Compact design

The new ME2 series has reduced the installation space required with up to 20HP available in a single chassis. 8-10HP are able to fit inside a lift for easy handling on site.

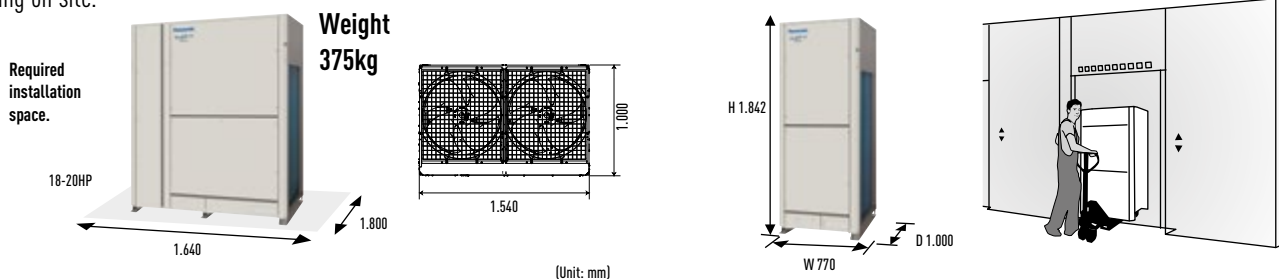



# PIPING DESIGN

Select installation locations so that the lengths and sizes of refrigerant piping are within the allowable ranges shown in the figure below.

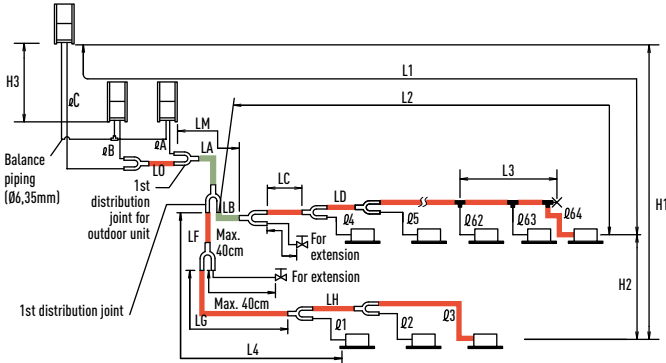

- Main piping length (maximum piping size) LM= LA + LB ...
- Main distribution tubes LC - LH are selected according to the capacity after the distribution joint.
- Sizes of indoor unit connection piping Ø1 - Ø64 are determined by the connection piping sizes on the indoor units.
- Distribution joint (CZ: optional parts)
- T-joint (field supply)
- Ball valve (field supply)
- Solidly welded shut (pinch weld)

The outdoor connection main piping (LO portion) is determined by the total capacity of the outdoor units that are connected to the tube ends.  
 Note: Be sure to use special R410A distribution joints (CZ: optional parts) for outdoor unit connections and piping branches.

- R410A distribution joint**  
 CZ-P680PJ2 (for outdoor unit)  
 CZ-P1350PJ2 (for outdoor unit)  
 CZ-P160BK2 (for indoor unit)  
 CZ-P680BK2 (for indoor unit)  
 CZ-P1350BK2 (for indoor unit)

## Ranges that apply to refrigerant piping lengths and to differences in installation heights

Items	Mark	Contents	Length (m)
Allowable piping length	L1	Maximum piping length	Actual length ≤200 <sup>1)</sup> Equivalent length ≤210 <sup>1)</sup>
	Δ L (L2-L4)	Difference between Maximum length and min. length from the 1st distribution joint	≤50 <sup>2)</sup>
	LM	Maximum length of main piping (at maximum size) * Even after 1st distribution joint, LM is allowed if at maximum piping length.	- <sup>3)</sup>
	Ø1, Ø2 - Ø64	Maximum length of each distribution tube	≤50 <sup>4)</sup>
	L1+ Ø1+ Ø2- Ø63+ ØA+ ØB+LF+LG+LH	Total Maximum piping length including length of each distribution tube (only liquid piping)	≤1000
	ØA, ØB+LO, ØC+LO	Maximum piping length from outdoor's 1st distribution joint to each outdoor unit	≤10
Allowable elevation difference	H1	When outdoor unit is installed higher than indoor unit When outdoor unit is installed lower than indoor unit	≤50 ≤40
	H2	Maximum difference between indoor units	≤15 <sup>5)</sup>
	H3	Maximum difference between outdoor units	≤4
Allowable length of joint piping	L3	T-joint piping (field-supply); Maximum piping length between the first T-joint and solidly welded-shut end point	≤2

L = Length, H = Height

1) If the longest piping length (L1) exceeds 90m (equivalent length), increase the sizes of the main tubes (LM) by 1 rank for gas tubes and liquid tubes. Use a field supply reducer. Select the tube size from the table of main piping sizes (Table 3) and from the table of refrigerant piping sizes (Table 8) on the second following page. 2) When the piping length exceeds 40m, increase a longer liquid or gas piping by 1 rank. Refer to the Technical Data for the details. 3) If the longest main piping length (LM) exceeds 50m, increase the main piping size at the portion before 50m by 1 rank for the gas tubes. Use a field supply reducer. Determine the length less than the limitation of allowable maximum piping length. For the portion that exceeds 50m, set based on the main piping size (LA) listed in Table 3. 4) If any of the piping length exceeds 30m, increase the size of the liquid and gas tubes by 1 rank. 5) If the total distribution piping length exceeds 500m, maximum allowable elevation difference (H2) between the indoor units is calculated by the following formula. Make sure the indoor unit's actual elevation difference should fall within the figure calculated as follows. Unit of account (meter):  $15 \times (2 - \text{total piping length(m)} \div 500)$

\* The outdoor connection main piping (LO portion) is determined by the total capacity of the outdoor units that are connected to the tube ends. If the size of the existing piping is already larger than the standard piping size, it is not necessary to further increase the size.  
 \*\* If the existing piping is used, and the amount of on-site refrigerant charge exceeds the value listed below, then change the size of the piping to reduce the amount of refrigerant. Total amount of refrigerant for the system with 1 outdoor unit: 50kg. Total amount of refrigerant for the system with 2 outdoor units: 80kg. Total amount of refrigerant for the system with 3 outdoor units or 4 outdoor units: 105kg.

## Necessary amount of additional refrigerant charge per outdoor unit.

U-8ME2E8	U-10ME2E8	U-12ME2E8	U-14ME2E8	U-16ME2E8
5,5kg	5,5kg	7,0kg	7,0kg	7,0kg

## System limitations.

Maximum number allowable connected outdoor units	4 <sup>1)</sup>
Maximum capacity allowable connected outdoor units	224kW (80HP)
Maximum connectable indoor units	64 <sup>2)</sup>
Maximum allowable indoor / outdoor capacity ratio	50-130% <sup>3)</sup>

- 1) Up to 4 units can be connected if the system has been extended.
- 2) In the case of 38HP or smaller units, the number is limited by the total capacity of the connected indoor units.
- 3) If the following conditions are satisfied, the effective range is above 130% and below 200%.
  - i) Obey the limited number of connectable indoor units.
  - ii) The lower limit of operating range for heating outdoor temperature is limited to -10°C WB (standard -25°C WB).
  - iii) Simultaneous operation is limited to less than 130% of connectable indoor units.

## Additional refrigerant charge.

Liquid piping size Inch (mm)	Amount of refrigerant charge/m (g/m)
1/4 (6,35)	26
3/8 (9,52)	56
1/2 (12,7)	128
5/8 (15,88)	185
3/4 (19,05)	259
7/8 (22,22)	366
1 (25,4)	490

## Refrigerant piping (existing piping can be used).

Piping size (mm)				Material Temper - 1/2 H, H			
Material Temper - 0				Material Temper - 1/2 H, H			
Ø6,35	t 0,8	Ø15,88	t 1,0	Ø22,22	t 1,0	Ø38,1	over t 1,35
Ø9,52	t 0,8	Ø19,05	t 1,2	Ø25,4	t 1,0	Ø41,28	over t 1,45
Ø12,7	t 0,8			Ø28,58	t 1,0	Ø44,45	over t1,55
				Ø31,75	t 1,1		

\* When bending the tubes, use a bending radius that is at least 4 times the outer diameter of the tubes. In addition, take sufficient care to avoid crushing or damaging the tubes when bending them.

# 2-PIPE ECOi EX ME2 SERIES HIGH EFFICIENCY MODEL

Units			8HP	10HP	12HP	14HP	16HP
Model name			U-8ME2E8	U-10ME2E8	U-12ME2E8	U-14ME2E8	U-16ME2E8
Power supply	Voltage	V	380 / 400 / 415	380 / 400 / 415	380 / 400 / 415	380 / 400 / 415	380 / 400 / 415
	Phase		Three Phase	Three Phase	Three Phase	Three Phase	Three Phase
	Frequency	Hz	50	50	50	50	50
Cooling capacity	kW		22,4	28,0	33,5	40,0	45,0
EER	W/W		4,70	4,37	3,96	3,88	3,52
ESSER	W/W		9,33	8,67	7,94	7,73	7,19
SEER <sup>1)</sup>	W/W		<b>7,74</b>	<b>7,66</b>	<b>7,32</b>	<b>6,97</b>	<b>6,66</b>
Running current cooling	A		7,40 / 7,14	10,20 / 9,80	13,00 / 12,50	16,50 / 15,90	20,10 / 19,40
Input power cooling	kW		4,77	6,41	8,47	10,30	12,80
Heating capacity	kW		25,0	31,5	37,5	45,0	50,0
COP	W/W		5,13	4,76	4,73	4,56	4,42
SCOP <sup>2)</sup>	W/W		<b>5,61</b>	<b>5,71</b>	<b>5,84</b>	<b>5,72</b>	<b>5,71</b>
Running current heating	A		7,56 / 7,29	10,50 / 10,10	12,30 / 11,80	15,80 / 15,20	17,90 / 17,30
Input power heating	kW		4,87	6,62	7,92	9,86	11,30
Starting current	A		1	1	1	2	2
External static pressure (Max)	Pa		80	80	80	80	80
Air volume	m <sup>3</sup> /min		224	224	232	232	232
Sound pressure	Normal mode	dB(A)	54,0	56,0	59,0	60,0	61,0
	Silent mode	dB(A)	51,0	53,0	56,0	57,0	58,0
Sound power	Normal mode	dB	75,0	77,0	80,0	81,0	82,0
Dimensions	H x W x D	mm	1.842 x 770 x 1.000	1.842 x 770 x 1.000	1.842 x 1.180 x 1.000	1.842 x 1.180 x 1.000	1.842 x 1.180 x 1.000
Net weight	kg		210	210	270	315	315
Piping connections <sup>3)</sup>	Liquid pipe	Inch (mm)	3/8 (9,52) / 1/2 (12,70)	3/8 (9,52) / 1/2 (12,70)	1/2 (12,70) / 5/8 (15,88)	1/2 (12,70) / 5/8 (15,88)	1/2 (12,70) / 5/8 (15,88)
	Gas pipe	Inch (mm)	3/4 (19,05) / 7/8 (22,22)	7/8 (22,22) / 1 (25,40)	1 (25,40) / 1-1/8 (28,58)	1 (25,40) / 1-1/8 (28,58)	1-1/8 (28,58) / 1-1/4 (31,75)
	Balance pipe	Inch (mm)	1/4 (6,35)	1/4 (6,35)	1/4 (6,35)	1/4 (6,35)	1/4 (6,35)
Refrigerant (R410A)	kg / TCO: Eq.		5,6 / 11,6928	5,6 / 11,6928	8,3 / 17,3304	8,3 / 17,3304	8,3 / 17,3304
Maximum allowable indoor / outdoor capacity ratio % <sup>4)</sup>			50 ~ 130 (200)	50 ~ 130 (200)	50 ~ 130 (200)	50 ~ 130 (200)	50 ~ 130 (200)
Operating range	Cooling Min ~ Max	°C	-10 ~ +52	-10 ~ +52	-10 ~ +52	-10 ~ +52	-10 ~ +52
	Heating Min ~ Max	°C	-25 ~ +18	-25 ~ +18	-25 ~ +18	-25 ~ +18	-25 ~ +18

Combinations			18HP	20HP	22HP	24HP	26HP	28HP	30HP	32HP	34HP	36HP
Model name			U-18ME2E8	U-20ME2E8	U-22ME2E8	U-24ME2E8	U-26ME2E8	U-28ME2E8	U-30ME2E8	U-32ME2E8	U-34ME2E8	U-36ME2E8
Model name			U-8ME2E8 U-10ME2E8	U-10ME2E8 U-10ME2E8	U-10ME2E8 U-12ME2E8	U-12ME2E8 U-12ME2E8	U-10ME2E8 U-16ME2E8	U-12ME2E8 U-16ME2E8	U-14ME2E8 U-16ME2E8	U-16ME2E8 U-16ME2E8	U-10ME2E8 U-12ME2E8	U-10ME2E8 U-12ME2E8
Power supply	Voltage	V	380 / 400 / 415	380 / 400 / 415	380 / 400 / 415	380 / 400 / 415	380 / 400 / 415	380 / 400 / 415	380 / 400 / 415	380 / 400 / 415	380 / 400 / 415	380 / 400 / 415
	Phase		Three Phase	Three Phase	Three Phase	Three Phase	Three Phase	Three Phase	Three Phase	Three Phase	Three Phase	Three Phase
	Frequency	Hz	50	50	50	50	50	50	50	50	50	50
Cooling capacity	kW		50,0	56,0	61,5	68,0	73,0	78,5	85,0	90,0	96,0	101,0
EER	W/W		4,55	4,38	4,13	3,93	3,80	3,69	3,68	3,52	4,05	3,95
Running current cooling	A		17,3 / 16,6	20,3 / 19,6	23,1 / 22,3	26,6 / 25,6	30,1 / 29,0	33,1 / 31,9	36,6 / 35,3	40,2 / 38,7	36,8 / 35,5	39,3 / 37,9
Input power cooling	kW		11,0	12,8	14,9	17,3	19,2	21,3	23,1	25,6	23,7	25,6
Heating capacity	kW		56,0	63,0	69,0	76,5	81,5	87,5	95,0	100,0	108,0	113,0
COP	W/W		4,96	4,77	4,76	4,69	4,55	4,56	4,48	4,42	4,72	4,73
Running current heating	A		17,7 / 17,1	20,9 / 20,2	22,7 / 21,9	25,3 / 24,4	28,4 / 27,4	30,1 / 29,0	33,6 / 32,4	35,8 / 34,6	35,9 / 34,6	37,1 / 35,8
Input power heating	kW		11,3	13,2	14,5	16,3	17,9	19,2	21,2	22,6	22,9	23,9
Starting current	A		2	2	2	2	3	3	4	4	3	3
External static pressure (Max)	Pa		80	80	80	80	80	80	80	80	80	80
Air volume	m <sup>3</sup> /min		448	448	456	464	456	464	464	464	688	696
Sound pressure	Normal mode	dB(A)	58,5	59,0	61,0	62,0	62,5	63,5	63,5	64,0	63,0	64,0
	Silent mode	dB(A)	55,5	56,0	58,0	59,0	59,5	60,5	60,5	61,0	60,0	61,0
Sound power	Normal mode	dB	79,5	80,0	82,0	83,0	83,5	84,5	84,5	85,0	84,0	85,0
Dimensions	H x W x D	mm	1.842 x 1.600 x 1.000	1.842 x 1.600 x 1.000	1.842 x 2.010 x 1.000	1.842 x 2.420 x 1.000	1.842 x 2.010 x 1.000	1.842 x 2.420 x 1.000	1.842 x 2.420 x 1.000	1.842 x 2.420 x 1.000	1.842 x 3.250 x 1.000	1.842 x 3.660 x 1.000
Net weight	kg		420	420	480	540	535	585	630	630	750	810
Piping connections <sup>3)</sup>	Liquid pipe	Inch (mm)	5/8 (15,88) / 3/4 (19,05)	5/8 (15,88) / 3/4 (19,05)	5/8 (15,88) / 3/4 (19,05)	5/8 (15,88) / 3/4 (19,05)	3/4 (19,05) / 7/8 (22,22)	3/4 (19,05) / 7/8 (22,22)	3/4 (19,05) / 7/8 (22,22)	3/4 (19,05) / 7/8 (22,22)	3/4 (19,05) / 7/8 (22,22)	3/4 (19,05) / 7/8 (22,22)
	Gas pipe	Inch (mm)	1-1/8 (28,58) / 1-1/4 (31,75)	1-1/8 (28,58) / 1-1/4 (31,75)	1-1/8 (28,58) / 1-1/4 (31,75)	1-1/8 (28,58) / 1-1/4 (31,75)	1-1/4 (31,75) / 1-1/2 (38,10)	1-1/4 (31,75) / 1-1/2 (38,10)	1-1/4 (31,75) / 1-1/2 (38,10)	1-1/4 (31,75) / 1-1/2 (38,10)	1-1/4 (31,75) / 1-1/2 (38,10)	1-1/2 (38,10) / 1-5/8 (41,28)
	Balance pipe	Inch (mm)	1/4 (6,35)	1/4 (6,35)	1/4 (6,35)	1/4 (6,35)	1/4 (6,35)	1/4 (6,35)	1/4 (6,35)	1/4 (6,35)	1/4 (6,35)	1/4 (6,35)
R410A refrigerant amount	kg / TCO: Eq.		11,2 / 23,3856	11,2 / 23,3856	13,9 / 29,0232	16,6 / 34,6608	13,9 / 29,0232	16,6 / 34,6608	16,6 / 34,6608	16,6 / 34,6608	22,2 / 46,3536	24,9 / 51,9912
Maximum allowable indoor / outdoor capacity ratio % <sup>4)</sup>			50 ~ 130 (200)	50 ~ 130 (200)	50 ~ 130 (200)	50 ~ 130 (200)	50 ~ 130 (200)	50 ~ 130 (200)	50 ~ 130 (200)	50 ~ 130 (200)	50 ~ 130 (200)	50 ~ 130 (200)
Operating range	Cooling Min ~ Max	°C	-10 ~ +52	-10 ~ +52	-10 ~ +52	-10 ~ +52	-10 ~ +52	-10 ~ +52	-10 ~ +52	-10 ~ +52	-10 ~ +52	-10 ~ +52
	Heating Min ~ Max	°C	-25 ~ +18	-25 ~ +18	-25 ~ +18	-25 ~ +18	-25 ~ +18	-25 ~ +18	-25 ~ +18	-25 ~ +18	-25 ~ +18	-25 ~ +18



1) Data obtained with setting by Panasonic commissioning. 2) Tentative data. 3) Pipe diameter under 90m for ultimate indoor unit / over 90m for ultimate indoor unit (if the longest piping equivalent length exceeds 90m, increase the sizes of the main tubes by 1 rank for gas tubes and liquid tubes). 4) If the following conditions are satisfied, the effective range is above 130 % and below 200 %: A. Obey the limited number of connectable indoor units. B. The lower limit of operating range for heating outdoor temperature is limited to -10°C WB (standard -25°C WB). C. Simultaneous operation is limited to less than 130% of connectable indoor units.



NEW TECHNOLOGY 17



	38HP	40HP	42HP	44HP	46HP	48HP	50HP	52HP	54HP	56HP	58HP	60HP	62HP	64HP
	<b>U-38ME2E8</b>	<b>U-40ME2E8</b>	<b>U-42ME2E8</b>	<b>U-44ME2E8</b>	<b>U-46ME2E8</b>	<b>U-48ME2E8</b>	<b>U-50ME2E8</b>	<b>U-52ME2E8</b>	<b>U-54ME2E8</b>	<b>U-56ME2E8</b>	<b>U-58ME2E8</b>	<b>U-60ME2E8</b>	<b>U-62ME2E8</b>	<b>U-64ME2E8</b>
	<b>U-10ME2E8</b> <b>U-12ME2E8</b> <b>U-16ME2E8</b>	<b>U-12ME2E8</b> <b>U-12ME2E8</b> <b>U-16ME2E8</b>	<b>U-10ME2E8</b> <b>U-16ME2E8</b> <b>U-16ME2E8</b>	<b>U-12ME2E8</b> <b>U-16ME2E8</b> <b>U-16ME2E8</b>	<b>U-14ME2E8</b> <b>U-16ME2E8</b> <b>U-16ME2E8</b>	<b>U-16ME2E8</b> <b>U-16ME2E8</b> <b>U-16ME2E8</b>	<b>U-10ME2E8</b> <b>U-12ME2E8</b> <b>U-16ME2E8</b>	<b>U-12ME2E8</b> <b>U-12ME2E8</b> <b>U-16ME2E8</b>	<b>U-10ME2E8</b> <b>U-12ME2E8</b> <b>U-16ME2E8</b>	<b>U-12ME2E8</b> <b>U-12ME2E8</b> <b>U-16ME2E8</b>	<b>U-10ME2E8</b> <b>U-16ME2E8</b> <b>U-16ME2E8</b>	<b>U-12ME2E8</b> <b>U-16ME2E8</b> <b>U-16ME2E8</b>	<b>U-14ME2E8</b> <b>U-16ME2E8</b> <b>U-16ME2E8</b>	<b>U-16ME2E8</b> <b>U-16ME2E8</b> <b>U-16ME2E8</b>
	380 / 400 / 415	380 / 400 / 415	380 / 400 / 415	380 / 400 / 415	380 / 400 / 415	380 / 400 / 415	380 / 400 / 415	380 / 400 / 415	380 / 400 / 415	380 / 400 / 415	380 / 400 / 415	380 / 400 / 415	380 / 400 / 415	380 / 400 / 415
	Three Phase	Three Phase	Three Phase	Three Phase	Three Phase	Three Phase	Three Phase	Three Phase	Three Phase	Three Phase	Three Phase	Three Phase	Three Phase	Three Phase
	50	50	50	50	50	50	50	50	50	50	50	50	50	50
	107,0	113,0	118,0	124,0	130,0	135,0	140,0	145,0	151,0	156,0	162,0	168,0	174,0	180,0
	3,84	3,75	3,69	3,62	3,62	3,52	3,87	3,82	3,75	3,71	3,65	3,60	3,60	3,52
	43,8 / 42,2	46,7 / 45,0	50,2 / 48,4	53,2 / 51,3	56,9 / 54,9	60,2 / 58,1	66,2 / 54,2	59,0 / 56,8	63,2 / 60,9	65,3 / 63,0	69,7 / 67,1	73,3 / 70,6	75,8 / 73,0	80,3 / 77,4
	27,9	30,1	32,0	34,3	35,9	38,4	36,2	38,0	40,3	42,1	44,4	46,7	48,3	51,2
	119,0	127,0	132,0	138,0	145,0	150,0	155,0	160,0	169,0	175,0	182,0	189,0	195,0	201,0
	4,61	4,57	4,49	4,50	4,46	4,42	4,65	4,66	4,56	4,56	4,47	4,47	4,45	4,42
	40,5 / 39,0	43,6 / 42,0	46,6 / 44,9	48,2 / 46,4	51,5 / 49,7	53,8 / 51,8	52,2 / 50,4	53,8 / 51,9	58,8 / 56,7	60,2 / 58,1	64,6 / 62,2	67,1 / 64,7	69,5 / 67,0	72,2 / 69,6
	25,8	27,8	29,4	30,7	32,5	33,9	33,3	34,3	37,1	38,4	40,7	42,3	43,8	45,5
	4	4	5	5	6	6	5	5	6	6	7	7	8	8
	80	80	80	80	80	80	80	80	80	80	80	80	80	80
	688	696	688	696	696	696	920	928	920	928	920	928	928	928
	64,0	64,5	65,0	65,5	65,5	66,0	65,5	66,0	66,0	66,5	66,5	67,0	67,0	67,0
	61,0	61,5	62,0	62,5	62,5	63,0	62,5	63,0	63,0	63,5	63,5	64,0	64,0	64,0
	85,0	85,5	86,0	86,5	86,5	87,0	86,5	87,0	87,0	87,5	87,5	88,0	88,0	88,0
	1.842 x 3.250 x 1.000	1.842 x 3.660 x 1.000	1.842 x 3.250 x 1.000	1.842 x 3.660 x 1.000	1.842 x 3.660 x 1.000	1.842 x 3.660 x 1.000	1.842 x 4.490 x 1.065	1.842 x 4.900 x 1.125	1.842 x 4.490 x 1.110	1.842 x 4.900 x 1.170	1.842 x 4.490 x 1.155	1.842 x 4.900 x 1.215	1.842 x 4.900 x 1.260	1.842 x 4.900 x 1.260
	795	855	840	900	945	945	1.065	1.125	1.110	1.170	1.155	1.215	1.260	1.260
	3/4 (19,05) / 7/8 (22,22)	3/4 (19,05) / 7/8 (22,22)	3/4 (19,05) / 7/8 (22,22)	3/4 (19,05) / 7/8 (22,22)	3/4 (19,05) / 7/8 (22,22)	3/4 (19,05) / 7/8 (22,22)	3/4 (19,05) / 7/8 (22,22)	3/4 (19,05) / 7/8 (22,22)	3/4 (19,05) / 7/8 (22,22)	3/4 (19,05) / 7/8 (22,22)	3/4 (19,05) / 7/8 (22,22)	3/4 (19,05) / 7/8 (22,22)	3/4 (19,05) / 7/8 (22,22)	3/4 (19,05) / 7/8 (22,22)
	1-1/2 (38,10) / 1-5/8 (41,28)	1-1/2 (38,10) / 1-5/8 (41,28)	1-1/2 (38,10) / 1-5/8 (41,28)	1-1/2 (38,10) / 1-5/8 (41,28)	1-1/2 (38,10) / 1-5/8 (41,28)	1-1/2 (38,10) / 1-5/8 (41,28)	1-1/2 (38,10) / 1-5/8 (41,28)	1-1/2 (38,10) / 1-5/8 (41,28)	1-1/2 (38,10) / 1-5/8 (41,28)	1-1/2 (38,10) / 1-5/8 (41,28)	1-1/2 (38,10) / 1-5/8 (41,28)	1-1/2 (38,10) / 1-5/8 (41,28)	1-5/8 (41,28) / 1-3/4 (44,45)	1-5/8 (41,28) / 1-3/4 (44,45)
	1/4 (6,35)	1/4 (6,35)	1/4 (6,35)	1/4 (6,35)	1/4 (6,35)	1/4 (6,35)	1/4 (6,35)	1/4 (6,35)	1/4 (6,35)	1/4 (6,35)	1/4 (6,35)	1/4 (6,35)	1/4 (6,35)	1/4 (6,35)
	22,2 / 46,3536	24,9 / 46,3536	22,2 / 51,9912	24,9 / 51,9912	24,9 / 51,9912	24,9 / 51,9912	30,5 / 63,6840	33,2 / 69,3216	30,5 / 63,6840	33,2 / 69,3216	30,5 / 63,6840	33,2 / 69,3216	33,2 / 69,3216	33,2 / 69,3216
	50 - 130 (200)	50 - 130 (200)	50 - 130 (200)	50 - 130 (200)	50 - 130 (200)	50 - 130 (200)	50 - 130 (200)	50 - 130 (200)	50 - 130 (200)	50 - 130 (200)	50 - 130 (200)	50 - 130 (200)	50 - 130 (200)	50 - 130 (200)
	-10 ~ +52	-10 ~ +52	-10 ~ +52	-10 ~ +52	-10 ~ +52	-10 ~ +52	-10 ~ +52	-10 ~ +52	-10 ~ +52	-10 ~ +52	-10 ~ +52	-10 ~ +52	-10 ~ +52	-10 ~ +52
	-25 ~ +18	-25 ~ +18	-25 ~ +18	-25 ~ +18	-25 ~ +18	-25 ~ +18	-25 ~ +18	-25 ~ +18	-25 ~ +18	-25 ~ +18	-25 ~ +18	-25 ~ +18	-25 ~ +18	-25 ~ +18

Rating Conditions: Cooling Indoor 27°C DB / 19°C WB. Cooling Outdoor 35°C DB. Heating Indoor 20°C DB. Heating Outdoor 7°C DB / 6°C WB. (DB: Dry Bulb; WB: Wet Bulb)  
Specifications subject to change without notice. For detailed information about ERP, please visit our websites [www.aircon.panasonic.eu](http://www.aircon.panasonic.eu) or [www.ptc.panasonic.eu](http://www.ptc.panasonic.eu).

# 2-PIPE ECOI EX ME2 SERIES SPACE SAVING MODEL

Units			8HP	10HP	12HP	14HP	16HP	18HP	20HP
Model name			U-8ME2E8	U-10ME2E8	U-12ME2E8	U-14ME2E8	U-16ME2E8	U-18ME2E8	U-20ME2E8
Power supply	Voltage	V	380 / 400 / 415	380 / 400 / 415	380 / 400 / 415	380 / 400 / 415	380 / 400 / 415	380 / 400 / 415	380 / 400 / 415
	Phase		Three Phase	Three Phase	Three Phase	Three Phase	Three Phase	Three Phase	Three Phase
	Frequency	Hz	50	50	50	50	50	50	50
Cooling capacity		kW	22,4	28,0	33,5	40,0	45,0	50,0	56,0
EER		W/W	4,70	4,37	3,96	3,88	3,52	3,52	3,35
ESSER		W/W	9,33	8,67	7,94	7,73	7,19	6,95	6,18
SEER <sup>1)</sup>		W/W	<b>7,74</b>	<b>7,66</b>	<b>7,32</b>	<b>6,97</b>	<b>6,66</b>	<b>6,56</b>	<b>5,98</b>
Running current cooling		A	7,40 / 7,14	10,20 / 9,80	13,00 / 12,50	16,50 / 15,90	20,10 / 19,40	22,00 / 21,20	25,40 / 24,50
Input power cooling		kW	4,77	6,41	8,47	10,30	12,80	14,20	16,70
Heating capacity		kW	25,0	31,5	37,5	45,0	50,0	56,0	63,0
COP		W/W	5,13	4,76	4,73	4,56	4,42	4,38	3,94
SCOP <sup>2)</sup>		W/W	<b>5,61</b>	<b>5,71</b>	<b>5,84</b>	<b>5,72</b>	<b>5,71</b>	<b>5,65</b>	<b>4,88</b>
Running current heating		A	7,56 / 7,29	10,50 / 11,10	12,30 / 11,80	15,80 / 15,20	17,90 / 17,30	20,10 / 19,40	24,60 / 23,70
Input power heating		kW	4,87	6,62	7,92	9,86	11,30	12,80	16,00
Starting current		A	1	1	1	2	2	2	2
External static pressure (Max)		Pa	80	80	80	80	80	80	80
Air volume		m <sup>3</sup> /min	224	224	232	232	232	405	405
Sound pressure	Normal mode	dB(A)	54,0	56,0	59,0	60,0	61,0	59,0	60,0
	Silent mode	dB(A)	51,0	53,0	56,0	57,0	58,0	56,0	57,0
Sound power		dB	75,0	77,0	80,0	81,0	82,0	80,0	81,0
Dimensions	H x W x D	mm	1.842 x 770 x 1.000	1.842 x 770 x 1.000	1.842 x 770 x 1.000	1.842 x 1.180 x 1.000	1.842 x 1.180 x 1.000	1.842 x 1.540 x 1.000	1.842 x 1.540 x 1.000
Net weight		kg	210	210	270	315	315	375	375
Piping connections <sup>3)</sup>	Liquid pipe	Inch (mm)	3/8 (9,52) / 1/2 (12,70)	3/8 (9,52) / 1/2 (12,70)	1/2 (12,70) / 5/8 (15,88)	1/2 (12,70) / 5/8 (15,88)	1/2 (12,70) / 5/8 (15,88)	5/8 (15,88) / 3/4 (19,05)	5/8 (15,88) / 3/4 (19,05)
	Gas pipe	Inch (mm)	3/4 (19,05) / 7/8 (22,22)	7/8 (22,22) / 1 (25,40)	1 (25,40) / 1-1/8 (28,58)	1 (25,40) / 1-1/8 (28,58)	1-1/8 (28,58) / 1-1/4 (31,75)	1-1/8 (28,58) / 1-1/4 (31,75)	1-1/8 (28,58) / 1-1/4 (31,75)
	Balance pipe	Inch (mm)	1/4 (6,35)	1/4 (6,35)	1/4 (6,35)	1/4 (6,35)	1/4 (6,35)	1/4 (6,35)	1/4 (6,35)
Refrigerant (R410A)	kg / TCO: Eq.		5,6 / 11,6928	5,6 / 11,6928	8,3 / 17,3304	8,3 / 17,3304	8,3 / 17,3304	9,5 / 19,836	9,5 / 19,836
Maximum allowable indoor / outdoor capacity ratio % <sup>4)</sup>			50 - 130 (200)	50 - 130 (200)	50 - 130 (200)	50 - 130 (200)	50 - 130 (200)	50 - 130 (200)	50 - 130 (200)
Operating range	Cooling Min - Max	°C	-10 - +52	-10 - +52	-10 - +52	-10 - +52	-10 - +52	-10 - +52	-10 - +52
	Heating Min - Max	°C	-25 - +18	-25 - +18	-25 - +18	-25 - +18	-25 - +18	-25 - +18	-25 - +18

			22HP	24HP	26HP	28HP	30HP	32HP	34HP	36HP	38HP	40HP	42HP	44HP	46HP	
Combinations			U-22ME2E8	U-24ME2E8	U-26ME2E8	U-28ME2E8	U-30ME2E8	U-32ME2E8	U-34ME2E8	U-36ME2E8	U-38ME2E8	U-40ME2E8	U-42ME2E8	U-44ME2E8	U-46ME2E8	
Model name			U-10ME2E8	U-12ME2E8	U-10ME2E8	U-12ME2E8	U-14ME2E8	U-16ME2E8	U-14ME2E8	U-16ME2E8	U-18ME2E8	U-20ME2E8	U-10ME2E8	U-12ME2E8	U-14ME2E8	
Model name			U-12ME2E8	U-12ME2E8	U-16ME2E8	U-16ME2E8	U-16ME2E8	U-16ME2E8	U-20ME2E8	U-20ME2E8	U-20ME2E8	U-20ME2E8	U-16ME2E8	U-16ME2E8	U-16ME2E8	
Power supply	Voltage	V	380 / 400 / 415	380 / 400 / 415	380 / 400 / 415	380 / 400 / 415	380 / 400 / 415	380 / 400 / 415	380 / 400 / 415	380 / 400 / 415	380 / 400 / 415	380 / 400 / 415	380 / 400 / 415	380 / 400 / 415	380 / 400 / 415	
	Phase		Three Phase	Three Phase	Three Phase	Three Phase	Three Phase	Three Phase	Three Phase	Three Phase	Three Phase	Three Phase	Three Phase	Three Phase	Three Phase	
	Frequency	Hz	50	50	50	50	50	50	50	50	50	50	50	50	50	
Cooling capacity		kW	61,5	68,0	73,0	78,5	85,0	90,0	96,0	101,0	107,0	113,0	118,0	124,0	130,0	
EER		W/W	4,13	3,93	3,80	3,69	3,68	3,52	3,56	3,42	3,42	3,34	3,69	3,62	3,62	
Running current cooling		A	23,1 / 22,3	26,6 / 25,6	30,1 / 29,0	33,1 / 31,9	36,6 / 35,3	40,2 / 38,7	41,9 / 40,4	45,3 / 43,7	48,1 / 46,3	51,4 / 49,5	50,2 / 48,4	53,2 / 51,3	56,9 / 54,9	
Input power cooling		kW	14,9	17,3	19,2	21,3	23,1	25,6	27,0	25,9	31,3	33,8	32,0	34,3	35,9	
Heating capacity		kW	69,0	76,5	81,5	87,5	95,0	100,0	108,0	113,0	119,0	127,0	132,0	138,0	145,0	
COP		W/W	4,76	4,69	4,55	4,56	4,48	4,42	4,17	4,14	4,13	3,92	4,49	4,50	4,46	
Running current heating		A	22,7 / 21,9	25,3 / 24,4	28,4 / 27,4	30,1 / 29,0	33,6 / 32,4	35,8 / 34,6	40,6 / 39,2	42,4 / 40,8	44,7 / 43,1	49,8 / 48,0	46,6 / 44,9	48,2 / 46,4	51,5 / 49,7	
Input power heating		kW	14,5	16,3	17,9	19,2	21,2	22,6	25,9	27,3	28,8	32,4	29,4	30,7	32,5	
Starting current		A	2	2	3	3	4	4	4	4	4	4	5	5	6	
External static pressure (Max)		Pa	80	80	80	80	80	80	80	80	80	80	80	80	80	
Air volume		m <sup>3</sup> /min	456	464	456	464	464	464	637	637	810	810	688	696	696	
Sound pressure	Normal mode	dB(A)	61,0	62,0	62,5	63,5	63,5	64,0	63,0	63,5	62,5	63,0	65,0	65,5	65,5	
	Silent mode	dB(A)	58,0	59,0	59,5	60,5	60,5	61,0	60,0	60,5	59,5	60,0	62,0	62,5	62,5	
Sound power		dB	82,0	83,0	83,5	84,5	84,5	85,0	84,0	84,5	83,5	84,0	86,0	86,5	86,5	
Dimensions	H x W x D	mm	1.842 x 2.010 x 1.000	1.842 x 2.420 x 1.000	1.842 x 2.010 x 1.000	1.842 x 2.420 x 1.000	1.842 x 2.420 x 1.000	1.842 x 2.420 x 1.000	1.842 x 2.780 x 1.000	1.842 x 2.780 x 1.000	1.842 x 3.140 x 1.000	1.842 x 3.140 x 1.000	1.842 x 3.250 x 1.000	1.842 x 3.660 x 1.000	1.842 x 3.660 x 1.000	
Net weight		kg	480	540	525	585	630	630	690	690	750	750	840	900	945	
Piping connections <sup>3)</sup>	Liquid pipe	Inch (mm)	5/8 (15,88) / 3/4 (19,05)	5/8 (15,88) / 3/4 (19,05)	3/4 (19,05) / 7/8 (22,22)	3/4 (19,05) / 7/8 (22,22)	3/4 (19,05) / 7/8 (22,22)	3/4 (19,05) / 7/8 (22,22)	3/4 (19,05) / 7/8 (22,22)	3/4 (19,05) / 7/8 (22,22)	3/4 (19,05) / 7/8 (22,22)	3/4 (19,05) / 7/8 (22,22)	3/4 (19,05) / 7/8 (22,22)	3/4 (19,05) / 7/8 (22,22)	3/4 (19,05) / 7/8 (22,22)	
	Gas pipe	Inch (mm)	1-1/8 (28,58) / 1-1/4 (31,75)	1-1/8 (28,58) / 1-1/4 (31,75)	1-1/4 (31,75) / 1-1/2 (38,10)	1-1/4 (31,75) / 1-1/2 (38,10)	1-1/4 (31,75) / 1-1/2 (38,10)	1-1/4 (31,75) / 1-1/2 (38,10)	1-1/4 (31,75) / 1-1/2 (38,10)	1-1/4 (31,75) / 1-1/2 (38,10)	1-1/4 (31,75) / 1-1/2 (38,10)	1-1/2 (38,10) / 1-1/2 (38,10)	1-1/2 (38,10) / 1-1/2 (38,10)	1-1/2 (38,10) / 1-1/2 (38,10)	1-1/2 (38,10) / 1-1/2 (38,10)	1-1/2 (38,10) / 1-1/2 (38,10)
	Balance pipe	Inch (mm)	1/4 (6,35)	1/4 (6,35)	1/4 (6,35)	1/4 (6,35)	1/4 (6,35)	1/4 (6,35)	1/4 (6,35)	1/4 (6,35)	1/4 (6,35)	1/4 (6,35)	1/4 (6,35)	1/4 (6,35)	1/4 (6,35)	1/4 (6,35)
Refrigerant (R410A)	kg / TCO: Eq.		13,9 / 23,3856	16,6 / 34,6608	13,9 / 29,0232	16,6 / 34,6608	16,6 / 34,6608	16,6 / 34,6608	17,8 / 37,1664	17,8 / 37,1664	19,0 / 39,672	19,0 / 39,672	22,2 / 46,3536	24,9 / 51,9912	24,9 / 51,9912	
Maximum allowable indoor / outdoor capacity ratio % <sup>4)</sup>			50 - 130 (200)	50 - 130 (200)	50 - 130 (200)	50 - 130 (200)	50 - 130 (200)	50 - 130 (200)	50 - 130 (200)	50 - 130 (200)	50 - 130 (200)	50 - 130 (200)	50 - 130 (200)	50 - 130 (200)	50 - 130 (200)	
Operating range	Cooling Min - Max	°C	-10 - +52	-10 - +52	-10 - +52	-10 - +52	-10 - +52	-10 - +52	-10 - +52	-10 - +52	-10 - +52	-10 - +52	-10 - +52	-10 - +52	-10 - +52	
	Heating Min - Max	°C	-25 - +18	-25 - +18	-25 - +18	-25 - +18	-25 - +18	-25 - +18	-25 - +18	-25 - +18	-25 - +18	-25 - +18	-25 - +18	-25 - +18	-25 - +18	



1) Data obtained with setting by Panasonic commissioning. 2) Tentative data. 3) Pipe diameter under 90m for ultimate indoor unit / over 90m for ultimate indoor unit (if the longest piping equivalent length exceeds 90m, increase the sizes of the main tubes by 1 rank for gas tubes and liquid tubes). 4) If the following conditions are satisfied, the effective range is above 130 % and below 200 %: A. Obey the limited number of connectable indoor units. B. The lower limit of operating range for heating outdoor temperature is limited to -10°C WB (standard -25°C WB). C. Simultaneous operation is limited to less than 130% of connectable indoor units.





NEW TECHNOLOGY  
17



	48HP	50HP	52HP	54HP	56HP	58HP	60HP	62HP	64HP	66HP	68HP	70HP	72HP	74HP	76HP	78HP	80HP
	U-48ME2E8	U-50ME2E8	U-52ME2E8	U-54ME2E8	U-56ME2E8	U-58ME2E8	U-60ME2E8	U-62ME2E8	U-64ME2E8	U-66ME2E8	U-68ME2E8	U-70ME2E8	U-72ME2E8	U-74ME2E8	U-76ME2E8	U-78ME2E8	U-80ME2E8
	U-16ME2E8	U-14ME2E8	U-16ME2E8	U-14ME2E8	U-16ME2E8	U-18ME2E8	U-20ME2E8	U-14ME2E8	U-16ME2E8	U-10ME2E8	U-12ME2E8	U-10ME2E8	U-16ME2E8	U-16ME2E8	U-16ME2E8	U-18ME2E8	U-20ME2E8
	U-16ME2E8	U-16ME2E8	U-16ME2E8	U-20ME2E8	U-20ME2E8	U-20ME2E8	U-20ME2E8	U-16ME2E8	U-16ME2E8	U-16ME2E8	U-16ME2E8	U-20ME2E8	U-16ME2E8	U-18ME2E8	U-20ME2E8	U-20ME2E8	U-20ME2E8
	U-16ME2E8	U-20ME2E8	U-20ME2E8	U-20ME2E8	U-20ME2E8	U-20ME2E8	U-20ME2E8	U-16ME2E8	U-16ME2E8	U-20ME2E8	U-20ME2E8	U-20ME2E8	U-20ME2E8	U-20ME2E8	U-20ME2E8	U-20ME2E8	U-20ME2E8
	380 / 400 / 415	380 / 400 / 415	380 / 400 / 415	380 / 400 / 415	380 / 400 / 415	380 / 400 / 415	380 / 400 / 415	380 / 400 / 415	380 / 400 / 415	380 / 400 / 415	380 / 400 / 415	380 / 400 / 415	380 / 400 / 415	380 / 400 / 415	380 / 400 / 415	380 / 400 / 415	380 / 400 / 415
	Three Phase	Three Phase	Three Phase	Three Phase	Three Phase	Three Phase	Three Phase	Three Phase	Three Phase	Three Phase	Three Phase	Three Phase	Three Phase	Three Phase	Three Phase	Three Phase	Three Phase
	50	50	50	50	50	50	50	50	50	50	50	50	50	50	50	50	50
	135,0	140,0	145,0	151,0	156,0	162,0	168,0	174,0	180,0	185,0	190,0	196,0	202,0	208,0	213,0	219,0	224,0
	3,52	3,55	3,46	3,49	3,41	3,40	3,35	3,60	3,52	3,52	3,49	3,47	3,42	3,42	3,39	3,38	3,35
	60,2 / 58,1	61,1 / 58,9	65,0 / 62,7	66,5 / 64,1	70,3 / 67,8	73,1 / 70,4	76,1 / 73,4	75,8 / 73,0	80,3 / 77,4	80,8 / 77,8	83,7 / 80,7	86,8 / 83,6	90,6 / 87,3	93,4 / 90,0	96,6 / 93,1	98,3 / 94,7	101,5 / 97,8
	38,4	39,4	41,9	43,3	45,8	47,6	50,1	48,3	51,2	52,6	54,5	56,5	59,0	60,8	62,9	64,7	66,8
	150,0	155,0	160,0	169,0	175,0	182,0	189,0	195,0	201,0	207,0	213,0	219,0	226,0	233,0	239,0	245,0	252,0
	4,42	4,29	4,27	4,11	4,08	4,06	3,94	4,45	4,42	4,16	4,18	4,05	4,14	4,12	4,03	4,03	3,94
	53,8 / 51,8	56,6 / 54,6	58,8 / 56,7	63,8 / 61,5	66,6 / 64,2	69,5 / 67,0	73,7 / 71,0	69,5 / 67,0	72,2 / 69,6	77,1 / 74,3	79,2 / 76,3	83,1 / 80,1	84,7 / 81,7	87,7 / 84,5	92,0 / 88,7	93,4 / 90,0	98,3 / 94,7
	33,9	36,1	37,5	41,1	42,9	44,8	48,0	43,8	45,5	49,7	51,0	54,1	54,6	56,5	59,3	60,8	64,0
	6	6	6	6	6	6	6	8	8	7	7	8	8	8	8	8	8
	80	80	80	80	80	80	80	80	80	80	80	80	80	80	80	80	80
	696	869	869	1.042	1.042	1.215	1.215	928	928	1.266	1.274	1.439	1.274	1.447	1.447	1.620	1.620
	66,0	65,5	65,5	65,0	65,5	64,5	65,0	67,0	67,0	66,0	66,5	65,5	66,5	66,5	66,5	66,0	66,0
	63,0	62,5	62,5	62,0	62,5	61,5	62,0	64,0	64,0	63,0	63,5	62,5	63,5	63,5	63,5	63,0	63,0
	87,0	86,5	86,5	86,0	86,5	85,5	86,0	88,0	88,0	87,0	87,5	86,5	87,5	87,5	87,5	87,0	87,0
	1.842 x 3.660 x 1.000	1.842 x 4.020 x 1.000	1.842 x 4.020 x 1.000	1.842 x 4.380 x 1.000	1.842 x 4.380 x 1.000	1.842 x 4.740 x 1.000	1.842 x 4.740 x 1.000	1.842 x 4.900 x 1.000	1.842 x 4.900 x 1.000	1.842 x 5.210 x 1.000	1.842 x 5.210 x 1.000	1.842 x 5.620 x 1.000	1.842 x 5.620 x 1.000	1.842 x 5.980 x 1.000	1.842 x 5.980 x 1.000	1.842 x 6.340 x 1.000	1.842 x 6.340 x 1.000
	945	1.005	1.005	1.065	1.065	1.125	1.125	1.260	1.260	1.275	1.335	1.335	1.380	1.440	1.440	1.500	1.500
	3/4 (19,05) / 7/8 (22,22)	3/4 (19,05) / 7/8 (22,22)	3/4 (19,05) / 7/8 (22,22)	3/4 (19,05) / 7/8 (22,22)	3/4 (19,05) / 7/8 (22,22)	3/4 (19,05) / 7/8 (22,22)	3/4 (19,05) / 7/8 (22,22)	3/4 (19,05) / 7/8 (22,22)	3/4 (19,05) / 7/8 (22,22)	3/4 (19,05) / 7/8 (22,22)	3/4 (19,05) / 7/8 (22,22)	7/8 (22,22) / 1 (25,04)	7/8 (22,22) / 1 (25,04)	7/8 (22,22) / 1 (25,04)	7/8 (22,22) / 1 (25,04)	7/8 (22,22) / 1 (25,04)	7/8 (22,22) / 1 (25,04)
	1-1/2 (38,10)	1-1/2 (38,10)	1-1/2 (38,10)	1-1/2 (38,10)	1-1/2 (38,10)	1-1/2 (38,10)	1-1/2 (38,10)	1-5/8 (41,28)	1-5/8 (41,28)	1-5/8 (41,28)	1-5/8 (41,28)	1-5/8 (41,28)	1-3/4 (44,45)	1-3/4 (44,45)	1-3/4 (44,45)	1-3/4 (44,45)	1-3/4 (44,45)
	1-5/8 (41,28)	1-5/8 (41,28)	1-5/8 (41,28)	1-5/8 (41,28)	1-5/8 (41,28)	1-5/8 (41,28)	1-5/8 (41,28)	1-3/4 (44,45)	1-3/4 (44,45)	1-3/4 (44,45)	1-3/4 (44,45)	1-3/4 (44,45)	1-3/4 (44,45)	1-3/4 (44,45)	1-3/4 (44,45)	1-3/4 (44,45)	1-3/4 (44,45)
	1/4 (6,35)	1/4 (6,35)	1/4 (6,35)	1/4 (6,35)	1/4 (6,35)	1/4 (6,35)	1/4 (6,35)	1/4 (6,35)	1/4 (6,35)	1/4 (6,35)	1/4 (6,35)	1/4 (6,35)	1/4 (6,35)	1/4 (6,35)	1/4 (6,35)	1/4 (6,35)	1/4 (6,35)
	24,9 / 51,9912	26,1 / 54,4968	26,1 / 54,4968	27,3 / 57,0024	27,3 / 57,0024	28,5 / 59,508	28,5 / 59,508	33,2 / 69,3216	33,2 / 69,3216	32,9 / 68,6952	35,6 / 74,3328	34,1 / 19,836	35,8 / 68,6952	36,8 / 19,836	36,8 / 76,8384	38,0 / 79,344	38,0 / 79,344
	50 - 130 (200)	50 - 130 (200)	50 - 130 (200)	50 - 130 (200)	50 - 130 (200)	50 - 130 (200)	50 - 130 (200)	50 - 130 (200)	50 - 130 (200)	50 - 130 (200)	50 - 130 (200)	50 - 130 (200)	50 - 130 (200)	50 - 130 (200)	50 - 130 (200)	50 - 130 (200)	50 - 130 (200)
	-10 - +52	-10 - +52	-10 - +52	-10 - +52	-10 - +52	-10 - +52	-10 - +52	-10 - +52	-10 - +52	-10 - +52	-10 - +52	-10 - +52	-10 - +52	-10 - +52	-10 - +52	-10 - +52	-10 - +52
	-25 - +18	-25 - +18	-25 - +18	-25 - +18	-25 - +18	-25 - +18	-25 - +18	-25 - +18	-25 - +18	-25 - +18	-25 - +18	-25 - +18	-25 - +18	-25 - +18	-25 - +18	-25 - +18	-25 - +18

Rating Conditions: Cooling Indoor 27°C DB / 19°C WB. Cooling Outdoor 35°C DB. Heating Indoor 20°C DB. Heating Outdoor 7°C DB / 6°C WB. (DB: Dry Bulb; WB: Wet Bulb)  
Specifications subject to change without notice. For detailed information about ERP, please visit our websites www.aircon.panasonic.eu or www.ptc.panasonic.eu.

# 3-PIPE ECOi MF2 6N SERIES



## Simultaneous heating and cooling VRF system. The Panasonic 3-Pipe MF2 Series offers the best solution for the most demanding customers.

- The 3-Pipe units have only one chassis size, with a very small footprint (only 0,93m<sup>2</sup>)
- 1 body for all sizes: 1.758 x 1.000 x 930mm, for 8, 10, 12, 14 and 16HP

- Maximum capacity size as 48HP by 3 unit combinations
- Up to 52 indoor units connectable
- Connectable indoor/outdoor unit capacity ratio up to 150%

### Market-leading COP (at full load), High Efficiency Combination.

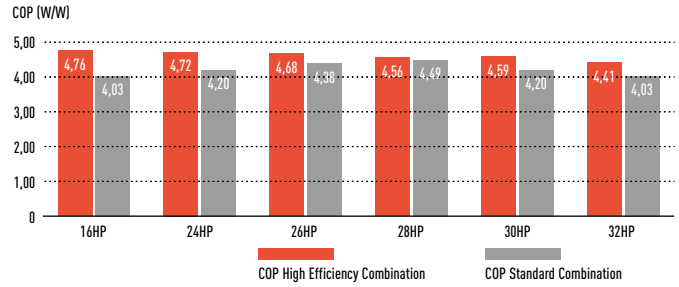
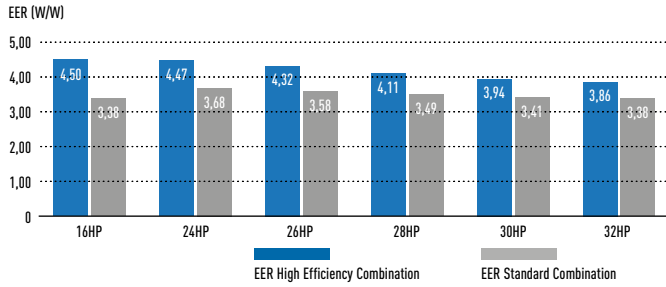

### Market-leading COP (at full load), standard efficiency.

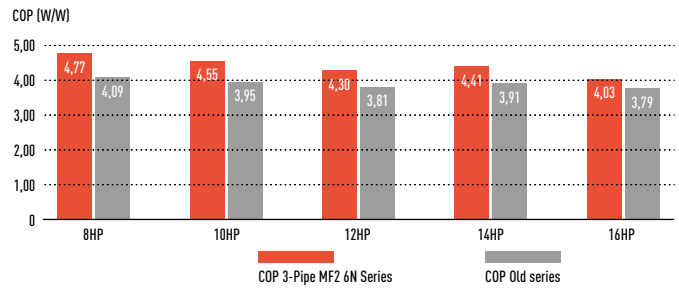
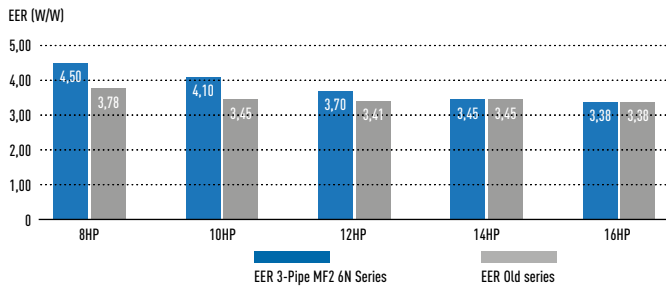

## 3-Pipe Control Box Kit / Multiple connection type

### New Heat Recovery Box to connect multiple indoor units with just one box, 4, 6 and up to 8 indoor units or groups.

This is good advantage specially in hotel applications, where space for connecting several boxes is limited.

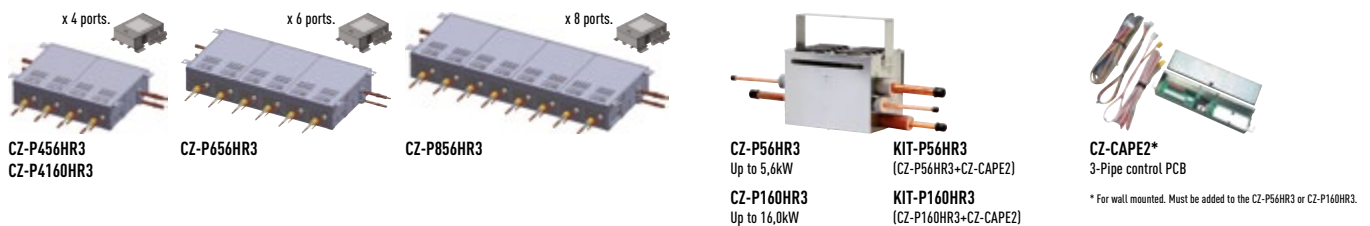

### Individual control of multiple indoor units with solenoid valve kits.

- Any design and layout can be used in a single system.
- Cooling operation is possible up to an outdoor temperature of -10°C.

### System structure.

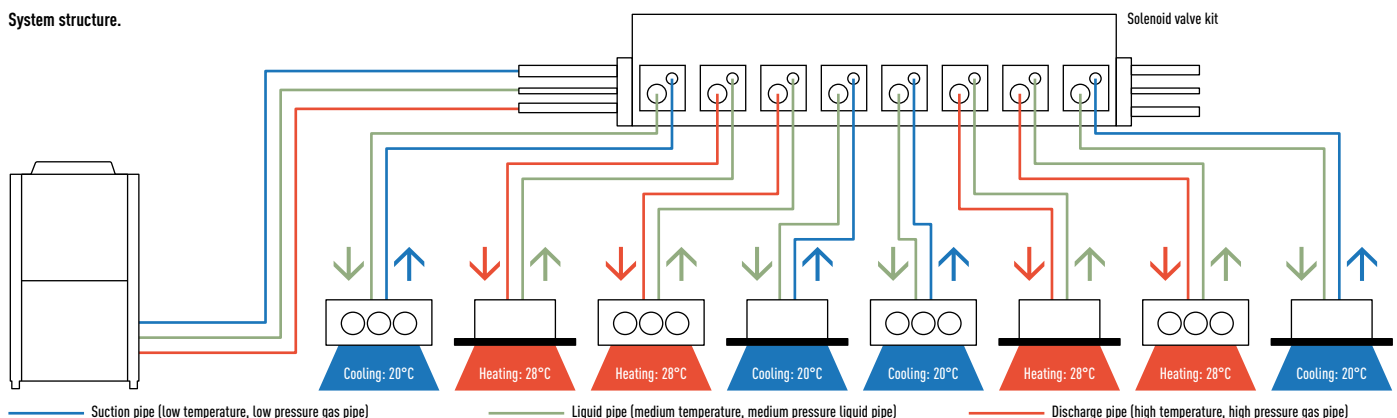

# 3-PIPE ECOi MF2 6N SERIES

## Extended design operation conditions

Cooling design operation conditions: The cooling operation range has been extended to -10°C by changing the outdoor fan to an inverter type.

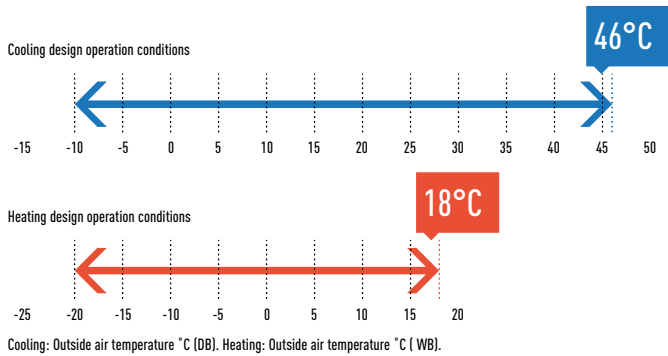

Heating design operation conditions: Stable heating operation even with an outside air temperature of -20°C. The heating operation range has been extended to -20°C by use of a compressor with a high-pressure vessel.

## Wide temperature setting range.

Wired remote control heating temperature setting range is 16 to 30°C.

## Large combination of outdoor units, up to 48HP

Unit	System ( HP )																					
	8	10	12	14	16	18	20	22	24	26	28	30	32	34	36	38	40	42	44	46	48	
8	1				1	1	1	1						1	1	1	1					
10		1				1																
12			1				1							1								
14				1				1		1	2	1		1	2	1		3	2	1		
16					1				1			1	2				1	2		1	2	3

## High efficiency combination

Unit	System ( HP )					
	16	24	26	28	30	32
8	2	3	2	2	2	1
10			1			
12				1		2
14					1	

## Power suppression control for energy saving (Demand control)<sup>1</sup>

The 3-Pipe ECOi MF2 6N Series has a built-in demand function which uses the inverter characteristics. With this demand function, the power consumption can be set in three steps, and operation<sup>2</sup> at optimum performance is performed according to the setting and the power consumption. This function is useful to reduce the annual power consumption and to save electricity costs while maintaining comfort.

<sup>1</sup> An outdoor Seri-Para I/O unit is required for demand input.  
<sup>2</sup> Setting is possible as 0% or in the range from 40 to 100% (in steps of 5%). At the time of shipping, setting has been done to the three steps of 0%, 70%, and 100%.

## Non-stop operation during maintenance

Even when an indoor unit needs maintenance, the other indoor units can be kept operating by setting. (Not applicable for all situations)

## Compact design for superb space saving and low noise level

5 types of outdoor units with different capacities have been standardized to one compact casing.

Uniquely constructed with two compartments, the upper chamber contains the heat exchange, with the lower chamber stores the compressors. The benefits are two-fold - superb space saving and low noise level.

Installation space: 0,93m<sup>2</sup>

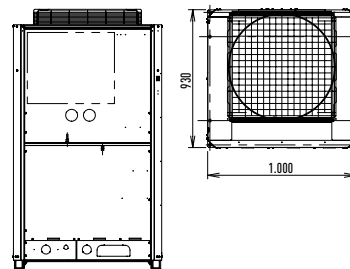

Operating sound dB(A)

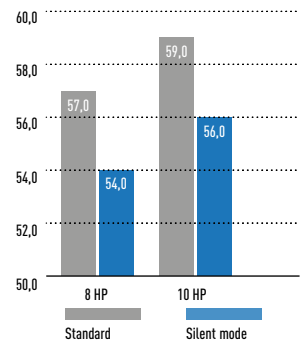

## Increased piping lengths and design flexibility

Adaptable to various building types and sizes. Actual piping length: 180m. Maximum piping length: 500m.

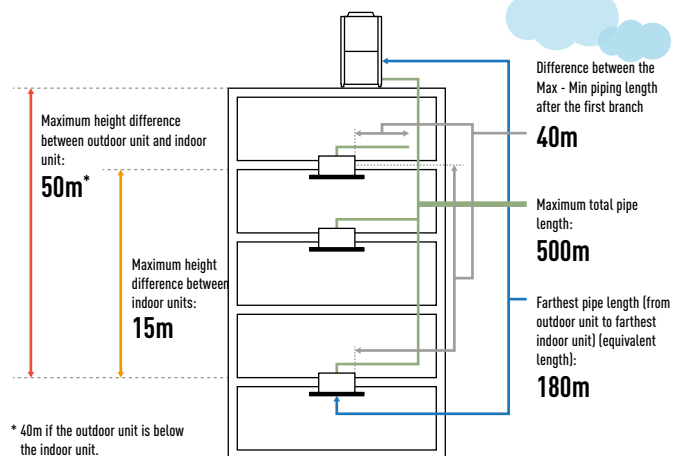

## Additional refrigerant charge (g/m)

Liquid piping size	6,35	9,52	12,7	15,88	19,05	22,22	25,40
Amount of refrigerant charge	26	56	128	185	259	366	490

## Refrigerant piping (Piping size (mm))

Material	Piping size (mm)						
	Outer diameter	6,35	9,52	12,70	15,88	19,05	22,22
0 material	Wall thickness	0,80	0,80	0,80	1,00	1,00	1,15
	1/2 H, H material	Outer diameter	25,40	28,58	31,75	38,10	41,28
1/2 H, H material	Wall thickness	1,00	1,00	1,10	over 1,35	over 1,45	

Note: When pipe bending is to be performed, the bending radius shall be at least 4 times the outer diameter. Also, take sufficient care to prevent pipe collapse and damage at the time of bending.



### Excellent cost saving and smaller piping size

By using R410A with low pressure loss, pipe sizes for discharge, suction and liquid are all reduced.

This makes it possible to aim for reduced piping space, improved workability at the site, and reduction of the piping material costs.

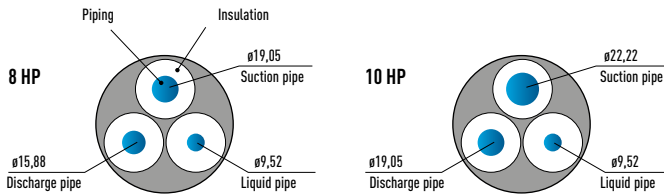

### 3-Pipe wind protection shield

PAW-WPH1	1 long side of the outdoor unit (624 x 983 x 489)
PAW-WPH2	1 long side of the outdoor units (853 x 983 x 489)
PAW-WPH3	2 long sides of the outdoor units (744 x 983 x 289) (2ER SET)

### Extended compressor life by uniform compressor operation time

The total run-time of compressors are monitored by a built-in microcomputer, which ensures that operation times of all compressors within the same refrigerant circuit are balanced. Compressors with histories showing shorter run times are selected first, ensuring equal wear and tear across all units and extended the working life of the system.

#### System example

A,C: DC inverter compressor  
B,D: Constant speed compressor

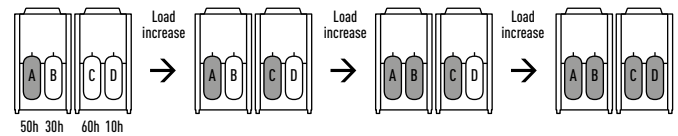

\* Depend on accumulated operation time of each compressors.  
\* Compressor priority has possibility to be changed.  
(e.g Case 1: A→C→B→D, Case 2: C→A→D→B, Case 3: A→C→D→B, Case 4: C→A→B→D  
\* Also other cases available.

### Piping design

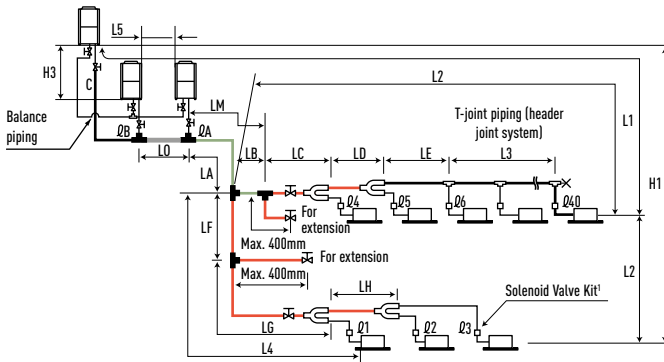

— Main piping  
— Main distribution pipes LC-LH are selected according to the capacity after the distribution joint.  
— Size of indoor unit connection piping 1-40 is determined by the connection piping size on the indoor units.  
 Distribution joint (CZ, option).  
 Ball valve (BV, option).  
 T-joint (field supply).  
 Solidly welded shut (pinch weld).

The outdoor connection main piping (L0 portion) is determined by the total capacity of the outdoor units that are connected to the tube end.  
Note: Do not use commercial T-pieces for the liquid pipes of the distribution joint.

**R410A distribution joint**  
 CZ-P680PH2 (for outdoor unit)  
 CZ-P1350PH2 (for outdoor unit)  
 CZ-P224HK2 (for indoor unit)  
 CZ-P680HK2 (for indoor unit)  
 CZ-P1350HK2 (for indoor unit)

### Ranges that apply to refrigerant piping lengths and to differences in installation heights

Items	Marks	Contents	Length (m)
Allowable piping length	L1	Maximum piping length	Actual piping length ≤180 <sup>1</sup> Equivalent piping length ≤200
	Δ L (L2-L4)	Difference between the Maximum length and the minimum length from the No. 1 distribution	≤40
	LM	Maximum length of main piping (at Maximum diameter)	— <sup>2</sup>
	Q1, Q2-Q40	Maximum length of each distribution	≤30
	L1+Q1+Q2...Q39+QA+QB+LF+LG+LH	Total Maximum piping length including length of each distribution (only liquid piping)	≤500 <sup>3</sup>
Allowable elevation difference	L5	Distance between outdoor units	≤10
	H1	When outdoor unit is installed higher than indoor unit	≤50
		When outdoor unit is installed lower than indoor unit	≤40
	H2	Maximum difference between indoor units	≤15
Allowable length of joint piping	H3	Maximum difference between outdoor units	≤4
	L3	T-joint piping (field-supply); Maximum piping length between the first T-joint and solidly welded-shut end point	≤2

L = Length, H = Height  
 1) If the longest piping length (L1) exceeds 90m (equivalent length), increase the sizes of the main tubes (LM) by 1 rank for the discharge tubes, suction tubes, and narrow tubes (field supplied).  
 2) If the longest main tube length (LM) exceeds 50m, increase the main tube size at the portion before 50m by 1 rank for the suction tubes and discharge tubes (field supplied).  
 (For the portion that exceeds 50m, set based on the main tube sizes (LA) listed in the table on the following page).  
 3) 24HP - 30HP of high efficiency combination is 300m.

# 3-PIPE ECOi MF2 6N SERIES

## HIGH EFFICIENCY COMBINATION FROM 16 TO 32HP

With simultaneous heating and cooling operation heat recovery type.

ECOi 3-Pipe is one of the most advanced VRF systems available. Not only offering high-efficiency and performance for simultaneous heating and cooling, its sophisticated design makes installation and maintenance much easier.

- Achieves COP 4,76 as the top class in the industry (average cooling and heating value for 8HP outdoor unit).
- Simultaneous cooling or heating operation for up to 52 indoor units.
- Small installation space, top class in the industry.
- Rotation operation function and back-up operation function provided.



### Technical focus

- Standardisation of outdoor unit to one compact casing size
- Improved operation efficiency
- The constant-speed compressor adopts a high-performance internal high-pressure scroll
- Improvement of the heat exchanger
- Redesign of structural parts
- Close side-by-side installation is possible

HP		16HP	24HP	26HP	28HP	30HP	32HP
High Efficiency model		U-8MF2E8 U-8MF2E8	U-8MF2E8 U-8MF2E8 U-8MF2E8	U-8MF2E8 U-8MF2E8 U-10MF2E8	U-8MF2E8 U-8MF2E8 U-12MF2E8	U-8MF2E8 U-8MF2E8 U-14MF2E8	U-8MF2E8 U-12MF2E8 U-12MF2E8
Power supply	V	380 / 400 / 415	380 / 400 / 415	380 / 400 / 415	380 / 400 / 415	380 / 400 / 415	380 / 400 / 415
		Three Phase / 50 Hz	Three Phase / 50 Hz	Three Phase / 50 Hz	Three Phase / 50 Hz	Three Phase / 50 Hz	Three Phase / 50 Hz
Cooling capacity	kW	45,0	68,0	73,0	78,5	85,0	90,0
EER <sup>1)</sup>	W/W	4,50	4,47	4,32	4,11	3,94	3,86
Running current	380 / 400 / 415 V	17,3 / 16,4 / 16,0	26,2 / 24,9 / 24,3	28,5 / 27,4 / 26,7	32,2 / 31,0 / 30,2	36,5 / 35,0 / 34,1	38,9 / 37,4 / 36,4
Input power	kW	10,0	15,2	16,9	19,1	21,6	23,3
Heating capacity	kW	50,0	76,5	81,5	87,5	95,0	100,0
COP <sup>1)</sup>	W/W	4,76	4,72	4,68	4,56	4,59	4,41
Running current	380 / 400 / 415 V	17,9 / 17,0 / 16,6	27,7 / 26,3 / 25,6	29,4 / 27,9 / 27,5	32,4 / 31,1 / 30,4	35,0 / 33,6 / 32,7	38,3 / 36,8 / 35,9
Input power	kW	10,5	16,2	17,4	19,2	20,7	22,7
Air volume	m <sup>3</sup> /min	316	474	494	528	528	582
Sound pressure	Hi / Lo	60,0 / 57,0	62,0 / 59,0	62,5 / 59,5	63,5 / 60,5	64,0 / 61,0	65,0 / 62,0
Sound power	Normal mode	74,5 / 71,5	76,5 / 73,5	77,0 / 74,0	78,0 / 75,0	78,5 / 75,5	79,5 / 76,5
Dimensions (Combination)	H x W x D	1.758 x 2.060 x 930	1.758 x 3.120 x 930	1.758 x 3.120 x 930	1.758 x 3.120 x 930	1.758 x 3.120 x 930	1.758 x 3.120 x 930
Net weight	kg	538	807	807	852	860	897
Piping connections	Suction pipe	Inch (mm)	1-1/8 (28,58)	1-1/8 (28,58)	1 1/4 (31,75)	1 1/4 (31,75)	1 1/4 (31,75)
	Discharge pipe	Inch (mm)	7/8 (22,22)	1 (25,40)	1 (25,40)	1-1/8 (28,58)	1-1/8 (28,58)
	Liquid pipe	Inch (mm)	1/2 (12,70)	5/8 (15,88)	3/4 (19,05)	3/4 (19,05)	3/4 (19,05)
	Balance pipe	Inch (mm)	1/4 (6,35)	1/4 (6,35)	1/4 (6,35)	1/4 (6,35)	1/4 (6,35)
Refrigerant (R410A)	kg / TCO <sub>2</sub> Eq.	16,6 / 34,6608	24,9 / 51,9912	25,1 / 52,4088	25,4 / 53,0352	25,9 / 54,0792	25,9 / 54,0792
Operating range	Cooling Min ~ Max	°C	-10 ~ +46	-10 ~ +46	-10 ~ +46	-10 ~ +46	-10 ~ +46
	Heating Min ~ Max	°C	-20 ~ +18	-20 ~ +18	-20 ~ +18	-20 ~ +18	-20 ~ +18
	Simultaneous operation	°C	-10 ~ +24	-10 ~ +24	-10 ~ +24	-10 ~ +24	-10 ~ +24

1) EER and COP classification is at 400V in accordance with EU directive 2002/31/EC.

#### Solenoid valve kit

KIT-P56HR3	KIT-P56HR3	3-Pipe control solenoid valve kit (up to 5,6kW)
	CZ-P56HR3	Solenoid valve kit (up to 5,6kW)
	CZ-CAPE2	3-Pipe control PCB
KIT-P160HR3	KIT-P160HR3	3-Pipe control solenoid valve kit (from 5,6kW to 10,6kW)
	CZ-P160HR3	Solenoid valve kit (up to 16,0kW)
CZ-CAPE2	CZ-CAPE2	3-Pipe control PCB
		3-Pipe control PCB for wall mounted

#### 3-Pipe control box kit

CZ-P456HR3	4 ports 3 pipe box (up to 5,6kW)
CZ-P656HR3	6 ports 3 pipe box (up to 5,6kW)
CZ-P856HR3	8 ports 3 pipe box (up to 5,6kW)
CZ-P4160HR3	4 ports 3 pipe box (up to 16,0kW)



## 3-PIPE ECOi MF2 6N SERIES FROM 8 TO 16HP

With simultaneous heating and cooling operation heat recovery type.

ECOi 3-Pipe is one of the most advanced VRF systems available. Not only offering high-efficiency and performance for simultaneous heating and cooling, but also its sophisticated installation and maintenance much easier.

- Achieves COP 4,77 as the top class in the industry (average cooling and heating value for 8HP outdoor unit).
- Simultaneous cooling or heating operation for up to 26 indoor units.
- Small installation space, top class in the industry.
- Rotation operation function and back-up operation function provided.

### Technical focus

- Standardisation of outdoor unit to one compact casing size
- Improved operation efficiency
- The constant-speed compressor adopts a high-performance internal high-pressure scroll
- Improvement of the heat exchanger
- Redesign of structural parts
- Close side-by-side installation is possible



HP			8HP	10HP	12HP	14HP	16HP
<b>Standard model</b>			<b>U-8MF2E8</b>	<b>U-10MF2E8</b>	<b>U-12MF2E8</b>	<b>U-14MF2E8</b>	<b>U-16MF2E8</b>
Power supply	V		380 / 400 / 415	380 / 400 / 415	380 / 400 / 415	380 / 400 / 415	380 / 400 / 415
			Three Phase / 50 Hz	Three Phase / 50 Hz	Three Phase / 50 Hz	Three Phase / 50 Hz	Three Phase / 50 Hz
Cooling capacity	kW		22,4	28,0	33,5	40,0	45,0
EER <sup>1)</sup>	W/W		4,50	4,10	3,70	3,45	3,38
Running current	380 / 400 / 415 V	A	8,60 / 8,20 / 8,00	11,3 / 10,8 / 10,6	15,1 / 14,5 / 14,1	19,2 / 18,4 / 17,9	22,0 / 21,1 / 20,6
Input power	kW		4,98	6,83	9,05	11,00	13,00
Heating capacity	kW		25,0	31,5	37,5	45,0	50,0
COP <sup>1)</sup>	W/W		4,77	4,55	4,30	4,41	4,03
Running current	380 / 400 / 415 V	A	8,95 / 8,50 / 8,30	11,6 / 11,0 / 10,7	14,7 / 14,1 / 13,8	17,0 / 16,4 / 15,9	20,7 / 19,9 / 19,4
Input power	kW		5,24	6,92	8,72	10,2	12,4
Air volume	m <sup>3</sup> /min		158	178	212	212	212
Sound pressure	Hi / Lo	dB(A)	57,0 / 54,0	59,0 / 56,0	61,0 / 58,0	62,0 / 59,0	62,0 / 59,0
Sound power	Normal mode	dB	71,5 / 68,5	73,5 / 70,5	75,5 / 72,5	76,5 / 73,5	76,5 / 73,5
Dimensions	H x W x D	mm	1.758 x 1.000 x 930	1.758 x 1.000 x 930	1.758 x 1.000 x 930	1.758 x 1.000 x 930	1.758 x 1.000 x 930
Net weight		kg	269	269	314	322	322
Piping connections	Suction pipe	Inch (mm)	3/4 (19,05)	7/8 (22,22)	1 (25,40)	1 (25,40)	1-1/8 (28,58)
	Discharge pipe	Inch (mm)	5/8 (15,88)	3/4 (19,05)	3/4 (19,05)	7/8 (22,22)	7/8 (22,22)
	Liquid pipe	Inch (mm)	3/8 (9,52)	3/8 (9,52)	1/2 (12,70)	1/2 (12,70)	1/2 (12,70)
	Balance pipe	Inch (mm)	1/4 (6,35)	1/4 (6,35)	1/4 (6,35)	1/4 (6,35)	1/4 (6,35)
Refrigerant (R410A)		kg / TCO <sub>2</sub> Eq.	8,3 / 17,3304	8,5 / 17,748	8,8 / 18,3744	9,3 / 19,4184	9,3 / 19,4184
Operating range	Cooling Min ~ Max	°C	-10 ~ +46	-10 ~ +46	-10 ~ +46	-10 ~ +46	-10 ~ +46
	Heating Min ~ Max	°C	-20 ~ +18	-20 ~ +18	-20 ~ +18	-20 ~ +18	-20 ~ +18
	Simultaneous operation	°C	-10 ~ +24	-10 ~ +24	-10 ~ +24	-10 ~ +24	-10 ~ +24

1) EER and COP classification is at 400V in accordance with EU directive 2002/31/EC.

#### Solenoid valve kit

KIT-P56HR3	KIT-P56HR3	3-Pipe control solenoid valve kit (up to 5,6kW)
	CZ-P56HR3	Solenoid valve kit (up to 5,6kW)
	CZ-CAPE2	3-Pipe control PCB
KIT-P160HR3	KIT-P160HR3	3-Pipe control solenoid valve kit (from 5,6kW to 10,6kW)
	CZ-P160HR3	Solenoid valve kit (up to 16,0kW)
CZ-CAPEK2	CZ-CAPE2	3-Pipe control PCB
		3-Pipe control PCB for wall mounted

#### 3-Pipe control box kit

CZ-P456HR3	4 ports 3 pipe box (up to 5,6kW)
CZ-P656HR3	6 ports 3 pipe box (up to 5,6kW)
CZ-P856HR3	8 ports 3 pipe box (up to 5,6kW)
CZ-P4160HR3	4 ports 3 pipe box (up to 16,0kW)



# 3-PIPE ECOi MF2 6N SERIES COMBINATION FROM 18 TO 48HP

With simultaneous heating and cooling operation heat recovery type.

ECOi 3-Pipe is one of the most advanced VRF systems available. Not only offering high-efficiency and performance for simultaneous heating and cooling, its sophisticated design makes installation and maintenance much easier.

- Achieves COP 4,63 as the top class in the industry (average cooling and heating value for 18HP outdoor unit).
- Simultaneous cooling or heating operation for up to 52 indoor units.
- Small installation space, top class in the industry.
- Rotation operation function and back-up operation function provided.

## Technical focus

- Standardisation of outdoor unit to one compact casing size
- Improved operation efficiency
- The constant-speed compressor adopts a high-performance internal high-pressure scroll
- Improvement of the heat exchanger
- Redesign of structural parts
- Close side-by-side installation is possible

HP		18HP	20HP	22HP	24HP	26HP	28HP	30HP	
Standard model		U-8MF2E8 U-10MF2E8	U-8MF2E8 U-12MF2E8	U-8MF2E8 U-14MF2E8	U-8MF2E8 U-16MF2E8	U-12MF2E8 U-14MF2E8	U-14MF2E8 U-14MF2E8	U-14MF2E8 U-16MF2E8	
Power supply	V	380 / 400 / 415	380 / 400 / 415	380 / 400 / 415	380 / 400 / 415	380 / 400 / 415	380 / 400 / 415	380 / 400 / 415	
		Three Phase / 50 Hz	Three Phase / 50 Hz	Three Phase / 50 Hz	Three Phase / 50 Hz	Three Phase / 50 Hz	Three Phase / 50 Hz	Three Phase / 50 Hz	
Cooling capacity	kW	50,4	56,0	61,5	68,0	73,0	78,5	85,0	
EER <sup>1)</sup>	W/W	4,27	3,97	3,80	3,68	3,58	3,49	3,41	
Running current	380 / 400 / 415 V	A	19,7 / 18,9 / 18,4	23,8 / 22,9 / 22,3	27,0 / 26,0 / 25,3	30,9 / 29,7 / 28,9	33,7 / 32,4 / 31,5	37,2 / 35,7 / 34,8	41,1 / 39,5 / 38,5
Input power	kW	11,8	14,1	16,2	18,5	20,4	22,5	24,90	
Heating capacity	kW	56,5	63,0	69,0	76,5	81,5	87,5	95,0	
COP <sup>1)</sup>	W/W	4,63	4,47	4,57	4,20	4,38	4,49	4,20	
Running current	380 / 400 / 415 V	A	20,4 / 19,6 / 19,1	23,8 / 22,9 / 22,3	25,2 / 24,2 / 23,6	30,4 / 29,2 / 28,5	31,1 / 29,8 / 29,1	32,6 / 31,3 / 30,5	37,7 / 36,2 / 35,3
Input power	kW	12,2	14,1	15,1	18,2	18,6	19,5	22,6	
Air volume	m <sup>3</sup> /min	336	370	370	370	424	424	424	
Sound pressure	Hi / Lo	dB(A)	61,0 / 58,0	62,5 / 59,5	63,0 / 60,0	63,0 / 60,0	64,5 / 61,5	65,0 / 62,0	65,0 / 62,0
Sound power	Normal mode	dB	75,5 / 72,5	77,0 / 74,0	77,5 / 74,5	77,5 / 74,5	79,0 / 76,0	79,5 / 76,5	79,5 / 76,5
Dimensions	H x W x D	mm	1.758 x 2.060 x 930	1.758 x 2.060 x 930	1.758 x 2.060 x 930	1.758 x 2.060 x 930	1.758 x 2.060 x 930	1.758 x 2.060 x 930	1.758 x 2.060 x 930
Net weight		kg	538	538	591	591	636	644	644
Piping connections	Suction pipe	Inch (mm)	1-1/8 (28,58)	1-1/8 (28,58)	1-1/8 (28,58)	1-1/8 (28,58)	1 1/4 (31,75)	1 1/4 (31,75)	1 1/4 (31,75)
	Discharge pipe	Inch (mm)	7/8 (22,22)	7/8 (22,22)	1 (25,40)	1 (25,40)	1 (25,40)	1-1/8 (28,58)	1-1/8 (28,58)
	Liquid pipe	Inch (mm)	5/8 (15,88)	5/8 (15,88)	5/8 (15,88)	5/8 (15,88)	3/4 (19,05)	3/4 (19,05)	3/4 (19,05)
	Balance pipe	Inch (mm)	1/4 (6,35)	1/4 (6,35)	1/4 (6,35)	1/4 (6,35)	1/4 (6,35)	1/4 (6,35)	1/4 (6,35)
Refrigerant (R410A)	kg / TCO <sub>2</sub> Eq.	16,8 / 35,0784	17,1 / 35,7048	17,6 / 36,7488	17,6 / 36,7488	18,1 / 37,7928	18,6 / 38,8368	18,6 / 38,8368	
Operating range	Cooling Min ~ Max	°C	-10 ~ +46	-10 ~ +46	-10 ~ +46	-10 ~ +46	-10 ~ +46	-10 ~ +46	-10 ~ +46
	Heating Min ~ Max	°C	-20 ~ +18	-20 ~ +18	-20 ~ +18	-20 ~ +18	-20 ~ +18	-20 ~ +18	-20 ~ +18
	Simultaneous operation	°C	-10 ~ +24	-10 ~ +24	-10 ~ +24	-10 ~ +24	-10 ~ +24	-10 ~ +24	-10 ~ +24

1) EER and COP classification is at 400 V in accordance with EU directive 2002/31/EC.

### Solenoid valve kit

KIT-P56HR3	KIT-P56HR3	3-Pipe control solenoid valve kit (up to 5,6kW)
	CZ-P56HR3	Solenoid valve kit (up to 5,6kW)
	CZ-CAPE2	3-Pipe control PCB
KIT-P160HR3	KIT-P160HR3	3-Pipe control solenoid valve kit (from 5,6kW to 10,6kW)
	CZ-P160HR3	Solenoid valve kit (up to 16,0kW)
CZ-CAPEK2	CZ-CAPE2	3-Pipe control PCB
		3-Pipe control PCB for wall mounted

### 3-Pipe control box kit

CZ-P456HR3	4 ports 3 pipe box (up to 5,6kW)
CZ-P656HR3	6 ports 3 pipe box (up to 5,6kW)
CZ-P856HR3	8 ports 3 pipe box (up to 5,6kW)
CZ-P4160HR3	4 ports 3 pipe box (up to 16,0kW)







	32HP	34HP	36HP	38HP	40HP	42HP	44HP	46HP	48HP
	U-16MF2E8 U-16MF2E8	U-8MF2E8 U-12MF2E8 U-14MF2E8	U-8MF2E8 U-14MF2E8 U-14MF2E8	U-8MF2E8 U-14MF2E8 U-16MF2E8	U-8MF2E8 U-16MF2E8 U-16MF2E8	U-14MF2E8 U-14MF2E8 U-14MF2E8	U-14MF2E8 U-14MF2E8 U-16MF2E8	U-14MF2E8 U-16MF2E8 U-16MF2E8	U-16MF2E8 U-16MF2E8 U-16MF2E8
	380 / 400 / 415	380 / 400 / 415	380 / 400 / 415	380 / 400 / 415	380 / 400 / 415	380 / 400 / 415	380 / 400 / 415	380 / 400 / 415	380 / 400 / 415
	Three Phase / 50 Hz	Three Phase / 50 Hz	Three Phase / 50 Hz	Three Phase / 50 Hz	Three Phase / 50 Hz	Three Phase / 50 Hz	Three Phase / 50 Hz	Three Phase / 50 Hz	Three Phase / 50 Hz
	90,0	96,0	101,0	107,0	113,0	118,0	124,0	130,0	135,0
	3,38	3,74	3,66	3,60	3,55	3,48	3,43	3,40	3,38
	43,9 / 42,2 / 41,1	42,9 / 41,2 / 39,7	46,1 / 44,3 / 43,1	49,6 / 47,6 / 46,4	53,1 / 51,0 / 49,7	56,0 / 53,8 / 52,4	59,6 / 57,3 / 55,8	63,8 / 61,3 / 59,7	65,9 / 63,3 / 61,7
	26,6	25,7	27,6	29,7	31,8	33,9	36,1	38,2	39,9
	100,0	108,0	113,0	119,0	127,0	132,0	138,0	145,0	150,0
	4,03	4,44	4,52	4,33	4,12	4,46	4,30	4,14	4,03
	41,7 / 40,1 / 39,1	41,0 / 39,4 / 38,4	41,6 / 39,9 / 38,9	46,1 / 44,3 / 43,1	52,2 / 49,6 / 47,8	49,3 / 47,3 / 46,1	53,8 / 51,6 / 50,3	58,8 / 56,5 / 55,0	62,6 / 60,1 / 58,6
	24,8	24,3	25,0	27,5	30,8	29,6	32,1	35,0	37,2
	424	582	582	582	582	636	636	636	636
	65,0 / 62,0	65,0 / 62,0	65,5 / 62,5	65,5 / 62,5	65,5 / 62,5	67,0 / 64,0	67,0 / 64,0	67,0 / 64,0	67,0 / 64,0
	79,5 / 76,5	79,5 / 76,5	80,0 / 77,0	80,0 / 77,0	80,0 / 77,0	81,5 / 78,5	81,5 / 78,5	81,5 / 78,5	81,5 / 78,5
	1.758 x 2.060 x 930	1.758 x 3.120 x 930	1.758 x 3.120 x 930	1.758 x 3.120 x 930	1.758 x 3.120 x 930	1.758 x 3.120 x 930	1.758 x 3.120 x 930	1.758 x 3.120 x 930	1.758 x 3.120 x 930
	644	905	913	913	913	966	966	966	966
	1 1/4 (31,75)	1 1/4 (31,75)	1-1/2 (38,10)	1-1/2 (38,10)	1-1/2 (38,10)	1-1/2 (38,10)	1-1/2 (38,10)	1-1/2 (38,10)	1-1/2 (38,10)
	1-1/8 (28,58)	1-1/8 (28,58)	1-1/8 (28,58)	1 1/4 (31,75)	1 1/4 (31,75)	1 1/4 (31,75)	1 1/4 (31,75)	1 1/4 (31,75)	1 1/4 (31,75)
	3/4 (19,05)	3/4 (19,05)	3/4 (19,05)	3/4 (19,05)	3/4 (19,05)	3/4 (19,05)	3/4 (19,05)	3/4 (19,05)	3/4 (19,05)
	1/4 (6,35)	1/4 (6,35)	1/4 (6,35)	1/4 (6,35)	1/4 (6,35)	1/4 (6,35)	1/4 (6,35)	1/4 (6,35)	1/4 (6,35)
	18,6 / 38,8368	26,4 / 55,1232	26,9 / 56,1672	26,9 / 56,1672	26,9 / 56,1672	27,9 / 58,2552	27,9 / 58,2552	27,9 / 58,2552	27,9 / 58,2552
	-10 ~ +46	-10 ~ +46	-10 ~ +46	-10 ~ +46	-10 ~ +46	-10 ~ +46	-10 ~ +46	-10 ~ +46	-10 ~ +46
	-20 ~ +18	-20 ~ +18	-20 ~ +18	-20 ~ +18	-20 ~ +18	-20 ~ +18	-20 ~ +18	-20 ~ +18	-20 ~ +18
	-10 ~ +24	-10 ~ +24	-10 ~ +24	-10 ~ +24	-10 ~ +24	-10 ~ +24	-10 ~ +24	-10 ~ +24	-10 ~ +24

# ECO G, THE GAS DRIVEN VRF

NEW VRF  
TECHNOLOGY

'17





The advanced Gas Driven VRF system offers increased efficiency and performance across the range. Improvements include increased part load performance, reduced gas consumption with a Miller-cycle engine and reduced electrical consumption by using DC-Fan motors.

**New ECO G GE3 Series**



Reduce by 30% electrical energy consumption giving better energy efficiency.

**ECO G GF2 3-Pipe**



3-Pipe heat recovery system with simultaneous heating & cooling.

**What is GHP? The Gas Heat Pump (GHP)**

Panasonic Gas Heat Pump is a direct expansion system with compressor as same as VRF system. Gas engine is used as driving source of compressor instead of electric motor. This gas engine compressor drive has 2 advantages:

1. Waste heat from the gas engine available
2. No need for motor power consumption thanks to gas engine

GHP is the natural choice for commercial projects, especially for those projects where power restrictions apply.

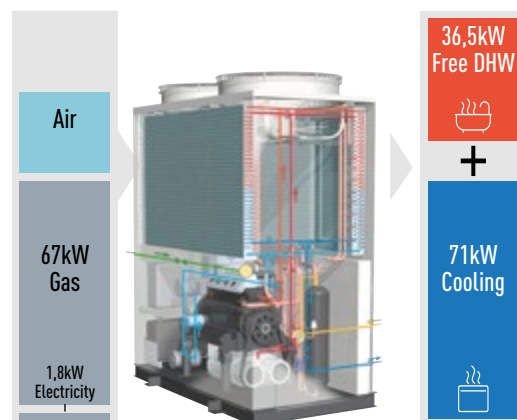
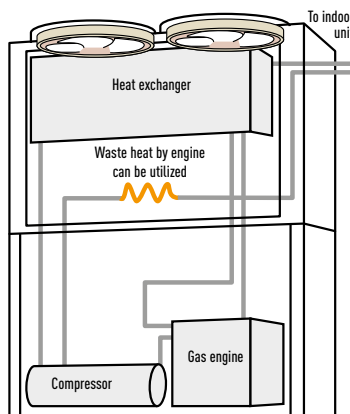

\* Regarding a 25HP model.

**4 benefit points of ECO G Series**

**1**

**Limited electric supply.**

Electric consumption of ECO G is only 9% compared to ECOi because gas engine is utilized for the compressor driving source.

**2**

**High demand of DHW with heating and cooling cogeneration.**

DHW is produced effectively thanks to heat from engine exhaust during heating and cooling.

**3**

**Open and flexible design.**

ECO G system is designed to connect various Indoor units and controllers which is available for ECOi system. With new GE3 series, Pump down system has been also implemented to answer commercial needs.

**4**

**Heating at low ambient temperature up to -20°C.**

Stable heating capacity has been realized with waste heat recovery from the engine even if outside temperature is quite low.

Comparison of heating capacity.

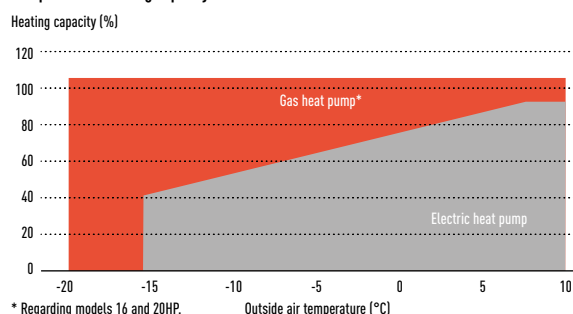

\* Regarding models 16 and 20HP.

# ECO G, THE GAS DRIVEN VRF

ECO G satisfies special requirement for your application and environmentally friendly solution by Panasonic professional technology.

Reliable quality by long development history since 1985.

Our GHP VRF range of commercial systems is leading the industry in the development of efficient and flexible systems



## Power supply problems?

If you are short of electric power, our ECO G is a perfect solution.

- Runs on natural gas or LPG and just needs single phase supply
- Enables the building's electrical power supply to be used for other critical electrical demands
- Reduces capital cost to upgrade power substations to run heating and cooling systems
- Reduces power loadings within a building especially during peak periods
- Electricity supply freed up for other uses such as IT servers, commercial refrigeration, manufacturing, lighting, etc...

Limited electricity area.  
Comparison of electrical consumption on a 71kW outdoor unit.

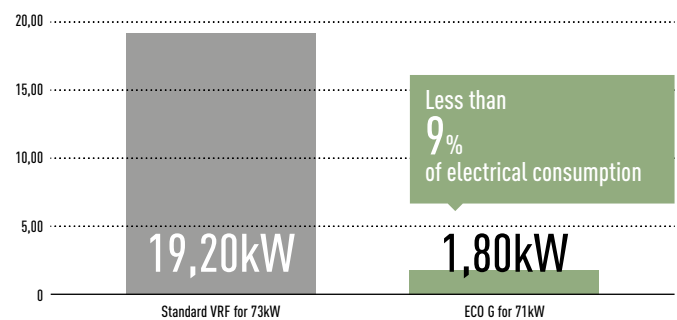

## High demand of Domestic Hot Water in heating and cooling

Generates electricity during heating or cooling operation.

Generates electricity and air conditioning (heating or cooling) at the same time by using remaining engine power. The rejected heat from the engine is available for DHW production and can supply up to 46kW of hot water at 65°C. DHW at 65°C is also ready to use in heating without additional electric heaters.

Application example: Hotel

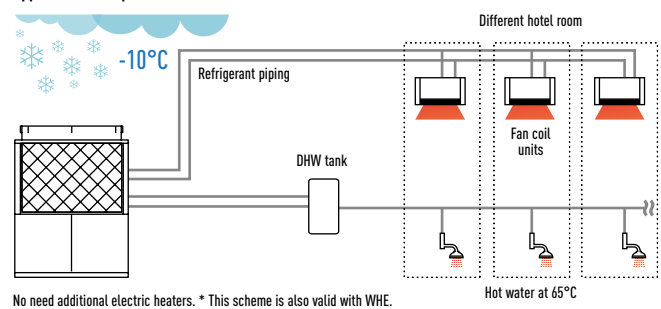

## Quick start up and great heating capacity at low ambient temperature

Waste heat from gas engine is utilized to raise temperature quicker than electric VRF system. This contributes great heating capacity at extremely low ambient temperature.

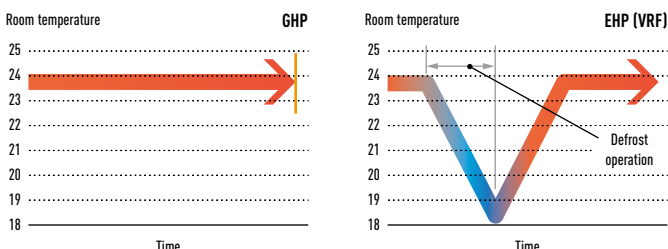

## Lowest nitrogen oxide emissions.

The GHP VRF systems have the lowest nitrogen oxide emissions. In a pioneering development, the Panasonic GHP features a brand new lean-burn combustion system that utilizes air fuel ratio feedback control to reduce NOx emissions to an all time low.

## Water chiller option.

Our GHP system is also available with a water chiller option, which can be combined with individual outdoor units or as part of a DX chilled water mix of indoor units. The system can be operated via a BMS system or a Panasonic supplied control panel, with chilled water set points from -15°C ~ +15°C and heating set points 35°C ~ +55°C.



## Application

Application	Condition	ECO G
Hotel	High DHW demand	✓ Energy recovery of ECO G system can fulfill different requirement
Hotel	Needs to warm up swimming pool	
Office	Quick start up is necessary	✓ Speed of start up is quicker than VRF system
Winery	1) Outlet water demand at specific temperature 2) Needs high amount of power temporary (not every month)	✓ 1) Chiller application with hydro module (ECO G + WHE) can make this special process 2) Running cost can be saved since fixed Gas tariff per month is cheaper than fixed electric tariff.
Any building	In a city with power restriction	✓ - No need an additional power transformer - Space and cost can be saved
	At extremely low ambient condition	✓ Heating capacity is kept up to -20°C without defrost process

## Project Case Studies



### Savills HQ Dublin & Google Block R. Ireland.

ECO G 3-way units with a 243kW load.

The project has been such a success that it has recently been awarded a Panasonic PRO Award for Best Contribution of efficient projects within Europe.



### Thomas Cook's Sunprime Atlantic View resort.

A holiday resort in the Canaries. Spain.

229 rooms plus full spa and swimming pool facility.



### CAPITA call centre. UK.

11 ECO G 3-way units.

Over 150 indoor units in meeting rooms and open-plan areas.

Intelligent touch screen controller, the CZ-256ESMC2.



### French winery Gennevilliers, France.

ECO G 3-way units. One of the best solution utilized our ECO G solution for wine production process.



# NEW ECO G GE3 SERIES

## Improvement in blast efficiency

### New 3-blades fan.

Propeller shape with 3 blades is more efficient. Max. 30% of fan electrical consumption is saved compared to conventional fan.

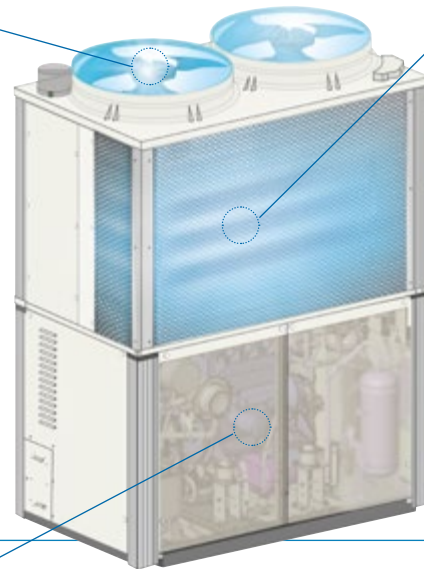
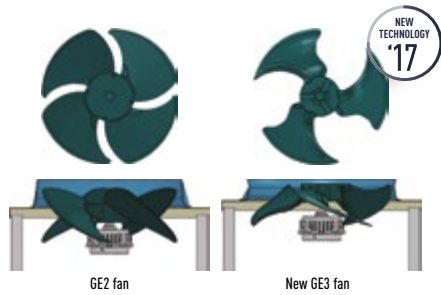

### New "L" type heat exchanger

Heat exchanger surface area is included by 25% compared to conventional model to optimize efficiency.

Heat exchanger surface area **25% up**

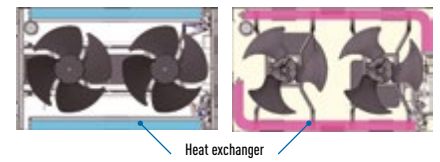

## Better partial load control

Reduce start / stop loss has reduced by expanding the area where continuous operation is possible. Annual operation efficiency has further improved by better efficiency at lower partial load.

### Compressor.

- Amount of internal leakage has reduced by the reduction of clearance, the compressor efficiency in the low load and low rotation region has been greatly improved.
- Moreover, efficiency of high speed and high load is also improved by reduction of suction pressure loss due to expansion of suction path
- Optimize compressor capacity

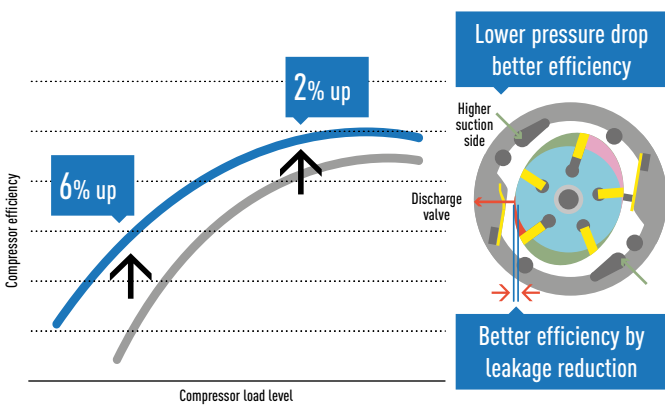

### Engine.

- Continuous operation area has expanded at lower partial load by expanding operation area of lower speed
- Engine efficiency has improved by shifting output points to higher torque side

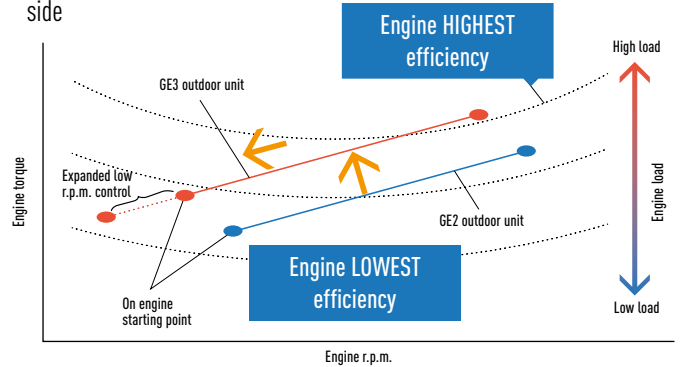

### Engine pulley.

- Bigger diameter of engine pulley contributes the optimization of the compressor rotation speed ratio with engine speed
- Higher engine pulley diameter giving better performance at partial load and reducing ON/OFF operation.

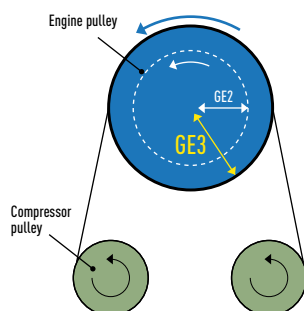

## New line up of W-Multi

- For new or renewal
- Available for water heat exchanger
- Maximum 60HP combination

**Introducing new ECO G GE3 Series.**  
Optimized energy saving with reliable Panasonic technologies.

**High power efficiency of W-Multi system**

GE3 system offers seasonal efficiency which has been drastically improved with new heat exchanger design, blast efficiency, partial load control.

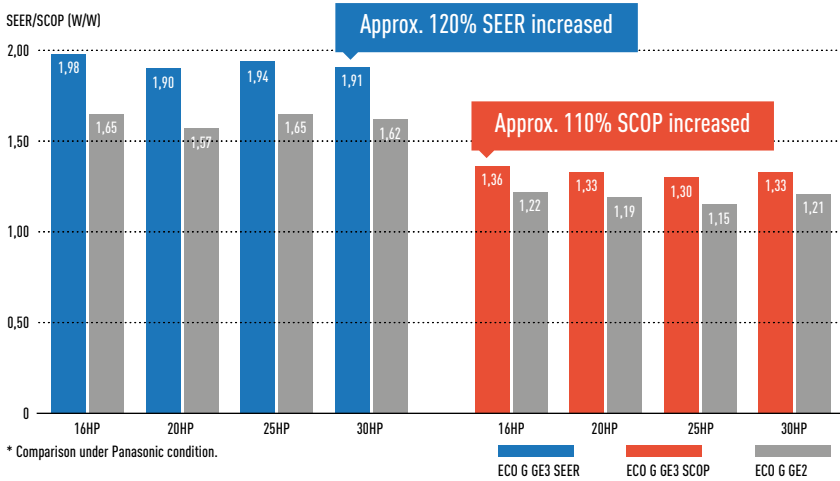

**Compared to conventional model ECO G GE2.**

All models are newly developed and have maximum 21% of SEER, 13% of SCOP better than conventional model.

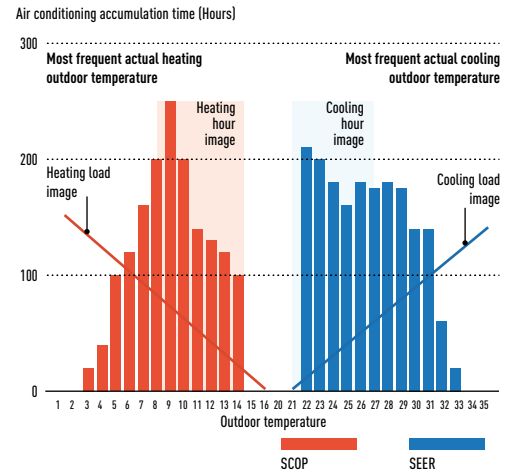

**Heating design operation conditions**

Operating range in heating has been expanded up to 24°C (WB) for air to water system to meet the demand of swimming pool application.

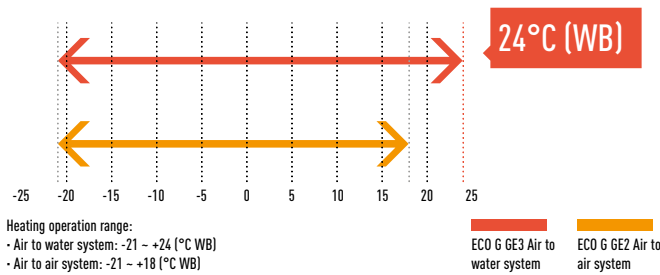

**DHW priority mode setting in heating**

Ambient temperature range for DHW production is expandable by setting depending on DHW needs. Hot water at 65°C is available in heating without additional electric heaters.

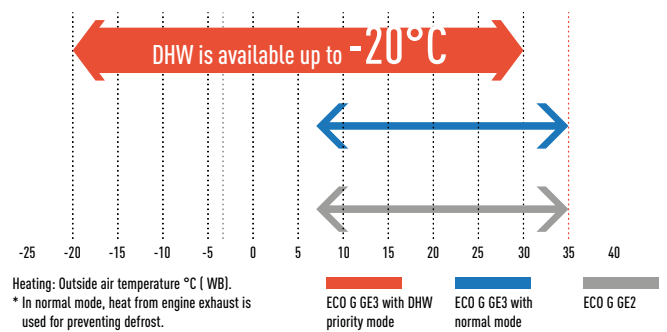

**Automatic refrigerant leak detection is available**

One of the big advantage is that new GE3 series can be connected to pump down system. Now refrigerant leak is detected automatically in not only ECOi system but also ECO G system.

**No defrost requirement**

No defrost mode is selectable to get higher capacity under low ambient temperature.

**Flexible design with wide line up of indoor units**

The advanced GE3 series can connect up to 64 indoor units.

Series	16HP	20HP	25HP	30HP	32HP	36HP	40HP	45HP	50HP	55HP	60HP
GE2 2-Pipe	24	24	24	32	48	48	48	48	48	48	48
GE3 2-Pipe	26	33	41	50	52	59	64	64	64	64	64

# NEW ECO G GE3 SERIES 2-PIPE

## New ECO G GE3 Series 2-Pipe.

The new GE3 Series has a top level of seasonal efficiency in this category. In addition, this product fits with special needs for commercial application thanks to DHW priority setting and Auto pump down functions.

### Technical focus

- 20% of SEER and 10% of SCOP have been improved
- Operating range in heating up to 35°C
- DHW priority setting
- Auto pump down system available
- 0-10V control demand by a connection with 3rd party controllers (CZ-CAPBC2 required)
- Option of DX or chilled water for indoor heat exchange

HP			16HP	20HP	25HP	30HP
Model			U-16GE3E5	U-20GE3E5	U-25GE3E5	U-30GE3E5
Power supply	Voltage	V	220 / 230 / 240	220 / 230 / 240	220 / 230 / 240	220 / 230 / 240
	Phase		Single Phase	Single Phase	Single Phase	Single Phase
	Frequency	Hz	50	50	50	50
Cooling capacity		kW	45,0	56,0	71,0	85,0
Input power cooling		kW	1,17	1,12	1,80	1,80
Hot water in cooling mode (at 65°C outlet)		kW	23,6	29,1	36,4	46,0
<b>SEER</b>		<b>W/W</b>	<b>1,98</b>	<b>1,90</b>	<b>1,94</b>	<b>1,91</b>
Max COP in hot water		W/W	1,55	1,55	1,49	1,47
Gas consumption cooling	Standard / Low temperature	kW	41,1	52,1	67,2	84,1
Heating capacity	Standard / Low temperature	kW	50,0 / 53,0	63,0 / 67,0	80,0 / 78,0	95,0 / 90,0
Input power heating			0,56	1,05	0,91	1,75
<b>SCOP</b>	<b>A2A</b>	<b>W/W</b>	<b>1,36</b>	<b>1,33</b>	<b>1,30</b>	<b>1,33</b>
Gas consumption heating	Standard / Low temperature	kW	38,0 / 45,4	51,1 / 62,7	68,6 / 60,7	75,3 / 73,9
Starter amperes		A	30	30	30	30
External static pressure		Pa	10	10	10	10
Air volume		m³/min	370	420	460	460
Sound power	Normal / Silent	dB(A)	80 / 77	80 / 77	84 / 81	84 / 81
Dimensions	H x W x D	mm	2.255 x 1.650 x 1.000	2.255 x 1.650 x 1.000	2.255 x 2.026 x 1.000	2.255 x 2.026 x 1.000
Net weight		kg	765	765	870	880
Piping connections	Liquid pipe	Inch (mm)	1/2 (12,70)	5/8 (15,88)	5/8 (15,88)	3/4 (19,05)
	Gas pipe	Inch (mm)	1-1/8 (28,58)	1-1/8 (28,58)	1-1/8 (28,58)	1-1/4 (31,75)
	Balance pipe	Inch (mm)	—	—	—	—
Elevation difference (in/out)		m	50	50	50	50
Refrigerant (R410A)		kg / TCO: Eq.	11,5 / 24,0	11,5 / 24,0	11,5 / 24,0	11,5 / 24,0
Maximum number of connectable indoor units			26	33	41	50
Operating range	Cooling Min - Max	°C (DB)	-10 - +43	-10 - +43	-10 - +43	-10 - +43
	Heating Min - Max	°C (WB)	-21 - +18	-21 - +18	-21 - +18	-21 - +18

Hot water take out function added, EU safety regulation standard cleared. 25HP chassis enlarged due to specification improvement.  
Pre-coat corrosion fin. Auto pump down function.







HP			32HP	36HP	40HP	45HP	50HP	55HP	60HP
Model			U-16GE3E5	U-16GE3E5	U-20GE3E5	U-20GE3E5	U-25GE3E5	U-25GE3E5	U-30GE3E5
Power supply	Voltage	V	220 / 230 / 240	220 / 230 / 240	220 / 230 / 240	220 / 230 / 240	220 / 230 / 240	220 / 230 / 240	220 / 230 / 240
	Phase		Single Phase	Single Phase	Single Phase	Single Phase	Single Phase	Single Phase	Single Phase
	Frequency	Hz	50	50	50	50	50	50	50
Cooling capacity		kW	90	101	112	127	142	156	170
Input power cooling		kW	2,34	2,29	2,24	2,92	3,6	3,6	3,6
Hot water in cooling mode (at 65°C outlet)		kW	47,2	52,7	58,2	65,5	72,8	82,42	92,04
SEER		W/W	<b>1,98</b>	<b>1,94</b>	<b>1,90</b>	<b>1,92</b>	<b>1,94</b>	<b>1,92</b>	<b>1,91</b>
Max COP in hot water		W/W	1,55	1,55	1,55	1,52	1,49	1,48	1,47
Gas consumption cooling	Standard / Low temperature	kW	82,20	93,20	104,20	119,30	134,40	151,30	168,20
Heating capacity	Standard / Low temperature	kW	100 / 106	113 / 120	126 / 134	143 / 145	160 / 156	175 / 168	190 / 180
Input power heating			1,12	1,61	2,10	1,96	1,82	2,66	3,50
SCOP	A2A	W/W	<b>1,36</b>	<b>1,34</b>	<b>1,33</b>	<b>1,31</b>	<b>1,30</b>	<b>1,31</b>	<b>1,33</b>
Gas consumption heating	Standard / Low temperature	kW	76,0 / 90,8	89,1 / 108,1	102,2 / 125,4	119,7 / 123,4	137,2 / 121,4	143,9 / 134,6	150,6 / 147,8
Starter amperes		A	30	30	30	30	30	30	30
External static pressure		Pa	10	10	10	10	10	10	10
Air volume		m <sup>3</sup> /min	370 / 370	370 / 420	420 / 420	420 / 460	460 / 460	460 / 460	460 / 460
Sound power	Normal / Silent	dB(A)	83 / 80	83 / 80	83 / 80	86 / 83	87 / 84	87 / 84	87 / 84
	Height	mm	2.255	2.255	2.255	2.255	2.255	2.255	2.255
	Width	mm	1.650 + 100 + 1.650	1.650 + 100 + 1.650	1.650 + 100 + 1.650	1.650 + 100 + 2.026	2.026 + 100 + 2.026	2.026 + 100 + 2.026	2.026 + 100 + 2.026
Dimensions	Depth	mm	1.000	1.000	1.000	1.000	1.000	1.000	1.000
	Net weight	kg	1.530 (765 + 765)	1.530 (765 + 765)	1.530 (765 + 765)	1.635 (765 + 870)	1.740 (870 + 870)	1.750 (870 + 880)	1.760 (880 + 880)
Piping connections	Liquid pipe	Inch (mm)	3/4 (19,05)	3/4 (19,05)	3/4 (19,05)	3/4 (19,05)	3/4 (19,05)	7/8 (22,22)	7/8 (22,22)
	Gas pipe	Inch (mm)	1-1/4 (31,75)	1-1/4 (31,75)	1-1/2 (38,10)	1-1/2 (38,10)	1-1/2 (38,10)	1-1/2 (38,10)	1-1/2 (38,10)
	Balance pipe	Inch (mm)	—	—	—	—	—	—	—
Elevation difference (in/out)		m	50	50	50	50	50	50	
Refrigerant (R410A)		kg / TCO <sub>2</sub> Eq.	2x 11,5 / 24,0	2x 11,5 / 24,0	2x 11,5 / 24,0	2x 11,5 / 24,0	2x 11,5 / 24,0	2x 11,5 / 24,0	
Maximum number of connectable indoor units			52	59	64	64	64	64	
Operating range	Cooling Min ~ Max	°C (DB)	-10 ~ +43	-10 ~ +43	-10 ~ +43	-10 ~ +43	-10 ~ +43	-10 ~ +43	-10 ~ +43
	Heating Min ~ Max	°C (WB)	-21 ~ +18	-21 ~ +18	-21 ~ +18	-21 ~ +18	-21 ~ +18	-21 ~ +18	-21 ~ +18

Hot water take out function added, EU safety regulation standard cleared. 25HP chassis enlarged due to specification improvement. Pre-coat corrosion fin. Auto pump down function.



# ECO G GF2 3-PIPE



## Power supply problems?

If you are short of electrical power, our gas heat pump could be the perfect solution:

- Runs on natural gas or LPG and just needs Single Phase supply
- Enables the building's electrical power supply to be used for other critical electrical demands
- Reduces capital cost to upgrade power substations to run heating and cooling systems
- Reduces power loadings within a building especially during peak periods
- Electricity supply freed up for other uses such as IT servers, commercial refrigeration, manufacturing, lighting etc.

## GHP Outdoor Heat Exchanger

- Integrated DX and hot water coil
- No defrost required
- Faster reaction to demand for heating

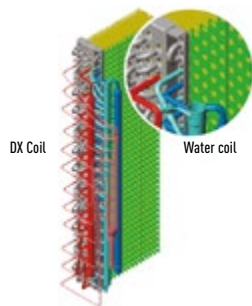

## Comparison of heating capacity.

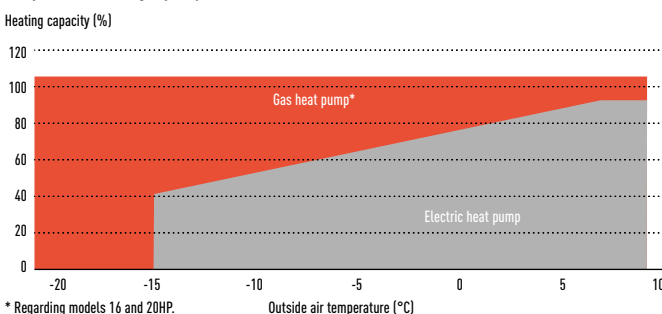

## Excellent performance

Panasonic 3-Pipe Multi system is capable of simultaneous heating/cooling and individual operation of each indoor unit by only one outdoor unit. As a result, efficient individual air conditioning is possible in buildings having diverse room temperatures.

## System example.

Improved maintenance intervals. The unit only needs to be serviced every 10,000 hours. This is the best in the industry.

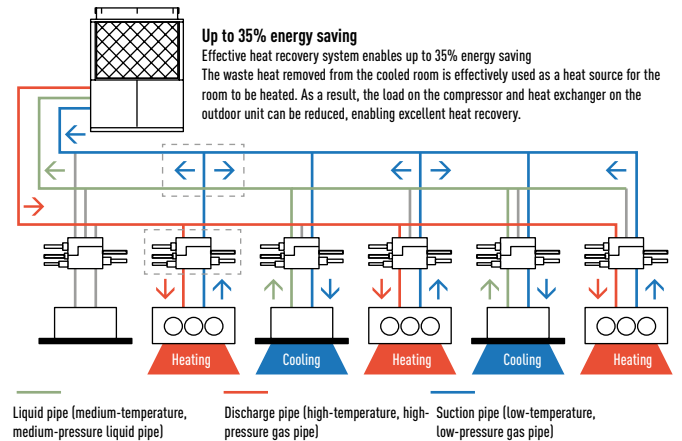

## Solenoid valve kit.

To be fitted on all 'zones' to allow simultaneous heating and cooling. Up to 36 indoor units are capable of simultaneous heating/cooling operation. Oil-recovery operation to gives more stable comfort air-conditioning control.

### 3-Pipe control Solenoid valve kit

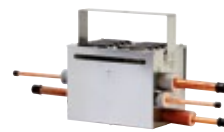

**CZ-P56HR3**  
Up to 5,6kW  
**CZ-P160HR3**  
Up to 16,0kW

**KIT-P56HR3**  
(CZ-P56HR3+CZ-CAPE2)  
**KIT-P160HR3**  
(CZ-P160HR3+CZ-CAPE2)

### 3-Pipe control PCB



**CZ-CAPE2\***  
3-Pipe control PCB

\* For wall mounted. Must be added to the CZ-P56HR3 or CZ-P160HR3.

## Comparison of the start times for heating operation.

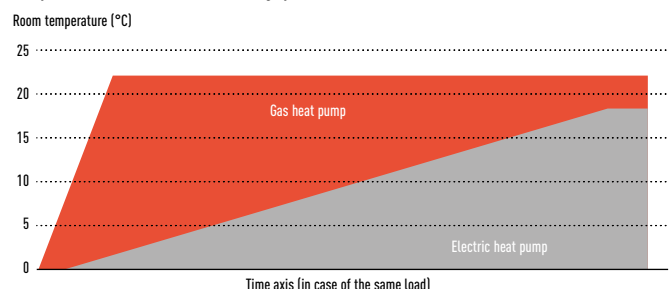

## ECO G GF2 3-PIPE

### 3-Pipe heat recovery system with simultaneous heating & cooling.

The only 3-Pipe GHP system in Europe, the S Series ECO G GF2 3-Pipe offers even more performance and outstanding features when you need simultaneous heating and cooling. Now with capacities available from 16HP to 25HP, Panasonic offers the greatest choice and flexibility to solve any power problem or site requirement.

#### Technical focus

- Reduced gas consumption by Miller-cycle engine
- Reduced electrical power consumption by using DC Motors
- Capacity ratio 50–200%
- Quiet mode offers a further 2dB(A) reduction
- Part load efficiencies increased
- Connectivity increased to up to 24 indoor units
- 145m maximum allowable piping length (L1)
- Extended pipe runs (total 780m)
- Option of using LPG as a power supply (increases flexibility and avoids problems of potential site restrictions in the future. The purer fuel is also excellent for further reductions in CO<sub>2</sub> emissions)
- Full heating capacity down to -21°C
- No defrost cycle



\* Assuming 3,120 running hours per year - 12 h x 5 days x 52 weeks

HP			16HP	20HP	25HP
Model			U-16GF2E5	U-20GF2E5	U-25GF2E5
Cooling capacity		kW	45,00	56,00	71,00
Input power cooling		kW	0,71	1,02	1,33
EER (Calorific Value) <sup>1</sup>	Hi / Lo	W/W	1,48 / 1,64	1,40 / 1,55	1,15 / 1,28
Cooling gas consumption		kW	29,7	39,1	60,4
Heating capacity	Standard	kW	50,00	63,00	80,00
	Low temperature <sup>2</sup>	kW	53,00	67,00	78,00
Input power heating		kW	0,60	0,64	0,83
COP (Calorific Value) <sup>1</sup>	Hi / Lo	W/W	1,51 / 1,68	1,46 / 1,62	1,48 / 1,64
Gas consumption	Standard	kW	32,5	42,5	53,2
	Low temperature <sup>2</sup>	kW	41,5	56,4	62,3
COP	Average		1,50	1,43	1,32
Starter amperes		A	30	30	30
Operation sound		dB(A)	57	58	62
Dimensions	H x W x D	mm	2,273 x 1,650 x 1,000 (+80)	2,273 x 1,650 x 1,000 (+80)	2,273 x 1,650 x 1,000 (+80)
Net weight		kg	775	775	805
Pipe Connections	Gas	Inch (mm)	1 1/8 (28,58)	1 1/8 (28,58)	1 1/8 (28,58)
	Liquid	Inch (mm)	3/4 (19,05)	3/4 (19,05)	3/4 (19,05)
	Discharge	Inch (mm)	7/8 (22,22)	1 (25,40)	1 (25,40)
	Fuel gas		R3/4	R3/4	R3/4
	Exhaust drain port	mm	25	25	25
Refrigerant (R410A)		kg / TCO <sub>2</sub> Eq.	10,5 / 21,9	11,5 / 24,0	11,5 / 24,0
Maximum allowable indoor / outdoor capacity ratio			50–200% <sup>3</sup>	50–200% <sup>3</sup>	50–200% <sup>3</sup>
Maximum number of connectable indoor units			24	24	24

1) Referred to Natural Gas (HCV 37,78 MJ/Nm<sup>3</sup> or 55,56 MJ/kg; LCV 34,00 MJ/Nm<sup>3</sup> or 50,00 MJ/kg). 2) Low temperature condition: outdoor temperature 2°C. 3) Indoor unit can be connected to up to 16kW model (model size 60). Cooling and heating capacities in the tables are determined under the test conditions of JIS B 8627. Effective heating requires that the outdoor air intake temperature be at least -20°C DB or -21°C WB. Gas consumption is the total (high) calorific value standard. Outdoor unit operating sound is measured 1m from the front and 1,5m above the floor (in an anechoic environment). Actual installations may have larger values due to ambient noise and reflections.

#### Solenoid valve kit

KIT-P56HR3	KIT-P56HR3	3-Pipe control solenoid valve kit (up to 5,6kW)
	CZ-P56HR3	Solenoid valve kit (up to 5,6kW)
	CZ-CAPE2	3-Pipe control PCB
KIT-P160HR3	KIT-P160HR3	3-Pipe control solenoid valve kit (from 5,6kW to 10,6kW)
	CZ-P160HR3	Solenoid valve kit (up to 10,6kW)
	CZ-CAPE2	3-Pipe control PCB
CZ-CAPEK2		3-Pipe control PCB for wall mounted

#### 3-Pipe control box kit

CZ-P456HR3	4 ports 3 pipe box (up to 5,6kW)
CZ-P656HR3	6 ports 3 pipe box (up to 5,6kW)
CZ-P856HR3	8 ports 3 pipe box (up to 5,6kW)
CZ-P4160HR3	4 ports 3 pipe box (up to 16,0kW)

#### Service kits model

Kit CZ-PSK50SP	Material included
	Oil filter
	Air cleaner element
	Spark plug
	V Belt (for compressor)
	V Belt (for generator)
	Oil absorption mats
	Drain filter packing





# WATER HEAT EXCHANGER FOR HYDRONIC APPLICATIONS





When a top London restaurant opened, it needed large volumes of fresh air to ensure the optimum dining environment. GHP units connected to the cooling coils within the air handling equipment ensured the air was introduced in the right condition in both summer and winter.

**Chiller replacement. Chilled water supply to fan coils**

**Chiller replacement.**

When some old chillers needed replacing at the end of their operational lifetime, GHPs with Water Heat Exchangers enabled the project to be carried out in stages whilst still utilising the existing water pipe work and fan coils. This enabled the project to be delivered on time, to a restricted budget and avoided all issues regarding refrigerant in confined spaces.



**Connection to 'close control' computer equipment**

**Computer room applications.**

When all available electrical power needed to be utilised for the IT equipment for a leading international bank, the cooling load of over 450kW had to be powered by gas. The outdoor units were connected via Water Heat Exchangers to cooling coils inside the 'close control' units thereby maintaining a conditioned environment for temperature and humidity. By utilising the hot water function over 100kW of hot water are supplied to the building and therefore the additional benefit of considerable CO<sub>2</sub> savings is ensured.

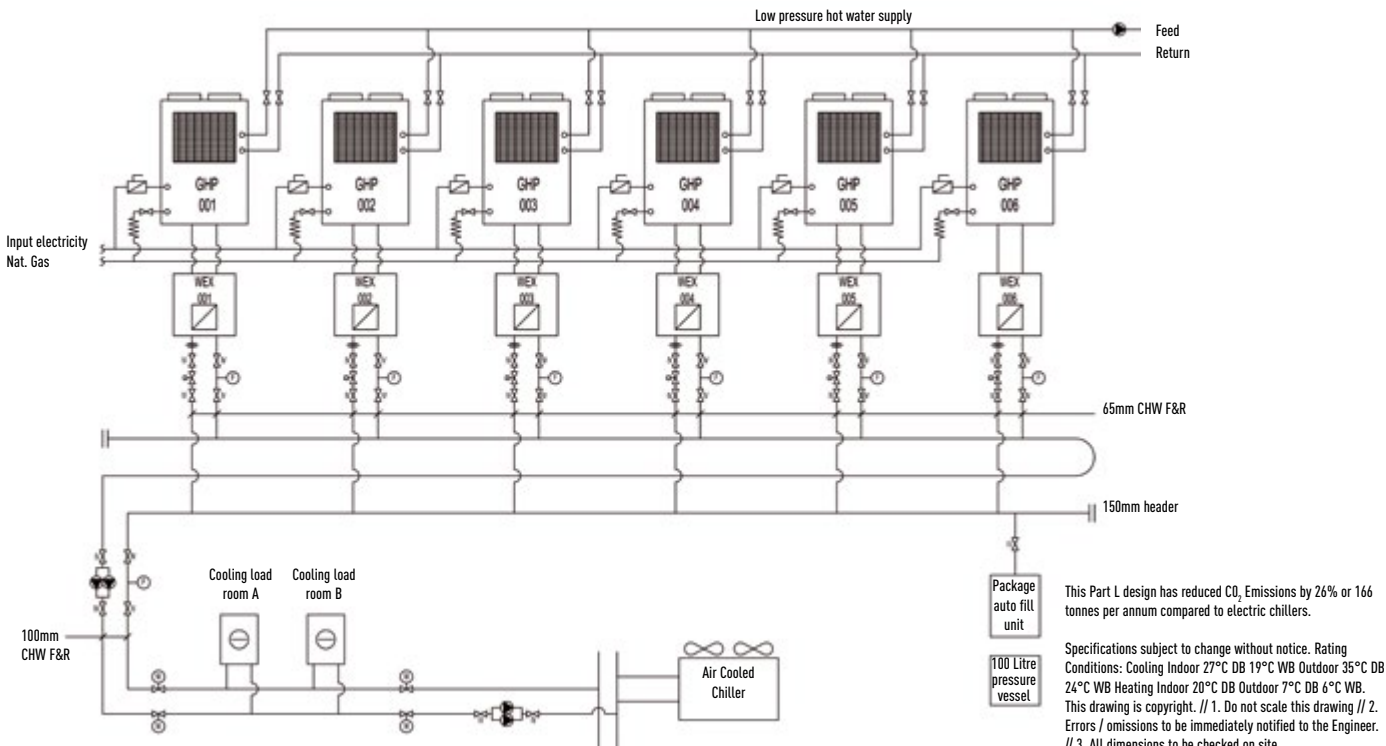

# ECOi 2-PIPE WITH WATER HEAT EXCHANGER FOR CHILLED AND HOT WATER PRODUCTION



The Panasonic solution for chilled and hot water production!

## For hydronic applications

Water Heat Exchanger (WHE) for ECOi. Operation and control by timer remote control CZ-RTC4. Energy-efficient capacity control. Stainless steel plate heat exchanger with anti-freeze protection control. Change-over between heating and cooling operation.

## Technical focus

- A class water pump included
- 4 Way valve included
- Heating, cooling and DHW
- Increased energy efficiency and low CO<sub>2</sub> emissions
- Water connections R2" f for 28kW and R2,5" f for 50kW
- Maximum distance between outdoor unit and WHE: 170m
- Maximum hot water outlet temperature: 45°C
- Minimum chilled water outlet temperature: 5°C
- Outdoor temperature range in cooling mode: +5°C to +43°C
- Outdoor temperature range in heating mode: -11°C to +15°C (with low temperature kit -25°C)

## ECOi Water Heat Exchanger

Electrical VRF with Water Heat Exchanger

- With this easy to install Water Heat Exchanger unit, you can now cover projects up to 51kW hot water demand or 44kW on chilled application on an efficient way and cost effective

### System example

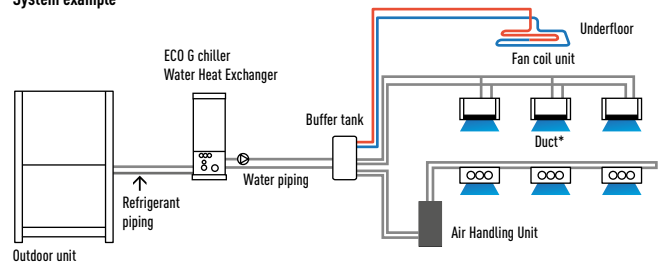

A Buffer tank of minimum 280l for 28kW and 500l for 50kW is always needed.

## New electrical panel with new algorithm

- Optimized heat exchanger to increase drastically the efficiency
- Liquid receiver to outperform the functionality of the WHE
- Unique 4 way valve in order always have counterflow fluid circulation in heating and cooling fluid circulation on both sides of the cross flow. This optimizes efficiency!



Optional Controller. Wired remote controller CZ-RTC5A Compatible with Econavi



Optional Controller. Timer remote controller CZ-RTC4 Compatible with Econavi

Hydrokit with A class water pump*			PAW-250WX2E5N		PAW-500WX2E5N
Hydrokit without pump			PAW-250WX2E5N2		PAW-500WX2E5N2
Cooling capacity at 35°C, water outlet 7°C	kW		25,0		50,0
Heating capacity	kW		28,0		56,0
Heating capacity at +7°C, heating water temperature at 45°C	kW		28,0		56,0
COP at +7°C with heating water temperature at 45°C	W/W		2,97		3,10
Heating Energy Efficiency class at 35°C			<b>A+</b>		<b>A++</b>
Dimensions	H x W x D	mm	1.010 x 570 x 960		1.010 x 570 x 960
Net weight		kg	120		145
Water pipe connector			Rp2 Female Thread (50A)		Rp2 Female Thread (50A)
Heating water flow (ΔT=5 K, 35°C)		m <sup>3</sup> /h	4,3		8,6
Capacity of integrated electric heater		kW	Not equipped		Not equipped
Input power		kW	0,01 + (min. 0,05 / max. 0,13 for water pump)		0,01 + (min. 0,19 / max. 0,31 for water pump)
Maximum current		A	0,07 + (min. 0,37 / max. 0,95 for water pump)		0,07 + (min. 0,88 / max. 1,37 for water pump)
<b>Outdoor Unit</b>			<b>U-10ME2E8</b>		<b>U-20ME2E8</b>
Sound pressure		dB(A)	59		63
Dimensions / Net weight	H x W x D	mm / kg	1.758 x 770 x 930 / 234		1.758 x 1.540 x 930 / 421
Piping connections	Liquid pipe / Gas pipe	Inch (mm)	3/8 (9,52) / 7/8 (22,22)		5/8 (15,88) / 1-1/8 (28,58)
Refrigerant (R410A)		kg	6,8 *Need Additional gas amount at site		9,0 *Need Additional gas amount at site
Pipe length range / Elevation difference (in/out)		m	170 / 50 (OD above) 35 (OD below)		170 / 50 (OD above) 35 (OD below)
Pipe length for nominal capacity		m	7,5		7,5
Pipe length for additional gas / Additional gas amount (R410A)		m / g/m	0 < / Refer to manual		0 < / Refer to manual
Operation range	Heating Min - Max	°C	-11 ~ +15 <sup>1)</sup>		-11 ~ +15 <sup>1)</sup>
Water outlet at 5 / 15 <sup>2)</sup>		°C	35 ~ 45		35 ~ 45

\* PAW-250WX2E5N includes pump with 0-10 Volt Control by default / PAW-500WX2E5N includes pump with 0-10 Volt with optional IF.

1) With accessory low temperature kit -25 ~ +15°C.

Performance calculation in agreement with Eurovent. Sound pressure measured at 1m from the outdoor unit and at 1,5m height.

# ECO G WITH WATER HEAT EXCHANGER FOR CHILLED AND HOT WATER PRODUCTION



Excellent applicability when there is a thermal demand for heat, DHW and cooling, as well as additional thermal usages.

## For hydronic applications

Water Heat Exchanger. Operation and control by timer remote control CZ-RTC4. Energy-efficient capacity control. Stainless steel plate heat exchanger with anti-freeze protection control. Change-over between heating and cooling operation.

## Technical focus

- A class water pump included (only in N model)
- No cascade installation up to 80kW
- Water connections R2,5" f
- Maximum distance between outdoor units and WHE: 170m
- Possibility to mix DX and Water Heat Exchanger systems
- Super silent outdoor units
- Hot water outlet temperatures from 35°C to 55°C
- Chilled water outlet temperatures from -15°C to +15°C
- Outdoor temperature range in cooling mode: -10°C to +43°C
- Minimum outdoor temperature in heating mode: -21°C

Case Study, Hotel Application

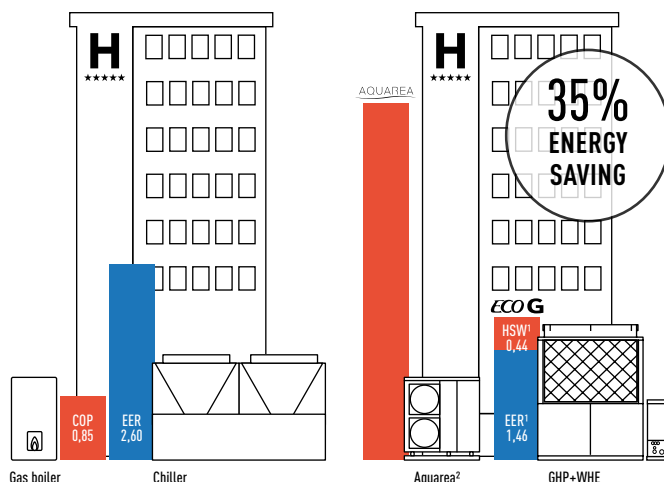

1) Total COP= 1,90, calculated in primary energy (U-20GE2E8). Equivalent EER (2007/749)= 3,73.  
2) Electric to support pick of consumption on domestic hot water.

## Example of Hotel renewal of existing Chiller and Boiler system with Panasonic GHP and Aquarea mixed solution

GHP and Aquarea are the smart solution for renewal Chiller/Boiler applications with annual running cost savings around 13.600€.



Optional Controller. Wired remote controller CZ-RTC5A Compatible with Econavi



Optional Controller. Timer remote controller CZ-RTC4 Compatible with Econavi

Hydrokit with A class water pump*		PAW-500WX2E5N		PAW-710WX2E5N	
Hydrokit without pump		PAW-500WX2E5N2		PAW-710WX2E5N2	
Heating Capacity	kW	60,0		80,0	
Heating Capacity at +7°C, heating water temperature at 35°C	kW	60,9		81,2	
COP at +7°C with heating water temperature at 35°C	W/W	1,15		1,18	
Heating Capacity at +7°C, heating water temperature at 45°C	kW	60,0		80,0	
COP at +7°C with heating water temperature at 45°C	W/W	1,02		1,04	
Heating Capacity at -7°C, heating water temperature at 35°C	kW	48,2		50,8	
COP at -7°C, heating water temperature at 35°C	W/W	0,80		0,80	
Heating Capacity at -15°C, heating water temperature at 35°C	kW	46,3		50,0	
COP at -15°C with heating water temperature at 35°C	W/W	0,80		0,80	
<b>SCOP</b>	<b>W/W</b>	<b>1,30</b>		<b>1,27</b>	
Cooling capacity	kW				
Cooling capacity at +35°C, outlet temperature 7°C, inlet temperature 12°C	kW	50		67	
EER at +35°C, outlet temperature 7°C, inlet temperature 12°C	W/W	0,78		0,89	
<b>SEER</b>	<b>W/W</b>	<b>1,75</b>		<b>1,72</b>	
Dimensions / Weight	H x W x D	mm / kg		mm / kg	
Water pipe connector		1.010 x 570 x 960 / 145		1.010 x 570 x 960 / 180	
Heating water flow (ΔT=5 K, 35°C)	m³/h	10,32		13,76	
Capacity of integrated electric heater	kW				
Input power	kW				
Maximum current	A				
<b>Outdoor Unit</b>		<b>U-20GE3E5</b>		<b>U-30GE3E5</b>	
Sound power	Normal / Silent	dB(A)		dB(A)	
Dimensions / Weight	H x W x D	mm / kg		mm / kg	
Piping connections	Liquid pipe / Gas pipe	mm		mm	
Pipe length / for nominal capacity	Max.	m		m	
Elevation difference (in/out)		m		m	
Operation range	Heating Min - Max	°C		°C	
Water outlet at -15 / 15°		°C		°C	

Performance calculation in agreement with Eurovent. Sound pressure measured at 1m from the outdoor unit and at 1,5m height. \* PAW-500WX2E5N and PAW-710WX2E5N includes pump with 0-10 Volt with optional IF.

# LEAK DETECTION AND AUTOMATIC REFRIGERANT PUMP DOWN



## Improving safety and the environment

Panasonic has developed an innovative solution to detect refrigerant leaks that offer complete assurance and protection for end users, building occupiers and the environment. Panasonic's Pump Down System is ideal for hotels, offices and public buildings where safety for occupants and the building owners is of utmost importance.

The system monitors refrigerant leakage continually and provides a warning before refrigerant leaks, preventing major refrigerant loss and potentially damaging the system's efficiency. The new system can improve potential refrigerant loss to approximately 90%.

As well as ensuring safe and reliable operation, Panasonic's Pump Down System contributes to a building qualifying for additional BREEAM points and enables compliance with current EN378 2008 standards, covering applications where refrigeration concentration levels exceed practical safety limits of 0,44 kg/m<sup>3</sup>.

Panasonic has developed two detection methods that can operate simultaneously to offer complete protection for owners, building occupiers and the environment.

## Pump Down system

**This innovative pump down system can be connected in two ways:**

- With sensor leakage
- Without sensor leakage, using only an innovative algorithm

### Basic pump down function:

- Detect the leakage
- Activate pump down process
- Collect the gas in the tank
- Close the valves to isolate the gas

### Key points:

- Comply with legislation
- Protect personnel
- Protect the environment
- Save on operating costs

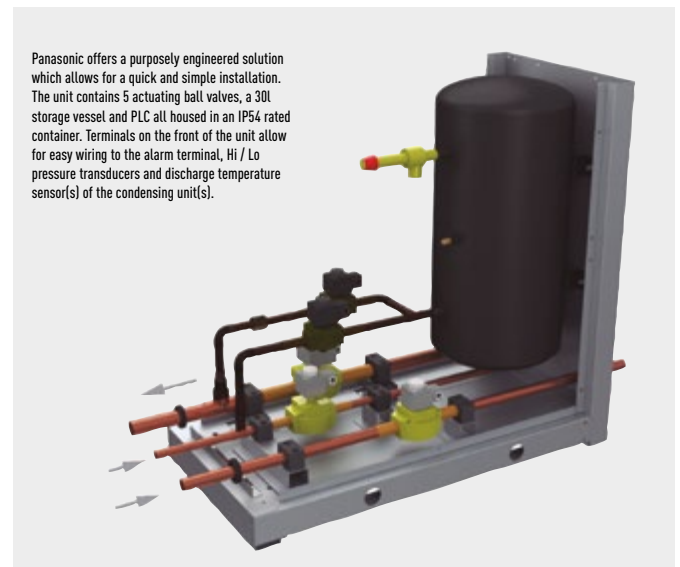

## R22 Renewal

Panasonic's advanced technology enables the system to work with previously installed pipe work by managing the working pressure within the system down to R22 (33 bar) levels, this ensures the system works safely and efficiently without loss of capacity. The new equipment can offer increased COP/EER by using state of the art inverter compressor and heat exchanger technology. Having contacted your Panasonic supplier regarding pipe work restrictions and gained approval to use the Panasonic Renewal System there are three

main tests that have to be carried out to ensure that the system can be used effectively. Firstly a thorough inspection of the pipe work must be carried out and any damage must be repaired. Secondly an oil test has to be carried out to ensure that the system has not been subject to a compressor burnout during its lifetime. Lastly a VRF Renewal Kit (CZ-SLK2) has to be installed within the pipe work to ensure that the system is cleaned of any remnants of oil.





# DESIGN SUPPORT SOFTWARE FOR VRF



Features the unique Mounting Scheme function providing more thorough spec-in and tender quotation support for easier, faster completion of work



**The Panasonic VRF Designer software can be used for all Panasonic VRF ME2, LE1 and MF2.**

Panasonic has identified the importance of ever-increasing demands for fast and accurate responses to customer requests in our industry. More and more emphasis is being placed upon energy-efficiency in our marketplace. The ability to calculate cooling/heating loads and produce information of actual design conditions is a major advantage to any architect, consultant, contractor or end user.

Panasonic understands the time-poor and demanding industry we are in and we are pleased to announce the launch of the next generation of our system design software program.

The Panasonic VRF Designer software has been customised to make the selection and design process as quick and easy as possible.

The design package utilises system wizards and import tools to enable both simple and complex systems to be created. In addition, the system will allow outdoor and indoor units to be dragged on an interactive desktop. This allows users to create everything from realistic floor plans with detailed piping and wiring schematics to send out with quotations, through to installation guidance drawings.

#### Features include:

- Mounting scheme. Design selection from building floor drawing
- Any kind of drawing format. (dxf, jpg, png..etc.)
- Conventional principal scheme
- Easy to use system wizards
- Auto piping and wiring features
- Converted duties for conditions and pipework
- Auto(CAD) (dxf), Excel and PDF export
- Detailed wiring and pipework diagrams
- Automatic price quotation
- Automatic tender document assist
- SEER, SCOP
- ESEER

**Panasonic's Advanced VRF software with AutoCAD® compatibility makes design easier than ever**

Panasonic provides bespoke software helping system designers, installers and dealers to very quickly design and size systems, create wiring diagrams and issue bills of quantities at the push of a button.



#### Panasonic VRF Service Checker

Panasonic will make available to installers and commissioning companies the VRF Service Checker as a communication interface to Panasonic VRF systems. This easy to manage tool checks all parameters of the system.

#### The VRF Service Checker allows:

- On ECOi and Mini ECOi connect anywhere on the P-Link
- Search the P-Link to validate systems that are connected
- Monitor all indoor and outdoor units simultaneously on 1 screen
- Monitor all Temperature data, Pressure data, Valve position, and alarm status on 1 screen
- Data can be viewed in Graph or number format
- Controlling the indoor unit ON/OFF, MODE, SET POINT, FAN, and TEST mode
- Switching between various systems on same communication P-Link (ECOi only)
- Monitor and record at a set interval time
- Record and review the data at a later date
- Update software as ROM flash writer

This Panasonic VRF Service Checker is available from your service partner.



Interface Box

# NEW VRF SYSTEMS INDOOR UNITS















# ECOi AND ECO G SYSTEMS INDOOR UNITS RANGE

	1,5kW	2,2kW	2,8kW	3,0kW	3,6kW	4,0kW	4,5kW
<b>NEW U2 Type. 4 Way 90x90 Cassette</b>							
<b>U1 Type. 4 Way 90x90 Cassette</b>							
<b>Y2 TYPE. 4 Way 60x60 Cassette</b>							
<b>L1 Type. 2 Way Cassette</b>							
<b>D1 Type. 1 Way Cassette</b>							
<b>F2 Type. Variable Static Pressure Hide Away</b>							
<b>M1 Type. Slim Variable Static Pressure Hide Away</b>							
<b>E2 Type. High Static Pressure Hide Away</b>							
<b>Heat Recovery with DX Coil</b>							
<b>T2 Type. Ceiling</b>							
<b>K2/K1 Type. Wall Mounted</b>							
<b>P1 Type. Floor Standing</b>							
<b>R1 Type. Concealed Floor Standing</b>							
<b>Hydrokit for ECOi, water at 45°C</b>							
Wide choice of models depending on the indoor requirements.							
	<b>16,0kW</b>	<b>28,0kW</b>	<b>56,0kW</b>	<b>84,0kW</b>	<b>112,0kW</b>	<b>140,0kW</b>	<b>168,0kW</b>
<b>AHU Connection Kit 16, 28 and 56kW</b>							
	PAW-160MAH2	PAW-280MAH2	PAW-560MAH2	PAW-280MAH2 + PAW-560MAH2	PAW-560MAH2 x 2	PAW-280MAH2 + PAW-560MAH2 x 2	PAW-560MAH2 x 3



5,6kW	6,0kW	7,3kW	9,0kW	10,6kW	14,0kW	16,0kW	22,4kW	28,0kW
 S-56MU2E5A	 S-60MU2E5A	 S-73MU2E5A	 S-90MU2E5A	 S-106MU2E5A	 S-140MU2E5A	 S-160MU2E5A		
 S-56MU1E5A	 S-60MU1E5A	 S-73MU1E5A	 S-90MU1E5A	 S-106MU1E5A	 S-140MU1E5A	 S-160MU1E5A		
 S-56MY2E5A								
 S-56ML1E5		 S-73ML1E5						
 S-56MD1E5		 S-73MD1E5						
 S-56MF2E5A	 S-60MF2E5A	 S-73MF2E5A	 S-90MF2E5A	 S-106MF2E5A	 S-140MF2E5A	 S-160MF2E5A		
 S-56MM1E5A								
							 S-224MEZE5	 S-280MEZE5
 S-56MT2E5A		 S-73MT2E5A		 S-106MT2E5A	 S-140MT2E5A			
 S-56MK1E5A		 S-73MK1E5A		 S-106MK1E5A				
 S-56MP1E5		 S-71MP1E5						
 S-56MR1E5		 S-71MR1E5						
			 S-80MW1E5		 S-125MW1E5			

	11,4kW	25,0kW	31,5kW	37,5kW
<b>Air Curtain Jet-Flow with DX Coil</b>	 PAW-10EAIRC-MJ	 PAW-15EAIRC-MJ	 PAW-20EAIRC-MJ	 PAW-25EAIRC-MJ
<b>Air Curtain Standard with DX Coil</b>	 PAW-10EAIRC-MS		 PAW-20EAIRC-MS	

# U2 TYPE 4 WAY 90x90 CASSETTE SEMI CONCEALED

Large capacity VRF. Trusted power and high efficiency. These cassettes offer upgraded Econavi and nanoe™ purification system as accessories for making application space more comfortable, healthy and efficient.

Thanks to advances in design and technology such as the new high performance turbo fan, more efficient and silent, the nanoe™ air cleaner, for total healthy and the floor temperature & humidity sensor to more control, the new U2 Panasonic 4 Way 90x90 Cassette is the best Industry in energy savings, healthy and comfort.

## Always fresh and clean air with nanoe™

New nanoe™ is available by the advanced technology of room air conditioning.

- Purificating operation can work simultaneously or independently from heating/cooling operation.
- Inhibiting viruses, bacteria & deodorisation (bacteria, fungus, pollen, virus and cigarette smoke). OH radicals in nanoe™ pull bacteria's hydrogen out and it is effectively deodorised be sterilised
- Clean inside by nanoe™ + Dry control: inside of indoor unit can be cleaned by short operation circuit with nanoe™ and drying

CZ-RTC5A and optional accessory CZ-CNEXU1 are required to use nanoe™ function.

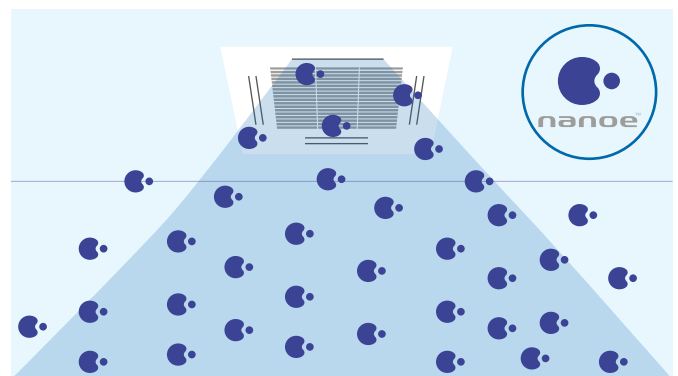

## Econavi intelligent sensor

Human activity sensor and floor temperature sensor can reduce energy by optimising air conditioner operation.



### Advanced Econavi functions.

2 sensors (movement and floor temperature) can find waste of energy and control effectively. Floor temperature can detect up to 5m ceiling height.

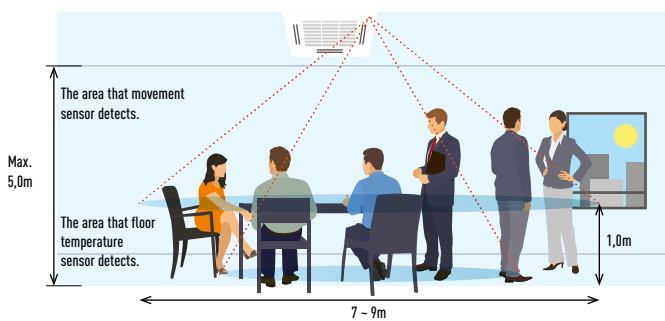

**Econavi exclusive panel. Optional (CZ-KPU3A)**

**Floor temperature sensor.**  
This sensor detects average floor temperature and operates circulation if floor is low temperature.

**Movement sensor.**  
This sensor detects the amount of human activity, and operates effectively.

Wired remote controller CZ-RTC5A is required.

### Humidity sensor.

New humidity sensor has added on air suction part, and realises comfort and energy saving based on temperature and humidity.

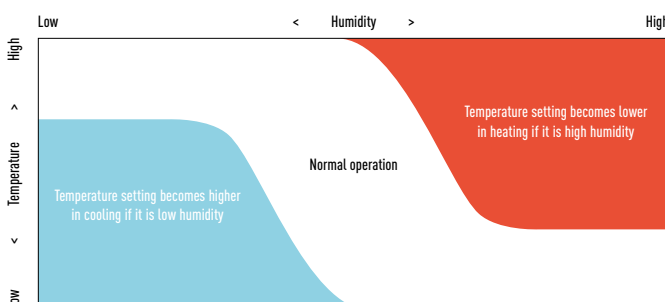

### Group control, circulation function.

Circulating operation is activated when nobody is there, and mix air in the whole room. Minimize temperature gap in both heating and cooling operation.

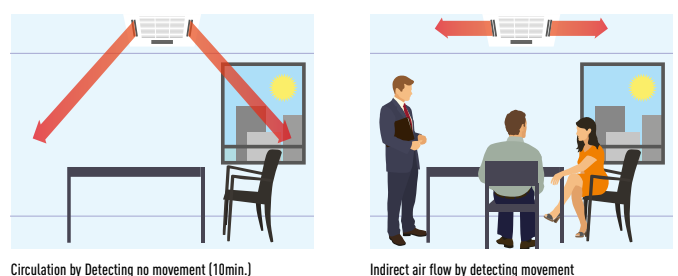



The new U2 Panasonic 4 Way 90x90 Cassettes with new panel design and 2 types of body with height difference.

2 types of body with height difference (same as current ones)

25,6cm and 31,9cm.

Technical focus

- New high performance turbo fan, new path system for heat exchanger
- Lower noise in slow fan operation
- Ceiling height up to 5,0m
- Industry top light weight, easy piping
- Econavi: Floor temperature and humidity sensor added. Activity amount detection and new circulator
- Nanoe™: The first 10x for CAC (10 times more purification power). Inside cleaning by 10x nanoe™ + dry control
- Powerful drain pump gives 850mm lift
- Fresh air knockout
- Branch duct connection
- Optional air-intake plenum CZ-FDU2

Panasonic introduces new flat panel design which is modern and matching well with your space. These cassettes have developed to satisfy today's customer needs such as highest energy saving, maximum comfort and healthier air.

The drain pipe can be raised to a maximum height of 850mm from the bottom of the ceiling

Do not attempt to raise it higher than 850mm. Doing so will result in water leakage.

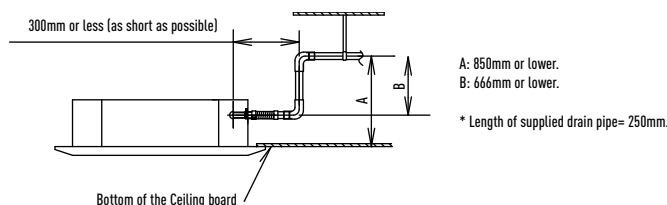

New Panel design

Flat design, well-matched with interior, building. Position of 4 air wings can be set individually.



Model		S-22MU2E5A	S-28MU2E5A	S-36MU2E5A	S-45MU2E5A	S-56MU2E5A	S-60MU2E5A	S-73MU2E5A	S-90MU2E5A	S-106MU2E5A	S-140MU2E5A	S-160MU2E5A
Power source		Single Phase / 220 / 230 / 240V / 50 Hz — 220 / 230V / 60Hz										
Cooling capacity	kW	2,2	2,8	3,6	4,5	5,6	6,0	7,3	9,0	10,6	14,0	16,0
Input power cooling	W	20	20	20	20	25	35	40	40	95	100	115
Operating current cooling	A	0,19	0,19	0,19	0,19	0,22	0,31	0,33	0,36	0,71	0,76	0,89
Heating capacity	kW	2,5	3,2	4,2	5,0	6,3	7,1	8,0	10,0	11,4	16,0	18,0
Input power heating	W	20	20	20	20	25	35	40	40	85	100	105
Operating current heating	A	0,17	0,17	0,17	0,17	0,20	0,30	0,32	0,34	0,65	0,73	0,80
Fan type		Turbo fan	Turbo fan	Turbo fan	Turbo fan	Turbo fan	Turbo fan	Turbo fan	Turbo fan	Turbo fan	Turbo fan	Turbo fan
Air volume	Hi / Med / Lo	m³/min	14,5 / 13,0 / 11,5	14,5 / 13,0 / 11,5	14,5 / 13,0 / 11,5	15,5 / 13,0 / 11,5	17,0 / 13,5 / 11,5	21,0 / 16,0 / 13,0	22,5 / 16,0 / 13,0	23,0 / 18,5 / 14,0	35,0 / 26,0 / 20,0	36,0 / 27,0 / 21,5
Sound pressure	Hi / Med / Lo	dB(A)	30 / 29 / 28	30 / 29 / 28	30 / 29 / 28	31 / 29 / 28	33 / 30 / 28	36 / 32 / 29	37 / 32 / 29	38 / 35 / 32	44 / 38 / 34	45 / 39 / 35
Sound power	Hi / Med / Lo	dB	45 / 44 / 43	45 / 44 / 43	45 / 44 / 43	46 / 44 / 43	48 / 45 / 43	51 / 47 / 44	52 / 47 / 44	53 / 50 / 47	59 / 53 / 49	60 / 54 / 50
Dimensions (H x W x D)	Indoor	mm	256 x 840 x 840	256 x 840 x 840	256 x 840 x 840	256 x 840 x 840	256 x 840 x 840	256 x 840 x 840	256 x 840 x 840	256 x 840 x 840	319 x 840 x 840	319 x 840 x 840
	Panel	mm	33,5 x 950 x 950	33,5 x 950 x 950	33,5 x 950 x 950	33,5 x 950 x 950	33,5 x 950 x 950	33,5 x 950 x 950	33,5 x 950 x 950	33,5 x 950 x 950	33,5 x 950 x 950	33,5 x 950 x 950
Net weight (Panel)		kg	21	21	21	21	21	21	21	25	25	25
Pipe connections	Liquid	Inch (mm)	1/4 (6,35)	1/4 (6,35)	1/4 (6,35)	1/4 (6,35)	1/4 (6,35)	3/8 (9,52)	3/8 (9,52)	3/8 (9,52)	3/8 (9,52)	3/8 (9,52)
	Gas	Inch (mm)	1/2 (12,7)	1/2 (12,7)	1/2 (12,7)	1/2 (12,7)	1/2 (12,7)	5/8 (15,88)	5/8 (15,88)	5/8 (15,88)	5/8 (15,88)	5/8 (15,88)
	Drain piping		VP-25	VP-25	VP-25	VP-25	VP-25	VP-25	VP-25	VP-25	VP-25	VP-25

Rating Conditions: Cooling Indoor 27°C DB / 19°C WB. Cooling Outdoor 35°C DB / 24°C WB. Heating Indoor 20°C DB. Heating Outdoor 7°C DB / 6°C WB. DB: Dry Bulb; WB: Wet Bulb. \* Sound pressure with no refrigerant flow.



# U1 TYPE 4 WAY 90x90 CASSETTE SEMI CONCEALED



The award winning range of U1 type cassettes are smaller, shallower and lighter than previous models and feature a 950 x 950mm panel throughout. The DC-Fan motor and air discharge louvre ensure quiet, optimum air distribution.

### Technical focus

- Compact design
- Reduced sound levels (from previous models)
- DC-Fan motor for increased efficiency
- Powerful drain pump gives 850mm lift
- Lightweight design
- Fresh air knockout
- Branch duct connection
- Optional air-intake plenum CZ-FDU2

### Air intake chamber

1. Air intake box CZ-BCU2 for main unit.
2. Air intake box CZ-ATU2\* for Air intake plenum. CZ-CFU2 Part to close airflow for the cassette 90x90 series U1.



\* When using Air intake box (CZ-ATU2), Air intake plenum (CZ-FDU2) is required.

### Lighter and Slimmer, Easier Installation

A lightweight unit at 24kg, the unit is also very slim with a height of only 256mm, making installation possible even in narrow ceiling voids.

### A drain height of approximately 850mm from the ceiling surface

The drain height can be increased by approximately 350mm over the conventional value by using a high-lift drain pump, and long horizontal piping is possible.

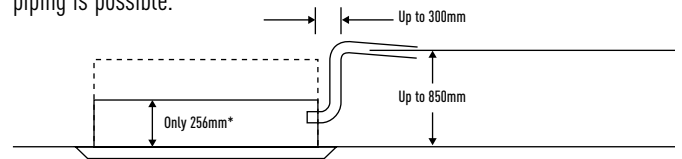

\* For 6.0kW / 7.1kW.

### Air flow directed to avoid ceiling marks

The condensation and dirt appearing near the discharge ports for conventional ceiling cassettes has been reduced.

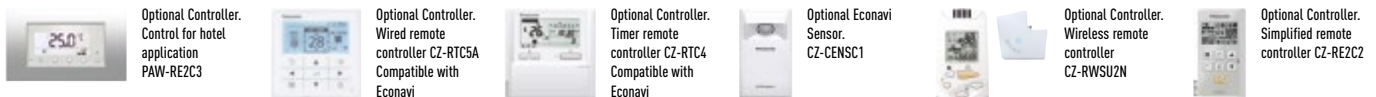
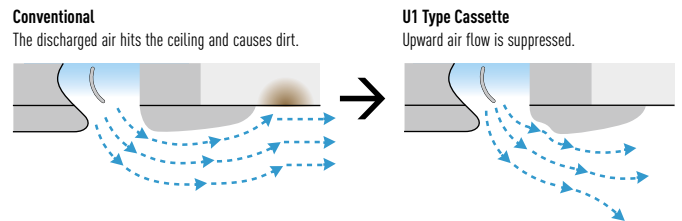

Model		S-22MU1E5A	S-28MU1E5A	S-36MU1E5A	S-45MU1E5A	S-56MU1E5A	S-60MU1E5A	S-73MU1E5A	S-90MU1E5A	S-106MU1E5A	S-140MU1E5A	S-160MU1E5A
Power source		230 V / Single Phase / 50 Hz										
Cooling capacity	kW	2.2	2.8	3.6	4.5	5.6	6.0	7.3	9.0	10.6	14.0	16.0
Input power cooling	W	20	20	20	20	25	35	40	40	95	100	115
Operating current cooling	A	0.19	0.19	0.19	0.19	0.22	0.31	0.33	0.36	0.71	0.76	0.89
Heating capacity	kW	2.5	3.2	4.2	5.0	6.3	7.1	8.0	10.0	11.4	16.0	18.0
Input power heating	W	20	20	20	20	25	35	40	40	85	100	105
Operating current heating	A	0.17	0.17	0.17	0.17	0.20	0.30	0.32	0.34	0.65	0.73	0.80
Fan type		Turbo fan	Turbo fan	Turbo fan	Turbo fan	Turbo fan	Turbo fan	Turbo fan	Turbo fan	Turbo fan	Turbo fan	Turbo fan
Air volume	Hi / Med / Lo	m <sup>3</sup> /min 14.0 / 12.0 / 11.0	14.0 / 12.0 / 11.0	14.0 / 12.0 / 11.0	15.0 / 13.0 / 12.0	16.0 / 13.5 / 12.0	21.0 / 17.0 / 14.0	22.0 / 17.0 / 14.0	23.0 / 19.0 / 15.0	33.0 / 27.0 / 21.0	35.0 / 28.0 / 22.0	36.0 / 29.0 / 23.0
Sound pressure	Hi / Med / Lo	dB(A) 30 / 29 / 28	30 / 29 / 28	30 / 29 / 28	31 / 29 / 28	33 / 30 / 28	36 / 32 / 29	37 / 32 / 29	38 / 35 / 32	44 / 38 / 34	45 / 39 / 35	46 / 40 / 38
Dimensions (H x W x D)	Indoor	mm 256 x 840 x 840	256 x 840 x 840	256 x 840 x 840	256 x 840 x 840	256 x 840 x 840	256 x 840 x 840	256 x 840 x 840	256 x 840 x 840	319 x 840 x 840	319 x 840 x 840	319 x 840 x 840
	Panel	mm 33.5 x 950 x 950	33.5 x 950 x 950	33.5 x 950 x 950	33.5 x 950 x 950	33.5 x 950 x 950	33.5 x 950 x 950	33.5 x 950 x 950	33.5 x 950 x 950	33.5 x 950 x 950	33.5 x 950 x 950	33.5 x 950 x 950
Net weight (Panel)		kg 23 (4)	23 (4)	23 (4)	23 (4)	23 (4)	24 (4)	24 (4)	24 (4)	27 (4)	27 (4)	27 (4)
	Liquid	Inch (mm) 1/4 (6.35)	1/4 (6.35)	1/4 (6.35)	1/4 (6.35)	1/4 (6.35)	3/8 (9.52)	3/8 (9.52)	3/8 (9.52)	3/8 (9.52)	3/8 (9.52)	3/8 (9.52)
Pipe connections	Gas	Inch (mm) 1/2 (12.70)	1/2 (12.70)	1/2 (12.70)	1/2 (12.70)	1/2 (12.70)	5/8 (15.88)	5/8 (15.88)	5/8 (15.88)	5/8 (15.88)	5/8 (15.88)	5/8 (15.88)
	Drain piping	VP-25	VP-25	VP-25	VP-25	VP-25	VP-25	VP-25	VP-25	VP-25	VP-25	VP-25

Rating Conditions: Cooling Indoor 27°C DB / 19°C WB. Cooling Outdoor 35°C DB / 24°C WB. Heating Indoor 20°C DB. Heating Outdoor 7°C DB / 6°C WB. DB: Dry Bulb; WB: Wet Bulb.



ECONAVI and INTERNET CONTROL: Optional.



# Y2 TYPE 4 WAY 60x60 CASSETTE MINI SEMI CONCEALED



Designed to fit exactly into a 600 x 600mm ceiling grid without the need to alter the bar configuration, the Y2 is ideal for small commercial and retrofit applications. In addition, the improvements to efficiency make this one of the most advanced units in the industry.

### Technical focus

- Mini cassette fits into a 600 x 600mm ceiling grid
- Fresh air knock out
- Multidirectional airflow
- Powerful drain pump gives 850mm lift
- Turbo fans and heat exchanger fins with improved design
- DC-Fan motors with variable speed, new heat exchangers, etc. ensure an efficient power consumption

### Special designed flap

The flap can be removed easily for washing with water.

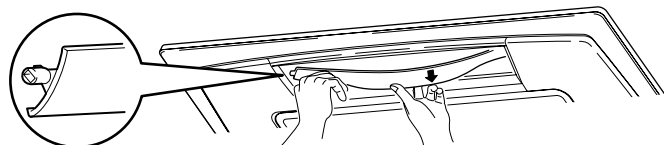

### A drain height of approximately 850mm from the ceiling surface

The drain height can be increased by approximately 350mm over the conventional value by using a high-lift drain pump, and long horizontal piping is possible.

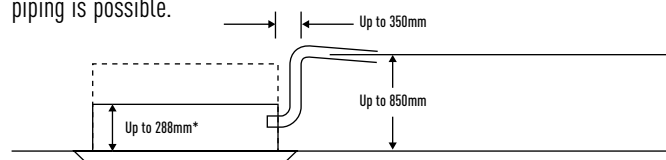

A lightweight unit at 18,4kg the unit is also very slim with a height of only 288mm, making installation possible even in narrow ceilings.

### Anti-Mould Long-Life Air Filter

Anti-mould and anti-bacteria washable filter ensures clean, healthy air.



Optional Controller. Control for hotel application PAW-REZC3



Optional Controller. Wired remote controller CZ-RTC5A Compatible with Econavi



Optional Controller. Timer remote controller CZ-RTC4 Compatible with Econavi



Optional Econavi Sensor. CZ-CENSC1



Optional Controller. Wireless remote controller CZ-RWSK2



Optional Controller. Simplified remote controller CZ-REZC2

Model		S-15MY2E5A	S-22MY2E5A	S-28MY2E5A	S-36MY2E5A	S-45MY2E5A	S-56MY2E5A	
Power source		230 V / Single Phase / 50 Hz						
Cooling capacity	kW	1,5	2,2	2,8	3,6	4,5	5,6	
Input power cooling	W	35	35	35	40	40	45	
Operating current cooling	A	0,30	0,30	0,30	0,30	0,32	0,35	
Heating capacity	kW	1,7	2,5	3,2	4,2	5,0	6,3	
Input power heating	W	30	30	30	35	35	40	
Operating current heating	A	0,25	0,25	0,30	0,30	0,30	0,30	
Fan type		Centrifugal fan						
Air volume	Cooling	m³/min	8,9 / 8,2 / 5,6	9,1 / 8,2 / 5,6	9,3 / 8,4 / 5,6	9,7 / 8,7 / 6,0	10,0 / 9,3 / 8,2	10,4 / 9,8 / 8,5
	Heating	m³/min	9,1 / 8,4 / 5,6	9,3 / 8,4 / 5,6	9,6 / 8,7 / 5,6	9,9 / 9,1 / 6,0	10,3 / 9,6 / 8,2	11,1 / 9,8 / 8,7
Sound pressure	Hi / Med / Lo	dB(A)	34 / 31 / 25	35 / 31 / 25	35 / 31 / 25	36 / 32 / 26	38 / 34 / 28	40 / 37 / 34
Sound power	Hi / Med / Lo	dB	49 / 46 / 40	50 / 46 / 40	50 / 46 / 40	51 / 47 / 41	53 / 49 / 43	55 / 52 / 49
Dimensions	Indoor	mm	288 x 583 x 583	288 x 583 x 583	288 x 583 x 583	288 x 583 x 583	288 x 583 x 583	288 x 583 x 583
	Panel (3A)	mm	31 x 700 x 700	31 x 700 x 700	31 x 700 x 700	31 x 700 x 700	31 x 700 x 700	31 x 700 x 700
	Panel (3B)	mm	31 x 625 x 625	31 x 625 x 625	31 x 625 x 625	31 x 625 x 625	31 x 625 x 625	31 x 625 x 625
Net weight (Panel)		kg	18 (2,4)	18 (2,4)	18 (2,4)	18 (2,4)	18 (2,4)	18 (2,4)
	Liquid	Inch (mm)	1/4 (6,35)	1/4 (6,35)	1/4 (6,35)	1/4 (6,35)	1/4 (6,35)	1/4 (6,35)
Pipe connections	Gas	Inch (mm)	1/2 (12,70)	1/2 (12,70)	1/2 (12,70)	1/2 (12,70)	1/2 (12,70)	1/2 (12,70)
	Drain piping		VP-25	VP-25	VP-25	VP-25	VP-25	VP-25

Rating Conditions: Cooling Indoor 27°C DB / 19°C WB. Cooling Outdoor 35°C DB / 24°C WB. Heating Indoor 20°C DB. Heating Outdoor 7°C DB / 6°C WB. DB: Dry Bulb; WB: Wet Bulb.



ECONAVI and INTERNET CONTROL: Optional.



# L1 TYPE 2 WAY CASSETTE



Slim, compact and lightweight units. Remarkable size and weight reductions have been achieved by improvement of the design around the fan, the weight of all models now being 30kg.

### Technical focus

- Airflow and distribution is automatically altered depending on the operational mode of the unit
- Drain up is possible up to 500mm from the drain port
- Simple maintenance

### Simple maintenance

The drain pan is equipped with site wiring and can be removed. The fan case has a split construction, and the fan motor can be removed easily when the lower case is removed.

### Auto flap control

Airflow and distribution is automatically altered depending on the operational mode of the unit.

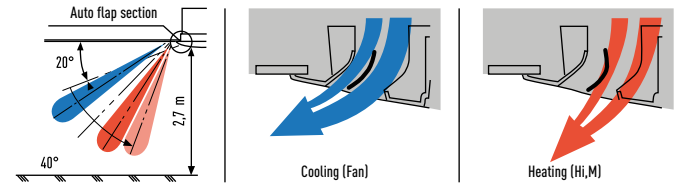

### Drain up is possible up to 500mm from the drain port

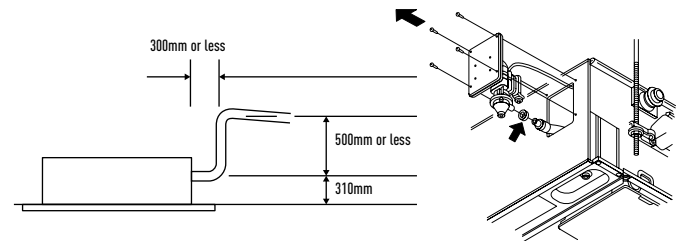

Maintenance of the drain pump is possible from two sides, from the left side (piping side) and from the inside of the unit.



Optional Controller. Control for hotel application PAW-RE2C3



Optional Controller. Wired remote controller CZ-RTCSA Compatible with Econavi



Optional Controller. Timer remote controller CZ-RTC4 Compatible with Econavi



Optional Econavi Sensor. CZ-CENSC1



Optional Controller. Wireless remote controller CZ-RWSL2N



Optional Controller. Simplified remote controller CZ-RE2C2

Model		S-22ML1E5	S-28ML1E5	S-36ML1E5	S-45ML1E5	S-56ML1E5	S-73ML1E5	
Power source		230 V / Single Phase / 50 Hz						
Cooling capacity	kW	2,2	2,8	3,6	4,5	5,6	7,3	
Input power cooling	W	90	92	93	97	97	145	
Operating current cooling	A	0,45	0,45	0,45	0,45	0,45	0,65	
Heating capacity	kW	2,5	3,2	4,2	5,0	6,3	8,0	
Input power heating	W	58	60	61	65	65	109	
Operating current heating	A	0,29	0,29	0,29	0,29	0,29	0,48	
Fan type		Sirocco fan						
Air volume	Hi / Med / Lo	m <sup>3</sup> /min	8,0 / 7,0 / 6,0	9,0 / 8,0 / 7,0	9,7 / 8,7 / 7,7	11,0 / 9,0 / 8,0	11,0 / 9,0 / 8,0	19,0 / 16,0 / 14,0
Sound pressure	Hi / Med / Lo	dB(A)	30 / 27 / 24	33 / 29 / 26	34 / 31 / 28	35 / 33 / 29	35 / 33 / 29	38 / 35 / 33
Dimensions (H x W x D)	Indoor	mm	350 x 840 x 600					
	Panel	mm	8 x 1.060 x 680					
Net weight (Panel)		kg	23 (5,5)	23 (5,5)	23 (5,5)	23 (5,5)	30 (9)	
Pipe connections	Liquid	Inch (mm)	1/4 (6,35)					
	Gas	Inch (mm)	1/2 (12,70)					
	Drain piping		VP-25					

Rating Conditions: Cooling Indoor 27°C DB / 19°C WB. Cooling Outdoor 35°C DB / 24°C WB. Heating Indoor 20°C DB. Heating Outdoor 7°C DB / 6°C WB. DB: Dry Bulb; WB: Wet Bulb.



ECONAVI and INTERNET CONTROL: Optional.



Panel CZ-02KPL2 CZ-03KPL2 (for S-73ML1E5)

# D1 TYPE 1 WAY CASSETTE



Designed for installation within the ceiling void, the D1 range of slimline 1 way blow cassettes feature powerful yet quiet fans for up to 4,2m.

### Technical focus

- Ultra-Slim
- Suitable for standard and high ceilings
- Built-in drain pump provides 590mm lift
- Easy to install and maintain
- Hanging height can be easily adjusted
- Uses a DC-Fan motor to improve energy-efficiency

### Drain height

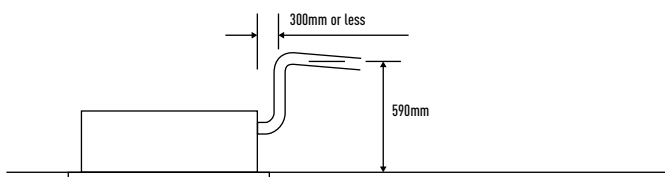

With 3 types of air-blow systems, the units can be used in various ways



**1. One-direction “down-blow” system.**  
Powerful one-direction “down-blow” system reaches the floor even from high ceilings (up to 4,2m).



**2. Two-direction ceiling-mounted system.**  
“Down-blow” and “front-blow” systems are combined in a ceiling-mounted unit to blow air over a wide area.



**3. One-direction ceiling-mounted system.**  
This powerful ceiling-mounted “front-blow” system efficiently air-conditions the space in front of the unit. (Additional accessories required)



Optional Controller. Control for hotel application PAW-RE2C3



Optional Controller. Wired remote controller CZ-RTC5A Compatible with Econavi



Optional Controller. Timer remote controller CZ-RTC4 Compatible with Econavi



Optional Econavi Sensor. CZ-CENS1



Optional Controller. Wireless remote controller CZ-RWSD2



Optional Controller. Simplified remote controller CZ-RE2C2

Model		S-28MD1E5	S-36MD1E5	S-45MD1E5	S-56MD1E5	S-73MD1E5
Power source		230 V / Single Phase / 50 Hz				
Cooling capacity	kW	2,8	3,6	4,5	5,6	7,3
Input power cooling	W	51	51	51	60	87
Operating current cooling	A	0,39	0,39	0,39	0,46	0,70
Heating capacity	kW	3,2	4,2	5,0	6,3	8,0
Input power heating	W	40	40	40	48	76
Operating current heating	A	0,35	0,35	0,35	0,41	0,65
Fan type		Sirocco fan		Sirocco fan	Sirocco fan	Sirocco fan
Air volume	Hi / Med / Lo	m <sup>3</sup> /min 12,0 / 10,0 / 9,0		12,0 / 11,0 / 10,0	13,0 / 11,5 / 10,0	18,0 / 15,0 / 13,0
Sound pressure	Hi / Med / Lo	dB(A) 36 / 34 / 33		36 / 35 / 34	38 / 36 / 34	45 / 40 / 36
Dimensions (H x W x D)	Indoor	mm 200 x 1.000 x 710				
	Panel	mm 20 x 1.230 x 800				
Net weight (Panel)		kg 21 (5,5)		21 (5,5)	21 (5,5)	22 (5,5)
Pipe connections	Liquid	Inch (mm) 1/4 (6,35)				
	Gas	Inch (mm) 1/2 (12,70)				
Drain piping		VP-25				

Rating Conditions: Cooling Indoor 27°C DB / 19°C WB. Cooling Outdoor 35°C DB / 24°C WB. Heating Indoor 20°C DB. Heating Outdoor 7°C DB / 6°C WB. DB: Dry Bulb; WB: Wet Bulb.



ECONAVI and INTERNET CONTROL: Optional.



Panel CZ-KP2D

# F2 TYPE VARIABLE STATIC PRESSURE HIDE AWAY



The new F2 type is designed specifically for applications requiring fixed square ducting. The internal filter is equipped as standard.

### Technical focus

- Industry-leading low sound levels from 25dB(A)
- Built-in drain pump provides 785mm lift
- Easy to install and maintain
- Air OFF sensor avoids cold air dumping
- Configurable air temperature control

### More powerful drain pump

Using a high-lift drain pump, drain piping can be elevated up to 785mm from the base of the unit.

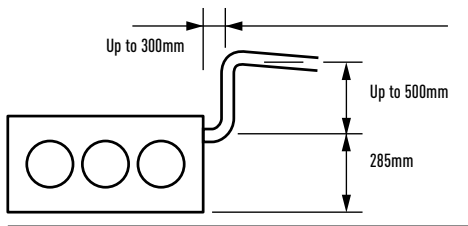

### F2 Advantages

Automatic learning function for the required static pressure, to be activated easily by the standard wired timer remote controller. Possible to increase the sensible cooling capacity by adjusting the air volume flow in order to almost completely eliminate latent losses. This is possible due to the outstanding big heat exchanger surface in combination with increasing the air volume flow by a manual selection of higher fan speed curves through the standard wired remote controller when commissioning the system together with the default active off-coil temperature control and the room load based variable evaporation temperature control.

### Diagram 1 S-22MF2E5A

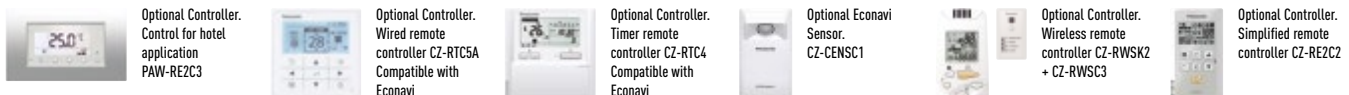
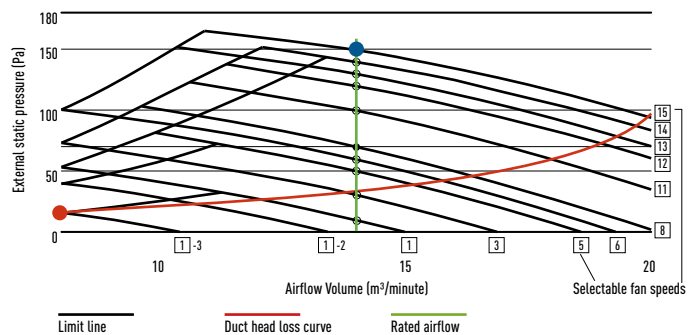

Model	S-15MF2E5A	S-22MF2E5A	S-28MF2E5A	S-36MF2E5A	S-45MF2E5A	S-56MF2E5A	S-60MF2E5A	S-73MF2E5A	S-90MF2E5A	S-106MF2E5A	S-140MF2E5A	S-160MF2E5A		
Power source	230 V / Single Phase / 50 Hz													
Cooling capacity	kW	1,5	2,2	2,8	3,6	4,5	5,6	6,0	7,3	9,0	10,6	14,0	16,0	
Input power cooling	W	70	70	70	70	70	100	120	120	135	195	215	225	
Operating current cooling	A	0,57	0,57	0,57	0,57	0,57	0,74	0,89	0,89	0,97	1,30	1,44	1,50	
Heating capacity	kW	1,7	2,5	3,2	4,2	5,0	6,3	7,1	8,0	10,0	11,4	16,0	18,0	
Input power heating	W	70	70	70	70	70	100	100	120	120	135	200	225	
Operating current heating	A	0,57	0,57	0,57	0,57	0,57	0,74	0,89	0,89	0,97	1,34	1,42	1,50	
Fan type		Sirocco fan	Sirocco fan	Sirocco fan	Sirocco fan	Sirocco fan	Sirocco fan	Sirocco fan	Sirocco fan	Sirocco fan	Sirocco fan	Sirocco fan	Sirocco fan	
Air volume <sup>1)</sup>	Hi / Med / Lo	m³/min	14,0 / 13,0 / 9,0	14,0 / 13,0 / 9,0	14,0 / 13,0 / 9,0	14,0 / 13,0 / 9,0	14,0 / 13,0 / 10,0	16,0 / 15,0 / 12,0	21,0 / 19,0 / 15,0	21,0 / 19,0 / 15,0	25,0 / 23,0 / 19,0	32,0 / 26,0 / 21,0	34,0 / 29,0 / 23,0	36,0 / 32,0 / 25,0
External static pressure		Pa	70 (10-150)	70 (10-150)	70 (10-150)	70 (10-150)	70 (10-150)	70 (10-150)	70 (10-150)	70 (10-150)	100 (10-150)	100 (10-150)	100 (10-150)	
Sound pressure <sup>2)</sup>	Hi / Med / Lo	dB(A)	33 / 29 / 22	33 / 29 / 22	33 / 29 / 22	33 / 29 / 22	34 / 32 / 25	34 / 32 / 25	35 / 32 / 26	35 / 32 / 26	37 / 34 / 28	38 / 34 / 31	39 / 35 / 32	40 / 36 / 33
Sound power <sup>2)</sup>	Hi / Med / Lo	dB	55 / 51 / 44	55 / 51 / 44	55 / 51 / 44	55 / 51 / 44	56 / 54 / 47	56 / 54 / 47	57 / 54 / 48	57 / 54 / 48	59 / 56 / 50	60 / 56 / 53	61 / 57 / 54	62 / 58 / 55
Dimensions	H x W x D	mm	290 x 800 x 700	290 x 800 x 700	290 x 800 x 700	290 x 800 x 700	290 x 800 x 700	290 x 800 x 700	290 x 1.000 x 700	290 x 1.000 x 700	290 x 1.400 x 700	290 x 1.400 x 700	290 x 1.400 x 700	
Net weight		kg	29	29	29	29	29	29	34	34	46	46	46	
Pipe connections	Liquid	Inch (mm)	1/4 (6,35)	1/4 (6,35)	1/4 (6,35)	1/4 (6,35)	1/4 (6,35)	1/4 (6,35)	3/8 (9,52)	3/8 (9,52)	3/8 (9,52)	3/8 (9,52)	3/8 (9,52)	
	Gas	Inch (mm)	1/2 (12,70)	1/2 (12,70)	1/2 (12,70)	1/2 (12,70)	1/2 (12,70)	1/2 (12,70)	5/8 (15,88)	5/8 (15,88)	5/8 (15,88)	5/8 (15,88)	5/8 (15,88)	
	Drain piping		VP-25	VP-25	VP-25	VP-25	VP-25	VP-25	VP-25	VP-25	VP-25	VP-25	VP-25	

Rating Conditions: Cooling Indoor 27°C DB / 19°C WB. Cooling Outdoor 35°C DB / 24°C WB. Heating Indoor 20°C DB. Heating Outdoor 7°C DB / 6°C WB. DB: Dry Bulb; WB: Wet Bulb.

1) ) Value referred to standard settings at shipment (H curve 8, M curve 5, L curve 1). 2) Sound pressure without refrigerant flow.



ECONAVI and INTERNET CONTROL: Optional.



# M1 TYPE SLIM VARIABLE STATIC PRESSURE HIDE AWAY CONCEALED DUCT



The ultra slim M1 type is one of the leading products of its type in the industry. With a depth of only 200mm it provides greater flexibility and can be used in far more applications. In addition, its high-efficiency and extremely quiet sound levels make it very popular with many users, including hotels and small offices.

### Ultra-slim profile for all models

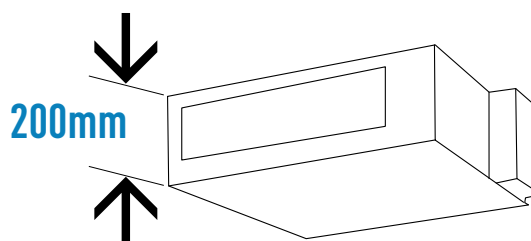

### Technical focus

- Ultra-slim profile: 200mm for all models
- DC-Fan motor greatly reduces power consumption
- Ideal for hotel application with very narrow false ceilings
- Easy maintenance and service by external electrical box
- 40Pa static pressure enables ductwork to be fitted.
- Includes drain pump

### Drain pump with increased power!

By adoption of a high-lift drain pump, the drain piping rise height can be increased to 785mm from the lower surface of the body.

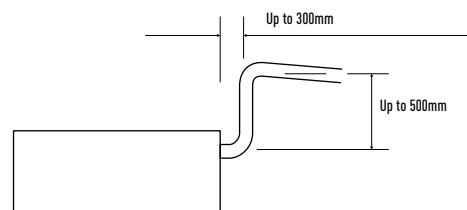

### Air Outlet & Inlet Plenum

S-...MM1E5A	Diameters	Air Outlet Plenum	Diameters	Air Inlet Plenum
22, 28 & 36	2 x Ø200	CZ-DUMPA22MMS2	2 x Ø200	CZ-DUMPA22MMR2
45 & 56	3 x Ø160	CZ-DUMPA45MMS3	2 x Ø200	CZ-DUMPA22MMR3



Optional Controller. Control for hotel application PAW-RE2C3



Optional Controller. Wired remote controller CZ-RTC5A Compatible with Econavi



Optional Controller. Timer remote controller CZ-RTC4 Compatible with Econavi



Optional Econavi Sensor. CZ-CENSC1



Optional Controller. Wireless remote controller CZ-RWSC2 + CZ-RWSC3



Optional Controller. Simplified remote controller CZ-RE2C2

Model		S-15MM1E5A	S-22MM1E5A	S-28MM1E5A	S-36MM1E5A	S-45MM1E5A	S-56MM1E5A
Power source		230 V / Single Phase / 50 Hz					
Cooling capacity	kW	1,5	2,2	2,8	3,6	4,5	5,6
Input power cooling	W	36	36	40	42	49	64
Operating current cooling	A	0,26	0,26	0,30	0,31	0,37	0,48
Heating capacity	kW	1,7	2,5	3,2	4,2	5,0	6,3
Input power heating	W	26	26	30	32	39	54
Operating current heating	A	0,23	0,23	0,27	0,28	0,34	0,45
Fan type		Sirocco fan		Sirocco fan	Sirocco fan	Sirocco fan	Sirocco fan
Air volume	Hi / Med / Lo	8,0 / 7,0 / 6,0		8,5 / 7,5 / 6,5	9,0 / 8,0 / 7,0	10,5 / 9,5 / 8,0	12,5 / 11,5 / 10,0
External static pressure	Pa	10 (30)		15 (30)	15 (40)	15 (40)	15 (40)
Sound pressure	Hi / Med / Lo <sup>1</sup>	28 / 27 / 25 (30 / 29 / 27)		30 / 29 / 27 (32 / 31 / 29)	32 / 30 / 28 (34 / 32 / 30)	34 / 32 / 30 (36 / 34 / 32)	35 / 33 / 31 (37 / 35 / 32)
Sound power	Hi / Med / Lo	43 / 42 / 40		45 / 44 / 42	47 / 45 / 43	49 / 47 / 45	50 / 48 / 46
Dimensions	H x W x D	200 x 750 x 640		200 x 750 x 640	200 x 750 x 640	200 x 750 x 640	200 x 750 x 640
Net weight	kg	19		19	19	19	19
Pipe connections	Liquid	1/4 (6,35)		1/4 (6,35)	1/4 (6,35)	1/4 (6,35)	1/4 (6,35)
	Gas	1/2 (12,70)		1/2 (12,70)	1/2 (12,70)	1/2 (12,70)	1/2 (12,70)
	Drain piping	VP-20		VP-20	VP-20	VP-20	VP-20

Rating Conditions: Cooling Indoor 27°C DB / 19°C WB. Cooling Outdoor 35°C DB / 24°C WB. Heating Indoor 20°C DB. Heating Outdoor 7°C DB / 6°C WB. DB: Dry Bulb; WB: Wet Bulb.

1) With booster cable using short circuit connection.



ECONAVI and INTERNET CONTROL: Optional.

# E2 TYPE HIGH STATIC PRESSURE HIDE AWAY



2 products in 1: High pressure duct and 100% Fresh air duct function. The E2 range of ducted units offers improved design flexibility for extended duct layouts as a result of their increased external static pressures and reduces energy consumption.

### Technical focus

- No need of rap valve
- 100% Fresh air duct function
- DC-Fan motor for more savings
- Complete flexibility for ductwork design
- Can be located into a weatherproof housing for external sitting
- Air OFF sensor avoids cold air dumping
- Configurable air temperature control

### System example

An inspection port (450 x 450mm or more) is required at the lower side of the indoor unit body (field supply).

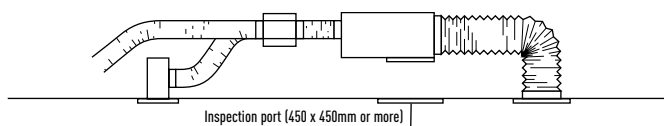

### 100% Fresh air duct function

The New E2 duct with 100% fresh air duct function have exceptional discharge temperature.

	Discharge Range		
	Min	Max	Default
Cooling	15°C	24°C	18°C
Heating	17°C	45°C	40°C

### Plenums

#### Air Outlet Plenum (suitable for rigid + flexible duct)

	Number of exits with diameters	Model
S-224ME1E5A / S-280ME1E5	1 x 500mm	CZ-TREMIESPW706

### Kit for 100% Fresh air function

For 2-Pipe systems		For 3-Pipe systems	
2x CZ-P160RVK2	Rap valve kit	2x CZ-P160HR3	3-Pipe valve kit
2x CZ-CAPE2	3-Pipe control PCB	2x CZ-CAPE2	3-Pipe control PCB
CZ-P680BK2	Distribution Joint kit	CZ-P680BH2	Distribution Joint kit
1x Remote control		1x Remote control	

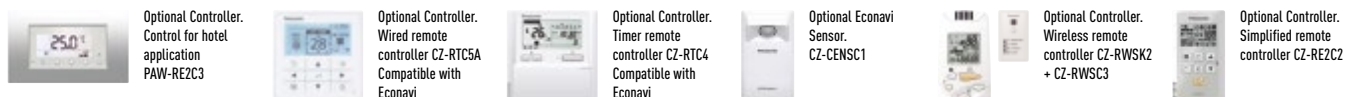

Model	100% Fresh air duct function (by using Kit for 100% Fresh air)				High pressure duct				
	S-224ME2E5		S-280ME2E5		S-224ME2E5		S-280ME2E5		
Power source	230 V / Single Phase / 50 Hz		230 V / Single Phase / 50 Hz		230 V / Single Phase / 50 Hz		230 V / Single Phase / 50 Hz		
Cooling capacity	kW	22,4	28,0	22,4	28,0				
Input power cooling	W	290	350	440	715				
Operating current cooling	A	1,85	2,20	2,45	3,95				
Heating capacity	kW	21,2	26,5	25,0	31,5				
Input power heating	W	290	350	440	715				
Operating current heating	A	1,85	2,20	2,45	3,95				
Fan type	Sirocco DC Fan Motor				Sirocco DC Fan Motor				
Air volume	Hi / Med / Lo	m <sup>3</sup> /min		28,3 / - / -		35,0 / - / -		56,0 / 51,0 / 44,0	
External static pressure	Pa		200		140 (60 / 270) <sup>1)</sup>		140 (72 / 270) <sup>1)</sup>		
Sound pressure <sup>2)</sup>	Hi / Med / Lo	dB(A)		43 / - / -		44 / - / -		45 / 43 / 41	
Sound power	Hi / Med / Lo	dB		75 / - / -		76 / - / -		77 / 75 / 73	
Dimensions	H x W x D	mm		479 x 1.453 x 1.205		479 x 1.453 x 1.205		479 x 1.453 x 1.205	
Net weight	kg		102		106		106		
Pipe connections	Liquid	Inch (mm)		3/8 (9,52)		3/8 (9,52)		3/8 (9,52)	
	Gas	Inch (mm)		3/4 (19,05)		3/4 (19,05)		3/4 (19,05)	
	Drain piping	VP-25		VP-25		VP-25		VP-25	

Rating Conditions: Cooling Indoor 27°C DB / 19°C WB. Cooling Outdoor 35°C DB / 24°C WB. Heating Indoor 20°C DB. Heating Outdoor 7°C DB / 6°C WB.  
Rating Conditions for 100% Fresh air duct function: Cooling Outdoor 33°C DB / 28°C WB. Heating Outdoor 0°C DB / -2,9°C WB. DB: Dry Bulb; WB: Wet Bulb.

1) Available to select the setting by initial setup. 2) Values with 140Pa setting.



ECONAVI and INTERNET CONTROL: Optional.

# HEAT RECOVERY WITH DX COIL



Motorised heat recovery by-pass device automatically controlled by unit control to use fresh air free-cooling when convenient.

- Galvanized steel self-supporting panels, internally and externally insulated
- Counterflow air-to-air heat recovery device, made of sheets of special paper with special sealing to keep airflows separate and only permeable to water vapour. Total heat exchange with temperature efficiency up to 77% and enthalpy efficiency up to 63%, also at high level during summer season
- G4 efficiency class filters with synthetic cleanable media, both on fresh air and return air intake
- Removable side panel to access filters and heat recovery in the event of scheduled maintenance
- Low consumption, high efficiency & low noise direct driven fans with 3-speed EC motors
- Supply section complete with DX Coil (R410A) fitted with solenoid control valve, freon filter, contact temperature sensors on liquid and gas line, NTC sensors upstream and downstream airflow
- Built-in electric box equipped with PCB to control internal fan speed and to interconnect outdoor/indoor units
- Duct connection by circular plastic collars
- CZ-RTC4 Timer remote controller (option)

## Balanced Ventilation

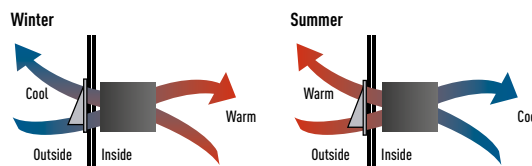

## Interconnection to outdoor/indoor units

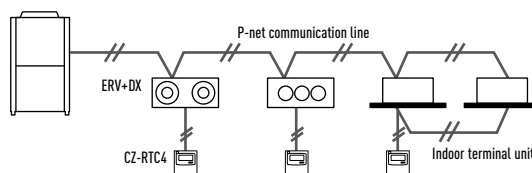

## Characteristic curves

The following curves show the unit external static pressure at maximum fan speed for each model.

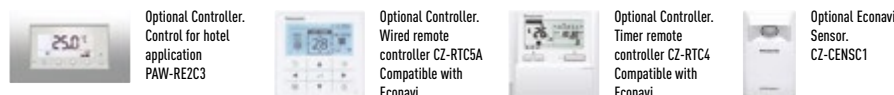
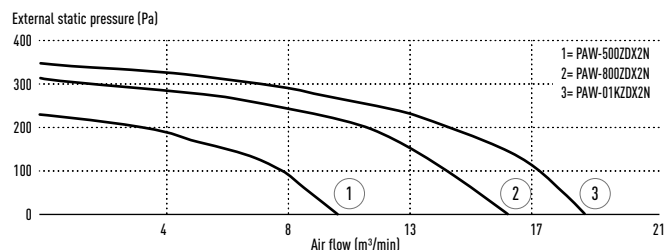

Model		PAW-500ZDX2N	PAW-800ZDX2N	PAW-01KZDX2N
Power source		230 V / Single Phase / 50 Hz	230 V / Single Phase / 50 Hz	230 V / Single Phase / 50 Hz
Air volume	Hi / Med / Lo	8,3 / 8,3 / 6,0	13,3 / 11,7 / 10,0	16,7 / 13,0 / 10,8
External static pressure <sup>1</sup>	Hi / Med / Lo	135 / 95 / 50	115 / 45 / 25	100 / 70 / 35
Maximum current	A	2,0	2,8	3,0
Maximum Input power	W	135	300	310
Sound pressure <sup>2</sup>	Hi / Med / Lo	33 / 31 / 27	38 / 36 / 32	39 / 37 / 33
Pipe connections	Liquid / Gas	1/4 (6,35) / 1/2 (12,70)	1/4 (6,35) / 1/2 (12,70)	1/4 (6,35) / 1/2 (12,70)
<b>Heat Recovery</b>				
Temperature / Enthalpy efficiency summer mode	%	62,5 / 60,0	59,0 / 57,0	59,5 / 57,5
Saved power summer mode	kW	1,7	2,5	3,2
Temperature / Enthalpy efficiency winter mode	%	76,5 (76,5) / 62,3 (64,1)	73,0 (73,0) / 59,0 (60,8)	73,5 (73,5) / 59,5 (61,2)
Saved power winter mode	kW	4,3 (4,8)	6,5 (7,3)	8,2 (9,0)
<b>DX Coil</b>				
Total / Sensible cooling capacity	kW	3,0 / 2,0	4,0 / 2,8	4,5 / 3,3
Off temperature	Cooling	16,5	17,9	18,6
Off relative humidity	Cooling	86	82	81
Total heating capacity	kW	2,9 (3,1)	4,0 (4,3)	4,6 (5,0)
Off temperature	Heating	30,1 (29,2)	27,5 (26,5)	26,3 (25,3)
Off relative humidity	Heating	16 (15)	18 (17)	19 (18)

Nominal summer conditions: Outside air: 32°C DB, RH 50%. Ambient air: 26°C DB, RH 50%. Nominal winter conditions: Outside air: -5°C (-10°C) DB, RH 80%. Ambient air: 20°C DB, RH 50%. Cooling mode air inlet condition: 28.5°C DB, RH 50%; evaporating temp. 4°C. Heating mode air inlet condition: 13°C DB, RH 40% (11°C DB, RH 45%); condensating temperature 49°C. DB: Dry Bulb; RH: Relative Humidity.  
 1) Referred to the nominal airflow after filter and plate heat exchanger. 2) Referred to 1,5m from inlet in free field condition.



ECONAVI and INTERNET CONTROL: Optional.

# T2 TYPE CEILING



The T2 TYPE ceiling mounted units feature a DC-Fan motor for increased efficiency and reduced operating sound levels. All the units are the same height and depth for a uniform appearance in mixed installations and feature a fresh air knockout for improved air quality.

## Further comfort improvement with airflow distribution

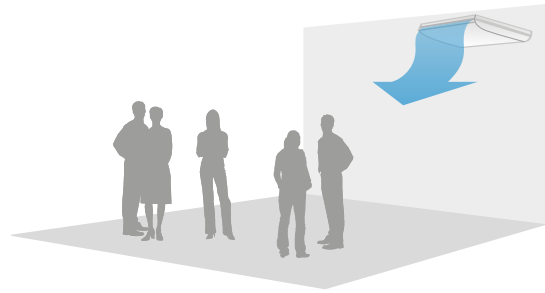

### Technical focus

- Low sound levels
- New design, all units just 235mm high
- Large and wide air distribution
- Easy to install and maintain
- Fresh air knockout

## Air distribution is automatically altered depending on the operational mode

### Further comfort improvement

The wide air discharge opening widens the airflow to the left and the right, so that a comfortable temperature is obtained in the entire room. The unpleasant feeling caused when the airflow directly hits the human body is prevented by the "Draft prevention position", which changes the swing width, so that the degree of comfort is increased.

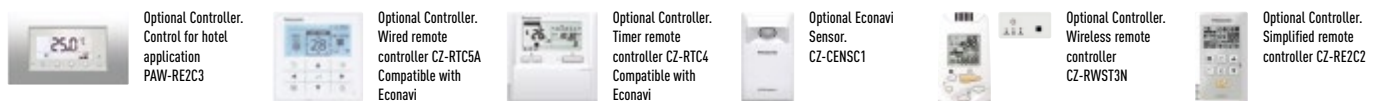
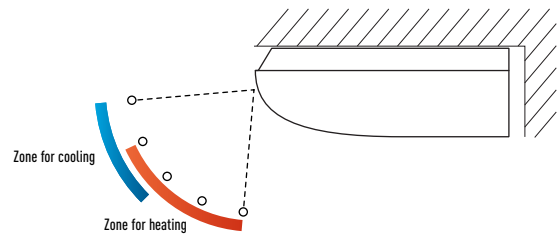
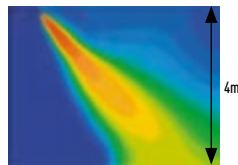

Model		S-36MT2E5A	S-45MT2E5A	S-56MT2E5A	S-73MT2E5A	S-106MT2E5A	S-140MT2E5A
Power source		230 V / Single Phase / 50 Hz					
Cooling capacity	kW	3,6	4,5	5,6	7,3	10,6	14,0
Input power cooling	W	35	40	40	55	80	100
Operating current cooling	A	0,36	0,38	0,38	0,44	0,67	0,79
Heating capacity	kW	4,2	5,0	6,3	8,0	11,4	16,0
Input power heating	W	35	40	40	55	80	100
Operating current heating	A	0,36	0,38	0,38	0,44	0,67	0,79
Fan type		Sirocco fan		Sirocco fan		Sirocco fan	
Air volume	Hi / Med / Lo	m <sup>3</sup> /min	14,0 / 12,0 / 10,5	15,0 / 12,5 / 10,5	15,0 / 12,5 / 10,5	21,0 / 18,0 / 15,5	30,0 / 25,0 / 23,0
Sound pressure	Hi / Med / Lo	dB(A)	36 / 32 / 30	37 / 33 / 30	37 / 33 / 30	39 / 35 / 33	42 / 37 / 36
Sound power	Hi / Med / Lo	dB	54 / 50 / 48	55 / 51 / 48	55 / 51 / 48	57 / 53 / 51	60 / 55 / 54
Dimensions	H x W x D	mm	235 x 960 x 690	235 x 960 x 690	235 x 960 x 690	235 x 1.275 x 690	235 x 1.590 x 690
Net weight		kg	27	27	27	33	40
Pipe connections	Liquid	Inch (mm)	1/4 (6,35)	1/4 (6,35)	1/4 (6,35)	3/8 (9,52)	3/8 (9,52)
	Gas	Inch (mm)	1/2 (12,70)	1/2 (12,70)	1/2 (12,70)	5/8 (15,88)	5/8 (15,88)
	Drain piping		VP-20	VP-20	VP-20	VP-20	VP-20

Rating Conditions: Cooling Indoor 27°C DB / 19°C WB. Cooling Outdoor 35°C DB / 24°C WB. Heating Indoor 20°C DB. Heating Outdoor 7°C DB / 6°C WB. DB: Dry Bulb; WB: Wet Bulb.



ECONAVI and INTERNET CONTROL: Optional.



# K2/K1 TYPE WALL MOUNTED



The K2/K1 Type wall mounted unit has a stylish smooth panel which not only looks good but is also easy to clean. The unit is also smaller, lighter and substantially quieter than previous models making it ideal for small offices and other commercial applications.

### Technical focus

- Closed discharge port
- Lighter and smaller units make the installation easy
- Quiet operation
- Smooth and durable design
- Piping outlet in three directions
- Washable front panel
- Air distribution is automatically altered depending on the operational mode

### Closed discharge port

When the unit is turned OFF, the flap closes completely to prevent entry of dust into the unit and to keep the equipment clean.

Lighter and smaller units make the installation easy. The width has been decreased by 17% and the units are lighter.

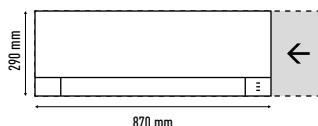

Air distribution is automatically altered depending on the operational mode of the unit

### Quiet operation

These units are among the quietest in the industry, making them ideal for hotels and hospitals.

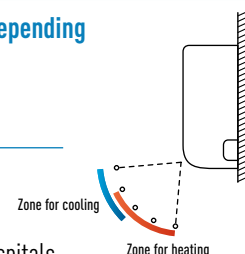

### Smooth and durable design

The smooth cover means these units match most modern interiors. Their compact size enables them to blend in, even in small spaces.

### Piping outlet in three directions

Piping outlet is possible in the three directions of rear, right, and left, making the installation work easier.

### External valve (Optional)

CZ-P56SVK2 (model sizes 15 to 56)  
CZ-P160SVK2 (model sizes 73 to 106)



Optional Controller. Control for hotel application PAW-RE2C3



Optional Controller. Wired remote controller CZ-RTCSA Compatible with Econavi



Optional Controller. Timer remote controller CZ-RTC4 Compatible with Econavi



Optional Econavi Sensor. CZ-CENSC1



Optional Controller. Wireless remote controller CZ-RWSK2



Optional Controller. Simplified remote controller CZ-REZC2

Model	S-15MK2E5A	S-22MK2E5A	S-28MK2E5	S-36MK2E5	S-45MK1E5A	S-56MK1E5A	S-73MK1E5A	S-106MK1E5A	
Power source	230 V / Single Phase / 50 Hz								
Cooling capacity	1,5	2,2	2,8	3,6	4,5	5,6	7,3	10,6	
Input power cooling	25	25	25	30	20	30	57	60	
Operating current cooling	0,20	0,21	0,23	0,25	0,26	0,35	0,58	0,62	
Heating capacity	1,7	2,5	3,2	4,2	5,0	6,3	8,0	11,4	
Input power heating	25	25	25	30	20	30	57	68	
Operating current heating	0,20	0,21	0,23	0,25	0,26	0,35	0,58	0,70	
Fan type	Cross flow		Cross flow		Cross flow		Cross flow		
Air volume	Hi / Med / Lo	m <sup>3</sup> /min	7,9 / 7,4 / 6,5	9,0 / 7,5 / 6,5	9,5 / 8,3 / 6,5	10,9 / 9,0 / 6,5	12,0 / 10,5 / 8,5	14,0 / 12,0 / 10,5	18,0 / 14,5 / 11,5
		m <sup>3</sup> /min	9,0 / 7,7 / 6,8	9,2 / 8,3 / 6,8	9,7 / 8,5 / 6,8	11,2 / 9,5 / 6,8	—	—	—
Sound pressure	Hi / Med / Lo	dB(A)	34 / 32 / 29	36 / 33 / 29	37 / 34 / 29	40 / 36 / 29	38 / 34 / 30	40 / 36 / 32	47 / 44 / 40
Sound power	Hi / Med / Lo	dB	49 / 47 / 44	51 / 48 / 44	52 / 49 / 44	55 / 51 / 44	—	—	—
Dimensions	H x W x D	mm	290 x 870 x 214	290 x 870 x 214	290 x 870 x 214	290 x 870 x 214	300 x 1.065 x 230	300 x 1.065 x 230	300 x 1.065 x 230
Net weight		kg	9	9	9	9	13	13	14,5
Pipe connections	Liquid	Inch (mm)	1/4 (6,35)	1/4 (6,35)	1/4 (6,35)	1/4 (6,35)	1/4 (6,35)	1/4 (6,35)	3/8 (9,52)
	Gas	Inch (mm)	1/2 (12,70)	1/2 (12,70)	1/2 (12,70)	1/2 (12,70)	1/2 (12,70)	1/2 (12,70)	5/8 (15,88)
	Drain piping (O.D.)		φ 16	φ 16	φ 16	φ 16	φ 18	φ 18	φ 18

Rating Conditions: Cooling Indoor 27°C DB / 19°C WB. Cooling Outdoor 35°C DB / 24°C WB. Heating Indoor 20°C DB. Heating Outdoor 7°C DB / 6°C WB. DB: Dry Bulb; WB: Wet Bulb.



ECONAVI and INTERNET CONTROL: Optional.

# P1 TYPE. FLOOR STANDING R1 TYPE. CONCEALED FLOOR STANDING



**P1 Type.** The compact floor standing P1 units are the ideal solution for providing perimeter air conditioning. The standard wired controller can be incorporated into the body of the unit.

**R1 Type.** At just 229mm deep, the R1 unit can be easily concealed in perimeter areas to provide powerful and effective air conditioning.

### Technical focus

- Pipes can be connected to either side of the unit from the bottom or rear
- Easy to install
- Front panel opens fully for easy maintenance
- Removable air discharge grille gives flexible airflow
- Room for condensate pump
- For build-in remote control, only CZ-RTC2 is suitable

### Technical focus

- Chassis unit for discreet installation
- Complete with removable filters
- Pipes can be connected to either side of the unit from the bottom or rear
- Easy to install

### Perimeter air conditioning with high interior quality

#### Effective perimeter handling

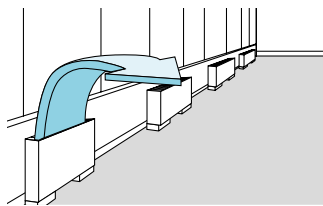

#### A remote control can be installed

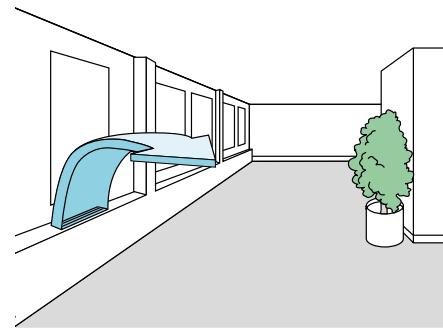

Optional Controller. Control for hotel application PAW-RE2C3



Optional Controller. Timer remote controller CZ-RTC2



Optional Controller. Wired remote controller CZ-RTC5A Compatible with Econavi



Optional Econavi Sensor. CZ-CENSC1



Optional Controller. Wireless remote controller CZ-RWSK2 + CZ-RWSC3



Optional Controller. Simplified remote controller CZ-RE2C2

Model P1 Type		S-22MP1E5	S-28MP1E5	S-36MP1E5	S-45MP1E5	S-56MP1E5	S-71MP1E5
Model R1 Type		S-22MR1E5	S-28MR1E5	S-36MR1E5	S-45MR1E5	S-56MR1E5	S-71MR1E5
230 V / Single Phase / 50 Hz							
Power source							
Cooling capacity	kW	2,2	2,8	3,6	4,5	5,6	7,1
Input power cooling	W	56	56	85	126	126	160
Operating current cooling	A	0,25	0,25	0,38	0,56	0,56	0,72
Heating capacity	kW	2,5	3,2	4,2	5,0	6,3	8,0
Input power heating	W	40	40	70	91	91	120
Operating current heating	A	0,18	0,18	0,31	0,41	0,41	0,54
Fan type		Sirocco fan		Sirocco fan	Sirocco fan	Sirocco fan	Sirocco fan
Air volume	Hi / Med / Lo m³/min	7,0 / 6,0 / 5,0	7,0 / 6,0 / 5,0	9,0 / 7,0 / 6,0	12,0 / 9,0 / 8,0	15,0 / 13,0 / 11,0	17,0 / 14,0 / 12,0
Sound pressure	Hi / Med / Lo dB(A)	33 / 30 / 28	33 / 30 / 28	39 / 35 / 29	38 / 35 / 31	39 / 36 / 31	41 / 38 / 35
Dimensions P1 Type	H x W x D mm	615 x 1.065 x 230	615 x 1.065 x 230	615 x 1.065 x 230	615 x 1.380 x 230	615 x 1.380 x 230	615 x 1.380 x 230
Net weight P1 Type	kg	29	29	29	39	39	39
Dimensions R1 Type	H x W x D mm	616 x 904 x 229	616 x 904 x 229	616 x 904 x 229	616 x 1.219 x 229	616 x 1.219 x 229	616 x 1.219 x 229
Net weight R1 Type	kg	21	21	21	28	28	28
Pipe connections	Liquid	Inch (mm)	1/4 (6,35)	1/4 (6,35)	1/4 (6,35)	1/4 (6,35)	3/8 (9,52)
	Gas	Inch (mm)	1/2 (12,70)	1/2 (12,70)	1/2 (12,70)	1/2 (12,70)	5/8 (15,88)
	Drain piping		VP-20	VP-20	VP-20	VP-20	VP-20

Rating Conditions: Cooling Indoor 27°C DB / 19°C WB. Cooling Outdoor 35°C DB / 24°C WB. Heating Indoor 20°C DB. Heating Outdoor 7°C DB / 6°C WB. DB: Dry Bulb; WB: Wet Bulb.



ECONAVI and INTERNET CONTROL: Optional.

# HYDROKIT FOR ECOi WATER AT 45°C



Connect the Hydrokit to your VRF system, together with other indoor units.

### Technical focus

- Only with 3-Pipe ECOi MF2 6N Series outdoor units
- Remote controller CZ-RTC5A common use with DX Coil indoor units ECOi and PACi

### Basic principle & advantage

Hydrokit module provides hot water by using waste heat that is recovered from standard air-conditioning indoor unit in cooling mode. Total system performs high energy efficiency by this heat recovering operation, and it gives an advantage for the environmental-friendly assessment scheme (ex. BREEAM in UK).

### Hydrokit control function / CZ-RTC5A

- CZ-RTC5A is updated version from CZ-RTC3. It can be used for hydrokit and also normal indoor unit. CZ-RTC5A checks the type of connected unit and switch hydrokit or air conditioner style of display automatically

- Operating mode on hydrokit style to be set at initial setting of the system from following modes: tank mode or air conditioning mode

### Overview: hydromodule in VRF system

- Multiple hydromodule connection in same circuit is available
- Each module can be set different operation mode either hot water supply mode or space heating mode (both operation modes are not able to set at 1 hydromodule)
- 3-Pipe control solenoid valve kit is necessary for each indoor unit and hydromodule

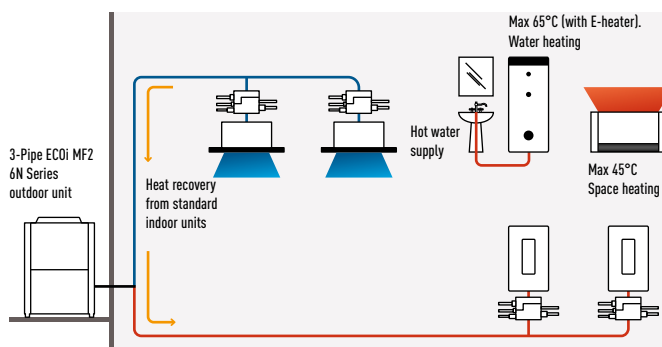

Optional Controller. Control for hotel application PAW-RE2C3



Optional Controller. Wired remote controller CZ-RTC5A Compatible with Econavi



Optional Econavi Sensor. CZ-CENS1

Model*				S-80MW1E5		S-125MW1E5	
Power source				230 V / Single Phase / 50 Hz		230 V / Single Phase / 50 Hz	
Cooling capacity		kW	8,0		12,5		
Heating capacity		kW	9,0		14,0		
Power input heating (hydrokit)		W	—		—		
Operating current heating (hydrokit)		A	—		—		
Maximum temperature		°C	-45 / -65 <sup>1</sup>		-45 / -65 <sup>1</sup>		
Dimensions		H x W x D	892 x 502 x 353		892 x 502 x 353		
Net weight		kg	—		—		
Water pipe connector		inch	R1 1/4		R1 1/4		
Water pump (built-in)			DC motor (A class)		DC motor (A class)		
Water flow rate		Cooling	l/min	22,9	35,8		
		Heating	l/min	25,8	40,1		
Sound pressure			dB(A)	—	—		
Pipe connections		Liquid	inch (mm)	3/8 (9,52)	3/8 (9,52)		
		Gas	inch (mm)	5/8 (15,88)	5/8 (15,88)		
Drain piping			mm (inner size)	15 - 17mm (inner size)	15 - 17mm (inner size)		
Operation range		Cooling Min ~ Max	Ambient / Water	°C	+10 ~ +43 / +5 ~ +20		
		Heating Min ~ Max	Ambient / Water	°C	-20 ~ +32 / +25 ~ +45		
Connectable system				3-Pipe (heat recovery type) VRF system (system capable up to 48HP)			
Maximum Indoor ratio (connectable hydrokit module capacity ratio)				Total indoor unit + Hydrokit capacity: up to 130 % (** - **% vs. total outdoor unit capacity)			

Rating Conditions: Cooling Indoor 27°C DB / 19°C WB. Cooling Outdoor 35°C DB / 24°C WB. Heating Indoor 20°C DB. Heating Outdoor 7°C DB / 6°C WB. DB: Dry Bulb; WB: Wet Bulb.  
 1) Max 45°C by refrigerant circuit (heat pump cycle), over 45°C is provided by electric heater operation. \* Tentative Data.



ECONAVI: Optional.

# AQUAREA AIR RADIATORS FAN COILS FOR HEAT PUMP APPLICATION

## New line up of Super low temperature radiators for Heat Pump application: Aquarea Air 200/700/900 with radiating effect

The slimline Panasonic Aquarea Air radiators deliver high efficiency climate control. With a depth of just under 13 cm they are at the cutting edge of the market. Blending easily into the home, Aquarea Air's elegant design and product refinements are clear to see in every detail. The Aquarea Air's slimline profile has been achieved thanks to the innovative layout of the ventilation unit and the heat exchanger. The fan is tangential with asymmetric blades and the large surface heat exchanger enables high airflows to be achieved with low pressure loss and low noise levels. Exceptional ventilation efficiency means the motor uses considerably less energy (low wattage). The fan speed is continuously modulated by the temperature controller with proportional integral logic, with undoubted advantages for regulating the temperature and humidity in summer mode.

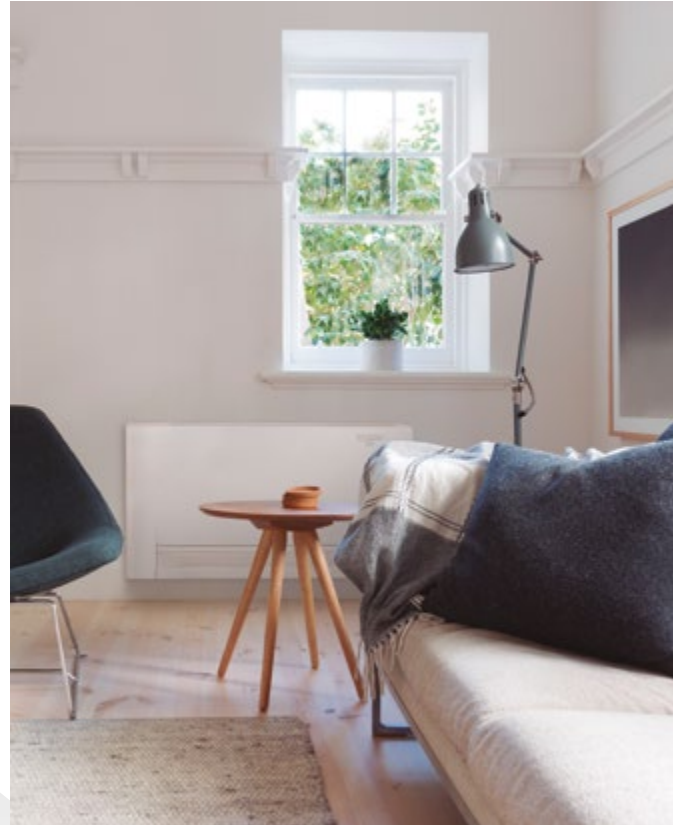

## Line up of super low temperature radiators for Heat Pump application

During winter, the operating principle is based on micro fans with very low power consumption and minimum noise, that send hot air coming from the heat exchanger, to the inside of the front panel of the device and therefore heat it effectively. With this principle, the terminal also provides significant power while heating, without running the main fan. Comfort temperatures are therefore maintained, without air movements and in silence. In summer mode, the airflow generated by the micro fans is stopped to avoid any dew formation on the terminal's front surface.

With standard cast radiators.

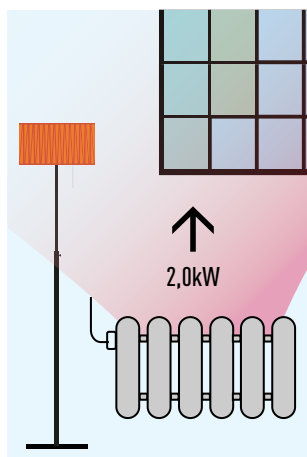

Water at 65°C needed.

With Aquarea Air.

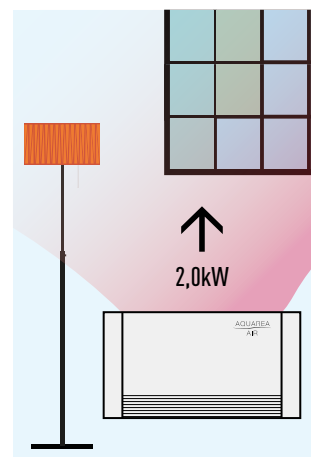

Water at 35°C needed.

### Technical focus:

- Front panel heating with radiant effect
- High heating capacity (without main fan running)
- 4 fan speeds and capacities
- Exclusive design
- Extremely compact (only 12,9 cm deep)
- Cooling and dehumidification functions possible (drain is needed)
- 3-way valve included (no overflow valve needed on the installation if more than 3 radiators installed)
- Touch screen thermostat

All temperature curves and capacity are available on [www.panasonicproclub.com](http://www.panasonicproclub.com)



# AQUAREA AIR

During winter, the operating principle is based on micro fans with very low power consumption and minimum noise, that send hot air coming from the heat exchanger, to the inside of the front panel of the device and therefore heat it effectively.

With this principle, the terminal also provides significant power while heating, without running the main fan. Comfort temperatures are therefore maintained, without air movements and in silence. In summer mode, the airflow generated by the micro fans is stopped to avoid any dew formation on the terminal's front surface.

### Technical focus

- Front panel heating with radiant effect
- High heating capacity (without main fan running)
- 4 fan speeds and capacities
- Exclusive design
- Extremely compact (only 12,9cm deep)
- Cooling and dehumidification functions possible (drain is needed)
- 3-way valve included (no overflow valve needed on the installation if more than 3 radiators installed)
- Touch screen thermostat

Operating on heating mode with radiator using only radiant effect.

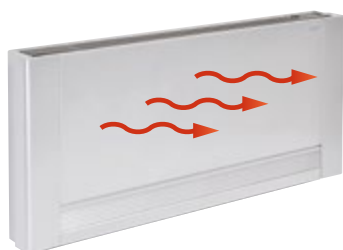

Operating on heating mode with radiant effect and fan mode.

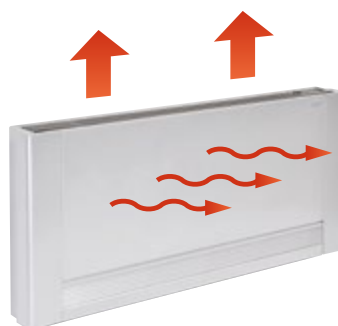

Operating on cooling mode with fan.



Fan Coils for Heat Pump application		PAW-AAIR-200-1					PAW-AAIR-700-1					PAW-AAIR-900-1				
Total heating capacity	W	138	160	217	470	570	223	360	708	1.032	1.188	273	475	886	1.420	1.703
Water flow	kg/h	23,7	27,5	37,3	80,8	98,0	38,4	61,9	121,8	177,5	204,3	47,0	81,7	152,4	244,2	292,9
Water pressure drop	kPa	0,1	0,2	0,4	2,0	2,9	0,1	0,1	0,3	0,8	1,0	0,1	0,2	0,5	1,6	2,2
Air flow	m³/min	0,5	0,6	0,9	1,9	2,7	0,7	1,4	2,6	4,2	5,3	0,9	1,8	4,1	6,1	7,7
	Speed	Main Fan Off	Super Min	Min	Med	Max	Main Fan Off	Super Min	Min	Med	Max	Main Fan Off	Super Min	Min	Med	Max
Maximum input power	W	2	5	7	9	13	3	9	14	18	22	3	11	16	20	24
Sound pressure	dB(A)	17,6	18,8	24,7	33,2	39,4	18,4	19,6	25,8	34,1	40,2	18,4	22,3	26,2	34,4	42,2
Inlet water temperature	°C	35	35	35	35	35	35	35	35	35	35	35	35	35	35	35
Outlet water temperature	°C	30	30	30	30	30	30	30	30	30	30	30	30	30	30	30
Inlet air temperature	°C	19	19	19	19	19	19	19	19	19	19	19	19	19	19	19
Outlet air temperature	°C	34,5	32,6	38,9	32,0	30,0	34,9	32,4	33,3	31,8	30,6	34,8	32,5	30,2	31,1	30,6
Dimensions (H x W x D)	mm	579 x 735 x 129					579 x 935 x 129					579 x 1.135 x 129				
Weight	kg	17					20					23				
3-ways valve included		Yes					Yes					Yes				
Touch screen thermostat		Yes					Yes					Yes				

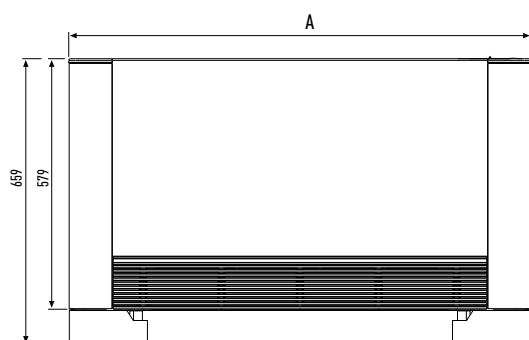

	200	700	900
A	735	935	1.135

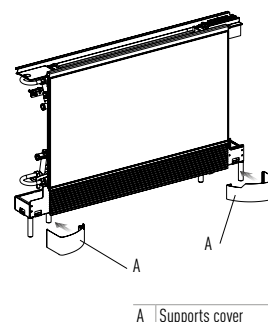

# PANASONIC VENTILATION SOLUTIONS



For maximum savings and easy integration.

### AHU connection kit 16kW, 28kW and 56kW

AHU connection kit contains: IP65 box with PCBs and terminal connections mounted inside, expansion valve and sensors.

Heat exchanger, fan & fan motor to be mounted in the AHU itself shall be provided in the field.

Application: Hotels, offices, server rooms or all large buildings where air quality control such as humidity control and fresh air and is needed.



### AHU Kit combine air conditioning and fresh air in just one solution.

New AHU Kits connect ECOi systems to air handling unit systems, using the same refrigerant circuit as the VRF system.

Large connectivity possibilities mean the Panasonic AHU Kit can be easily integrated.

### 3 types of AHU Kit: Deluxe, Medium and Light.

Model Code	IP 65	0-10V demand control*	Outdoor temperature shift compensation. Cold draft prevention
PAW-160MAH2 / PAW-280MAH2 / PAW-560MAH2	Yes	Yes	Yes
PAW-160MAH2M / PAW-280MAH2M / PAW-560MAH2M	Yes	Yes	No
PAW-160MAH2L / PAW-280MAH2L / PAW-560MAH2L	Yes	No	No

\* With CZ-CAPBC2.

### Heat Recovery With DX Coil

Motorised heat recovery by-pass device automatically controlled by unit control to use fresh air free-cooling when convenient.



- Galvanized steel self-supporting panels, internally and externally insulated
- Counterflow air-to-air heat recovery device, made of sheets of special paper with special sealing to keep airflows separate and only permeable to water vapour. Total heat exchange with temperature efficiency up to 77% and enthalpy efficiency up to 63%, also at high level during summer season
- G4 efficiency class filters with synthetic cleanable media, both on fresh air and return air intake
- Removable side panel to access filters and heat recovery in the event of scheduled maintenance
- Low consumption, high efficiency & low noise direct driven fans with 3-speed EC motors
- Supply section complete with DX Coil (R410A) fitted with solenoid control valve, freon filter, contact temperature sensors on liquid and gas line, NTC sensors upstream and downstream airflow
- Built-in electric box equipped with PCB to control internal fan speed and to interconnect outdoor/indoor units

### Air Curtain with DX Coil

#### Highly efficient heating effect.

The combined air stream, which has a desirable low air current induction factor (mixing factor), can carry the selected initial temperature effect over long distances, and will reach the floor area while still at room temperature. This is necessary to avoid cooling down the interior spaces.



The Panasonic range of air curtains is designed for smooth operation and efficient performance. Air curtains produce a continuous stream of air blown from the top to the bottom of an open doorway and create a barrier that people and products can flow across, but air can't. Designed to improve energy efficiency, minimise heat loss from a building, and to allow retailers to keep doors open to encourage customers, our Air Curtains are suitable for connection to both VRF and PACi Systems.

Heating capacity comparison: Electrical air curtain / Panasonic air curtain

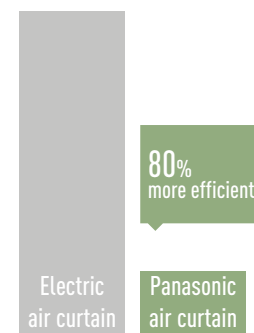

\* With the U-100PE1ESA on the PAW-20PAIRC-MS. Calculation method: Taking as consideration SCOP of the Panasonic combination of 6.0. If 100 is the energy needed for a air curtain, Panasonic Air curtain will need 1/(1-6)\*100=20.

### Energy Recovery Ventilation

Panasonic Energy Recovery Ventilators help you with your comfort and energy-saving plan.



Panasonic Energy Recovery Ventilators can reduce the outside air load because they efficiently recover the heat lost by ventilation during the heat recovery process. This results in energy-saving ventilation and lower running costs for air-conditioning and heating equipment. Furthermore, by designing our current models with a counter-flow heat-exchange element, we achieved products with slim body shapes and quiet operation that create a comfortable and pleasant air-conditioned environment while saving energy.

- Dramatic energy savings achieved through adoption of a high-efficiency counter-flow heat-exchange element
- Counter-flow heat exchange element used for reduced noise and slimmer, more compact body shape
- All maintenance can be performed through a single inspection hole
- Straight air supply / exhaust system used for easier installation

When a regular ventilation fan is used<sup>1</sup>      When a Energy Recovery Ventilator is used<sup>2</sup>

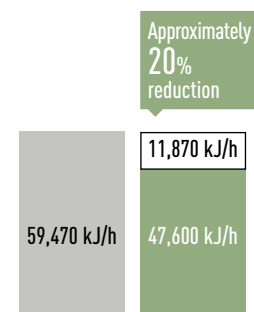

1) Two FY-27FPK7 units. 2) One FY-500ZD08 unit.

# AHU CONNECTION KIT 16, 28 AND 56kW FOR ECOi AND GHP



## Panasonic AHU Kit, 16-56kW connected to ECOi or ECO G

PCB, Transformer, Solenoid Control Valve, Thermistor x 4 pcs, Terminal Base and Electrical Component Box.

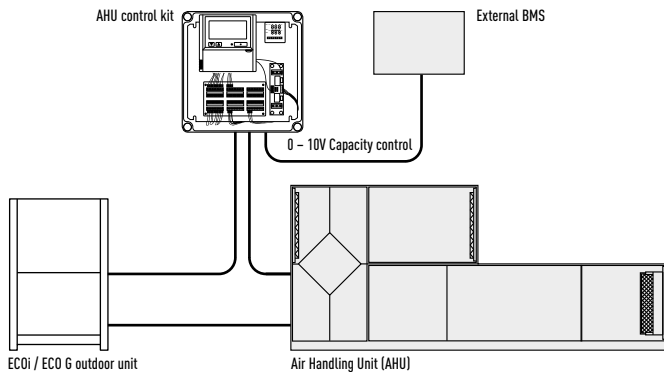

ECOi / ECO G outdoor unit

Air Handling Unit (AHU)

Demand control on the outdoor unit managed by external 0-10 V signal.

### System example for large capacity (more than 56kW)

3 x [PCB, Transformer, Solenoid Control Valve, Thermistor x 4 pcs, Terminal Base and Electrical Component Box].  
Example 140kW system

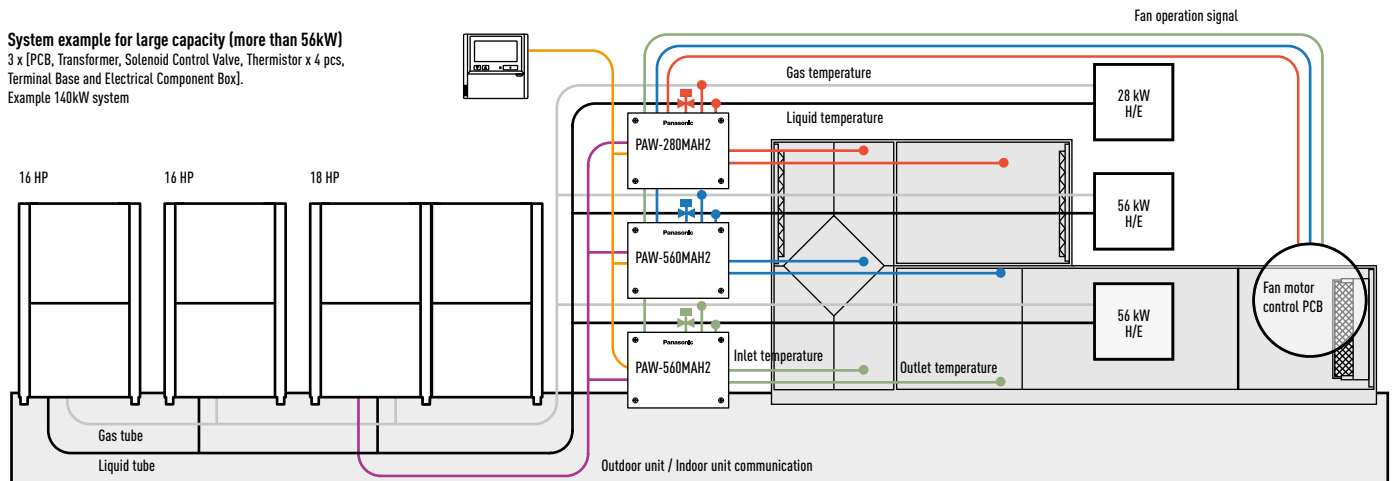

## Optional parts: Following functions are available by using different control accessories:

### CZ-RTC4 Timer remote controller.

- Operation-ON/OFF
- Mode select
- Temperature setting

\* Fan operation signal can be taken from the PCB.

### CZ-T10 terminal.

- Input signal= Operation ON/OFF
- Remote controller prohibition
- Output signal= Operating-ON status
- Alarm output (by DC12V)

### PAW-OCT, DC12 V outlet. OPTION terminal.

- Output signal= Cooling/Heating/Fan status
- Defrost
- Thermostat-ON

### CZ-CAPBC2 Mini seri-para I/O unit.

- Demand control 40% to 120% (5% steps) by 0-10V input signal
- Temperature setting by 0-10V or 0-140 Ω input signal
- Room (inlet air) temp outlet by 4-20mA
- Mode select or/and ON/OFF control
- Fan operation control
- Operation status output/ Alarm output
- Thermostat ON/OFF control

### PAW-T10 PCB to connect to T10 connector.

- A Dry contact PCB has been developed to easily control the unit
- Input signal operation ON/OFF
- Remote control prohibition
- Output signal Operation ON status maximum 230V 5A (NO/NC)
- Output signal alarm status max. 230 V 5 A (NO/NC)
- Additional available contacts:
  - External humidifier control (ON/OFF) 230 VAC 3A
  - External fan control (ON/OFF) 12V DC
  - External filter status signal potential free
  - External float switch signal potential free
  - External leakage detection sensor or TH. OFF contact potential free (possible usage for external blow out temperature control)



ECOi 2-Pipe 6N Series outdoor unit shall be used for AHU Connection Kit. 3 models for VRF system: 5HP (PAW-160MAH2/M/L), 10HP (PAW-280MAH2/M/L) and 20HP (PAW-560MAH2/M/L).

**With GHP outdoor units:**

- One AHU kit may be used for one GHP unit (2-Pipe, 56kW). Multiple AHU kits cannot be used
- Mixed with standard indoor units is not allowed
- Power specifications are Single Phase 220V to 240V

**Technical focus**

- Maximum capacity/system: 60HP (168kW)
- Maximum piping length: 100m (120m equivalent)
- Elevation difference (indoor unit / indoor unit): 4m
- In/Out capacity ratio: 50~100%
- Maximum indoor unit number: 3 units\*
- Outdoor temperature range in heating: -20 ~ +15°C
- Available temperature range for the suction air at AHU Kit: cool: +18 ~ +32°C / heat: +16 ~ +30°C

\* To be simultaneous operation controlled by one remote controller sensor.

- The systems is controlled by the suction air (or room return air) temperature (same as standard indoor unit). (Selectable mode: Automatic / Cooling / Heating / Fan / Dry (but same as Cool))
- The discharge air temperature is also controlled to prevent too-low air discharge in cooling or too-high air discharge in heating (in case of VRF)
- Demand control (Forcible thermostat-OFF control by operating current)
- Defrost operation signal, Thermo-ON/OFF states output
- Drain pump control (Drain-pump and the float switch to be supplied in local)
- External target temperature setting via Indoor/Outdoor signal interface is available with CZ-CAPBC2 (Ex. 0 – 10V)
- Demand control 40% to 120% (5% steps) by 0-10V input signal
- Connectable with P-Link system. Special care for electrical noise may be necessary depending on the on-side system
- Fan control signal from the PCB can be used for control the air volume (high/mid/low and LL for Th-OFF). Need to change the fan control circuit wiring at field

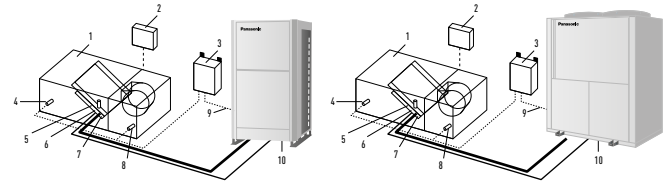

**System & regulations. System overview**

1. AHU Unit equipment (field supplied)
2. AHU Unit system controller (field supplied)
3. AHU Kit controller box (with control PCB)
4. Thermistor for discharge air
5. Electronic expansion valve
6. Thermistor for gas pipe (E3)
7. Thermistor for liquid pipe (E1)
8. Thermistor for suction air
9. Inter-unit wiring
10. Outdoor unit



Optional Controller. Timer remote controller CZ-RTC4 Compatible with Econavi

HP			5HP	10HP	20HP	30HP	40HP	50HP	60HP
			PAW-160MAH2/M/L	PAW-280MAH2/M/L	PAW-560MAH2/M/L	PAW-280MAH2/M/L + PAW-560MAH2/M/L	PAW-560MAH2/M/L + PAW-560MAH2/M/L	PAW-560MAH2/M/L + PAW-560MAH2/M/L + PAW-280MAH2/M/L	PAW-560MAH2/M/L + PAW-560MAH2/M/L + PAW-560MAH2/M/L
Nominal cooling capacity @ 50Hz	kW		14,0	28,0	56,0	84,0	112,0	140,0	168,0
Nominal heating @ 50Hz	kW		16,0	31,5	63,0	95,0	127,0	155,0	189,0
Cooling airflow	Hi / Lo	m³/min	2.600 / 1.140	5.000 / 3.500	10.000 / 7.000	15.000 / 10.500	20.000 / 14.000	25.000 / 17.500	30.000 / 21.000
Bypass factor			0,9 (recommended)	0,9 (recommended)	0,9 (recommended)	0,9 (recommended)	0,9 (recommended)	0,9 (recommended)	0,9 (recommended)
Dimensions / Weight	H x W x D	mm / kg	303 x 232 x 110 / 3,2	404 x 425 x 78 / 6,3	404 x 425 x 78 / 6,3	404 x 425 x 78 / 6,3	404 x 425 x 78 / 6,3	404 x 425 x 78 / 6,3	404 x 425 x 78 / 6,3
Piping length	Min / Max	m	10 / 100	10 / 100	10 / 100	10 / 100	10 / 100	10 / 100	10 / 100
Elevation difference (in/out)	Max	m	10	10	10	10	10	10	10
Piping connections	Liquid pipe	Inch (mm)	3/8 (9,52)	3/8 (9,52)	5/8 (15,88)	3/4 (19,05)	3/4 (19,05)	3/4 (19,05)	3/4 (19,05)
	Gas pipe	Inch (mm)	5/8 (15,88)	7/8 (22,22)	1 1/8 (28,58)	1 1/4 (31,75)	1 1/2 (38,15)	1 1/2 (38,15)	1 1/2 (38,15)
Intake temperature of AHU Kit	Cooling Min ~ Max	°C	+18 ~ +32 (+13 ~ +23)	+18 ~ +32 (+13 ~ +23)	+18 ~ +32 (+13 ~ +23)	+18 ~ +32 (+13 ~ +23)	+18 ~ +32 (+13 ~ +23)	+18 ~ +32 (+13 ~ +23)	+18 ~ +32 (+13 ~ +23)
	Heating Min ~ Max	°C	+16 ~ +30	+16 ~ +30	+16 ~ +30	+16 ~ +30	+16 ~ +30	+16 ~ +30	+16 ~ +30
Ambient temperature of outdoor unit	Cooling Min ~ Max	°C	-10 ~ +43	-10 ~ +43	-10 ~ +43	-10 ~ +43	-10 ~ +43	-10 ~ +43	-10 ~ +43
	Heating Min ~ Max	°C	-20 ~ +15	-20 ~ +15	-20 ~ +15	-20 ~ +15	-20 ~ +15	-20 ~ +15	-20 ~ +15

**AHU connection kit / System combination**

Capacity (HP)	Outdoor unit combination	AHU kit combination
28kW (10HP)	U-10ME2E81	PAW-280MAH2
56kW (20HP)	U-20ME2E81	PAW-560MAH2
84kW (30HP)	U-16ME2E81 U-14ME2E81	PAW-560MAH2 PAW-280MAH2
112kW (40HP)	U-20ME2E81 U-20ME2E81	PAW-560MAH2 PAW-560MAH2
140kW (50HP)	U-18ME2E81 U-16ME2E81 U-16ME2E81	PAW-560MAH2 PAW-560MAH2 PAW-280MAH2
168kW (60HP)	U-20ME2E81 U-20ME2E81 U-20ME2E81	PAW-560MAH2 PAW-560MAH2 PAW-560MAH2
56kW (20HP)	U-20GE3E5	PAW-560MAH2

## AIR CURTAIN WITH DX COIL, CONNECTED TO THE VRF OR PACi SYSTEMS

High efficiency air curtain connected to your VRF installation. EC Fan motor for a smooth operation and efficient performance. 2 types of air flow available: Jet-Flow and Standard. Easy cleaning and servicing.

### Highly efficient heating effect

The combined air stream, which has a desirable low air current induction factor (mixing factor), can carry the selected initial temperature effect over long distances, and will reach the floor area while still at room temperature. This is necessary to avoid cooling down the interior spaces. Available in different lengths to suit requirements between 1,0 and 2,5m, both air curtains have outlet grilles that can be adjusted to five different positions. The jet flow model can be installed up to a height of 3,5m with the standard model up to 3,0m. The outlet grilles can be easily adjusted into five positions to suit different installations requirements and the air filter can be accessed without the need for specialist tools.

- Super-efficient with new EC fan motor (40% lower running costs compared to a standard AC fan motor)
  - Easy Cleaning and Servicing
  - Can be connected to either Panasonic VRF or PACi systems
  - Built-in drain for cooling operation
  - Standard and Jet Flow air curtains can be controlled via Panasonic's range of remote internet controls
- The new standard and jet-flow models are ideal for connection to a ECOi or PACi system. With simple "plug and play" installation, both are fitted with an EC fan motor for a smooth operation and efficient performance. This new fan guarantees 40% lower running cost than with a standard AC fan motor. With air curtains often running for 12 hours a day as a minimum, this can lead to considerable savings.

### Internet Control

An app added to your tablet or smartphone or via the Internet allows you to control and manage the system remotely. There is also the option to integrate into existing BMS systems by using other Panasonic interfaces.

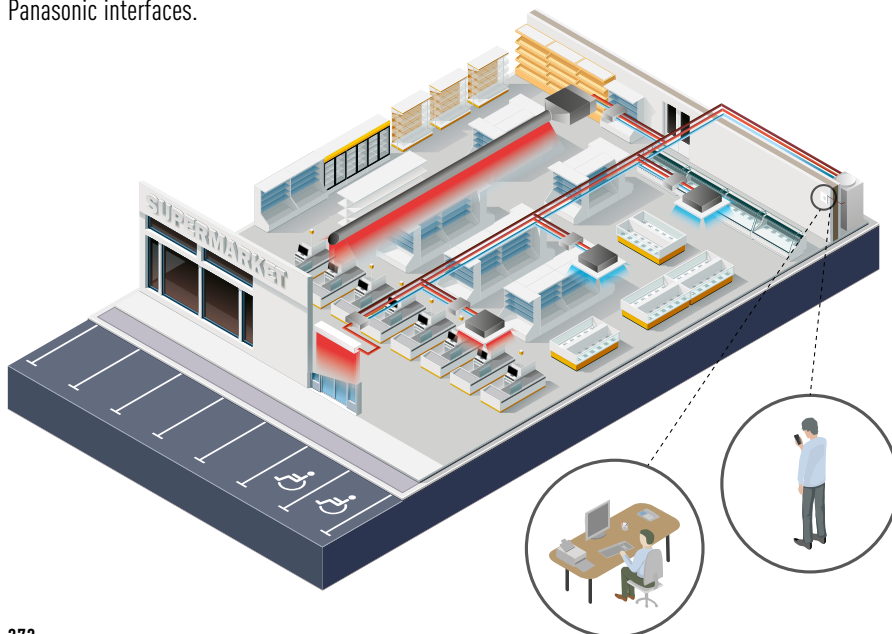

### Intelligent Operation

Our air curtains combine airflow and heating / cooling technology to ensure optimum comfort and energy efficiency whilst also creating an effective barrier between indoor and outdoor environments. Design and installation is key to achieving the correct height / temperature settings to achieve optimum performance. Our air curtains are designed to answer the demands of the retail, commercial and industrial markets.

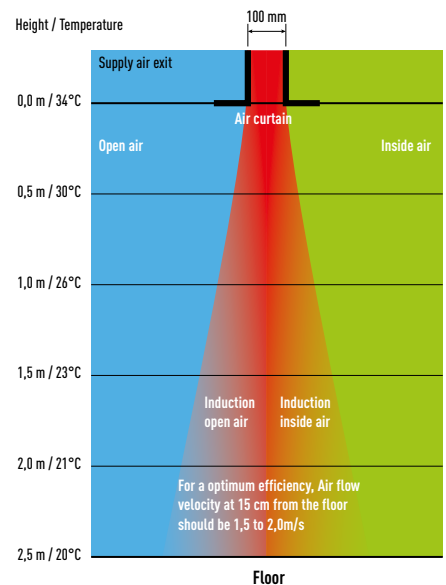

### How does it work?

Stale air from the room is taken in and ejected near the door. This creates a 'roll of air' that shields the door area, mixing with the colder incoming air. It then turns away from the door, back into the room and toward the intake screen, where it is partly drawn in again. This flow of air helps to create a barrier for heat loss yet at the same time refreshes room air

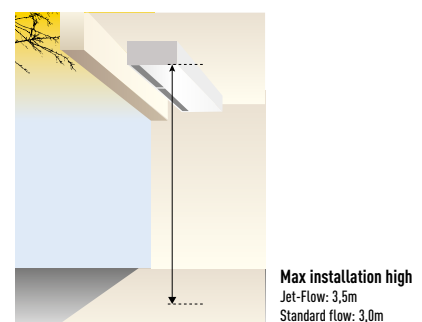



**Technical focus**

- Save up to 40% Energy Costs by use of the integrated EC Fan Technology (Higher efficiency than conventional AC fan, soft start and longer motor duration)
- 3 Lengths of Air Curtains Jet-Flow, from 1,0 to 2,0m and 2 lengths of Air Curtains Standard, 1,0 and 2,0m
- Installation Height up to 3,5m (Jet-Flow) and 3,0m (Standard)
- Outlet Grilles can be adjusted in five positions, to suite different Indoor and installation requirements (Jet-Flow)
- Control with Panasonic Remote Control systems (optional)
- Direct integration to BMS by optional Panasonic Interfaces
- Drain included for cooling operation

**Features**

**Comfort.**

- Easy redirection of Airflow by means of manual deflector (Jet-Flow)

**Ease of use.**

- Speed selector (high and low) on the unit itself

**Easy installation and maintenance.**

- Easy installation
- Compact dimensions improve installation and positioning (Jet-Flow)
- Easy cleaning of grid without opening of the unit

**Optimised airflow velocity**

1. Energy losses, no air curtain installed
2. Too low velocity air curtain – air curtain not efficient
3. Optimum results with the Tekador air curtain connected to Panasonic VRF
4. Too high velocity air curtain – considerable turbulence, energy lost to the outside, air curtain not efficient

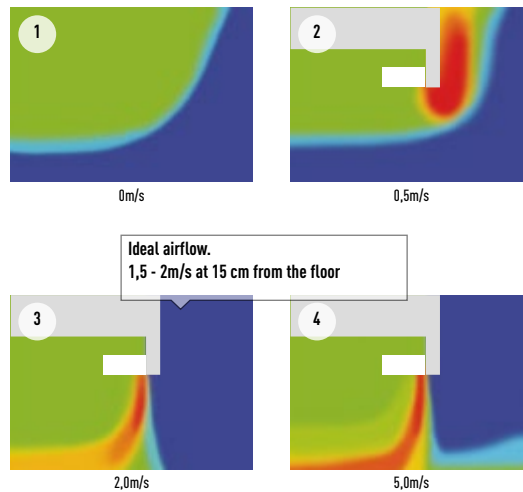

HP			4HP	6HP	8HP	14HP	4HP	8HP
Air Curtain			PAW-10EAIRC-MJ	PAW-15EAIRC-MJ	PAW-20EAIRC-MJ	PAW-25EAIRC-MJ	PAW-10EAIRC-MS	PAW-20EAIRC-MS
Air flow type			Jet-Flow				Standard	
Airflow Length (A)	m		1,0	1,5	2,0	2,5	1,0	2,0
Air volume	Hi / Med / Lo	m <sup>3</sup> /min	30,0 / 25,0 / 20,0	45,0 / 38,3 / 31,7	60,0 / 50,0 / 41,7	75,0 / 63,3 / 51,7	30,0 / 25,0 / 20,0	45,0 / 38,3 / 31,7
Cooling capacity		kW	9,2	17,5	23,1	24,4	9,2	17,5
Heating capacity		kW	11,4	25,0	31,5	31,5	11,4	31,5
Heating capacity with air in 20°C, air out 40°C / 35°C / 30°C		kW	11,9 / 8,9 / 5,9	17,9 / 13,4 / 8,9	23,9 / 17,9 / 11,9	29,9 / 22,4 / 14,9	11,9 / 8,9 / 5,9	17,9 / 13,4 / 8,9
Max installation height	Good / Normal / Bad condition	m	3,5 / 3,1 / 2,7	3,5 / 3,1 / 2,7	3,5 / 3,1 / 2,7	3,5 / 3,1 / 2,7	3 / 2,7 / 2,4	3 / 2,7 / 2,4
Refrigerant			R410A	R410A	R410A	R410A	R410A	R410A
Hot gas temperature / Condensing temperature		°C	70 / 50	70 / 50	70 / 50	70 / 50	70 / 50	70 / 50
Subcooling		K	5	5	5	5	5	5
Pressure		bar	45	45	45	45	45	45
Liquid pipe / Gas pipe		Inch (mm)	3/8 (9,52) / 5/8 (15,88)	3/8 (9,52) / 3/4 (19,05)	3/8 (9,52) / 7/8 (22,22)	3/8 (9,52) / 7/8 (22,22)	3/8 (9,52) / 5/8 (15,88)	3/8 (9,52) / 7/8 (22,22)
Fan			230V / 50Hz / 1 / N / PE	230V / 50Hz / 1 / N / PE	230V / 50Hz / 1 / N / PE	230V / 50Hz / 1 / N / PE	230V / 50Hz / 1 / N / PE	230V / 50Hz / 1 / N / PE
Fan type			EC	EC	EC	EC	EC	EC
Current	Hi / Med / Lo	A	2,1 / 0,8 / 0,3	2,8 / 1,1 / 0,4	4,2 / 1,6 / 0,6	4,9 / 1,9 / 0,7	2,1 / 0,8 / 0,3	4,2 / 1,6 / 0,6
Electrical Consumption	Hi / Med / Lo	kW	0,44 / 0,17 / 0,06	0,59 / 0,23 / 0,08	0,89 / 0,34 / 0,12	1,03 / 0,40 / 0,14	0,44 / 0,17 / 0,06	0,89 / 0,34 / 0,12
Protecting Fuse		A	M16A	M16A	M16A	M16A	M16A	M16A
Noise		dB(A)	40 - 55	40 - 56	40 - 57	40 - 58	40 - 55	40 - 57
Dimensions / Weight	W x H x D	mm / kg	1.210 x 260 x 590 / 70	1.710 x 260 x 590 / 100	2.210 x 260 x 590 / 138	2.710 x 260 x 590 / 160	1.210 x 260 x 490 / 60	2.210 x 260 x 490 / 128
Mini ECOi with air out 40°C			U-4LE1E5/8 <sup>1)</sup>	U-6LE1E5/8 <sup>1)</sup>	—	—	U-4LE1E5/8 <sup>1)</sup>	U-6LE1E5/8 <sup>1)</sup>
Mini ECOi with air out 35°C			U-4LE1E5/8 <sup>1)</sup>	U-4LE1E5/8 <sup>1)</sup>	U-6LE1E5/8 <sup>1)</sup>	—	U-4LE1E5/8 <sup>1)</sup>	U-4LE1E5/8 <sup>1)</sup>
Mini ECOi with air out 30°C			U-4LE1E5/8 <sup>1)</sup>	U-4LE1E5/8 <sup>1)</sup>	U-4LE1E5/8 <sup>1)</sup>	U-5LE1E5/8 <sup>1)</sup>	U-4LE1E5/8 <sup>1)</sup>	U-4LE1E5/8 <sup>1)</sup>
ECOi with air out 40°C			All models	All models	All models	All models without 8HP	All models	All models
ECOi with air out 30°C or 35°C			All models	All models	All models	All models	All models	All models
GHP all temperatures			All models	All models	All models	All models	All models	All models

1) or bigger size.



# ENERGY RECOVERY VENTILATION

Suppresses indoor temperature changes while providing fresh air. Recovers up to 77% of the heat in the outgoing air, for an ecological and energy efficient building.

### Energy efficiency and ecology

Energy consumption is dramatically reduced by using a counter-flow heat-exchange element. Air conditioning load is reduced by approximately 20%, resulting in significant energy savings.

### Comparison of former and current elements

With the cross-flow element, air moves in a straight line across the element; with the counter-flow element, air flows through the element for a longer time (longer distance), so the heat-exchange effect remains unchanged even if the element is made thinner.

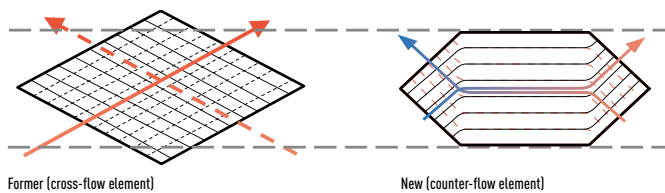

### Heat exchange ventilation and normal ventilation

Energy-saving ventilation can be achieved through the proper use of heat-exchange ventilation and normal ventilation.

#### Heat exchange ventilation.

When a room is cooled or heated, the exhausted cooling / heating energy is recovered by heat-exchange ventilation.

#### Normal ventilation.

This is used in the spring and autumn, when rooms are not cooled or heated, that is, when there is little difference between the indoor and outdoor air conditions. In addition, at night during the hot season, when the outside air temperature drops the outside air is drawn inside without heat exchange, alleviating the load on the air conditioning equipment. The heat exchanger is made up of a membrane manufactured from a special material covered in resin for optimal heat transmission. The nylon/polyester fibre filter offers high dust retention capacity. We have also redesigned the air ducts to obtain a long-lasting heat exchange system which does not need periodic cleaning.

### Heat exchanger

With the cross-flow element, air moves in a straight line across the element. With the counter-flow element, airflows through the element for a longer time (longer distance), so the heat-exchange effect remains unchanged even if the element is made thinner.



### More comfort

#### Quiet operation

Low noise operation results in noticeably quieter units. All models with capacities below 500m<sup>3</sup>/h run at noise levels below 32dB (High setting) and even our largest 1.000m<sup>3</sup>/h-capacity model runs at only 37,5dB (High setting).

### Long service life of heat-exchange element

We used a nonwoven cloth filter with a high dust collection efficiency and redesigned the air flow passages to achieve a durable heat-exchange element that requires no periodic cleaning.

Changes in airflow resistance based on number of years in service.

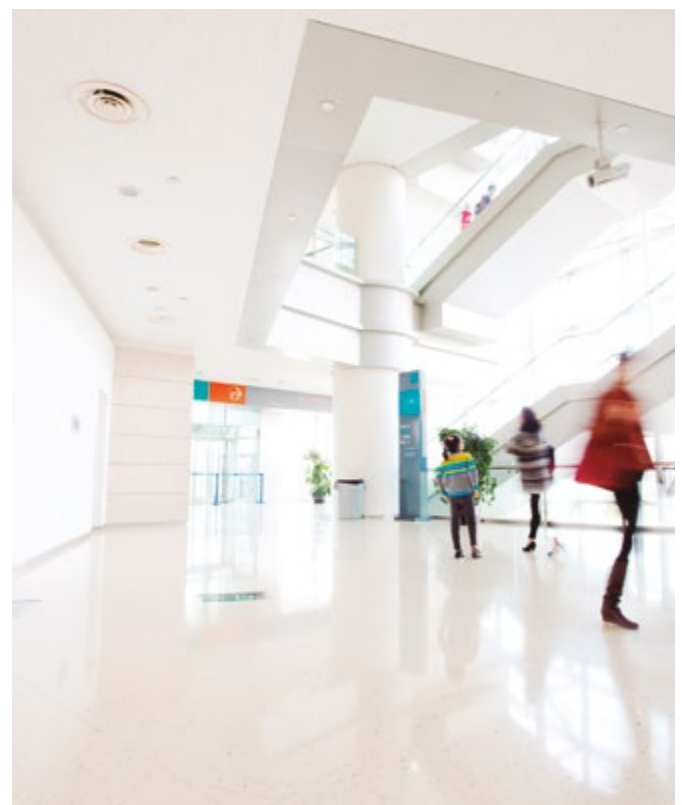
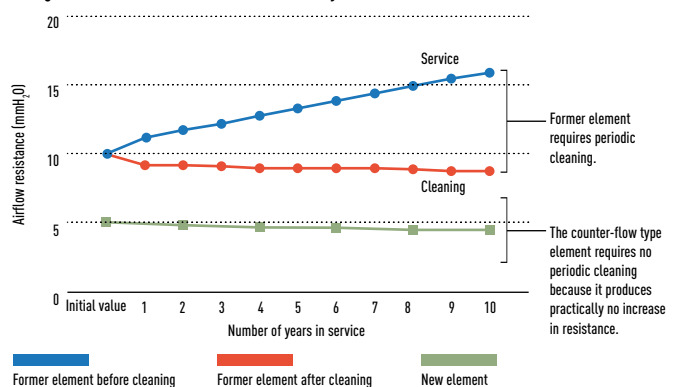



**Technical focus**

- High energy saving, up to 20%
- Counter Cross Flow technology for better efficiency
- Long life element core
- Easy installation and 20% less thickness
- Easy connection to air conditioning units
- Super quiet units

**Features**

**Energy efficiency and ecology.**

- Up to 20% energy saving in the installation
- Recovers up to 77% of the heat in the outgoing air

**Comfort.**

- Cleaning reduced due to the revolutionary structure (every 6 months)
- Ideal for indoor spaces without windows

**Easy installation and maintenance.**

- 6 models for easier selection
- Reduced system height (270mm and 388mm)
- Side opening for cleaning (inspection of filter, motor and other parts)
- Installation can be reversed to share an inspection opening between 2 machines
- Easy connection to the air conditioning unit (without additional elements)
- Installation in false ceilings
- Units operate at 220 - 240V
- High static pressure for easier installation

**Healthy air.**

- The filter guarantees healthier air

**Balanced ventilation**

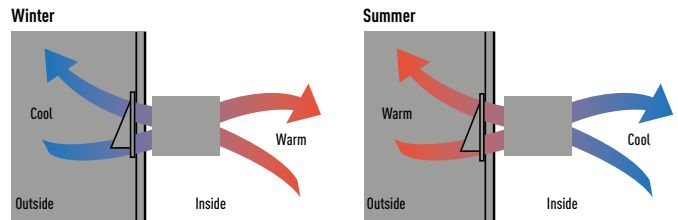

**Easy installation and maintenance**

**Slim shape and easier installation.**

Counter-flow heat exchange element used for reduced noise and slimmer, more compact body shape.

270mm Height: FY-250ZDY8 // FY-350ZDY8 // FY-500ZDY8

388mm Height: FY-800ZDY8 // FY-01KZDY8A

**Reverse mountable direct air supply / exhaust system.**

Adoption of straight air supply / exhaust system: Duct design is simplified because the air supply / exhaust ducts are straight.

Since each unit can be mounted in reverse position, only one inspection hole is needed for two units: Two units can share one inspection hole so duct work is easier and more flexible.

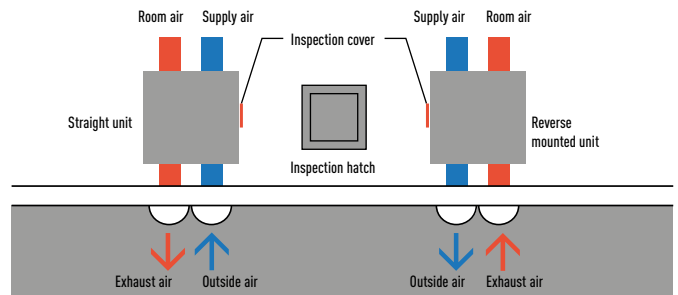

Rated flow rate Models	250m³/h FY-250ZDY8			350m³/h FY-350ZDY8			500m³/h FY-500ZDY8			800m³/h FY-800ZDY8			1.000m³/h FY-01KZDY8A			
Power source	220 / 240 V / 50 Hz			220 / 240 V / 50 Hz			220 / 240 V / 50 Hz			220 / 240 V / 50 Hz			220 / 240 V / 50 Hz			
Heat exchange ventilation	E-High	High	Low	E-High	High	Low	E-High	High	Low	E-High	High	Low	E-High	High	Low	
Input	W	112 / 128	108 / 123	87 / 96	182 / 190	178 / 185	175 / 168	263 / 289	204 / 225	165 / 185	387 / 418	360 / 378	293 / 295	437 / 464	416 / 432	301 / 311
Air volume	m³/h	250	250	190	350	350	240	500	500	440	800	800	630	1.000	1.000	700
External static pressure	Pa	105	95	45	140	60	45	120	60	35	140	110	55	105	80	75
Sound power	dB	30,0 / 31,5	29,5 / 30,5	23,5 / 26,5	32,5 / 33,0	30,5 / 31,0	22,5 / 25,5	36,5 / 37,5	34,5 / 35,5	31,0 / 32,5	37,0 / 37,5	36,5 / 37,0	33,5 / 34,5	37,5 / 38,5	37,0 / 37,5	33,5 / 34,5
Temp. exchange efficiency	%	75	75	77	75	75	78	75	75	76	75	75	76	75	75	79
Normal ventilation	E-High	High	Low	E-High	High	Low	E-High	High	Low	E-High	High	Low	E-High	High	Low	
Input	W	112 / 128	108 / 123	87 / 96	182 / 190	178 / 185	175 / 168	263 / 289	204 / 225	165 / 185	387 / 418	360 / 378	293 / 295	437 / 464	416 / 432	301 / 311
Air volume	m³/h	250	250	190	350	350	240	500	500	440	800	800	630	1.000	1.000	700
External static pressure	Pa	105	95	45	140	60	45	120	60	35	140	110	55	105	80	75
Sound power	dB	30,0 / 31,5	29,5 / 30,5	23,5 / 26,5	32,5 / 33,0	30,5 / 31,0	22,5 / 25,5	37,5 / 38,5	37,0 / 38,0	31,0 / 32,5	37,0 / 37,5	36,5 / 37,0	33,5 / 34,5	39,5 / 40,5	39,0 / 39,5	35,5 / 36,5
Temp. exchange efficiency	%	—	—	—	—	—	—	—	—	—	—	—	—	—	—	—
Dimensions (W x D x H)	mm	882 x 599 x 270			1.050 x 804 x 317			1.090 x 904 x 317			1.322 x 884 x 388			1.322 x 1.134 x 388		
Weight	kg	29			49			57			71			83		

This noise of the product is the value which was measured at the acoustic room. Actually, in the established condition, that undergo influence by the echoing of the room and so that become bigger than the display numerical value. The input, the current and the exchange efficiency are values at the time of the mentioned air volume. The noise level shall be measured 1,5m below the centre of the unit. The temperature exchange efficiency averages that of when cooling and when heating.

## HEAT RECOVERY WITH DX COIL

Panasonic launches an heat recovery solution for greater energy efficiency and cleaner lungs.

Panasonic's heat recovery solution performs well in extreme weather conditions and can achieve up to 77% efficiency (63% in enthalpy efficiency).

The counter-flow heat exchanger reduces the air conditioning load, enabling customers – typically owners of hotels, restaurants and other large commercial buildings – to reduce their energy consumption and save on the cost of maintaining comfortable room temperatures.

### Energy efficiency

As the latest example of Panasonic's continued commitment to developing unbeatable, energy-efficient air conditioning technologies for commercial applications, the company has introduced a heat recovery device. The unit features a DX Coil designed to recover up to 77% of the heat from outgoing air, and a air purifying system which helps to improve air quality.

In even the most demanding commercial applications, business owners will benefit from the unit's ability to by-pass the heat exchange process when the outside air temperature is cool enough for fresh air to be drawn directly inside (free cooling).

This alleviates the load on the air conditioning equipment and consequently reduces energy bills.



### Supply section complete

The supply section comes complete with the DX coil (using the environmentally-friendly R410A refrigerant) – fitted with a solenoid control valve, freon filter, contact temperature sensors on the liquid and gas line, and NTC sensors on the upstream and downstream airflows. The built-in electric box is equipped with a PCB to control the internal fan speed and to interconnect the outdoor and indoor units, and the ducts are connected by circular plastic collars.

### Characteristic curves

The following curves show the unit external static pressure at maximum fan speed for each model.

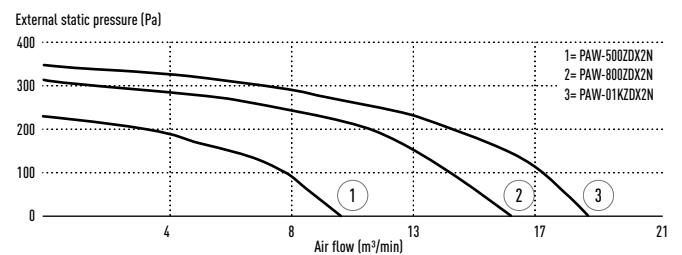

### Balanced Ventilation

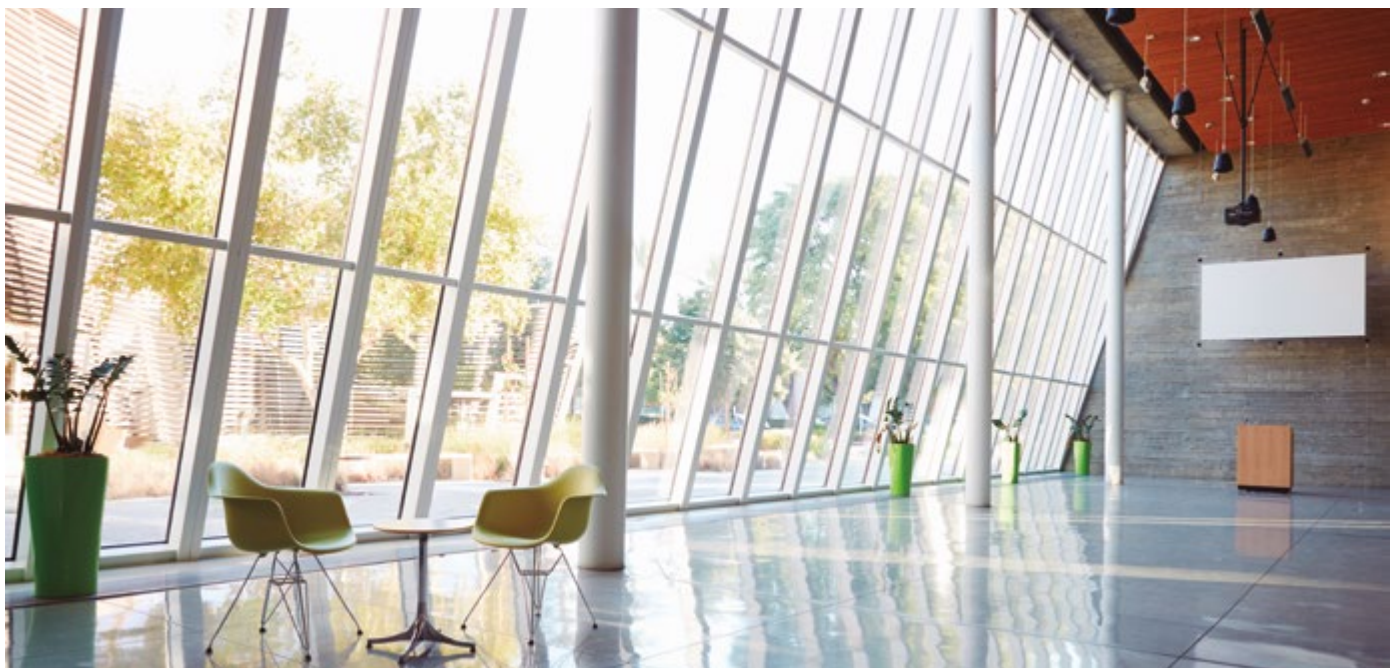
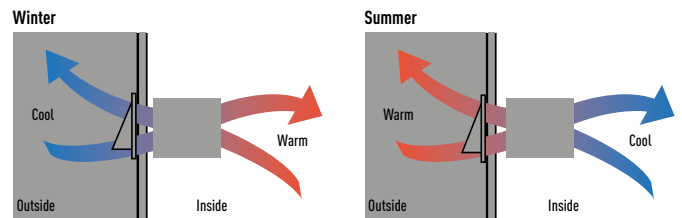

### Interconnection

This ventilation unit is connected to an ECOi indoor unit (3,0kW, 4,0kW or 4,5kW) and can be controlled by the easy-to-use ECOi remote controller CZ-RTC4.

This capability makes the system an excellent choice for hotels, offices (large and small), educational settings and other buildings requiring different temperatures in multiple rooms. The system also integrates easily with building management systems.

### Technical focus

- Motorised heat recovery by-pass device automatically controlled by unit control to use fresh air free-cooling when convenient

### General characteristics

- Galvanized steel self-supporting panels, internally and externally insulated
- Counterflow air-to-air heat recovery device, made of sheets of special paper with special sealing to keep airflows separate and only permeable to water vapour. Total heat exchange with temperature efficiency up to 77% and enthalpy efficiency up to 63%, also at high level during summer season
- G4 efficiency class filters with synthetic cleanable media, both on fresh

air and return air intake

- Removable side panel to access filters and heat recovery in the event of scheduled maintenance
- Low consumption, high efficiency & low noise direct driven fans with 3-speed EC motors
- Supply section complete with DX Coil (R410A) fitted with solenoid control valve, freon filter, contact temperature sensors on liquid and gas line, NTC sensors upstream and downstream airflow
- Built-in electric box equipped with PCB to control internal fan speed and to interconnect outdoor/indoor units
- Duct connection by circular plastic collars
- CZ-RTC4 Timer remote controller (option)

### Interconnection to outdoor/indoor units

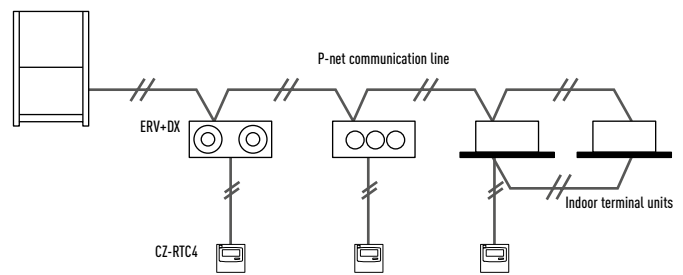

Optional Controller. Wired remote controller CZ-RTC5A Compatible with Econavi



Optional Controller. Timer remote controller CZ-RTC4 Compatible with Econavi

Model	PAW-500ZDX2N		PAW-800ZDX2N		PAW-01KZDX2N	
Power source	230 V / Single Phase / 50 Hz		230 V / Single Phase / 50 Hz		230 V / Single Phase / 50 Hz	
Air volume	Hi / Med / Lo	m <sup>3</sup> /h	500 / 500 / 360	800 / 700 / 600	1.000 / 780 / 650	
External static pressure <sup>1</sup>	Hi / Med / Lo	Pa	135 / 95 / 50	115 / 45 / 25	100 / 70 / 35	
Maximum current	A		2,0	2,8	3,0	
Maximum Input power	W		135	300	310	
Sound pressure <sup>3</sup>	Hi / Med / Lo	dB(A)	33 / 31 / 27	38 / 36 / 32	39 / 37 / 33	
Pipe connections	Liquid / Gas	Inch (mm)	1/4 (6,35) / 1/2 (12,70)	1/4 (6,35) / 1/2 (12,70)	1/4 (6,35) / 1/2 (12,70)	
<b>HEAT RECOVERY</b>			<b>Summer mode</b>	<b>Winter mode</b>	<b>Summer mode</b>	<b>Winter mode</b>
Temperature efficiency	%		62,5	76,5 (76,5)	59	73,0 (73,0)
Enthalpy efficiency	%		60	62,3 (64,1)	57	59,0 (60,8)
Saved power	kW		1,7	4,3 (4,8)	2,5	6,5 (7,3)
<b>DX COIL</b>			<b>Cooling</b>	<b>Heating</b>	<b>Cooling</b>	<b>Heating</b>
Total capacity	kW		3,0	2,9 (3,1)	4,0	4,0 (4,3)
Sensible cooling capacity	kW		2,0	—	2,8	—
Off temperature	°C		16,5	30,1 (29,2)	17,9	27,5 (26,5)
Off relative humidity	%		86	16 (15)	82	18 (17)

Nominal summer conditions: Outside air: 32°C DB, RH 50%. Ambient air: 26°C DB, RH 50%. Nominal winter conditions: Outside air: -5°C (-10°C) DB, RH 80%. Ambient air: 20°C DB, RH 50%. Cooling mode air inlet condition: 28.5°C DB, RH 50%; evaporating temp. 4°C. Heating mode air inlet condition: 13°C DB, RH 40% (11°C DB, RH 45%); condensating temperature 49°C. DB: Dry Bulb; RH: Relative Humidity.  
 1) Referred to the nominal airflow after filter and plate heat exchanger. 3) Referred to 1,5m from inlet in free field condition.



INTERNET CONTROL: Optional.

# DIMENSIONS

## Mini ECOi High Efficiency 4-6HP

4 x Ø32 holes (holes for drain)  
Of the 4 Ø32 holes, use 1 of the 2 holes specified for drain use to install the port.  
Use rubber plugs to seal the remaining 3 holes.

Top view

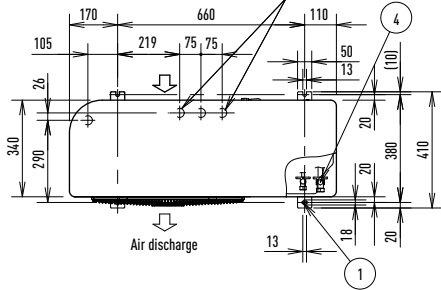

Front view

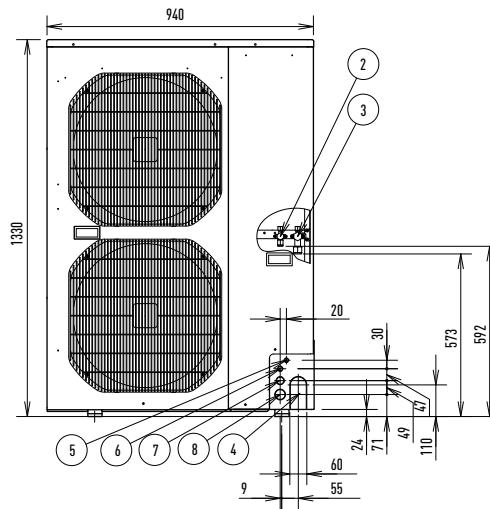

Side view

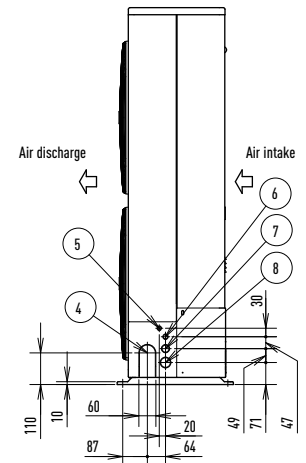

	Size (mm)
1 Mounting hole (4-R6.5), anchor bolt:	M10
2 Refrigerant piping (liquid tube), flared connection	Ø9.52
3 Refrigerant piping (gas tube), flared connection	15.88 or 19.05
4 Refrigerant piping port	
5 Electrical wiring port	Ø16
6 Electrical wiring port	Ø19
7 Electrical wiring port	Ø29
8 Electrical wiring port	Ø38

Unit: mm

## Mini ECOi High Efficiency 8-10HP

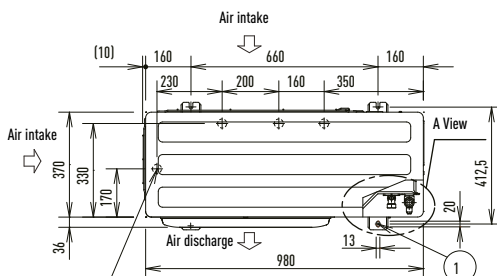

4xØ32 holes (holes for drain)  
When using a drain pipe, install the drain socket (field supply) onto the drain port. Seal the other drain port with the rubber cap.

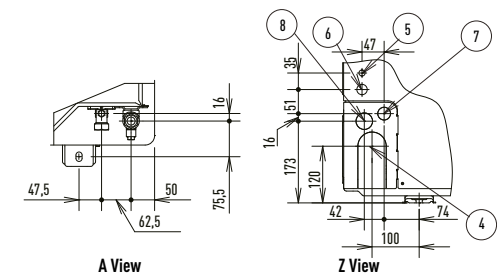

Air intake

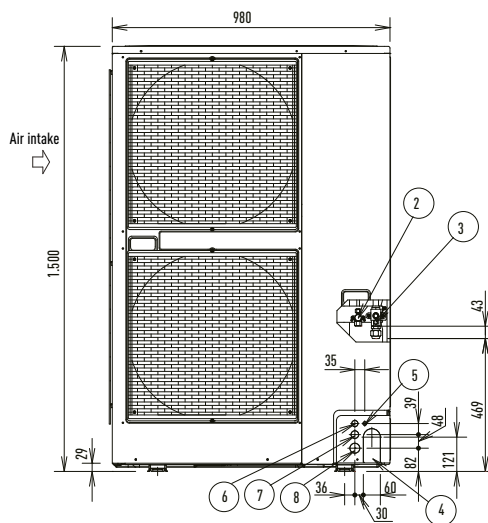

Air intake

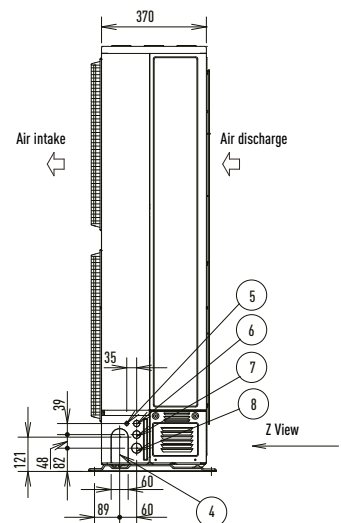

1 Mounting hole (4-R6.5), anchor bolt: M10
2 Refrigerant piping (liquid tube), flared connection (Ø9.52)
3 Refrigerant piping (gas tube), flared connection (Ø19.05)
4 Refrigerant piping port
5 Electrical wiring port (Ø13)
6 Electrical wiring port (Ø22)
7 Electrical wiring port (Ø27)
8 Electrical wiring port (Ø35)

The piping of the gas main has a diameter of ø22.22, but the connection to the service valve of the outdoor unit has a diameter of ø19.05, so a flare has to be used. Consequently, be sure to use the enclosed joint tube B and joint tube A in making connections (brazing).

Unit: mm



2-Pipe ECOi EX ME2 Series 8 / 10HP

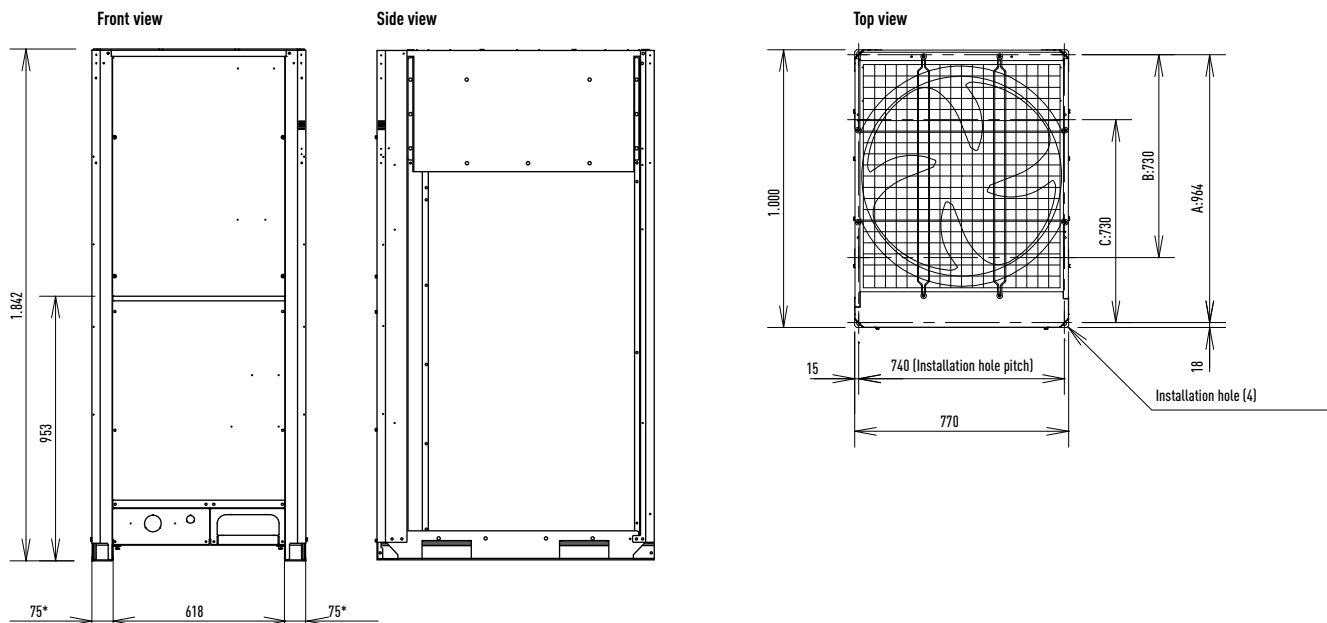

According to the installation site, you may choose the setting position in the depth direction of the anchor bolt from A, B or C.

- A: 964 (Installation hole pitch) (the piping is routed out from the front)
- B: 730 (Installation hole pitch) \* The piping is routed out from the bottom
- C: 730 (Installation hole pitch)

\* Installation fixing bracket. Installation side

Dimensions: mm

2-Pipe ECOi EX ME2 Series 12 / 14 / 16HP

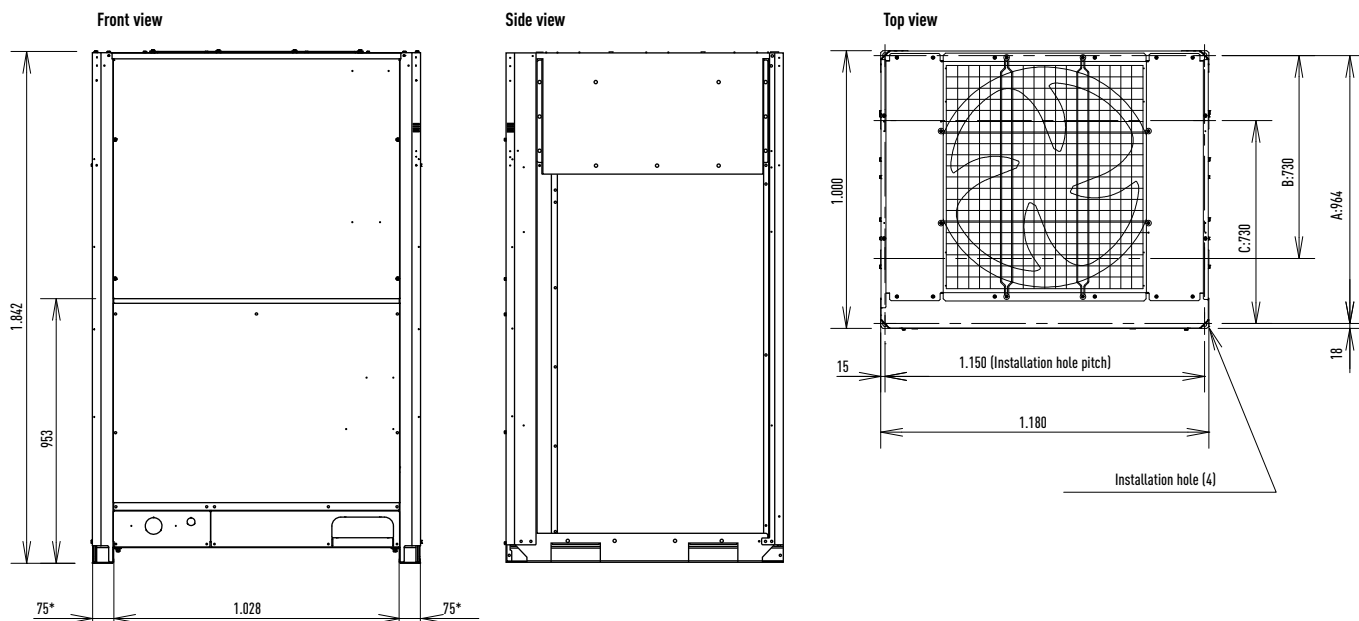

According to the installation site, you may choose the setting position in the depth direction of the anchor bolt from A, B or C.

- A: 964 (Installation hole pitch) (the piping is routed out from the front)
- B: 730 (Installation hole pitch) \* The piping is routed out from the bottom
- C: 730 (Installation hole pitch)

\* Installation fixing bracket. Installation side

Dimensions: mm

2-Pipe ECOi EX ME2 Series 18 / 20HP

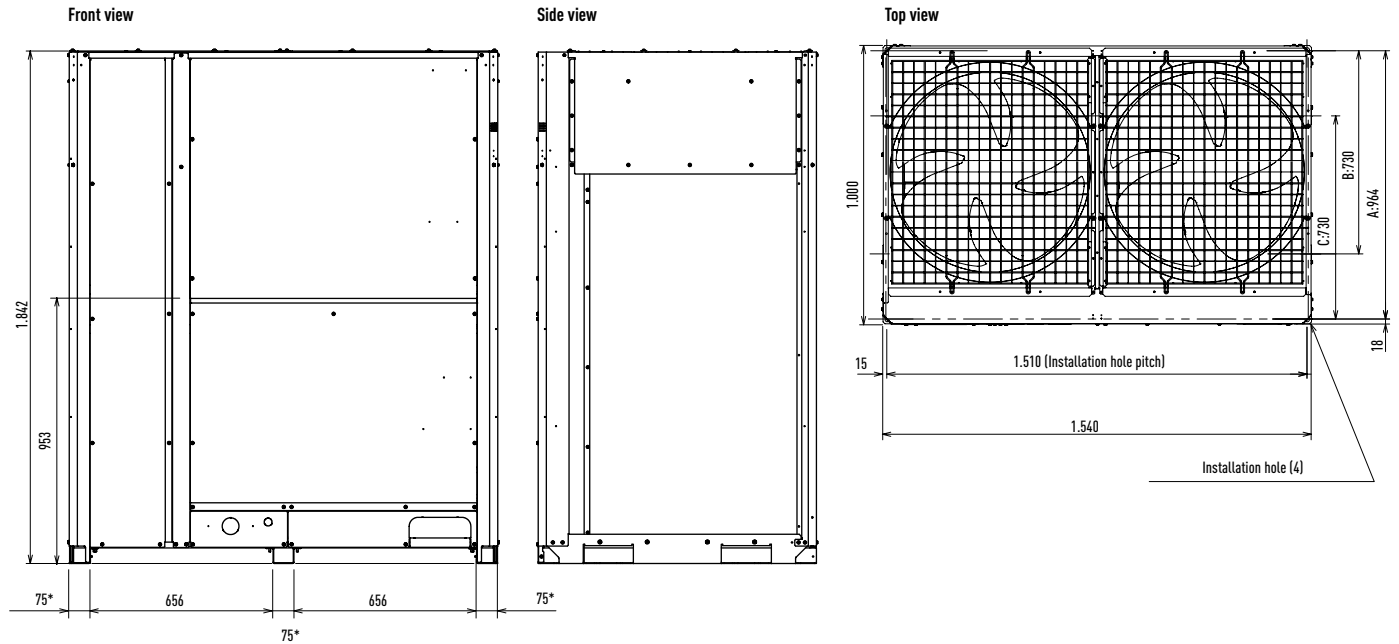

According to the installation site, you may choose the setting position in the depth direction of the anchor bolt from A, B or C.

- A: 964 (Installation hole pitch) (the piping is routed out from the front)
- B: 730 (Installation hole pitch) \* The piping is routed out from the bottom
- C: 730 (Installation hole pitch)

\* Installation fixing bracket. Installation side

Dimensions: mm

3-Pipe ECOi MF2 6N Series 8-16HP

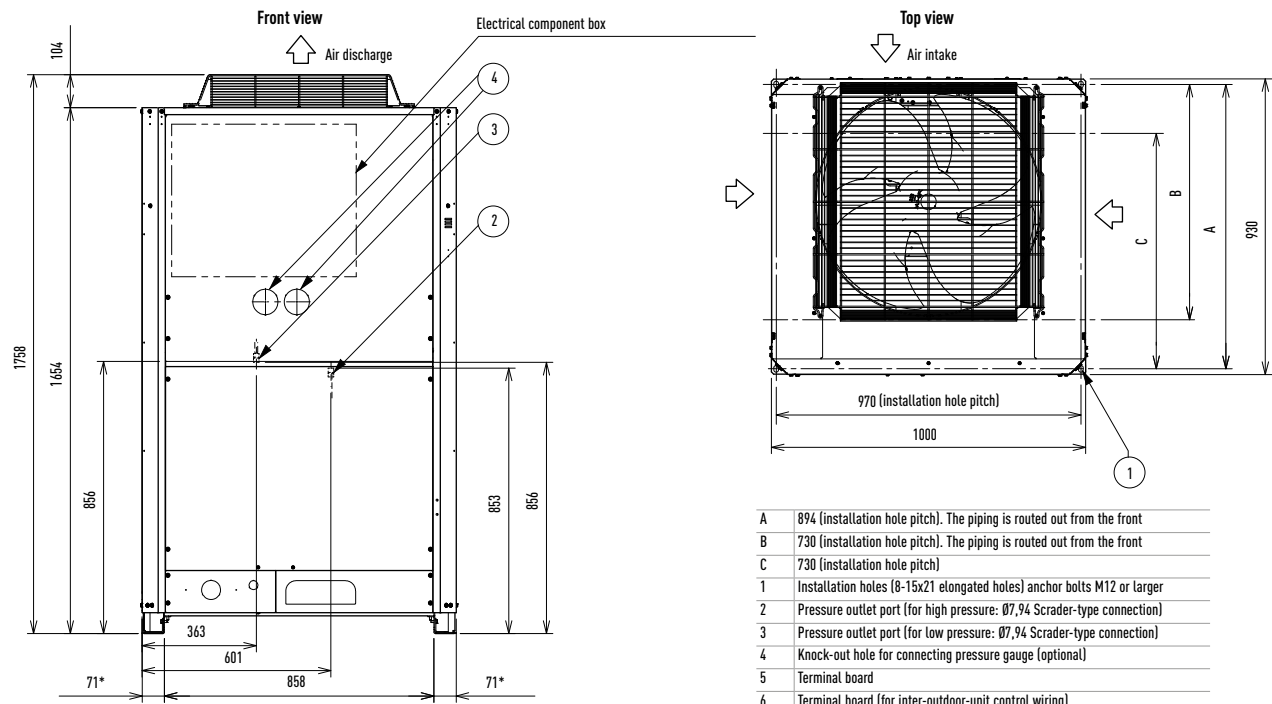

\* Installation fixing bracket, installation side.

- A 894 (installation hole pitch). The piping is routed out from the front
- B 730 (installation hole pitch). The piping is routed out from the front
- C 730 (installation hole pitch)
- 1 Installation holes (8-15x21 elongated holes) anchor bolts M12 or larger
- 2 Pressure outlet port (for high pressure: Ø7,94 Scraeder-type connection)
- 3 Pressure outlet port (for low pressure: Ø7,94 Scraeder-type connection)
- 4 Knock-out hole for connecting pressure gauge (optional)
- 5 Terminal board
- 6 Terminal board (for inter-outdoor-unit control wiring)

### 3-Pipe Control Box Kit / Multiple connection type

#### Heat Recovery Box Dimensions

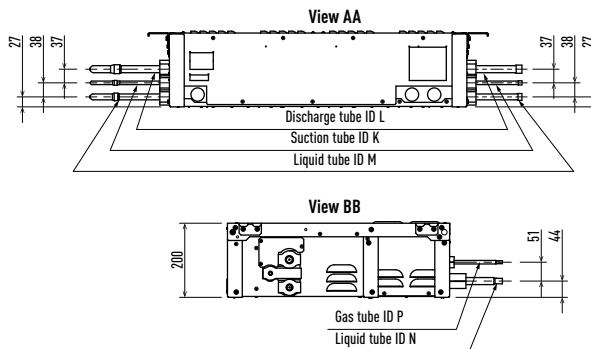
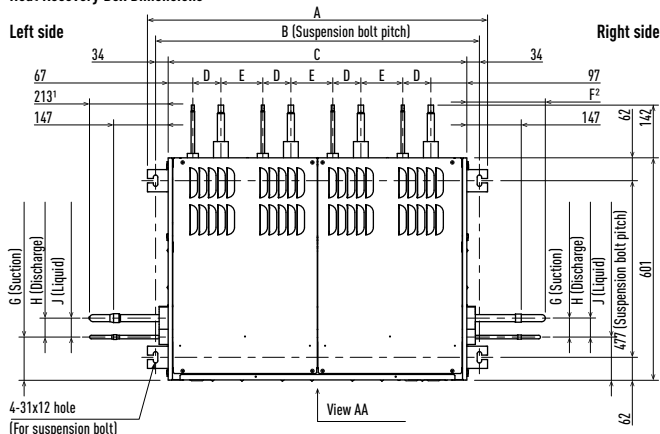

	A	B	C	D	E	F	G	H	J	K	L	M	N	P
Type 456	919	874	807	67	113	213	51	51	117	Ø19,05	Ø15,88	Ø9,52	Ø6,35	Ø12,7
Type 4160	919	874	807	67	113	207	55	54	113	Ø9,52	Ø15,88	Ø28,58	Ø25,4	Ø15,88
Type 656	1.297	1.253	1.185	67	113	213	54	55	115	Ø25,4	Ø19,05	Ø12,7	Ø6,35	Ø12,7
Type 856	1.675	1.631	1.563	67	113	213	53	53	115	Ø28,58	Ø22,22	Ø12,7	Ø6,35	Ø12,7

- 1) In case of right side connection.
- 2) Including the protection tubes when connecting to the left side.

#### Valve Dimensions

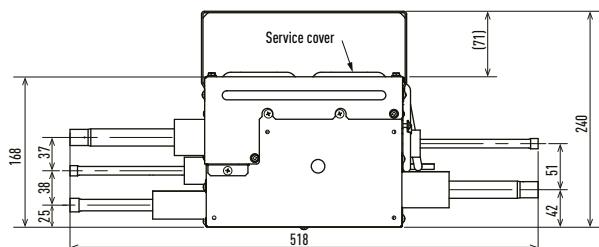
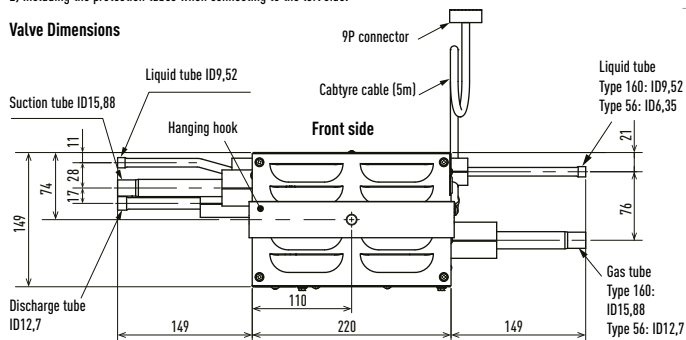

Unit: mm

### ECO G GE3 Series 16 and 20HP

#### Service clearances for installation

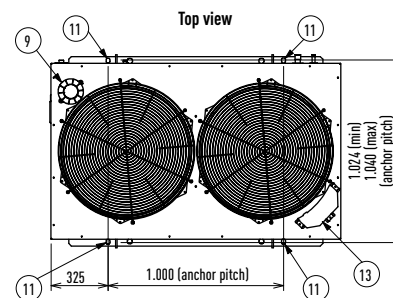
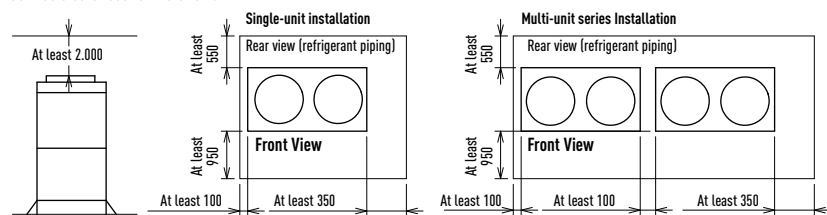

Type	45,0kW	56,0kW
1 Gas refrigerant pipe		Ø28,58
2 Liquid refrigerant pipe	Ø12,7	Ø15,88
3 Exhaust gas drain port	HOSE OD: Ø25 (accessory)	
4 Electrical power supply port		Ø28
5 Inter-unit cable port		Ø28
6 Fuel gas port		R3/4
7 Condensation drain opening		Ø20
8 Rain and condensation outlet		
9 Engine exhaust outlet		
10 Suspension holes 4-Ø20x30		
11 Anchor holes 4-22x30		
12 Segmented display		
13 Coolant intake (top)		
14 Air intake		
15 Coolant level		
16 Hot water inlet		Rp3/4
17 Hot water outlet		Rp3/4

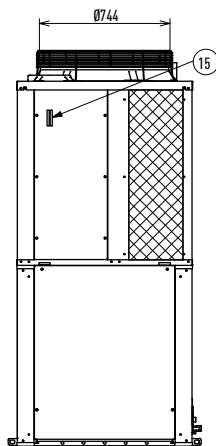

Right side view

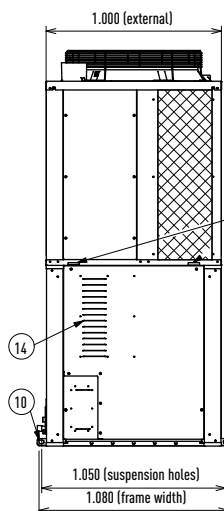

Left side view

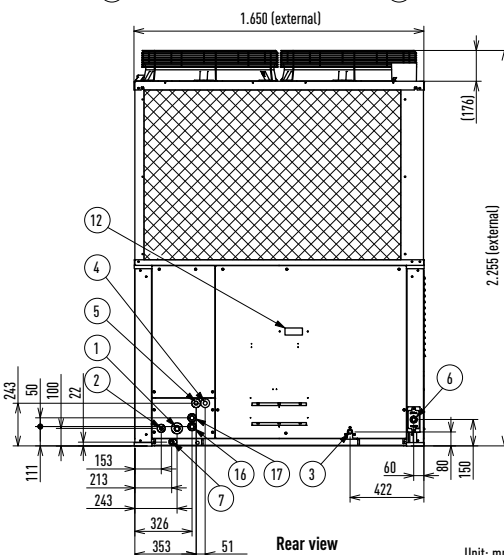

Rear view

Unit: mm

ECO G GE3 Series 25 and 30HP

Service clearances for installation

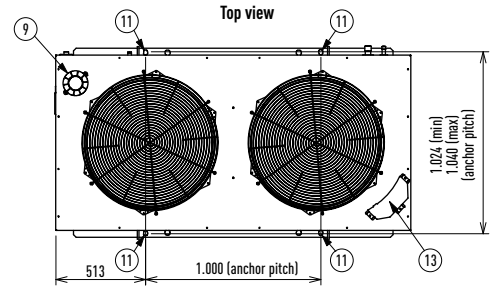
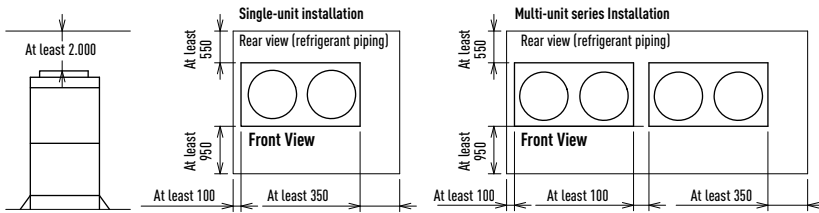

Type	71,0kW	85,0kW
1 Gas refrigerant pipe	Ø28,58	Ø31,75
2 Liquid refrigerant pipe	Ø15,88	Ø19,05
3 Exhaust gas drain port	HOSE OD: Ø25 (accessory)	
4 Electrical power supply port	Ø28	
5 Inter-unit cable port	Ø28	
6 Fuel gas port	R3/4	
7 Condensation drain opening	Ø20	
8 Rain and condensation outlet		
9 Engine exhaust outlet		
10 Suspension holes 4-Ø20x30		
11 Anchor holes 4-22x30		
12 Segmented display		
13 Coolant intake (top)		
14 Air intake		
15 Coolant level		
16 Hot water inlet	Rp3/4	
17 Hot water outlet	Rp3/4	

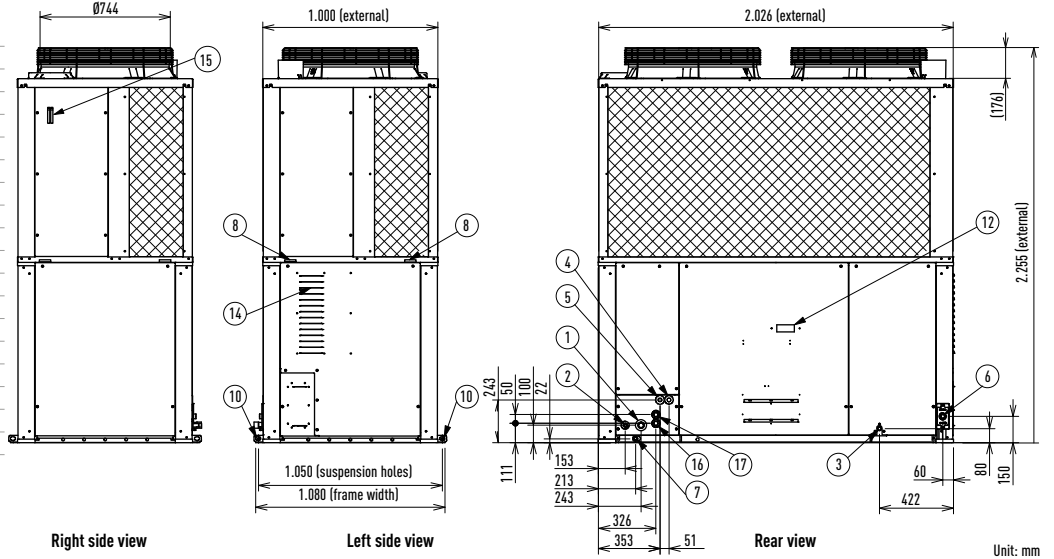

ECO G GF2 3-Pipe

Service clearances for installation

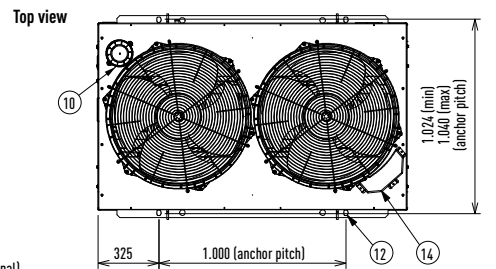
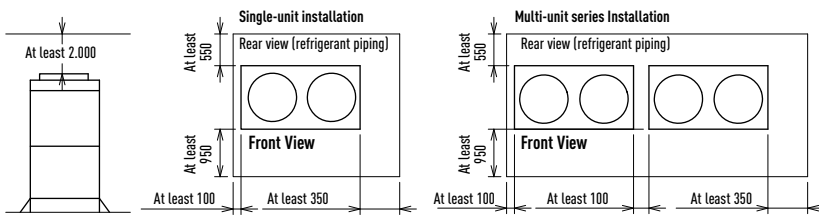

Type	45,0kW	56,0-71,0 kW
1 Suction refrigerant pipe	Ø28,58	
2 Discharge refrigerant pipe	Ø22,22	Ø25,4
3 Liquid refrigerant pipe	Ø19,05	
4 Exhaust gas drain port	HOSE OD: Ø25 (accessory)	
5 Electrical power supply port	Ø28	
6 Inter-unit cable port	Ø28	
7 Fuel gas port	R3/4	
8 Condensation drain opening	Ø20	
9 Rain and condensation outlet		
10 Engine exhaust outlet		
11 Suspension holes 4-Ø20x30		
12 Anchor holes 4-Ø22x30		
13 Segmented display		
14 Coolant intake (top)		
15 Vent		

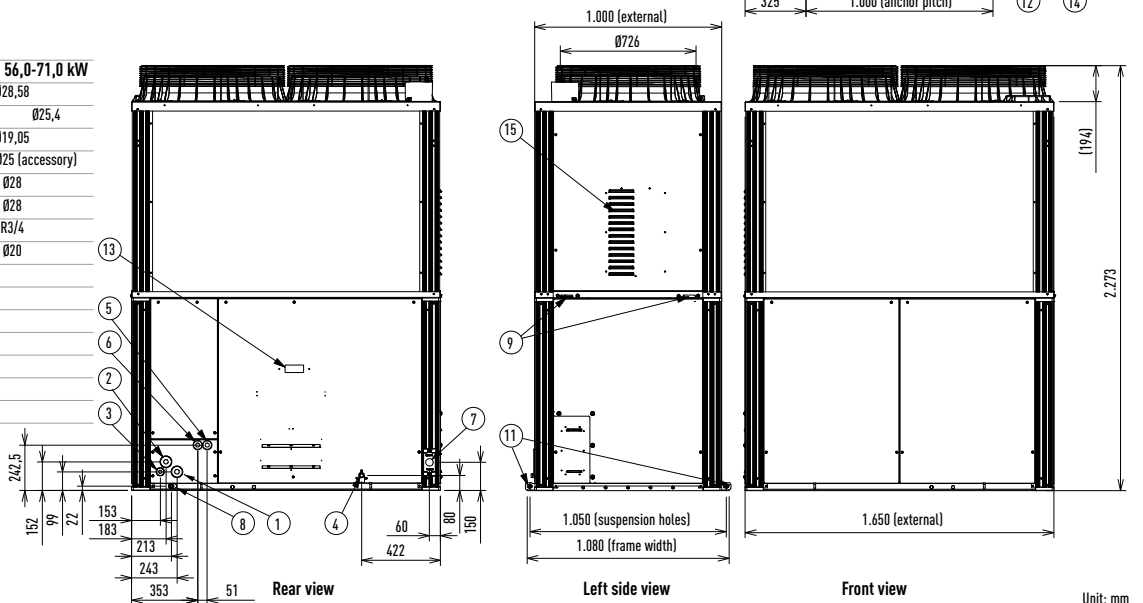



### Water Heat Exchanger for chilled and hot water production

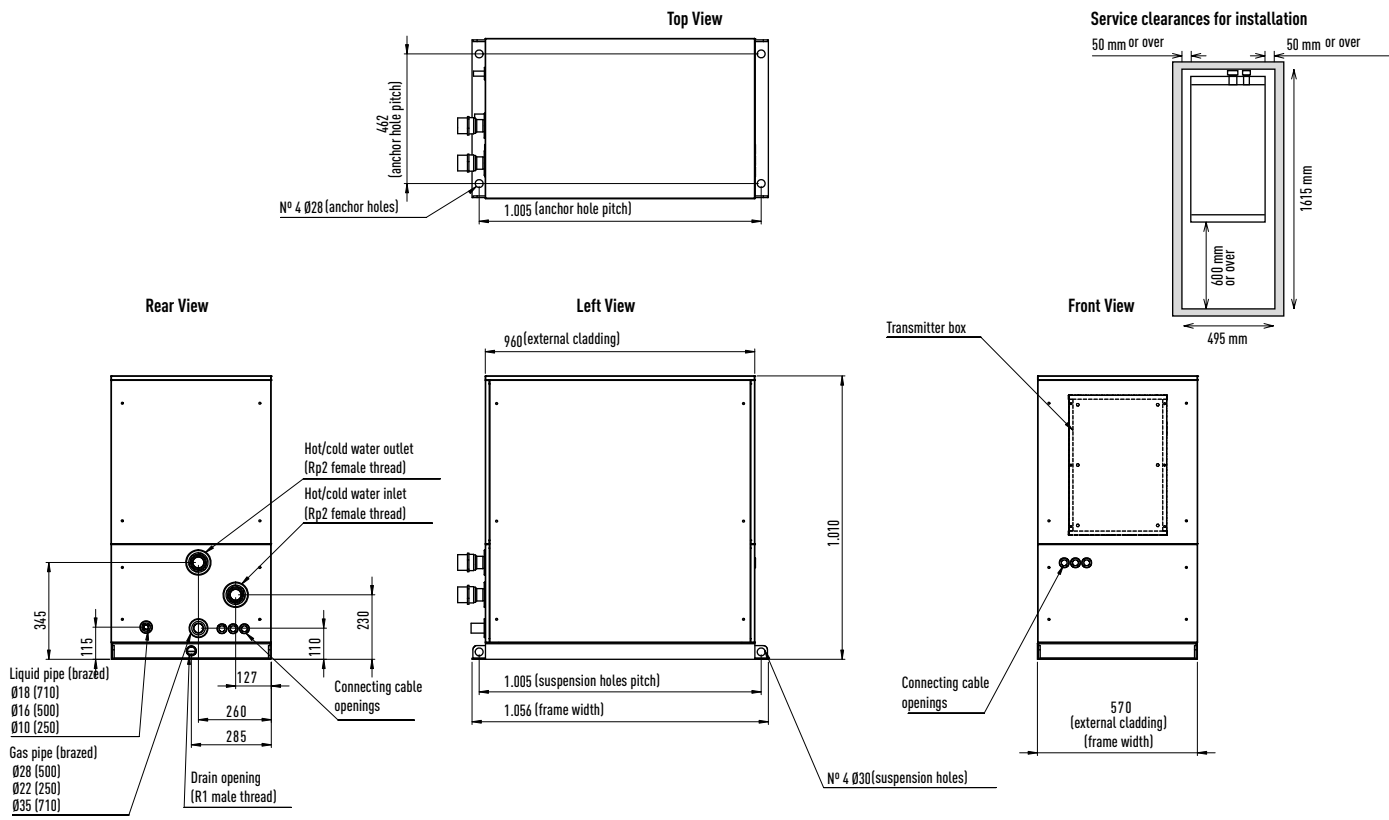

Unit: mm

### U2 Type. 4 Way 90x90 Cassette

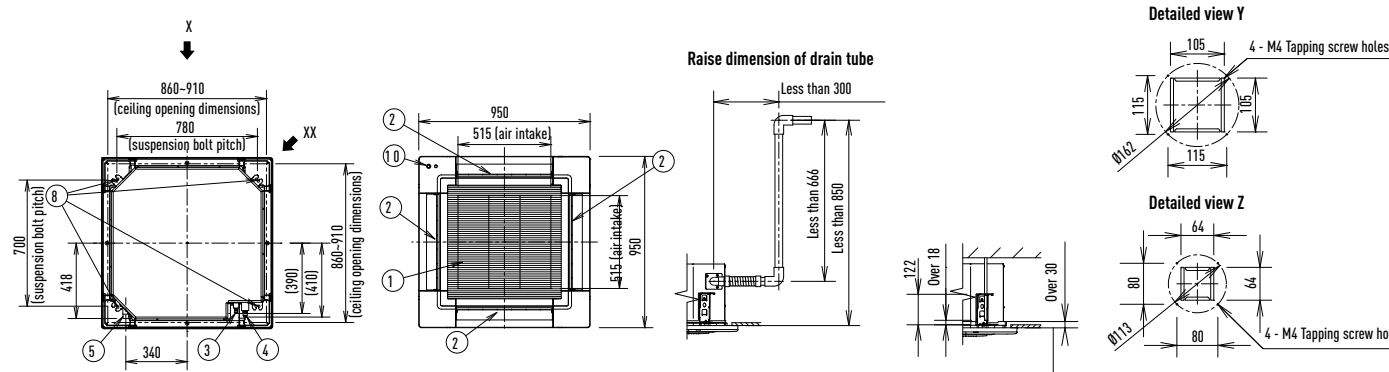

S-22MU2E5A // S-28MU2E5A // S-36MU2E5A // S-45MU2E5A // S-56MU2E5A // S-60MU2E5A // S-73MU2E5A // S-90MU2E5A

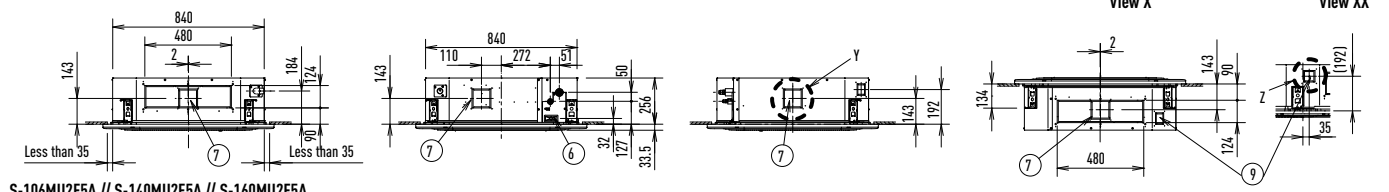

S-106MU2E5A // S-140MU2E5A // S-160MU2E5A

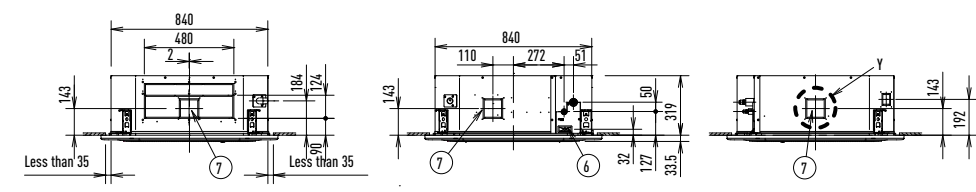

The length of the suspension bolts should be selected so that there is a gap of 30mm or more below the lower surface of the ceiling (18mm or more below the lower surface of the main unit), as shown in the figure at right. If the suspension bolt is too long, it will contact the ceiling panel and the unit cannot be installed.  
Filter dimension: 520 x 520 x 15mm.

Type	22-90	106-160
1 Air intake		
2 Discharge outlet		
3 Refrigerant piping (liquid tube)	Ø6,35 (flared)	Ø9,52 (flared)
4 Refrigerant piping (gas tube)	Ø12,7 (flared)	Ø15,88 (flared)
5 Drain tube connection port VP25 (outer diameter Ø32)		
6 Power supply port		
7 Suspension bolt hole (4-12x30 elongated hole)		
8 Fresh air intake duct connection port (Ø100)*		
9 Suspension bolt hole (4-12x30 elongated hole)		
10 Econavi sensor (Only CZ-KPU3A)		

\* Necessary to attach duct connecting flange(field supplied).

Unit: mm

### U1 Type. 4 Way 90x90 Cassette

Type	22-56	60-160
1	Air intake grill	
2	Air discharge outlet	
3	Refrigerant piping (liquid pipes)	Ø6,35 (flared)    Ø9,52 (flared)
4	Refrigerant piping (gas pipes)	Ø12,7 (flared)    Ø15,88 (flared)
5	Drain outlet VP50    Outer diameter 32mm	
6	Power supply port	
7	Discharge duct    Ø150	
8	Suspension bolt hole    4-12x30 slot	
9	Fresh air intake duct connection port    Ø100 <sup>1</sup>	

1 Air inlet kit is necessary.  
Filter size: 520 x 520 x 16

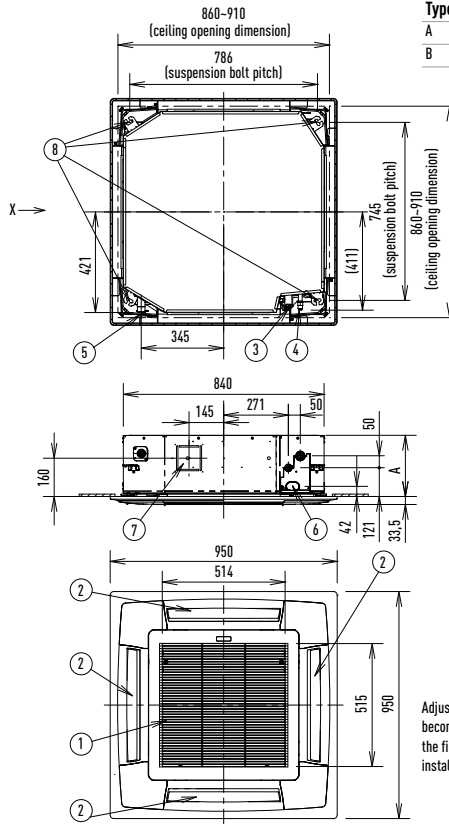
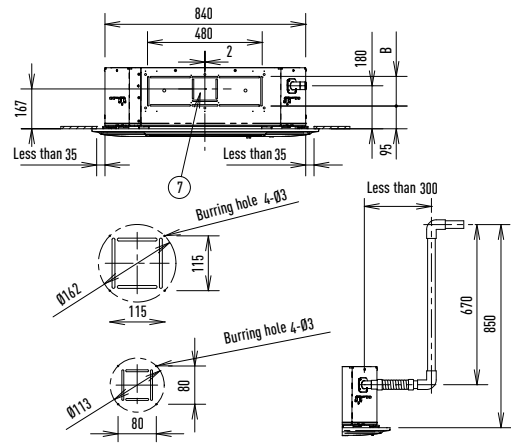

Type	22-90	106-160
A	256	319
B	124	187

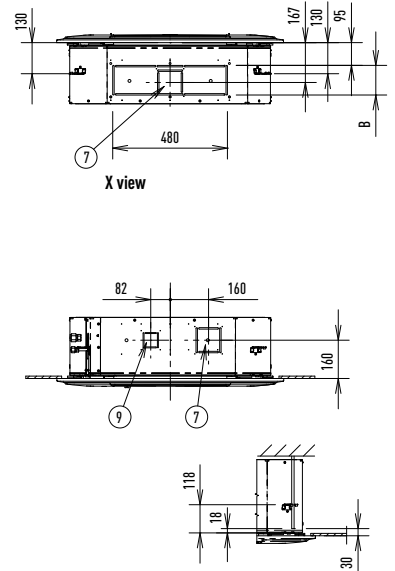

Adjust the suspension bolt length so that the gap from the lower ceiling surface becomes 30mm or more (18mm or more from the lower surface of the body) as shown in the figure. When the suspension bolt length is long, it hits the ceiling panel and installation is not possible.

Unit: mm

### Y2 Type. 4 Way 60x60 Cassette

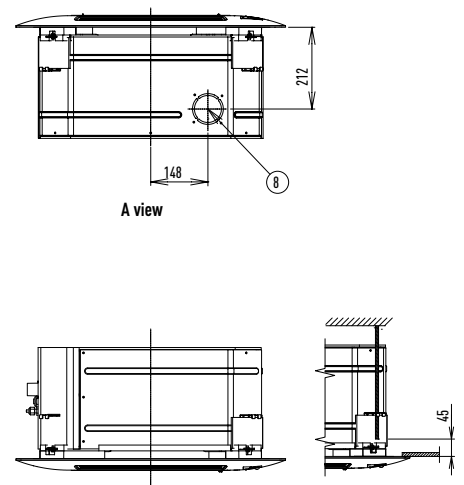
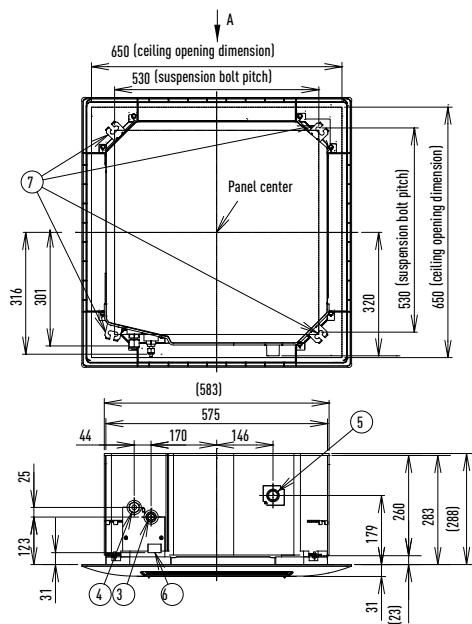
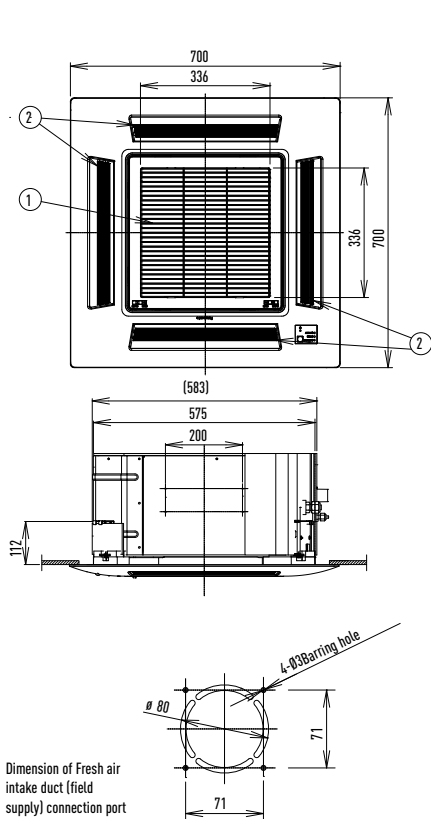

1	Air intake	
2	Discharge outlet	
3	Refrigerant piping (liquid tube)	Ø6,35 (flared)
4	Refrigerant piping (gas tube)	Ø12,7 (flared)
5	Drain tube connection port VP25	Outer dia. Ø32
6	Power supply port	
7	Suspension bolt hole    4-11 x 26 hole	
8	Fresh air intake duct connection port    Ø80	

Adjust the suspension bolt length so that the gap from the lower ceiling surface becomes 45mm or more, as shown in the figure at right. If the suspension bolts are too long, it will contact the ceiling panel and the unit cannot be installed.

Unit: mm

### L1 Type. 2 Way Cassette

1	Refrigerant liquid line	Ø9,52
2	Refrigerant gas line	Ø15,88
3	Drain connection Z5 A	Outer diameter 32mm
4	Power supply entry	

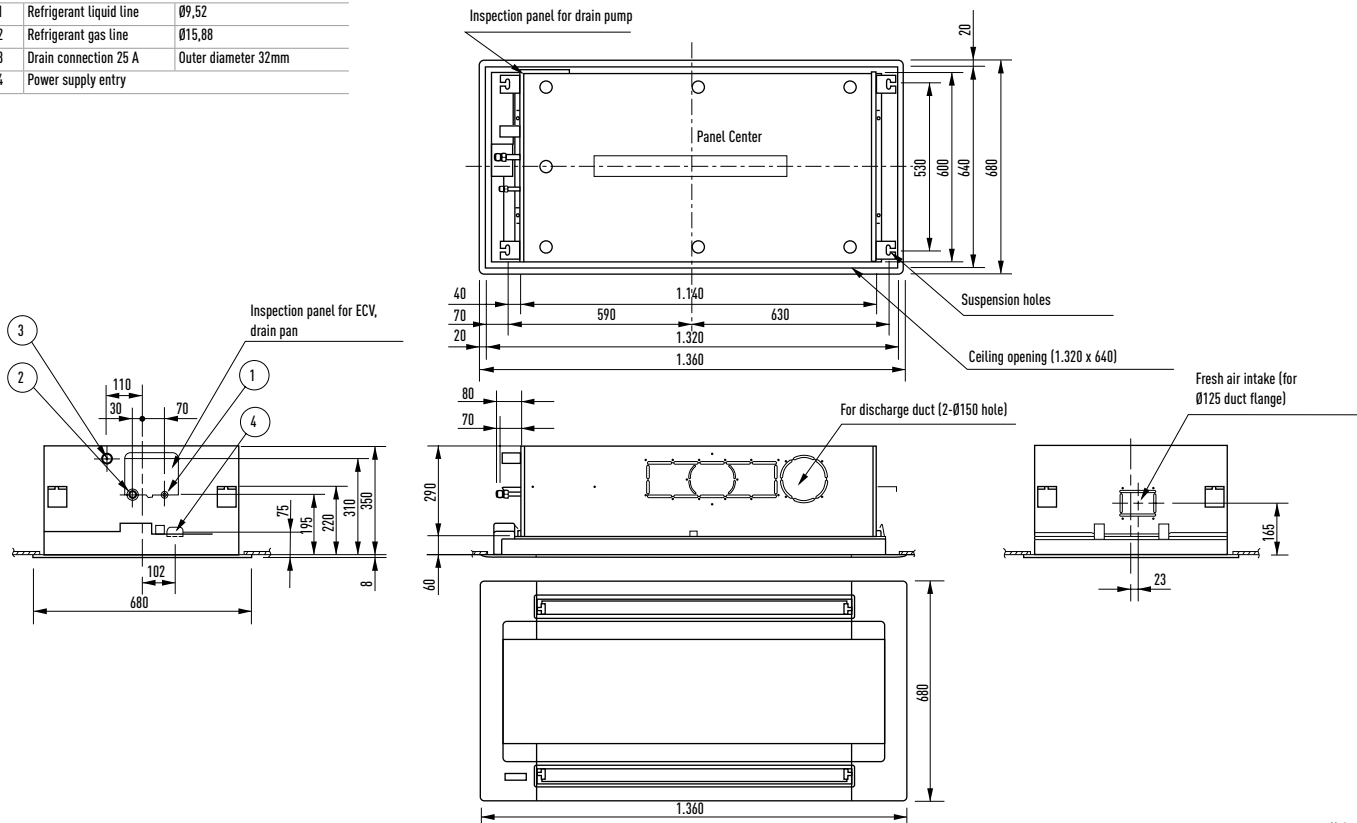

Unit: mm

### D1 Type. 1 Way Cassette

	28-56	73
1	Air intake grille	
2	Discharge outlet	
3	Refrigerant piping (liquid pipes)	Ø6,35 (flared) Ø9,52 (flared)
4	Refrigerant piping (gas pipes)	Ø12,7 (flared) Ø15,88 (flared)
5	Drain connection VP25	Outer diameter:32
6	Power supply entry	
7	Discharge duct connection port (for descending ceiling)	
8	Fresh air intake duct connection port	Ø100
9	Installation port for wireless remote controller receiver	
10	Suspension bolt hole	4-12 30 hole

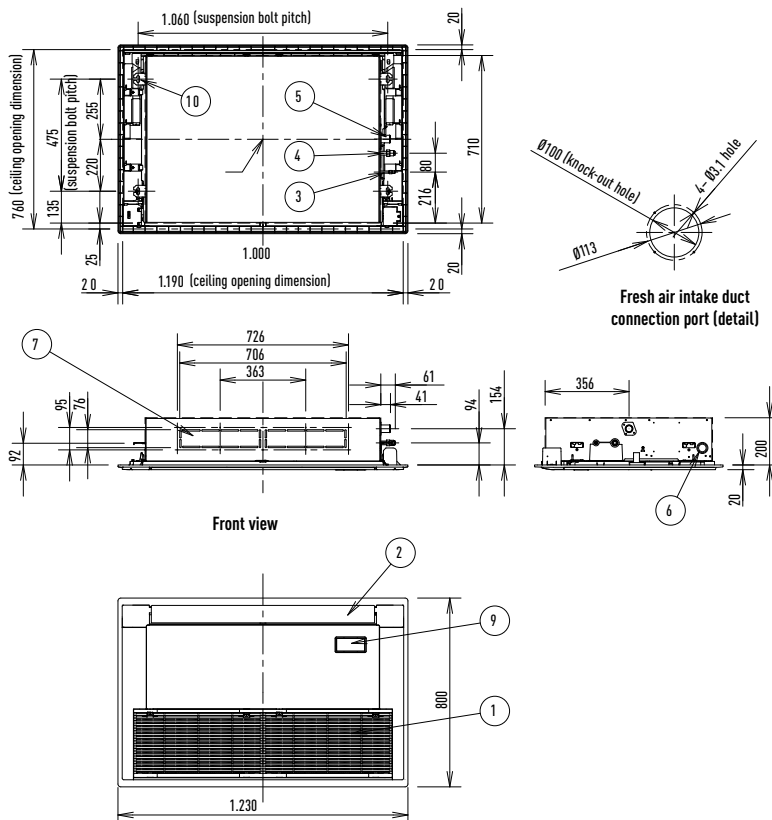

Required space for installation

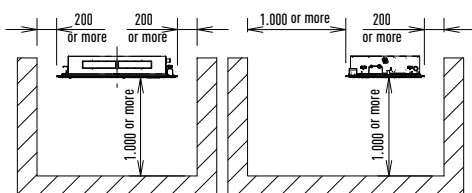

Front view

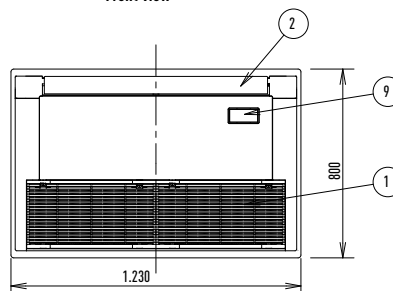

Unit: mm

### M1 Type. Slim Variable Static Pressure Hide Away

1	Refrigerant piping joint (narrow tube)	
2	Refrigerant piping joint (wide tube)	
3	Upper and bottom drain port	Outer diameter 26mm
4	Suspension lug	
5	Power supply outlet	2- Ø30
6	Flange for air intake duct	
7	PL cover	
8	Electrical component box	
9	Frame filter	
10	Signal output board	ACC-SG-AGB: optional

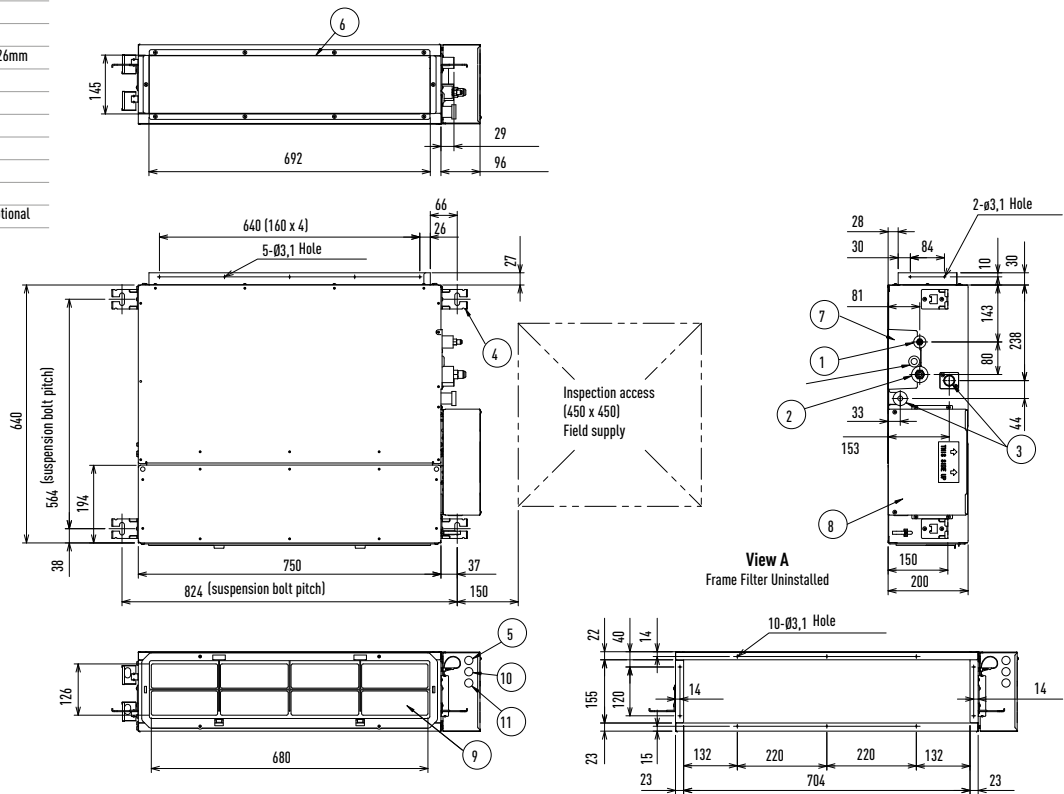

Unit: mm

### E2 Type. High Static Pressure Hide Away

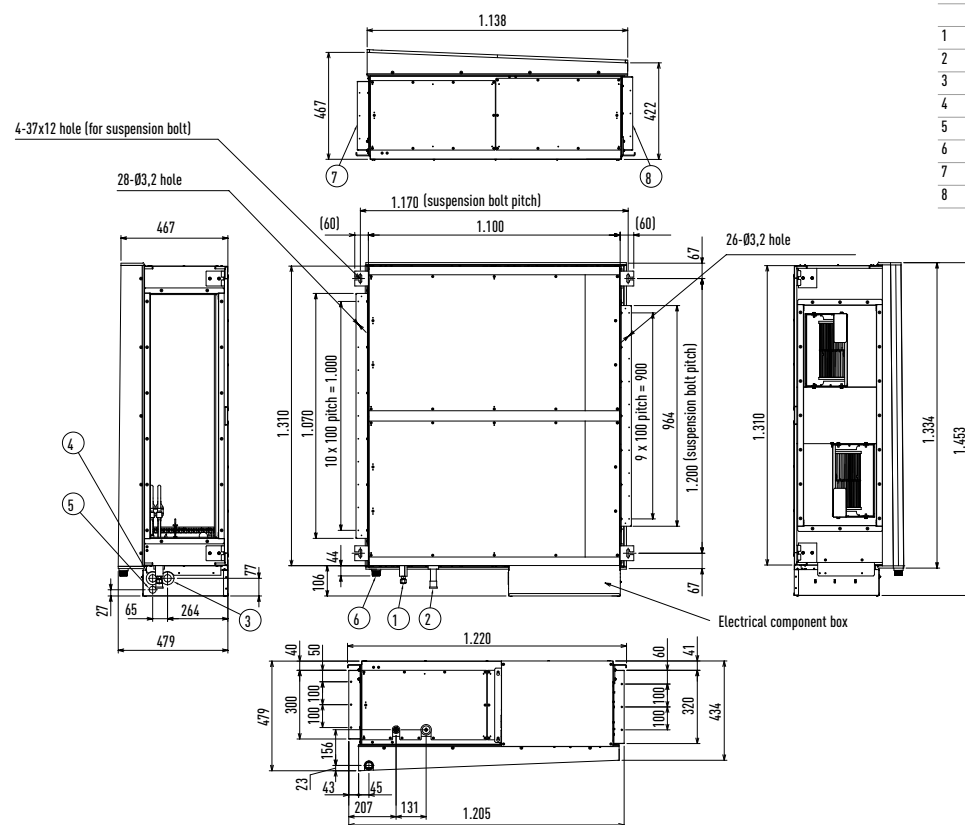

	224	280
1	Refrigerant liquid piping (Flare)	Ø9,52
2	Refrigerant gas piping (Brazing)	Ø19,05    Ø22,22
3	Power supply port	
4	Communication wiring port	
5	Port for optional wiring part	
6	Drain port 25A	
7	Air intake duct connecting side flange	
8	Air discharge duct connecting side flange	

Unit: mm

### F2 Type. Variable Static Pressure Hide Away

S-15MF2E5A // S-22MF2E5A // S-28MF2E5A // S-36MF2E5A // S-45MF2E5A // S-56MF2E5A

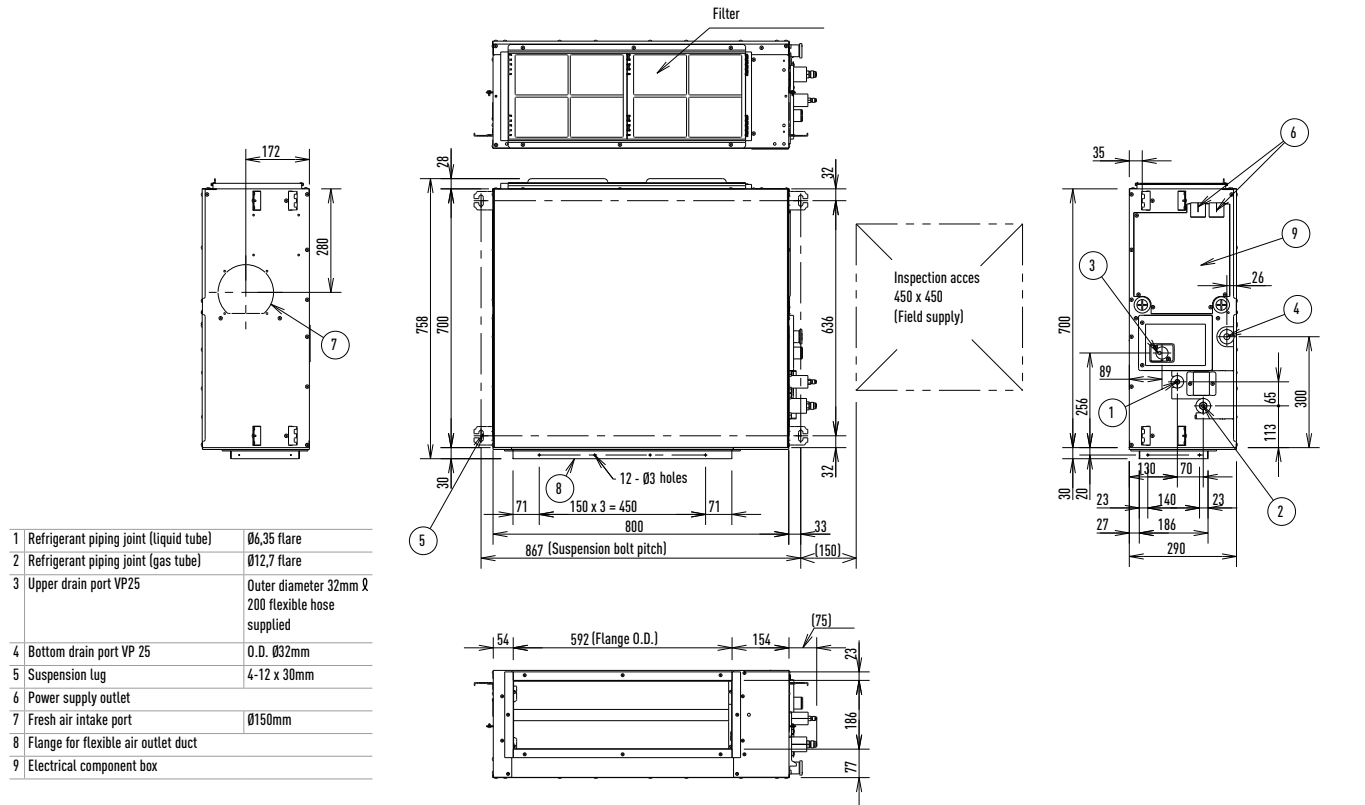

S-60MF2E5A // S-73MF2E5A // S-90MF2E5A

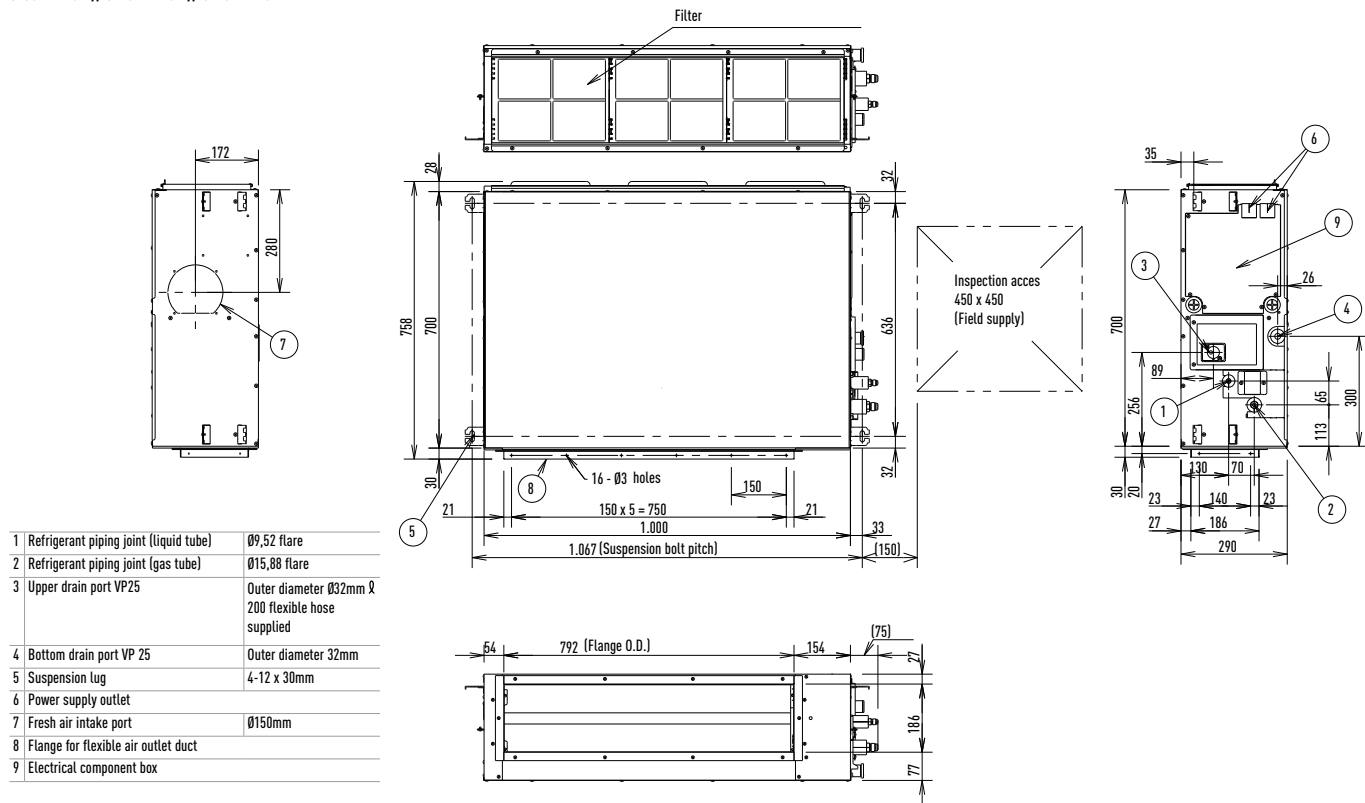



## F2 Type. Variable Static Pressure Hide Away

S-106MF2E5A // S-140MF2E5A // S-160MF2E5A

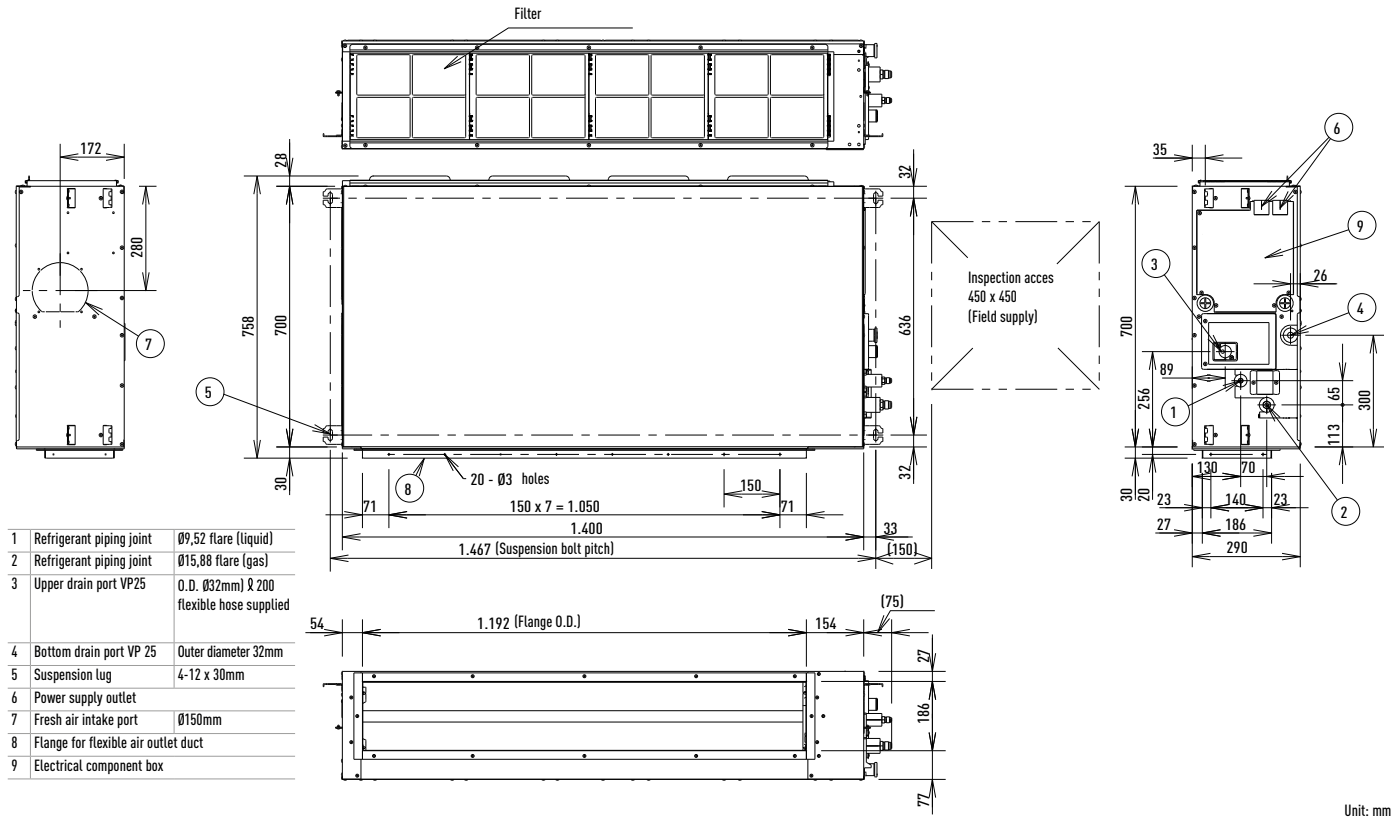

Unit: mm

## Heat Recovery with DX Coil

	A	A1	A2	B	B1	B2	C	D	D1	Ød	E	Net weight
PAW-500ZDX2N	1.822	1.752	1.986	882	936	994	390	431	431	250	169	81
PAW-800ZDX2N	1.822	1.752	1.986	1.132	1.186	1.244	390	431	431	250	169	87
PAW-01KZDX2N	1.822	1.752	1.986	1.132	1.186	1.244	390	681	532	250	169	87

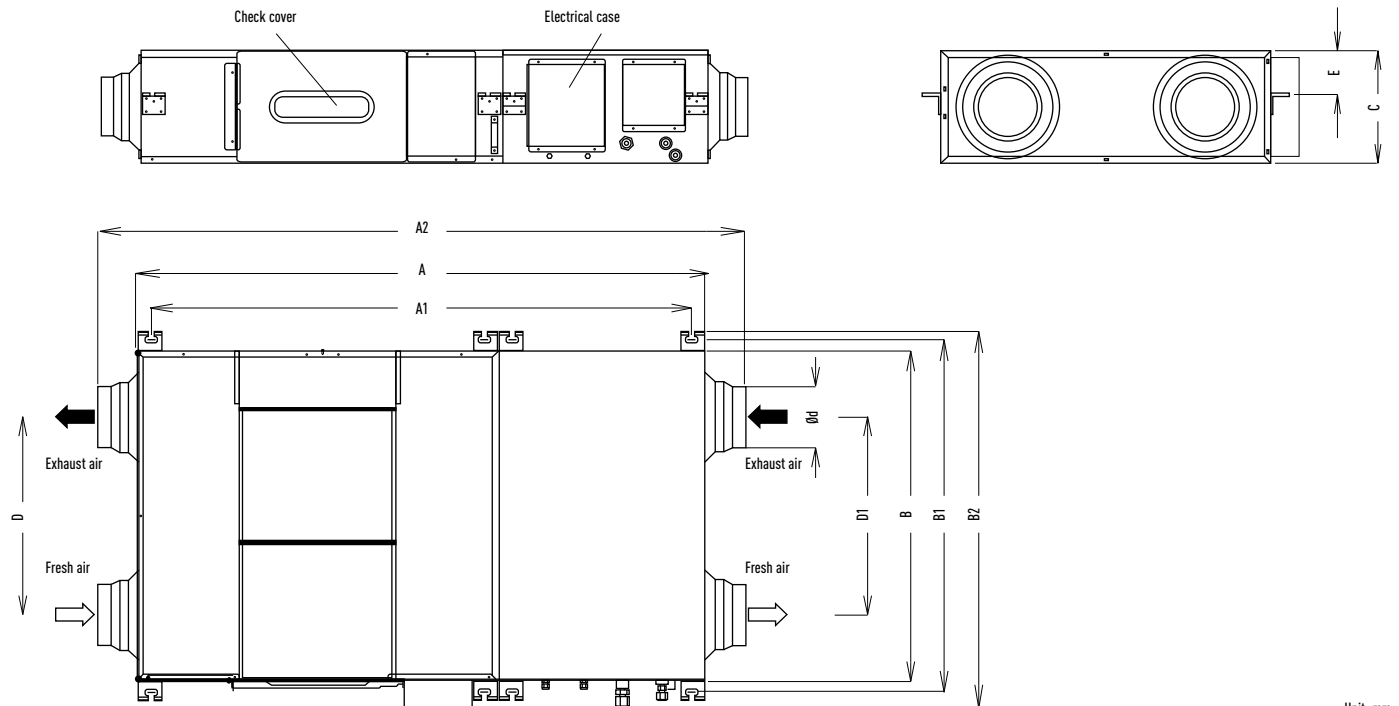

Unit: mm

## T2 Type. Ceiling

S-36MT2E5A // S-45MT2E5A // S-56MT2E5A

1 Drain port VP20	Inside diameter Ø26mm, drain hose supplied
2 Left drain position	
3 Refrigerant liquid piping	Ø9,52mm, flare connection
4 Refrigerant gas piping	Ø15,88mm, flare connection
5 Left side drain hose outlet port (cutout)	
6 Piping hole on wall surface	Ø100mm
7 Upper side piping port	
8 Right side drain hose outlet port (cutout)	
9 Wireless remote controller receiver installation location	

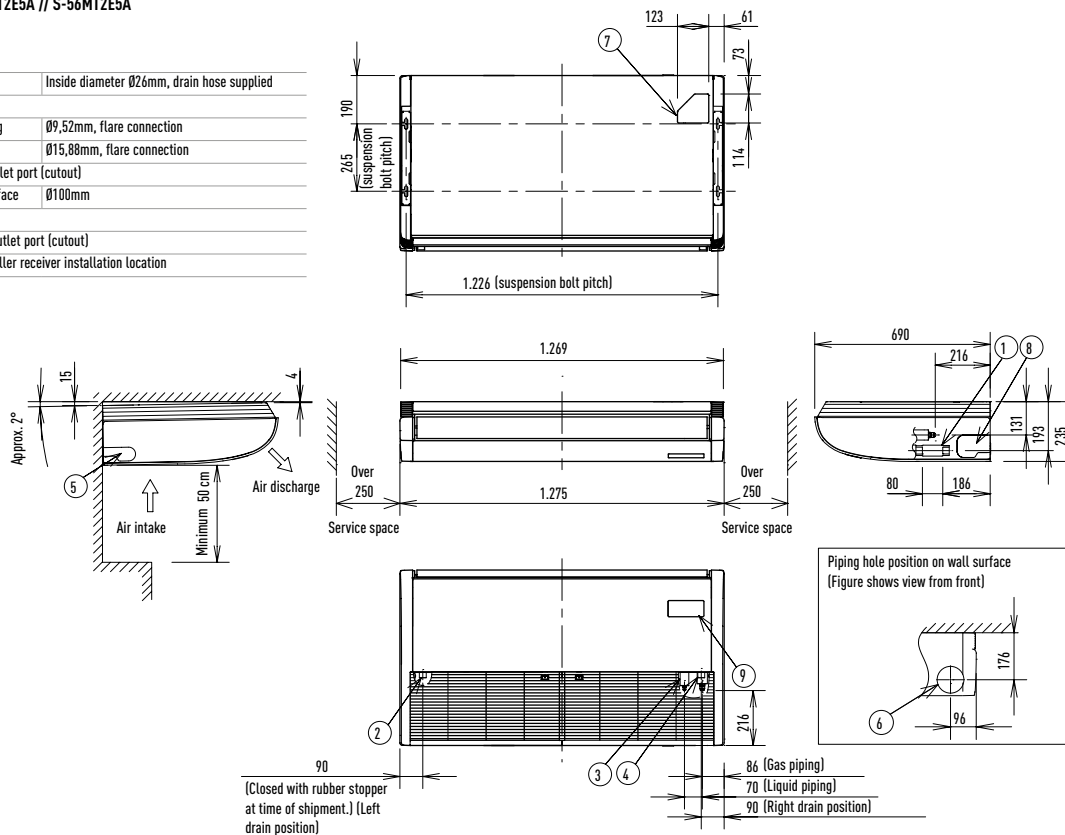

S-73MT2E5A // S-106MT2E5A // S-140MT2E5A

	A	B	C	D	E
106-140 type	1.590	235	690	1.584	1.541
140 type	1.275	235	690	1.269	1.226

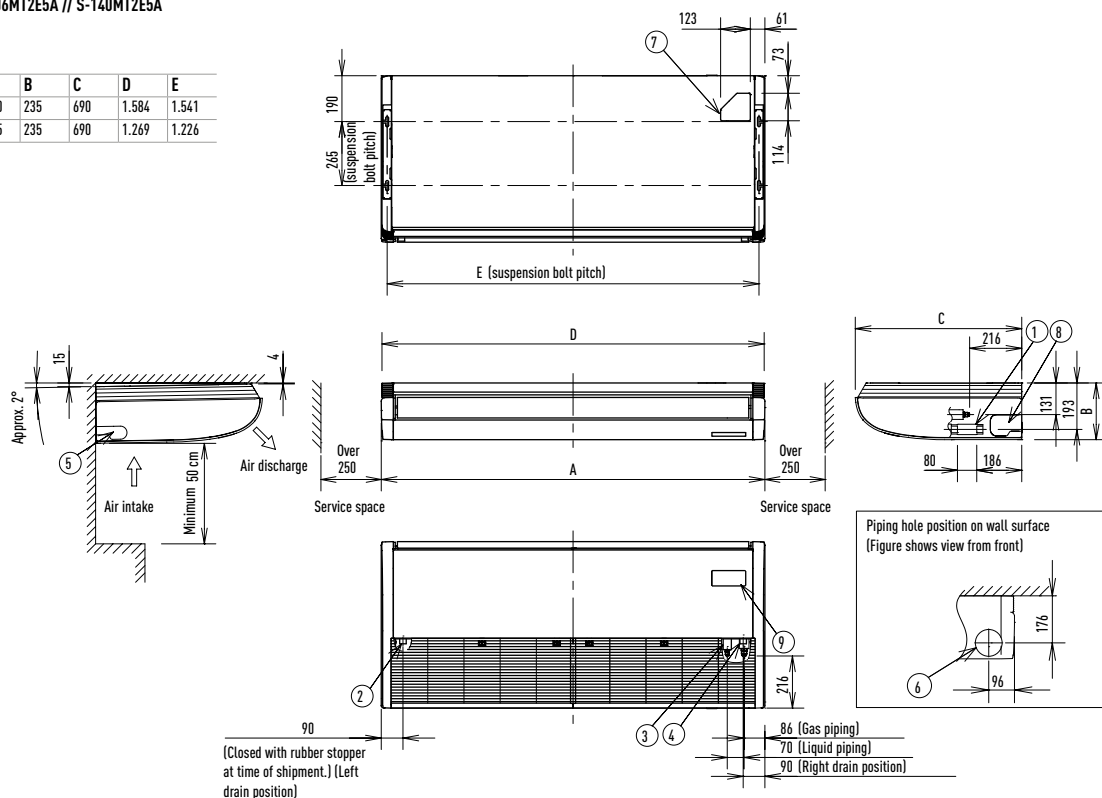

K2/K1 Type. Wall Mounted

S-15MK2E5A / S-22MK2E5A / S-28MK2E5A / S-36MK2E5A

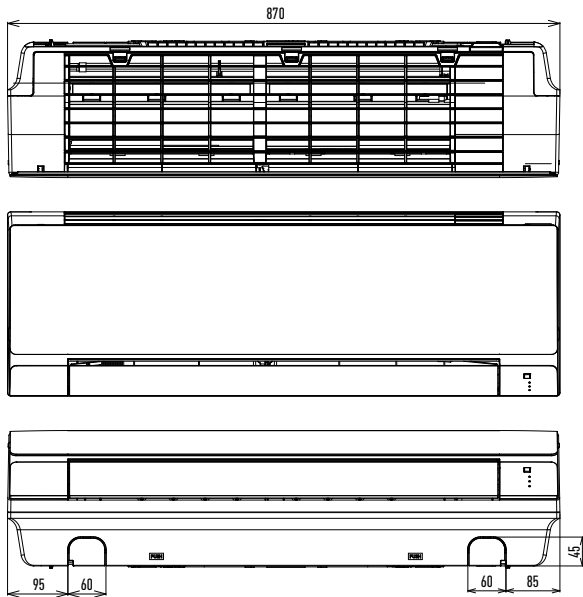

1	Refrigerant piping (liquid tube)	Ø6,35 (flared)
2	Drain hose	Outer diameter 16mm
3	Rear panel	PL Back
4	Refrigerant piping (gas tube)	Ø12,7 (flared)
5	Rear panel fixing holes	
6	Piping and wiring holes	Ø70

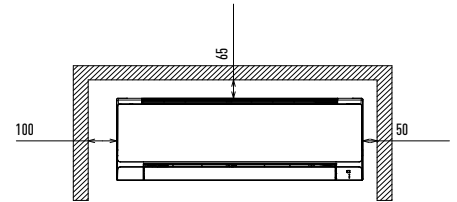
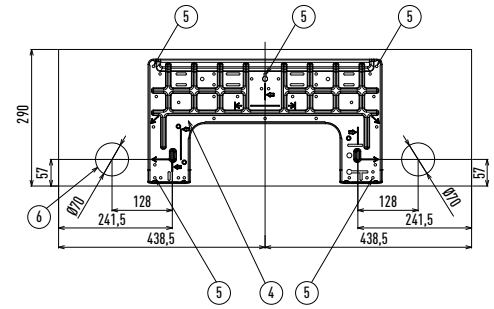
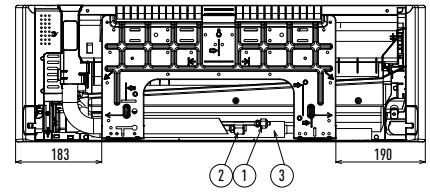

S-45MK1E5A / S-56MK1E5A / S-73MK1E5A / S-106MK1E5A

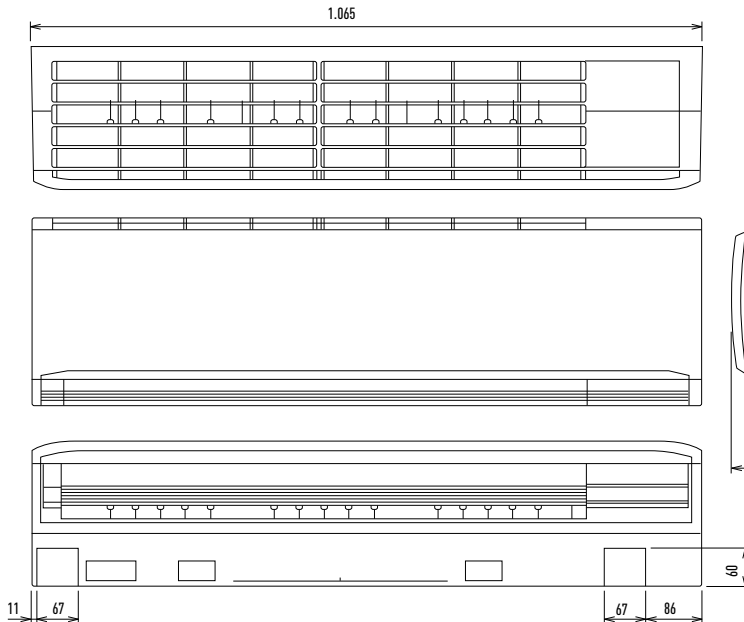

		45-56	73-106
1	Refrigerant piping (liquid tube)	Ø6,35 (flared)	Ø9,52 (flared)
2	Refrigerant piping (gas tube)	Ø12,7 (flared)	Ø15,88 (flared)
3	Drain hose VP13	Outer diameter 18mm	
4	Rear panel	PL BACK	
5	Piping and wiring holes	Ø80	

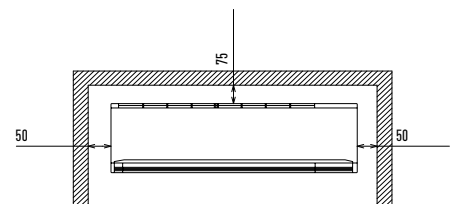
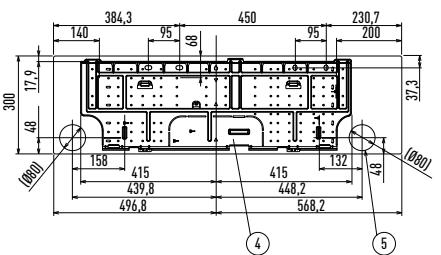
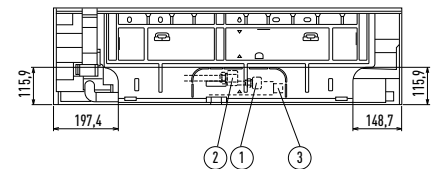

### P1 Type. Floor Standing

- 1 4-Ø12 hole (For fastening the indoor unit to the floor with screws.)
- 2 Air filter
- 3 Refrigerant connection outlet (liquid tube)
- 4 Refrigerant connection outlet (gas tube)
- 5 Level adjusting bolt
- 6 Drain outlet (20 A)
- 7 Power cord outlet (downward, rear)
- 8 Refrigerant piping outlet (downward, rear)
- 9 Location for mounting the remote controller (Remote controller can be attached within the room.)

	A	B	C	Liquid pipes	Gas pipes
22-36	1065	665	632	Ø6,35	Ø12,7
45					
56	1380	980	947		
71				Ø9,52	Ø15,88

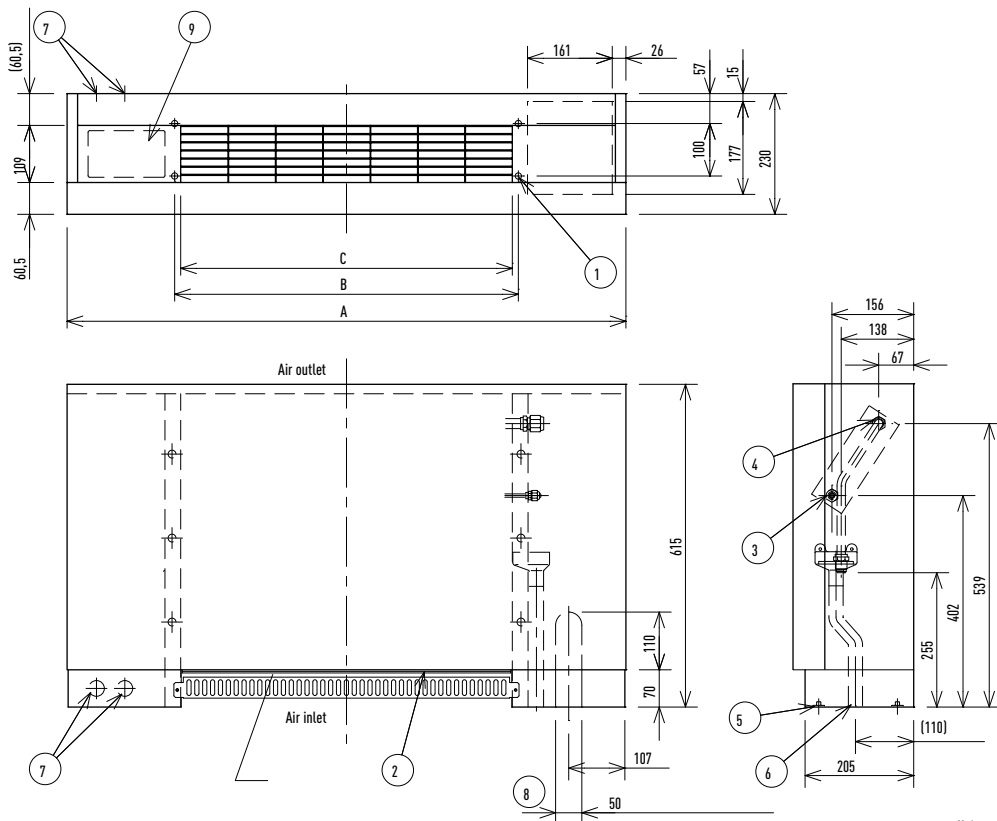

Unit: mm

### R1 Type. Concealed Floor Standing

- 1 4-Ø12 hole (For fastening the indoor unit to the floor with screws.)
- 2 Air filter
- 3 Refrigerant connection outlet (liquid tube)
- 4 Refrigerant connection outlet (gas tube)
- 5 Level adjusting bolt
- 6 Drain outlet (20 A)
- 7 Flange for the air-outlet duct

	A	B	C	D	E	F	Liquid pipes	Gas pipes
22-36	904	692	672	665	500	86	Ø6,35	Ø12,7
45								
56	1,219	1,007	1,002	980	900	51		
71							Ø9,52	Ø15,88

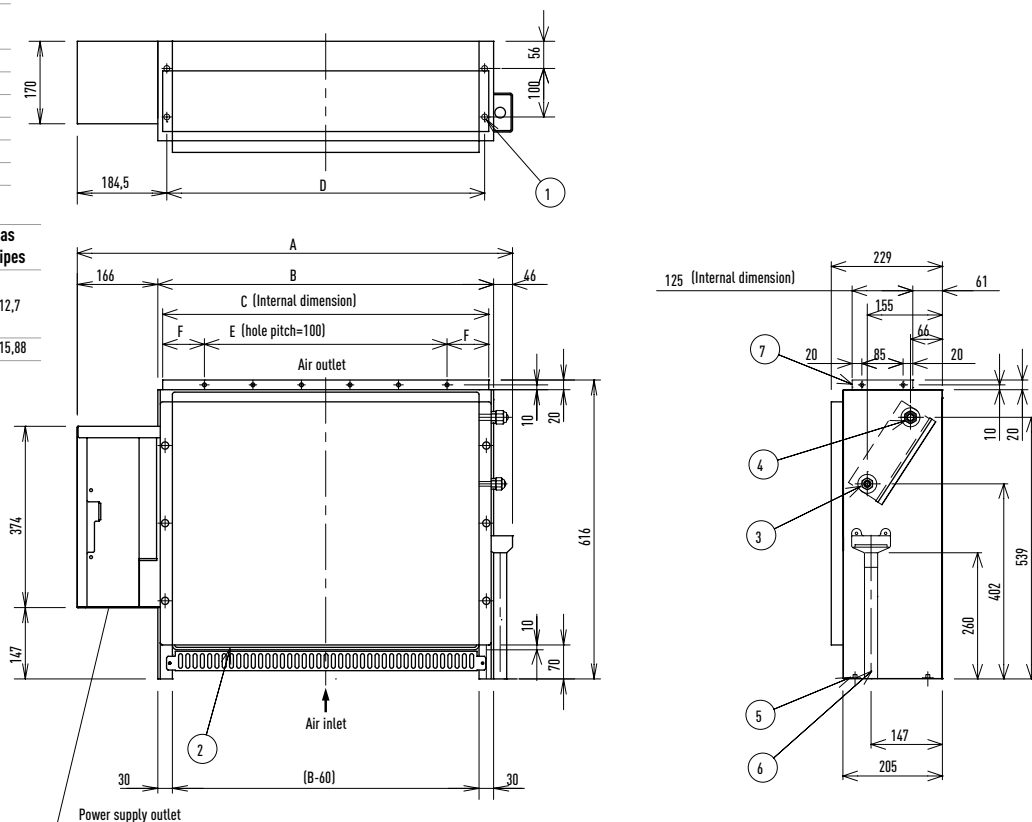

Unit: mm

AHU Connection Kit

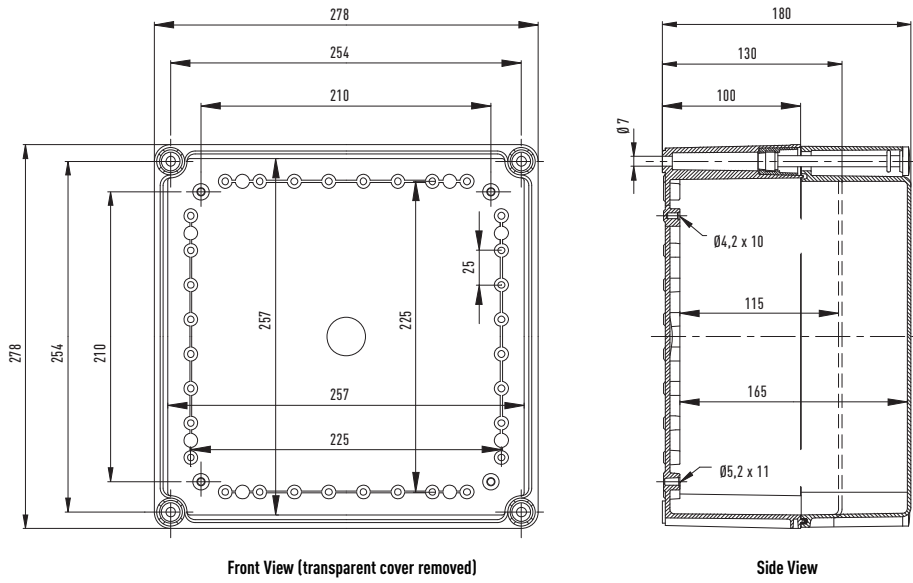

Unit: mm

Air Curtain with DX Coil

Jet-Flow dimensions

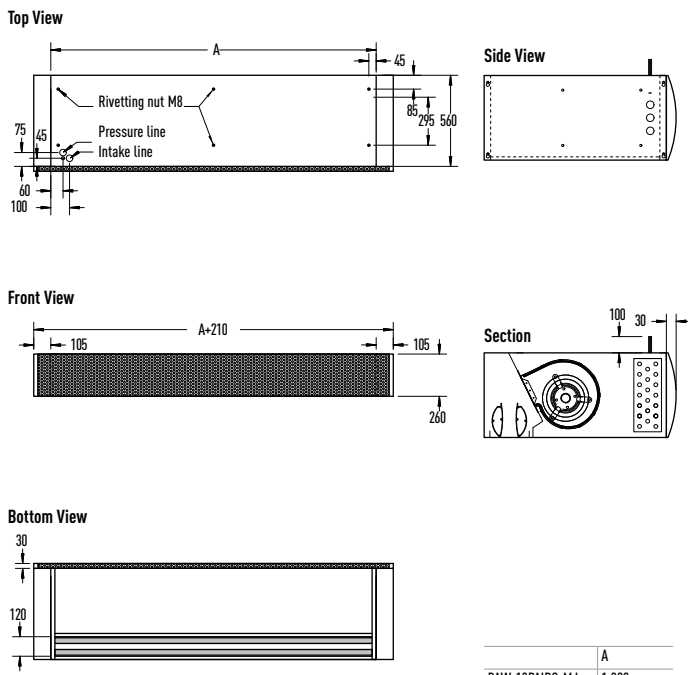

	A
PAW-10PAIRC-MJ	1.000
PAW-15PAIRC-MJ	1.500
PAW-20PAIRC-MJ	2.000
PAW-25EAIRC-MJ	2.500

Standard dimensions

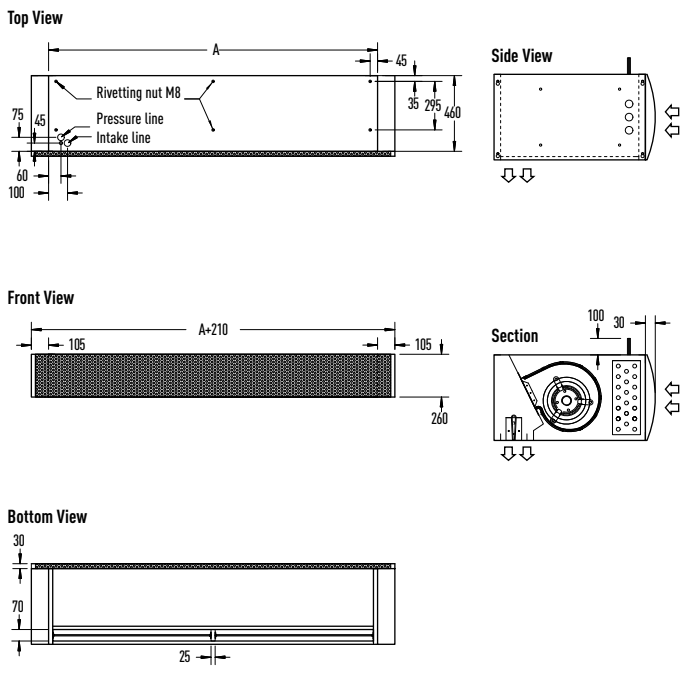

	A
PAW-10PAIRC-MS	1.000
PAW-20PAIRC-MS	2.000

Unit: mm



Energy Recovery Ventilation System

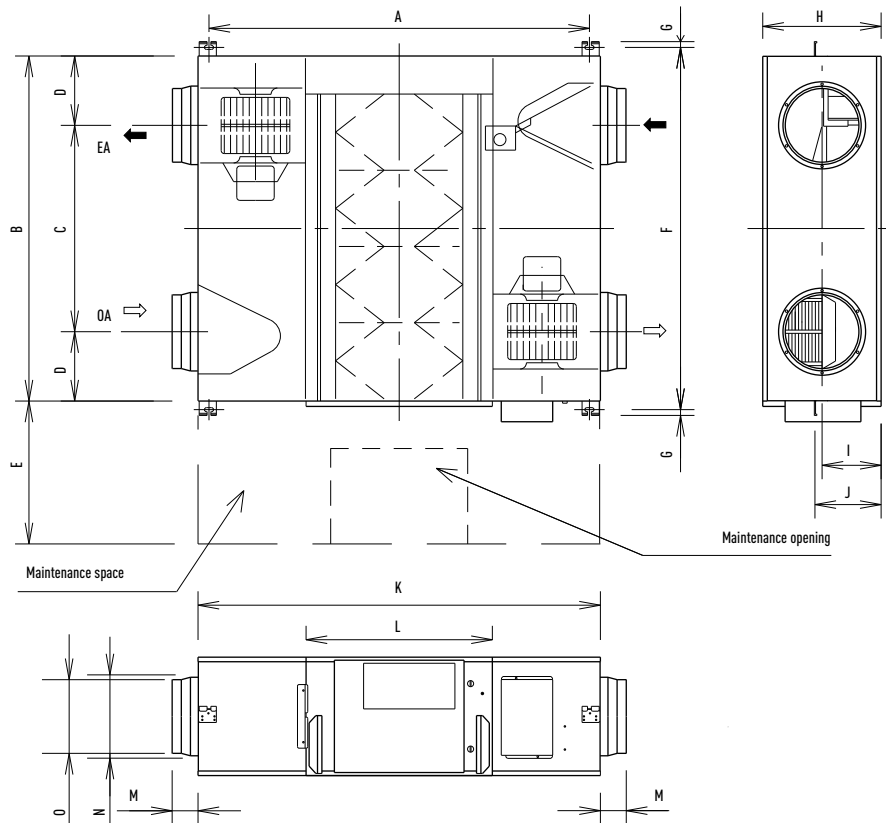

	FY-250ZDY8	FY-350ZDY8	FY-500ZDY8	FY-800ZDY8	FY-01KZDY8A
A	810	810	890	1.250	1.250
B	599	804	904	884	1.134
C	315	480	500	428	678
D	142	162	202	228	228
E	600	600	600	600	600
F	655	860	960	940	1.190
G	19	19	19	19	19
H	270	317	317	288	388
I	135	145	145	194	194
J	159	159	159	218	218
K	882	882	962	1.322	1.322
L	414	414	414	612	612
M	95	95	107	85	85
N	219	219	246	258	258
O	144	144	194	242	242

Unit: mm

# REFRIGERANT BRANCH PIPES FOR 2-PIPE ME2 SERIES

## Optional Distribution Joint Kits

See the installation instructions packaged with the distribution joint kit for the installation procedure.

\* In case the total capacity of indoor units connected after distribution exceeds the total capacity of the outdoor units, select the distribution piping size for the total capacity of the outdoor units.

Model name	Cooling capacity after distribution	Remarks
1. CZ-P680PJ2	68,0kW or less	For outdoor unit
2. CZ-P1350PJ2	More than 68,0kW	For outdoor unit
3. CZ-P160BK2	22,4kW or less*	For indoor unit
4. CZ-P680BK2	68,0kW or less*	For indoor unit
5. CZ-P1350BK2	More than 68,0kW*	For indoor unit

## Piping size (with thermal insulation)

### 1. CZ-P680PJ2

For outdoor unit (capacity after distribution joint is 68,0kW or less).

#### Gas piping

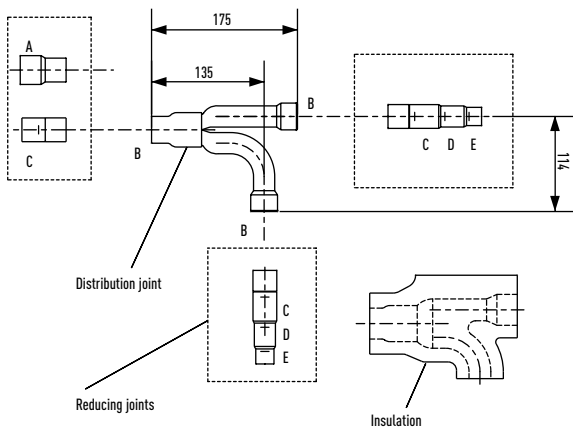

#### Liquid piping

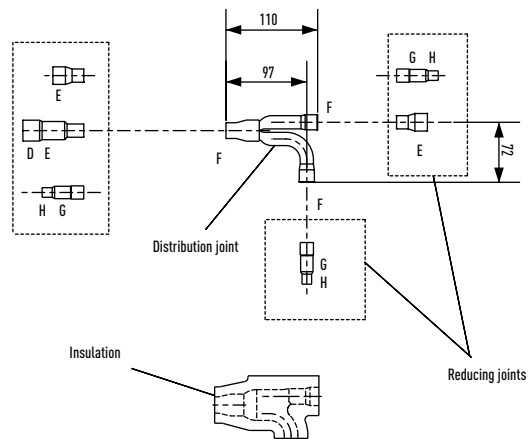

Unit: mm

### Size of connection point on each part (shown are inside diameters of piping)

Size	Part A	Part B	Part C	Part D	Part E	Part F	Part G	Part H	
Dimension	mm	31,75	28,58	25,40	22,22	19,05	15,88	12,70	9,52
	Inches	1-1/4	1-1/8	1	7/8	3/4	5/8	1/2	3/8

### 2. CZ-P1350PJ2

For outdoor unit (capacity after distribution joint is more than 68,0kW).

#### Gas piping

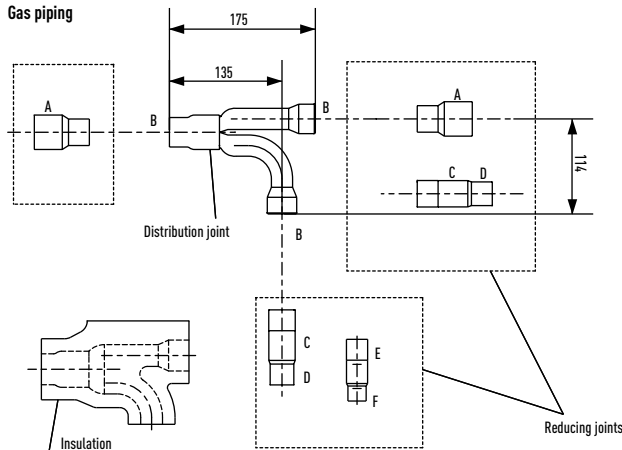

#### Liquid piping

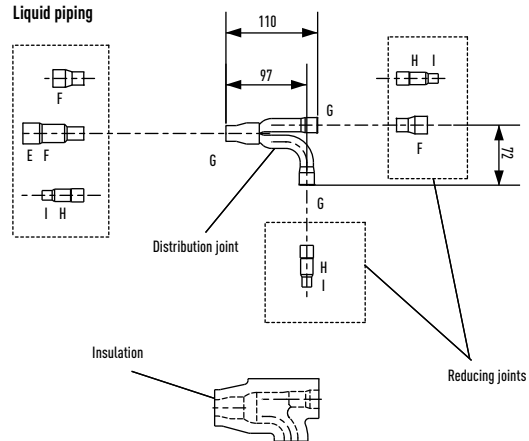

Unit: mm

### Size of connection point on each part (shown are inside diameters of piping)

Size	Part A	Part B	Part C	Part D	Part E	Part F	Part G	Part H	Part I	
Dimension	mm	38,10	31,75	28,58	25,40	22,22	19,05	15,88	12,70	9,52
	Inches	1-1/2	1-1/4	1-1/8	1	7/8	3/4	5/8	1/2	3/8

\* If the tube diameter is more than 38.1, use field-supply reducer.

### 3. CZ-P160BK2

Use: For indoor unit (Capacity after distribution joint is 22,4kW or less)\*.

Gas piping

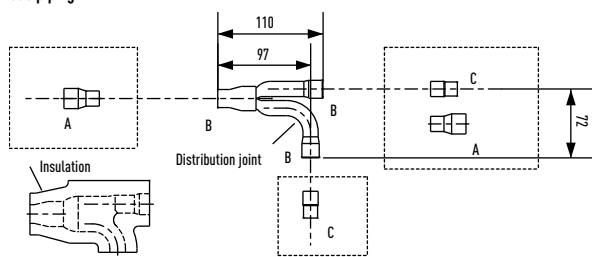

Liquid piping

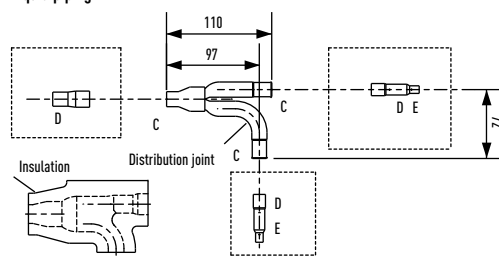

Unit: mm

Size of connection point on each part (shown are inside diameters of piping)

Size	Part A	Part B	Part C	Part D	Part E
Dimension	mm	19,05	15,88	12,70	9,52
	Inches	3/4	5/8	1/2	3/8

### 4. CZ-P680BK2

Use: For indoor unit (capacity after distribution joint is more than 22,4kW and no more than 68,0kW\*).

Gas piping

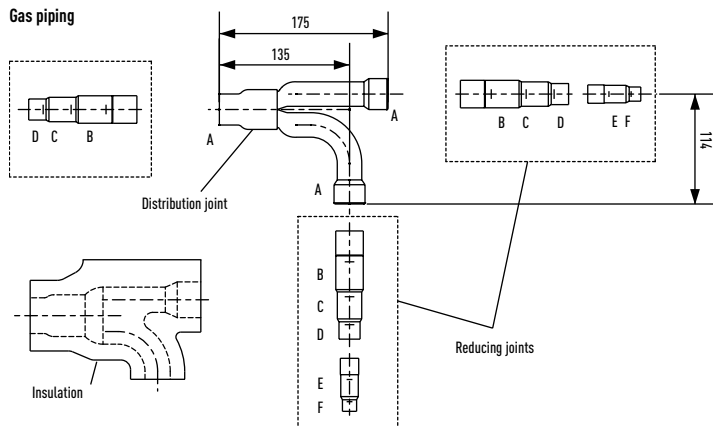

Liquid piping

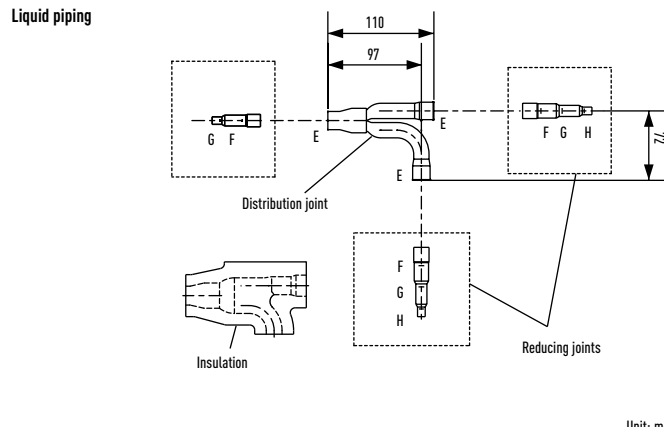

Unit: mm

Size of connection point on each part (shown are inside diameters of piping)

Size	Part A	Part B	Part C	Part D	Part E	Part F	Part G	Part H
Dimension	mm	28,58	25,40	22,22	19,05	15,88	12,70	9,52
	Inches	1-1/8	1	7/8	3/4	5/8	1/2	3/8

### 5. CZ-P1350BK2

Use: For indoor unit (capacity after distribution joint is more than 68,0kW\*).

Gas piping

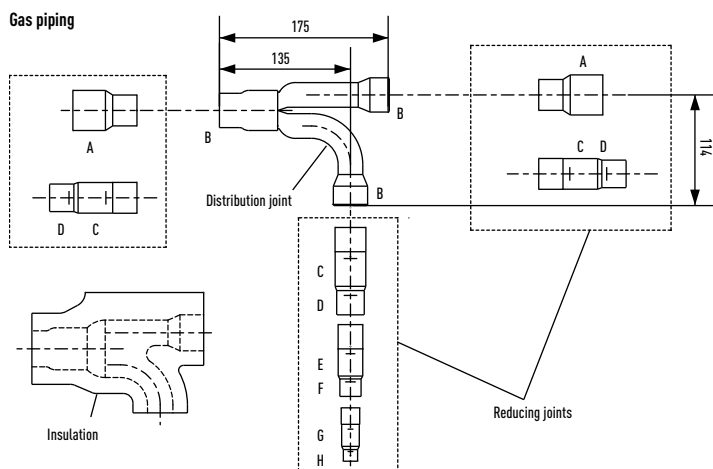

Liquid piping

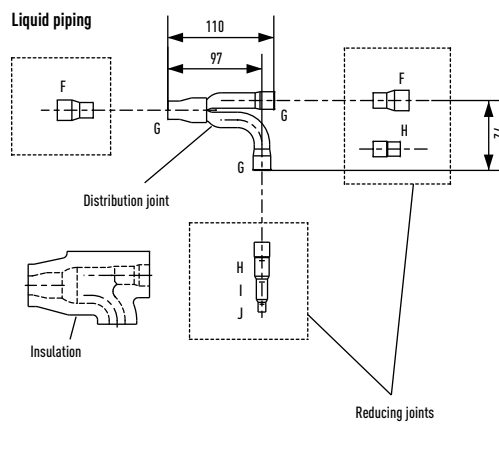

Unit: mm

Size of connection point on each part (shown are inside diameters of piping)

Size	Part A	Part B	Part C	Part D	Part E	Part F	Part G	Part H	Part I	Part J
Dimension	mm	38,10	31,75	28,58	25,40	22,22	19,05	15,88	12,70	9,52
	Inches	1-1/2	1-1/4	1-1/8	1	7/8	3/4	5/8	1/2	3/8

\* If the tube diameter is more than 38,1, use field-supply reducer.

\* In case the total capacity of indoor units connected after distribution exceeds the total capacity of the outdoor units, select the distribution piping size for the total capacity of the outdoor units.

# BRANCHES AND HEADERS FOR 3-PIPE ECOi AND MINI ECOi

## Optional distribution joint Kits for 3-Pipe ECOi 6N Systems (MF2)

See the installation instructions packaged with the distribution joint kit for the installation procedure.

\* In case the total capacity of indoor units connected after distribution exceeds the total capacity of the outdoor units, select the distribution piping size for the total capacity of the outdoor units.

Model name	Cooling capacity after distribution	Remarks
1. CZ-P680PJ2BM	68,0kW or less	For outdoor unit
2. CZ-P1350PJ2BM	Greater than 68,0kW and no more than 135,0kW	For outdoor unit
3. CZ-P224BH2BM	22,4kW or less	For indoor unit
4. CZ-P680BH2BM	Greater than 22,4kW and no more than 68,0kW	For indoor unit
5. CZ-P1350BH2BM	Greater than 68,0kW and no more than 135,0kW	For indoor unit

## Piping size for 3-Pipe ECOi 6N Systems (MF2)

### 1. CZ-P680PJ2BM

For outdoor unit side (capacity after distribution joint is 68,0kW or less).

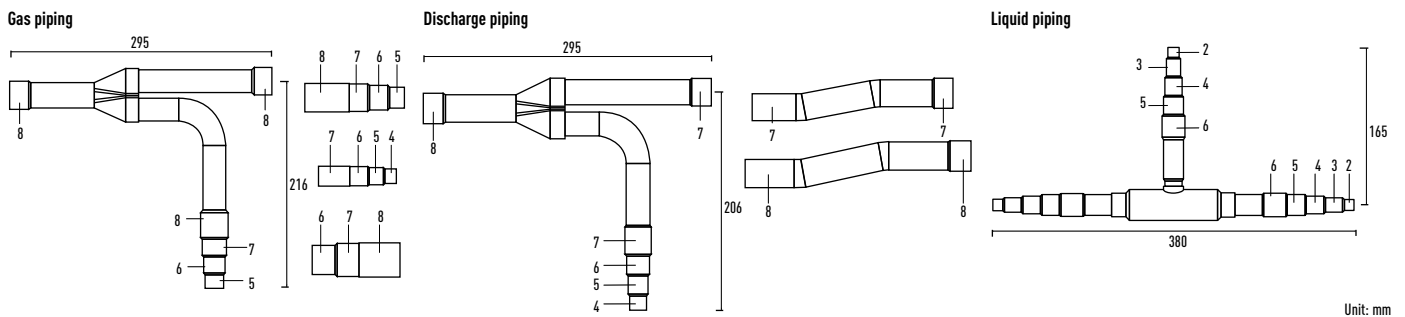

### 2. CZ-P1350PJ2BM

For outdoor unit side (capacity after distribution joint is greater than 68,0kW and no more than 135,0kW).

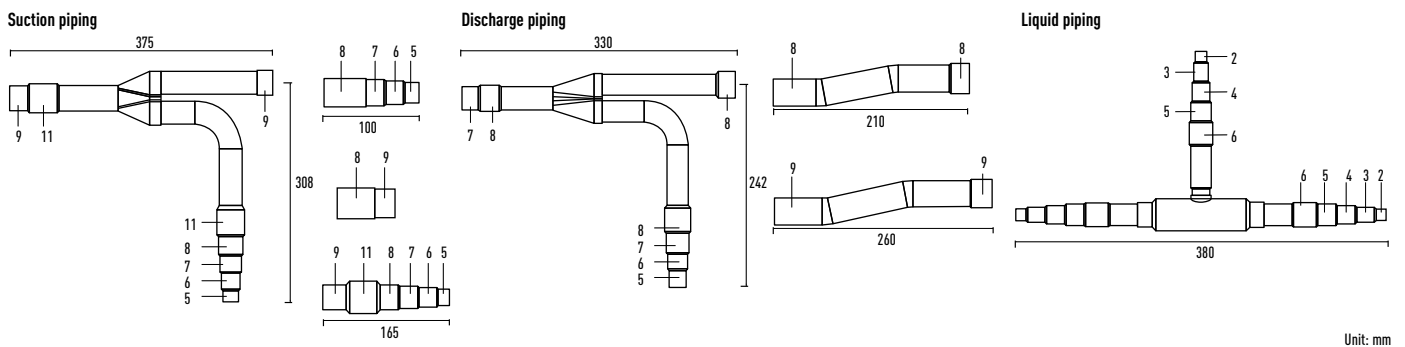

### 3. CZ-P224BH2BM

For indoor unit side (capacity after distribution joint is 22,4kW or less).

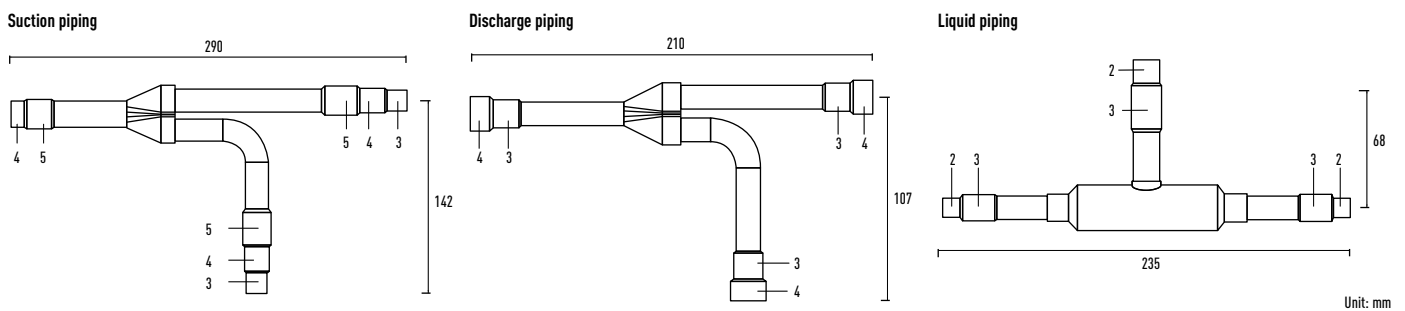

## Size of connection point on each part (shown are inside diameters of piping)

Size	Part 1	Part 2	Part 3	Part 4	Part 5	Part 6	Part 7	Part 8	Part 9	Part 10	Part 11	Part 12	Part 13	Part 14	
Dimension	mm	6,35	9,52	12,70	15,88	19,05	22,40	25,40	28,57	31,75	34,92	38,10	41,28	44,45	50,80
	Inches	1/4	3/8	1/2	5/8	3/4	7/8	1	1 1/8	1 1/4	13/8	11/2	15/8	13/4	2

### 4. CZ-P680BH2BM

For indoor unit side (capacity after distribution joint is greater than 22,4kW and no more than 68,0kW).

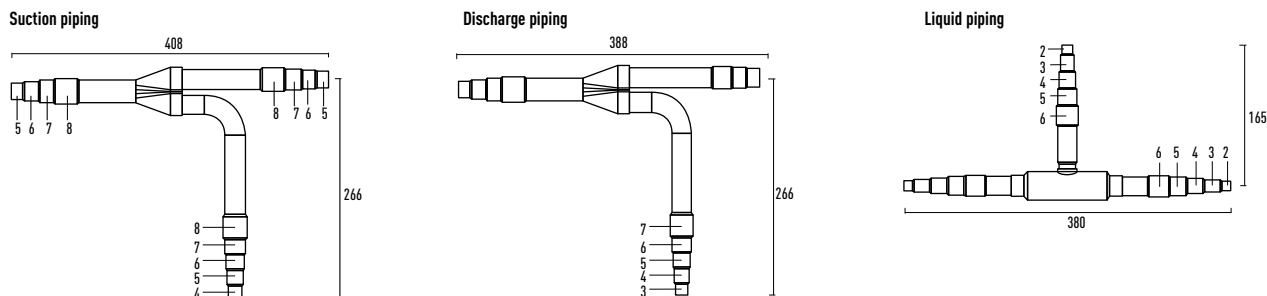

Unit: mm

### 5. CZ-P1350BH2BM

For indoor unit side (capacity after distribution joint is greater than 68,0kW and no more than 135,0kW).

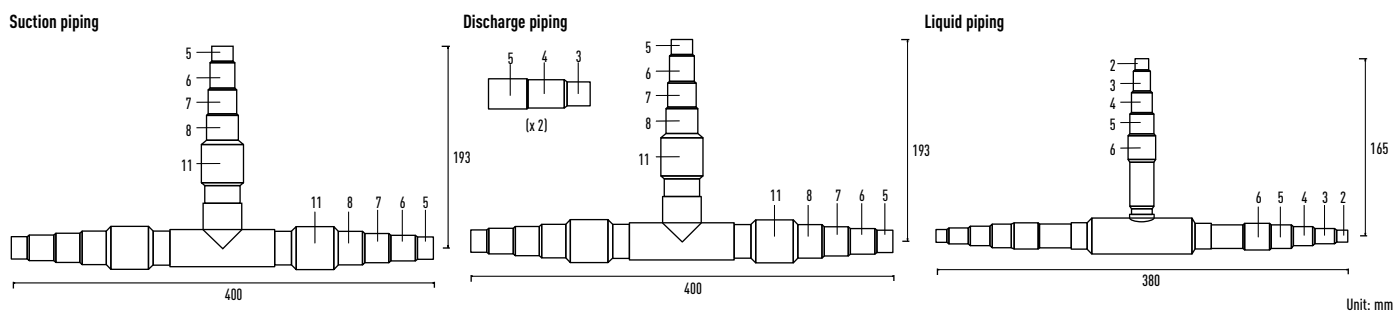

Unit: mm

### Header pipe set for 3-Pipe ECOi 6N Systems (MF2)

#### CZ-P4HP3C2BM

Header pipe model for 3-Pipe systems.

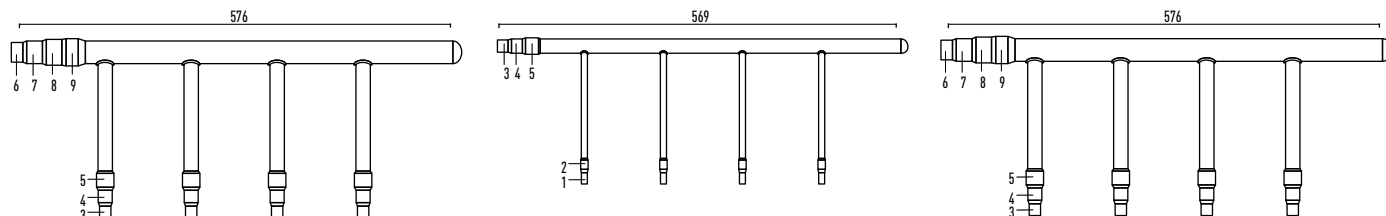

#### Size of connection point on each part (shown are inside diameters of piping)

Size	Part 1	Part 2	Part 3	Part 4	Part 5	Part 6	Part 7	Part 8	Part 9	Part 10	Part 11	
Dimension	mm	6,35	9,52	12,70	15,88	19,05	22,40	25,40	28,57	31,75	34,92	38,10
	Inches	1/4	3/8	1/2	5/8	3/4	7/8	1	1 1/8	1 1/4	13/8	11/2

### Distribution joint Kits for 2-Pipe Mini ECOi LE1 Series

#### CZ-P160BK2

For indoor unit (capacity after distribution joint is 22,4kW or less).

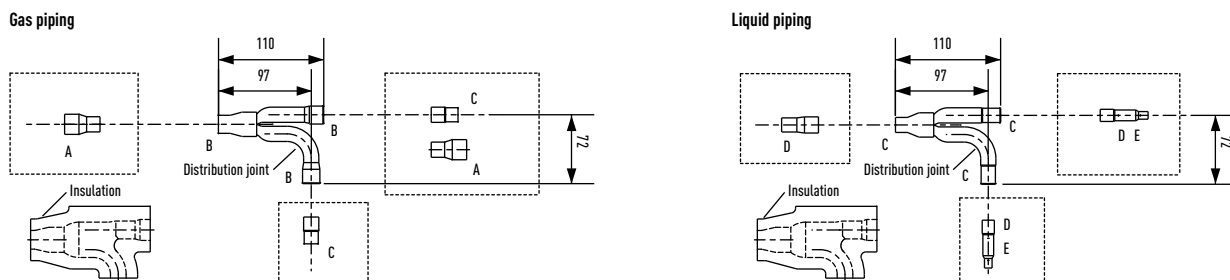

Unit: mm

#### Size of connection point on each part (shown are inside diameters of piping)

Size	Part A	Part B	Part C	Part D	Part E
Dimension	mm	19,05	15,88	12,70	9,52
	Inches	3/4	5/8	1/2	3/8
					1/4



PAW-RE2C3 Intelligent Controller

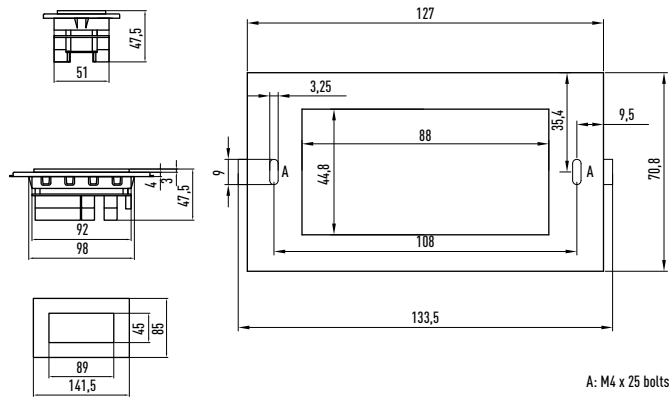

CZ-RTC4 Wired remote controller

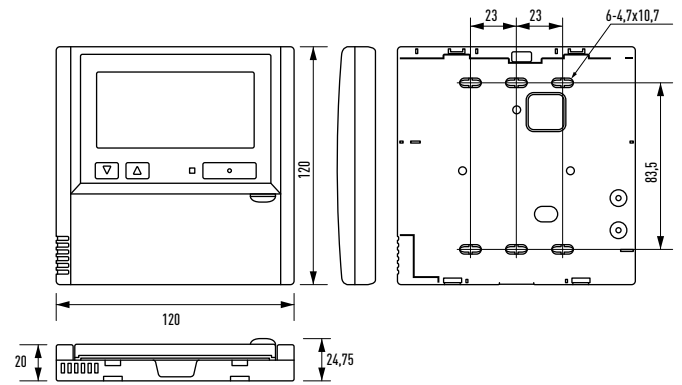

CZ-RTC5A Design wired remote controller

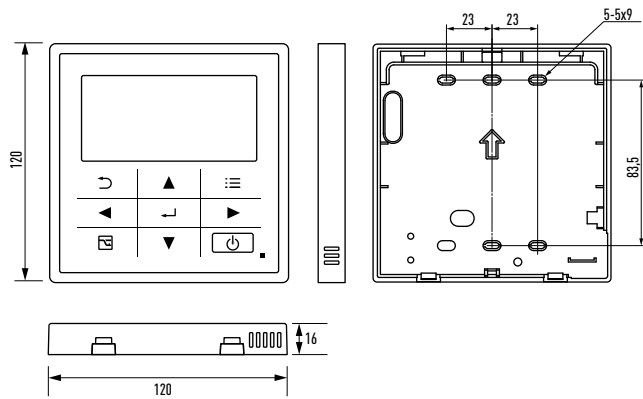

CZ-RTC2 Wired remote controller. Normal operation

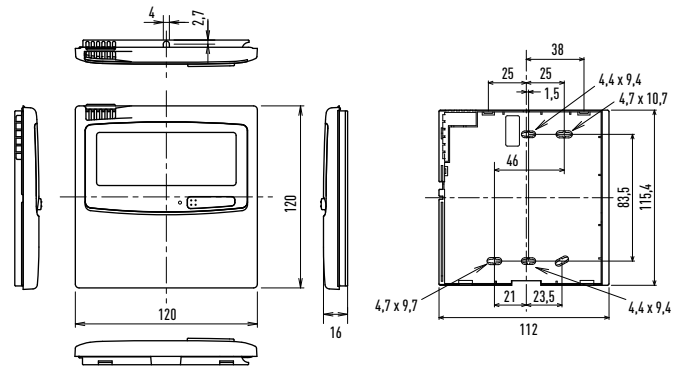

Wireless remote controller

CZ-RWSC3

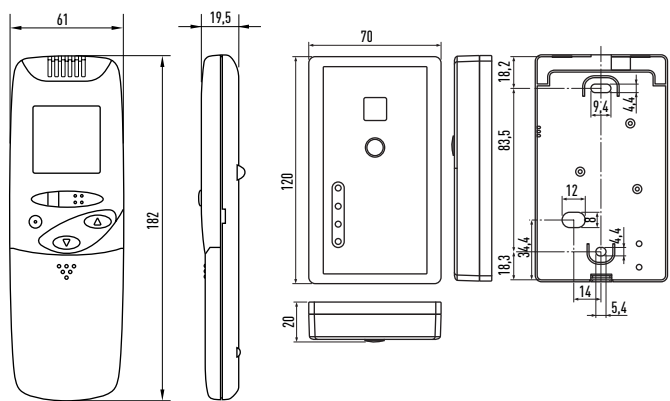

CZ-RE2C2 Simplified remote controller

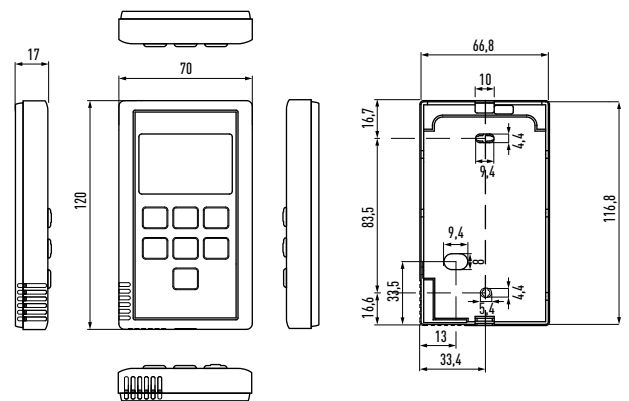

CZ-CSRC3 Remote sensor

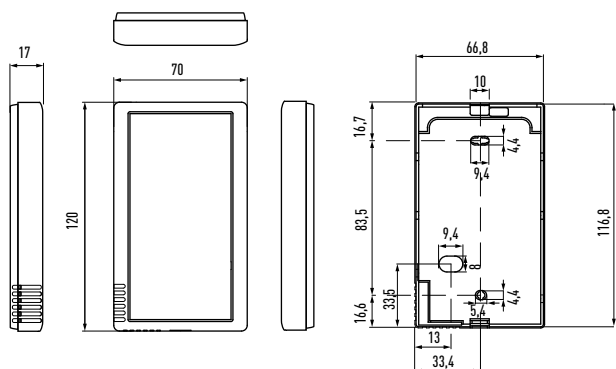

CZ-64ESMC3 System Controller with Schedule timer

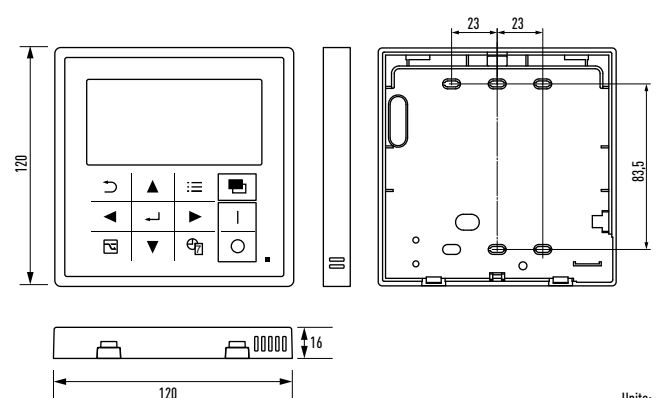

**CZ-ANC2 ON/OFF Controller**

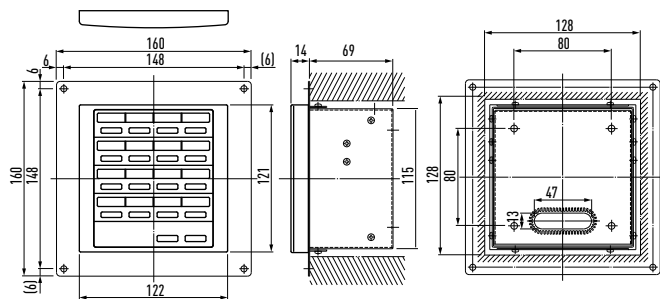

**CZ-256ESMC3 Intelligent Controller (Touch screen panel)**

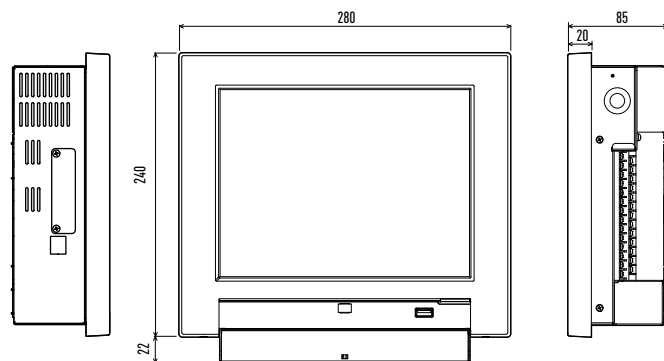

**CZ-CAPDC2 Seri-Para I/O unit for outdoor unit**

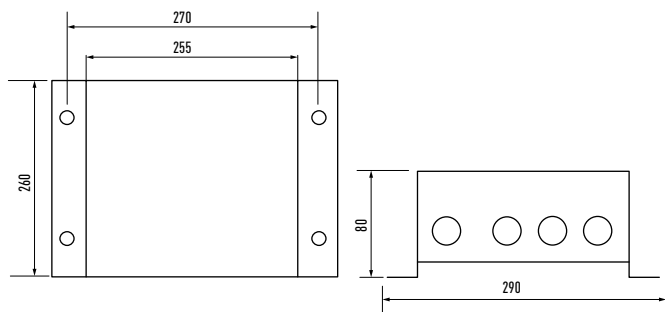

**CZ-CAPC2 Local adaptor for ON/OFF control**

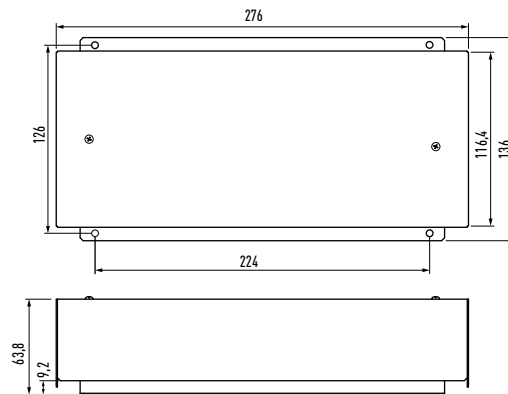

**CZ-CAPBC2 Mini Seri-Para I/O Unit 0 -10V**

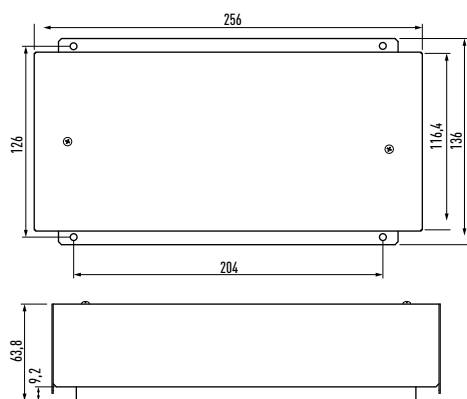

**CZ-CFUNC2 Communication Adaptor**

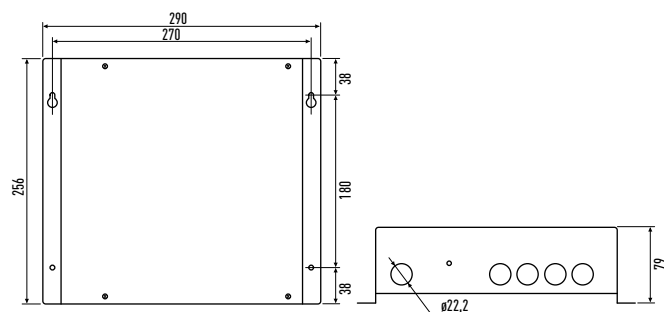

# CONTROL AND CONNECTIVITY

NEW CONTROL  
TECHNOLOGY  
**'17**



Panasonic has developed the largest range of control systems to offer the best option to each need.

From the individual remote control for the residential single units up to the newest technology to control each your buildings around the world from an easy to use software in the cloud by your portable device.



# CONNECT TO THE FUTURE. VRF SMART CONNECTIVITY

Life Is On



Through thorough energy management, Panasonic's VRF Smart Connectivity is a completely new, state-of-the-art solution providing energy saving and comfort as well as simple installation, operation and running.

Panasonic, passionately pursuing the ultimate in energy saving through the application of cutting-edge technology, and Schneider Electric, an advanced global energy management specialist offering innovative control systems. This collaboration has set the new standard for creating the next generation of contemporary buildings.

## VRF Smart Connectivity Advantages:

-  Easy Design and Plug and Play to Reduce CapEx
-  Dramatic Reduction of OpEx with Outstanding IAQ
-  Ultimate Customization
-  User-/Owner-friendly



VRF Smart Connectivity.  
The future of Control.

A remote controller is all that's required for occupancy control and optimum automatic indoor air quality (IAQ) control. Simple operation with a rented interface further contributes to increased energy efficiency and productivity for reduced capital expenditure (CapEx) and operating expense (OpEx).

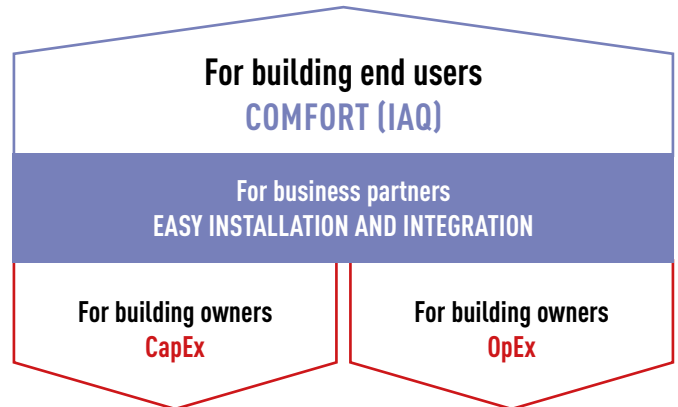

Extremely simple Plug and Play connection to a Building Energy Management System (BEMS) is possible. Compared to the current VRF systems and chillers of other companies, connection is smooth and stress-free, so there's considerably less burden on the system integrator.



**Easy Design and Plug and Play to Reduce CapEx.**

- Simple Plug & Play VRF connection to Building Energy Management System (BEMS)
- Stand alone or BEMS connected
- VRF indoor Wired or Wireless connection
- Plug and play additional ZigBee sensors



**Dramatic Reduction of OpEx with Outstanding IAQ.**

- 2 Built in sensors: Temperature and RH
- ZigBee wireless sensors: CO<sub>2</sub>, window/door, human presence.



**Ultimate Customization.**

- Background colour customisable
- Custom display/icons, messages
- Set point boundaries
- Programmable logic (also stand alone)



**User-/Owner-friendly.**

- Colour touch screen
- Ease and simply of use
- 20 Languages
- Easy to understand error description

# WHAT IS VRF CONNECTIVITY?

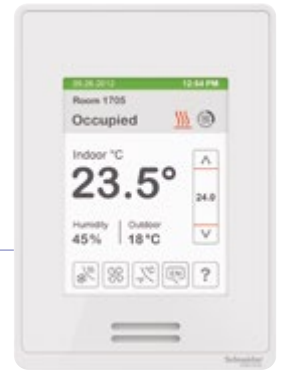

## Stand alone Smart Connection

VRF Smart connectivity connects Panasonic ECOi and PACi indoor units by wired or wireless connection.

### Wired Solution.

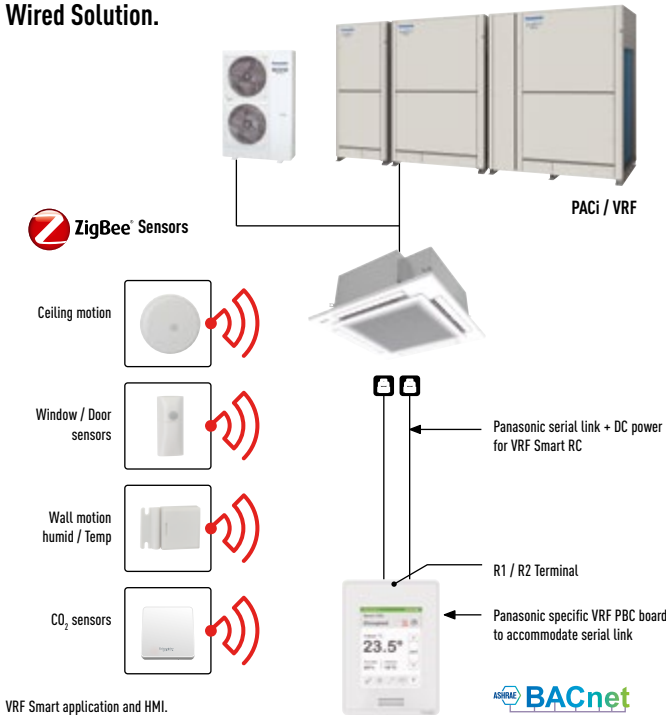

VRF Smart application and HMI.  
Powered over communication serial link.  
BACnet, Modbus, ZigBee.  
One RC to one VRF FCU.

### Wireless solution.

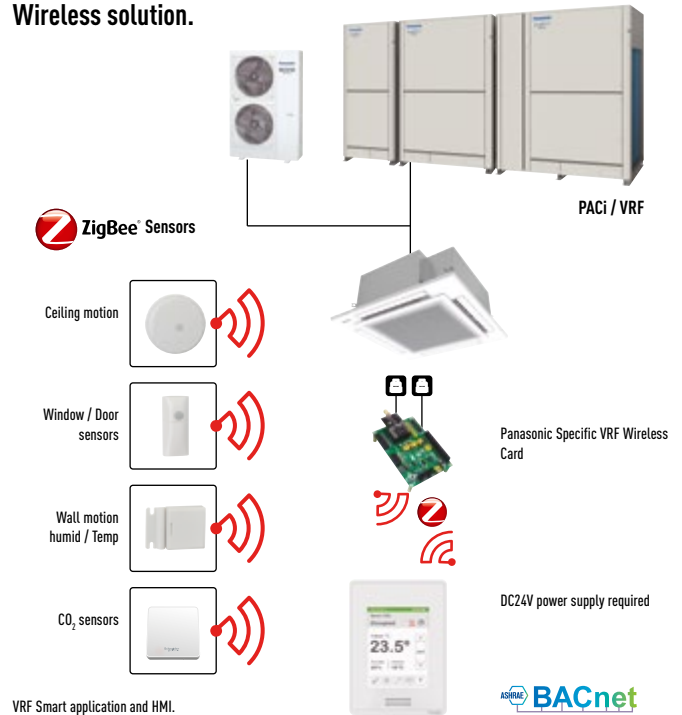

VRF Smart application and HMI.  
Normal Power Supply.  
BACnet, Modbus, ZigBee.  
One RC to one VRF FCU.

## Sensing Technology

The wireless solution using sensors born from the collaboration between Panasonic and Schneider Electric enables easy installation in existing and old buildings in which wiring is difficult (installation in a wired environment is also possible). The result is high-quality occupancy control and automatic IAQ control.

The sensors detect the presence or absence of occupants, and the opening and closing of doors and windows to achieve the most efficient energy management for exceptional air-conditioned comfort. Flexible installation is possible to match different applications and building features such as walls, ceilings and closeness to doors and windows. No wiring means extra installation versatility.

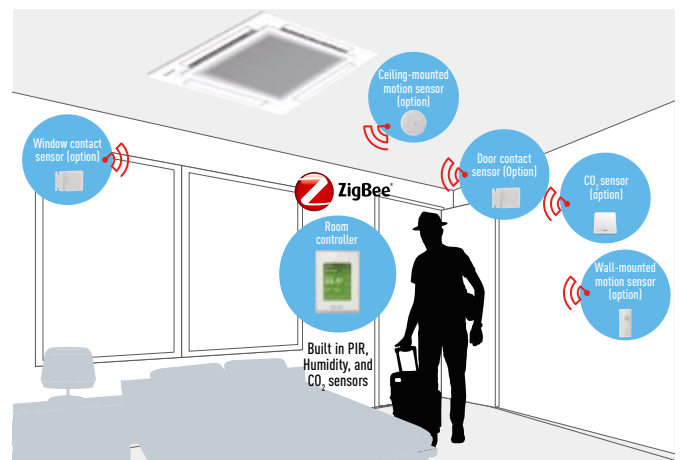

Batteries last for up to five years and are easy to install and replace.

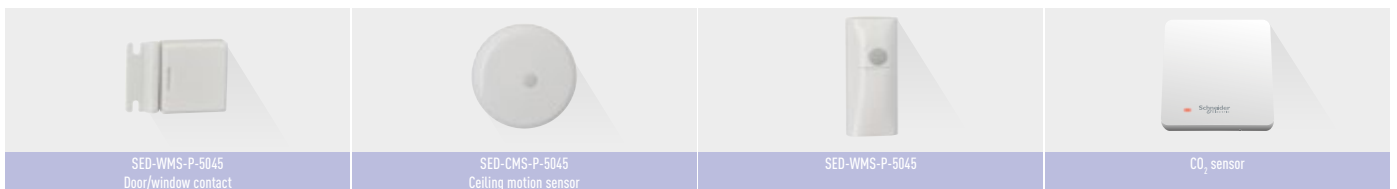

### BEMS Smart Connection

The Smarter solution to simplify energy management, optimize building efficiency and drive savings.

#### Plug and Play BEMS connection.

With Plug and Play, connection to a BEMS is extremely easy. Better still, a remote controller is all that's needed to enable use as a stand-alone system. As well as dramatically reducing the burden on system integrators, this cuts costs.

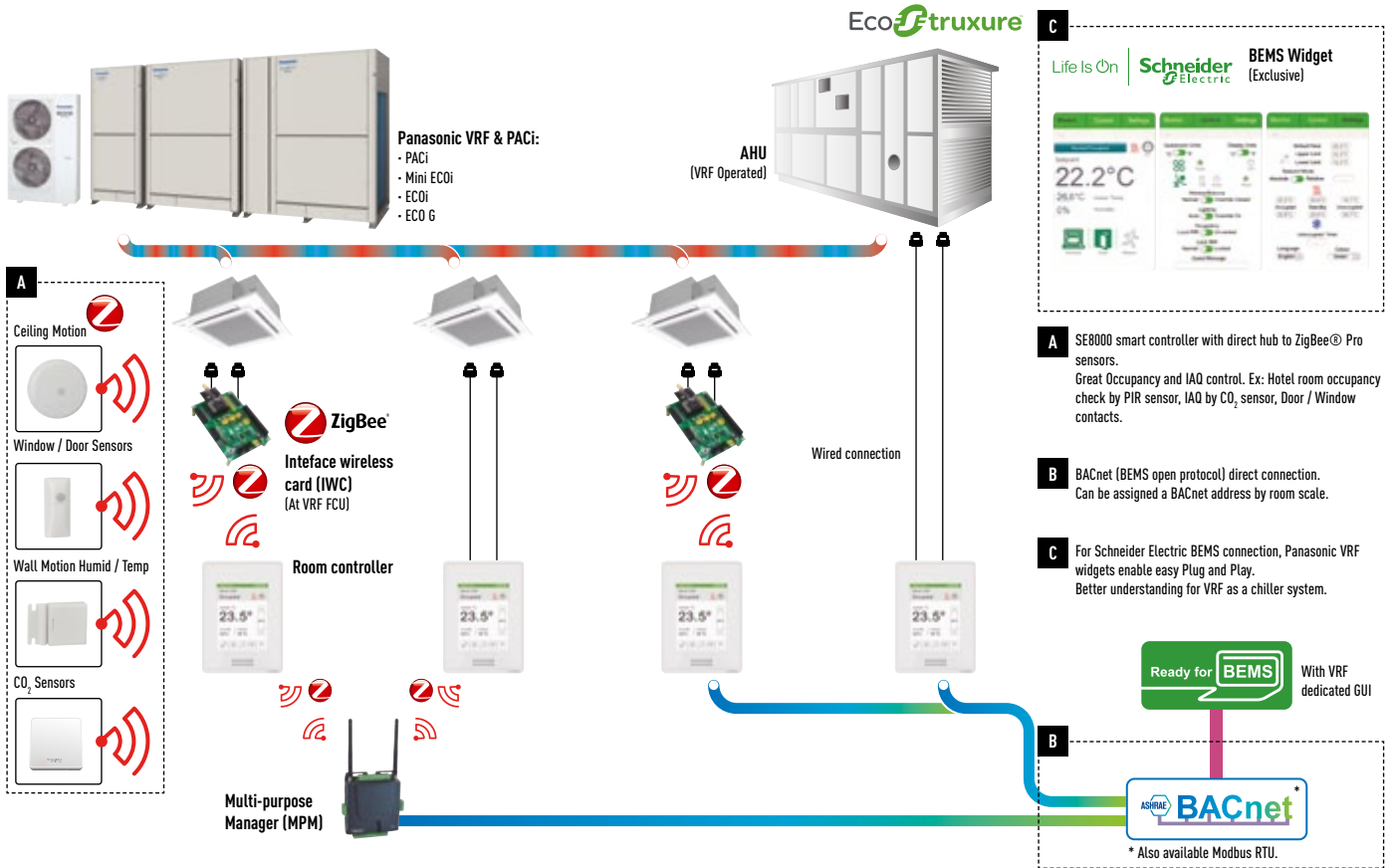

- A** SE8000 smart controller with direct hub to ZigBee® Pro sensors. Great Occupancy and IAQ control. Ex: Hotel room occupancy check by PIR sensor, IAQ by CO<sub>2</sub> sensor, Door / Window contacts.
- B** BACnet (BEMS open protocol) direct connection. Can be assigned a BACnet address by room scale.
- C** For Schneider Electric BEMS connection, Panasonic VRF widgets enable easy Plug and Play. Better understanding for VRF as a chiller system.

### BEMS conventional system vs VRF Smart Connectivity

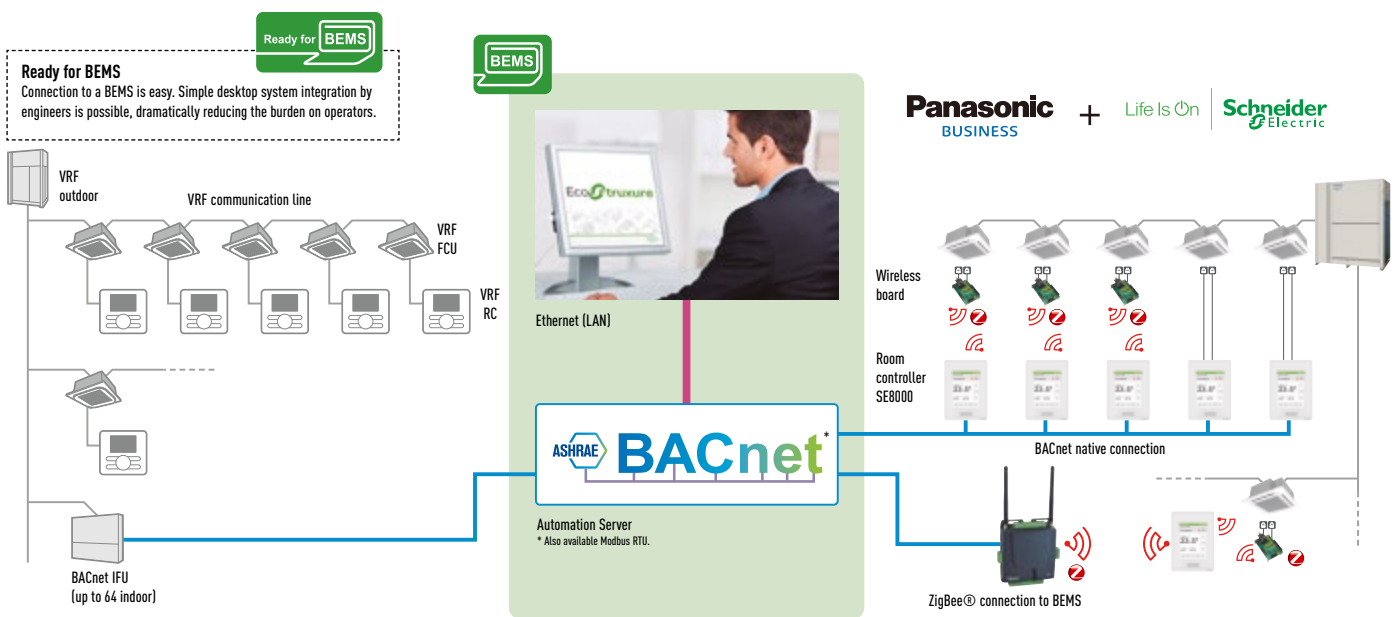

	Conventional	VRF Smart Connectivity	Advantage
<b>Hardware connection</b>	Need 2 Hardware CZ-CFUNC1 + BMS I/F	Required BACnet objects manual Wired/wireless)	CapEx: Saving interfaces
<b>Integration</b>	Manual system integration per indoor	Advanced plug & play connection	CapEx: Integrator time
	Required BACnet objects manual	Advanced plug & play connection	CapEx: Integrator time / OpEx: Full Integration of VRF signals

# INNOVATIVE AND UNRIVALLED ADVANTAGES

## Stand alone Smart Connection VRF.

### CO<sub>2</sub> and humidity sensors for high IAQ

CO<sub>2</sub> sensors taking measurements in units of ppm, and humidity sensors enable fine air quality control. This creates the most comfortable space for occupants while contributing to improved employee satisfaction.



### VRF / PACi wireless connection

Layout is extremely important because it decides how members of staff spend their time and work in an office. Until now, changing the layout of an office was difficult because of the complicated wiring involved, but with wireless VRF / PACi connection it's no trouble at all and more flexible layout is possible.



### Energy management for high return on investment (ROI)

Avoid the huge costs that occur when the control of air conditioning is left to staff with a tailor-made solution. Automatically controlled operation with precise settings reduces both wasted energy and running costs. This in turn contributes to improved ROI which is directly linked to management.

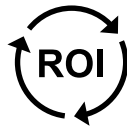

### Colour and design to match office interiors

When creating an office environment, a stylish appearance that complements the design of the office rather than interfering with it is an important consideration. Colour combinations and design can be set to match different facilities.

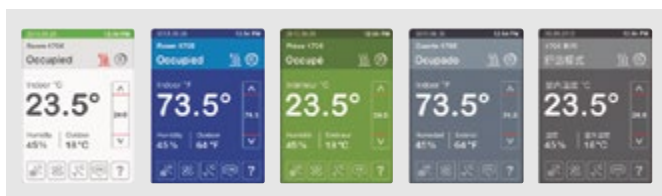

### Installation possible during business hours without closing the store

To install a new system, it was previously necessary to close stores and restaurants. Now, thanks to Panasonic's wireless technology, smart installation is possible without closing an establishment or performing building work such as knocking down walls. And the enjoyment of customers isn't interrupted.

### Easy-to-understand Error Description

Error description during an emergency is easy to understand, enabling staff to respond quickly. By eliminating the wasted cost of calling a service person every time there's a problem, this reduces total annual maintenance costs.



Guest room Management solutions for hotels.  
Deliver exceptional guest satisfaction while optimizing energy and operational efficiency.

**Customization in approx. 20 languages possible**

The display can be customized to match the native languages of guests to enable smooth, stress-free communication for hospitality at its finest.



**Occupancy sensors enabling automatic control for outstanding efficiency**

Sensors in the room and on the controller detect the presence or absence of occupants and the opening and closing of windows and doors. While maintaining the optimum air-conditioned environment guests expect, automatic control ensures the most efficient operation when they are away or when windows are open. This contributes to an appreciable reduction in operation costs.

**A truly comfortable experience for guests**

Easy-to-understand, refined on-screen images enable display of hotel logos and original welcoming messages. Colour and design can also be customized for different facilities to create an even more comfortable environment for guests.



**VRF Smart Connectivity Devices**

2 types of devices depending on type connection with indoor units wireless or wired.  
Wireless connection to indoor unit requires ZigBee interface for indoor unit.



Remote Controller Part Number	Description
SER8150A0B1194P	Panasonic Net Con, RH, No PIR, ZigBee®
SER8150A5B1194P	Panasonic Net Con, RH, PIR, ZigBee®
SER8150R0B1194	Panasonic Net Con, RH, No PIR, R1/R2
SER8150R5B1194	Panasonic Net Con, RH, PIR, R1/R2
Interface Part Number	Description
VCM8000R5094	Panasonic R1/R2 to ZigBee® I/F
Sensor Part Number	Description
SED-WMS-P-5045	SED SEN OCC WALL ZP
SED-WDS-P-5045	SED SW DOR/WIN ZP
SED-CMS-P-5045	SED SEN OCC CEIL ZP

**Features**

- Up to 5-year battery life, batteries included
- Battery level is a point
- Sensor points visible in SBO when SE8000 is integrated via BACnet MS/TP
- Sensor status and battery level visible in SBE when SE8000 is integrated via ZigBee® Pro
- Integration to SBE only recommended when each MPM is connected to Ethernet and are set as ZigBee® Coordinator nodes



# PANASONIC AC SMART CLOUD





**Flexible solution and scalable solution**

- Energy saving
- Zero downtime
- Site(s) management

Centralize control of your business premises, from wherever you are, 24/7/365. It doesn't matter how many sites you have, or where they are! The AC Smart Cloud system from Panasonic allows you to have complete control of all your installations, from your tablet or from your computer. In a simple click, all your units from several locations, receive status updates in real-time of all your installations, preventing breakdowns and optimizing costs.

With Panasonic AC Smart Cloud, have your business under control, and start saving!

**Flexible solution for your business.**

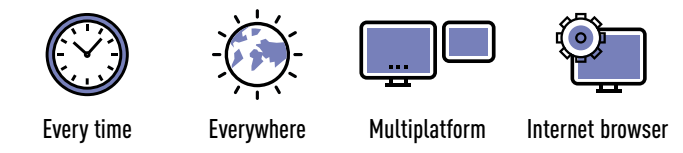

**Scalable solution for your business.**

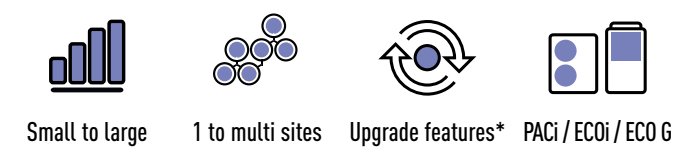

\*Customized to meet user demand / Upgraded new functions / Upgraded by new products / IT smart management.

**Key functions and uniqueness**

**Multi site monitoring.**

- It doesn't matter how many sites you have, easy to manage, operate, compare per sites, locations, rooms.



**Schedule setting.**

- Weekly / holiday timer setting as you want
- One setting can be copied to other sites



**User customization.**

Site administrator can create users as desired and assign customized profiles.

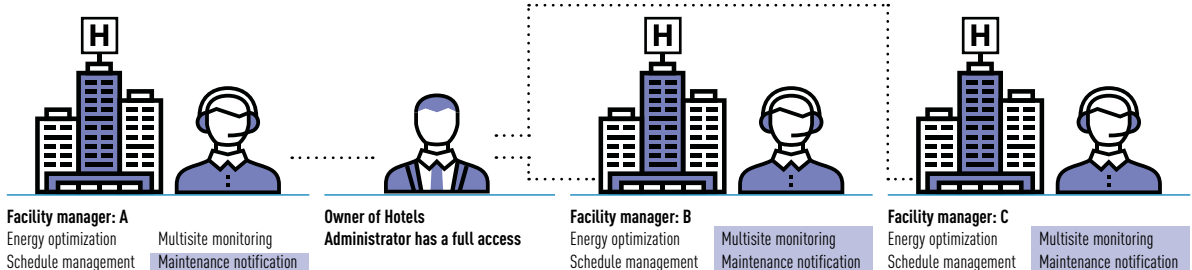

**Powerful statistics for energy savings.**

- Power consumption, capacity, efficiency level can be compared per different parameters (Yearly / monthly / weekly / daily bases)



**Maintenance notification.**

- Error notification by email and with floor layout
- Maintenance notification of ECOi / ECO G outdoor units



**One of our uniqueness is "Stable and secured communication package"**

- Connectivity is included in the service. Customers do not have to take time to find and prepare suitable connectivity.
- With an all inclusive service offering, the customer has peace of mind and a one stop shop for all AC Smart Cloud issues they may face including connectivity



3G router

SIM card

# REMOTE CONTROLLER WITH ECONAVI

NEW  
TECHNOLOGY  
**'17**



Easy to use, attractive, clear design, with new demand control functions and energy consumption display! This useful feature makes this remote control unique!

**Design**

The new CZ-RTC5A wired remote control is ideal for integration into the most demanding interior architectures. The touch panel features a very sleek and easy to use display, which with its compact display is only 120 x 120 x 16mm.

**Display of information**

The information is mainly based on pictograms to ensure easy understanding. The minimal amount of text is available in 5 languages (English / German / French / Spanish / Italian). The screen is back lit to enable reading even during the night.

**Easy Access to the menus.**

With the new pictograms, the navigation, the selection and the settings are simple and easy to follow.

**Key Functions**

- Easy setup of the timer and settings of the indoor unit
- Energy consumption display (only available with PACi units with the reference ending with A)
- Limitation of the energy consumption (Demand control) by timer.

**Basic function (Operation display & indication)**

All functions are easily available on the remote controller.

- OFF/ON timer • Weekly timer • Quiet operation • Remote control sensor • Operation prohibit • Filter sign • Energy saving • Centralized control indication • Mode change prohibit • Automatic temperature return • Temperature range limitation • OFF remind • Schedule demand control • Ventilation • Out Function

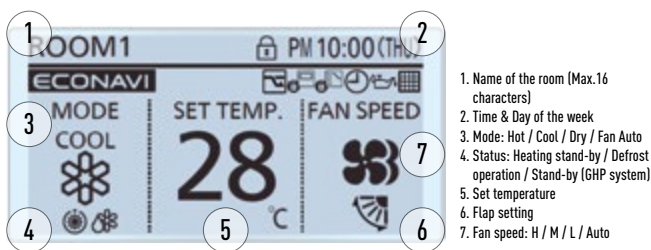

**Easy operation and quick access to all menus**

1. Set temperature will be selected, when any arrow button is touched
2. Select the item (Mode or Fan speed) by left/right ◀▶ key
3. Change the setting by up/down ▲▼ key



**Backup control by using CZ-RTC5A**

Group wiring of 2 systems of PACi can do auto individual control.

- Rotation operation
- Backup operation
- Support operation

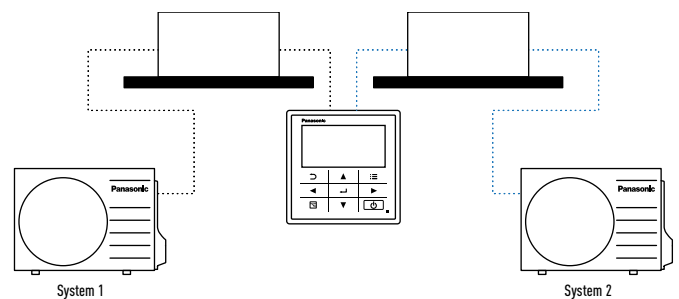

**Example of easy access to the functions: Air direction setting**

1. Select "Air direction" and press "determine" key
2. Select the unit number by up/down key
3. Select the flap position by up/down key
4. Press "Return" key to go back the Menu display

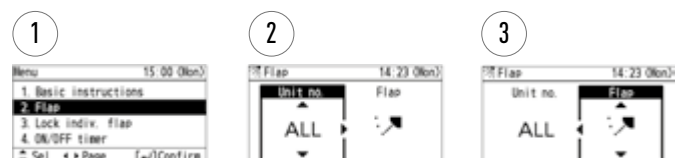

**Functions available on the CZ-RTC5A**

Control item	Controllability	Indoor Units		
		PACi Standard	PACi Elite	All VRF
Basic Operation	Operation, Mode, Temperature setting, Airflow volume, Airflow direction	✓	✓	✓
	Time display	✓	✓	✓
Timer function	Easy ON/OFF timer	✓	✓	✓
	Weekly Program timer	✓	✓	✓
Energy saving	Outing function	✓	✓	✓
	Temperature auto return	✓	✓	✓
	Temperature setting range limitation	✓	✓	✓
	OFF remind	✓	✓	✓
	Energy saving mode	✓	✓	✓
	Schedule demand control	—	✓	✓
	Energy monitoring	—	✓	—
Maintenance	System failure information	—	✓	—
	Service contact registration	✓	✓	✓
	Filter sign (rest time display) & Reset	✓	✓	✓
	Auto-address, Test run	✓	✓	✓
	Sensor value monitor	✓	✓	✓
Others	Simple / Detail setting mode	✓	✓	✓
	Key lock	✓	✓	✓
	Ventilation fan control	✓	✓	✓
	Display contrast adjustment	✓	✓	✓
	Remote controller sensor	✓	✓	✓
	Quiet operation mode	—	✓	—
Prohibit setting control from Central controller	✓	✓	✓	

All specifications subject to change without notice.



# ECONAVI SENSOR





The all new Econavi Sensor detects presence in the room, and quietly adapts the PACi or VRF air conditioning system in order to improve comfort and maximise energy savings.

- Detects human activity and adjusts temperature by 2 degrees (up or down) to optimize comfort and efficiency
- If there is no activity detected for a set time, the Econavi will stop the unit or move to a new temperature previously set
- The Econavi device is installed independently of the indoor unit, and is located in the area best suited for detection

**Applications**

**Saving Energy for Offices:** if the air conditioning is left on after the last employee leaves the office, Econavi will automatically react, reducing or stopping the system.  
**Increased comfort in hotel rooms:** when presence is detected in the room, the temperature is automatically adjusted to achieve best comfort.

**Key points**

- Compatible with Cassette, Wall Mounted, Hide Away and Ceiling
- Improves efficiency
- Better Comfort
- Can be installed in the best place of the room for detection purposes

**Sensor location image**

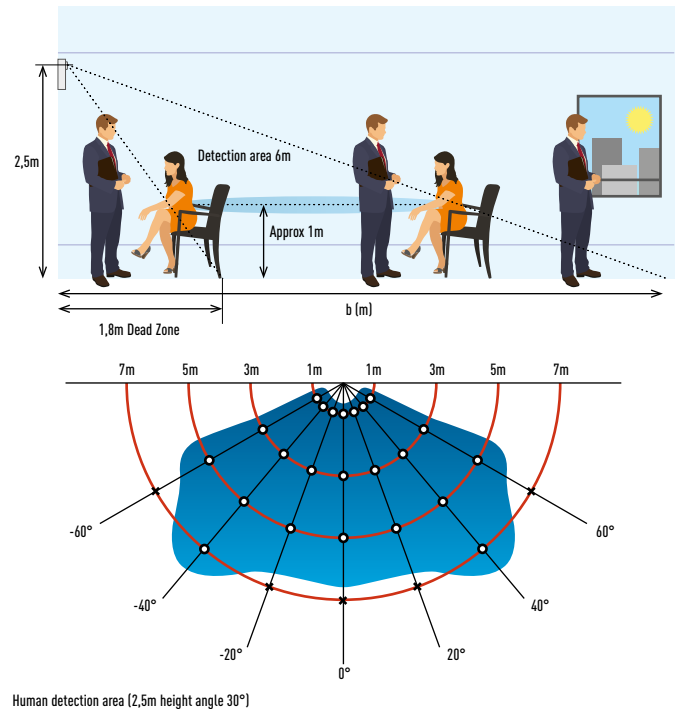

Providing outstanding energy-saving performance, Panasonic's Inverter system can be connected to Econavi to detect when energy is being wasted. Econavi senses the presence or absence of people and the level of activity in each area of an office. When unnecessary heating or cooling is detected, indoor units are individually controlled to match office conditions for energy-saving operation.

**Detection of the level of activity enables precise power saving.**

Presence or absence of people at their desks and the level of activity in the office are detected in real time. Set temperature is automatically adjusted to optimise the lower power consumption.



**Remote Econavi sensor allows optimum energy operation.**

Pillars, walls, cabinets and other fittings obstruct the sensor, reducing the area of detection and lowering the energy-saving effect. Taking into consideration blind spots, Panasonic enables the optimum layout for sensors in any office.

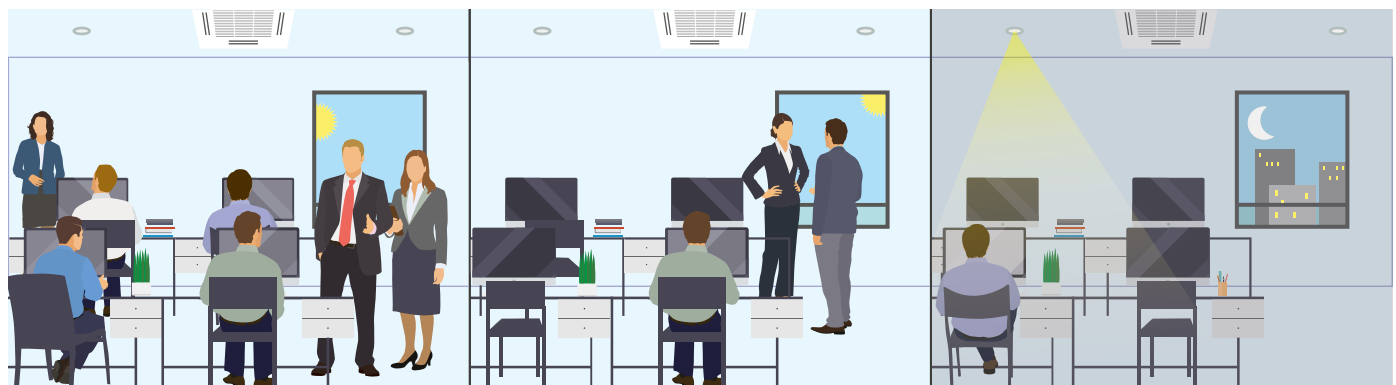

**In the morning.**  
Thorough cooling when there is a high level of activity

**In the afternoon.**  
Reduced cooling when there are fewer people

**At night.**  
Automatic Thermo Off depending on conditions at the end of the day

# NEW INTELLIGENT CONTROLLER

NEW  
TECHNOLOGY  
**'17**



This controller is the smart solution for your advanced requirement in buildings.

### Intuitive operation

The screens used for operations all follow a common pattern, with the screens being easy to read and easy to use.

- Enlarged screen (10,4 inch) with colour LDC
- Smartphone-like operations (Swiping, flicking)

Large screen display. Enlarged by 60%.



Easy Swipe or flick operation.

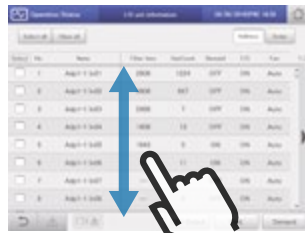

**Swipe.**  
This is an operation where the finger is slid in a direction (up or down) on the touch panel. This is used to scroll slowly.

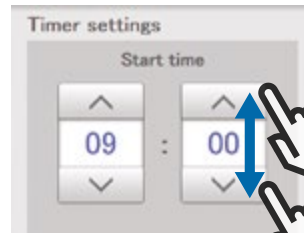

**Select.**  
This is an up and down movement of the finger touching the screen, used to pick settings in elements such as spin boxes.

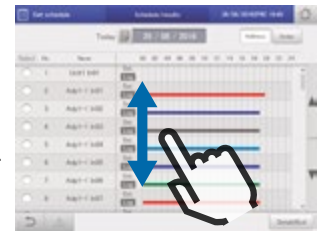

**Pull out.**  
This is an operation where the finger on the touch panel is flicked in a direction (up or down). This is used to scroll quickly.

### Enhanced functions for energy saving as standards

- Set temperature auto return settings, Auto shutoff, Set temperature range limit settings
- Demand control function

Screen of Set temperature auto return setting.

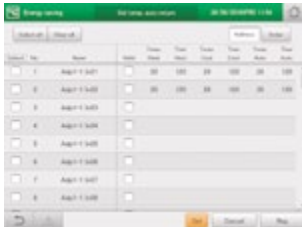

Auto shutoff.



Screen of Outdoor demand control.



- Outdoor demand input and timer settings possible
- Indoor can be set at  $\pm 1^{\circ}\text{C}$ / $\pm 2^{\circ}\text{C}$  or thermostat OFF
- Indoor units controlled in sequence at 10-minute intervals

### Energy Visualization

- Energy-saving plans are supported with graph display function
- Displays electricity & gas usage distribution

Screen of graph display.

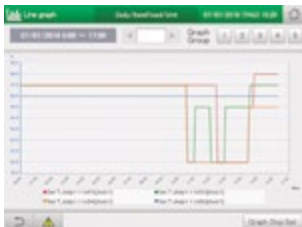

Useful parameters are shown for your better energy saving.  
Ex.) Bar graph:

- Indoor Unit: Total operating time, thermostat ON operation time (Min.)  
Amount used (electricity, gas)  
Electricity or gas charges
- Outdoor unit: Outdoor unit operation cycles (# cycles)  
Engine time in operation (Hrs.)  
Cumulative Inverter power output  
Cumulative PV power output

Pulse value selection per different data intervals 1 hour/1 day/ 1 month compared with last year.

### Main new function

Gesture function (Flick, Swipe)	✓
Graph display (Trends, comparisons)	✓
Web functions (Max. 64 users)	✓
Recipient setting for warning email	✓ (Maximum 8)
Automatic return to setting temperature	✓
Limitation of setting temperature range	✓
Left-on prevention	✓
Quiet operation of outdoor unit	✓
Occupant sensor linkage	✓
Demand function	✓
Charge calculation	✓
Log display	✓ Warning 10.000 items Status change 50.000 items
Linked control Event definition 50 events, Input: 32, Output: 32	✓
Under maintenance (Under inspection registration)	✓



# CONTROL FOR HOTEL APPLICATION



More easier to install, cheaper to integrate one only control to integrate all devices. Nice, easy and cost effective! Panasonic has developed an innovative line up of remote controls specially designed for applications.

- Easy to install
- Cost effective installation as all electrical cable are centralized on this remote
- Architect inspired attractive design
- Direct connection to the Indoor unit with most of the functions of the indoor unit
- 3 options available: Stand-Alone, Modbus or LonWorks communication
- 2 frame colours: White and aluminium

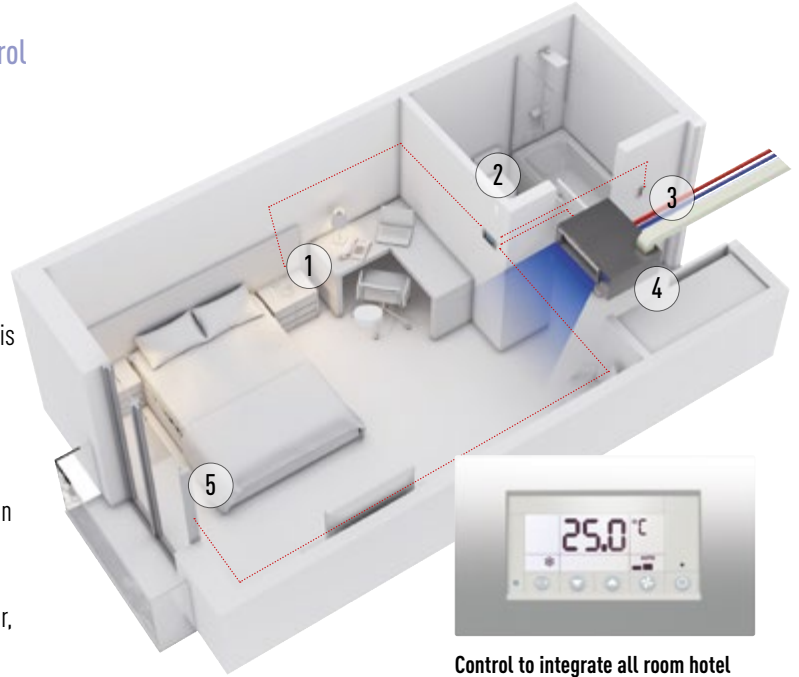

**From this remote control:** The lighting, card contact, motion detector, window contact and the air conditioning are controlled.

**Energy saving functions included on the device:** Turns Off air conditioning and lighting when room is unoccupied. Disables air conditioning when window is open. Maximum/minimum setpoint temperature configurable

**Easy remote control:** The hotel customer will have access to limited functions to control the air conditioning:

ON/OFF, Temperature (under a certain limit fixed during the start up) and Fan speed

**Easy set up:** Stand-Alone model with easy configuration menu to access all parameters. The installation is simplified as all the cables should arrive to the remote control. A pre-define scenario can be uploaded on the remote control connected to a computer to make installation on site plug and play (only on the Modbus and LonWorks models).

**Control to integrate all room hotel needs in one device:**

Card switch. Heating and cooling control. Light control. Window control. Possible to connect to Modbus



Lighting control.



Indoor unit. Variable static pressure hide away.

- 3. Room card switch\*
- 2. Human sensor

- 5. Window contact\*
- \* Field supply

**Four preconfigured systems (option 1 to 4)**

The remote control have a 4 preconfigured systems in order to easily integrate it.

**4 options available I/O configurations: Inputs.**

Configurations	Digital 1-2	Digital 3-4	Digital 5-6	Analog 7-8
Option 1	Card	Window	Lighting	Temperature
Option 2	Card	Window	Blinds up	Blinds down
Option 3	Motion sensor	Window	Door contact	Temperature
Option 4	Lighting	Window	Blinds up	Blinds down

**Available I/O Configurations: Outputs.**

Configurations	Relay 15-16	Relay 13-14	Relay 11-12	Relay 9-10
Option 1	Courtesy	Lighting	Not used	Valve actuator
Option 2	Courtesy	Lighting	Blinds up	Blinds down
Option 3	Courtesy	Lighting	Not used	Valve actuator
Option 4	Not used	Lighting	Blinds up	Blinds down

**I/O Definitions: Inputs.**

Description	Functionality
Card	Occupancy room status. Enable HVAC Control and automatically switches ON Courtesy and Lighting outputs
Window	Temporary disables HVAC System
Lighting	Push button to turn ON/OFF Lighting Output when room occup.
Temperature	Analog input for Valve Actuator output control on 2nd zone
Blinds up	Push button for Blind Up motor output control
Blinds down	Push button for Blind Down motor output control
Motion sensor	In combination with Door Contact, enables HVAC Control and automatically switches ON Courtesy and Lighting outputs
Door contact	In combination with Motion Sensor, enables HVAC Control and automatically switches ON Courtesy and Lighting outputs

**I/O Definitions: Outputs.**

Description	Functionality
Courtesy	Automatically turns ON when room changes to occupied or unoccupied mode. It turns to OFF after a configurable time-out
Lighting	Automatically turns ON/OFF when room changes to occupied/unoccupied. Manual override with Lighting input
Valve actuator	HVAC Control for a 2nd zone
Blinds up	Output for Blind Up motor control
Blinds down	Output for Blind Down motor control

**Example I/O: Wiring configuration for Option 2.**

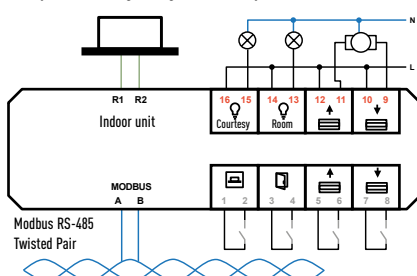

**Example I/O: Option 2.**

Terminals	Description	Type
A, b	Modbus RS-485	Bi-directional
R1, r2	Indoor unit	Bi-directional
1, 2	Card contact	Digital input
3, 4	Window contact	Digital input
5, 6	Blinds up	Digital input
7, 8	Blinds down	Analog input
9, 10	Blinds down	Relay output
11, 12	Blinds up	Relay output
13, 14	Lighting room	Relay output
15, 16	Lighting courtesy	Relay output

**Panasonic Reference.**

PAW-RE2C3-WH	Stand-Alone with I/O White frame
PAW-RE2C3-GR	Stand-Alone with I/O Grey Frame
PAW-RE2C3-MOD-WH	Modbus RS-485 with I/O White frame
PAW-RE2C3-MOD-GR	Modbus RS-485 with I/O Grey frame
PAW-RE2C3-LON-WH	LonWorks TP/FT-10 with I/O White frame
PAW-RE2C3-LON-GR	LonWorks TP/FT-10 with I/O Grey frame



# CONTROL AND CONNECTIVITY

## Centralized Control Systems

### BMS System. PC Base.



P-AIMS. Basic Software  
Up to 1024 groups. Controls 1024 units.  
CZ-CSWKC2

### Connection with 3rd Party Controller.



Seri-Para I/O unit for outdoor unit.  
Up to 4 outdoor units.  
CZ-CAPDC2



Local adaptor for ON/OFF control.  
Controls 1 to 8 units.  
CZ-CAPC2



Mini Seri-Para I/O Unit 0 - 10V.  
Controls 1 to 8 units.  
CZ-CAPBC2



Communication Adaptor.  
Up to 128 groups. Controls 128 units.  
CZ-CFUNC2

### AC Smart Cloud.



Cloud internet control.  
Up to 128 groups. Controls 128 units.  
CZ-CFUSCC1

## New Domestic integration to P-Line - CZ-CAPRA1

Can connect all ranges to P-Line. Full control is now possible.

### Integrates any unit in big system control.

- PKEA Server room integration
- Small offices with Domestic indoors
- Tender for refurbishment (old system Domestic and VRF in one installation)

**Centralized Control Systems: 64 Indoor Units**

**Intelligent Controller / Web Server: 256 Indoor Units**

**P-AIMS: 1.024 Indoor Units**

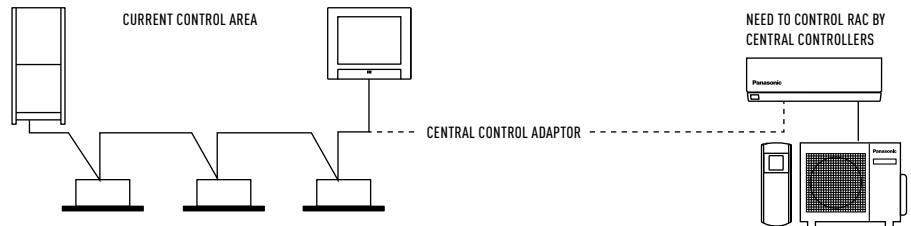

Current system for PACI / VRF. Central controller can connect to S-link line to control units directly.



Request: We want to control RAC unit (which does not have S-link protocol) by Central controllers.



It's necessary to have interface between S-link and RAC protocol to cover basic operating items.

#### Basic operation items

ON/OFF	✓
Mode select	✓
Temperature setting	✓
Fan speed	✓
Flap setting	✓
Remote control prohibit	✓
Econavi ON/OFF	✓

#### External input

ON/OFF control signal	✓
Abnormal stop signal	✓

#### External output for Relay<sup>1</sup>

Operation status (ON/OFF)	✓
Alarm status output	✓







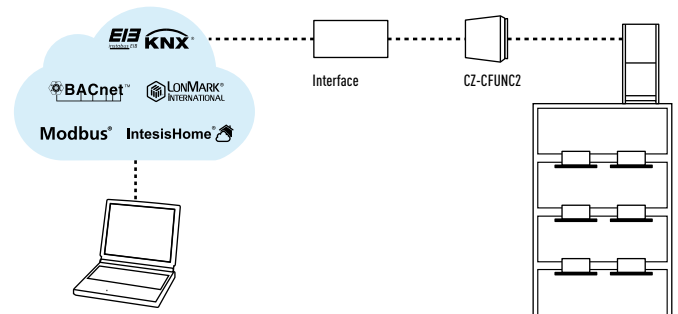

<sup>1)</sup> Because current CN-CNT connector can not provide the power for external output relay, additional Input power for external relay is necessary.

## Easy connection to KNX, Modbus, LonWorks and BACnet

Great flexibility for integration into your KNX / Modbus / LonWorks / BACnet projects allows fully bi-directional monitoring and control of all the functioning parameters.

For more information, contact Panasonic.

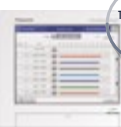

			Econavi control	Built-in thermostat	Indoor units which can be controlled	Use limitations	Function ON/OFF	Mode setting	Fan speed setting	Temperature setting	Air flow direction	Permit/Prohibit switching	Weekly program	BMS protocol	
<b>Individual Controllers</b>															
Control for hotel application. Intelligent Controller		PAW-RE2C3-WH /-GR PAW-RE2C3-MOD-WH /-GR PAW-RE2C3-LON-WH /-GR White / Grey	-	✓	1 indoor unit	-	✓	✓	✓	✓	-	✓	-	Stand alone Modbus or Lonworks	
Wired remote controller. Normal operation		CZ-RTC4	✓	✓	1 group, 8 units	· Up to 2 controllers can be connected per group	✓	✓	✓	✓	✓	-	✓	-	
Wired remote controller. Design wired remote controller	 <b>NEW TECHNOLOGY 17</b>	CZ-RTC5A	✓	✓	1 group, 8 units	· Up to 2 controllers can be connected per group	✓	✓	✓	✓	✓	-	✓	-	
Wired remote controller. Normal operation		CZ-RTC2 (for Floor Standing (MP1) indoor units)	-	✓	1 group, 8 units	· Up to 2 controllers can be connected per group	✓	✓	✓	✓	✓	-	✓	-	
Wireless remote controller		CZ-RWSU3 / CZ-RWSL2N / CZ-RWSK2 / CZ-RWSD2 / CZ-RWST3N / CZ-RWSK2 + CZ-RWSC3	-	✓	1 group, 8 units	· Up to 2 controllers can be connected per group	✓	✓	✓	✓	✓ <sup>1</sup>	-	-	-	
Quick and easy operation Simplified remote controller		CZ-RE2C2	-	✓	1 group, 8 units	· CZ-RE2C2: up to 2 controllers can be connected per group	✓	✓	✓	✓	✓ <sup>1</sup>	-	-	-	
<b>Centralized Controllers</b>															
Central controller with weekly timer	 <b>NEW TECHNOLOGY 17</b>	CZ-64ESMC3	✓	-	64 groups, maximum 64 units	· Up to 10 controllers, can be connected to one system · Main unit/sub unit (1 main unit + 1 sub unit) connection is possible · Use without remote controller is possible	✓	✓	✓	✓	✓ <sup>1</sup>	✓	✓	-	
Only ON/OFF operation from center station. ON/OFF Controller		CZ-ANC2 CZ-ANC3 (available in September 2017)	-	-	16 groups, maximum 64 units	· Up to 8 controllers (4 main units + 4 sub units) can be connected to one system · Use without remote controller is impossible	✓	-	-	-	-	✓	-	-	
Simplified load distribution ratio (LDR) for each tenant. Intelligent Controller (Touch screen panel)	 <b>NEW TECHNOLOGY 17</b>	CZ-256ESMC3	✓	-	Main unit: 128. Up to 256 units can be expanded	· Communication adaptor CZ-CFUNC2 is necessary for connection with more than 128 units	✓	✓	✓	✓	✓ <sup>1</sup>	✓	✓	-	

1. Setting is not possible when a remote control unit is present (use the remote control for setting). \* All specifications subject to change without notice.

# INDIVIDUAL CONTROLLERS

## Control for hotel application. Intelligent Controller (for VRF)



**PAW-RE2C3-WH // PAW-RE2C3-GR // PAW-RE2C3-MOD-WH // PAW-RE2C3-MOD-GR // PAW-RE2C3-LON-WH // PAW-RE2C3-LON-GR**

- Easy to install
- Cost effective installation as all electrical cable are centralized on this remote
- Architect inspired attractive design
- Direct connection to the Indoor unit with most of the functions of the indoor unit
- 3 options available: Stand-Alone, Modbus or LonWorks communication
- 2 frame colours: White and aluminium

### From this remote control.

The lighting, card contact, motion detector, window contact and the air conditioning are controlled.

### Energy saving functions included on the device.

- Turns Off air conditioning and lighting when room is unoccupied
- Disables air conditioning when window is open
- Maximum/minimum setpoint temperature configurable

## Wired remote controller. Normal operation with Econavi



### CZ-RTC4

- Time Function 24 hours real time clock (week day indicator)
- Weekly programme function (a maximum of 6 actions can be programmed for each day)
- Sleeping function (this function controls the room temperature for comfortable sleeping)
- Maximum 8 indoor units can be controlled from one remote controller
- Remote control by main remote controller and sub controller is possible (maximum 2 remote controllers (main remote controller and sub controller) can be installed for one indoor unit)
- Possible to connect to the outdoor unit using PAW-MRC cable for servicing purposes

- Outing function (this function can prevent the room temperature from dropping or rising when the occupants are out for a long time)
- Dimensions (H x W x D:) 120 x 120 x 20mm
- Weight: 160 g

### Basic remote controller ON/OFF.

- Econavi compatible
- Operation mode changeover (Cooling, Heating, Dry, Auto, Fan)
- Temperature setting (Cooling / Dry: 18-30°C Heating: 16-30°C)
- Fan speed setting High / Medium / Low and Auto
- Air flow direction adjustment

## Wired remote controller. Design wired remote controller



### CZ-RTC5A

- Power consumption monitor (only for PACi)
- Flat face design & Touch sensor switch for stylish design and operating usability
- New functions such as for Energy saving & monitoring and for Service use are available on the Full dot LCD (3.5" display)
- Improved illumination
- White LED backlit
- Blink when alarm occurs

### Timer function.

- Outing function
- Weekly Program timer
- Easy ON/OFF timer
- Time display

### Energy saving.

- Outing function
- Temperature setting range limitation
- Temperature auto return
- OFF remind
- Schedule demand control
- Energy saving mode
- Energy monitoring

### Others.

- Key lock
- Ventilation fan control
- Display contrast adjustment
- Remote controller sensor
- Quiet operation mode
- Prohibit setting control from Central controller

\* Several functions can not use on some outdoor unit. Ex. Power consumption monitor is not available for PACi Standard, Backup/Rotation control for PACi system.

Control contents	Part name, model No.	Quantity
Standard Control	Timer remote controller: CZ-RTC4 // CZ-RTC5A Wired remote controller: CZ-RE2C2 // CZ-RE2C3 Wireless remote controller: CZ-RWSU3 // CZ-RWSL2N // CZ-RWSK2 // CZ-RE2C2 // CZ-RE2C3	1 unit each
(1) Group control	Timer remote controller: CZ-RTC4 // CZ-RTC5A Wired remote controller: CZ-RE2C2 // CZ-RE2C3 Wireless remote controller: CZ-RWSU3 // CZ-RWSL2N // CZ-RWSK2 // CZ-RE2C2 // CZ-RE2C3	1 unit
(2) Main/sub remote control	Main or sub. Timer remote controller: CZ-RTC4 // CZ-RTC5A Wireless remote controller: CZ-RWSU3 // CZ-RWSL2N // CZ-RWSK2 // CZ-RE2C2 // CZ-RE2C3	As required

## Wired remote controller. Normal operation (for Floor Standing (MP1) indoor units)

### CZ-RTC2

- Time Function 24 hours real time clock (week day indicator)
- Weekly programme function (a maximum of 6 actions can be programmed for each day)
- Sleeping function (this function controls the room temperature for comfortable sleeping)
- Maximum 8 indoor units can be controlled from one remote controller
- Remote control by main remote controller and sub controller is possible (maximum 2 remote controllers (main remote controller and sub controller) can be installed for one indoor unit)

- Possible to connect to the outdoor unit using PAW-MRC cable for servicing purposes
- Outing function (this function can prevent the room temperature from dropping or rising when the occupants are out for a long time)

### Basic remote controller ON/OFF.

- Operation mode changeover (Cooling, Heating, Dry, Auto, Fan)
- Temperature setting (Cooling / Dry: 18-30°C Heating: 16-30°C)
- Fan speed setting High / Medium / Low and Auto
- Air flow direction adjustment
- Dimensions (H x W x D): 120 x 120 x 16mm



## Wireless remote controller



CZ-RWSC3  
For 4 Way 90x90 Cassette.



CZ-RWSL2N  
For 2 Way Cassette.



CZ-RWSK2  
For Wall Mounted and 4 Way  
60x60 (with CZ-KPY3A).



CZ-RWSD2  
For 1 Way Cassette.



CZ-RWST3N  
For Ceiling.



CZ-RWSK2 + CZ-RWSC3  
Combination for all indoor units.

### CZ-RWSC3 // CZ-RWSL2N // CZ-RWSK2 // CZ-RWSD2 // CZ-RWST3N // CZ-RWSK2 + CZ-RWSC3

- Easy installation for the 4 Way cassette type simply by replacing the corner part
- 24 hour timer function
- Remote control by main remote controller and sub controller is possible (Max. 2 remote controllers (main remote controller and sub controller) can be installed for one indoor unit)

- When CZ-RWSC3 is used, wireless control becomes possible for all indoor units (1: when a separate receiver is set up in a different room, control from that room also becomes possible. 2: automatic operation by means of the emergency operation button is possible even when the remote controller has been lost or the batteries have been exhausted)
- Operation of separate energy recovery ventilators (When commercial ventilation fans or heat-exchange ventilation fans have been installed, they can be operated with this remote control (interlocked operation with the indoor unit or independent ventilation ON/OFF))

## Simplified remote controller. Quick and easy operation

### CZ-RE2C2. A remote controller with simple functions and basic operation.

- Suitable for open rooms or hotels where detailed functions are not required
- ON/OFF, operation mode switching, temperature setting, air speed switching, air flow direction setting, alarm display, and remote controller self-diagnosis can be performed

- Batch group control for up to 8 indoor units
- Remote control by main remote controller and sub controller is possible with a simplified remote controller or a wired remote controller (up to two units)
- Dimensions (H x W x D): 120 x 70 x 16mm



## Remote sensor

### CZ-CSRC3

- This remote sensor can be connected to any indoor unit. Please use it to detect the room temperature when no remote controller sensor or body sensor is used (connection to a system without a remote controller is possible)
- For joint use with a remote control switch, use the remote control switch as main remote controller
- Batch group control for up to 8 indoor units
- Appearance design based on simplified remote controller chassis

- Dimensions (H x W x D): 120 x 70 x 17mm
- Weight: 70 g
- Temperature/Humidity range: 0 °C to 40 °C / 20 % to 80 % (no condensation) (indoor use only)
- Power Source: DC16 V (supplied from indoor unit)
- Maximum number of connectable indoor units: Up to 8 units



# CENTRALISED CONTROLLERS

## New System Controller with Schedule timer. Operation with various function from center station



NEW TECHNOLOGY  
\*17

Sample display image / Operation status display

Operation Status ALL



Operation Status ZONE



Operation Status GROUP



### CZ-64ESMC3

#### Panasonic unveils state-of-the-art digital controller.

Panasonic has launched its latest controller, an innovative and easy to use interface that offers full functionality with an integrated schedule timer and system controller, making managing heating and cooling systems easier than ever before. The CZ-64ESMC3 includes Panasonic's popular schedule timer, which gives users full flexibility over when they want their property heated or cooled. Users can adjust the system for holidays, pausing operations for long periods of time so that energy isn't wasted heating or cooling an empty home or office. The controller also allows six operations per day to be programmed.

#### Mix of current 2 controllers: System controller + Schedule timer.

New system controller will be designed by taking priority on these 2 operations with following technical key points:

- Same operation feeling as new wired remote controller by touch-key panel
- High visibility and usability by Full-dot LCD
- Based on High wired remote controller
- Maximum 64 group of indoor units, Individual control for 64 units
- 4 zone control; 1 zone = Maximum 16 groups
- Several energy saving function (based on CZ-RTC5A)
- 6 timer program per day for 1 week (7 days) operation (Total 6 x 7 = 42 programs)
- Basic setting items (Temperature, Mode, Fan speed, Flap position) can be set by same manner as CZ-RTC5A

#### Function list.

From CZ-64ESMC2 System controller:

- Central control / individual setting
- Start-stop prohibition for remote controller
- Start-stop / Mode change / Temperature setting prohibition for remote controller
- Mode change / Temperature setting prohibition for remote controller
- Mode change prohibition for remote controller
- Select items for prohibition

- Filter information
- Filter sign
- Filter sign reset
- Ventilation setting

From CZ-ESWC2 Schedule timer:

- Weekly Timer
- Timer setting Enable / Disable
- Copy of Timer setting
- Maintenance
- External signal (Start / Stop) (Demand control)
- Centralized control master-slave setting
- Alarm history
- Initial setting
- Clock

From CZ-RTC5A

- Energy-saving control
- Econavi On/Off
- Filter information
- Filter sign and Hour counter display
- Maintenance
- Service contact
- Initial setting
- Clock display setting
- Name Setting
- Operation lock setting
- Operation sound setting
- LCD contrast setting
- LCD backlight setting
- Select displayed language (EN / FR / IT / ES / DE)
- Administrator password
- Setting information list

## ON/OFF Controller. Only ON/OFF operation from center station



### CZ-ANC2 / CZ-ANC3 (available in September 2017).

- 16 groups of indoor units can be controlled
- Collective control and individual group (unit) control can also be performed
- Up to 8 ON/OFF controller (4 main, 4 sub) can be installed in one link system
- The operation status can be determined immediately
- Dimensions (H x W x D): 121 x 122 x 14 + 52mm (embedding dimension)

Power supply: AC 220 to 240V.

I/O part: Remote input (effective voltage: within DC 24V): All ON/OFF.

Remote output (allowable voltage: within DC 30V): All ON, All alarm.

Note: As operation mode and temperature settings are not possible with the ON/OFF controller, it must be used together with a remote controller, a system controller etc.



**Intelligent Controller (Touch screen panel). Simplified load distribution ratio (LDR) for each tenant**

**CZ-256ESMC3**

Dimensions (H x W x D): 240 x 280 x 20 (+60)mm.  
 Power supply: Single phase 100-240V ~ 50/60Hz.  
 Number of connectable units per link<sup>1</sup>: Up to 100 units of the combined total of the following:

- Indoor unit: Up to 64 units<sup>2</sup>
- Outdoor unit: Up to 30 units
- Central control device: Up to 10 units

Enlarged Display Screen: 10,4 inch Touch-panel colour LCD.  
 Pursuing visibility, ease of use.  
 Retrieve data from USB memory: Place the USB port inside the panel (USB memory available in stores).  
 Communication adaptor: CZ-CFUNC2.

1) The maximum number of connectable units is shown below:  
 - When using only this unit: 128 indoor units and 60 outdoor units  
 - When connecting a communication adaptor: 256 indoor units and 120 outdoor units  
 2) The number of indoor units includes the interface adaptor.

**New Functions.**

- Graph display (trends, comparisons)
- Econavi ON/OFF
- Outdoor unit quiet operation ON/OFF
- Energy-saving functions: Set temperature auto return settings, Auto shutoff, Set temperature range limit settings, Energy saving for PAC current value, etc.
- Event control (such as equipment linkage)
- Performs closing at end of any period

**Operation and status.**

You can check to operational status (ON/OFF, operating mode, alarms, etc.) of all indoor units and outdoor units in real time. You can also select indoor units to change their settings.

**Operation scheduling.**

You can register daily operation schedules (ON/OFF time, operating modes, set temperatures, etc.) for individual indoor units or groups of indoor units. Operations can be schedule for up to 2 years in advance.

**Distributing air conditioner energy.**

You can view cumulative operating times for indoor units, engine operating times for outdoor units, and operation cycles in a list (cumulative values). Using these data, you can calculate the distribution ratio of electricity or gas consumed for air conditioning and volumes used (kWh, m<sup>3</sup>) per indoor unit or in an area, then show these calculations in a list.

**Remote control.**

The LAN terminal on this unit enables you connect it to a network. Connecting to Internet will enable you to operate the unit and check the status using a PC from a remote location.

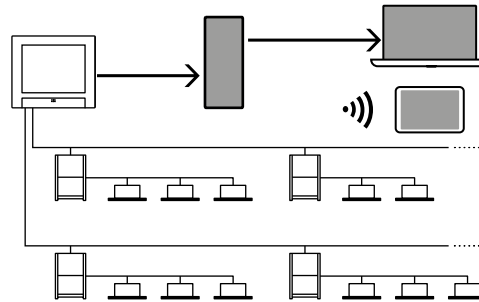

**New back up tool to save your commissioning time.**

Various data such as distribution, setting, log history etc. can be saved by CSV file. Setting data of CSV file is available to edit and import to the controller again. You can save time for commissioning and change setting flexibly and easily by your PC.

- Customize data
- Data recovery

Data can be imported again by general USB.

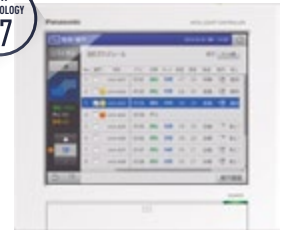
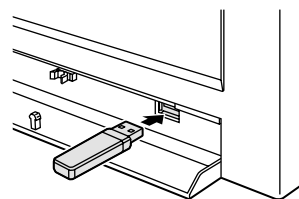

**System Configuration Example.**

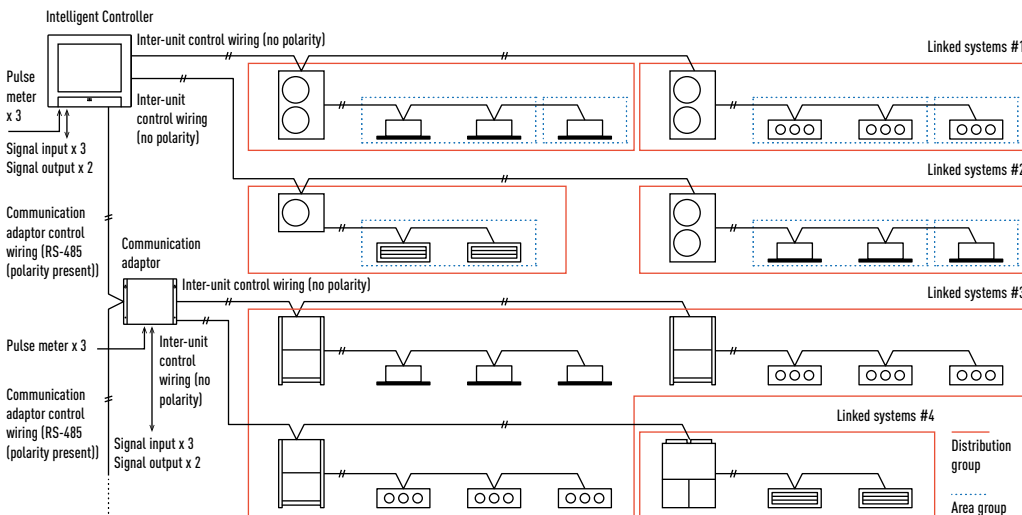

# CENTRALISED CONTROLLERS

## P-AIMS. Panasonic Total Air Conditioning Management System



### CZ-CSWKC2 / P-AIMS Basic software.

Up to 1024 indoor units can be controlled by one PC.

#### Functions of basic software.

- Standard remote control for all indoor units.
- Many timer schedule programs can be set on the calendar.
- Detailed information display for alarms.
- CSV file output with alarm history, operating status.
- Automatic data backup to HDD.

P-AIMS is suitable for large shopping centers and universities with many areas/ buildings. 1 "P-AIMS" PC can have 4 independent systems at once.

Each system can have maximum 8 C/A units, and control maximum 512 units. In total, 1024 indoor units can be controlled by 1 "P-AIMS" PC.

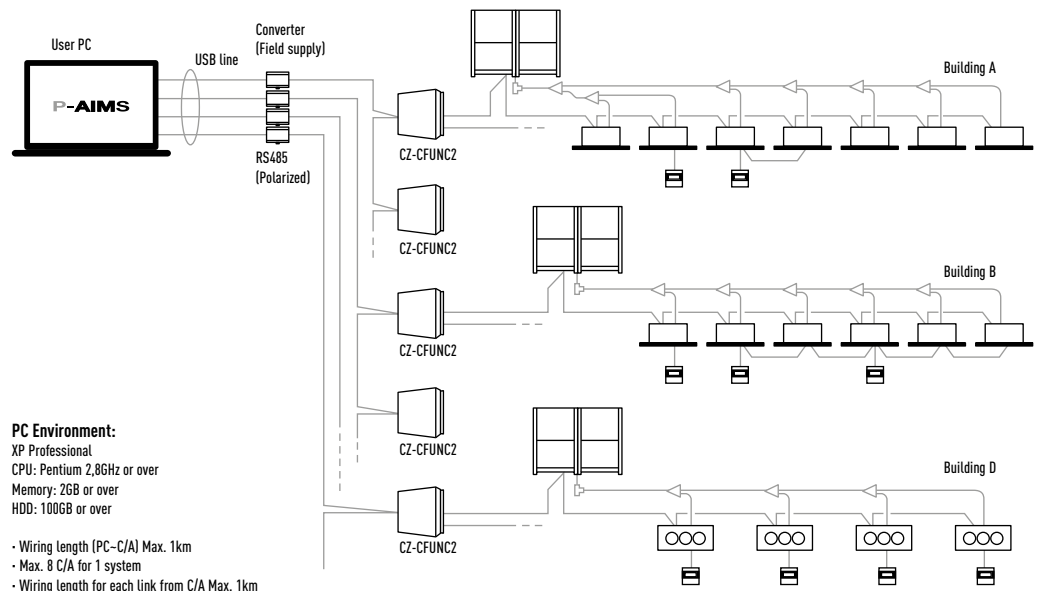

### P-AIMS optional software CZ-CSWAC2 for Load distribution. Load distribution calculation for each tenant.

- Air-conditioner load distribution ratio is calculated for each unit (tenant) with used energy consumption data (m<sup>3</sup>, kWh)
- Calculated data is stored as a CSV type file
- Data from the last 365 days is stored

### P-AIMS optional software CZ-CSWGC2 for Object layout display. Whole system can be controlled visually.

- Operating status monitor is available on the layout display
- Object's layout and indoor unit's location can be checked at once
- Each unit can be controlled by virtual remote controller on the display
- Max. 4 layout screens are shown at once

### P-AIMS optional software CZ-CSWWC2 for Web application. Web access & control from remote station.

- Accessing P-AIMS software from remote PC
- You can monitor/operate ECOi 6N system by using Web browser (Internet Explorer)

### P-AIMS optional software CZ-CSWBC2 for BACnet software interface. Connectable to BMS system.

- Can communicate with other equipment by BACnet protocol
- ECOi 6N system can be controlled by both BMS and P-AIMS
- Max. 255 indoor units can be connected to 1 PC (that has P-AIMS basic & BACnet software).

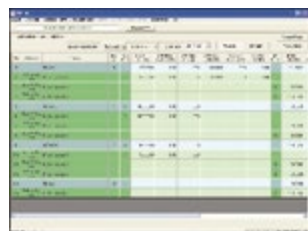

With 4 upgrade packages the basic software can be upgraded to suit individual requirements.

**Seri-Para I/O unit for outdoor unit. Connection with 3rd Party Controller**

**CZ-CAPDC2 for ECOi / CZ-CAPDC3 for Mini ECOi and PACi.**

- This unit can control up to 4 outdoor units
- From the central control device, mode changing and batch operation/batch stop are possible
- Required for demand control

Dimensions (H x W x D): 80 x 290 x 260mm.  
 Power supply: Single Phase 100/200V (50/60Hz), 18W.  
 Input: Batch operation/Batch stop (non-voltage contact/DC 24 V, pulse signal). Cooling/Heating (non-voltage contact/static signal). Demand 1/2 (non-voltage contact/static signal) (Local stop by switching).

Output: Operation output (non-voltage contact). Alarm output (non-voltage contact).  
 Wiring length: Indoor/Outdoor operation lines: Total length 1km.  
 Digital signal: 100m or shorter.

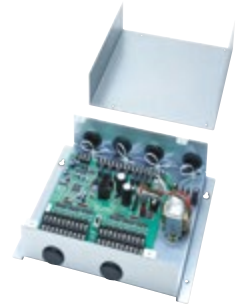
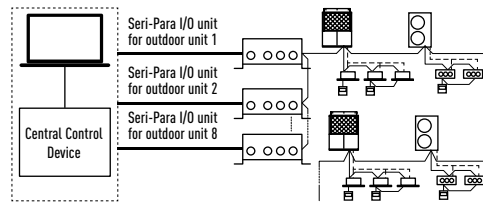

**Local adaptor for ON/OFF control. Connection with 3rd Party Controller**

**CZ-CAPC2 / CZ-CAPC3 (available in December 2017).**

- Control and status monitoring is possible for individual indoor unit (or any external electrical device up to 250 V AC, 10 A) by contact signal

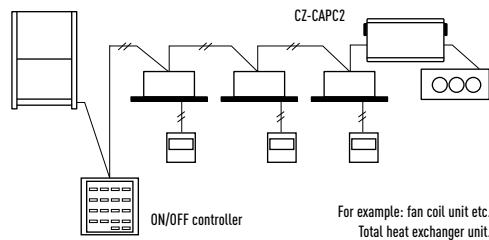

**MINI Seri-Para I/O Unit 0 -10V. Connection with 3rd Party Controller**

**CZ-CAPBC2**

- Control and status monitoring is possible for individual indoor unit (1 group)
- In addition to operation and stop, there is a digital input function for air speed and operation mode
- Temperature setting and measuring of the indoor suction temperature can be performed from central monitoring
- Power is supplied from the CZ-T10 terminal of the indoor units
- The analog input for demand of the outdoor capacity by 20 steps (from 40% to 120%) by 0-10V

- The analog input for temperature setting is 0 to 10V, or 0 to 140 Ohm
- Separate power supply also is possible (in case of suction temperature measuring)

\* Ask to your distributor.

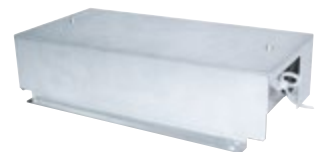
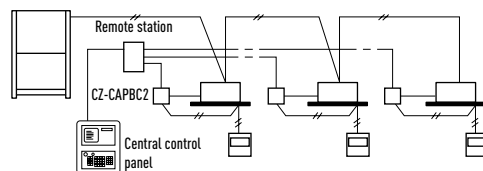

**Communication adaptor for VRF Connectivity**

**CZ-CFUNC2**

This communication interface is required to connect a ECOi and GHP systems to a BMS. An additional interface is needed to convert the information into KNX/Modbus/Bacnet language. CZ-CFUNC2 is very easy to operate and to connect to the Panasonic P-Link, which is the ECOi bus. From the CZ-CFUNC2, all

the indoor and outdoor units of the installation can be easily control. Two linked wiring systems can be connected to one CZ-CFUNC2.

Dimensions (H x W x D): 260 x 200 x 68mm

\* As this is not a splash-proof design, it must be installed indoors or in the control panel, etc.



# CENTRALISED CONTROLLERS

## Centralised Control Systems

### A custom web application to manage the centralized operation of A2W and GHP systems.

Operation and monitoring of devices connected to the new Management System can be realized both remotely/locally from any device with connection to the internet (Laptop, Tablet, Mobile)

The new system will make the interaction with air conditioning systems easier, improving the operation set as well as the global control of installations.

The application will act with various units, regardless of whether they are available in the same intranet or in different locations, transparently to users at any time. In this way, our solution allows to overcome main restrictions like onsite maintenance or the lack of centralization.

In addition, the application offers significant improvements in terms of control:

- Aircon units can be grouped in a totally custom way
- Possibility to realize group commands and batch commands (in succession)
- Alarms and events can be controlled more efficiently and a lot more...

### Features of current system.

Operation Functions

- Start & Stop
- Temperature settings
- Operation mode selection
- Fan speed, Fan direction settings
- Prohibition of use of remote controller

### Operation Monitoring.

- Monitoring of operation status and alarms
- Monitoring of filter cleaning signs
- Display of alarm logs

### Program Timers.

- Up to 50 types of weekly timer
- Holiday and Special Days

### Benefits.

The new solution offers significant benefits for the different actors involved in its management:

#### For the building Ownership:

- Maximum equipment performance
- Energy saving
- Increased lifetime of equipment
- Savings in maintenance costs

#### For Maintenance companies:

- Instant knowledge of any incident
- Possibility of preventive alarms
- Reduction of systematic visits (warning and remote control)
- More effective maintenance support

### Current installation .

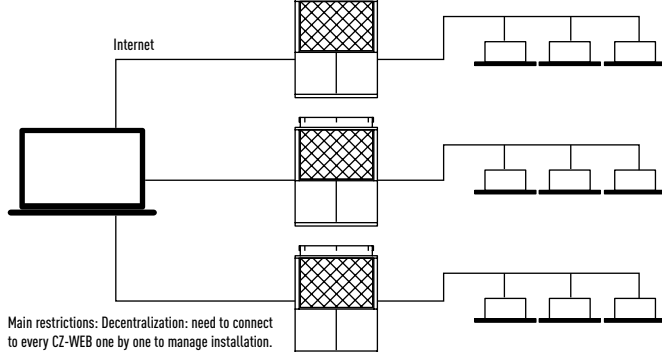

Main restrictions: Decentralization: need to connect to every CZ-WEB one by one to manage installation.  
On-site maintenance: Access limited to local network.

### Offer reliable solution to improve existing functionalities.

- Running timer
- Remote control through Web Cloud Application or local. Accessible anytime, anywhere, via a device with internet connection
- Centralized Control: Manage several installations in one single interface. Ideal for multi-site organizations
- Easy monitoring and maintenance thanks to group commands, and batch commands. Easy supervision of complex installations
- Secure Remote Access. Powerful identity protection and convenient access control



# PACi AND VRF CONNECTIVITY & CONTROL

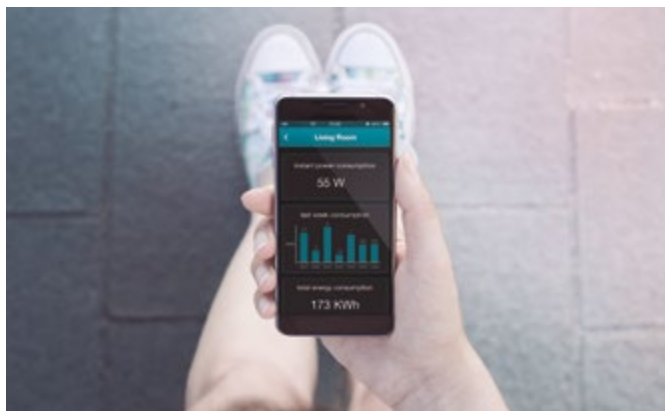
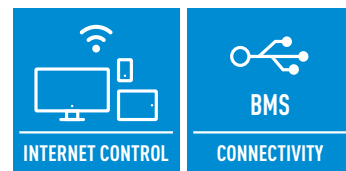

Aware of the importance of both control and connectivity in offering the best comfort at the lowest price, Panasonic offers its customers cutting-edge technology, specially designed to ensure our air conditioning systems deliver maximum performance. You can properly manage the air conditioning and perform comprehensive monitoring and control, with all of the features the remote control provides at home, from anywhere in the world thanks to the internet applications Panasonic has created for you.

## Internet Control

Control your air conditioning system with your smart device -smartphone & internet for PACi and VRF Systems.

### What's Internet Control?

Internet Control is a next generation system providing user-friendly remote control of air conditioning or heat pump units from anywhere, by the simple use of an Android or iOS smartphone, tablet or PC via internet. With the option of the Wired Room temperature sensor, the system can display the temperature.

### Simple Installation.

Just connect the Internet Control device to the air conditioner or heat pump with the supplied wire and then link it to your WIFI Access point.

## KX-UT670 Smart Desktop Phone from Panasonic.



## Airzone. Control of the PACi Hide Aways

Airzone has developed interfaces to easily connect to Panasonic PACi Hide Away units. Ensuring optimum performance, comfort and energy savings, the new system is efficient and easy to install.

### Airzone full range of accessories for any duct project.



Different type of outlets



Also plenum automatic doors



Full range of RC (wired/wireless, ...)

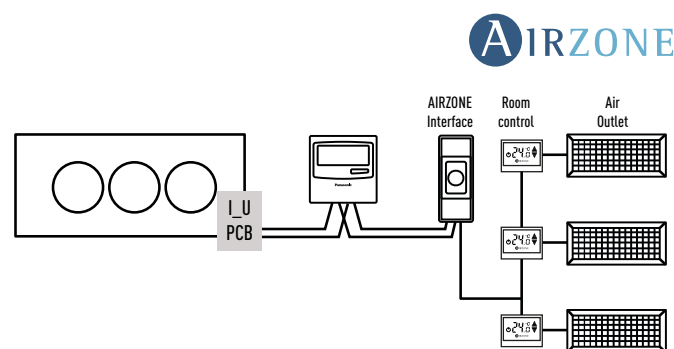

## ECOi and GHP Connectivity

### New Plug and play interface connected directly to the P-Link.

The interface has been designed specifically for Panasonic and provides complete monitoring, control and full functionality of the line-up from IntesisHome, KNX, EnOcean, Modbus, BacNet and Lonworks installations.

This connectivity solution is made by a third party company, please contact Panasonic for more information.

1) Interface Modbus RTU/TCP is needed in case if Modbus TCP connection. PAW-MBS-TCP2RTU (ModBus RTU Slave devices).  
2) Interface CZ-CFUNC2 needed.

	Model name	Interface	Maximum number of indoor units connected
ECOi / PACi Indoor Units	PAW-RC2-KNX-1i	KNX	1 (1 Group of Indoor units)
	PAW-RC2-MBS-1	Modbus RTU <sup>1</sup>	1 (1 Group of Indoor units)
	PAW-RC2-MBS-4	Modbus	4 indoor/groups
	PAW-RC2-ENO-1i	EnOcean	1 (1 Group of Indoor units)
	PA-RC2-WIFI-1	IntesisHome	1 (1 Group of Indoor units)
ECOi P-Link	PAW-AC-KNX-64	KNX <sup>2</sup>	64
	PAW-AC-KNX-128	KNX <sup>2</sup>	128
	PAW-AC-MBS-64	Modbus	64
	PAW-AC-MBS-128	Modbus	128
	PAW-TM-MBS-RTU-64	Modbus RTU <sup>2</sup>	64
	PAW-TM-MBS-TCP-128	Modbus TCP <sup>2</sup>	128
	PAW-AC-BAC-1	Bacnet	1
	PAW-AC-BAC-64	Bacnet <sup>2</sup>	64
	PAW-AC-BAC-128	Bacnet <sup>2</sup>	128
	CZ-CLNC2	Lonworks	16 groups of max. 8 indoor units, in total max. 64 indoor units



# ECOi, ECO G AND PACi CONNECTIVITY INDOOR UNITS

## PCB's and cables for ECOi, ECO G and PACi indoor units

Name of the cables	Function	Comment
CZ-T10	All T10 functions	Requires field supplied accessory
PAW-FDC	Operate external fan	Requires field supplied accessory
PAW-OCT	All option monitoring signals	Requires field supplied accessory
CZ-CAPE2	Option monitoring signals wo. fan	Requires additional wires from spare part supply
PAW-EXCT	Forced Thermo OFF/Leakage D.	Requires field supplied accessory
Name of the PBC	Function	Comment
PAW-T10	All T10 functions	Allows easy connection "Plug & Play"
PAW-T10V	All T10 functions + powermonitoring	Same like PAW-T10 + monitoring the power supply of indoor unit
PAW-T10H	ON/OFF; Prohibit 5VDC & 230VAC	Specials for single hotel card or window contact
PAW-T10HW	ON/OFF; Prohibit 5VDC	For hotel card + window contact at same time
PAW-PACR3	Redundancy of 2 or 3 systems; for ECOi and PACi	Redundancy of 2 or 3 ECOi or PACi systems including temperature monitoring, error indication, backup, alternative run
PAW-SERVER-PKEA	Redundancy of 2 units PKEA	Redundancy of 2 units PKEA including temperature monitoring, error indication, backup, alternative run

## T10 connector (CN015)



### CZ-T10

Panasonic has developed an optional accessory (consisting of plug + wires) called CZ-T10 to enable an easy connection to this T10 connector.

Connecting an ECOi indoor unit to an external device is easy. The T10 terminal featured in the electronic circuit board of all indoor units enables digital connection to external devices.

### T10 terminal Specification (T10: CN015 at indoor unit PCB).

- Control items: 1. Start/stop input
- 2. Remote controller prohibit input
- 3. Start signal output
- 4. Alarm signal output

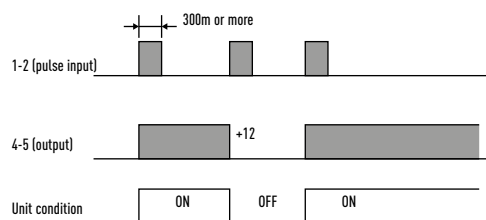

NOTE: The wire length from indoor unit to the Relay must be within 2.0m. Pulse signal changeable to static with JP cutting. (Refer to JP001)

### Condition

- 1-2 (Pulse input): Unit ON/OFF condition switching with a pulse signal. (1 pulse signal: shortage status more than 300msec. or more)
  - 2-3 (Static input): Open / Operation with Remote is permitted (Normal condition) Close / Remote controller is prohibited
  - 4-5 (Static output): 12V output during the unit ON / No output at OFF
  - 5-6 (Static output): 12V output when some errors occur / No output at normal
- Example of wiring

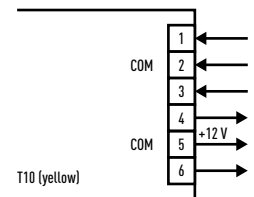

### Usage Example.

#### Forced OFF control.

Term 1 & 2: Free contact for ON/OFF signal (cut \*JP1\* for static signal) when the hotel card is it connected the contact must be close (the unit can be used).

Term 2 & 3: Free contact to prohibit all function in the remote controller install in the room when the hotel card is it removed the contact must be closed (the unit can not work).

#### Terminal = T10

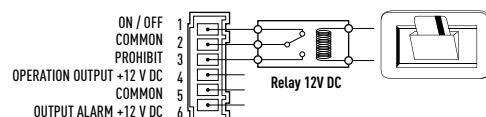

### Operation ON/OFF signal output.

#### Condition:

4-5 (Static output): 12V output during the unit ON / No output at OFF

#### Example of wiring

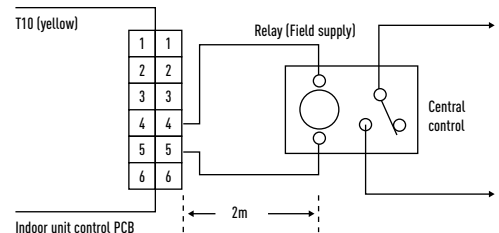

NOTE: The wire length from indoor unit to the Relay must be within 2.0m. Pulse signal changeable to static with JP cutting. (Refer to JP001)

### Fan Drive Connector (CN032)

#### PAW-FDC

Panasonic has developed an optional accessory (consisting of plug + wires) called PAW-FDC to enable an easy connection to this Fan Drive Connector (CN032).

- Operating the ventilation fan from the remote controller
- Start / stop of external ventilation and total heat exchanger fans
  - Works even if indoor unit is stopped
  - In case of group control → all fans will operate; no individual control

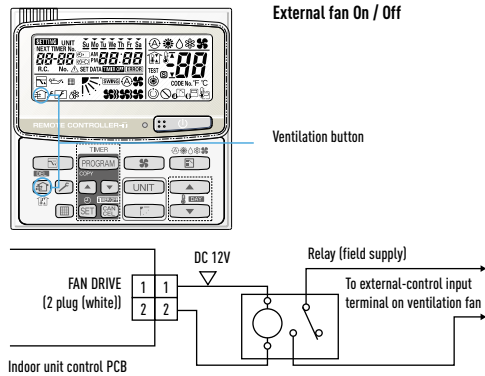

### Option Connector (CN060) Output external signals

#### PAW-OCT

Panasonic has developed an optional accessory (consisting of plug + wires) called PAW-OCT to enable an easy connection to this Option Connector (CN060).

With the combination of the T10 and the option CN060 an external control of the indoor units is possible!

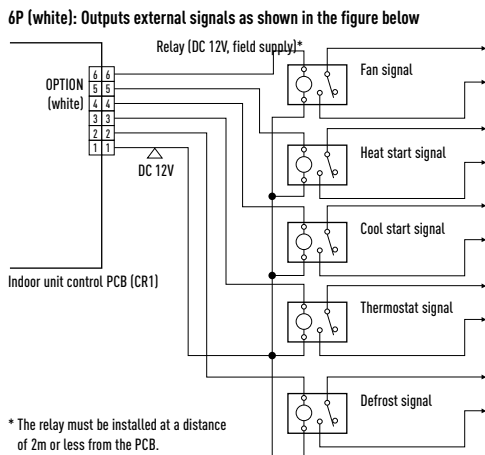

\* The relay must be installed at a distance of 2m or less from the PCB.

### EXCT Connector (CN009)

#### PAW-EXCT

Panasonic has developed an optional accessory (consisting of plug + wires) called PAW-EXCT to enable an easy connection to this EXCT Connector (CN009).

#### A) With static input.

→ STATIC INPUT → THERMO OFF → ENERGY SAVING

2P plug (red): Can be used for demand control. When input is present, forces the unit to operate with the thermostat OFF.

Note: The length of the wiring from the indoor unit control PCB to the relay must be 2m or less.  
\* Lead wire with 2P plug (special—order part: WIRE K/854 05280 75300)

• Examples of wiring:

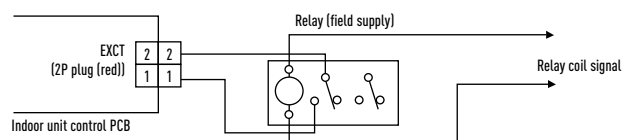

#### B) Example: In connection with a refrigerant sensor.

- Signal from leakage detector: non voltage, static.
- Indoor unit setting: Code 0b → 1
- Connector for leak detector: EXCT
- Outdoor unit setting:
  - Code C1 → 1 power output if alarm from O2 connector 230V
  - Code C1 → 2 power output if alarm from O2 connector 0V
- Displayed alarm message P14

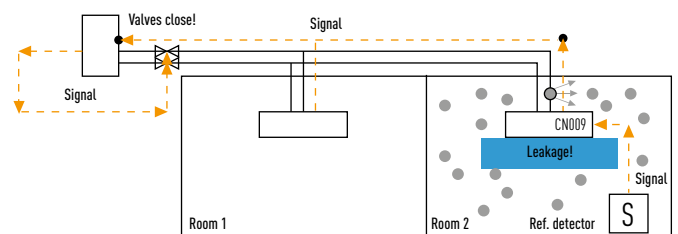

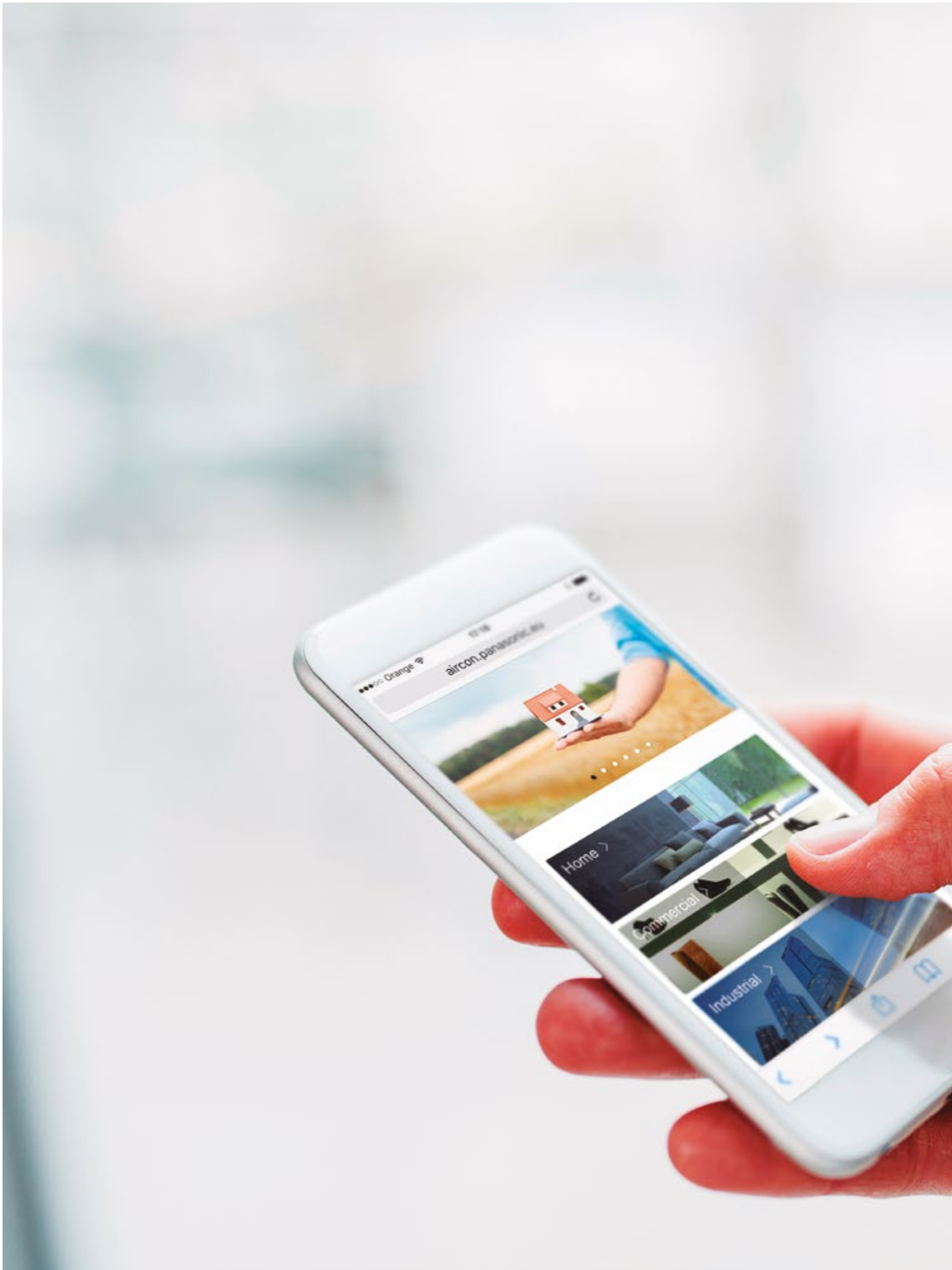

[www.aircon.panasonic.eu](http://www.aircon.panasonic.eu)

---

heating & cooling solutions

# Panasonic®

To find out how Panasonic cares for you,  
log on to: [www.aircon.panasonic.eu](http://www.aircon.panasonic.eu)



Panasonic Marketing Europe GmbH  
Panasonic Air Conditioning  
1117. Budapest, Neumann János u. 1.



Do not add or replace refrigerant other than the specified type. Manufacturer is not responsible for the damage and deterioration in safety due to usage of the other refrigerant.  
The outdoor units in this catalogue contains fluorinated greenhouse gases with a GWP higher than 150.



Due to the ongoing innovation of our products, the specifications of this catalogue are valid barring typographic errors, and may be subject to minor modifications by the manufacturer without prior warning in order to improve the product. The total or partial reproduction of this catalogue is prohibited without the express authorisation of Panasonic Marketing Europe GmbH.