

Panasonic

NEW PRODUCTS

EFFICIENT SOLUTIONS

2015 — 2016



AQUAREA AIR TO WATER HEAT PUMP



DOMESTIC AIR TO AIR HEAT PUMP



COMMERCIAL AIR TO AIR



VRF SYSTEMS

NEW PRODUCTS 2015 - 2016

heating & cooling solutions

AQUAREA

Aquarea Air To Water Heat Pump range

Aquarea is a ground breaking low energy system for heating and domestic hot water production: delivering outstanding performance, even at extreme outdoor temperatures.

All in One

New All in One solution from 3 to 16kW with 200L tank, A class pump and small foot print. Ideal for new and retrofit homes.



New Mono-Bloc generation

With A class water pump and the new remote controller to improve performance, enhance comfort and deliver maximum savings.



New T-CAP Bi-Bloc 16kW

New 16kW T-CAP Bi-Bloc, ideal for retrofit and commercial applications.



Featured Remote Control

Ease of use and advanced features for install, maintenance and user with the new generation control. Built in F generation Bi-Bloc and new G Generation Mono-Bloc.



Control and connectivity

Integrate Aquarea system to any protocol: KNX, Modbus, BACnet, EnOcean... Or integrate other heating system with Aquarea HPM control and/or control Aquarea from anywhere with Wifi adapter.



DOMESTIC

Domestic Range

Panasonic has developed a range of domestic products designed for you and your clients.

Built in Etherea and Heatcharge range

Anti-allergy Nanoe-G tested by the UK Allergy Association! Get the best for your health with Etherea and Nanoe-G.

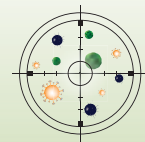

Heatcharge

A+++/A+++ VE Series got the top best energy class for extraordinary energy savings. With Heatcharge technology it ensures highest comfort even at -25°C outdoor ambient temperature.

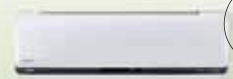

Etherea

Etherea range is bringing to home the most advanced features for heating and cooling. Purifying air with Nanoe-G and ensuring best comfort to people and savings with Econavi sensors.

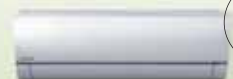

Cassette and Hide Away

New 5,0 and 6,0 kW 4 Way 60x60 Cassette and new 5,0 kW Low Static Pressure Hide Away, more efficiency and more capacity.



Control and connectivity

Control your units from anywhere with the Wifi adapter or Integrate to any protocol: KNX, Modbus or BACnet.



R22 replacement

R22 Renewal. Panasonic units can be install on existing R22 pipings.



COMMERCIAL

Commercial Range

The commercial range is constantly expanding so that you can always offer your clients the best solutions: high performance, silent machines and a complete range of ducts, cassettes and ceiling installations.

Big PACi Hide Away 20-25 kW

New big capacity ducts with DC fans. High efficiency and only from 38dB(A) operation.



Econavi

Econavi for PACi is more than just a sensor. It also analyse occupancy and activity level adjusting operation for improve comfort and reduce energy. Compatible with any PACi and ECDi.



Elite TOP features

Outstanding performance at low temperatures, high energy efficiency, power consumption in remoon display.



Server room solutions

Choose the best solution to ensure any server room needs. Designed for high durability and adverse weather conditions its server room ad hoc control assure permanent operation and failure alarms communications.



Complete AHU Solution

Demand control 0-10V, box IP65 case, cold draft prevention, monitoring status digital output, remote control built-in.



Control and connectivity

Control your units from anywhere with the Wifi adapter or Integrate to any BMS protocol: KNX, Modbus or BACnet.



R22 replacement

R22 Renewal. Panasonic units can be install on existing R22 pipings.



VRF

VRF Systems

The VRF industrial range considerably improves efficiency so even large buildings can benefit from a high-level of comfort with less energy consumption.

New Hydrokit for ECOi

Procudes LT hot water it is compatible with both ECOi, heat pump and heat recovery outdoors.



Multi port heat recovery boxes

New 3 boxes with 4, 6 and 8 ports brings to Heat Recovery systems bigger flexibility in design, and lower installation costs.

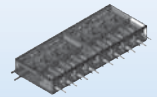

Pump down

Safer installations with refrigerant under control, meet regulations and increase your building energy class.

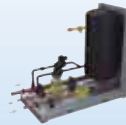

Hotel Remote Control

Indoor unit Hotel Remote control which integrates direct connection to: Card switch, lighting, Window contact and blinds.



Professional Climate Cloud

Centralised control of your business premises, from wherever 24/7. Smartly control, maintain, optimise and save.



Hide Away high pressure 100% Fresh air

New 8HP and 10HP ducted indoor unit with 100% fresh air.



Outstanding performance

Compressor with high capacity range and high performance even at extreme conditions.



Advanced indoors

DC fan motor, discharge temperature sensor, quiet operation, fresh air intake.



ECO G

Unique GHP VRF system: Wide range up to 30HP outdoor module, full indoor and controls compatibility, free hot water up to 75 °C, and heat recovery range.



R22 replacement

R22 Renewal. All Panasonic standard units can be install on existing R22 pipings.



SUMMARY



EDITORIAL

The desire to advance has made Panasonic the international leader in air conditioning. Our industrial capabilities and firm commitment to the environment enable us to open new avenues of research and to develop innovative technologies which can enhance today's way of life.

- 6 PANASONIC, THE AIR OF YOUR LIFE
- 8 RELIABILITY FACTS
- 10 PANASONIC NO. 1
- 12 PANASONIC – LEADING THE WAY IN HEATING AND COOLING
- 14 PRO CLUB

01 AQUAREA

Panasonic's new Aquarea system, based on high-efficiency heat pump technology, not only heats your home and hot water, but also cools your home in summer with incredible operating performance. This creates perfect comfort whatever the weather conditions, even at outdoor temperatures as low as -20°C. Panasonic new heat pumps are designed in response to the new demand for low consumption housing, with high efficiency and low running costs.

- 16 WELCOME TO AQUAREA AIR TO WATER HEAT PUMP
- 18 HIGHLIGHTED FEATURES
- 20 AQUAREA, A CLASS WATER PUMP
- 22 AQUAREA COMPLETELY NEW LINE-UP
- 24 NEW AQUAREA HIGH PERFORMANCE
- 26 NEW AQUAREA T-CAP
- 28 AQUAREA COMMERCIAL
- 30 NEW AQUAREA ALL IN ONE
- 32 CONTROL & CONNECTIVITY
- 32 NEW REMOTE CONTROL
- 33 NEW HEAT PUMP MANAGER
- 34 INTERNET CONTROL
- 35 CONNECTIVITY. CONTROL BY BMS
- 36 PV PANELS + HEAT PUMP MANAGER
- 38 AQUAREA HEAT PUMPS LINE-UP
- 40 AQUAREA ALL IN ONE HIGH PERFORMANCE BI-BLOC SINGLE PHASE HEATING AND COOLING
- 41 AQUAREA ALL IN ONE T-CAP BI-BLOC SINGLE PHASE / THREE PHASE HEATING AND COOLING
- 42 AQUAREA HIGH PERFORMANCE BI-BLOC SINGLE PHASE HEATING ONLY - SDF HEATING AND COOLING - SDC
- 43 AQUAREA T-CAP BI-BLOC SINGLE PHASE / THREE PHASE HEATING AND COOLING - SXC
- 44 AQUAREA HT BI-BLOC SINGLE PHASE / THREE PHASE HEATING ONLY - SHF
- 45 AQUAREA / AQUAREA G GENERATION HIGH PERFORMANCE MONO-BLOC SINGLE PHASE HEATING ONLY - MDF HEATING AND COOLING - MDC
- 46 AQUAREA T-CAP MONO-BLOC SINGLE PHASE / THREE PHASE HEATING ONLY - MXF HEATING AND COOLING - MXC
- 47 AQUAREA G GENERATION T-CAP MONO-BLOC SINGLE PHASE / THREE PHASE HEATING AND COOLING - MXC
- 48 AQUAREA HT / AQUAREA G GENERATION HT MONO-BLOC SINGLE PHASE / THREE PHASE HEATING ONLY - MHF
- 49 AQUAREA HIGH PERFORMANCE MONO-BLOC SINGLE PHASE HEATING ONLY - MDF HEATING AND COOLING - MDC
- 50 SANITARY TANKS
- 51 AQUAREA AIR RADIATORS
- 52 ACCESSORIES
- 52 CONTROL
- 53 EXAMPLES OF INSTALLATIONS WITH AQUAREA MANAGER
- 54 A TYPICAL EXAMPLE OF SAVINGS AND EFFICIENCIES THAT AQUAREA CAN OFFER TO YOU
- 56 DIMENSIONS

02 DOMESTIC

With its innovative design, high efficiency and incomparable purification system, the Etherea range has been designed with your clients in mind. Above all, it is also a range for air conditioning professionals, such as yourself, thanks to its broad range of products which are capable of conditioning rooms of all sizes – always with optimal efficiency and incomparable ease of installation. The Etherea range guarantees that you are offering your clients the very best.

- 58 WELCOME TO DOMESTIC RANGE
- 76 INTERNET CONTROL
- 77 CONNECTIVITY. CONTROL BY BMS
- 78 DOMESTIC AIR CONDITIONER RANGE
- 80 FEATURES EXPLAINED
- 81 FEATURE COMPARISON
- 82 WALL MOUNTED VE INVERTER+ ENERGY CHARGE SYSTEM
- 83 WALL MOUNTED ETHEREA INVERTER+ SILVER PLATED / WHITE
- 84 WALL MOUNTED RE TYPE STANDARD INVERTER
- 85 4 WAY 60x60 CASSETTE INVERTER
- 86 LOW STATIC PRESSURE HIDE AWAY INVERTER
- 87 FLOOR CONSOLE TYPE INVERTER+
- 88 FREE MULTI SYSTEM
- 89 OUTDOOR UNITS FOR FREE MULTI COMBINATIONS
- 90 INDOOR UNITS FOR FREE MULTI COMBINATIONS
- 91 FREE MULTI COMBINATIONS TABLE





03 COMMERCIAL

Panasonic has developed an impressive range of highly efficient Commercial Air Conditioners. This range confirms our commitment to the environment. Our Inverter compressors optimise performance and thus reduce energy costs.

- 100 WELCOME TO THE COMMERCIAL RANGE
- 102 HIGHLIGHTED FEATURES
- 104 PACI STANDARD AND ELITE
- 106 SOLUTIONS FOR SERVER ROOMS
- 108 PACI STANDARD AND ELITE: INDOOR UNITS
- 110 PACI STANDARD AND ELITE: INDOOR UNITS
- 112 RANGE OF COMMERCIAL UNITS
- 114 WALL MOUNTED PKEA
- 116 WALL MOUNTED PACI STANDARD AND ELITE INVERTER+
- 118 4 WAY 60X60 CASSETTE PACI STANDARD AND ELITE INVERTER+
- 120 4 WAY 90X90 CASSETTE PACI STANDARD AND ELITE INVERTER+
- 122 LOW STATIC PRESSURE HIDE AWAY PACI STANDARD AND ELITE INVERTER+
- 124 HIGH STATIC PRESSURE HIDE AWAY PACI STANDARD AND ELITE INVERTER+
- 126 CEILING PACI STANDARD AND ELITE INVERTER+
- 128 HIGH STATIC PRESSURE HIDE AWAY 20-25KW BIG PACI INVERTER+
- 130 PACI TWIN, TRIPLE AND DOUBLE-TWIN SYSTEM
- 134 AIR CURTAIN WITH DX COIL
- 136 AIR CURTAIN WITH DX COIL ELECTRIC AIR CURTAIN
- 138 AIR HANDLING UNIT KIT 10-25 KW FOR PACI
- 140 R22 RENEWAL
- 142 R22 RENEWAL
- 143 CONTROL EQUIPMENT EXTERNAL DIMENSIONS
- 144 PKEA DIMENSIONS
- 145 PACI STANDARD AND ELITE DIMENSIONS



04 VRF SYSTEMS

Professional solutions for all types of projects. The new Panasonic VRF system is specifically designed for energy saving, easy installation and high efficiency performance, with a wide choice of outdoor and indoor unit models and unique features which are designed for the most demanding offices and big buildings. Panasonic VRF Systems: ECOi (Mini ECOi VRF, 2-Pipe ECOi 6N series and 3-Pipe ECOi MF2 series) and ECO G.

- 154 PANASONIC INDUSTRIAL VRF SYSTEMS
- 156 HIGHLIGHTED FEATURES
- 158 PANASONIC IS DEFINITELY THE MOST EFFICIENT SYSTEM THROUGHOUT THE YEARS
- 160 YOUR ENTIRE HOTEL WITH MAXIMUM SAVINGS, MAXIMUM CONTROL AND MAXIMUM COMFORT
- 162 INNOVATIVE SOLUTIONS FOR RETAIL
- 164 LEAK DETECTION AND AUTOMATIC REFRIGERANT PUMP DOWN
- 166 **BEST EFFICIENCY ECOi SERIES FROM PANASONIC**
- 168 2-PIPE MINI ECOi LE1 SERIES
- 174 2-PIPE ECOi 6N SERIES. HIGH-EFFICIENCY AND LARGE-CAPACITY VRF SYSTEM
- 192 3-PIPE ECOi MF2 6N SERIES
- 202 **PANASONIC INTRODUCING THE GAS DRIVEN VRF**
- 204 ECO G OUTDOOR UNITS RANGE
- 205 ECO G HIGH POWER
- 206 ECO G HIGH POWER, ECO G AND ECO G MULTI
- 207 ECO G 3 WAY
- 208 ECO G WATER HEAT EXCHANGER FOR HYDRONIC APPLICATIONS
- 210 ECO G HIGH POWER
- 212 ECO G AND ECO G MULTI
- 214 ECO G 3 WAY
- 216 THE PANASONIC SOLUTION FOR CHILLED AND HOT WATER PRODUCTION!
- 218 ECOi 2-PIPE WITH WATER HEAT EXCHANGER FOR CHILLED AND HOT WATER PRODUCTION
- 220 GHP + VHE HEATING, COOLING AND DHW
- 222 ECO G WITH WATER HEAT EXCHANGER FOR CHILLED AND HOT WATER PRODUCTION
- 224 AQUAREA AIR RADIATORS
- 226 FEATURES
- 227 PANASONIC'S SOFTWARE
- 228 INDOOR UNITS FOR ECOi AND ECO G
- 230 ECOi AND ECO G SYSTEMS INDOOR UNITS RANGE
- 232 U1 TYPE 4 WAY 90X90 CASSETTE SEMI CONCEALED CASSETTE
- 233 Y2 TYPE 4 WAY 60X60 CASSETTE MINI SEMI CONCEALED CASSETTE
- 234 L1 TYPE 2 WAY CASSETTE
- 235 D1 TYPE 1 WAY CASSETTE
- 236 F2 TYPE VARIABLE STATIC PRESSURE HIDE AWAY
- 237 M1 TYPE SLIM VARIABLE STATIC PRESSURE HIDE AWAY CONCEALED DUCT
- 238 E2 TYPE HIGH STATIC PRESSURE HIDE AWAY
- 239 HEAT RECOVERY WITH DX COIL
- 240 T2 TYPE CEILING
- 241 K2/K1 TYPE WALL MOUNTED
- 242 P1 TYPE FLOOR STANDING R1 TYPE CONCEALED FLOOR STANDING
- 243 HYDROKIT FOR ECOi WATER AT 45 °C
- 244 **PANASONIC VENTILATION SOLUTIONS**
- 246 AIR HANDLING UNIT KIT
- 250 AIR CURTAIN WITH DX COIL, CONNECTED TO THE VRF OR PACI SYSTEMS
- 254 ENERGY RECOVERY VENTILATOR
- 258 R22 RENEWAL
- 260 BRANCHES
- 264 HEADERS
- 265 CONTROL EQUIPMENT EXTERNAL DIMENSIONS
- 266 ECOi AND ECO G INDOOR UNITS DIMENSIONS



05 CONTROL AND CONNECTIVITY

Panasonic has developed the largest range of control systems to offer the best option to each need. From the individual remote control for the residential single units up to the newest technology to control each your buildings around the world from an easy to use software in the cloud by your portable device.

- 274 CONTROL AND CONNECTIVITY
- 276 PANASONIC SMART CLOUD
- 278 REMOTE CONTROLLER WITH ECONAVI
- 280 ECONAVI SENSOR
- 283 CONTROL SYSTEMS FOR PACI, ECOi AND ECO G
- 284 CONTROL FOR HOTEL APPLICATION
- 286 INDIVIDUAL CONTROL SYSTEMS
- 288 CENTRALISED CONTROL SYSTEMS
- 295 PACI AND VRF CONTROL
- 296 PACI AND VRF CONNECTIVITY PACI CONNECTIVITY
- 297 ECOi AND GHP CONNECTIVITY
- 298 ECOi, ECO G AND PACI CONNECTIVITY INDOOR UNITS

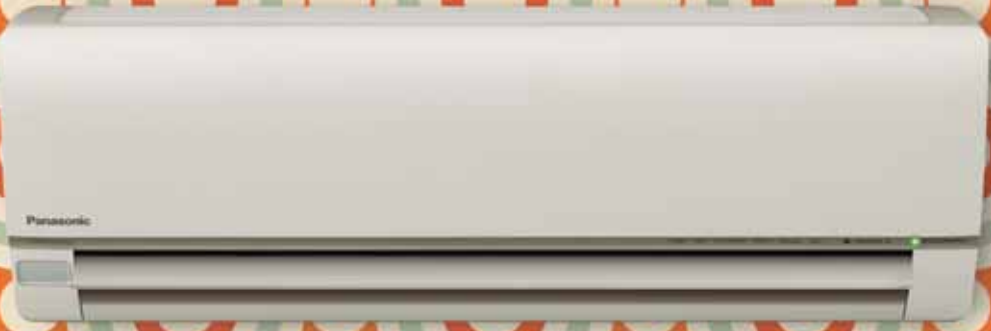

Panasonic,
the Air of your Life
Since 1958

Panasonic, the Air of your Life

Panasonic Air Conditioners have been with us since 1958. In many homes they are part of the family and are, in part, responsible for the air that each member breathes.

Many things happen in your home, and Panasonic makes sure that those moments have the best climate. Panasonic Air Conditioners were the first to produce Healthy Air, and also worry about being super-efficient and quiet. Which is why they have been among us for so long.



1958

First room air conditioner launched for domestic installation.



1973

Panasonic launches the first highly efficient air-to-water heat pump in Japan.



1975

Panasonic becomes the first Japanese air conditioner manufacturer in Europe.



2008

Etherea new concept of air conditioning systems: high efficiency and high performances with a great design.



No.1
in Japan

40 years
in Europe

History of Air Conditioning Group

Panasonic starts with a desire to create things of value. As hard work and dedication results in one innovative product after another, the fledgling company takes its first steps towards becoming the electronics giant of today.



2010

New Aquarea. Panasonic has created Aquarea, an innovative new, low-energy system.



2011

The new Panasonic ECOi VRF solution for big buildings is the most efficient in the industry in more than 74% of combinations.



2012

New GHP units. Panasonic's gas-driven VRF systems are ideal for projects where power restrictions apply.



Looking ahead

By creating, storing, managing and saving energy, Panasonic aims to realize a lifestyle with virtually zero CO₂ emissions throughout the entire home.



Reliability facts

Reliable comfort comes from reliable technologies

Today, Panasonic air conditioners have earned widespread acclaim throughout the world. A rugged design ensures that the air conditioner will continue to keep the room comfortable, and operate trouble-free for many years. Panasonic believes this is the true value of an air conditioner. And this is why we subject them to a wide range of stringent tests.

Durability. Long Time Continuous Operation Simulation.



Long-term Durability Test

The air conditioner's main mission is to provide a level of durability that allows it to operate stably for years. In order to achieve this, we conduct an accelerated test for 10,000 hours of continuous operation. The results of this test, which is conducted under conditions that are much more severe than actual operating conditions, prove the rugged strength of Panasonic air conditioners.



Compressor Disassembly Test

After a test with 10,000 hours of continuous operation, we remove the compressor from a randomly selected outdoor unit, disassemble it, then examine the internal mechanisms and parts for possible failure. Panasonic air conditioners continue to provide their designed performance for many years even after prolonged operation under harsh conditions.



Operating Test in Harsh Conditions

In addition to normal operating conditions, an operating durability test is conducted in a high-temperature, high humidity test chamber at a temperature of 55 °C. For use in cold climates, the test is also conducted in a low temperature test chamber at -20°C. This test assures that the oil inside the compressor will not freeze during use and interrupt operation.



Checking the oil inside the compressor under extremely cold conditions.



Waterproof Test

The outdoor unit, which is subject to rain and wind, is provided with IPX4 waterproof compliance. Contact sections on printed circuit boards are also resin-potted to prevent adverse effects caused by an unlikely exposure to droplets of water.



A resin-potted circuit board.



Shock Resistance

Panasonic simulates impacts, vibrations and other environmental conditions that air conditioners might be subjected to during transport. We promise that the quality and performance at the time of the final product inspection are unchanged when the product reaches the user's home.

No Breaking. When Dropped onto Sides or Corners.



Drop Test

Even with the large impacts that may occur due to improper handling during transportation, the product packaging has been strengthened to prevent it from being damaged. In addition to conventional vertical dropping, more severe conditions in which the sides or corners hit the floor first are carefully tested to ensure that the product's rigidity and shock-absorbing materials work to prevent problems.

Vibration Test

Preventing damage that would hinder the product's performance due to vibration during transport is a major role of the packaging. Panasonic confirms that the product operates properly even after applying vibrations in both horizontal and vertical directions.

Warehouse Storage Test

During distribution, products may be subjected to extended warehouse storage under unfavourable conditions. To simulate these conditions, we place a weight equal to a stack of five product packages on top of the test package, and leave it in that condition in a room at a temperature of 27 °C and a humidity level of 85%. Then, the product is checked for proper operation.



Comfort

Air conditioners should keep each person in the room comfortable without making their presence known. They should work totally in the background, using their strength to create and maintain a relaxing environment. We build this hidden strength into our air conditioners, and test them repeatedly from this viewpoint.

Silence. That Does Not Disturb You.



Noise Test

The operating noise of the indoor and outdoor units is measured in an echo-free chamber. The noise test verifies that the operating noise is low enough so that the product operation will not disturb daily activities including conversations and sleep.

Amenity Test

An actual air conditioner is operated in a test room that simulates an ordinary living room. Conditions such as the amount of sunlight entering the room from outside are changed while measuring a variety of parameters, such as cooling speed, cooling efficiency, and temperature and humidity differences throughout the room. This makes it possible to confirm whether the air conditioner is operating at its designed performance level under ordinary conditions.

EMC (Electromagnetic Compatibility) Test

This test determines whether electromagnetic waves emitted during operation are sufficiently low to prevent adverse effects, i.e., electrical noise, on signals such as TV and radio broadcasts.

Remote Control Dropping Test

Because the remote control is the main interface between people and the air conditioner, it is naturally subjected to frequent impacts - such as drops and bumps - when it is passed from person to person during normal operation. Panasonic drops the remote control from a height of 1.5 metres at various angles to ensure that no problems in basic performance will result from accidental dropping.



Sunshine simulation.



World Standard Quality

Over the years, Panasonic air conditioners have continued to offer the highest possible quality with the lowest environmental impact worldwide. Naturally, the fundamental production principles that are common to all Panasonic products apply to air conditioners as well. The fact that these principles actively support every product, rather than simply serving as slogans, is the result of the endless repetition of challenges and trial-and-error efforts that are conducted at our production bases all over the world.

Quality. Is at the Core of All Our Manufacturing.



Reliable Parts with Major Standards Approval

Panasonic air conditioners comply with all of the major standards that maintain high reliability in the countries and regions where they are marketed. To ensure this, we conduct a variety of tests to examine the quality of materials used in parts.

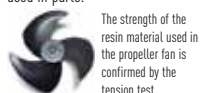

The strength of the resin material used in the propeller fan is confirmed by the tension test.

RoHS/REACH Compliant Parts

All parts and materials comply with RoHS/REACH, Europe's world-leading environmental regulations. Stringent inspections of more than 100 materials are conducted to ensure that no hazardous substances are included during parts development.

Sophisticated Production Process

The air conditioner production line uses advanced, state-of-the-art factory automation technologies to produce products with higher reliability. Products are efficiently manufactured with high and uniform quality.

Eco Activities

Panasonic has set up eco ideas factories around the globe. While developing and manufacturing energy-saving products based on original environmental technologies, these factories reduce CO2 emissions from manufacturing processes and conduct regional-based environmental communication activities to contribute to both the global environment and the local communities that they serve.



**BEST
GLOBAL
GREEN
BRANDS
2014**

Interbrand | Deloitte

Panasonic No. 1

Interbrand Ranks Panasonic No. 1 in the Electronics Sector for the “Best Global Green Brands 2014”

Interbrand, the US brand consulting company, announced on June 24th, 2014, that Panasonic ranks No. 5 in its Best Global Green Brands 2014. Although a rank lower than last year, the company has come out top in the electronics sector.

2014 marks the fourth year for this global ranking of “green brands.” An Excellent Green Brand is defined as achieving a good balance between Green Perception (consumers’ image of an eco-brand) and Green Performance (a company’s environmental management practices). The top 50 companies are ranked based on these two elements.

Evaluation Points

Panasonic’s Green Performance was evaluated as being especially high, with excellent marks going to “Products and Services,” “Governance,” and “Transportation and Logistics.”

Interbrand also noted the following points in its evaluation

Energy Star Award Recognitions: Panasonic has received more Energy Star awards than any other consumer electronics manufacturer.

Achieved a Recycling Rate of 99.3%: Taking steps toward zero waste, Panasonic achieved a factory waste recycling rate of 99.3% in 2013.

Improved Water Usage: In 2013, water usage at factories per basic unit of production improved by 0.7% compared with 2012.

Econavi Function: In 2009, Panasonic launched home appliances with the Econavi function, which automatically controls power and water consumption to cut losses by using sensor and other energy efficient technologies.

We aim to realise a lifestyle with virtually zero CO₂ emissions throughout the entire home

By creating, storing, managing and saving energy, Panasonic aims to realise a lifestyle with virtually zero CO₂ emissions throughout the entire home.

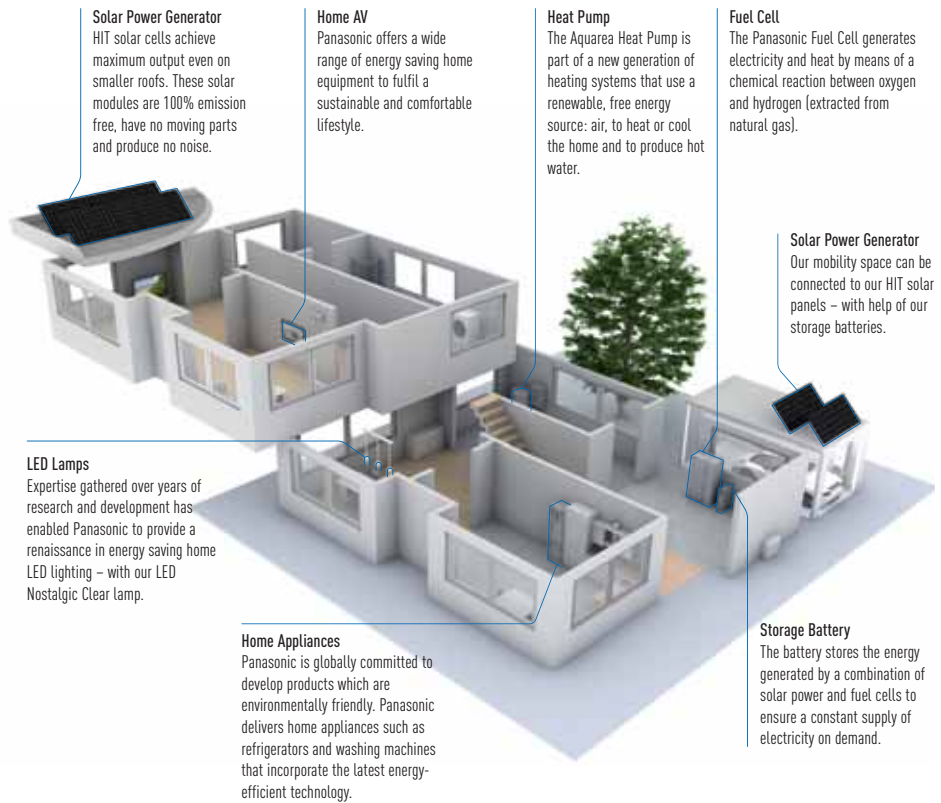

Exemplary sustainable projects

What is Smart Electric Lyon?

Smart Electric Lyon is a project that looks at electricity consumption as a key part of the building energy solutions of tomorrow. This experiment, will be conducted for four years in more than 25,000 homes, businesses and communities of Grand Lyon. Panasonic will provide the project with a variety of its energy efficient heating and cooling products, including the Aquarea Air Source Heat Pump. These heat pumps are especially equipped with connectivity solutions from Panasonic to ensure the systems are easy to use, and collect the vital, accurate data. This project is particularly apt for Panasonic, as heating and hot water occupy a prominent place in household energy consumption. The company has involved for the project a dedicated and experienced R&D team from Panasonic’s European technical centre in Frankfurt.



Fujisawa Sustainable Smart Town Goes Into Full-Scale Operation Near Tokyo

Fujisawa SST Council, a consortium led by Panasonic Corporation spearheading the development of the Fujisawa Sustainable Smart Town (Fujisawa SST). With its core facility supporting sustainable development of the town and its community now coming into operation, the Fujisawa SST is moving from the construction stage into a new stage where the town is nurtured to grow in full-scale into an eco and smart town that puts a high priority on the residents’ lifestyles.

The Fujisawa SST Management Company is the town management company located in the SQUARE. Together with partner companies, the

company provides five essential services in the town: energy, security, mobility, healthcare and community. The company will also collect and manage information pertaining to the town’s overall environment, energy, security and safety to support an eco and smart life in the town. As a fresh development in the town, the Fujisawa SST has set a detached housing zone for non car owners for the second phase of sales. By using the town’s eco-car sharing and rent-a-car services, residents in the zone can enjoy their lifestyles without the need to own a car while reducing economic burden and making effective use of the lot. Preparations are also underway for a new base to provide environmentally-friendly logistic services to the residents.





heating & cooling solutions



Panasonic – leading the way in Heating and Cooling

With more than 30 years of experience, selling to more than 120 countries around the world, Panasonic is unquestionably one of the leaders in the heating and cooling sector. With a diverse network of production and R&D facilities, Panasonic delivers innovative products incorporating cutting-edge technologies that set the standard for air conditioners worldwide. Expanding globally, Panasonic provides superior international products transcending borders.

100% Panasonic: we control the process

The company is also a world leader in innovation as it has filed more than 91,539 patents to improve its customers' lives. Moreover, Panasonic is determined to remain at the forefront of its market. In all, the company has produced more than 200 million compressors and its products are manufactured in 294 plants which are located all over the world. You can be assured of the extremely high quality of Panasonic's heat pumps.

This wish to excel has made Panasonic the international leader in heating and turn-key air conditioning solutions. These offer maximum effectiveness, comply with the strictest environmental standards and meet the most avant-garde construction requirements of our time.

Projects & Case Studies of Panasonic Heating and Cooling Solutions



Call centre retrofit. Woodhouse Environmental Services Ltd. Bourmemouth, UK. **VRF**



New residential building. 84 apartments. Barcelona, Spain. **Aquarea**



New condominium. Bergås Terrasse complex. Drammen, Norway. **ECOi / Aquarea**



Hotel refurbishment. Hotel Claris 5 * Barcelona, Spain. **ECOi**



New residential building. 176 flats Xàtiva, Spain. **ECO G**



French Winery. Boutiers-Saint-Trojan, France. **ECO G**



Le Centurie Centro Commerciale. 40,000 m² with 40 commercial spaces. Padua, Italy. **ECOi**



Europa-Park is the second most popular theme park resort. 300 rooms. Germany. **ECOi**



The National Grid's. Call Center refurbishment. Hinkley, UK. **ECO G**



The exclusive Sunprime Atlantic View resort, owned by Thomas Cook. 220 rooms. Canary Islands. Spain. **ECO G**



Montcenis Nursing Home. Over 6100 m² and 85 rooms. Saône et Loire, France. **ECO-G**



Smart House. Ariake, Tokyo. **HVAC and the combination of solar power generation, fuel cells and storage batteries.**



Technopark of Nobosibirsk Academgorodok. Novosibirsk, Russia. **ECOi**



Shippensburg University. Pennsylvania, United States. **ECOi**



Urban residential Mosaic Panama Pacifico. Republic of Panama. **Mini ECOi**



Patra Jasa Bandung Hotel. Bandung, Indonesia. **ECOi**

To find out more: www.aircon.panasonic.co.uk



PRO Club 

PRO Club

the professional website of Panasonic

Panasonic has an impressive range of support services for designers, market, engineers and distributors working in the heating and cooling markets.

Panasonic PRO Club (www.panasonicproclub.com) is the online tool which makes your life easier! You just have to register and a lot of functionalities are freely available to you, where ever you are, from your computer or smart phone!

- **Print catalogues with your logo and your address**
- **Download the latest Aquarea designer to define your system and select the good Aquarea Heat pump.**
- **Calculate the specs of the Aquarea Air fan coil based on the parameters of your system**
- **Get Documents of conformity and all other documents you may need**
- **Download all the service manuals, end user manuals and installation manuals**
- **Know what to do with error codes**
- **Find out about the latest news first**
- **Register for training**

Highlighted Features

- Extensive library of resources
- Tools & Apps for end users. Check availability in your country:
 - My Home: sizing wizard for domestic and A2W range
 - My Project: Contact form to Panasonic team
 - iFinder: Lists of installers displayed by postcode
- Special offers & promotions
- Training PRO Academy
- Catalogues (Commercial documentation)
- Marketing (Images in high resolution, advertisements, deco guidelines)
- Tools (Professional software, sizing tools...)

NEW Highlighted Features

- **NEW!** Installers customize leaflets in PDF format with their logo & contact details
- **NEW!** Energy label generator. Download energy labels of any device in PDF format
- **NEW!** Heating calculator demand
- **NEW!** Noise calculator for outdoor unit
- **NEW!** Aquarea Radiator calculator
- **NEW!** Error Code Search by error code or unit ref. Compatible with smartphone and tablet computer
- **NEW!** Revit / CAD Images / Spec texts
- **NEW!** Access to Pananet, online library of technical documentation
- **NEW!** Download Documents of Conformity and other Certifications
- **NEW!** Commissioning online

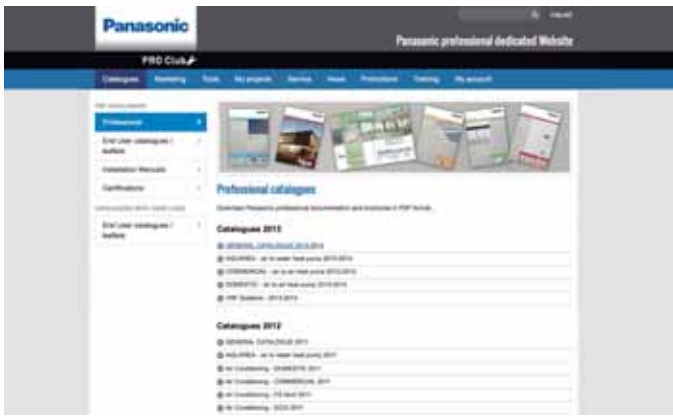

NEW! Easy download Panasonic service documentation and brochures



Panasonic PRO Club is fully compatible with tablet computer and smartphone



NEW! Customize leaflets with your logo & contact details. Save and print the PDF



The Panasonic PRO Academy

Panasonic takes its responsibility to its distributors, specifiers and installers seriously and has developed a comprehensive Training Programme. The Panasonic Pro-Academy encompasses the traditional hands-on approach.

New training courses cover three levels. Design, installation, and commissioning & trouble-shooting. Training courses include:

- Domestic applications Air to Air
- Aquarea air source heat pumps
- VRF ECOi

The courses are offered on site at Panasonic's premises across Europe as well as via the Panasonic ProClub eLearning site. The Training Centres display Panasonic's latest product range and give delegates an opportunity to get hands-on experience with the latest controllers, indoor and outdoor units from the VRF ECOi, Etheera, GHP and Aquarea ranges.



NEW! Energy label generator. Download Energy labels of any device in PDF format



NEW! Error Code on your smartphone and your PC: Search by error code or model reference. Online version + downloadable version for offline use



PRO Club

www.panasonicproclub.com

or connect simply with your smartphone to the PRO Club using this QR



ErP
ready
2015



AQUAREA



* Not all products certified. As the certification process is on-going and the list of certified products constantly changing, please check for latest details on the official websites.



WELCOME TO AQUAREA AIR TO WATER HEAT PUMP

Aquarea's new Air to Water Heat Pump for residential and commercial applications

Offering capacities from 3kW all the way through to 16kW, the Aquarea Heat Pump Range is the widest on the market, ensuring a system is available, whatever your heating and cooling needs. Suitable for new build and refurbishment projects, the systems are cost-effective and environmentally friendly.



Highlighted Features

Panasonic's Aquarea range of heat pumps deliver major energy savings thanks to its incredible efficiency even at -20°C

Aquarea is part of a new generation of heating systems that use a renewable, free energy source (the air) to heat or cool the home and to produce hot water:

- Extremely high efficiency (COP of 5.08 for new 5kW Mono-Bloc unit)
- Line up developed for low consumption homes (starting at 3kW)
- T-CAP solution is ideal for cold areas, as it maintains the nominal capacity up to -15 °C
- Easy to control with your smart phone (using an optional interface)
- Large range of efficient tanks for domestic hot water storage

The Panasonic Aquarea Heat Pumps are designed and produced by Panasonic and not by other companies.



ENERGY SAVING

ErP ready
2015

ErP ready 2015 applies to European directive for energy related products. Our products are ErP ready based on preliminary data.

A class water pump
HIGH EFFICIENCY

Aquarea Bi-Bloc F Generation and normal G Generation are built-in with A class water pump.

High efficiency heating
INVERTER +

The A Inverter+ system provides energy savings of up to 30% compared to non Inverter models. Both you, and nature, win!

Environmentally friendly refrigerant
R410A / R407C

Refrigerant R410A / R407C offers optimal performance and involves no environmental cost since it does not harm the ozone layer.

Down to -20 °C in heating mode
OUTDOOR TEMPERATURE

Down to -20 °C in heating mode. The Heat Pumps work in heat pump mode with an outdoor temperature as low as -20 °C.

5,08 COP high efficiency
AQUAREA HIGH PERFORMANCE

Aquarea High Performance for low consumption houses. From 3 to 16 kW. For a house with low temperature radiators or under-floor heating, our high performance Aquarea HP is a good solution.

100% capacity at -15 °C
AQUAREA T-CAP

Aquarea T-CAP for extremely low temperatures. From 9 to 16 kW. If the most important aspect is to maintain nominal heating capacities even at temperatures as low as -7 °C or -15 °C, select the Aquarea T-CAP.

Output water 65 °C
HIGH TEMP HEAT PUMP

Aquarea HT ideal for retrofit. From 9 to 12 kW. For a house with traditional high-temperature radiators, the Aquarea HT Solution is the most appropriate as the Aquarea HT it can work in output water temperatures of 65 °C even at outdoor temperatures as low as -20 °C.

Internet Control Ready
INTERNET CONTROL

Internet Control is a next generation system providing a user-friendly remote control of air conditioning or heat pump units from everywhere, using a simple Android or iOS smartphone, tablet or PC via internet.



Thanks to Aquarea HPM, Aquarea range (Bi-Bloc and Mono-Bloc) is holding the SG Ready Label (Smart Grid Ready Label), given by Bundesverband Wärmepumpe (German Heat Pump Association). This Label shows the real capacity of Aquarea to be connected in an intelligent grid control.

HIGH CONNECTIVITY

Boiler connection
RETROFIT

Renovation. Our Aquarea heat pumps can be connected to an existing or new boiler for optimum comfort even at very low outdoor temperatures.

Solar panels connection
SOLAR KIT

Solar Kit. For even greater efficiency, our Aquarea heat pumps can be connected to photovoltaic solar panels with an optional kit.

Domestic hot water
DHW

DHW. With Aquarea you can also heat your domestic hot water at a very low cost with the optional hot water cylinder.

Easy control by BMS
CONNECTIVITY

Connectivity. The communication port is integrated into the indoor unit and provides easy connection to, and control of, your Panasonic heat pump to your home or building management system.

5 year compressor warranty

5 years compressor warranty only for PRO Partners.

7 years warranty extension

7 years warranty cost option for PRO Partners

~~AQUAREA~~



A class
water pump

HIGH EFFICIENCY

Aquarea, A class water pump

Panasonic's new Aquarea air to water system can work in outdoor temperature even at -20°C

Panasonic's new Aquarea system, based on high-efficiency heat pump technology, not only heats your home and hot water, but also cools your home in summer with incredible operating performance. This creates perfect comfort whatever the weather conditions, even at outdoor temperatures as low as -20°C. Panasonic new heat pumps are designed in response to the new demand for low consumption housing, with high efficiency and low running costs.

Impressive Energy Savings: Panasonic's Aquarea Heat Pump provides savings of up to 80% on heating expenses compared to electrical heaters.

Why air source heat pumps?

- Reduced heating bills and maintenance costs
- Savings of up to Euro 1,000 a year are possible. 30%-40% reduction in annual energy bills
- Reduce your carbon footprint
- Simple to integrate into most heating systems
- Energy efficient alternative to oil, LPG and electric systems
- Highly compatible with other energy efficient energy sources eg solar panels
- Provides sustainable heating, cooling and hot water for your home
- Ideal for properties without access to mains gas
- Externally positioned saving valuable internal living space
- Proven technology from Panasonic and already well established in other EU countries



Up to 80% energy savings*

At the forefront of energy innovation, Aquarea is resolutely positioned as a “green” heating and air-conditioning system. Aquarea is part of a new generation of heating and air-conditioning systems that use a renewable, free energy source – the air – to heat or cool the home and to produce hot water. The Aquarea heat pump is a much more flexible and cost-effective alternative to a traditional fossil fuel boiler.

“Green” High-efficiency heating with Panasonic’s new Air to Water Heat Pump Systems

Panasonic’s Aquarea Heat Pump provides savings of up to 80% on heating expenses compared to electrical heaters. For example, the Aquarea 5kW system has a COP of 5,08. This is 4,08 more than a conventional electrical heating system which has a maximum COP of 1. This is equivalent to an 80%* saving. Consumption can be further reduced by connecting photovoltaic solar panels to the Aquarea system.

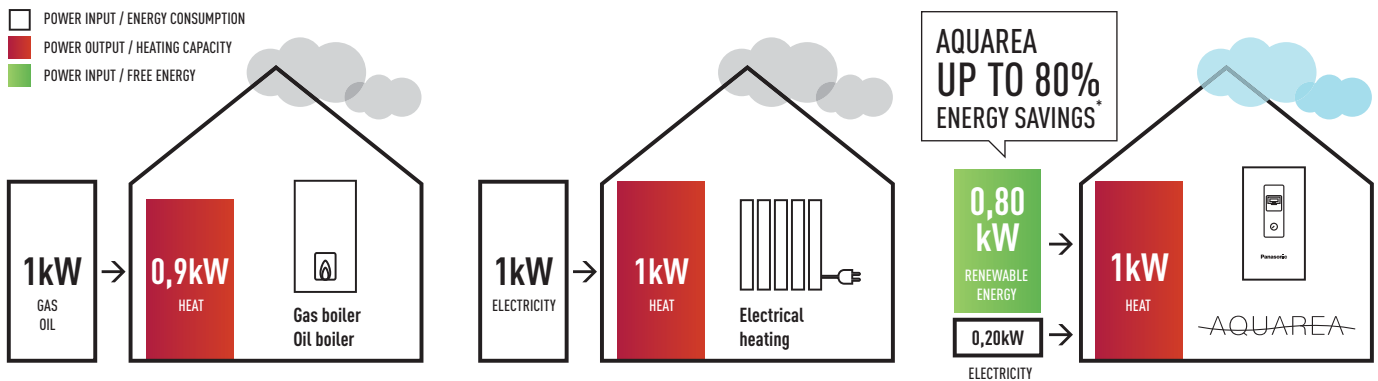

* Up to 80% of the heat produced by a heat pump is free, since it comes from the outdoor air. Rating conditions: Heating: Inside air temperature: 20°C Dry Bulb / Outside air temperature: 7 °C Dry Bulb / 6°C Wet Bulb. Conditions : Water input temperature: 30°C Water output temperature: 35 °C

Inverter+ compressor for even greater efficiency

Panasonic has clearly demonstrated its status as leaders in this field with over 200 million compressors supplied and the excellent quality and reliability of its heat pumps. With a Panasonic Inverter+ compressor, you can save up to 30% energy compared to a traditional system with no inverter. With a Panasonic Inverter compressor, the heat pump is always producing heat with the maximum of efficiency and adapting the capacity to the element.

The advantages of inverter heat pumps. Comparing Inverter and non-Inverter heat pumps.

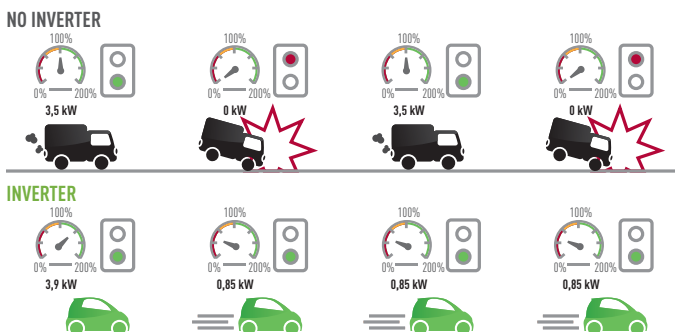

NO INVERTER Slow to start. Takes longer to reach the temperature set point. The temperature oscillates between the two extremes and never stabilises. The temperature falls and then rises quickly, leading to a consumption peak.

INVERTER Rapidly reaches the desired temperature. Adjusts the temperature: more comfort and greater savings. Keeps the temperature comfortable all the time.

“We expect to save around 1,000 € a year on fuel costs and we’ve been able to get rid of a large ugly oil tank in the garden thanks to the new Aquarea.”

Aquarea Customer, Surrey¹



1) Information provided by Aquarea customer, August 2012.

5,08 COP
high efficiency
AQUAREA
HIGH PERFORMANCE



100%
capacity
at -15 °C
AQUAREA T-CAP



Output water
65 °C
HIGH TEMP
HEAT PUMP



Aquarea completely new line-up

Panasonic has designed a completely new line-up to offer the best to our customers.

There are several types of heat pump available:

- The Mono-Bloc system: This only has an outdoor unit. The installation doesn't require a refrigerated connection and is only connected to the heating and/or hot water.
- The Bi-Bloc system: The system, separate indoor and outdoor units, connects to the heating and/or hot water system.
- New All in One: Hydromodule + 200l tank. Panasonic has developed a highly efficient solution, easy to install.

A wide range from 3 to 16kW, Single and Three Phase, Mono-Bloc and Bi-Bloc. 3 Versions:

Aquarea High Performance for low consumption houses. From 3 to 16kW

For a house with low temperature radiators or under-floor heating, our high performance Aquarea HP is a good solution. This solution can work as a stand-alone unit or can be combined with an existing gas- or oil-fired heating system depending on requirements. This new solution is ideal for low consumption homes.

Aquarea T-CAP. From 9 to 16kW

If the most important aspect is to maintain nominal heating capacities even at temperatures as low as -7 °C or -15 °C, select the Aquarea T-CAP. This ensures that there is always enough capacity to heat the house without help from an external boiler – even at extremely low temperatures. Aquarea T-CAP always has high efficiency and high heating capacity even at extremely low temperatures. With Aquarea T-CAP, you can always enjoy high savings.

Aquarea HT. From 9 to 12kW

For a house with traditional high-temperature radiators (such as cast iron radiators), the Aquarea HT Solution is the most appropriate as the Aquarea HT can work in output water temperatures of 65 °C even at outdoor temperatures as low as -20°C. Aquarea HT is able to deliver hot water to 65 °C with the Heat Pump alone.

1) For WH-MDC05F3E5.



1b

Bi-Bloc option

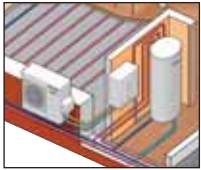

1c

New All in One option



1a

1b

1c

2



3



KNX
Modbus®

Aquarea outdoor air source heat pumps

Panasonic has developed an extensive range of air-to-water heat pumps designed to efficiently convert free air into sustainable heating and hot water. Fitted externally to your home and designed to operate in all year round weather conditions (-20°C), it's the smart alternative to oil, LPG and electric heating systems.

Aquarea Heat Pump Manager (Optional)

This new generation of smart controllers for eco-efficient heating, features our versatile stand-alone controller not only for our heat pump systems, but also your gas, oil boiler and all other devices installed on your heating system.

Heating control App for smart phone, tablet or computer (Optional)

The heating control App allows you to control the heating and hot water system via your smart phone, tablet or computer with ease, whether at home or away. The heat pump can be also connected to house management system using KNX or Modbus.



4

Efficient tanks: PAW-TE18/30/40C2E3STD-UK

- Efficient tanks for sanitary water production.
- Secondary coil available to improve the sanitary hot water production or to connect a solar thermal system

5



High efficient radiators for heating and cooling (Optional)

- High efficient radiators working with water at 35 °C.
 - No need for two kits if both floor heating and radiators are required.
 - As the product is efficient, it opens the possibility to also provide cooling while still meeting construction requirements.
- Panasonic offers a cooling mode within its heat pump range for low consumption homes**

6



Heat Pump + HIT Photovoltaic solar panel (Optional)

Photovoltaic solar panels: the best solution for big savings. Combining photovoltaic solar panels with your heat pump can help to further reduce your electrical consumption and CO₂ emissions. Additionally, with the unique HIT photovoltaic solar panel technology from Panasonic, you can produce more electricity per square metre, helping you to increase your energy savings still further.

FOR NEW INSTALLATIONS AND LOW CONSUMPTION HOMES

5,08 COP
high efficiency
AQUAREA
HIGH PERFORMANCE

NEW AQUAREA ALL IN ONE



NEW AQUAREA 5KW MONO-BLOC



New Aquarea High Performance

For new installations and low consumption homes. Maximum savings, maximum efficiency, minimum CO₂ emissions, minimum of space.

Panasonic has designed the new Aquarea Bi-Bloc and Mono-Bloc heat pumps for homes which have high performance requirements.

Whatever the weather, Aquarea can work even at -20°C! The New Aquarea is easy to install on new or existing installations, in all types of properties.

High Performance helps you to meet strict building requirements and reduce building costs

The heating and production of hot water have a very important impact on the energy consumption of a house. Efficient Panasonic heat pumps can help to significantly reduce the energy consumption of the house.

Total energy consumption of a conventional house, compared to the energy consumption with Panasonic heat pumps

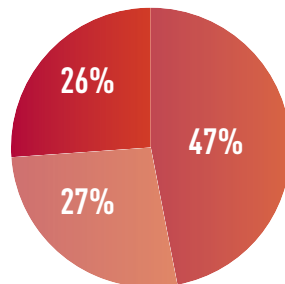

Total energy consumption of a conventional house¹

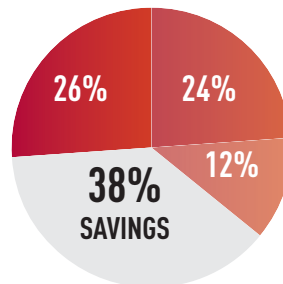

Energy consumption with Panasonic heat pumps²

- Heating
- Sanitary Hot Water
- Domestic Appliances³

1. Source: IDEA, European values 2010. Consumption of a conventional house of 80 kWh/(m².year).
 2. Source: Panasonic, RT2012 simulation, house of 50 kWh/(m².year) per year, equipped by Panasonic heat pump.
 3. Eg. Fridge telephone, oven,....

Key points of the line-up

- A Class water pump significantly reduces the energy consumption
- A Class water pump adapts water pressure according to demand, reducing energy consumption, noise on the valves, and makes installation easy.
- No Backup heater needed to maintain the capacity at -15 °C, high efficiency guaranteed even at -15 °C
- Many new remote control functions added:
Auto mode, holiday mode, show power consumption

High Performance Pumps are also Highly Efficient

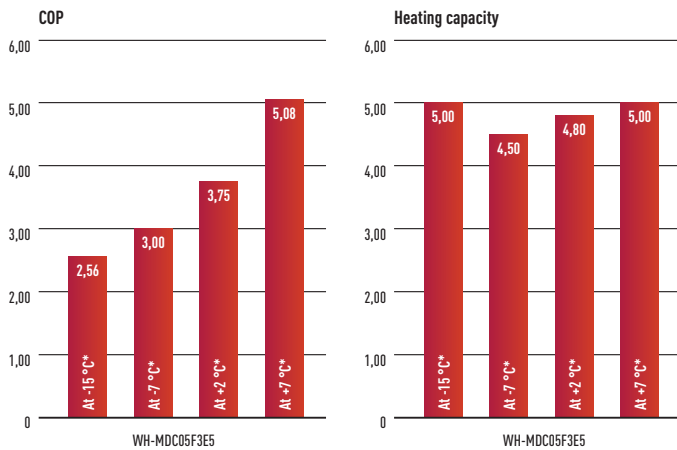

* Heating water at 35 °C.

Comparison of energy consumption - Standard pumps vs A class water pump

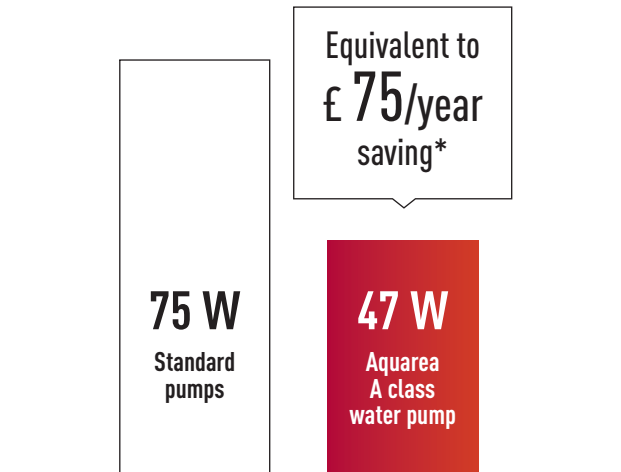

New A class water pump with Constant water flow (Dynamic pump control) for 5kW Mono-Block

* Based on German market: Assuming Standard pump may vary depending on consumption and energy cost.

With a Panasonic heat pump, there is no need to oversize the heat pump to reach the required capacity at low temperatures.

- Dedicated software for low consumption houses which allows the heat pump to produce hot water at 20°C. This is needed during the seasons, when a little heating is required
- No need for an additional expansion vessel, as the unit already has a 6l expansion vessel
- No buffer tank required as the Panasonic heat pump has an inverter compressor which can regulate the capacity. (Please check on the service manual the minimum volume of water needed on the circuit)
- 3kW electrical heater is included on the heat pump
- Panasonic heat pumps can work in outdoor temperatures as low as -20°C and guarantee the capacity without backup heating down to -15 °C
- Panasonic heat pumps are very quiet and have a night mode program for even lower noise. See noise calculator on www.panasonicproclub.com

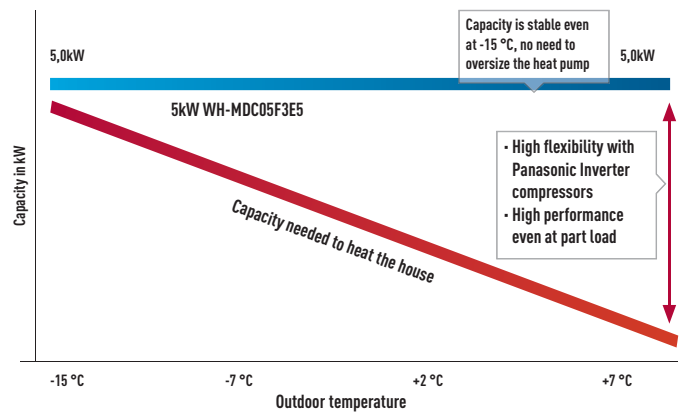

Special attention has been given to noise levels - Panasonic created a night mode to reduce the noise when it's needed.

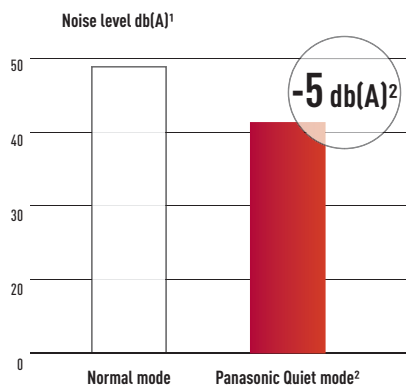

1. Sound pressure measured at 1 m from the outdoor unit and at 1,5 m height.
2. At standard condition working at heating capacity at +7 °C (heating water at 35 °C) for two fans outdoor units. For one fan outdoor units, night mode reduction is 3db(A).

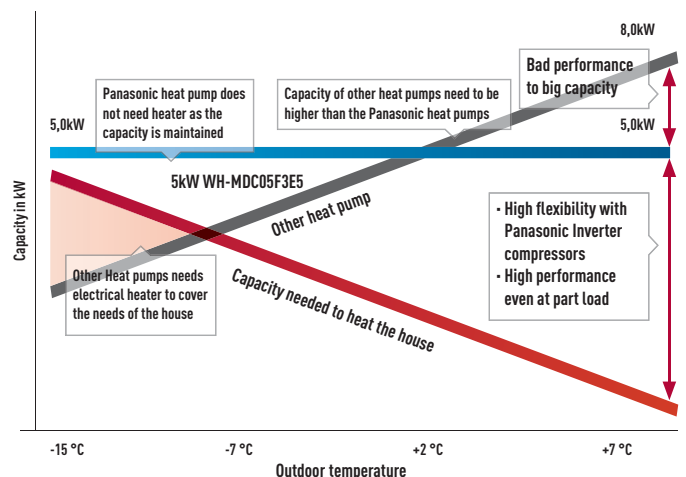

**NEW T-CAP FOR
EXTREMELY LOW
TEMPERATURES**



100%
capacity
at -15 °C
AQUAREA T-CAP

**NEW AQUAREA
ALL IN ONE**



**NEW AQUAREA
16kW BI-BLOC**



New Aquarea T-CAP

For extremely low temperatures. Install A class water pump: Industry top class energy-saving!

The whole T-CAP line-up can replace old gas or oil boilers, and in a new application with under floor heating, low temperature radiators or even fan-coil heaters. This range can also be connected to a solar kit in order to increase efficiency and minimize the impact on the ecosystem. Finally, it is possible to connect a thermostat for even better heating or cooling control and management.

- T-CAP stands for Total Capacity. This line-up is able to maintain the same nominal capacity even at -15 °C without the help of an electrical booster heater.
- High heating capacity even at low ambient temperatures.
- Maintains capacity of 16 kW until -15 °C outdoor temperature. Adding many new functions: Auto mode, Holiday mode, power consumption display.

The New T-CAP range has extended with the addition of the 16kW pump

The new 16kW maintains full capacity of 16kW even at outdoor temperatures down to -15 °C. The 16kW fits perfectly to retrofit houses, as well as to commercial applications to heat and cool the applications and also to provide sanitary hot water.

New Aquarea T-CAP. High capacity improvement at low ambient & high efficiency

Enhance larger capacity (16kW)

More Energy saving with A class water pump.

Adding new functions

Auto mode, Holiday mode, Displays power consumption, New de-ice control, Concrete Dry mode, Lock cooling mode and Pump speed control.

Applications



For retrofit houses

Replace easily expensive gas or oil boilers for high efficient 16kW T-CAP or manage bivalent installations (heat pump and existing gas or oil boiler) with the Heat Pump Manager. Further information on: www.panasonicproclub.com

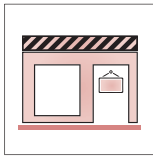

For commercial applications

Wide range of capacities now covered - from 9kW to 45kW with the Heat Pump Manager. Also you are able to connect up to five heat pumps on cascade with the Heat Pump Manager.

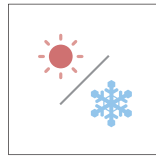

For heating and cooling mode

The 16kW model is able to heat the water at 55 °C and can work even when the temperature is as low as -20°C. Cooling operation can be activated on the remote control to cool water up to +5 °C.

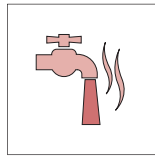

For heating and sanitary hot water

Efficient domestic hot water tanks allow large storage for high consumption of hot water (for example Jacuzzi or bathtub). All our tanks have an anti-legionella protection with a backup heater of 3kW.

Best efficiency compared to other heating efficiency systems

Panasonic heat pumps have a maximum COP of 4.85 at +7 °C which makes them much more efficient than fossil fuel fired boilers, gas boilers and electrical heaters.

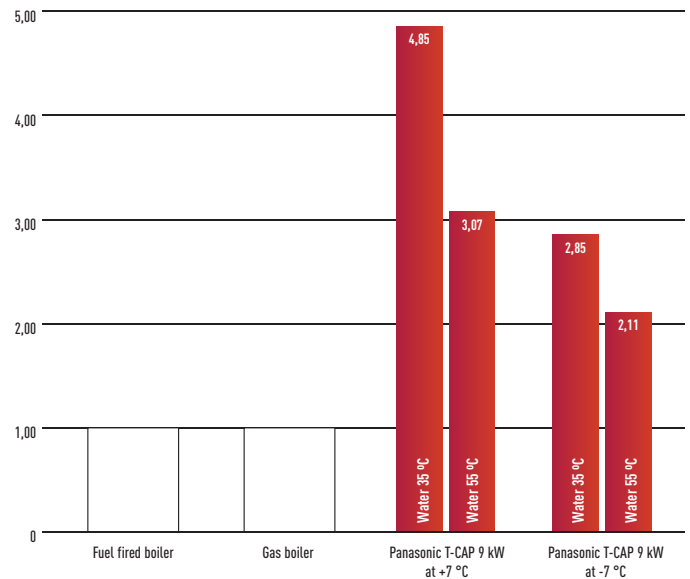

A class water pump. More Energy saving

Aquarea T-CAP maintains the nominal capacity until -15 °C

The T-CAP line-up is able to maintain the same nominal capacity even at -15 °C without the help of an electrical booster heater. T-CAP is also able to provide extremely high efficiencies, whatever the outside or the water temperature. Panasonic has now extended the range with the new three phase 16kW.

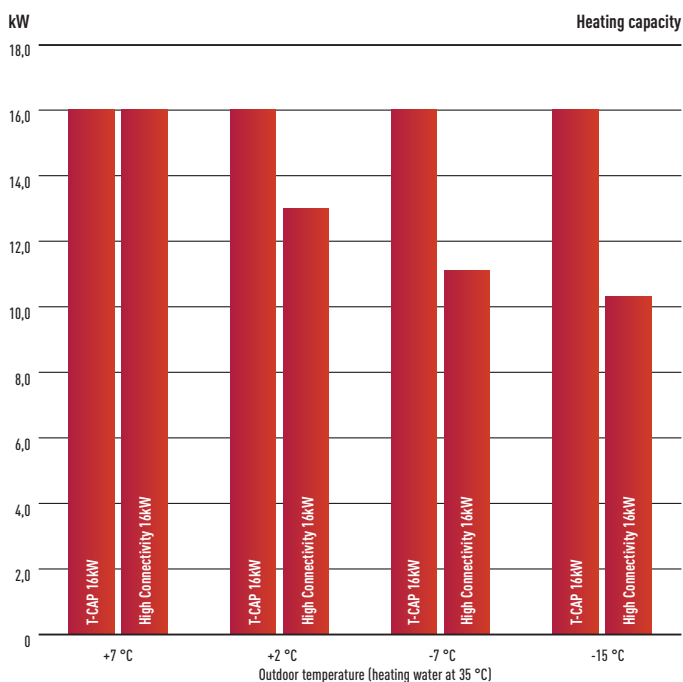

- Backup heater capacity can be selected (3/6/9kW)
- Cooling mode activation possible by software*

* This activation can only be done by service partner or installer

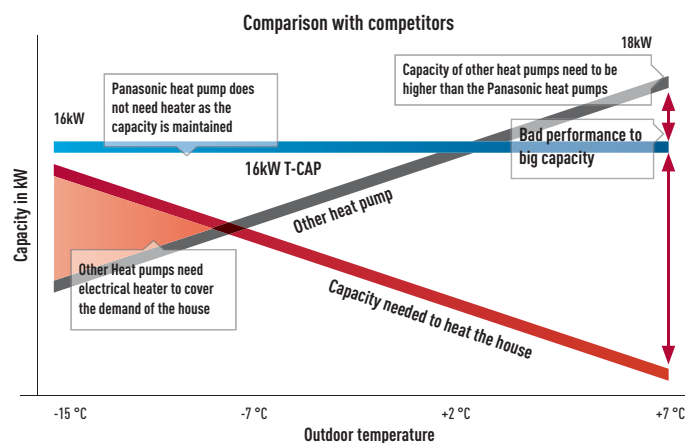
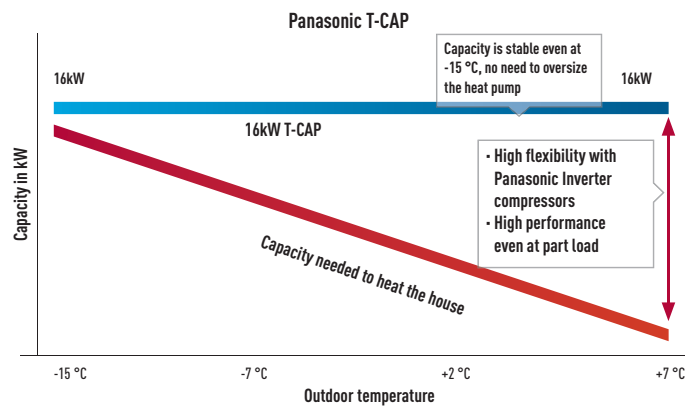



SOLUTION FOR
RETAIL
AND RESTAURANT
80 KW CAPACITY



Aquarea commercial

Solutions for best savings

Efficient Panasonic heat pumps can help to significantly reduce the energy consumption of your business. Recent improvements to air source heat pump technology, including compact single unit systems, can provide an ideal housing and commercial solution. They offer space saving, energy-efficient heating and can be easily adapted for installation in flats, houses and commercial premises. And for businesses producing heat, such as restaurants, installing an Aquarea heat pump system can also use this wasted heat to improve energy efficiency further.



Case study: Carluccio's restaurant

Carluccio's restaurant wanted to install a system which would provide the desired volume of hot water, at the correct temperature while at the same time reduced energy costs. Following a consultation with Carluccio's, it was decided that their new site in the Meadowhall shopping centre in Sheffield would be the ideal location as it had the correct attributes for the installation of an air to water heat pump system. Previous restaurants in the chain had been fitted with a more traditional 12kW boiler system.

FWP installed a 12kW Aquarea T-CAP mono bloc unit which would allow for the free air from the kitchen roof space to be transferred through condensing unit providing hot water at the optimum temperature. With a high coefficient of performance (COP), for every kW of electricity the system uses, it provides 4kW of energy. This makes the Aquarea far more cost effective than a conventional heating system.

When Carluccio's compared the Sheffield site to one of their existing restaurants of a similar size, the energy savings were considerable. To heat the water for their Leeds restaurant cost £3782 whilst at the Meadowhall site the comparable cost was just £951. These sizable savings mean the site will see a return on investment in about 2 years and has achieved a COP of about 3.91.

Restaurant with Aquarea

If you look for savings on your business, Aquarea is the right choice!

Ideal for heating, cooling and for production of big quantities of hot water at 65 degrees, Aquarea have a extremely quick return on investment and a low CO₂ footprint.

Key points

- Produce hot water efficiency
- Fast return of investment
- Easy control
- Cascade management for higher durability of the system

* 1 HPM can control 3 HP, on this case 2 HPM are needed

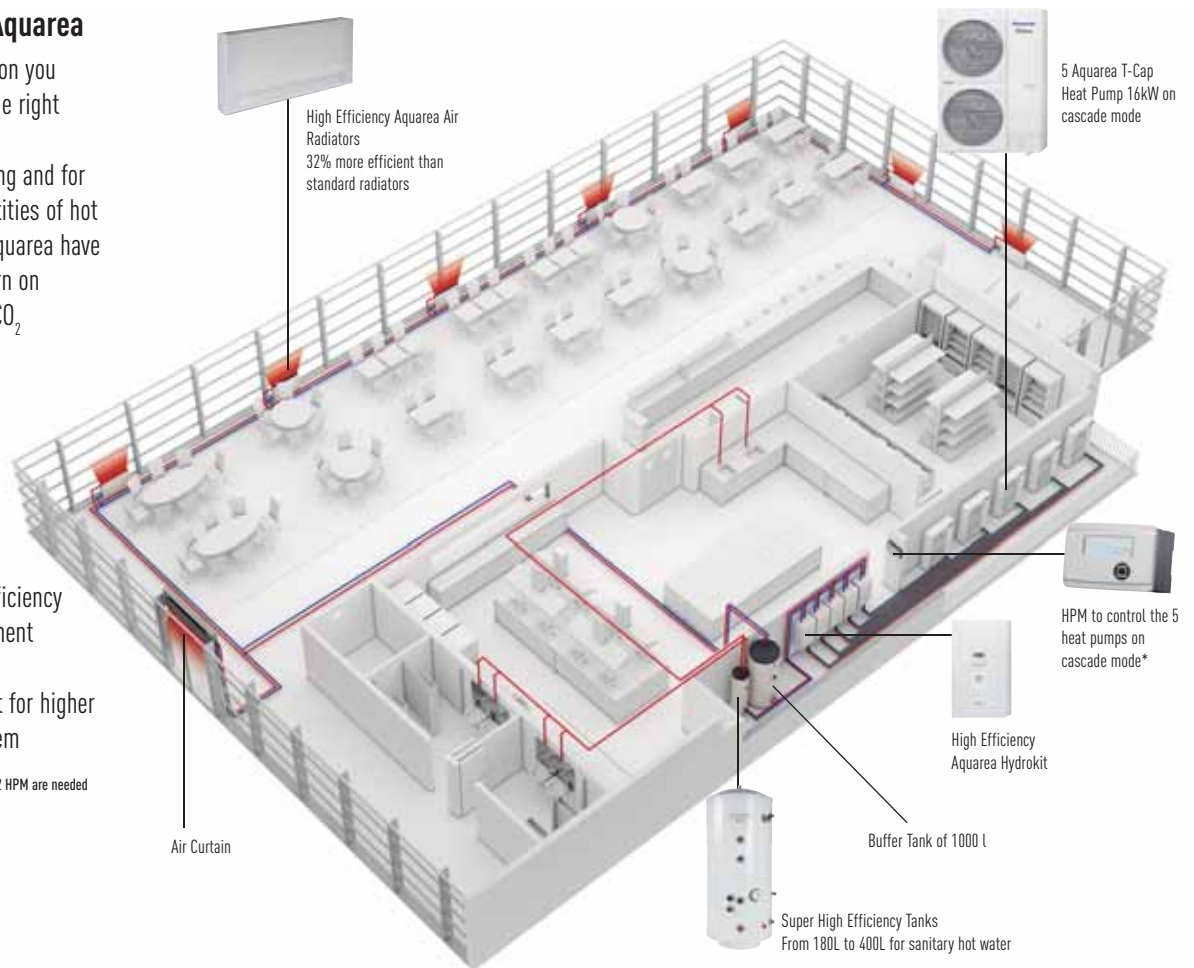

Supermarket with Aquarea

Heat pump technology is scalable, meaning that it can be installed in buildings of varying sizes, offering both small- and large-scale heating solutions. The technology is also environmentally friendly when compared to existing technologies, offering demonstrable energy-use and emissions savings and in most cases; will deliver operational cost savings when compared with fossil fuel alternatives.

By flexible with your water system

Easy connection to existing system

- Fan Coils
- Floor Heating
- 4 way and 2 way convectors
- Domestic hot water tanks
- High efficiency
- Very good part load management
- Cascade management for higher durability of the system

* 1 HPM can control 3 HP, on this case 2 HPM are needed

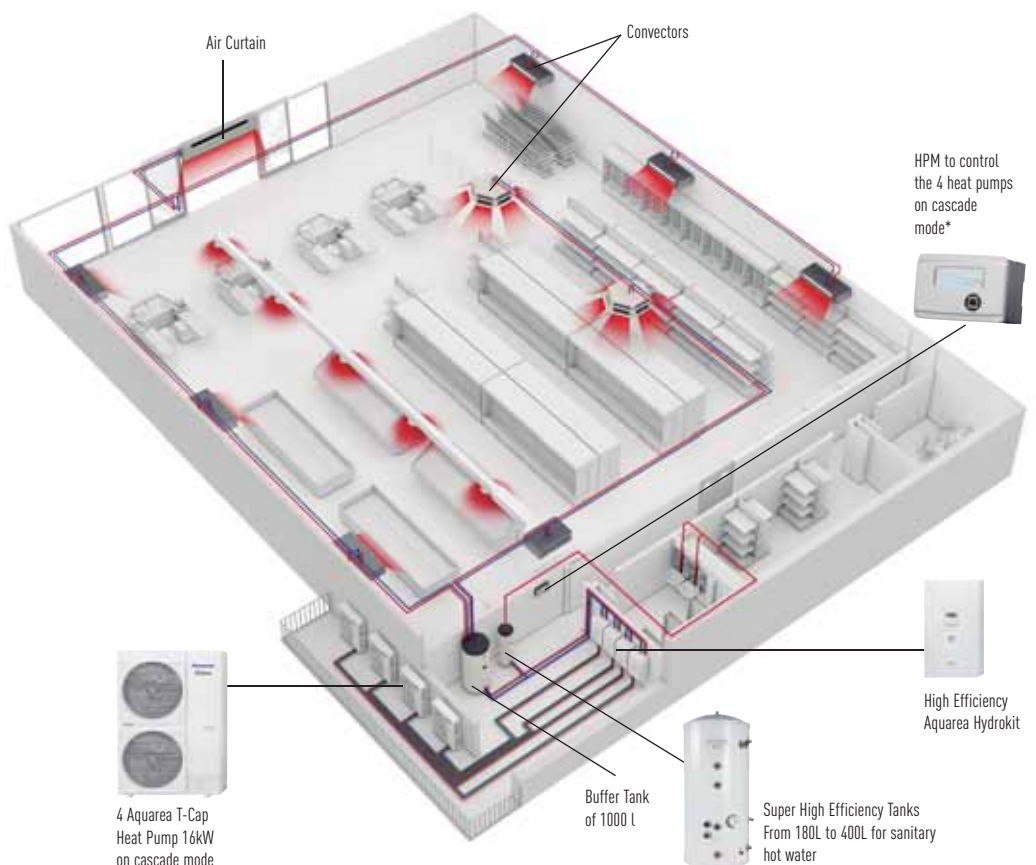



5,00 COP
high efficiency

AQUAREA
HIGH PERFORMANCE

100%
capacity
at -15 °C

AQUAREA T-CAP

**NEW ALL IN ONE
COMPACT AND
EASY TO INSTALL**

New Aquarea All in One

Hydromodule + 200l tank. From 3 to 16 kW.

Aquarea All in One is the new generation of Panasonic Heat Pumps for Heating, Cooling and Domestic Hot Water (DHW). This new range intelligently integrates the best Hydrokit technology with a premium quality stainless steel tank, which also comes with a 10 year warranty. In this way, Panasonic combines the finest product design with performance to achieve a market-leading COP.

This highly efficient solution is quick and easy to install. Thanks to piping being factory-fitted, savings of 50% are possible on installation time. Piping connections are intelligently sited on bottom of the unit further simplifying installation. All in One is also a space saving solution, perfect to install in the kitchen due to its stylish design. Furthermore, Panasonic has developed a range of controllers which allows the control of 2 heating zones, bivalent and cascade systems.

**INCLUDES
200L
STAINLESS
STEEL TANK**

- Highly efficient solution
- Quick and easy installation. Reduce installation costs. Piping on the bottom of the All in One
- A class water pump
- 200l stainless steel tank with 10 year warranty
- Easy integration of the HPM remote control
- Best stainless steel tank with high insulation to reduce energy losses
- High exchange surface to increase efficiency
- Space saving: 1,800H x 598W x 717D
- Best performing Aquarea hydraulic module to heat the water
- Maintenance from the front. Electrical connections on the front
- Built-in filters
- Max water temp output 55 °C

Note: Cooling mode activation possible by software. This activation can only be done by service partner.

What makes Aquarea All in One unique?

Wide range

Up to 14 different combinations. From 3kW to 16kW.

- High Performance for new installations and low consumption homes.
- T-CAP for extremely low temperatures ensuring constant heating up to -15 °C.



High performance	3kW (Single Phase)	5kW (Single Phase)	7kW (Single Phase)	9kW (Single)	12kW (Single)
T-CAP					

It's Panasonic

Panasonic is the world leading compressor manufacturer, the heart of any heat pump.

Intelligent Design

We listened to the installation specialists. As a result, piping connections are at the bottom of the unit, making installation easier, and as no piping works are visible, it makes the unit more aesthetically pleasing. Additional advantages are that space is available on top of the unit, and there is no need to keep an access point for maintenance.

New function for installer

- Floor heating concrete dry mode
- Cooling mode unlock facility
- Class A Pump management with 7 speeds

High Efficiency

Heating COP up to 5. DHW COP up to 2,5. A Class water pump.

Connectivity Possibilities

Three remote controls can be installed:

- New Remote control. New function for customer:
 - Auto Mode for Heating and Cooling
 - Shows Energy Consumption
 - Set Holiday Mode
- Heat Pump Manager for more than 600 possible installation configurations (as 2 zone control, Bivalent, etc.)
- Heat Pump Manager with touch screen LCD.



Warranty

- 5 year warranty on compressors
- 10 year warranty on All in One Tanks

Ideal for installation in new homes, Aquarea All in One is also particularly suited for retrofit projects, saving installation time and space.

Space Saving

Hydromodule and tank both in one self-contained enclosure.

Easy and fast installation

No installation work is needed between the indoor unit and the tank. Water filter included.

All in one accessories:

PAW-ADC-PREKIT: Piping connection kit.
PAW-ADC-CV150: Decorative magnetic side cover.
More information in accessories page.

- | | |
|------------------------|--------------------------|
| 1. Control Panel | 6. 03-Way Valve |
| 2. Water Pump | 7. Air Purge Valve |
| 3. Control Board Cover | 8. Pressure Relief Valve |
| 4. Expansion vessel | 9. Flow Switch |
| 5. Water Filter Set | 10. Water Pressure Gauge |

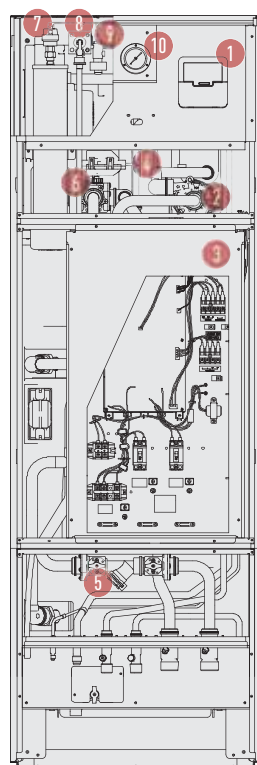

Pre Installation Kit PAW-ADC-PREKIT (optional)

Unique pre installation kit to realize easier & quicker installation.

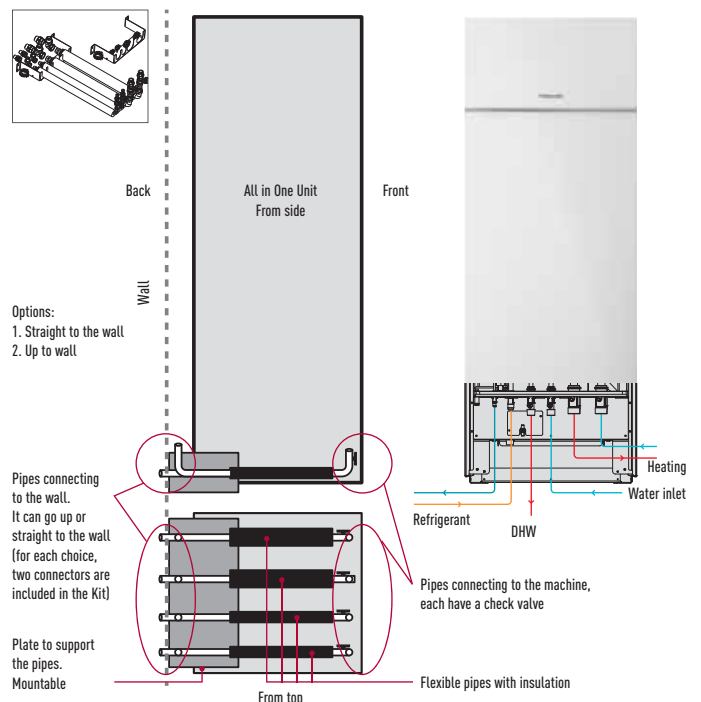

Control & connectivity

Aware of the importance of both control and connectivity in offering the best comfort at the lowest price, Panasonic offers its customers cutting-edge technology, specially designed to ensure our Aquarea heat pump systems deliver maximum performance. You can properly manage the heat pump and perform comprehensive monitoring and control, with all of the features the remote control provides at home, from anywhere in the world thanks to the internet applications Panasonic has created for you.

New remote control

Panasonic has introduced a new remote controller to improve performance, enhance comfort and deliver maximum savings.

New function for installer

- Floor heating concrete dry mode
- How to Lock Cool Mode
- Class A Pump management with 7 speeds

Floor heating concrete dry mode: Allows slow increase in temperature of floor heating via software.

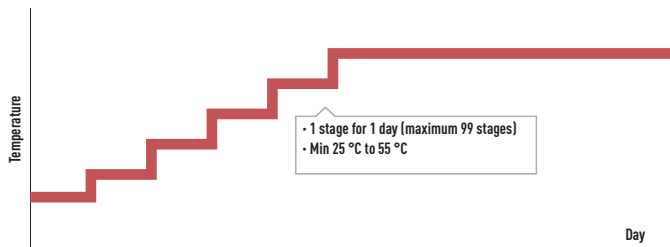

Heating and Cooling Mode: Authorized service partner or Authorized installer can enable the cooling mode through a special operation via the remote controller on site.

Pump with 7 speeds: Pump speed can be selected on the remote control.

New Remocon changing point

Better user interface:

1. Adding Holiday Mode
2. Adding Power Consumption

LCD display:

1. Expand LCD display to show mode on left and right side
2. Adding AUTO mode and remove defrost display (using heat blink)
3. Change not available into EXT SW OFF
4. Adding kWh and Hr

Button:

5. Adding holiday button
6. Change force and error reset position

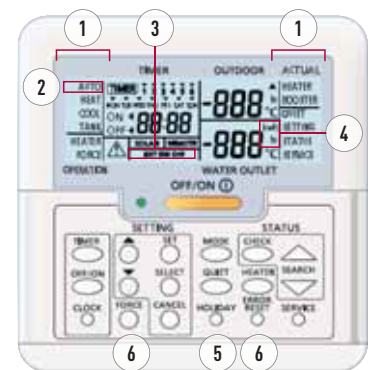

New function for end user

- Auto Mode for Heating and Cooling mode
- Show Energy Consumption
- Set Holiday Mode

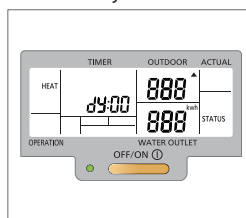

Auto Mode: Automatically changes from heating to cooling depending on outdoor temperature.

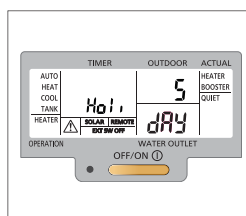

Energy Consumption: Displays the heat pump's energy consumption, split by heating, cooling and domestic hot water, and shows total consumption figure.

Holiday Mode: Enables the system to resume at the preset temperature after your holiday.



With or without built-in display



External touch display with the Heat Pump Manager

Optional

New Heat Pump Manager

Connected to a router, all information of the heating system controlled by the HPM is available from internet. Installers, service companies and end user can monitor the installation remotely. Panasonic has developed a new easy start up mode for the HPM. Start your bivalent system in just 10 minutes!



READY...
STEADY...
GO!

Easy Installation & Easy Configuration

Ready: Pre-programmed with up to 610 applications/system diagrams
Steady: At start up - state the number of application/system diagram
Go: The controller starts working according to selected diagram

The next generation of Aquarea Manager

This new generation of smart controllers for eco-efficient heating features our versatile stand-alone controller for heating and domestic hot water.



Panasonic offers:

Trends. Statistics. Consumption Energy Management-Optimization. Alarm. Handling + Maintenance. Complete documentation etc.

Key points

- Easy selection with the "ready to go" system
- Up to 610 preconfiguration installations available on www.panasonicproclub.com
- Cascade system possible for big installations.
- Bivalent control in order to also manage gas boilers
- Able to control 2 mixed heated zones
- Smart grid ready
- Solar panel mode in order to produce heat when the PV is generating electricity
- Online access with control of all parameters.
- Easy installation and needs less than 3 minutes to configure a complex system

Technical Specification

- New function: Smart Setup
- Control of 2 x Mixed Heating Circuits
- Floor screed dry program
- Cascade/bivalent controller
- Automatic switch from heating to cooling mode
- Night shift: - Internal Energy Manager
- Solar collector control
- Domestic hot water priority
- Easy to startup – easy to operate
- 7 output relays
- 0-10 V In/Output Signal
- 8 Sensor inputs (PT1000)
- USB interface (upload, service, remote control, trend)
- RS485 interface (com. with additional heat pump)
- RS485 interface (for external display)
- Built-in backlit text display

Easy mounting

Simple mounting without screws in the cabinet/door or on DIN-rail. Also possible to mount directly on to the wall.

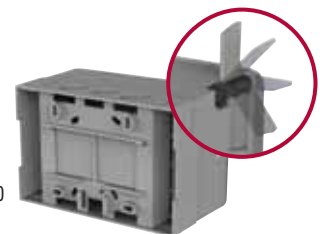



Internet Control

Control your heat pump from wherever you are. Control your comfort and efficiency with the lowest energy consumption

What's Internet Control?

Internet Control is a next generation system providing user-friendly remote control of air conditioning or heat pump units from anywhere, using a simple Android or iOS smartphone, tablet or PC via internet with the optional Wired Room temperature sensor, the temperature be display (only with PA-AW-WIFI-1).

Simple Installation

Just connect the Internet Control device to the air conditioner or heat pump with the supplied wire and then link it to your WIFI Access point.

Internet Control. Easy to install. Maximum benefit

Internet Control is underlined with the slogan "Your home in the cloud", meaning a simple and easy to handle solution has been considered for every user to manage the device, not requiring any communication or computer skills.

No servers. No adaptors. No wires. Just a small box needs to be connected and placed close to the air conditioning indoor unit... and your smartphone, tablet or PC.

Your existing WiFi connection does the rest when you are at home. Start the App from your smartphone device, your tablet or your computer, and enjoy a new experience in comfort. And if you are out of home, just launch the App, and manage the air conditioning of your home from the cloud. An intuitive and user-friendly application on the screen of your smartphone or PC that lets you manage the air conditioning unit in the same way you do with the remote controller at home.

Internet Control can be downloaded in Apple's AppStore and Android's PlayStore.

Control your air conditioning with the smart internet control device via smartphones, tablet, PC and smart desktop phone via internet

Offering the same functions as if you were at home or office: start/stop, Mode Operation, Set Temperature, Room Temperature etc as well as the new, advanced functionality provided by Internet Control to achieve the best comfort and efficiency with the lowest energy consumption.

Take control from wherever you are!

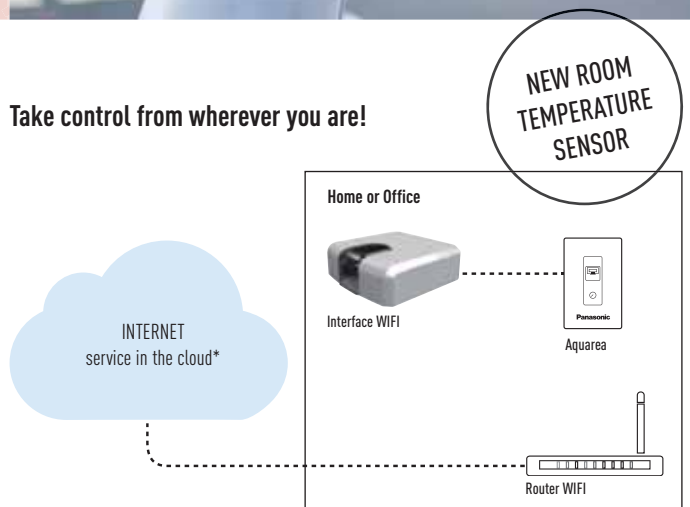

* Functionalities depend on the license. The information indicated above is subject to changes and updates.

PA-AW-WIFI-1 IntesisHome for web control. PA-AW-WIFI-1TE IntesisHome for web control with wired room temperature sensor to display the temperature of the room.



Case Study: Helen, Panasonic customer

"I was sick of heating my house in the mountains on the weekends when I couldn't go. It was a pointless and annoying expense. But now, with Internet Control, I've managed to put the rigidity of weekly programming behind me. If I go then I just put my Panasonic Aquarea heating system on. And if I don't go then I go to the cinema or the theatre with the money I've saved."

Easy control by BMS
CONNECTIVITY



Connectivity. Control by BMS

Great flexibility for integration into your KNX / Modbus projects allows fully bi-directional monitoring and control of all the functioning parameters



Modbus®

Interface to connect Aquarea to KNX

Reference: PAW-AW-KNX-1i

This new Aquarea-KNX interface allows full monitoring and control, bi-directionally, of all the functioning parameters of Aquarea control from KNX installations.

- Small dimensions. / Quick installation and possibility of hidden installation.
- External power not required.
- Direct connection to the unit.
- Fully KNX interoperable. Control and monitoring, from sensors or gateways, of the internal variables of the indoor unit and error codes and indication.
- Aquarea unit can be controlled simultaneously by the remote control of the Aquarea unit and by KNX devices.

Interface to connect Aquarea to Modbus

Reference: PAW-AW-MBS-1

This new Aquarea-Modbus RTU Slave interface allows monitoring and control, fully bi-directionally, all the functioning parameters of Aquarea control from Modbus installations.

- Small dimensions. / Quick installation and possibility of hidden installation.
- External power not required.
- Direct connection to the unit.
- Fully Modbus interoperable. Control and monitoring, from any BMS or PLC Modbus Master, of internal variables of the indoor unit and error codes and indication.
- Aquarea unit can be controlled simultaneously by the remote control of the Aquarea unit and by Modbus Master device.



KNX Any standard KNX device

Model name	Interface
PAW-AW-KNX-1i	KNX Interface
PAW-AW-MBS-1	Modbus Interface
PA-AW-WIFI-1	Interface for Intesishome for Aquarea models
PA-AW-WIFI-1TE	Wired room temperature sensor (only for PA-AW-WIFI-1)

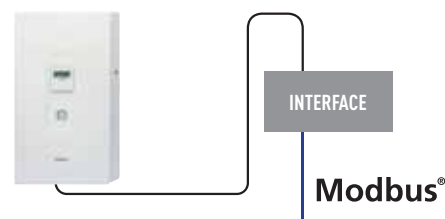

MODBUS



Building Management System

INCREASE BY 120%
THE USAGE OF FREE
ELECTRICITY*



+



PV panels + Heat Pump Manager

Heat and produce Domestic Hot Water for free

Panasonic has developed an innovative algorithm for its HPM (Heat Pump Manager) which drastically improves the Heat Pump's use of self-generated electricity from connected Photovoltaic panels. The Heat Pump will take the electricity generation by the solar system into consideration for the heating system and the domestic hot water production, without reducing comfort in the house.

The HPM (Heat Pump Manager) activates the heat pump based on:

- Energy produced by the photovoltaic system.
- The consumption requirement of the house, eg if a washing machine is working, the heat pump will not draw electricity from the photovoltaic system to avoid net increases on overall energy consumption and hence maximise efficiency.
- Heating demand of the house (in case of high electricity production, the house can be overheated by 1 or 2 degrees, or reduced by 1 or 2 degrees if low production of electricity).

As the production of domestic hot water is linked to the level of electricity generated by the solar system, if this was too low, the heat pump would start a normal process to maintain maximum comfort in the house for a given set time (defined by the user).

Key points

- Increases the amount of self-consumed electricity from the solar system up to 120%.
- Control the heat pump's energy consumption according to the output of electricity from the PV considering the electric energy consumption requirement of the house.
- Innovative algorithm balancing the consumption of the heat pump and the comfort in the house based on the outside temperature and the energy demand of the building.
- Easy configuration of the Heat Pump manager system with the PV system.

*Results of simulations for new housing (see next page)

Comparison on New housing Increase usage of self production by: 120%

The HPM could increase the energy consumption of the heat pump coming from the Photovoltaic from 352 kWh to 775 kWh a year. Results of simulations:

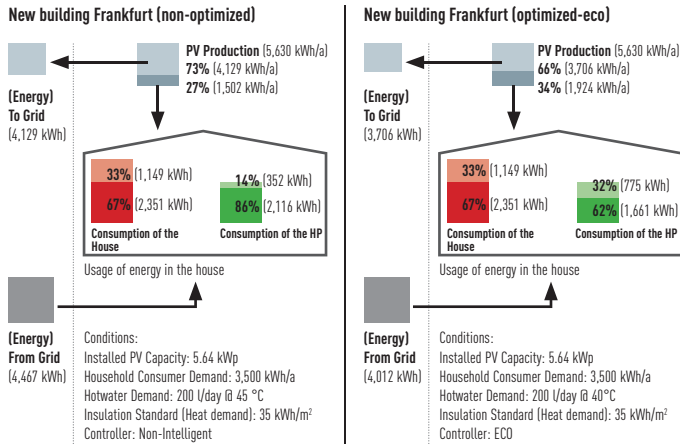

Comparison on Old housing Increase usage of self production by: 71%

The HPM could increase the energy consumption of the heat pump coming from the Photovoltaic from 526 kWh to 898 kWh a year. Results of simulations:

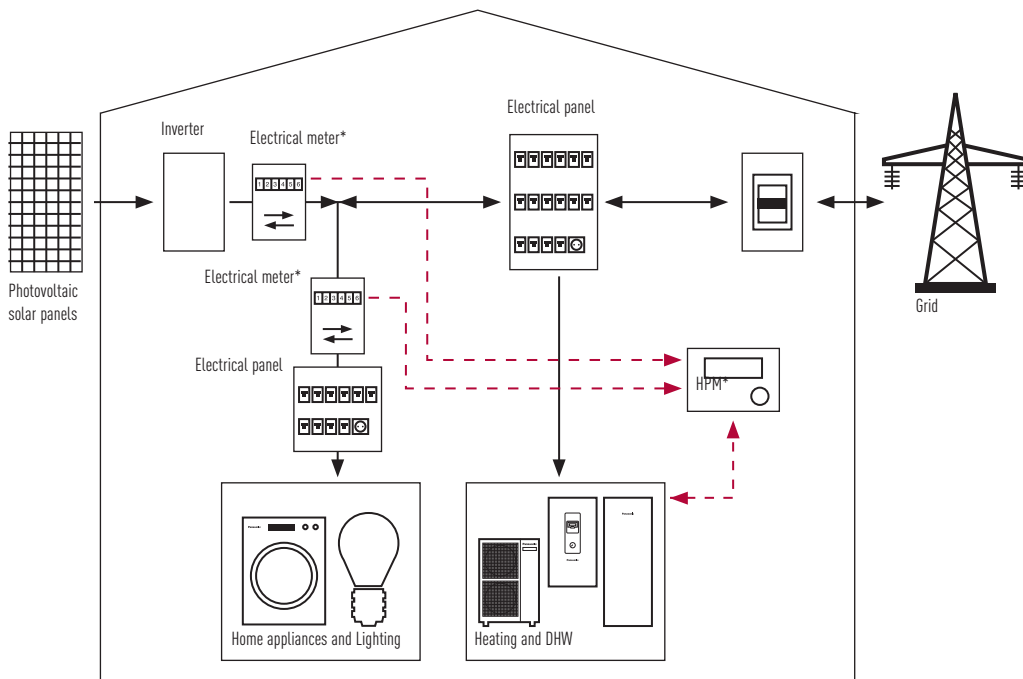
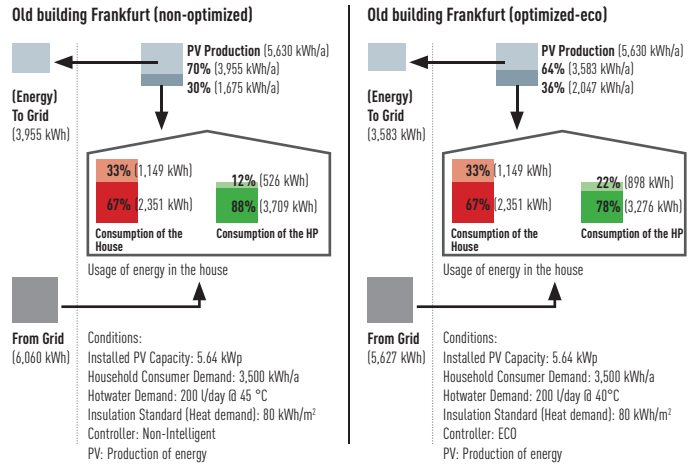

PV + HP control

How to create added value of the combination PV+HP?

- Optimize the HP considering the PV production
- When the PV is producing enough to cover the HP consumption, then Tank mode will be forced to heat up the DHW to 55 or 65 degrees
- If buffer tank on the installation, temperature on the buffer tank will increase 1-to 5 degrees or up to 55 °C.

*Device supply by Panasonic-PAW-HPM-Solar (HPM + 2 Electrical Retors)

Standard combination PV+HP. Why the Panasonic HPM can increase by 120% the performance of the combination PV+HP

Typical Electricity consumption and production profile WITHOUT Panasonic HPM

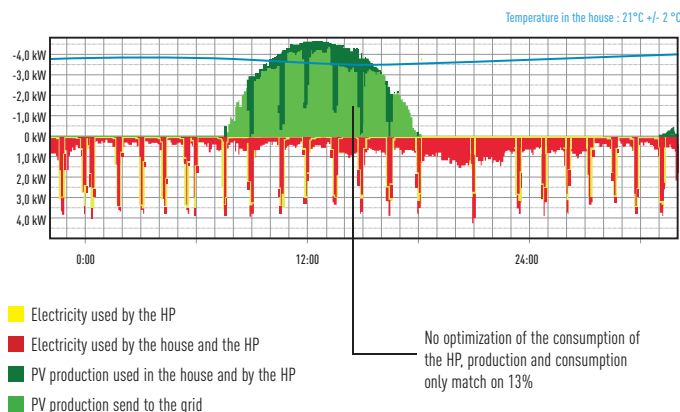

Typical Electricity consumption and production profile optimize by the Panasonic HPM

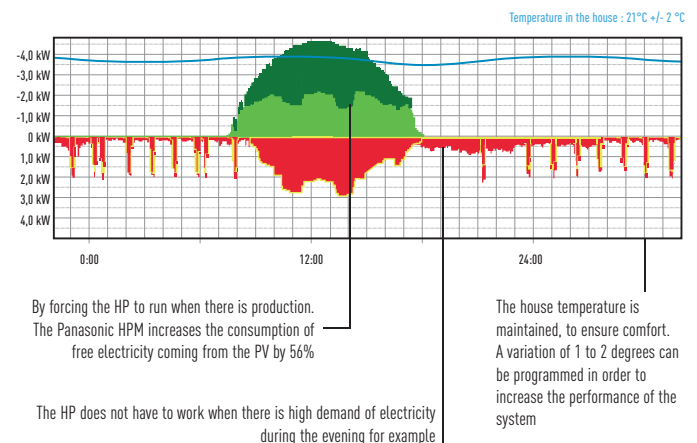







Aquarea Heat Pumps Line-Up





Aquarea All in One Bi-Bloc

						
	Figure 1 (F1)	Figure 2 (F2)	Figure 3 (F3)	Figure 4 (F4)	Figure 5 (F5)	Figure 6 (F6)
High performance	3kW (Single Phase)	5kW (Single Phase)	7kW (Single Phase)	9kW (Single Phase)	12kW (Single Phase)	16kW (Single Phase)
T-CAP				9kW (Single Phase)	12kW (Single Phase)	









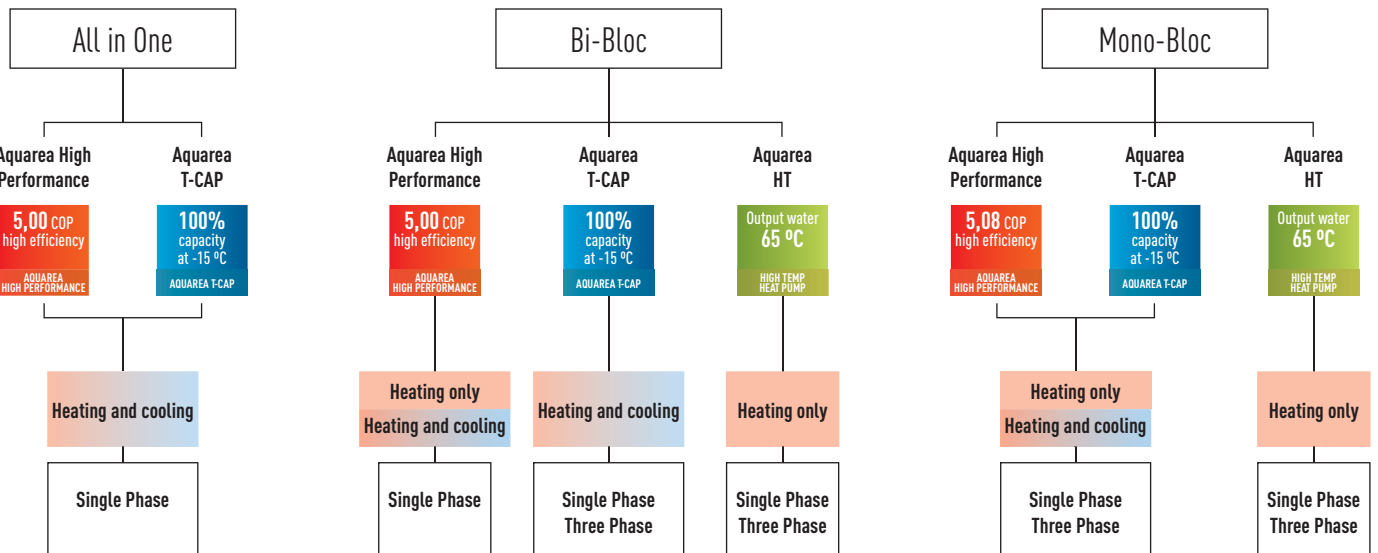







































Aquarea Bi-Bloc

						
	Figure 4 (F4)	Figure 5 (F5)	Figure 6 (F6)	Figure 7 (F7)	Figure 8 (F8)	Figure 9 (F9)
High Performance	3kW (Single Phase)	5kW (Single Phase)	7kW (Single Phase)	9kW (Single Phase)	12kW (Single Phase)	16kW (Single Phase)
T-CAP				9kW (Single, Three Phase)	12kW (Single, Three Phase)	16kW (Three Phase)
Aquarea HT				9kW (Single Phase)	12kW (Single, Three Phase)	

Aquarea Mono-Bloc

					
	Figure 7 (F7)	Figure 8 (F8)	Figure 9 (F9)	Figure 10 (F10)	Figure 11 (F11)
High performance	5kW (Single Phase)	6kW (Single Phase)	9kW (Single Phase)	12kW (Single)	16kW (Single)
T-CAP			9kW (Single, Three Phase)	12kW (Single, Three Phase)	16kW (Three Phase)
AQUAREA HT			9kW (Single)	12kW (Single, Three Phase)	



		3kW	5kW	6kW	7kW	9kW	12kW	16kW		
High Performance for well insulated houses	All in One	Single Phase	Heating and cooling WH-ADC0309G3E5 WH-UD03EE5 (F1) 	WH-ADC0309G3E5 WH-UD05EE5 (F1) 		WH-ADC0309G3E5 WH-UD07FE5 (F2) 	WH-ADC0309G3E5 WH-UD09FE5 (F2) 	WH-ADC1216G6E5 WH-UD12FE5 (F3) 	WH-ADC1216G6E5 WH-UD16FE5 (F3) 	
		Single Phase	Heating only WH-SDF03E3E5 WH-UD03EE5 (F4) 	WH-SDF05E3E5 WH-UD05EE5 (F4) 						
			Heating and cooling WH-SDC03E3E5 WH-UD03EE5 (F4) 	WH-SDC05E3E5 WH-UD05EE5 (F4) 		WH-SDC07F3E5 WH-UD07FE5 (F5) 	WH-SDC09F3E5 WH-UD09FE5 (F5) 	WH-SDC12F6E5 WH-UD12FE5 (F6) 	WH-SDC16F6E5 WH-UD16FE5 (F6) 	
	Mono-Bloc	Three Phase	Heating and cooling				WH-SDC09F3E8 WH-UD09FE8 (F6) 	WH-SDC12F9E8 WH-UD12FE8 (F6) 	WH-SDC16F9E8 WH-UD16FE8 (F6) 	
		Single Phase	Heating only		WH-MDF06E3E5 (F7) 		WH-MDF09E3E5 (F7) 	WH-MDF12C6E5 (F8) 	WH-MDF16C6E5 (F8) 	
			Heating and cooling		WH-MDC05F3E5 (F7) 	WH-MDC06E3E5 (F7) 		WH-MDC09E3E5 WH-MDC09G3E5 (F7) 	WH-MDC12C6E5* WH-MDC12G6E5 (F8) 	WH-MDC16C6E5* WH-MDC16G6E5 (F8) 
	T-CAP High Capacity for cold areas	All in One	Single Phase	Heating and cooling			WH-ADC1216G6E5 WH-UX09FE5 (F3) 	WH-ADC1216G6E5 WH-UX12FE5 (F3) 		
			Single Phase	Heating and cooling			WH-SXC09F3E5 WH-UX09FE5 (F6) 	WH-SXC12F6E5 WH-UX12FE5 (F6) 		
				Three Phase	Heating and cooling			WH-SXC09F3E8 WH-SXC09F9E8 WH-UX09FE8 (F6) 	WH-SXC12F9E8 WH-UX12FE8 (F6) 	WH-SXC16F9E8 WH-UX16FE8 (F6) 
		Mono-Bloc	Single Phase	Heating only				WH-MXF09D3E5 (F8) 	WH-MXF12D6E5 (F8) 	
				Heating and cooling				WH-MXC09D3E5* WH-MXC09G3E5 (F8) 	WH-MXC12D6E5* WH-MXC12G6E5 (F8) 	
			Three Phase	Heating only				WH-MXF09D3E8 (F8) 	WH-MXF12D9E8 (F8) 	
Heating and cooling						WH-MXC09D3E8* WH-MXC09G3E8 (F8) 	WH-MXC12D9E8* WH-MXC12G9E8 (F8) 	WH-MXC16G9E8 (F8) 		
HT for retrofit		Bi-Bloc	Single Phase	Heating only			WH-SHF09F3E5 WH-UH09FE5 (F6) 	WH-SHF12F6E5 WH-UH12FE5 (F6) 		
			Three Phase	Heating only				WH-SHF12F9E8 WH-UH12FE8 (F6) 		
		Mono-Bloc	Single Phase	Heating only			WH-MHF09D3E5* WH-MHF09G3E5 (F8) 	WH-MHF12D6E5* WH-MHF12G6E5 (F8) 		
			Three Phase	Heating only				WH-MHF12D9E8* WH-MHF12G9E8 (F8) 		

* No A class water pump.

AQUAREA ALL IN ONE HIGH PERFORMANCE BI-BLOC SINGLE PHASE HEATING AND COOLING



NEW



**AQUAREA
NEW REMOTE
CONTROL**

Panasonic has developed a highly efficient solution, easy to install.

Technical focus

- Space saving: 1,800 x 598 x 717 (H x W x D)
- Reduce installation costs
- Piping on the bottom of the All in One (easy to install)
- Reduce timing and minimize installation errors
- Easy remote control to set up
- Electrical connections on the front
- Reduce installation spaces
- All piping connections at bottom of the indoor unit
- Easier installation and maintenance
- New remote control functions

* Cooling mode activation possible by software. This activation can only be done by service partner.

		Single Phase (Power to indoor)					
Kit *		KIT-ADC03GE5-UK	KIT-ADC05GE5-UK	KIT-ADC7GE5-UK	KIT-ADC9GE5-UK	KIT-ADC12GE5-UK	KIT-ADC16GE5-UK
Indoor unit		WH-ADC1216G6E5UK					
Outdoor unit		WH-UD03EE5	WH-UD05EE5	WH-UD07FE5	WH-UD09FE5	WH-UD12FE5	WH-UD16FE5
Heating capacity at +7 °C (heating water at 35 °C)	kW	3.20	5.00	7.00	9.00	12.00	16.00
COP at +7 °C (heating water at 35 °C)	W/W	5.00	4.63	4.46	4.13	4.74	4.28
Heating capacity at +2 °C (heating water at 35 °C)	kW	3.20	4.20	6.55	6.70	11.40	13.00
COP at +2 °C (heating water at 35 °C)	W/W	3.56	3.11	3.34	3.13	3.44	3.28
Heating capacity at -7 °C (heating water at 35 °C)*	kW	3.20	4.20	5.15	5.90	10.00	11.40
COP at -7 °C (heating water at 35 °C)	W/W	2.69	2.59	2.68	2.52	2.73	2.57
Cooling capacity at 35 °C (cooling water at 7/12 °C)	kW	3.20	4.50	6.00	7.00	10.00	12.20
EER at 35 °C (cooling water at 7/12 °C)	W/W	3.08	2.69	2.63	2.43	2.81	2.56
Indoor unit							
Sound pressure level	Cooling / Heating	dB(A) 28 / 28		28 / 28		28 / 28	
Dimensions / Net Weight	H x W x D	mm / kg 1,800 x 598 x 717 / 135				1,800 x 598 x 717 / 137	
Hydrokit in the indoor unit							
Water pipe connector	mm	R1 1/4		R1 1/4		R1 1/4	
A class Pump	Number of speeds	7		7		7	
	Input power (Min / Max)	W 30 / 120		30 / 120		36 / 152	
Heating water flow [ΔT=5 K, 35 °C]	l/min	9.2		14.3		20.1	
Capacity of integrated electric heater	kW	3		3		6	
Input Power	Heating / Cooling	kW 0.64 / 1.04		1.59 / 2.30		2.20 / 2.90	
Running current	Heating / Cooling	A 3.00 / 4.8		5.00 / 7.6		7.30 / 10.40	
Current 1 / Current 2	A	21.0 / 26.0		22.9 / 26.0		24.0 / 26.0	
Recommended Fuse	A	15 / 15		30 / 15		30 / 30	
Recommended power cable section	mm ²	4.0 / 2.5		4.0 / 2.5		4.0 / 4.0	
Tank in the indoor unit							
Water volume	L	200		200		200	
Maximum water temperature	°C	65		65		65	
Material inside tank		Stainless steel		Stainless steel		Stainless steel	
Exchange surface	m ²	2.1		2.1		2.1	
Warranty of the stainless steel tank		10 years		10 years		10 years	
Maintenance required on the tank		No		No		No	
Outdoor unit							
Sound pressure level	Cooling / Heating	dB(A) 47 / 47		48 / 48		50 / 49	
Sound power level	Cooling / Heating	dB 65		66		67	
Dimensions / Weight	H x W x D	mm / kg 622 x 824 x 298 / 39			795 x 900 x 320 / 66		1,340 x 900 x 320 / 101
Refrigerant (R410A)	kg	1.20		1.45		2.55	
Pipe diameter	Liquid / Gas	mm (Inch) 6.35 (1/4) / 12.7 (1/2)		6.35 (1/4) / 15.88 (5/8)		9.52 (3/8) / 15.88 (5/8)	
Refrigerant / Additional gas amount (R410A)	kg / g/m	1.20 / 20		1.45 / 30		2.75 / 50	
Pipe length range	m	3 / 15		3 / 30		3 / 30	
Pipe length for nominal capacity / additional gas	m	7 / 10		7 / 10		7 / 10	
Elevation difference (in/out)	m	5		20		20	
Operation range	Outdoor ambient	°C -20 / +35		-20 / +35		-20 / +35	
Water outlet	Cooling / Heating	°C 5 - 20 / 25 - 55		5 - 20 / 25 - 55		5 - 20 / 25 - 55	

COP classification is at 230 V only in accordance with EU directive 2003/32/EC. Sound pressure measured at 1 m from the outdoor unit and at 1.5 m height. Performance in agreement with EN14511. 1) Insulated tested under EN12897.

* The KIT includes PAW-G3-KIT

* Tentative data.

ErP ready 2015	Internet Control Ready INTERNET CONTROL	A class water pump HIGH EFFICIENCY	5,00 COP high efficiency AQUAREA HIGH PERFORMANCE	High efficiency heating INVERTER+	Environmentally friendly refrigerant R410A	Down to -20 °C in heating mode OUTDOOR TEMPERATURE	Boiler connection RETROFIT	Domestic hot water DHW	Easy control by BMS CONNECTIVITY	5 year compressor warranty	10 year warranty in the vessel tank	INTERNET CONTROL READY: Optional. 5 YEARS COMPRESSOR WARRANTY: Only for PRO partners.
--------------------------	---	--	---	---	--	--	--------------------------------------	----------------------------------	--	-----------------------------------	--	--

AQUAREA ALL IN ONE T-CAP BI-BLOC SINGLE PHASE / THREE PHASE HEATING AND COOLING

NEW



NEW AQUAREA AIR RADIATORS
32% MORE EFFICIENT THAN STANDARD RADIATORS
Optional

All the benefits of the T-CAP All in ONE unit!
Panasonic has developed a highly efficient solution, easy to install.

Technical focus

- Space saving: 1,800 x 598 x 717 (H x W x D)
- Reduce installation costs
- Piping on the bottom of the All in One (easy to install)
- Reduce timing and minimize installation errors
- Easy remote control to set up
- Electrical connections on the front
- Reduce installation spaces
- All piping connections at bottom of the indoor unit
- Easier installation and maintenance
- 1 phase and 3 phase
- New remote control functions

Kit *		Single Phase (Power to indoor)	
		KIT-AXC09GE5-UK	KIT-AXC12GE5-UK
Indoor unit		WH-ADC1216G6E5UK	WH-ADC1216G6E5UK
Outdoor unit		WH-UX09FE5	WH-UX12FE5
Heating capacity at +7 °C (heating water at 35 °C)	kW	9.00	12.00
COP at +7 °C (heating water at 35 °C)	W/W	4.84	4.74
Heating capacity at +2 °C (heating water at 35 °C)	kW	9.00	12.00
COP at +2 °C (heating water at 35 °C)	W/W	3.59	3.44
Heating capacity at -7 °C (heating water at 35 °C)*	kW	9.00	12.00
COP at -7 °C (heating water at 35 °C)	W/W	2.85	2.72
Cooling capacity at 35 °C (cooling water at 7/12 °C)	kW	7.00	10.00
EER at 35 °C (cooling water at 7/12 °C)	W/W	3.17	2.81
Indoor unit			
Sound pressure level	Cooling / Heating	dB(A)	—
Dimensions / Net Weight	H x W x D	mm / kg	1,800 x 598 x 717 / 135
Hydrokit in the indoor unit			
Water pipe connector			R 1 1/4
A class Pump	Number of speeds		7
	Input power (Min / Max)	W	36 / 152
Heating water flow (ΔT=5 K, 35 °C)		l/min	25.8
Capacity of integrated electric heater		kW	6
Input Power	Heating / Cooling	kW	1.90
	Heating / Cooling	A	8.8 (10.4)
Running current	Heating / Cooling	A	25.0 / 26.0
		A	29.0 / 26.0
Recommended Fuse		A	30 / 30
Recommended power cable section		mm ²	4.0 / 4.0
Tank in the indoor unit			
Water volume	L		200
Maximum water temperature	°C		65
Material inside tank			Stainless steel
Exchange surface	m ²		2.1
Warranty of the Stainless steel tank			10 years
Maintenance required on the tank			No
Outdoor unit			
Sound pressure level	Cooling / Heating	dB(A)	49 / 49
Sound power level	Cooling / Heating	dB	66
Dimensions / Weight	H x W x D	mm / kg	1,340 x 900 x 320 / 101
Refrigerant (R410A)		kg	1.45
Pipe diameter	Liquid / Gas	mm (Inch)	9.52 (3/8) / 15.88 (5/8)
		kg / g/m	3.10 / 50
Refrigerant / Additional gas amount (R410A)		kg / g/m	3.10 / 50
Pipe length range		m	3 / 30
Pipe length for nominal capacity / additional gas		m	7 / 10
Elevation difference (in/out)		m	20
Operation range	Outdoor ambient	°C	-20 / +35
		°C	-20 / +35
Water outlet	Cooling / Heating	°C	5 - 20 / 25 - 55

COP classification is at 230 V only in accordance with EU directive 2003/32/EC. Sound pressure measured at 1 m from the outdoor unit and at 1.5 m height. Performance in agreement with EN14511. 1) Insulated tested under EN12897.

* The KIT includes PAW-G3-KIT

* Tentative data.

ErP ready
2015

Internet Control Ready
INTERNET CONTROL

A class water pump
HIGH EFFICIENCY

4.85 COP high efficiency
AQUAREA HIGH PERFORMANCE

High efficiency heating
INVERTER+

Environmentally friendly refrigerant
R410A

Down to -20 °C in heating mode
OUTDOOR TEMPERATURE

Boiler connection
RETROFIT

Domestic hot water
DHW

Easy control by BMS
CONNECTIVITY

5 year compressor warranty

10 year warranty in the vessel tank

INTERNET CONTROL READY: Optional.
5 YEARS COMPRESSOR WARRANTY: Only for PRO partners.

AQUAREA HIGH PERFORMANCE BI-BLOC SINGLE PHASE HEATING ONLY - SDF HEATING AND COOLING - SDC



**NEW AQUAREA TANK
TANKS AND BUFFER TANK
IN ONE!**
Optional

The Aquarea SDF / SDC range adapts well in an existing install with a boiler backup, and in a new application with underfloor heating, low temperature radiators or even fan-coil heaters.

This range can also be connected to a solar kit in order to increase efficiency and minimize the impact on the ecosystem. Finally, it is possible to connect a thermostat for better heating and cooling control and management.

The 3 and 5 kW is specially designed for low energy homes and achieves an impressive COP of 5 (on the 3.20 kW). The Aquarea's software is optimised to the requirements of low consumption homes in order to maximise energy efficiency. Whatever the weather. The compact design of the outdoor unit makes installation very easy.

Technical focus

- Range from 3 to 16kW, Single and Three Phase
- New remote control functions (only for 7 to 16 kW)
- Efficient control of room temperature based on the outdoor temperature, indoor temperature using the Aquarea Manager.
- Super efficient: COP of 5 in the 3.20 kW!
- A Class Pump (only for 3 and 5 kW)
- Optional Smartphone control
- Works down to -20°C
- Maximum hydraulic module output temperature: 55 °C
- Maximum 30 m rise between the outdoor unit and the hydraulic module (only for 7 to 16 kW)

Kit	Single Phase Heating Only		Single Phase Heating and Cooling		Single Phase (Power to indoor)					
	KIT-WF03C3E5	KIT-WF05C3E5	KIT-WC03C3E5	KIT-WC05C3E5	KIT-WC07F3E5	KIT-WC09F3E5	KIT-WC12F6E5	KIT-WC16F6E5		
Indoor unit	WH-SDF03E3E5	WH-SDF05E3E5	WH-SDC03E3E5	WH-SDC05E3E5	WH-SDC07F3E5	WH-SDC09F3E5	WH-SDC12F6E5	WH-SDC16F6E5		
Outdoor unit	WH-UD03EE5	WH-UD05EE5	WH-UD03EE5	WH-UD05EE5	WH-UD07FE5	WH-UD09FE5	WH-UD12FE5	WH-UD16FE5		
Heating capacity at +7 °C (heating water at 35 °C)	kW	3.20	5.00	3.20	5.00	7.00	9.00	12.0		
COP at +7 °C (heating water at 35 °C)	W/W	5.00	4.63	5.00	4.63	4.46	4.13	4.74		
Heating capacity at +2 °C (heating water at 35 °C)	kW	3.20	4.20	3.20	4.20	6.55	6.70	11.40		
COP at +2 °C (heating water at 35 °C)	W/W	3.56	3.11	3.56	3.11	3.34	3.13	3.44		
Heating capacity at -7 °C (heating water at 35 °C)	kW	3.20	4.20	3.20	4.20	5.15	5.90	10.00		
COP at -7 °C (heating water at 35 °C)	W/W	2.69	2.59	2.69	2.59	2.68	2.52	2.73		
Cooling capacity at 35 °C (cooling water at 7/12 °C)	kW	—	—	3.20	4.50	6.00	7.00	10.00		
EER at 35 °C (cooling water at 7/12 °C)	W/W	—	—	3.08	2.69	2.63	2.43	2.81		
Indoor unit										
Sound pressure level	Heating / Cooling	dB(A)	30 / —	30 / —	30 / 30	30 / 30	33 / 33	33 / 33	33 / 33	
Dimensions	H x W x D	mm	892 x 502 x 353	892 x 502 x 353	892 x 502 x 353	892 x 502 x 353	892 x 502 x 353	892 x 502 x 353	892 x 502 x 353	
Weight		kg	43	43	44	44	43	45	46	
Water pipe connector		mm	28	28	28	28	R1 1/4	R1 1/4	R1 1/4	
A class Pump	Number of speeds		Variable Speed	Variable Speed	Variable Speed	Variable Speed	7	7	7	
	Input power (Min / Max)	W	30 / 100	33 / 106	30 / 100	33 / 106	34 / 114	40 / 120	34 / 110	30 / 105
Heating water flow [ΔT=5 K, 35 °C]		l/min	9.2	14.3	9.2	14.3	20.1	25.8	34.4	
Capacity of integrated electric heater		kW	3	3	3	3	3	6	6	
Input Power	Heating / Cooling	kW	0.64 / 1.04	1.08 / 1.67	0.64 / 1.04	1.08 / 1.67	1.59 / 2.30	2.20 / 2.90	2.53 / 3.56	3.74 / 4.76
Running current		A	3.0	5.0	3.0	5.0	7.30	10.10	11.50	
Starting current		A	4.8	7.6	4.8	7.6	10.40	13.10	16.00	
Current 1 / Current 2		A	11.0 / 26.0	12.0 / 26.0	11.0 / 26.0	12.0 / 26.0	21.0 / 26.0	22.9 / 26.0	24.0 / 26.0	
Recommended Fuse		A	15 / 30	15 / 30	15 / 30	15 / 30	30 / 30	30 / 30	30 / 30	
Recommended power cable section		mm ²	2.5 / 4.0	2.5 / 4.0	2.5 / 4.0	2.5 / 4.0	4.0 / 4.0	4.0 / 4.0	4.0 / 4.0	
Outdoor unit										
Sound pressure level	Heating / Cooling	dB(A)	47 / —	48 / —	47 / 47	48 / 48	48	49	50	
Sound power level		dB	65	66	65	66	66	67	70	
Dimensions	H x W x D	mm	622 x 824 x 298	622 x 824 x 298	622 x 824 x 298	622 x 824 x 298	795 x 900 x 320	795 x 900 x 320	1,340 x 900 x 320	
Weight		kg	39	39	39	39	66	66	101	
Pipe diameter	Liquid	mm (Inch)	6.35 (1/4)	6.35 (1/4)	6.35 (1/4)	6.35 (1/4)	6.35 (1/4)	6.35 (1/4)	9.52 (3/8)	
	Gas	mm (Inch)	12.7 (1/2)	12.7 (1/2)	12.7 (1/2)	12.7 (1/2)	15.88 (5/8)	15.88 (5/8)	15.88 (5/8)	
Refrigerant (R410A)		kg	1.20	1.20	1.20	1.20	1.45	1.45	2.55	
Pipe length range		m	3-15	3-15	3-15	3-15	3-30	3-30	3-30	
Pipe length for nominal capacity		m	7	7	7	7	7	7		
Pipe length for additional gas		m	10	10	10	10	10	10		
Additional gas amount (R410A)		g/m	20	20	20	20	30	30		
Elevation difference (in/out)		m	5	5	5	5	20	20		
Operation range	Outdoor ambient	°C	-20 / +35	-20 / +35	-20 / +35	-20 / +35	-20 / +35	-20 / +35	-20 / +35	
Water outlet	Heating	°C	25 - 55	25 - 55	25 - 55	25 - 55	25 - 55	25 - 55	25 - 55	
	Cooling	°C	—	—	5 - 20	5 - 20	5 - 20	5 - 20	5 - 20	

COP classification is at 230 V only in accordance with EU directive 2003/32/EC. Sound pressure measured at 1 m from the outdoor unit and at 1.5 m height. Performance in agreement with EN14511.

ErP ready
2015

Internet Control Ready
INTERNET CONTROL

A class water pump
HIGH EFFICIENCY

5,00 COP high efficiency
AQUAREA HIGH PERFORMANCE

High efficiency heating
INVERTER+

Environmentally friendly refrigerant
R410A

Down to -20 °C in heating mode
OUTDOOR TEMPERATURE

Boiler connection
RETROFIT

Solar panels connection
SOLAR KIT

Domestic hot water
DHW

Easy control by BMS
CONNECTIVITY

5 year compressor warranty

INTERNET CONTROL READY: Optional.
5 YEARS COMPRESSOR WARRANTY: Only for PRO partners.

AQUAREA T-CAP BI-BLOC SINGLE PHASE / THREE PHASE HEATING AND COOLING - SXC



SG Ready
Smart Grid Ready

**PV PANELS + HEAT PUMP
MANAGER INCREASE BY
120% THE USAGE OF FREE
ELECTRICITY**
Optional

The new SXC is ideal for residential properties which don't have an external boiler and require a maintained capacity level.

T-CAP stands for Total Capacity. This new line-up is able to maintain the same nominal capacity even at -15 °C without the help of an electrical booster heater. T-CAP is also able to provide extremely high efficiency, whatever the outside temperature or the water temperature. The SXC adapts well in an existing install with a boiler backup, and in a new application with underfloor heating, low temperature radiators or even fan-coil heaters. This Range can also be connected to a solar kit in order to increase efficiency and minimize the impact on the ecosystem. Finally, it is possible to connect a thermostat for even better heating or cooling control and management.

Technical focus

- 16kW Model: Maintains 16kW capacity at outdoor temperatures down to -15 °C
- New remote control functions
- Efficient control of room temperature based on the outdoor temperature, indoor temperature using the Aquarea Manager.
- Optional Smartphone control
- Range from 9 to 16kW, Single and Three Phase
- Maximum hydraulic module output temperature: 55 °C
- Works down to -20°C (Cooling temperature range 5-20°C)
- Constant capacity at outdoor temperatures down to -15 °C
- Maximum 20 m rise between the outdoor unit and the hydraulic module

Kit	Single Phase (Power to indoor)			Three Phase (Power to indoor)			
	KIT-WXC09F3E5	KIT-WXC12F6E5		KIT-WXC09F9E8	KIT-WXC12F9E8	KIT-WXC16F9E8	
Indoor unit	WH-SXC09F3E5	WH-SXC12F6E5		WH-SXC09F9E8	WH-SXC12F9E8	WH-SXC16F9E8	
Outdoor unit	WH-UX09FE5	WH-UX12FE5		WH-UX09FE8	WH-UX12FE8	WH-UX16FE8	
Heating capacity at +7 °C (heating water at 35 °C)	kW	9.00	12.00	9.00	12.00	16.00	
COP at +7 °C (heating water at 35 °C)	W/W	4.84	4.74	4.84	4.74	4.28	
Heating capacity at +2 °C (heating water at 35 °C)	kW	9.00	12.00	9.00	12.00	16.00	
COP at +2 °C (heating water at 35 °C)	W/W	3.59	3.44	3.59	3.44	3.10	
Heating capacity at -7 °C (heating water at 35 °C)	kW	9.00	12.00	9.00	12.00	16.00	
COP at -7 °C (heating water at 35 °C)	W/W	2.85	2.72	2.85	2.72	2.49	
Cooling capacity at 35 °C (cooling water at 7 °C)	kW	7.00	10.00	7.00	10.00	12.20	
EER at 35 °C (cooling water at 7 °C)	W/W	3.17	2.81	3.17	2.81	2.57	
Indoor unit							
Sound pressure level	Heating / Cooling	dB(A)	33 / 33	33 / 33	33 / 33	33 / 33	
Dimensions	H x W x D	mm	892 x 502 x 353	892 x 502 x 353	892 x 502 x 353	892 x 502 x 353	
Weight		kg	44	45	45	52	
Water pipe connector			R 1 1/4	R 1 1/4	R 1 1/4	R 1 1/4	
Pump	Number of speeds		7	7	7	7	
	Input power (Min / Max)	W	32 / 102	34 / 110	32 / 102	34 / 110	30 / 105
Heating water flow (ΔT=5 K, 35 °C)		l/min	25.8	34.4	25.8	34.4	45.9
Capacity of integrated electric heater		kW	3	6	9	9	
Input Power		kW	1.86	2.53	1.86	2.53	3.74
Starting Current		A	10.2	16.5	3.4	5.4	7.2
Current 1 / Current 2		A	25.0 / 26.0	29.0 / 26.0	14.7 / 13.0	11.9 / 13.0	15.5 / 13.0
Recommended Fuse		A	30 / 30	30 / 30	16 / 16	16 / 16	
Recommended power cable section		mm ²	4.0 / 4.0	4.0 / 4.0	2.5 / 2.5	2.5 / 2.5	
Outdoor unit							
Sound pressure level	Heating / Cooling	dB(A)	49 / 49	50 / 50	49 / 49	50 / 50	
Sound power level		dB	66	67	67	70	
Dimensions	H x W x D	mm	1,340 x 900 x 320	1,340 x 900 x 320	1,340 x 900 x 320	1,340 x 900 x 320	
Weight		kg	101	101	109	119	
Pipe diameter	Liquid	mm (Inch)	9.52 (3/8)	9.52 (3/8)	9.52 (3/8)	9.52 (3/8)	
	Gas	mm (Inch)	15.88 (5/8)	15.88 (5/8)	15.88 (5/8)	15.88 (5/8)	
Refrigerant (R410A)		kg	2.85	2.85	2.85	2.85	
Pipe length range		m	3 - 30	3 - 30	3 - 30	3 - 30	
Pipe length for nominal capacity		m	7	7	7	7	
Pipe length for additional gas		m	10	10	10	10	
Additional gas amount (R410A)		g/m	50	50	50	50	
Elevation difference (in/out)		m	20	20	20	20	
Operation range	Outdoor ambient	°C	-20 / +35	-20 / +35	-20 / +35	-20 / +35	
Water outlet	Heating	°C	25 - 55	25 - 55	25 - 55	25 - 55	
	Cooling	°C	5 - 20	5 - 20	5 - 20	5 - 20	

COP classification is at 230 V only in accordance with EU directive 2003/32/EC. Sound pressure measured at 1 m from the outdoor unit and at 1.5 m height. Performance in agreement with EN14511.

ErP ready 2015	Internet Control Ready INTERNET CONTROL	A class water pump HIGH EFFICIENCY	100% capacity at -15 °C AQUAREA T-CAP	High efficiency heating INVERTER+	Environmentally friendly refrigerant R410A	Down to -20 °C in heating mode OUTDOOR TEMPERATURE	Boiler connection RETROFIT	Solar panels connection SOLAR KIT	Domestic hot water DHW	Easy control by BMS CONNECTIVITY	5 year compressor warranty	INTERNET CONTROL READY: Optional. 5 YEARS COMPRESSOR WARRANTY: Only for PRO partners.
--------------------------	---	--	---	---	--	--	--------------------------------------	---	----------------------------------	--	-----------------------------------	--

AQUAREA HT BI-BLOC SINGLE PHASE / THREE PHASE HEATING ONLY - SHF



INTERNET CONTROL
CONTROL YOUR HEAT PUMP
FROM WHEREVER YOU ARE
Optional

Aquaarea HT is able to deliver water heated to 65 °C with the Heat Pump alone.

For a house with high temperature radiators (for example, cast iron radiators), the Aquaarea High Temperature Solution is most suited as it provides output water temperatures of 65 °C even at -20°C.

Technical focus

- New remote control functions
- Efficient control of room temperature based on the outdoor temperature, indoor temperature using the Aquaarea Manager.
- Optional Smartphone control
- Range from 9 to 12kW, Single and Three Phase
- Maximum hydraulic module output temperature: 65 °C
- Works down to -20°C
- Maximum 20 m rise between the outdoor unit and the hydraulic module

		Single Phase (Power to indoor)		Three Phase (Power to indoor)	
Kit		KIT-WHF09F3E5		KIT-WHF12F6E5	
Indoor unit		WH-SHF09F3E5		WH-SHF12F6E5	
Outdoor unit		WH-UH09FE5		WH-UH12FE5	
Heating capacity at +7 °C (heating water at 35 °C)	kW	9.00	12.00	12.00	12.00
COP at +7 °C (heating water at 35 °C)	W/W	4.64	4.46	4.46	4.46
Heating capacity at +2 °C (heating water at 35 °C)	kW	9.00	12.00	12.00	12.00
COP at +2 °C (heating water at 35 °C)	W/W	3.45	3.26	3.26	3.26
Heating capacity at -7 °C (heating water at 35 °C)	kW	9.00	12.00	12.00	12.00
COP at -7 °C (heating water at 35 °C)	W/W	2.74	2.52	2.52	2.52
Heating capacity at +7 °C (heating water at 65 °C)	kW	9.00	12.00	12.00	12.00
COP at +7 °C (heating water at 65 °C)	W/W	2.25	2.20	2.20	2.20
Heating capacity at +2 °C (heating water at 65 °C)	kW	9.00	10.30	10.30	10.30
COP at +2 °C (heating water at 65 °C)	W/W	1.88	1.83	1.83	1.83
Heating capacity at -7 °C (heating water at 65 °C)	kW	8.90	9.60	9.60	9.60
COP at -7 °C (heating water at 65 °C)	W/W	1.64	1.61	1.61	1.61
Indoor unit					
Sound pressure level	dB(A)	33	33	33	33
Dimensions	H x W x D	mm	892 x 502 x 353	892 x 502 x 353	892 x 502 x 353
Weight	kg	46	47	48	48
Water pipe connector		R 1 1/4	R 1 1/4	R 1 1/4	R 1 1/4
Pump	Number of speeds	7	7	7	7
	Input power (Min / Max)	W	38 / 100	40 / 106	40 / 106
Heating water flow (ΔT=5 K, 35 °C)	l/min	25.8	34.4	34.4	34.4
Capacity of integrated electric heater	kW	3	6	9	9
Input Power	kW	1.94	2.69	2.69	2.69
Running and Starting current	A	9.3	12.9	4.2	4.2
Current 1 / Current 2	A	28.5 / 26.0	29.0 / 26.0	10.9 / 13.0	10.9 / 13.0
Recommended Fuse	A	30 / 30	30 / 30	30 / 16	30 / 16
Recommended power cable section	mm ²	4.0 / 4.0	4.0 / 4.0	4.0 / 2.5	4.0 / 2.5
Outdoor unit					
Sound pressure level	dB(A)	49	50	50	50
Sound power level	dB	66	67	67	67
Dimensions	H x W x D	mm	1,340 x 900 x 320	1,340 x 900 x 320	1,340 x 900 x 320
Weight	kg	104	104	110	110
Pipe diameter	Liquid	mm (Inch)	9.52 (3/8)	9.52 (3/8)	9.52 (3/8)
	Gas	mm (Inch)	15.88 (5/8)	15.88 (5/8)	15.88 (5/8)
Refrigerant (R407C)	kg	2.90	2.90	2.90	2.90
Pipe length range	m	3 - 30	3 - 30	3 - 30	3 - 30
Pipe length for nominal capacity	m	7	7	7	7
Pipe length for additional gas	m	10	10	10	10
Additional gas amount (R407C)	g/m	70	70	70	70
Elevation difference (in/out)	m	20	20	20	20
Operation range	Outdoor ambient	°C	-20 / +35	-20 / +35	-20 / +35
Water outlet	°C	25 - 65	25 - 65	25 - 65	25 - 65

COP classification is at 230 V only in accordance with EU directive 2003/32/EC. Sound pressure measured at 1 m from the outdoor unit and at 1.5 m height. Performance in agreement with EN14511.

ErP ready 2015	Internet Control Ready INTERNET CONTROL	A class water pump HIGH EFFICIENCY	Output water 65 °C HIGH TEMP HEAT PUMP	High efficiency heating INVERTER+	Environmentally friendly refrigerant R407C	Down to -20 °C in heating mode OUTDOOR TEMPERATURE	Boiler connection RETROFIT	Solar panels connection SOLAR KIT	Domestic hot water DHW	Easy control by BMS CONNECTIVITY	5 year compressor warranty	INTERNET CONTROL READY: Optional. 5 YEARS COMPRESSOR WARRANTY: Only for PRO partners.
--------------------------	---	--	--	---	--	--	--------------------------------------	---	----------------------------------	--	-----------------------------------	--

AQUAREA / AQUAREA G GENERATION HIGH PERFORMANCE MONO-BLOC SINGLE PHASE HEATING ONLY - MDF HEATING AND COOLING - MDC



The Aquarea MDF / MDC range adapts well in an existing installation with a boiler backup, and in a new application with underfloor heating, low temperature radiators or even fan-coil heaters.

This range can also be connected to a solar kit in order to increase efficiency and minimize the impact on the ecosystem. Finally, it is possible to connect a thermostat for even better heating (MDF) or better heating and cooling control (MDC) control and management.

Technical focus

- New remote control functions (only for G Generation)
- Efficient control of room temperature based on the outdoor temperature, indoor temperature using the Aquarea Manager.
- A Class Pump (only for G Generation)
- Optional Smartphone control
- Range from 9 to 16kW, Single and Three Phase
- Maximum hydraulic module output temperature: 55 °C
- Works down to -20°C
- Cooling temperature range 5-20°C (MDC)

			Single Phase					
Outdoor unit Heating Only			WH-MDF12C6E5	WH-MDF16C6E5	—	—	—	—
Outdoor unit Heating and Cooling			WH-MDC12C6E5	WH-MDC16C6E5	WH-MDC09G3E5*	WH-MDC12G6E5**	WH-MDC16G6E5**	—
Heating capacity at +7 °C (heating water at 35 °C)		kW	12.00	16.00	9.00	12.00	16.00	
COP at +7 °C (heating water at 35 °C)		W/W	4.67	4.23	4.15	4.74	4.28	
Heating capacity at +2 °C (heating water at 35 °C)		kW	11.40	13.00	7.45	11.40	13.00	
COP at +2 °C (heating water at 35 °C)		W/W	3.41	3.25	3.14	3.44	3.28	
Heating capacity at -7 °C (heating water at 35 °C)		kW	10.00	11.40	7.70	10.00	11.40	
COP at -7 °C (heating water at 35 °C)		W/W	2.70	2.65	2.12	2.73	2.68	
Cooling capacity at 35 °C (cooling water at 7/12 °C) ¹		kW	10.00	12.20	7.00	10.00	12.20	
EER at 35 °C (cooling water at 7/12 °C) ¹		W/W	2.78	2.54	2.44	2.81	2.57	
Sound pressure level	Heating / Cooling ¹	dB(A)	50 / 50	53 / 54	49 / 49	50 / 50	53 / 54	
	Heating / Cooling ¹	dB	67 / 68	70 / 72	67 / 67	67 / 68	70 / 72	
Dimensions	H x W x D	mm	1,410 x 1,283 x 320	1,410 x 1,283 x 320	865 x 1,283 x 320	1,410 x 1,283 x 320	1,410 x 1,283 x 320	
Weight		kg	153	153	112	153	153	
Refrigerant (R410A)		kg	2.30	2.30				
Water pipe connector			R 1 ¼	R 1 ¼	R 1 ¼	R 1 ¼	R 1 ¼	
Pump	Number of speeds		3	3	Variable Speed	7	7	
	Input power (Min - Max)	W	34 / 110	38 / 120	40 / 120	34 / 110	38 / 120	
Heating water flow (ΔT=5 K, 35 °C)		l/min	34.4	45.9	25.8	34.4	45.9	
Capacity of integrated electric heater		kW	6	6	3	6	6	
Input Power	Heating	kW	2.57	3.78	2.17	2.53	3.74	
	Cooling ¹	kW	3.60	4.80		3.56	4.76	
Running and Starting current	Heating	A	11.6	17.1	9.9	11.6	17.1	
	Cooling ¹	A	16.1	21.5		16.1	21.5	
Current 1		A	24.0	26.0		24.0	26.0	
Current 2		A	26.0	26.0		26.0	26.0	
Current 3		A	13.0	13.0				
Recommended Fuse		A	30 / 30 / 16	30 / 30 / 16	30 / 16	30 / 30	30 / 30	
Recommended power cable section		mm ²	4.0 / 4.0 / 2.5	4.0 / 4.0 / 2.5	4.0 / 2.5	4.0 / 4.0	4.0 / 4.0	
Operation range	Outdoor ambient	°C	-20 / +35	-20 / +35	-20 / +35	-20 / +35	-20 / +35	
Water outlet	Heating	°C	25 - 55	25 - 55	20 - 55	25 - 55	25 - 55	
	Cooling ¹	°C	5 - 20	5 - 20		5 - 20	5 - 20	

COP classification is at 230 V only in accordance with EU directive 2003/32/EC. Sound pressure measured at 1 m from the outdoor unit and at 1.5 m height. Performance in agreement with EN14511.

1. Specifications for Heating and Cooling models.

* Tentative data. Available in October 2015. ** Available in June 2015.

ErP ready 2015	Internet Control Ready INTERNET CONTROL	A class water pump HIGH EFFICIENCY	4.74 COP high efficiency AQUAREA HIGH PERFORMANCE	High efficiency heating INVERTER+	Environmentally friendly refrigerant R410A	Down to -20 °C in heating mode OUTDOOR TEMPERATURE	Boiler connection RETROFIT	Solar panels connection SOLAR KIT	Domestic hot water DHW	Easy control by BMS CONNECTIVITY	5 year compressor warranty	INTERNET CONTROL READY: Optional. 5 YEARS COMPRESSOR WARRANTY: Only for PRO partners.
--------------------------	---	--	---	---	--	--	--------------------------------------	---	----------------------------------	--	-----------------------------------	--

AQUAREA T-CAP MONO-BLOC SINGLE PHASE / THREE PHASE HEATING ONLY - MXF HEATING AND COOLING - MXC



KNX
Modbus

CONNECTABLE TO HOUSE
MANAGEMENT SYSTEM
USING KNX OR MODBUS
INTERFACES
Optional

The MXC is ideal for residential properties which don't have an external boiler and require a maintained capacity level.

T-CAP stands for Total Capacity. This new line-up is able to maintain the same nominal capacity even at -15 °C without the help of an electrical booster heater. T-CAP is also able to provide extremely high efficiency, whatever the outside temperature or the water temperature. The MXC adapts well in an existing install with a boiler backup, and in a new application with underfloor heating, low temperature radiators or even fan-coil heaters. This range can also be connected to a solar kit in order to increase efficiency and minimize the impact on the ecosystem. Finally, it is possible to connect a thermostat for even better heating or cooling control and management.

Technical focus

- Efficient control of room temperature based on the outdoor temperature, indoor temperature using the Aquarea Manager.
- Optional Smartphone control
- Range from 9 to 12 kW, Single and Three Phase
- Maximum hydraulic module output temperature: 55 °C
- Works down to -20°C
- Cooling temperature range 5–20°C (MXC)

		Single Phase		Three Phase	
Outdoor unit Heating Only		WH-MXF09D3E5 -1	WH-MXF12D6E5 -1	WH-MXF09D3E8 -1	WH-MXF12D9E8 -1
Outdoor unit Heating and Cooling		WH-MXC09D3E5 -1	WH-MXC12D6E5 -1	—	—
Heating capacity at +7 °C (heating water at 35 °C)	kW	9.00	12.00	9.00	12.00
COP at +7 °C (heating water at 35 °C)	W/W	4.74	4.67	4.74	4.67
Heating capacity at +2 °C (heating water at 35 °C)	kW	9.00	12.00	9.00	12.00
COP at +2 °C (heating water at 35 °C)	W/W	3.53	3.40	3.53	3.40
Heating capacity at -7 °C (heating water at 35 °C)	kW	9.00	12.00	9.00	12.00
COP at -7 °C (heating water at 35 °C)	W/W	2.81	2.70	2.81	2.70
Cooling capacity at 35 °C (cooling water at 7/12 °C) ¹	kW	7.00	10.00	7.00	10.00
EER at 35 °C (cooling water at 7/12 °C) ¹	W/W	3.11	2.78	3.11	2.78
Sound pressure level	Heating / Cooling ¹	dB(A) 49 / 49		49 / 49	
Sound power level		dB 66		66	
Dimensions	H x W x D	mm 1,410 x 1,283 x 320		1,410 x 1,283 x 320	
Weight		kg 155		158	
Refrigerant (R410A)		kg 2.30		2.30	
Water pipe connector		R 1 ½		R 1 ½	
Pump	Number of speeds	3		3	
	Input power (Min - Max)	W 32 / 102		34 / 110	
Heating water flow (ΔT=5 K, 35 °C)	l/min	25.8		34.4	
Capacity of integrated electric heater	kW	3		3	
Input Power	kW	1.90		2.57	
Starting Current	A	10.4		16.7	
Current 1	A	25.0		29.0	
Current 2	A	26.0		13.0	
Current 3	A			13.0	
Recommended Fuse	A	30 / 30		16 / 16	
Recommended power cable section	mm ²	4.0 / 4.0		4.0 / 4.0 / 2.5	
Operation range	Outdoor ambient	°C -20 / +35		-20 / +35	
Water outlet	Heating	°C 25 – 55		25 – 55	
	Cooling ¹	°C 5 – 20		5 – 20	

COP classification is at 230 V only in accordance with EU directive 2003/32/EC. Sound pressure measured at 1 m from the outdoor unit and at 1.5 m height. Performance in agreement with EN14511.
1. Specifications for Heating and Cooling models.

ErP ready 2015	Internet Control Ready INTERNET CONTROL	100% capacity at -15 °C AQUAREA T-CAP	High efficiency heating INVERTER+	Environmentally friendly refrigerant R410A	Down to -20 °C in heating mode OUTDOOR TEMPERATURE	Boiler connection RETROFIT	Solar panels connection SOLAR KIT	Domestic hot water DHW	Easy control by BMS CONNECTIVITY
--------------------------	---	---	---	--	--	--------------------------------------	---	----------------------------------	--

5 year compressor warranty

INTERNET CONTROL READY: Optional.
5 YEARS COMPRESSOR WARRANTY: Only for PRO partners.

AQUAREA G GENERATION T-CAP MONO-BLOC SINGLE PHASE / THREE PHASE HEATING AND COOLING - MXC

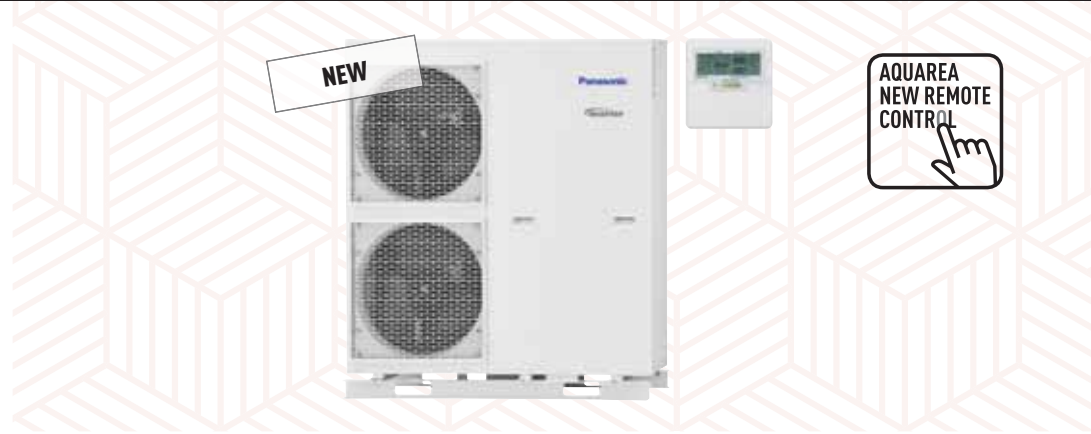

The MXC is ideal for residential properties which don't have an external boiler and require a maintained capacity level.

T-CAP stands for Total Capacity. This new line-up is able to maintain the same nominal capacity even at -15 °C without the help of an electrical booster heater. T-CAP is also able to provide extremely high efficiency, whatever the outside temperature or the water temperature. The MXC adapts well in an existing install with a boiler backup, and in a new application with underfloor heating, low temperature radiators or even fan-coil heaters. This range can also be connected to a solar kit in order to increase efficiency and minimize the impact on the ecosystem. Finally, it is possible to connect a thermostat for even better heating or cooling control and management.

Technical focus

- New remote control functions
- Efficient control of room temperature based on the outdoor temperature, indoor temperature using the Aquarea Manager.
- Optional Smartphone control
- Range from 9 to 16 kW, Single and Three Phase
- Maximum hydraulic module output temperature: 55 °C
- Works down to -20°C
- Cooling temperature range 5-20°C

		Single Phase		Three Phase		
Outdoor unit Heating and Cooling		WH-MXC09G3E5*	WH-MXC12G6E5*	WH-MXC09G3E8*	WH-MXC12G9E8*	WH-MXC16G9E8†
Heating capacity at +7 °C (heating water at 35 °C)	kW	9.00	12.00	9.00	12.00	16.00
COP at +7 °C (heating water at 35 °C)	W/W	4.84	4.74	4.84	4.74	4.28
Heating capacity at +2 °C (heating water at 35 °C)	kW	9.00	12.00	9.00	12.00	16.00
COP at +2 °C (heating water at 35 °C)	W/W	3.59	3.44	3.59	3.44	3.10
Heating capacity at -7 °C (heating water at 35 °C)	kW	9.00	12.00	9.00	12.00	16.00
COP at -7 °C (heating water at 35 °C)	W/W	2.85	2.72	2.85	2.72	2.49
Cooling capacity at 35 °C (cooling water at 7/12 °C)	kW	7.00	10.00	7.00	10.00	12.20
EER at 35 °C (cooling water at 7/12 °C)	W/W	3.17	2.81	3.17	2.81	2.57
Sound pressure level	Cooling / Heating	dB(A)	49 / 49	49 / 49	50 / 50	54 / 53
Sound power level		dB	66	67	66	70
Dimensions	H x W x D	mm	1,410 x 1,283 x 320	1,410 x 1,283 x 320	1,410 x 1,283 x 320	1,410 x 1,283 x 320
Weight		kg	148	148	155	161
Refrigerant (R410A)		kg	2.30	2.30	2.30	
Water pipe connector			R 1 ¼	R 1 ¼	R 1 ¼	R 1 ¼
Pump	Number of speeds		7	7	7	7
	Input power (Min - Max)	W	32 / 102	34 / 110	32 / 102	38 / 120
Heating water flow (ΔT=5 K, 35 °C)		l/min	25.8	34.4	25.8	45.9
Capacity of integrated electric heater		kW	3	6	3	9
Input Power		kW	1.90	2.57	1.90	3.74
Starting Current		A	10.4	16.7	2.9	5.70
Current 1		A	25.0	29.0	14.7	15.5
Current 2		A	26.0	26.0	13.0	13.0
Current 3		A		13.0	13.0	—
Recommended Fuse		A	30 / 30	30 / 30	16 / 16	16 / 16
Recommended power cable section		mm²	4.0 / 4.0	4.0 / 4.0	2.5 / 2.5	2.5 / 2.5
Operation range	Outdoor ambient	°C	-20 / +35	-20 / +35	-20 / +35	-20 / +35
Water outlet	Heating	°C	25 - 55	25 - 55	25 - 55	25 - 55
	Cooling	°C	5 - 20	5 - 20	5 - 20	5 - 20

COP classification is at 230 V only in accordance with EU directive 2003/32/EC. Sound pressure measured at 1 m from the outdoor unit and at 1.5 m height. Performance in agreement with EN14511.

† Tentative data.

* WH-MXC09G3E5 and WH-MXC12G6E5 available in June 2015. WH-MXC09G3E8 and WH-MXC12G9E8 available in June 2015. WH-MXC16G9E8 available in August 2015.

ErP ready 2015	Internet Control Ready INTERNET CONTROL	A class water pump HIGH EFFICIENCY	100% capacity at -15 °C AQUAREA T-CAP	High efficiency heating INVERTER+	Environmentally friendly refrigerant R410A	Down to -20 °C in heating mode OUTDOOR TEMPERATURE	Boiler connection RETROFIT	Solar panels connection SOLAR KIT	Domestic hot water DHW	Easy control by BMS CONNECTIVITY	5 year compressor warranty	INTERNET CONTROL READY: Optional. 5 YEARS COMPRESSOR WARRANTY: Only for PRO partners.
--------------------------	---	--	---	---	--	--	--------------------------------------	---	----------------------------------	--	-----------------------------------	--

AQUAREA HT / AQUAREA G GENERATION HT MONO-BLOC SINGLE PHASE / THREE PHASE HEATING ONLY - MHF



Aquarea HT is able to deliver 65 °C with the Heat Pump alone.

For a house with high temperature radiators (for example, cast iron radiators), the Aquarea High Temperature Solution is most suited as it provides output water temperatures of 65 °C even at -20°C.

Technical focus

- New remote control functions (only for G Generation HT)
- Efficient control of room temperature based on the outdoor temperature, indoor temperature using the Aquarea Manager.
- A Class Pump (only for G Generation HT)
- Optional Smartphone control
- Range from 9 to 12kW, Single and Three Phase
- Maximum hydraulic module output temperature: 65 °C
- Works down to -20°C

		Single Phase				Three Phase	
		WH-MHF09D3E5	WH-MHF12D6E5*	WH-MHF09G3E5	WH-MHF12G6E5*	WH-MHF12D9E8	WH-MHF12G9E8*
Heating capacity at +7 °C (heating water at 35 °C)	kW	9.00	12.00	9.00	12.00	12.00	12.00
COP at +7 °C (heating water at 35 °C)	W/W	4.55	4.40	4.64	4.46	4.40	4.46
Heating capacity at +2 °C (heating water at 35 °C)	kW	9.00	12.00	9.00	12.00	12.00	12.00
COP at +2 °C (heating water at 35 °C)	W/W	3.40	3.23	3.45	3.27	3.23	3.26
Heating capacity at -7 °C (heating water at 35 °C)	kW	9.00	12.00	9.00	12.00	12.00	—
COP at -7 °C (heating water at 35 °C)	W/W	2.70	2.50	2.74	2.52	2.50	—
Heating capacity at +7 °C (heating water at 65 °C)	kW	9.00	12.00	9.00	12.00	12.00	—
COP at +7 °C (heating water at 65 °C)	W/W	2.25	2.20	2.27	2.22	2.20	—
Heating capacity at +2 °C (heating water at 65 °C)	kW	9.00	10.30	9.00	10.30	10.30	—
COP at +2 °C (heating water at 65 °C)	W/W	1.88	1.83	1.90	1.84	1.83	—
Heating capacity at -7 °C (heating water at 65 °C)	kW	8.90	9.60	8.90	9.60	9.60	—
COP at -7 °C (heating water at 65 °C)	W/W	1.62	1.61	1.63	1.62	1.61	—
Sound pressure level	dB(A)	49	50	49	50	50	50
Sound power level	dB	66	67			67	
Dimensions	H x W x D	mm	1,410 x 1,283 x 320	1,410 x 1,283 x 320	1,410 x 1,283 x 320	1,410 x 1,283 x 320	1,410 x 1,283 x 320
Weight		kg	155	155	155	158	162
Refrigerant (R407C)		kg	2.22	2.22		2.22	
Water pipe connector			R 1 1/4	R 1 1/4	R 1 1/4	R 1 1/4	R 1 1/4
Pump	Number of speeds		3	7	7	3	7
	Input Power (Min - Max)	W	38 / 100	40 / 106	—	40 / 106	72
Heating water flow (ΔT=5 K, 35 °C)	l/min	25.8	34.4	25.8	34.4	34.4	34.4
Capacity of integrated electric heater	kW	3	6	3	6	9	9
Input Power	kW	1.98	2.73			2.73	
Running and Starting current	A	9.5	12.8			12.8	
Current 1	A	28.5	29.0			11.9	
Current 2	A	26.0	26.0			13.0	
Current 3	A		13.0			13.0	
Recommended Fuse	A	30 / 30	30 / 30	30 / 30	30 / 30	16 / 16	16 / 16
Recommended power cable section	mm ²	4.0 / 4.0	4.0 / 4.0	4.0 / 4.0	4.0 / 4.0	2.5 / 2.5	2.5 / 2.5
Operation range	Outdoor ambient	°C	-20 / +35	-20 / +35	-20 / +35	-20 / +35	-20 / +35
Water outlet		°C	25 - 65	25 - 65	25 - 65	25 - 65	25 - 65

COP classification is at 230 V only in accordance with EU directive 2003/32/EC. Sound pressure measured at 1 m from the outdoor unit and at 1.5 m height. Performance in agreement with EN14511.

ErP ready 2015	Internet Control Ready INTERNET CONTROL	A class water pump HIGH EFFICIENCY	Output water 65 °C HIGH TEMP HEAT PUMP	High efficiency heating INVERTER+	Environmentally friendly refrigerant R407C	Down to -20 °C in heating mode OUTDOOR TEMPERATURE	Boiler connection RETROFIT	Solar panels connection SOLAR KIT	Domestic hot water DHW	Easy control by BMS CONNECTIVITY	5 year compressor warranty	INTERNET CONTROL READY: Optional. 5 YEARS COMPRESSOR WARRANTY: Only for PRO partners.
--------------------------	---	--	--	---	--	--	--------------------------------------	---	----------------------------------	--	-----------------------------------	--

AQUAREA HIGH PERFORMANCE MONO-BLOC SINGLE PHASE HEATING ONLY - MDF HEATING AND COOLING - MDC



**PV PANELS + HEAT PUMP
MANAGER INCREASE BY
120% THE USAGE OF FREE
ELECTRICITY**
Optional

Panasonic has designed the new Aquarea Mono-Bloc heat pump for houses which have high performance requirements but limited space to install the outdoor unit.

Whatever the weather, Aquarea can work even at -20°C. The Mono-Bloc is easy to install in new and existing residential properties.

Technical focus

- New remote control functions
- Efficient control of room temperature based on the outdoor temperature, indoor temperature using the Aquarea Manager.
- Optional Smartphone control
- Range from 6 to 9kW, Single Phase
- Maximum hydraulic module output temperature: 55 °C
- Works down to -20°C
- Plug and play system

		Single Phase Heating Only		Single Phase Heating and Cooling		
		WH-MDF06E3E5	WH-MDF09E3E5	WH-MDC05F3E5	WH-MDC06E3E5	WH-MDC09E3E5
Heating capacity at +7 °C (heating water at 35 °C)	kW	6.00	9.00	5.00	6.00	9.00
COP at +7 °C (heating water at 35 °C)	W/W	4.48	4.15	5.08	4.48	4.15
Heating capacity at +2 °C (heating water at 35 °C)	kW	5.00	7.45	4.80	5.00	7.45
COP at +2 °C (heating water at 35 °C)	W/W	3.45	3.14	3.75	3.45	3.14
Heating capacity at -7 °C (heating water at 35 °C)	kW	5.15	7.70	4.50	5.15	7.70
COP at -7 °C (heating water at 35 °C)	W/W	2.68	2.12	2.98	2.68	2.12
Cooling capacity at 35 °C (cooling water at 7/12 °C) ¹	kW	—	—	4.50	5.50	7.00
EER at 35 °C (cooling water at 7/12 °C) ¹	W/W	—	—	3.33	2.74	2.44
Sound pressure level	Cooling / Heating	dB(A)	— / 47	47 / 47	47 / 47	49 / 49
Sound power level	Cooling / Heating	dB	— / 65	65 / 65	65 / 65	67 / 67
Dimensions	H x W x D	mm	865 x 1,283 x 320	865 x 1,283 x 320	865 x 1,283 x 320	865 x 1,283 x 320
Weight		kg	112	107	112	112
Refrigerant (R410A)		kg	1.45	1.42	1.45	1.45
Water pipe connector			R 1 ¼	R 1 ¼	R 1 ¼	R 1 ¼
Pump	Number of speeds		Variable Speed	Variable Speed	Variable Speed	Variable Speed
	Input power (Min - Max)	W	33 / 110	40 / 120	33 / 110	40 / 120
Water Flow (ΔT=5 K, 35 °C)		l/min	17.2	25.8	9.2	17.2
Capacity of integrated electric heater		kW	3	3	3	3
Input Power at +7 °C		kW	1.34	2.17	0.985	1.34
Running and Starting current at +7 °C		A	6.1	9.9	3	6.1
Recommended Fuse		A	30 / 16	30 / 16	30 / 15	30 / 16
Recommended power cable section		mm ²	4.0 / 2.5	4.0 / 2.5	4.0 / 2.5	4.0 / 2.5
Operation range	Outdoor ambient	°C	-20 / +35	-20 / +35	-20 / +35	-20 / +35
		°C	20 - 55	20 - 55	20 - 55	20 - 55

COP classification is at 230 V only in accordance with EU directive 2003/32/EC. Sound pressure measured at 1 m from the outdoor unit and at 1.5 m height. Performance in agreement with EN14511.

¹ Specifications for Heating and Cooling models.

Tentative. Authorized service partner or Authorized installer can enable the cooling mode through a special operation via the remote controller on site.

ErP ready
2015

Internet Control Ready
INTERNET CONTROL

A class water pump
HIGH EFFICIENCY

5.08 COP high efficiency
AQUAREA HIGH PERFORMANCE

High efficiency heating
INVERTER+

Environmentally friendly refrigerant
R410A

Down to -20 °C in heating mode
OUTDOOR TEMPERATURE

Easy control by BMS
CONNECTIVITY

5 year compressor warranty

INTERNET CONTROL READY: Optional.
5 YEARS COMPRESSOR WARRANTY: Only for PRO partners.

SANITARY TANKS

AQUAREA TANK



Aquarea Tank. Tanks and buffer tank in one!		PAW-TD20B8E3-NDS	
Water volume	L	185 (for DHW tank) / 80 (for buffer tank)	
Maximum water temperature	°C	100	
Dimension	H x W x D	mm 1,810 x 600 x 632	
Weight	kg	150	
Electric heater	kW	3	
Power supply	V	230 - 2p	
Material inside tank		Stainless steel	
Exchange surface	m ²	2.3	
Energy loss at 65 °C ¹	kWh/24h	1.3	
A class pump	Number of speed	Stepless (800-4250 rpm)	
	Pressure drop (Min / Max)	kPa 5 / 6	
	Input power (Min / Max)	W 3 / 45	
3 Way valve included		Yes	
Safety thermostat with contact for failure part of E-Heating		Yes	
Location of the electrical heater		Mid	
Electrical backup heater on the buffer tank		Optional	

*Only for Ireland



Tanks	Slimline HP Tank	Standard Heat Pump Tank		
Model	PAW-TE18C2E3HI-UK	PAW-TE18C2E3STD-UK	PAW-TE30C2E3STD-UK	PAW-TE40C2E3STD-UK
Indoor				
Outdoor				



Water volume	L	180	180	300	400
Maximum water temperature	°C	95	95	95	95
Dimensions	Hight / Diameter	mm 1,790 / 475	1,295 / 550	2,020 / 550	2,040 / 630
Weight	kg	33	33	49	61
Electric heater	kW	3	3	3	3
Power supply	V	230	230	230	230
Material inside tank		Stainless steel	Stainless steel	Stainless steel	Stainless steel
Exchange surface	m ²	3.01	1.36	2.04	2.91
Secondary Coil Exchange surface	m ²		0.68	0.97	1.27
Energy loss at 65°C ¹	kWh/24h	2.01	1.40	1.93	3.33
3 Way valve included		Yes	Yes	Yes	Yes
20 m temperature sensor cable included		Yes	Yes	Yes	Yes
Heat up time	Valuation	★★★★	★★★★	★★★★	★★★★
Energy losses	Valuation	★★★★	★★★★	★★★★	★★★★
Efficiency of the tank	Valuation	★★★★	★★★★	★★★★	★★★★
Warranty		25 years	25 years	25 years	25 years
Maintenance required		Yearly	Yearly	Yearly	Yearly



High efficiency water tanks with a large exchange surface and high levels of insulation to minimise energy losses.

1) Insulated tested under EN12897.

* Available from June 2014. Sold complete with G3 compliant kit.

AQUAREA AIR RADIATORS

AQUAREA
AIR



The slimline Panasonic Aquarea Air radiators deliver high efficiency climate control. With a depth of just under 13 cm they are at the cutting edge of the market.

Exceptional ventilation efficiency means the motor uses considerably less energy (low wattage). The fan speed is continuously modulated by the temperature controller with proportional integral logic, with undoubted advantages for regulating the temperature and humidity in summer mode. All temperature curves and capacity are available on www.panasonicproclub.com.

Main features

- Front panel heating with radiant effect
- High heating capacity (without main fan running)
- 4 fan speeds and capacities
- Exclusive design
- Extremely compact (only 12.9 cm deep)
- Cooling and dehumidification functions possible (drain is needed)
- 3-way valve included (no overflow valve needed on the installation if more than 3 radiators installed)
- Touch screen thermostat

Fan Coils for Heat Pump application	PAW-AAIR-200						PAW-AAIR-700						PAW-AAIR-900						
Total heating capacity	W	138	160	217	470	570	223	360	708	1,032	1,188	273	475	886	1,420	1,703			
Water flow	kg/h	23.7	27.5	37.3	80.8	98.0	38.4	61.9	121.8	177.5	204.3	47.0	81.7	152.4	244.2	292.9			
Water pressure drop	kPa	0.1	0.2	0.4	2.0	2.9	0.1	0.1	0.3	0.8	1.0	0.1	0.2	0.5	1.6	2.2			
Air flow	m ³ /h	28	37	55	113	162	44	84	155	252	320	54	110	248	367	461			
	Speed	Main Fan Off	Super Min	Min	Med	Max	Main Fan Off	Super Min	Min	Med	Max	Main Fan Off	Super Min	Min	Med	Max			
Maximum input power	W	2	5	7	9	13	3	9	14	18	22	3	11	16	20	24			
Sound pressure level	dB(A)	17.6	18.8	24.7	33.2	39.4	18.4	19.6	25.8	34.1	40.2	18.4	22.3	26.2	34.4	42.2			
Inlet water temperature	°C	35	35	35	35	35	35	35	35	35	35	35	35	35	35	35			
Outlet water temperature	°C	30	30	30	30	30	30	30	30	30	30	30	30	30	30	30			
Inlet air temperature	°C	19	19	19	19	19	19	19	19	19	19	19	19	19	19	19			
Outlet air temperature	°C	34.5	32.6	38.9	32.0	30.0	34.9	32.4	33.3	31.8	30.6	34.8	32.5	30.2	31.1	30.6			
Dimensions (H x W x D)	mm	735 x 579 x 129						935 x 579 x 129						1,135 x 579 x 129					
Weight	kg	17						20						23					
3 ways valve included		Yes						Yes						Yes					
Touch screen thermostat		Yes						Yes						Yes					

* Includes 3-way valve, booster heater and sensor.

Accessories for Aquarea Air	PAW-AAIR-LEGS-1	Kits of 2 legs to support the Aquarea Air on the floor and to protect the water pipings
-----------------------------	-----------------	---

Operating on heating mode with radiator using only radiant effect

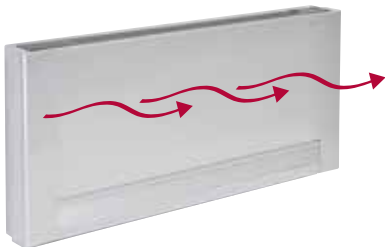

Operating on heating mode with radiant effect and fan mode

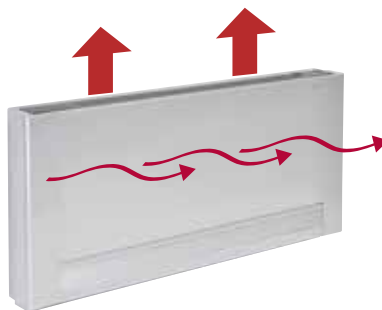

Operating on cooling mode with fan

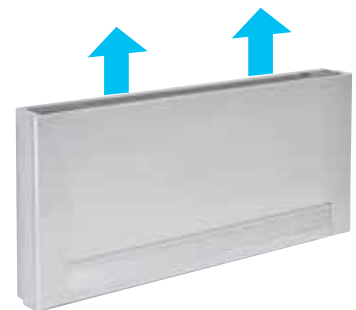

Accessories



CZ-NS1P // CZ-NS3P // CZ-NS2P



CZ-NE1P



CZ-TK1



PAW-TS1 / PAW-TS2

Solar Kit Accessories	
CZ-NS1P	PCB for solar connection kit for split systems
CZ-NS2P	PCB for solar connection kit for Mono-Bloc systems
CZ-NS3P	PCB for solar connection kit for Mono-Bloc systems 6 & 9 kW
Device Accessories	
CZ-NE1P	Base pan heater (for all old Bi-Bloc and Mono-Bloc, not for the 3 and 5 kW)
CZ-NE2P	Base pan heater (for 3 and 5 kW)
CZ-NE3P	Base pan heater (for all new F generation products: F3, F6, F9)

Sanitary Tank Accessories	
CZ-TK1	Temperature sensor kit for third party tank (with copper pocket and 6 m length sensor cable)
CZ-TK1-PACK10	10 Kit 3rd Party Tank including pocket sensor
PAW-TS1	Tank sensor with 6 m cable length
PAW-TS2	Tank sensor with 20 m cable length
PAW-TS4	Tank sensor with 6 m cable length and only 6 mm diameter
Buffer Tanks	
PAW-BTANK50L	50 l buffer tank

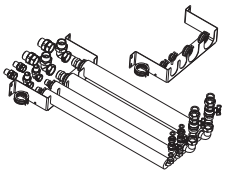

PAW-ADC-PREKIT



PAW-ADC-CV150



PAW-GRDBSE20



PAW-WTRAY



PAW-GRDSTD40

Accessories For All In One	
PAW-ADC-PREKIT	Flexible pipings and wall mounting plate for all in one
PAW-ADC-CV150	Decorative magnetic side cover
Accessories for Aquarea Air	
PAW-AAIR-LEGS-1	Kits of 2 legs to support the Aquarea Air on the floor and to protect the water pipings

Other accessories	
PAW-GRDBSE20	20 cm outdoor base ground support for noise and vibration absorption (600 x 200 x 130, 500 kg)
PAW-WTRAY	Tray for condenser water compatible with base ground support
PAW-GRDSTD40	Outdoor elevation platform
CZ-UG30	Noise reduction kit for outdoor units (-3dBa)

Extended Warranty	
PAW-A2W-7YW	Extended 7 years warranty only for PRO Partners

Control



PAW-HPM1



PAW-HPM2



PAW-HPMED / PAW-HPMLCD

Aquarea Manager Kits	
PAW-HPM12ZONE-U	HPM with room sensor and setpoint adaption for Bi-Bloc + sensors
PAW-HPM12ZONE-M	HPM with room sensor and setpoint adaption for Mono-Bloc + sensors
PAW-HPM12ZONELCD-U	HPM with LCD wireless room thermostat for Bi-Bloc + sensors
PAW-HPM12ZONELCD-M	HPM with LCD wireless room thermostat for Mono-Bloc + sensors
PAW-HPM12ZONE-F	HPM with room sensor and setpoint adaption for Mono-Bloc + Bi-Bloc F type + sensor and G type
PAW-HPM12ZONELCD-F	HPM with LCD wireless room thermostat for Mono-Bloc + Bi-Bloc F type + sensor and G type

Aquarea Manager Accessories	
PAW-HPMED	Touch screen
PAW-HPMLCD	LCD Display HPM Manager
PAW-HPM1	Aquarea Manager with LCD
PAW-HPM2	Aquarea Manager without LCD
PAW-HPMINT-U	Interface to connect Aquarea Manager to Heat pump Aquarea Bi-Bloc (HPM can control all parametres from HP)
PAW-HPMINT-M	Interface to connect Aquarea Manager to Heat pump Aquarea Mono-Bloc (HPM can control all parametres from HP)
PAW-HPMINT-F	Interface to connect Aquarea Manager to Heat pump Aquarea Mono-Bloc and Bi-Bloc F type (HPM can control all parametres from HP)
PAW-HPMB1	Buffer tank sensor
PAW-HPMDHW	Buffer tank sensor with well
PAW-HPMSOL1	Buffer tank sensor solar (with higher temperature range)
PAW-HPMAH1	Water flow pipe sensor for heating circuit
PAW-HPMR4	Room sensor + set point adaption
PAW-DEWPOINTSSENSOR	Dew point sensor
PAW-HPMUH	Outdoor temperature sensor



PAW-A2W-RTWIRED



PAW-A2W-RTWIRELESS

Room Thermostats	
PAW-A2W-RTWIRED	Wired LCD room thermostat with weekly timer
PAW-A2W-RTWIRELESS	Wireless LCD room thermostat with weekly timer

Hydraulic Accessories	
PAW-2PMP2ZONE	Low loss header, 2 zone kit, manifold, 2 A-class pumps, 1 mixture valve
PAW-FILTER	2 check valves + filter with 1"
PAW-FILTER-ONLY	Filter with 1"
PAW-FLWMTR-KIT	Connection kit, flow detector and strain filter
PAW-G3KIT	WRAS approved G3 kit

Connectivity Solutions	
PAW-AW-KNX-1i	KNX Interface
PAW-AW-MBS-1	Modbus Interface
PA-AW-WIFI-1	IntesisHome Interface
PA-AW-WIFI-1TE	Wired room temperature sensor (only for PA-AW-WIFI-1)
PAW-LANCABLE	Network cable
PAW-A2WSWITCH	Network switch

Controller	
PAW-A2W-BIV	NEW: Bivalent controller, available in March 2015

Examples of installations with Aquarea Manager

Temperature control in the 2 zones with PAW-HPM12ZONE-U

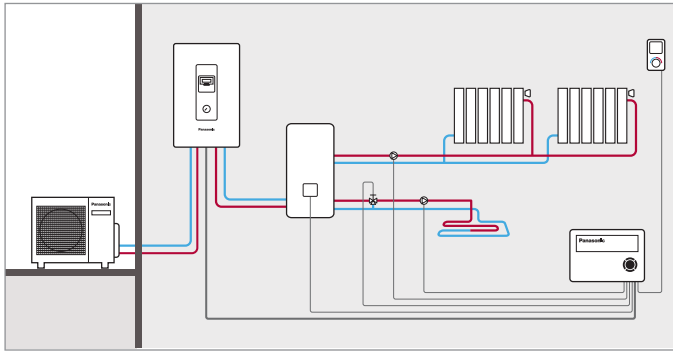

Temperature control in zones 2 + ECS with PAW-HPM12ZONE-U

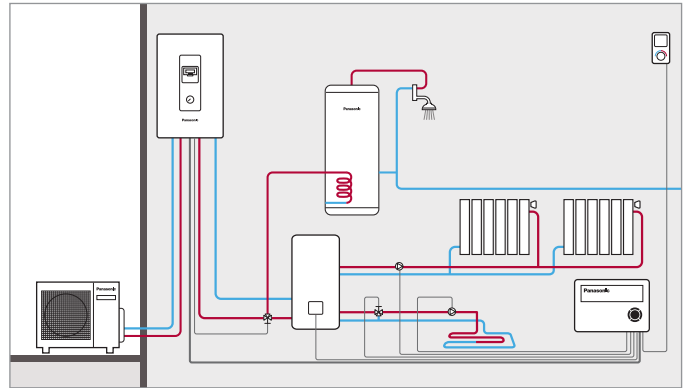

2 heat pumps in cascade with the PAW-HPM12ZONELCD-U

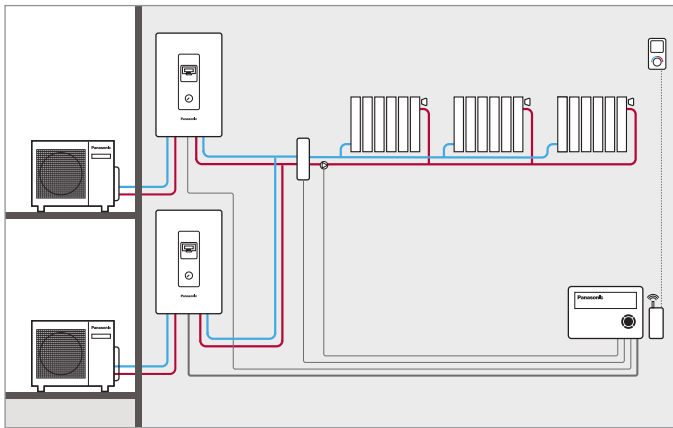

Management of heat pump + boiler and DHW with PAW-HPM12ZONELCD-U

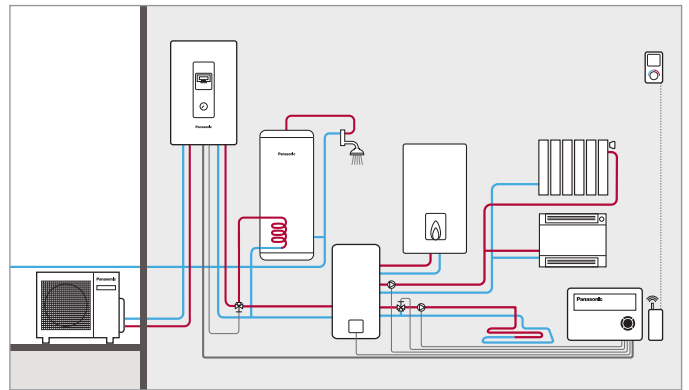

2 heat pump + boiler with PAW-HPM12ZONE-U

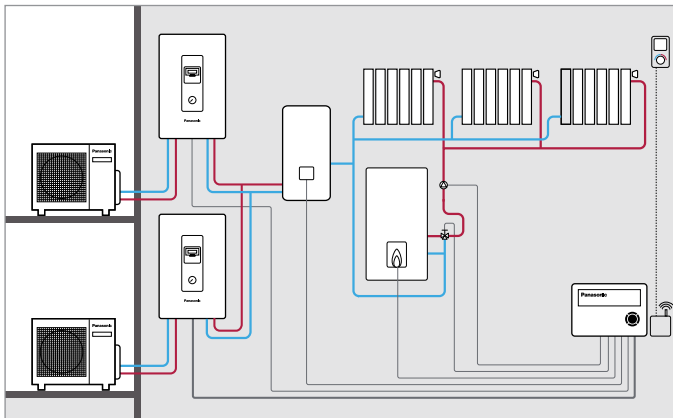

3 heat pumps in cascade with PAW-HPM12ZONELCD-U

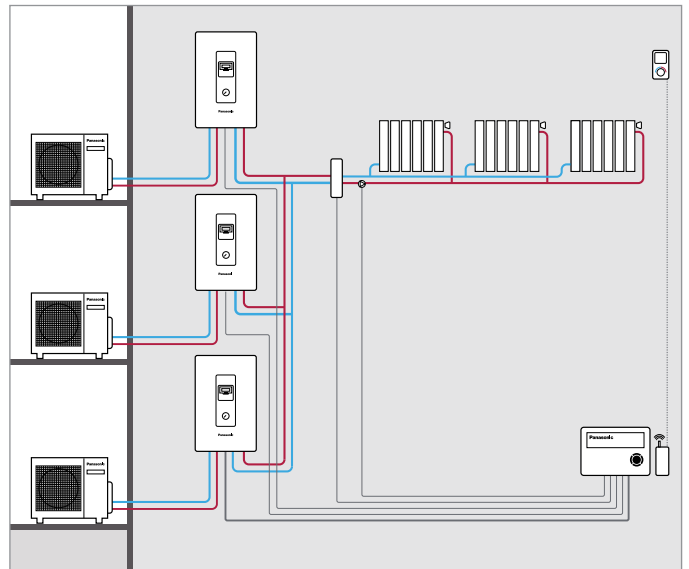



A typical example of savings and efficiencies that Aquarea can offer to you

A 170m² house in Birmingham

The example below shows a typical 3 bedroom UK home and highlights the potential savings that can be achieved with Panasonic's Aquarea heat pump. *

Building data	
Address	Birmingham (GB)
Building area	170 m ²
Standard heating requirement	6.8 kW
Internal gains	5100 kWh/year
Solar gains (windows)	3060 kWh/year
Indoor design temperature	20 °C
Outdoor temp. limit for heating 'on'	15 °C
Heat distribution	Underfloor heating by 100 % Radiator heating by -- % Wall heating by -- %
Max. flow water temperature	35 °C
Max. return water temperature	30 °C
Solar collector area	-- m ²

Service hot water	
Type of service	Hot water with heat pump
Tank volume	300 Litre
Average daily need	200 Litre
Cold water inlet temperature	10 °C
Target tank temperature	50 °C
Exchange loss	5 K
Electrical auxiliary heating necessary	No

Used Panasonic heat pump	
Description	WH-MHF09D3E5
Sanitary tank	WH-TD30E3E5
Heat pump type	Air / Water
Wattage at 2/35	Heat: 9.0 kW, Electric: 2.5 kW
Recommended flow-through of air	4600.0 m ³ /h
Max. flow temperature	65 °C
Mode of operation	Monovalent
Design/Bivalent temperature	-10.0 °C
Number of heat pumps used	1
Wattage of fan (included in heat pump performance data: yes)	60 W
Wattage of heat circulation pump(s)	180 W

* Calculations were carried using Panasonic's Aquarea Designer software, available from the PRO Club website (www.panasonicproclub.com).

Rate data		
Description	UK (Panasonic)	
Shut off times total	0,0 h/day	
Weekends with shut off times	Yes	
Daytime rate of heat pump	Time for daytime rate	
	5-19 o'clock	14,0 pence/kWh
Nighttime rate of heat pump	Time for nighttime rate	
	19-5 o'clock	14,0 pence/kWh
Heat circulation pump(s)	Like heat pump: yes	-- pence/kWh
Heating element for monoenergetic operation	Like heat pump: yes	-- pence/kWh
Heating element for post heating of hot water	Like heat pump: yes	-- pence/kWh

Climatic data				
Climatic location	Reims (FR)			
Monthly average temperatures in °C	Jan	3.4	Jul	16.0
	Feb	3.6	Aug	15.9
	Mar	5.7	Sep	13.7
	Apr	8.0	Oct	10.4
	May	11.2	Nov	6.7
	Jun	14.1	Dec	4.6

Calculation results

Monthly heat consumption in kWh

Annual energy costs	
Caused by heat producers	
Heat pump	638 €
Hot water heating rod	0 €
Caused by heat consumers	
Space heating	330 €
Service hot water	174 €
Heat circulation pump(s)	134 €
Total	638 €

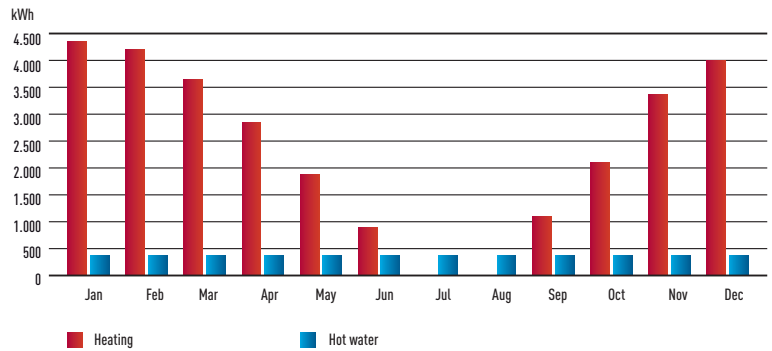

Aquarea energy coverage

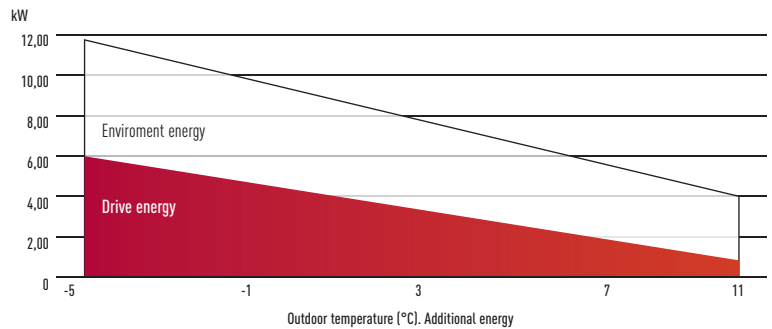

Comparison of running costs

Operational costs				
Type of heating	Price in pence/kWh	Efficiency (%)	Additional costs in £/year	Total costs in £/year
Heat pump	-	-	0	638
Oil	6.5	85	0	1,426
Gas	4.0	90	0	779
Wood heating	5.0	80	0	--
Electric night storage heater	12.0	100	0	1353
Electric heating element	14.0	100	0	2,038

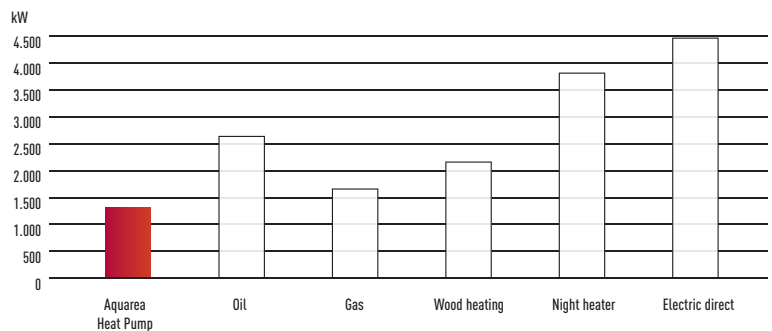

Comparison of CO₂ emissions

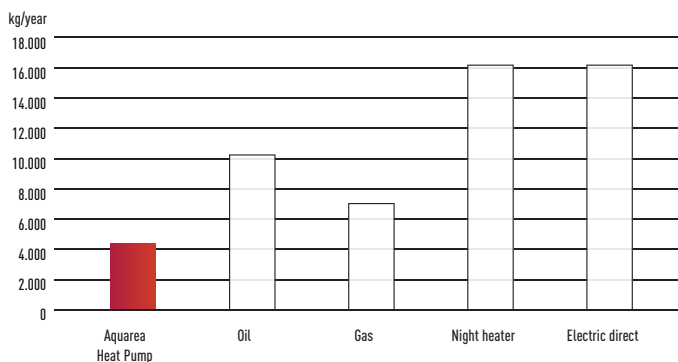

Comparison of CO₂ savings

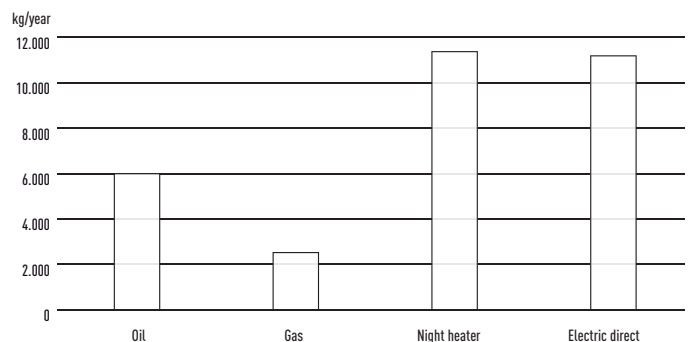

Dimensions

All in One

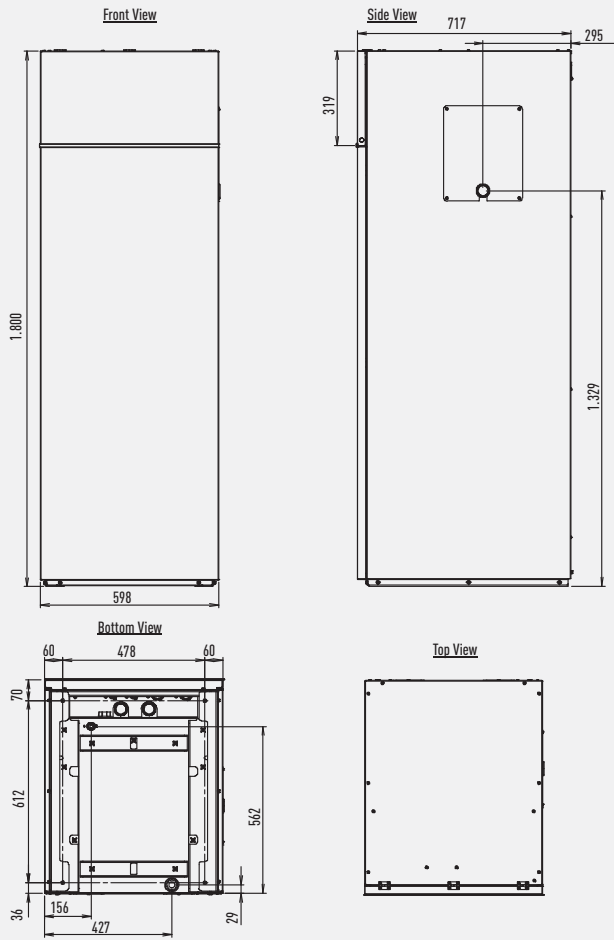

Hydraulic Module for all models

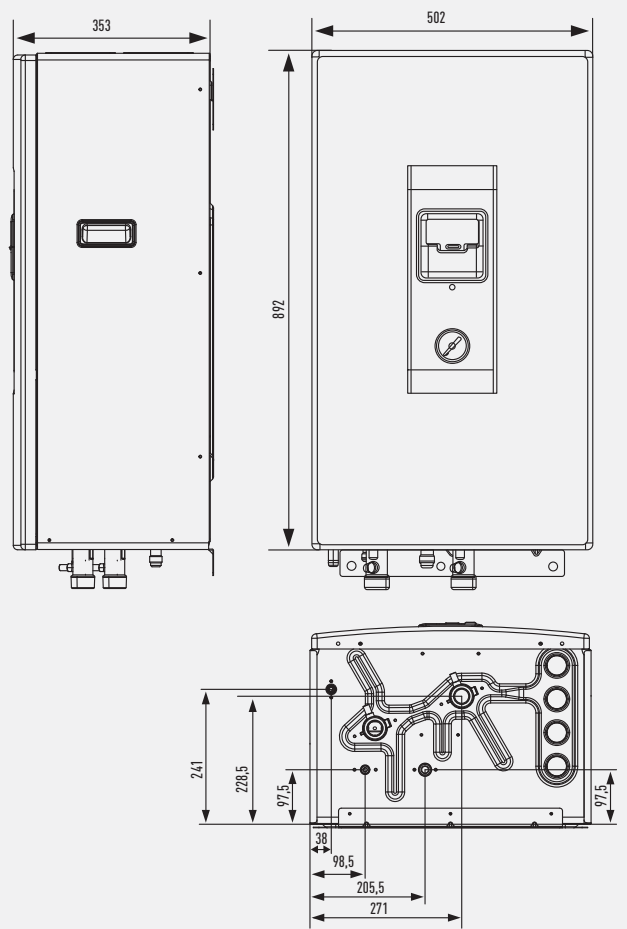

One fan outdoor unit

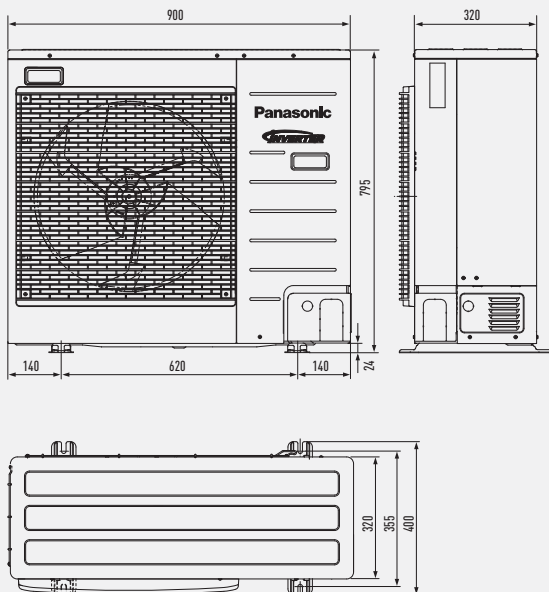

Two fans outdoor unit

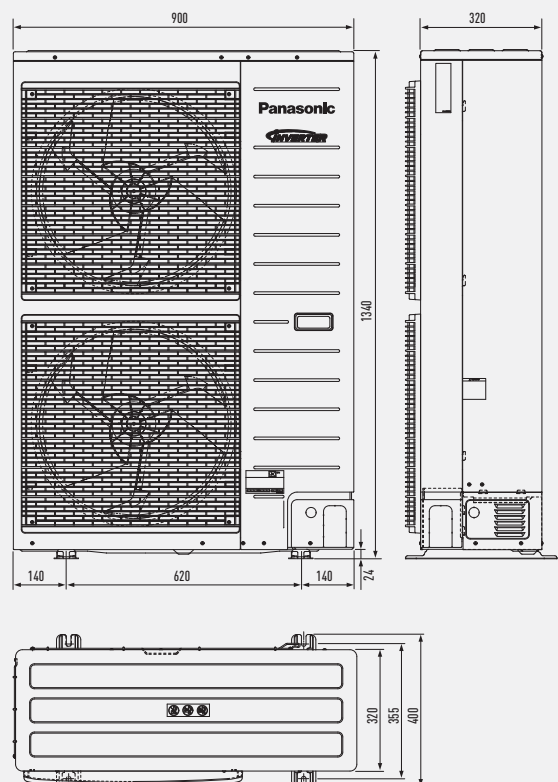

Bi-Bloc 3 and 5kW

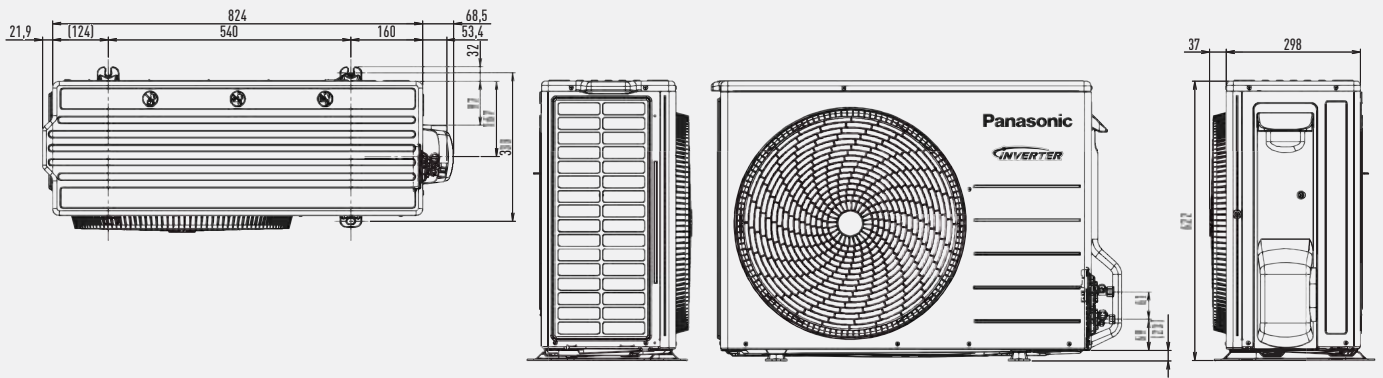

Mono-Bloc 6 and 9kW

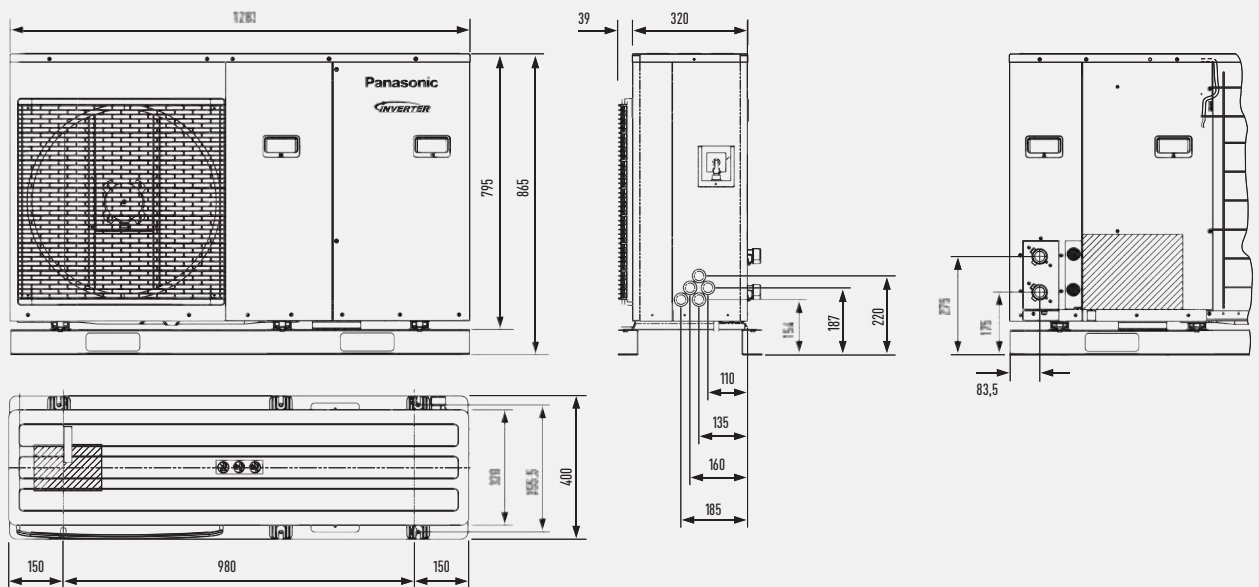

Mono-Bloc 9 to 16kW

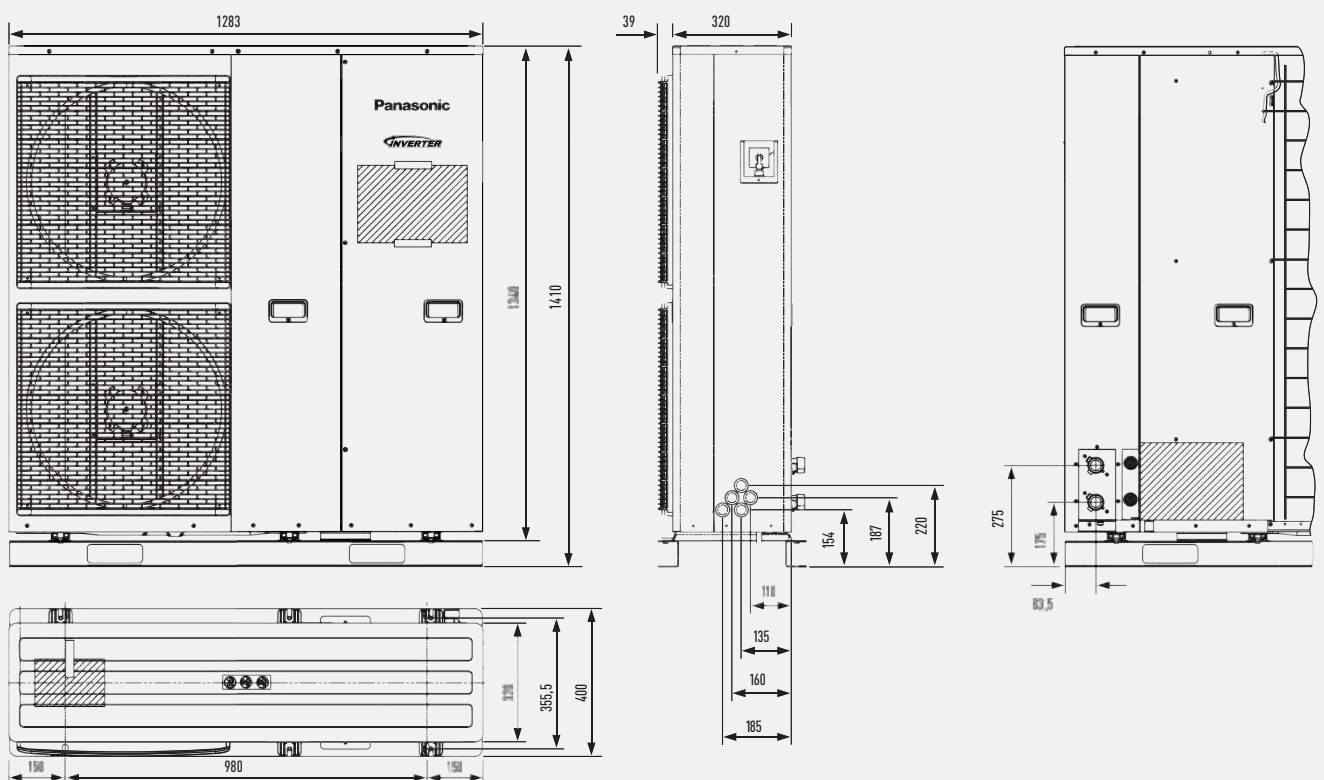



ETHEREA

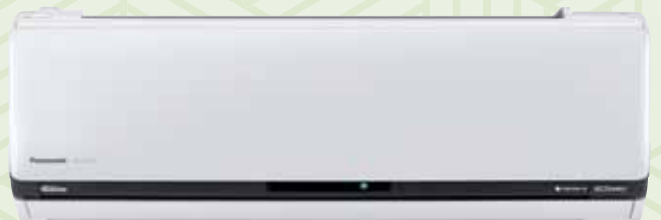

heatcharge



Panasonic Air Conditioning System Wins Prestigious Design Award

Panasonic is pleased to announce that its Ethera air conditioning system has won an iF 2013 Product Design Award.

The iF Product Design Awards are among the most important awards for product design excellence. With strict criteria to judge everything from cosmetic appearance, functionality, through to the environmental impact of the product, awards are only given to those products that demonstrate their innovative design.

Winning the award thanks to its highly intelligent functionality, the Panasonic Ethera is the ideal air-conditioning system for domestic and other localised installations. The unit makes use of multiple sensors, which measure the room's temperature, humidity, as well as detecting human presence.



WELCOME TO DOMESTIC RANGE

Panasonic has developed a range of products designed for you, better than ever before.

With its innovative design, high efficiency and incomparable purification system, the Etherea range has been designed with your clients in mind. Above all, it is also a range for air conditioning professionals, such as yourself, thanks to its broad range of products which are capable of conditioning rooms of all sizes – always with optimal efficiency and incomparable ease of installation. The Etherea range guarantees that you are offering your clients the very best.

Go green. Go clean. Go your way

Panasonic Air Conditioners are designed to provide more than just comfort cooling to homes. They save energy. They purify your surroundings. They adjust cooling power to suit your living spaces and styles. Living an eco-lifestyle your way is now easier than ever.



Highlighted Features

Panasonic air conditioners provide more savings and more comfort

We believe that going green shouldn't compromise on comfort. That's why Panasonic is introducing the new Econavi system; combining human sensor and control program technology to detect and reduce energy waste by 38% .

Our super silent air conditioners guarantee the purest air to take care of you and your family. And, for a cleaner living environment, the new Nanoe-G helps purify the air as well as your surroundings. Together, these breakthrough technologies define what Panasonic's Eco Clean Life Innovation is all about – innovations that improve our environment while making life as comfortable as possible.



ENERGY SAVING



Up to **38%**
energy savings
(cooling)

ECONAVI

Econavi features intelligent Human Activity Sensor and new Sunlight Sensor technologies that can detect and reduce waste by optimising air conditioner operation according to room conditions. With just one touch of a button, you can save energy efficiently with uninterrupted cooling, comfort and convenience.

8,60 A+++
SEER

SEASONAL ENERGY EFFICIENCY RATIO

Exceptional Seasonal Cooling Efficiency based on the new ErP regulation. Higher SEER ratings mean greater efficiency. Save all the year while cooling!

5,40 A+++
SCOP

SEASONAL COEFFICIENT OF PERFORMANCE

Exceptional Seasonal Heating Efficiency based on the new ErP regulation. Higher SCOP ratings mean greater efficiency. Save all the year while heating!

Energy saving

INVERTER+

The A Inverter system provides energy savings of up to 50%. Both you and nature wins!

Improved comfort

AUTOCOMFORT

The Autocomfort system detects conditions in the room and switches to energy saving operation when nobody is on the room.

Silent air
20 dB(A)

SUPER QUIET

With Super Quiet technology our devices are as quiet as a library.

Down to
-10°C in
cooling mode

OUTDOOR TEMPERATURE

Down to -10 °C in cooling only mode. The air conditioner works in cooling only mode with an outdoor temperature of -10 °C.

Down to
-15°C in
heating mode

OUTDOOR TEMPERATURE

Down to -15 °C in heating mode. The air conditioner works in heat pump mode with an outdoor temperature as low as -15 °C.

Constant heating

HEATCHARGE

Heatcharge, this innovative, newly developed technology charges heat and uses it for heating. Thanks to this system, you can enjoy incredibly powerful, comfortable air conditioner heating.

Prevent freezing

SUMMER HOUSE

Summer House, this innovative function keeps the house at 7/8 °C to avoid freezing pipes during the winter. This function is highly appreciated in summer house or week end houses.

Easy control by BMS

CONNECTIVITY

The communication port is integrated into the indoor unit and provides easy connection to, and control of, your Panasonic heat pump to your home or building management system.

Internet Control Ready

INTERNET CONTROL

Internet Control is a next generation system providing a user-friendly remote control of air conditioning or heat pump units from everywhere, using a simple Android or iOS smartphone, tablet or PC via internet.

Possible to use on R22 pipings

R22 RENEWAL

The Panasonic renewal system allows good quality existing R22 pipe work to be re-used whilst installing new high efficiency R410A systems.

HEALTHY AIR



Air purifier
99% removal
bacteria - virus - mold

nanoe-G

Nanoe-G utilises nano-technology fine particles to purify the air in the room. It works effectively on airborne and adhesive micro-organisms such as bacteria, viruses and mould thus ensuring a cleaner living environment. Seal of Approval of the British Allergy Foundation

Perfect humidity control

MILD DRY

The Perfect Humidity Air controls the humidity level in the air to prevent over-dryness.

5 year compressor warranty

5 Years Warranty. We guarantee the compressors in the entire range for five years. Only for PRO partners.

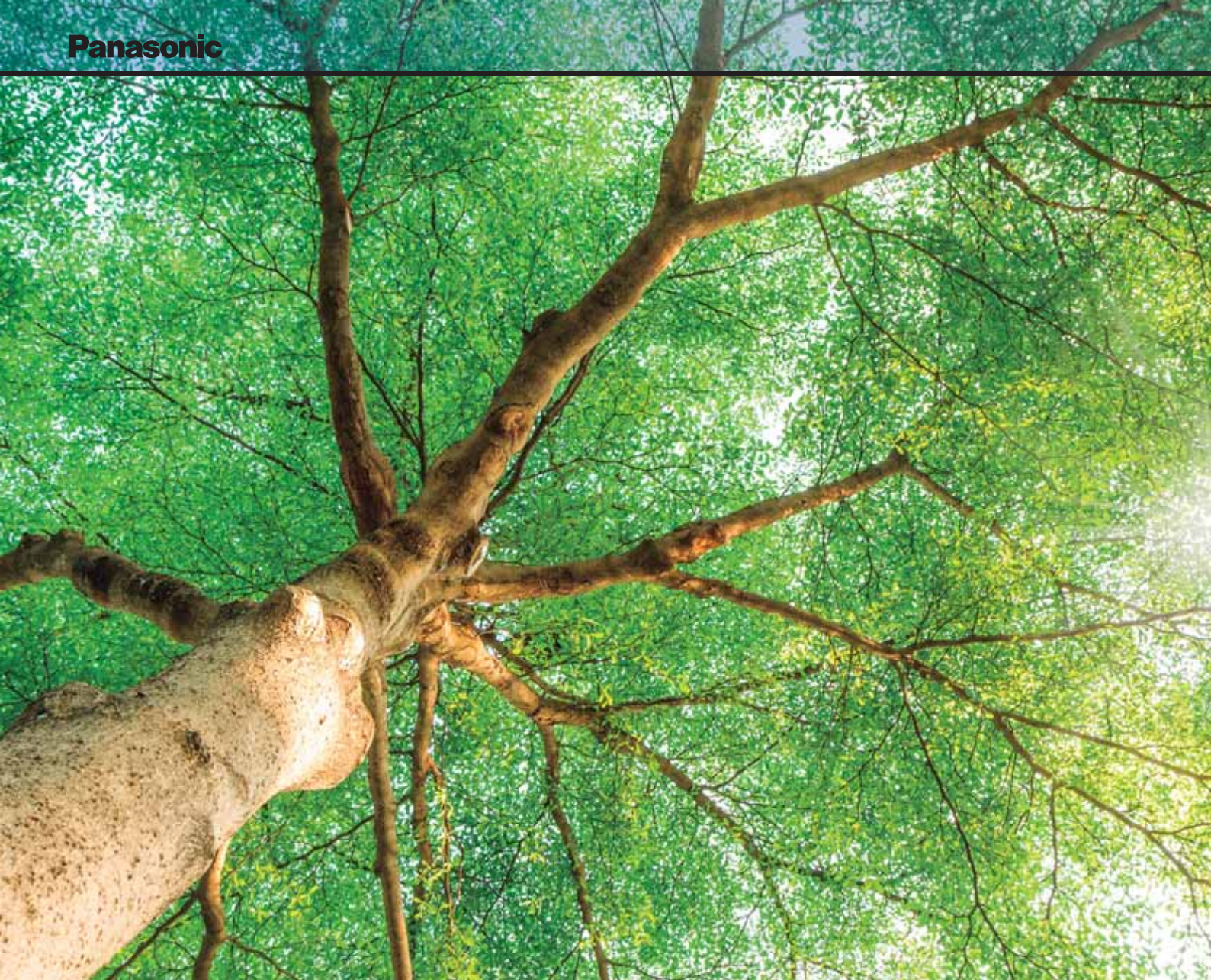

The very best SEER and SCOP

Etherea and Heatcharge. Economical, environment-friendly operation high SCOP (Seasonal Coefficiency of Performance).





New Etherea and Heatcharge performance: the very best SEER and SCOP available

Original Panasonic Inverter technology and a high performance compressor provide top-class operating efficiency. This lets you enjoy lower electricity bills while contributing to environmental protection.

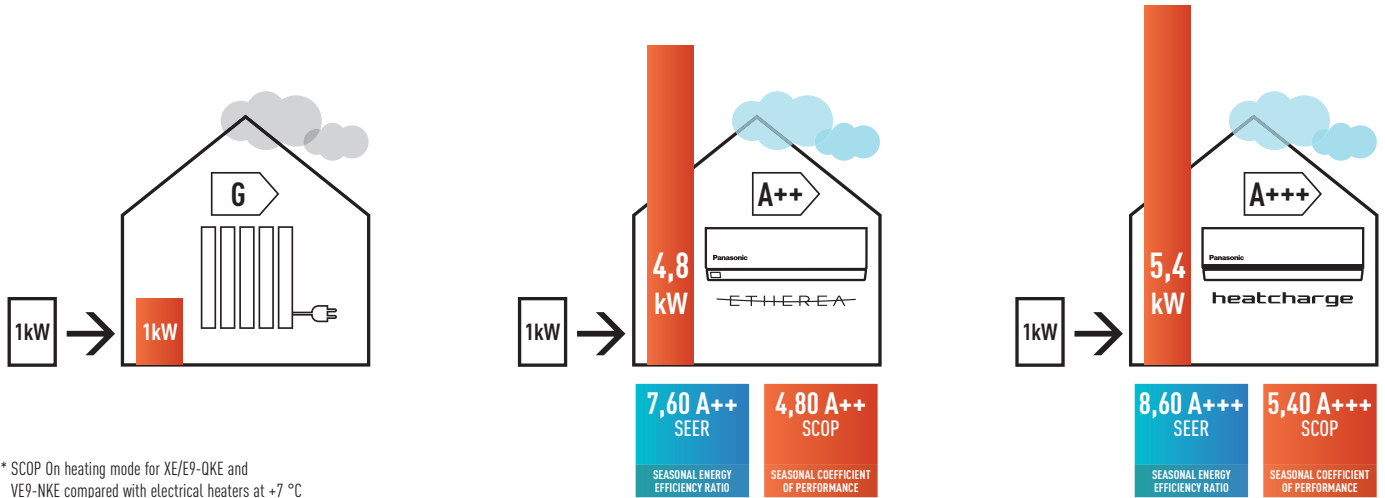

* SCOP On heating mode for XE/E9-OKE and VE9-NKE compared with electrical heaters at +7 °C

Seasonal Efficiency: New Energy Efficiency Label

From January 2013, the energy performance calculation for air conditioning systems changed from an overall EU based standard of EER and COP to a new standard based on seasonal efficiencies of SEER and SCOP. These changes to the Energy Related Products Directive or ErP are designed to give consumers a better understanding of the real efficiency of air conditioning and heat pump systems whose nominal power rating does not exceed 12kW.

Undergoing gradual implementation from 1 January 2013 until 1 January 2019, the schedule for each product category is as follows:

- 01 January 2013: A+++, A++, A+, A, B, C, D, E, F and G.
- 01 January 2015: A+++, A++, A+, A, B, C, D, E and F.
- 01 January 2017: A+++, A++, A+, A, B, C, D and E.
- 01 January 2019: A+++, A++, A+, A, B, C and D.

Seasonal Energy Efficiency Ratio (SEER) – This is the overall energy efficiency ratio of the unit, representative of the entire cooling season. It is calculated as the annual cooling demand divided by the annual consumption of electricity for cooling.

Seasonal Coefficient of Performance (SCOP) - This is the overall coefficient of performance of the unit, representative of the entire heating season designated (the value of SCOP corresponds to a determined heating season). It is calculated by dividing the reference annual heating demand by the annual consumption of electricity for heating.

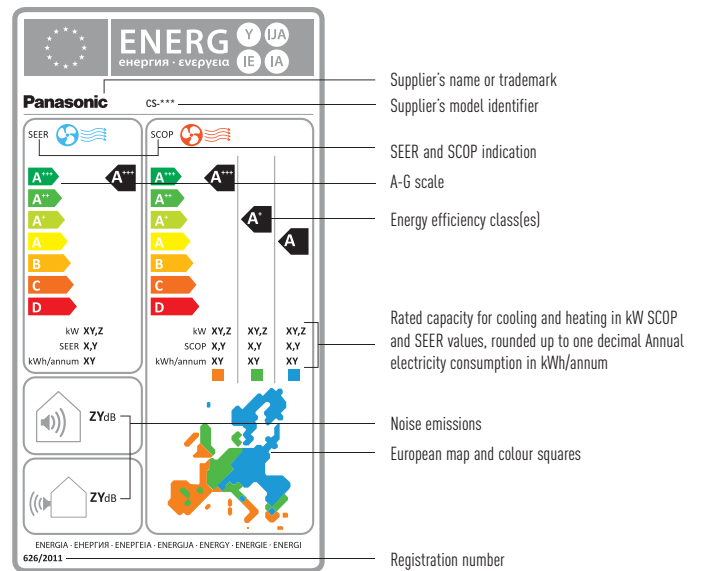

SEER	SEER	SCOP	SCOP
A+++	SEER ≥ 8.50	A+++	SCOP ≥ 5.10
A++	6.10 ≤ SEER < 8.50	A++	4.60 ≤ SCOP < 5.10
A+	5.60 ≤ SEER < 6.10	A+	4.00 ≤ SCOP < 4.60
A	5.10 ≤ SEER < 5.60	A	3.40 ≤ SCOP < 4.00
B	4.60 ≤ SEER < 5.10	B	3.10 ≤ SCOP < 3.40
C	4.10 ≤ SEER < 4.60	C	2.80 ≤ SCOP < 3.10
D	3.60 ≤ SEER < 4.10	D	2.50 ≤ SCOP < 2.80
E	3.10 ≤ SEER < 3.60	E	2.20 ≤ SCOP < 2.50
F	2.60 ≤ SEER < 3.10	F	1.90 ≤ SCOP < 2.20
G	SEER < 2.60	G	SCOP < 1.90

- HIGHER EFFICIENCY
- SINGLE AND DUAL PISTON
- R-410A REFRIGERANT
- COMPACT SIZE



Panasonic R2 Rotary Compressor

Making the world a cooler place since 1978.

Panasonic Rotary Compressors for Room Air Conditioners have been installed in the most demanding environments around the world. Designed to withstand extreme conditions, Panasonic Rotary delivers high performance, efficiency and reliable service, no matter where you are.

Panasonic, the world's largest manufacturer of rotary compressors.



Why is the Panasonic R2 Rotary Compressor so efficient?

1. High Efficiency Motor The premium silicon steel motor meets industry efficiency requirements.
2. Improved Lubrication of High Volume Oil Pump The extended, high volume oil pump in conjunction with a larger capacity oil reservoir provides superior lubrication.
3. Accumulator has Larger Refrigerant Capacity The larger accumulator accommodates generous refrigerant amounts needed in longer line length installations.

R2 rotary compressors utilize rolling piston technology.

The R2 compressor has been tested in extreme conditions.



R2 Compressor Value

About R2 Compressor

Built upon 36 years of compressor design and production experience, R2 is the next generation of Rotary Compressors for residential central air conditioning. New technology improvements, enhanced materials and simple design ensure R2 compressors are reliable, efficient and quiet. The R2 Compressor delivers quality, comfort and peace of mind in homes around the world.

Panasonic's Rotary Compressors have been life tested in some of the world's most demanding environments. Proven for years many of the most demanding areas of the world, the R2 design is the compressor of choice by contractors and homeowners in these challenging climates. For the high performance that homeowners demand, R2 Rotary Compressors are the best air conditioning engines for today's residential cooling solutions.

Leading Technology

Used in over 80% of cooling solutions globally, rotary is the world's dominant residential air conditioning compression technology. Panasonic is the leading rotary and residential AC compressor manufacturer in the world, with over 200 million compressors produced.

Benefits

Central air conditioning delivered with a Panasonic R2 Rotary Compressor ensures a superior level of comfort at an economical cost.



Vane - Long Life

The special Physical Vapor Deposition (PVD) coating applied to the Vane greatly enhances the durability and life of the compressor mechanism.

Piston - Durable

The piston is made of unique high-grade steel that prevents wear and extends operation life.

FAQ

How does a Panasonic Rotary compressor work?

R2 compressors are rolling piston rotary compressors. The heart of the rotary compressor is the cylinder which houses the piston and the vane. The vane maintains constant contact with the piston as the piston rolls along the inside wall of the cylinder. As the piston rotates, gas is compressed into an increasingly smaller area until the discharge pressure is reached, releasing gas into the shell chamber. At the same time, more gas comes in through the suction port, enabling a continuous process of suction and discharge. The simple design and symmetry of the cylinder components, combined with a special coating and premium materials, provide a highly durable and reliable product, rotation after rotation.

What SEER range does the Panasonic Rotary compressor support?

R2 compressors are found in air conditioning products featuring the very latest technology and offering the highest efficiency on the market today. Our R2 compressors are engineered specifically for this SEER efficiency requirement. Combined with the inherently simple design of the rotary, this results in a high desirable and impressively economical solution.

What makes Panasonic Rotary compressor so reliable?

Changes to the construction and material of internal components enables the R2 compressor to reliably operate with an above average maximum discharge

pressure. A Physical Vapor Deposition (PVD) coating on the vane, along with enhanced steel materials, significantly reduces wear and increases durability.

What makes a Panasonic Rotary compressor so quiet?

The structure of the R2 compressor mechanism has been redesigned to increase stability and reduce vibration. Specifically, the compressor has an upper cylinder discharge, an enhanced fixed upper bearing, and reduced friction in the cylinder parts. The lower discharge and muffler in the dual piston compressors also enables lower noise levels. As a result, this new design optimises efficiency and minimises noise.

How do R2 rotary compressors compare to scroll and reciprocating compressors?

R2 rotary compressors are very similar to some scroll compressors in overall performance, including efficiency and reliability. The simple and symmetrical key components contribute to the R2 compressor's reliability, light weight, compact size, and economical applied cost, without sacrificing the key performance requirements of high efficiency and low noise levels.

Which refrigerants can be used with Panasonic Rotary compressor?

Panasonic has R2 Rotary Compressors available for R410A applications.



Intelligent Sensors
ECONAVI

Up to **38%**
energy savings
(cooling)

ECONAVI



Econavi Intelligent Sensors

Discover how to achieve energy savings

When you are relaxing while watching television, the air conditioner's operation usually runs at a constant temperature setting.

Econavi detects and reduces this waste in all the right ways

Using high-tech sensors and precise control programs, it analyses room conditions and adjusts cooling power accordingly.

Econavi is smart enough to locate and operate in all the right places to give you better energy savings.

So much saved with so little effort

Up to 38%* energy savings for Inverter cooling model with temperature wave

ECONAVI ON, Outside temperature: 35 °C/24 °C

Remote setting temperature: 23 °C with Fan Speed (High)

Vertical Airflow direction: Auto, Horizontal Airflow direction: ECONAVI Mode

Setting temperature goes up 2 °C in total, 1 °C controlled by ECONAVI activity level detection and another 1 °C controlled by ECONAVI light intensity detection.

Temperature Wave is ON, electric heater (300W; simulating the heat of human and TV etc)

ECONAVI OFF, Outside temperature: 35 °C/24 °C

Remote setting temperature: 23 °C with Fan Speed (High)

Vertical Airflow direction: Auto, Horizontal Airflow direction: Front

Total power consumption amount are measured for 2 hours in stable condition. At Panasonic Amenity Room (size:16,6m²). This is the maximum energy savings value, and the effect differs according to conditions in installation and usage.

* Comparison of 1,5HP Inverter model between ECONAVI with (Dual Human Activity Sensor, Sunlight Sensor, and Temperature Wave) ON and ECONAVI OFF (Cooling)

5 Features saving energy all at once: Econavi with intelligent eco sensors

Intelligent Sensors detect potential waste of energy using the Human Activity Sensor and Sunlight Sensor. It is able to monitor human location, movements, absence and sunlight intensity. It then automatically adjusts cooling power to save energy efficiently with uninterrupted heating and cooling comfort and convenience.



Temperature Wave
Rhythmic temperature-controlled pattern to save energy without sacrificing comfort.

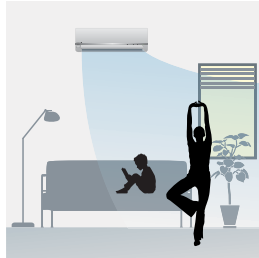

Area Search
Directs airflow to wherever you are in the room. Econavi detects changes in human movements and reduces the waste of cooling the unoccupied area of the room.

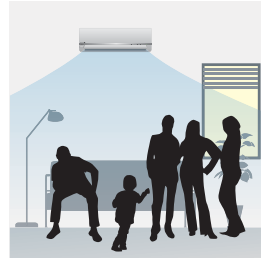

Activity Detection
Adapts cooling power to your daily activities. Econavi detects changes in activity levels and reduces the waste of cooling with unnecessary power.



Absence Detection
Reduces cooling power when you are not around. Econavi detects human absence in the room and reduces the waste of cooling an empty room.

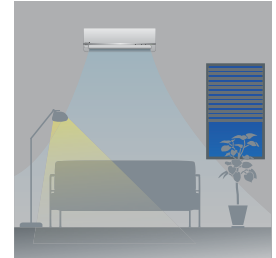

Sunlight Detection
Adjusts cooling power to changes in sunlight intensity.

Econavi sunlight sensor

Sunlight Detection (on Cooling Mode)

Econavi detects changes in sunlight intensity in the room and judges whether it is sunny or cloudy/night. It reduces waste energy by reducing cooling under less sunny conditions. When weather changes from sunny to cloudy/night, Econavi detects less sunlight intensity and determines less cooling power is required. If cooling power remains the same, energy will be wasted. Econavi detects this waste and reduces cooling power by an amount equivalent to increasing the set temperature by 1 °C.

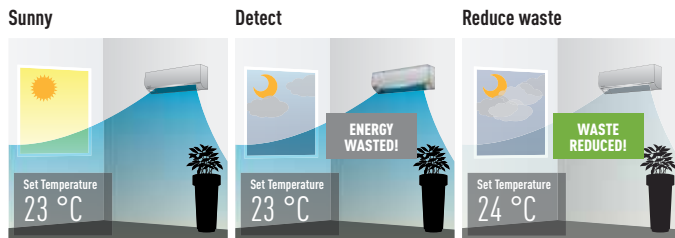

Econavi is switched on when it is sunny. Econavi detects less cooling power is required. Reduces cooling power by an amount equivalent to increasing the set temperature by 1 °C.

Sunlight Detection (on Heating Mode)

Econavi detects changes in sunlight intensity in the room and judges whether it is sunny or cloudy/night. It reduces heating operation (wasted energy) under more sunnier conditions. When weather changes from cloudy/night to sunny, Econavi detects more sunlight intensity and determines less heating power is required. If heating power remains the same, energy will be wasted. Econavi detects this waste and reduces heating power by an amount equivalent to decreasing the set temperature by 1 °C.

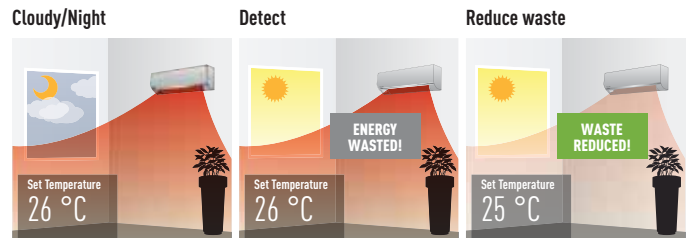

Econavi is switched on when it is cloudy/night. Econavi detects less heating power is required. Reduces heating power by an amount equivalent to decreasing the set temperature by 1 °C.

Temperature wave

Rhythmic temperature-controlled pattern to save energy without sacrificing comfort.

Econavi with Temperature Wave was developed based on an understanding of Thermal Physiology; the human body adapts physiologically to changes in temperature. Taking advantage of this understanding, Panasonic's R&D Centre has developed the Rhythmic Temperature Control pattern, which offsets the air conditioner's performance against thermal physiological responses.

Hence, when Econavi detects human presence and low activity level, Temperature Wave adapts to this rhythmic temperature control to realise further energy savings without sacrificing comfort.

How does temperature wave works?

When Econavi detects low activity

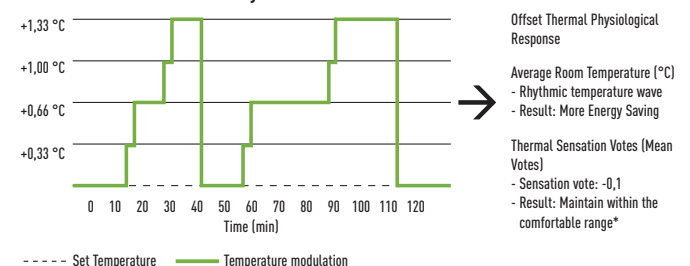

The result of the experiment showed that thermal sensation was maintained within the comfortable range* even though average set temperature was moderately increased. Hence, when ECONAVI detects human presence and low activity level, Temperature Wave adapts to this rhythmic temperature control to realise further energy saving without sacrificing comfort.

* The thermal condition of which PMV (Predicted Mean Value) is within -0.5 to +0.5 is recommended as comfortable condition (in the condition B) by International Standard EN ISO 7730.

Econavi Intelligent Sensors

Econavi Intelligent Sensors are able to monitor sunlight intensity, human movements, activity levels and human absence to detect unconscious waste of energy and automatically adjusts cooling power to save energy efficiently whilst still providing uninterrupted cooling comfort and convenience.

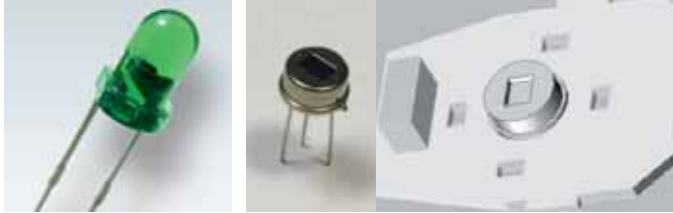

Sunlight Sensor
Detects changes in Sunlight Intensity

Human Activity Sensor
Detects human movements, changes in activity levels and human absence.

High-precision sensing

All objects emit infrared rays which, although invisible, can be detected as heat by Econavi's Human Activity Sensor if it is within the detection zone. When an object moves within its detection zone, Econavi compares the object's temperature with the room temperature to determine if it is human, and level of activity based on its movement.

Detecting Human Presence



Difference in temperatures	<input type="checkbox"/>	Difference in temperatures	<input checked="" type="checkbox"/>	Difference in temperatures	<input checked="" type="checkbox"/>
Movement	<input type="checkbox"/>	Movement	<input type="checkbox"/>	Movement	<input checked="" type="checkbox"/>

When there is no movement for over 20 min.



Determining the Level of Human Activity

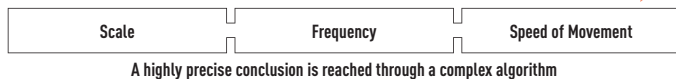

Sensor detection principle

Human Activity Sensor detects human activity level and directs airflow to occupied or high activity zone.

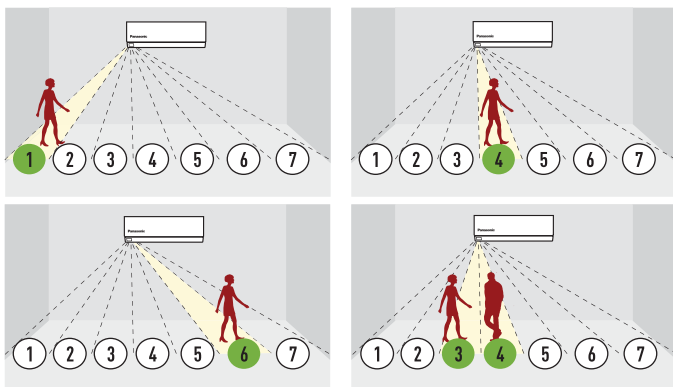

Differentiating objects

Econavi's sensor technology uses factors such as speed, frequency and temperature of every object to determine if it is human.

Electrical products Difference in temperatures <input checked="" type="checkbox"/> + Movement <input type="checkbox"/> ↓ Concludes it is not human	A rolling ball Difference in temperatures <input type="checkbox"/> + Movement <input checked="" type="checkbox"/> ↓ Concludes it is not human
Small insects Difference in temperatures <input type="checkbox"/> + Movement <input checked="" type="checkbox"/> ↓ Concludes it is not human	Pets Difference in temperatures <input checked="" type="checkbox"/> + Movement <input checked="" type="checkbox"/> ↓ Concludes it is not human

Both changes may be detected, but they are too small to have any effect on the sensor.

From the difference in temperatures and the nature of the object's movement, Econavi can determine if it's human*.
* The sensor may deem pets as humans, unless it moves within the detection zone at speeds that are not humanly possible.

Coverage capabilities

Human Activity Sensor covers a wider area due to its improved area detection function. The entire room is divided into 7 detection areas.

Horizontal sensing area

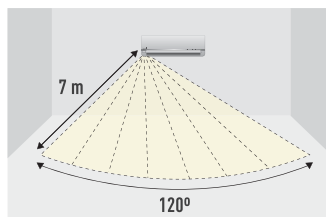

Vertical sensing area

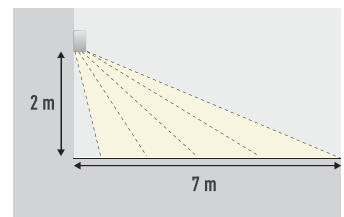

Autocomfort sensor provides comfort

Autocomfort sensor is used to provide comfort. High Activity Detection detects when the level of activity increases, and automatically increases cooling power by an amount equivalent to decreasing the set temperature by 1 °C to improve comfort.

This is explained in the following scenario: High Activity Detection: Econavi High Activity Detection can detect changes in activity levels to adjust cooling power to improve comfort.

Detect Level of activity increased. Detects high activity.	Improve comfort Increases cooling power by an amount equivalent to decreasing the set temperature by 1 °C.
--	--

Inverter technology

The secret is flexibility

Panasonic Inverter air conditioners have the flexibility to vary the rotation speed of the compressor. This allows it to use less energy to maintain the set temperature while also being able to cool the room quicker at start up. So you can enjoy better savings on your electricity bills while maintaining cooling comfort

The advantages of inverter heat pumps. Comparing Inverter and non-Inverter heat pumps.

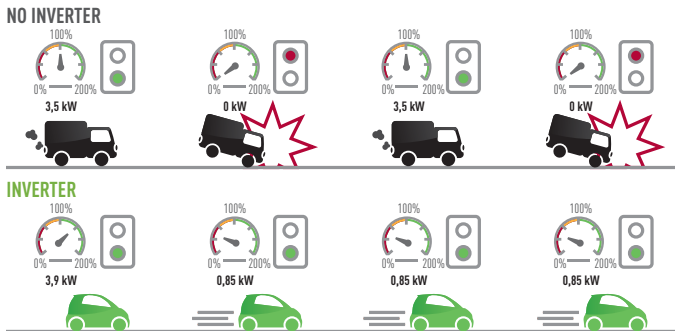

NO INVERTER Slow to start. Takes longer to reach the temperature set point. The temperature oscillates between the two extremes and never stabilises. The temperature falls and then rises quickly, leading to a consumption peak.
INVERTER Rapidly reaches the desired temperature. Adjusts the temperature: more comfort and greater savings. Keeps the temperature comfortable all the time.

Constant Comfort

Precise temperature control with a wide power output range enables an inverter air conditioner to meet different room occupancy levels – thus ensuring constant comfort.

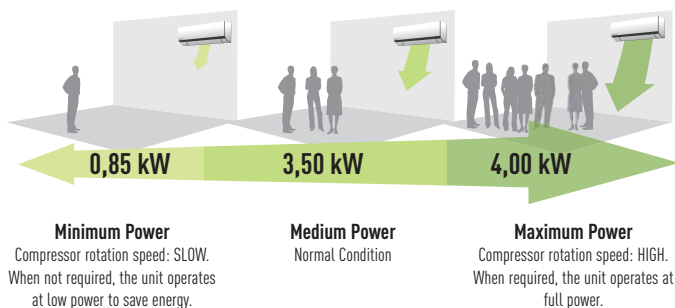

Minimum Power
Compressor rotation speed: SLOW.
When not required, the unit operates at low power to save energy.

Medium Power
Normal Condition

Maximum Power
Compressor rotation speed: HIGH.
When required, the unit operates at full power.

Graph shows the 1,5HP Inverter model's wide power output range during cooling. / Graph shows the 1,5HP Inverter model's wide power output range during heating.

Silent air
20 dB(A)

SUPER QUIET

Extremely quiet

We have succeeded in making one of the most silent air conditioners on the market. Panasonic Inverter air conditioner's indoor operating noise has been reduced by 3dB as the Inverter constantly varies its output power to enable more precise temperature control. In comparison, a non-Inverter air conditioner controls the temperature by switching on and off. Each time the air conditioner is switched on, it draws more energy to cool the room subsequently leading to more vibration and higher noise levels.

Exceptional energy-saving performance. Reduces electricity consumption

Panasonic Inverter air conditioners are designed to give you exceptional energy savings and performance. At the start up of an air conditioner's operation, a boost in power is required to reach the set temperature. After the set temperature is reached, less power is required to maintain it. The Panasonic Inverter air conditioner varies the rotation speed of the compressor. This provides a highly precise method of maintaining the set temperature.

Quick Comfort

Panasonic Inverter air conditioners can operate with higher power during the start up period to cool the room 1,5 times faster and heat the room 4 times faster than non-Inverter models.

Comparison of Cooling Speed

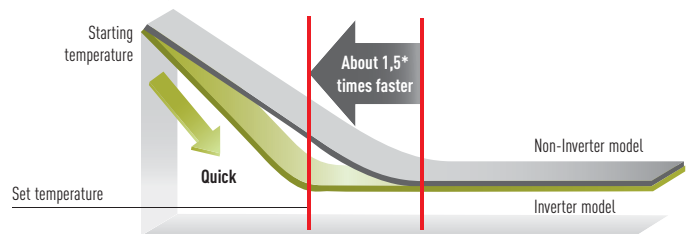

* 1.5HP Inverter vs. non-Inverter. Outside room temperature: 35°C; setting temperature: 25°C

Comparison of Heating Speed

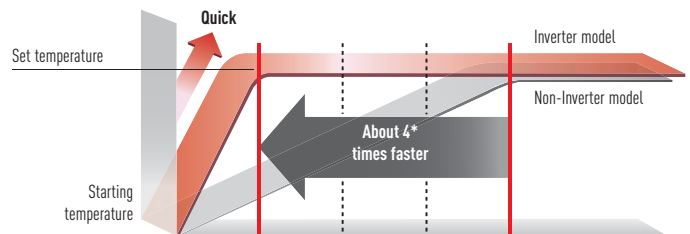

* Comparison of 1.0HP Inverter and Non-Inverter. Outside room temperature: 2°C; Setting temperature: 25°C

Perfect
humidity
control

MILD DRY

Mild Dry Cooling

Mild dry cooling maintains a higher level of relative humidity of up to 10% compared to regular cooling operation. This helps to reduce skin dryness - and a dry throat.

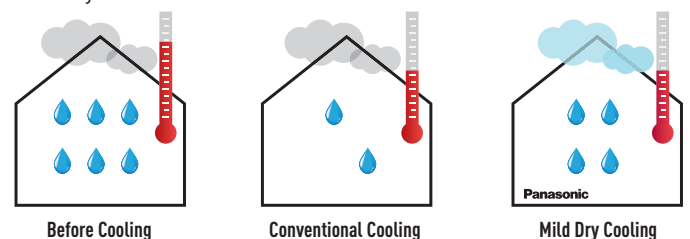

Lowers room temperature while maintaining high humidity.

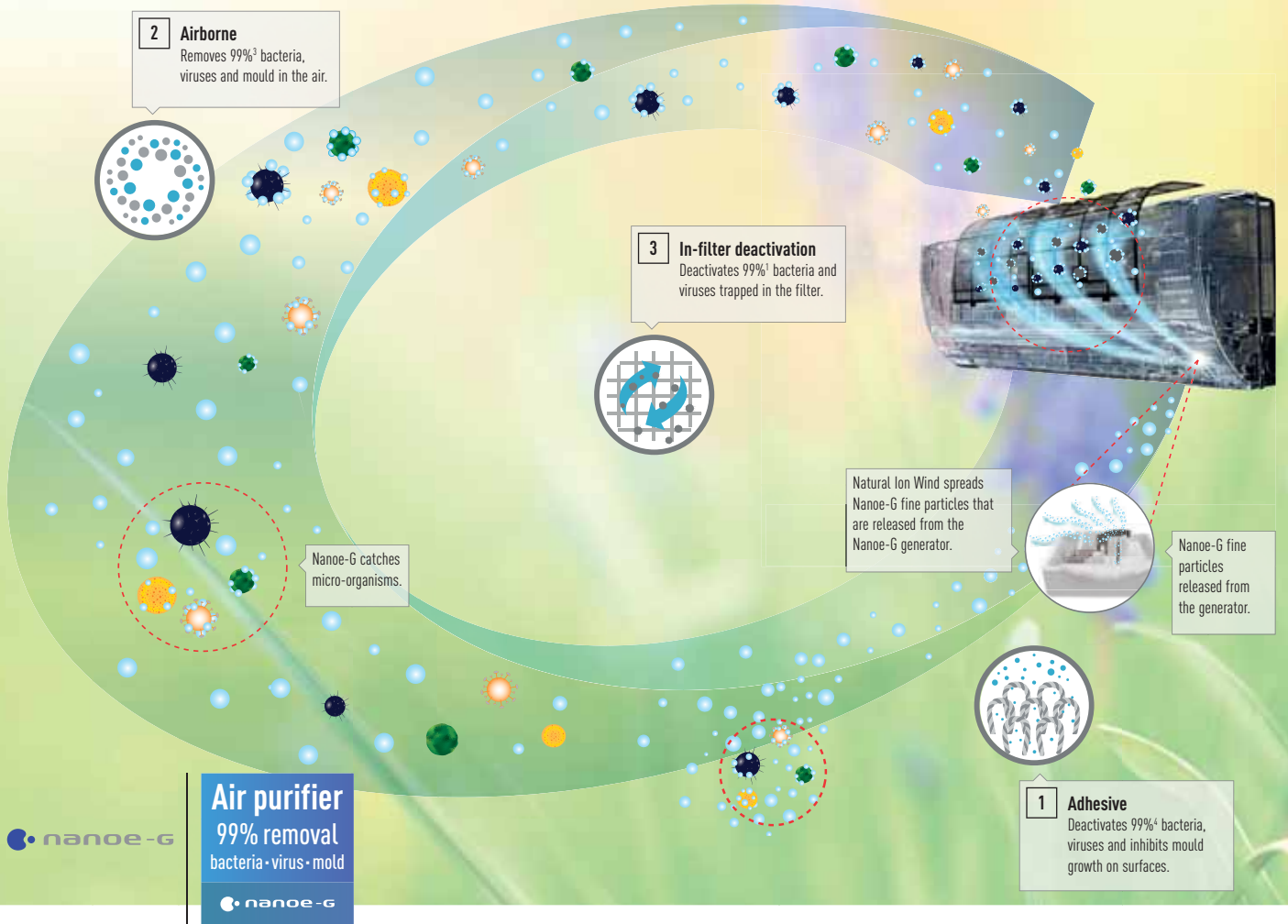

Nano-e-G Air Purification System

Purifies the air, surfaces and even inside itself

Now you can purify living spaces more effectively with Nano-e-G. Using nano-technology fine particles, harmful micro-organisms are removed from the air you breathe. But what about the ones found on furniture and other surfaces? Amazingly, they can also be deactivated by these particles. And now, when you switch off your air conditioner, Nano-e-G will even deactivate the micro-organisms in the filter. So you can enjoy complete peace-of-mind with a living environment that is fresher and cleaner.

Nano-e-G with in-filter deactivation. Advanced air purification system for your home

Panasonic introduces an air purification system that captures harmful micro-organisms from the air, deactivates those trapped on surfaces and in the filter as well. It utilises nano-technology fine particles to purify the air and clean harmful micro-organisms attached onto fabrics in the room. And this year, it comes with a brand new feature that deactivates bacteria and viruses trapped in the filter. Thus, giving you the complete air purification system so you come home to a cleaner living environment.

Nano-e-G has been comprehensively tested in real-life chamber and demonstrated it is also effective against Allergy airborne particles. Due to this, Nano-e-G get the Seal of Approval of the British Allergy Foundation.

	1 Adhesive	2 Airborne	3 In-filter deactivation
Bacteria 	99% Deactivation	99% Removal	99% Deactivation
Viruses 	99% Deactivation	99% Removal	99% Deactivation
Mould 	Growth Inhibition	99% Removal	—
Pollen Allergen 	—	76,6% Removal in 1 hour	—



Airborne

Data on removal of airborne bacteria was presented by HARVARD SCHOOL of Public Health researchers at Nano-Symposium at Kyoto University, 2012

In a large space of 40 m³ / Removal effect has been evaluated.

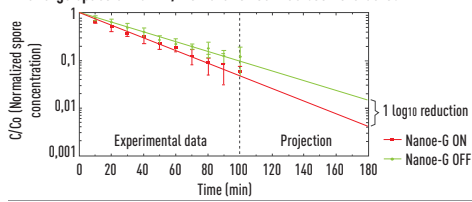

The effect after 100 minutes in a 40 m³ test space [about the size of a 10 tatami mat room], not the effect in a space where actually used.

"Performance evaluation of a novel ionizer for air purification applications". Dr. S. Rudnick et al. Harvard School of Public Health, Environmental Health Nanoscience Lab. A study of the removal effect of airborne bacteria by using an air-conditioner incorporating Nano-e-G was carried out in a large space, and the results were presented at Nano-Symposium jointly held in September 2012 by Harvard University and Kyoto University.

Test methods: Bacteria removal method: Release of Nano-e-G ions. Target: Airborne bacteria, Test results: It is estimated that after three hours of operation the Nano-e-G will achieve 2.7 log₁₀ reductions, ~ 1 log₁₀ reduction more, as compared to without Nano-e-G.

How does our in-filter deactivation work?

1. Power "Off"



The air-conditioner first has to be turned off.
Remark: Main power must be switched on for the entire duration.

2. Fan Operation



The fan operation will run automatically for 30 minutes with the louvre slightly open to ensure the internal components are dry and free from condensation.
Remark: The 30-minute fan operation is only applicable when the unit has been operated in COOL / DRY mode.

3. Nano-e-G Operation



Natural Ion Wind spreads Nano-e-G particles that are released from the Nano-e-G generator.

4. Deactivation Effect

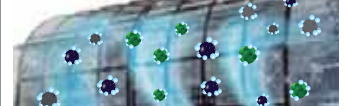

Nano-e-G deactivates bacteria and viruses that are trapped in the filter within 2 hours.

Fan Operation: On // Louvre: Low Louver Angle // Nano-e-G LED: On	Fan Operation: Off // Louvre: Closed // Nano-e-G LED: On	Fan Operation: Off // Louvre: Closed // Nano-e-G LED: On
---	--	--

Remark: Depending on the Air Conditioner's accumulated operation time, Nano-e-G In-Filter Deactivation may be activated only once a day.

The effectiveness of Nano-e-G

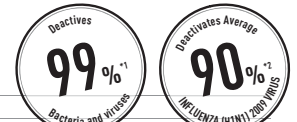

In-filter deactivation

Target	Substance Name	Effectiveness	Testing Institute	Test Report no	Method	Result
Bacteria	Bacteria Staphylococcus aureus (NBRC 12732)	99%	Japan Food Research Laboratories	Test Report No. 12037932001	The test piece impregnated with Staphylococcus aureus was placed on the filter of the Air Conditioner indoor unit, and then Nano-e-G was operated. After the test piece was collected, viable cells were counted.	99% deactivated after 2-hour Nano-e-G operation.
Virus	Escherichia coli phage (φX-174 ATCC 13706-B1)	99%	Japan Food Research Laboratories	Test Report No. 12014705001	The test piece impregnated with Escherichia coli phage was placed on the filter of the Air Conditioner indoor unit, and then Nano-e-G was operated. After the test piece was collected, phage infectivity titer was determined.	99% deactivated after 2-hour Nano-e-G operation.
	Influenza (H1N1) 2009 virus	Average 90% on filter (The percentage varies from 78.9% to 96.1% depending on its location)	Kitasato Research Center for Environmental Science	KRCES-Virus Test Report No. 24_0013	The test piece impregnated with Influenza (H1N1) 2009 virus was placed on the filter of the Air Conditioner indoor unit, and then Nano-e-G was operated. After the test piece was collected, virus infectivity titer was determined.	Average 90% deactivation after 2-hour Nano-e-G operation. (The percentage varies from 78.9% to 96.1%, depending on its location on filter)

Remark: All results are based on specific testing conditions. All tests are not demonstrated under actual usage situation. * Test substance was placed on the 4 locations of the filter; upper/lower right and upper/lower left.

1) In-filter deactivation was certified by Japan Food Research Laboratories - Test Report number : 12037932001 Bacteria : Staphylococcus aureus (NBRC 12732) - Test Report number : 12014705001 Virus : Escherichia coli phage (-174 ATCC 13706-B1).

2) In-filter deactivation was certified by Kitasato Research Center for Environmental Science - Test Report number : KRCES-Virus Test Report No. 24_0013 Virus : Influenza (H1N1) 2009 Virus.



Airborne. Testing institute: Kitasato research center for environmental science

Target	Substance Name	Effectiveness	Test Report no	Method	Result
Bacteria	Staphylococcus aureus (NBRC 12732)	99%	KRCES-Bio. Test Report No. 23_0182	The AC with Nano-e-G was operated in a test room (25m ³) and aerosol was collected and bacterial count was calculated.	99% removal from the air after 150 minutes of operation.
Virus	Escherichia coli phage (φX-174 ATCC 13706-B1)	99%	KRCES-Env. Test Report No. 22_0008	The AC with Nano-e-G was operated in a test room (25m ³) and airborne phages were collected and phage count of the collected air was calculated.	99% removal from the air after 120 minutes of operation.
		99%	KRCES-Env. Test Report No. 22_0008	Nano-e-G was operated in a test chamber (200 Litre) and the phages were collected and phage count of the collected air was calculated.	99% removal from the air after 5 minutes of operation.
		99%	KRCES-Env. Test Report No. 22_0008	Nano-e-G was operated in a test chamber (200 Litre) and the influenza viruses were collected and the virus titers were calculated by the Reed and Muench method.	99% removal from the air after 5 minutes of operation.
	Penicillium pinophilum (NBRC 6345)	99%	KRCES-Bio. Test Report No. 23_0140	In view of health hazard associated with spatial distribution of Influenza (H1N1) 2009 virus, Nano-e-G removal effectiveness cannot be tested in large test room (25m ³). When tested in 200 l chamber, Nano-e-G was able to decrease Influenza (H1N1) 2009 virus (99%) when it was operated for 5 min. Additionally when tested in larger test room (25m ³), Nano-e-G can remove 99.5% of Coli phage virus when operated for 120 min. It was validated that evaluation on the influenza virus could be speculated from the results on the phage according to the test results in a 200 l test chamber. It appeared that the air-conditioners in a larger test room (25m ³) would be able to remove the influenza virus as effectively as the phage.	99% removal from the air after 90 minutes of operation.
Mould	Penicillium pinophilum (NBRC 6345)	99%	KRCES-Bio. Test Report No. 23_0140	The AC with Nano-e-G was operated in a test room (25m ³) and aerosol was collected and fungal spores count was calculated.	99% removal from the air after 90 minutes of operation.

Remark: All results are based on specific testing conditions. All tests are not demonstrated under actual usage situation.

3) Airborne Removal was certified by Kitasato Research Center for Environmental Science - KRCES-Bio. Test Report no.: 23_0182 Bacteria: Staphylococcus aureus (NBRC 12732)

- KRCES-Env. Test Report no.: 22_0008 Virus: Escherichia coli phage (φX-174 ATCC 13706-B1); Influenza (H1N1) 2009 virus - KRCES-Env. Test Report no.: 23_0140 Mould: Penicillium pinophilum (NBRC 6345).



Adhesive. Testing institute: Japan food research laboratories

Target	Substance Name	Effectiveness	Test Report no	Method	Result
Bacteria	Staphylococcus aureus (NBRC 12732)	99%	Test Report No. 11047933001-02	The AC with Nano-e-G was operated in a test space (10m ³) and viable cells were counted by pour plate method	99% deactivation after 24 hour operation of Nano-e-G (compared to the original condition/ ventilation mode).
Virus	Bacteriophage (Phi X 174 NBRC103405)	99%	Test Report No. 11073649001-02	Nano-e-G was operated in a test box (90 l) and phage infectivity titer was determined by plaque technique.	99% deactivation after 120 minutes operation of Nano-e-G (compared to non-operation).
Mould	Cladosporium cladosporioides (NBRC 6348)	Inhibit Mould Growth	Test Report No. 11047937001-02	Nano-e-G was operated in a test box (1m ³) and colonies on the plate were counted.	The growth of the subject was inhibited (>85% after 7 days).

All results are based on specific testing conditions. All tests are not demonstrated under actual usage situation.

4) Adhesive Deactivation was certified by Japan Food Research Laboratories - Test Report number: 11047933001-02 Bacteria: Staphylococcus aureus (NBRC 12732) - Test Report number: 11073649001-02 Virus: Bacteriophage (Phi X 174 NBRC 103405) - Test Report number: 11047937001-02 Mould: Cladosporium cladosporioides (NBRC 6348)



heatcharge

Heatcharge. Energy Charge System

Heating power and efficiency

- Energy Charge System. Heat storage unit which features Non-Stop heating and fast heating function
- Maximum efficiency and comfort with Econavi sunlight detection and human activity detection
- Nanoe-G air purifying system
- More powerful airflow to quickly reach the desired temperature

Panasonic's new full line-up of A+++ heat pumps

In response to the Kyoto Protocol, the European Union set some challenging targets for the reduction in greenhouse-gas emissions. By the year 2020, across the member states, the EU wants to have achieved the following objectives:

- A 20% cut in greenhouse gas emissions (from 1990 base levels)
- The share of renewables in the energy mix to increase by 20%
- An overall reduction of 20% in energy consumption

Intelligent microprocessor



DC Inverter

Powerful, reliable heating even at low ambient winter temperatures

When the air conditioner is operating, the compressor, which is the power source of the unit, generates heat. Until now, this heat was released into the atmosphere. Panasonic focused on this waste heat! Heatcharge is a unique, innovative Panasonic technology that stores this waste heat in the compressor and effectively uses it as heating energy. This lets you enjoy a new level of air conditioner heating power and efficiency.



Constant heating

Using stored heat provides stable heating with less drop in temperature.

Even when heating operation stops during defrost operation, stored heat continues to constantly warm the room. This eliminates the previous discomfort due to the temperature dropping when heating temporarily stops to ensure stable air conditioner heating.

Constant heating

HEATCHARGE



You can check the charge level with the remote control. Press the Information button and the level is displayed in five stages (from 0 to 4).

Conventional: The room gradually becomes cold

Defrost operation: About 11 to 15 min.
Fall in room temperature: About 5 to 6 °C

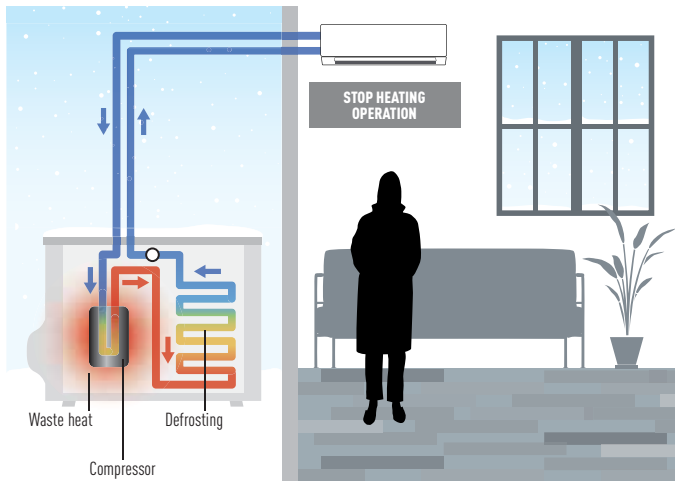

Heatcharge: The room is thoroughly warmed

Defrost operation: About 5 to 6 min.
Fall in room temperature: About 1 to 2 °C

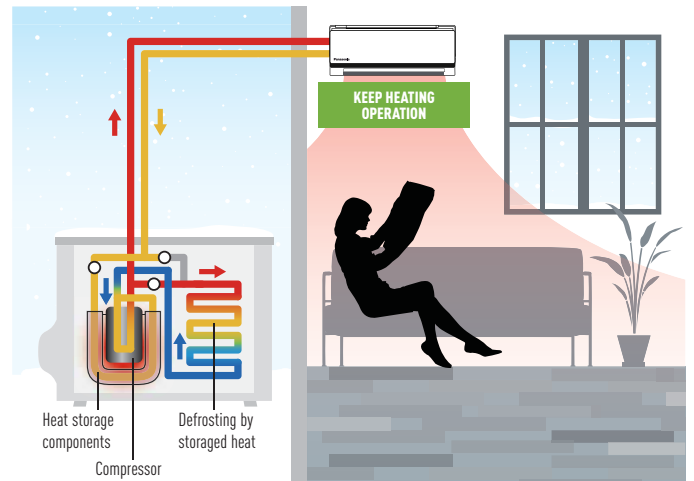

* Defrost operation time and how low room temperature falls differ depending on the environment in which the unit is being used (how insulated and airtight and room is), operation conditions, and temperature conditions.

* Output air temperature falls during defrost operation. How low room temperature falls differs depending on the environment in which the unit is being used (how insulated and airtight and room is), operation conditions, and temperature conditions.

* In environments where a lot of frost accumulates, heating may stop during defrost operation.

Conventional

During operation, heat is generated inside the compressor.

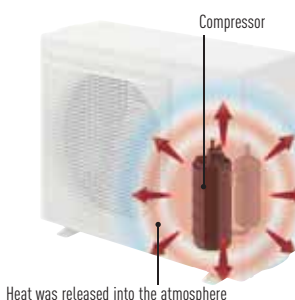

Heatcharge

Heat generated by the compressor is stored inside and used to warm the refrigerant to efficiently increase heating power.



Heatcharge unit

The compressor is wrapped exhaust heat is used for charging.

Heatcharge tank
Waste heat from the compressor is stored.

Finless heat exchanger
Stored heat is converted to energy.

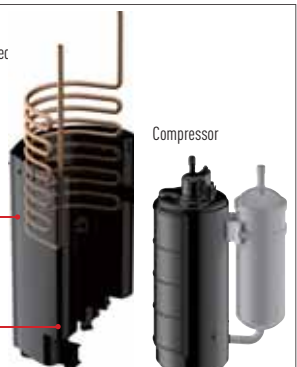



Change you old air conditioning system to a more efficient system!

Possible to use on R22 pipings
R22 RENEWAL

R22 Renewal

An important drive to further reduce the potential damage to our ozone

It is often said that legislation is ruling our lives but sometimes it is there to help save lives. R22 phase out can be described as one of these and from Jan 1st 2010 the use of Virgin (new) R22 refrigerant was banned within the European Community.

- All Panasonic standard NKE, PKE and QKE units can be install on existing R22 pipings
- No need of additional accessories (only pipe reduces)
- Approximately 30% energy saving compare to R22 units





Panasonic are doing our part

We at Panasonic are also doing our part – recognising that all finances are under pressure at the moment. Panasonic has developed a clean and cost effective solution to enable this latest legislation to be introduced with as minimum an effect on businesses and cash reserves as possible. The Panasonic renewal system allows good quality existing R22 pipe work to be re-used whilst installing new high efficiency R410A systems. By bringing a simple solution to the problem Panasonic can renew all Split Systems and PACi systems; and depending upon certain restrictions we don't even limit the manufacturer's equipment we are replacing. By installing a new high efficiency Panasonic R410A system you can benefit from around 30% running cost saving compared to the R22 system.

Yes...

1. Check the capacity of the system you wish to replace
 2. Select from the Panasonic range the best system to replace it with
 3. Follow the procedure detailed in the brochure and technical data
- Simple...

R22 - The reduction of Chlorine critical for a cleaner future

Guidance on re-using of existing R22 piping for a new R410A installation

1. Precaution

The existing R22 piping can be re-used for a R410A system installation if the following conditions are met and the piping are finally verified to be:

- Dry (no moisture remained in the piping)
- Clean (no dust remained in the piping)
- Tight (no refrigerant leak at the joining and piping)

2. Conditions

- Recover the refrigerant and oil.

Operate "force cooling" according to the recommended operation time, regardless of the piping length.

Single split: 10min.

Multi split: 30min.

After that, carry out "pump down" to recover the refrigerant and oil from the existing R22 system

* Note: If pump down operation is not possible due to the malfunction of the system, flush and wash the existing piping to collect back the oil and dirt inside the system.

- Check the oil condition.

If the oil contains dirt, wash the existing pipes

- Check the oil color.

After pump down, use a cotton bud to wipe the oil from the existing pipe.

If the oil color is higher than ASTM3, use a new pipe as re-use of old piping is not allowed

Deterioration Criteria for Refrigerant Oil

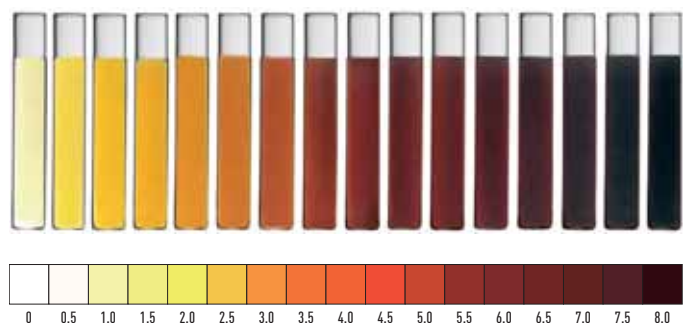

- Check pipe thickness.

Make sure that the pipe thickness is more than 0,8mm.

If the thickness is less than 0,8mm, use a new pipe

- Rework the flare for R410A connection.

Do not reuse the old flare nuts.

Make sure to use the new flare nuts attached to the R410a system

*Note: If the existing piping size is 1/4" (6.35mm) and 1/2" (12.7mm), and the new R410a system is 1/4" and 3/8" (9.52mm), use a pipe reducer connected at indoor and outdoor unit.

3. Applicable Model

Panasonic single split room air conditioner from CS/CU-RE/UE/VE/XE/CE/NE/E*NKE and PKE series onwards.

Panasonic multi split room air conditioner from CU-2E/3E/4E/5PBE series onwards.

Control & Connectivity

Aware of the importance of both control and connectivity in offering the best comfort at the lowest price, Panasonic offers its customers cutting-edge technology, specially designed to ensure our air conditioning systems deliver maximum performance. You can properly manage the air conditioning and perform comprehensive monitoring and control, with all of the features the remote control provides at home, from anywhere in the world thanks to the internet applications Panasonic has created for you.



Internet Control

Control your air conditioning from wherever you are. Control your comfort and efficiency with the lowest energy consumption



What's Internet Control?

Internet Control is a next generation system providing user-friendly remote control of air conditioning or heat pump units, using a simple Android or iOS smartphone, tablet or PC via internet.

Simple Installation

Just connect the Internet Control device to the air conditioner or heat pump with the supplied wire and then link it to your WIFI Access point.

Internet Control. Easy to install. Maximum benefit

Internet Control is underlined with the slogan "Your home in the cloud", meaning a simple and easy to handle solution has been considered for every user to manage the device, not requiring any communication or computer skills.

No servers. No adaptors. No wires. Just a small box is needed to be connected and placed close to the air conditioning indoor unit... and your smartphone, tablet or PC.

Your existing WiFi connection does the rest when you are at home. Start the App from your smartphone device, your tablet or your computer, and enjoy a new experience in comfort. And if you are out of home, just launch the App, and manage the air conditioning of your home from the cloud. An intuitive and user-friendly application on the screen of your smartphone or PC that lets you manage the air conditioning unit in the same way you do with the remote controller at home.

Internet Control can be downloaded in Apple's AppStore and Android's PlayStore.

Control your air conditioning with the smart internet control device via smartphones, tablet, PC and smart desktop phone via internet

Offering the same functions as if you were at home or office: start/stop, Mode Operation, Set Temperature, Room Temperature etc as well as the new, advanced functionality provided by Internet Control to achieve the best comfort and efficiency with the lowest energy consumption.

Take control from wherever you are!

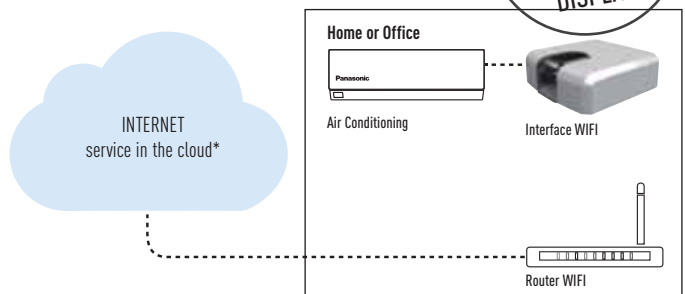

WITH ETHEREA QKE: ENERGY CONSUMPTION DISPLAY

* Functionalities depend on the license. The information indicated above is subject to changes and updates.

Reference: PA-AC-WIFI-1 For Ethera and Heatcharge, with full communication
Reference: PAW-IR-WIFI-1 by Infra red sensor, only ON/OFF and temperature setting



Study Case. James, architect

"As an architect, I'm proud of my home. Unfortunately, the pace of my life revolves around airports on all five continents. Because of this, whenever I get the chance to enjoy even just a few days at home, I programme my Panasonic Multi Split System to my tablet and from wherever I happen to be, I can enjoy the comforts that the system gives me from the minute I arrive home."

IntesisHome



Reference: PAW-IR-WIFI-1

IntesisHome IS-IR-WIFI-1 device is an easy to install and small device which allows connectivity with the IntesisHome application and connects with your climate system using Infrared (IR). The device enables the control of the Panasonic RAC units without CN-CNT connector (RE, UE, GFE and Free Multi lines).
Specific features: • ON/OFF, mode, set point, fan speed, vanes and room temperature • Easy installation (no special electrical work needed) • Feedback to the IntesisHome system when changes are made from the infrared remote controller.
General IntesisHome features: • Calendar scheduler • Scenes • Control from anywhere • Several languages

Easy control by BMS
CONNECTIVITY



Connectivity. Control by BMS

Great flexibility for integration into your IntesisHome, KNX, EnOcean, Modbus and BacNet projects allows fully bi-directional monitoring and control of all the functioning parameters



Reference: PAW-AC-KNX-1i

This new KNX interface allows full bi-directional monitoring and control of all the functioning parameters of the air conditioner control from KNX installations. Small dimensions.

- Quick installation and possibility of hidden installation
- External power not required
- Direct connection to the AC indoor unit (split unit or Multi split unit)
- Fully KNX compatible. Control and monitoring, from sensors or gateways, of the internal variables of the indoor unit and error codes and indication
- Use the air conditioner ambient temperature or the one measured by a KNX temperature sensor or Thermostat
- AC unit can be controlled simultaneously by the remote control of the AC unit and by KNX devices
- Advanced control functions: use it as a room controller
- 4 binary inputs. They work as standard KNX binary inputs as well as being used to control the AC directly

Modbus®

Reference: PAW-AC-MBS-1

This new Modbus interface allows full bi-directional monitoring and control of all the functioning parameters of the air conditioner control from Modbus installations. Small dimensions.

- Quick installation and possibility of hidden installation
- External power not required
- Direct connection to the AC indoor unit (split unit or Multi split unit)
- Fully Modbus compatible. Control and monitoring, from sensors or gateways, of the internal variables of the indoor unit and error codes and indication
- Use the air conditioner ambient temperature or the one measured by a Modbus temperature sensor or Thermostat
- AC unit can be controlled simultaneously by the remote control of the AC unit and by Modbus devices
- Advanced control functions: use it as a room controller
- 4 binary inputs. They work as standard Modbus binary inputs as well as being used to control the AC directly



EnOcean Switch



EnOcean RC



Keycard



Movement sensor

Reference: PAW-AC-ENO-1i

This new EnOcean interface allows monitoring and control, fully bi-directionally, all the functioning parameters of the air conditioner control from EnOcean installations. Small dimensions.

- Quick installation and possibility of hidden installation
- External power not required
- Direct connection to the AC indoor unit (split unit)
- Fully EnOcean compatible. Control and monitoring, from sensors or gateways, of the internal variables of the indoor unit and error codes and indication
- Use the air conditioner ambient temperature or the one measured by an EnOcean temperature sensor or Thermostat
- AC unit can be controlled simultaneously by the remote control of the AC unit and by EnOcean devices
- Advanced control functions: use it as a room controller
- 4 binary inputs. They work as standard EnOcean binary inputs as well as being used to control the AC directly



Reference: PAW-AC-BAC-1

This interface allows a complete and natural integration of Panasonic air conditioners into either BACnet IP or MS/TP networks.

- Quick installation and possibility of hidden installation
- External power not required
- Direct connection to the AC indoor unit
- Total Control and Supervision. Real states of the AC unit's internal variables
- Allows using simultaneously the IR and wired remote controls and BACnet.

Dry contact with additional PCB: PAW-AC-DIO
SIMPLE CONNECTION

Reference: PAW-AC-DIO







Dry contact ON/OFF Interface. Panasonic has developed for hotels applications a dry contact PCB which works with Ethera, RE, UE and YE indoor units in order to control simply the unit centrally.











- ON/OFF signal by 3rd party BMS
- PCB connected to CN-RMT port on Indoor Unit PCB

Model name	Interface	Model name	Interface
PA-AC-WIFI-1	Interface for IntesisHome for Ethera, Heatcharge and Flagship, with full communication	PAW-AC-BAC-1	Interface for BacNet (Ethera, 4-Way 60x60 cassette and Low static pressure hide away)
PAW-IR-WIFI-1	Interface for IntesisHome by Infra red sensor, only ON/OFF and temperature setting	PAW-AC-HEAT-1	Heating only PCB for Ethera, 4-Way 60x60 cassette and Low static pressure hide away
PAW-AC-ENO-1i	Interface for En-ocean (Ethera, 4-Way 60x60 cassette and Low static pressure hide away)	PAW-AC-DIO	PCB for wall mounted with dry contacts, On/Off, Error message (all OKE and RKE wall mounted)
PAW-AC-KNX-1i	Interface for KNX (Ethera, 4-Way 60x60 cassette and Low static pressure hide away)	PAW-SMSCONTROL	Control of the Ethera, Flagship and Heatcharge by SMS (need additional SIM card)
PAW-AC-MBS-1	Interface for Modbus (Ethera, 4-Way 60x60 cassette and Low static pressure hide away)		

Domestic Air Conditioner Range

1x1 and Multi Split Kits	2,2 kW	2,8 kW	3,2 kW	4,5 kW
Wall Mounted Etherea Inverter+ Silver	 KIT-XE7-QKE	 KIT-XE9-QKE	 KIT-XE12-QKE	
Wall Mounted Etherea Inverter+ White	 KIT-E7-QKE	 KIT-E9-QKE	 KIT-E12-QKE	 KIT-E15-QKE
Wall Mounted VE Inverter+ Energy Charge System		 KIT-VE9-NKE	 KIT-VE12-NKE	
Wall Mounted RE Type Standard Inverter	NEW	 KIT-RE9-RKE	 KIT-RE12-RKE	
Wall Mounted Professional Inverter -15 °C		 KIT-E9-PKEA	 KIT-E12-PKEA	 KIT-E15-PKEA
Floor Console Type Inverter+		 KIT-E9-PFE	 KIT-E12-PFE	
4-Way 60x60 Cassette Standard Inverter	NEW	 KIT-E9-PB4EA	 KIT-E12-PB4EA	
Low Static Pressure Hide Away Standard Inverter	NEW	 KIT-E9-PD3EA	 KIT-E12-QD3EA	

Free Multi	3,2 to 5,6 kW	3,2 to 6,4 kW	4,5 to 9,0 kW	4,5 to 11,0 kW	4,5 to 13,6 kW	4,5 to 17,5 kW
						
Outdoor Unit //Inverter+	CU-2E15PBE (2 rooms)	CU-2E18PBE (2 rooms)	CU-3E18PBE (3 rooms)	CU-4E23PBE (4 rooms)	CU-4E27PBE (4 rooms)	CU-5E34PBE (5 rooms)

5,0 kW	6,0 kW	6,5 kW	8,0 kW	10,0 kW
 <p>KIT-XE18-QKE</p>				
 <p>KIT-E18-QKE</p>	 <p>KIT-E21-QKE</p>	 <p>KIT-E24-QKE</p>	 <p>KIT-E28-QKE</p>	
 <p>KIT-RE18-RKE</p>		 <p>KIT-RE24-RKE</p>		
 <p>KIT-E18-PKEA</p>				
 <p>KIT-E18-PFE</p>				
 <p>KIT-E18-RB4EA</p>	 <p>KIT-E21-RB4EA</p>			
 <p>KIT-E18-RD3EA</p>				

Features Explained

Healthy Air Quality

Air purifier Nano-e-G
 99% removal of bacteria virus mold
 Nano-e-G utilises nano-technology fine particles to purify the air in the room. It works effectively on airborne and adhesive micro-organisms such as bacteria, viruses and mould thus ensuring a cleaner living environment. Seal of Approval of the British Allergy Foundation

Perfect humidity control MILD DRY
Mild Dry Cooling
 Fine control helps prevent a rapid decrease in room humidity while maintaining the set temperature. Maintains an RH* up to 10% higher than cooling operation (*RH: Relative Humidity). Ideal when sleeping with the air conditioner on.

Antiallergy Properties
 System is equipped with antiallergy properties filter.

Odour-removing function
 Allows the exchanger to be cleaned, preventing possible odours. While this function is connected, the fan also remains off momentarily to avoid unpleasant odours while the exchanger is being cleaned.

Removable, washable panel
 The front panel is easy to keep clean. It can be removed quickly in one single step and can be washed in water. A clean front panel ensures smoother, more efficient operation, which can save energy.

Comfort

Internet Control Ready
Internet Control
 Internet Control is a next generation system providing user-friendly remote control of air conditioning or heat pump units from everywhere, using a simple Android or iOS smartphone, tablet or PC via internet.

Energy saving
Inverter Plus System
 Inverter plus products improve on the characteristics of standard Inverter air conditioners by over 20%. This means 20% less consumption and 20% off your electric bill. Inverter plus is also A class on cooling and heating mode.

Energy saving
Inverter system
 The Inverter range provides greater efficiency, more comfort. Provides more precise temperature control, without highs and lows, and keeps the ambient temperature constant with lower energy consumption and a significant reduction in noise and vibration levels.

Up to 38% energy savings (cooling)
Econavi
 The sensor determines the human activity level and the position in the room and adjust the air flow orientation for maximum comfort and maximum savings, and detects changes in sunlight intensity and judges whether it is sunny or cloudy/night. It reduces unnecessary heating under more sunlight conditions.

Sunlight detection
Econavi Sunlight Detection
 Detects changes in sunlight intensity and judges whether it is sunny or cloudy/night. It reduces the heating and therefore wasted energy under more sunlight conditions.

Improved comfort
Autocomfort
 Detects conditions in the room and switches to energy saving operation when nobody is in the room. However, priority is given to comfort, so cooling power is increased when there's a lot of human activity.

Silent air 20 dB(A)
Super Quiet
 Thanks to its latest generation compressor and its twin blade fan, our outdoor unit is one of the most silent on the market. The indoor unit emits an almost imperceptible 20 dB.

Down to -10°C in cooling only mode
 The air conditioner works in cooling only mode with an outdoor temperature of -10 °C.

Down to -15°C in heating mode
 The air conditioner works in heat pump mode with an outdoor temperature as low as -15 °C.

Constant heating
Heatcharge
 This innovative, newly developed technology charges heat and uses it for heating. Thanks to this system, you can enjoy incredibly powerful, comfortable air conditioner heating.

Prevent freezing
Summer House
 This innovative function keeps the house at 7/8 °C to avoid freezing pipes during the winter. This function is highly appreciated in summer house or week end houses.

Easy control by BMS
Easy control by BMS
 The communication port is integrated into the indoor unit and provides easy connection to, and control of, your Panasonic heat pump to your home or building management system.

Powerful Mode
 The rapid and effective powerful mode is ideal for when you come home on the hottest or coldest days. It works at maximum power to reach the desired temperature in just 15 minutes.

Soft Dry Operation Mode
 The soft dry mode eliminates excess moisture with a soft breeze and provides a sense of wellbeing without much change in temperature.

Wide & Long Airflow Vane
 This vane has been designed so that the air goes further. It sends air to every corner of the room to keep the whole room in the comfort zone.

Personal Airflow Creation
 Permits the air direction to be adjusted vertically and horizontally. This feature can be conveniently selected by remote control.

Automatic Vertical Airflow Control
 The flap swings up and down automatically. The flow can also be set at a fixed angle with the remote control.

Manual Horizontal Airflow Control

Auto Mode (Inverter)
 Automatically changes from cooling to heating depending on the set temperature for the room.

Simple Auto Changeover
 When the difference between the measured temperature and the set temperature is 3 °C or more, it automatically switches the current operation mode to heating or cooling mode necessary to keep the temperature at a constantly comfortable level.

Hot Start Mode
 At the start of heating cycle and after defrost cycle, the indoor fan will start up once the indoor heat exchanger is warm.

Use

Real time clock with dual ON&OFF timer
 This feature enables you to preset two different sets of start/stop operation timer (hour and minute) within a 24-hour time frame.

Real time clock with single ON&OFF timer
 The exact operating time (hour and minute) can be set in advance. From here on, the unit will operate in accordance to these preset hours every day until the system is reset.

LCD Wireless Remote Controller

Reliability

Automatic Restart
 This function permits automatic restarting if safe mode operation has stopped for some unusual reason, such as after a power cut. As soon as the power is back, the unit restarts with the parameters selected before it stopped.

Long Piping
 Indicates the maximum length of pipe between the outdoor unit and the indoor unit(s). The distances permitted, demonstrate the installations possible.

Top-Panel Maintenance Access
 Maintenance of an outdoor unit used to be quite a tedious task. Now, with the possibility of removing the top cover, maintenance is quick and easy.

Self-Diagnosis Function
 With this function the unit carries out a process self-diagnosis when a particular function does not work correctly. This allows faster servicing.

Possible to use on R22 pipings
R22 Renewal
 The Panasonic renewal system allows good quality existing R22 pipe work to be re-used whilst installing new high efficiency R410A systems.

5 year compressor warranty
5 Years Warranty.
 Panasonic guarantees the compressors in the entire range for five years. Only for PRO partners.

Feature Comparison

MODELS	WALL MOUNTED ETHEREA INVERTER+ SILVER	WALL MOUNTED ETHEREA INVERTER+ WHITE	WALL MOUNTED VE INVERTER+ ENERGY CHARGE SYSTEM	WALL MOUNTED RE TYPE STANDARD INVERTER	FLOOR CONSOLE TYPE INVERTER+	4-WAY 60x60 CASSETTE INVERTER	LOW STATIC PRESSURE HIDE AWAY INVERTER
Healthy Air Quality Air purifier YPA sensor nanoe-G	Nanoe-G air purifying system	✓	✓	✓			
Perfect healthy control nanoe-G	Mild Dry Cooling	✓	✓				
Anti-allergy properties	✓ 3rd party tested	✓ 3rd party tested	✓ 3rd party tested	✓			
Odour-removing function	✓	✓	✓	✓	✓	✓	✓
Removable, washable panel	✓	✓	✓	✓	✓		
Internet Control Wi-Fi Smart Control	Internet Control	✓	✓	✓	✓		
Energy saving ECONAVI	Inverter+ system	✓	✓	✓	✓		
Energy saving ECONAVI	Inverter system			✓		✓	✓
Up to 38% energy saving (cooling) ECONAVI	Econavi	✓	✓				
Sunlight detection ECONAVI	Econavi Sunlight Detection	✓	✓	✓			
Personalized comfort Auto Comfort	Autocomfort	✓	✓				
Sound at 20 dB(A) Sound level	Super Quiet	✓ For XE7, XE9 and XE12	✓ For E7, E9 and E12	✓	✓ For RE9-12* (22dB)		
Down to -10°C in cooling mode Temperature	Down to -10 °C in cooling only	✓	✓	✓		✓	✓
Down to -15°C in heating mode Temperature	Down to -15 °C in heating mode	✓	✓	✓ -30 °C	✓ -20 °C	✓ -10 °C	✓ -10 °C
Constant heating Temperature	Heatcharge		✓				
Prevent freezing Temperature	Summer House		✓				
Easy control by BMS BMS	Easy control by BMS	✓	✓	✓		✓	✓
Powerful mode	Powerful mode	✓	✓	✓	✓	✓	✓
Soft dry operation mode	Soft dry operation mode	✓	✓	✓	✓	✓	✓
Wide & long airflow vane	Wide & long airflow vane		✓	✓			
Personal airflow creation	Personal airflow creation	✓	✓	✓	✓ For RE18 and RE24		
Automatic vertical airflow control	Automatic vertical airflow control		✓	✓	✓ For RE9 and RE12	✓	
Manual horizontal airflow control	Manual horizontal airflow control		✓	✓	✓ For RE9 and RE12	✓	
AUTO mode (Inverter)	AUTO mode (Inverter)	✓	✓	✓	✓	✓	✓
Simple Auto Changerover	Simple Auto Changerover	✓	✓	✓	✓		
Hot start mode	Hot start mode	✓	✓	✓	✓	✓	✓
Real time clock with dual ON&OFF timer	Real time clock with dual ON&OFF timer	✓	✓	✓			
Real time clock with single ON&OFF timer	Real time clock with single ON&OFF timer			✓	✓	✓	✓
LCD Wireless remote controller	LCD Wireless remote controller	✓	✓	✓	✓	✓	
Automatic restart	Automatic restart	✓	✓	✓	✓	✓	✓
Long piping	✓ 15 m (XE7-12) 20 m (XE18)	✓ 15 m (E7-15) 20 m (E18-21) 30 m (E24-28)	✓ 15 m	✓ 15 m (RE9-15) 20 m (RE18) 30 m (RE24)	✓ 15 m (E9-12) 20 m (E18)	✓ 20 m	✓ 20 m
Top-Panel maintenance access	Top-Panel maintenance access	✓	✓	✓	✓	✓	✓
Self-diagnosis function	Self-diagnosis function	✓	✓	✓	✓	✓	✓
Replace by one R22 piping R22	R22 renewal	✓	✓	✓	✓	✓	✓
5 year compressor warranty	Warranty on the compressor	✓	✓	✓	✓	✓	✓

* At the lowest fan speed.

WALL MOUNTED VE INVERTER+ ENERGY CHARGE SYSTEM



Included



CU-VE9NKE
CU-VE12NKE



SEASONAL
EFFICIENCY
SEER – SCOP

A+++

heatcharge

The Heatcharge from Panasonic has the capacity to store heat on the outdoor unit which allows heating to start quickly just after turning on the heat pump. It also ensures maximum comfort and heat in the house even during defrost operation as Heat charge also stores heat to prevent cool air during defrost. ECONAVI builds-in a new Sunlight Detection technology to adjust output ideally thereby giving you the best comfort at anytime whilst saving energy.

Furthermore, the Nanoe-G revolutionary air-purifying system utilises nano technology fine particles to remove and deactivate 99% of both airborne and adhesive micro-organisms like bacteria, viruses and mould.

Technical focus

- This units can be installed on R22 pipings
- Work up to -30 °C
- Energy Charge System. Heat storage unit which realizes NON-STOP heating and fast heating function
- Maximum efficiency and comfort with Econavi sunlight detection
- Nanoe-G air purifying system, 99 % effective on both airborne and adhesive mould, viruses and bacteria
- Super Quiet! Only 23 dB(A), equivalent to night-time in the country
- More powerful airflow to quickly reach the desired temperature

Kit			KIT-VE9-NKE	KIT-VE12-NKE
Indoor			CS-VE9NKE	CS-VE12NKE
Outdoor			CU-VE9NKE	CU-VE12NKE
Cooling capacity	Nominal (Min - Max)	kW	2,50 (0,60 - 3,00)	3,50 (0,60 - 4,00)
EER ¹⁾	Nominal (Min - Max)	Energy Saving	5,15 A	3,98 A
SEER	Nominal	Energy Saving	8,60 A+++	8,50 A+++
Pdesign (cooling)		kW	2,5	3,5
Power input cooling	Nominal (Min - Max)	kW	0,480 (0,140 - 0,790)	0,880 (0,140 - 1,100)
Annual electricity consumption (cooling) ²⁾		kWh/a	102	145
Heating capacity	Nominal (Min - Max)	kW	3,20 (0,60 - 7,70)	4,20 (0,60 - 8,40)
Heating capacity at -7 °C	Nominal	kW	3,2	5,60
COP ¹⁾	Nominal (Min - Max)	Energy Saving	5,47 A	4,91 A
SCOP	Nominal	Energy Saving	5,40 A+++	5,10 A+++
Pdesign at -10 °C		kW	3,2	4,2
Power input heating	Nominal (Min - Max)	kW	0,580 (0,140 - 2,720)	0,850 (0,140 - 3,160)
Annual electricity consumption (heating) ²⁾		kWh/a	830	1153
Indoor Unit				
Power source		V	230	230
Recommended fuse		A	16	16
Recommended power cable section		mm ²	1,5	1,5
Connection		mm ²	4 x 1,5	4 x 1,5
Current (Nominal)	Cooling / Heating	A	2,2 / 2,7	3,9 / 3,8
Maximum current		A	14,0	15,0
Air volume	Cooling / Heating	m ³ /h	600 / 600	654 / 618
Moisture removal volume		l/h	1,5	2,0
Sound pressure level ³⁾	Cooling — Heating (Hi / Lo / Q-Lo)	dB(A)	44 / 26 / 23 — 44 / 27 / 24	45 / 29 / 26 — 45 / 33 / 30
Sound power level	Cooling / Heating (Hi)	dB	59 / 59	60 / 60
Dimensions / Net weight	H x W x D	mm / kg	295 x 890 x 275 / 14,5	295 x 890 x 275 / 14,5
Air purifier filter			Nanoe-G	Nanoe-G
Outdoor Unit				
Air volume	Cooling / Heating	m ³ /h	1.980 / 1.890	2.052 / 1.890
Sound pressure level ³⁾	Cooling / Heating (Hi)	dB(A)	49 / 49	50 / 50
Sound power level	Cooling / Heating (Hi)	dB	64 / 64	65 / 65
Dimensions ⁴⁾ / Net weight	H x W x D	mm / kg	623 x 799 x 299 / 43	623 x 799 x 299 / 43
Piping connections	Liquid pipe / Gas pipe	inch (mm)	1/4 (6,35) / 3/8 (9,52)	1/4 (6,35) / 3/8 (9,52)
Refrigerant loading	R410A	kg	1,50	1,50
Elevation difference (in/out)	Max	m	12	12
Piping length	Min / Max	m	3 / 15	3 / 15
Precharge length	Max	m	7,5	7,5
Additional charge		g/m	20	20
Operating range	Cooling Min / Max	°C	-10 / +43	-10 / +43
	Heating Min / Max	°C	-30 ⁵⁾ / +24	-30 ⁵⁾ / +24

Rating Conditions: Cooling Indoor 27 °C DB / 19 °C WB. Cooling Outdoor 35 °C DB / 24 °C WB. Heating Indoor 20 °C DB. Heating Outdoor 7 °C DB / 6 °C WB. (DB: Dry Bulb; WB: Wet Bulb)

1) EER and COP classification is at 230 V in accordance with EU directive 2002/31/EC. 2) The annual energy consumption is calculated in accordance with the ErP directive. 3) The Sound pressure level of the units shows the value measured of a position 1 meter in front of the main body and 0,8 m below the unit. The sound pressure is measured in accordance with Eurovent 6/C/006-97 specification. 4) Add 70 mm for piping port. 5) Operation possible on heating mode up to -30 °C tested by SP. Performance guaranteed on heating mode up to -20 °C. * Preliminary data.

Specifications subject to change without notice. For detailed information about ErP, please visit our websites www.aircon.panasonic.co.uk or www.ptc.panasonic.eu.

Internet Control Ready	Energy saving	8,60 A+++ SEER	5,40 A+++ SCOP	Air purifier 99% removal bacteria-virus-mold	Sunlight detection	Silent air 23 dB(A)	Down to -30°C in heating mode	Constant heating	Prevent freezing	Easy control by BMS	Possible to use on R22 pipings	5 year compressor warranty	
INTERNET CONTROL	INVERTER+	SEASONAL ENERGY EFFICIENCY RATIO	SEASONAL COEFFICIENT OF PERFORMANCE	nanoe-g	ECONAVI	SUPER QUIET	OUTDOOR TEMPERATURE	HEATCHARGE	SUMMER HOUSE	CONNECTIVITY	R22 RENEWAL		

INTERNET CONTROL READY: Optional. SEER and SCOP: For KIT-VE9-NKE. 5 YEARS COMPRESSOR WARRANTY: Only for PRO partners.

WALL MOUNTED ETHEREA INVERTER+ SILVER PLATED / WHITE



Included



Optional wired remote control CZ-RD514C



SEASONAL EFFICIENCY SEER — SCOP

A++



CS-E70KEW // CS-E90KEW // CS-E120KEW // CS-E150KEW



CS-XE180KEW



CS-E180KEW // CS-E210KEW // CS-E240KEW // CS-E280KEW

ETHEREA



CU-E70KE



CU-E90KE



CU-E120KE



CU-E150KE



CU-E180KE



CU-E210KE



CU-E240KE



CU-E280KE

Etherea with enhanced Econavi sensor and new Nanoe-G air-purifying system: outstanding efficiency, comfort and healthy air combined with state-of-the-art design.

Econavi features an in-built human activity sensor and a new sunlight detection technology to adjust output thereby giving you the best comfort at anytime whilst saving energy. Econavi not only optimizes air flow orientation and volume according to human presence, it also reduces cooling power automatically by no/less sunshine. With Econavi, energy savings of up to 38% are possible, whilst increasing your comfort. Furthermore, the Nanoe-G revolutionary air-purifying system utilises nano technology fine particles to remove and deactivate 99% of both airborne and adhesive micro-organisms like bacteria, viruses and mould.

Technical focus

- This units can be installed on R22 pipings
- Maximum efficiency and comfort with Econavi, now with sunlight detection
- Nanoe-G air purifying system, 99 % effective on both airborne and adhesive mould, viruses, bacteria and pollen allergen
- Optional smartphone control
- Mild Dry Cooling: prevent a rapid decrease in room humidity
- Super Quiet! Only 20 dB(A), equivalent to night-time in the countryside (XE7, XE9, XE12, E7, E9 and E12)
- More powerful airflow to quickly reach the desired temperature

Kit Silver Plated			KIT-XE7-OKE	KIT-XE9-OKE	KIT-XE12-OKE	—	KIT-XE18-OKE	—	—	
Kit White			KIT-E7-OKE	KIT-E9-OKE	KIT-E12-OKE	KIT-E15-OKE	KIT-E18-OKE	KIT-E21-OKE	KIT-E24-OKE	KIT-E28-OKE
Indoor Silver plated			CS-XE70KEW	CS-XE90KEW	CS-XE120KEW	—	CS-XE180KEW	—	—	—
Indoor White			CS-E70KEW	CS-E90KEW	CS-E120KEW	CS-E150KEW	CS-E180KEW	CS-E210KEW	CS-E240KEW	CS-E280KES
Outdoor			CU-E70KE	CU-E90KE	CU-E120KE	CU-E150KE	CU-E180KE	CU-E210KE	CU-E240KE	CU-E280KE
Cooling capacity	Nominal (Min - Max)	kW	2,05 (0,75 - 2,40)	2,50 (0,85 - 3,00)	3,50 (0,85 - 4,00)	4,20 (0,85 - 5,00)	5,00 (0,98 - 6,00)	6,30 (0,98 - 7,10)	6,80 (0,98 - 8,10)	7,65 (0,98 - 8,60)
EER ¹⁾	Nominal (Min - Max)	Energy Saving	4,46 (3,13-4,25) A	4,76 (3,47-4,20) A	4,19 (3,40-3,81) A	3,39 (3,27-3,25) A	3,47 (3,50-3,02) A	2,89 (3,50-2,84) C	3,27 (2,58-3,06) A	3,04 (2,58-2,95) B
SEER	Nominal	Energy Saving	6,90 A++	6,90 A++	7,60 A++	6,60 A++	6,90 A++	6,50 A++	6,10 A++	6,00 A+
Pdesign (cooling)		kW	2,1	2,5	3,5	4,2	5,0	6,3	6,8	7,7
Power input cooling	Nominal (Min - Max)	kW	0,460 (0,240 - 0,565)	0,525 (0,245 - 0,715)	0,835 (0,250 - 1,050)	1,240 (0,260 - 1,540)	1,440 (0,280 - 1,990)	2,180 (0,280 - 2,500)	2,080 (0,380 - 2,650)	2,520 (0,380 - 2,920)
Annual electricity consumption (cooling) ²⁾		kWh/a	107	127	161	223	254	339	390	449
Heating capacity	Nominal (Min - Max)	kW	2,80 (0,70 - 4,00)	3,40 (0,80 - 5,00)	4,00 (0,80 - 6,00)	5,30 (0,80 - 6,80)	5,80 (0,98 - 8,00)	7,20 (0,98 - 8,50)	8,60 (0,98 - 9,90)	9,60 (0,98 - 11,00)
Heating capacity at -7 °C	Nominal	kW	2,38	2,95	3,45	4,11	4,98	5,24	6,13	6,77
COP ¹⁾	Nominal (Min - Max)	Energy Saving	4,48 (3,89-4,00) A	4,72 (4,21-3,92) A	4,76 (4,21-3,75) A	3,73 (4,21-3,54) A	3,82 (2,88-3,11) A	3,44 (2,88-3,11) B	3,33 (2,18-3,19) C	2,96 (2,18-3,01) D
SCOP	Nominal	Energy Saving	4,40 A+	4,70 A++	4,80 A++	4,00 A+	4,20 A+	4,00 A+	3,90 A-	3,80 A-
Pdesign at -10 °C		kW	2,1	2,7	3,2	3,6	4,4	4,6	5,5	6,0
Power input heating	Nominal (Min - Max)	kW	0,625 (0,180 - 1,000)	0,720 (0,190 - 1,270)	0,840 (0,190 - 1,600)	1,420 (0,190 - 1,920)	1,520 (0,340 - 2,570)	2,090 (0,340 - 2,730)	2,580 (0,450 - 3,100)	3,240 (0,450 - 3,650)
Annual electricity consumption (heating) ²⁾		kWh/a	668	804	933	1.260	1.467	1.610	1.974	2.211
Indoor Unit										
Power source (Recommended fuse)	V (A)		230 (16)	230 (16)	230 (16)	230 (16)	230 (16)	230 (20)	230 (20)	230 (20)
Recommended power cable section	mm ²		1,5	1,5	1,5	1,5	1,5	2,5	2,5	2,5
Connection indoor / outdoor	mm ²		4 x 1,5	4 x 1,5	4 x 1,5	4 x 1,5	4 x 2,5	4 x 2,5	4 x 2,5	4 x 2,5
Current (Nominal)	Cooling / Heating	A	2,20 / 2,80	2,35 / 3,20	3,80 / 3,90	5,50 / 6,30	6,4 / 6,8	9,7 / 9,4	9,5 / 11,7	11,5 / 14,5
Maximum current		A	4,40	5,6	7,40	8,5	11,3	11,9	14,4	15,5
Air volume	Cooling / Heating	m ³ /h	726 / 738	768 / 774	804 / 822	852 / 876	1074 / 1158	1.134 / 1.200	1.188 / 1.272	1.266 / 1.314
Moisture removal volume		l/h	1,3	1,5	2	2,4	2,8	3,5	3,9	4,5
Sound pressure level ³⁾	Cooling (Hi / Lo / Q-Lo)	dB(A)	37 / 24 / 20	39 / 25 / 20	42 / 28 / 20	43 / 31 / 25	44 / 37 / 34	45 / 37 / 34	47 / 38 / 35	49 / 38 / 35
	Heating (Hi / Lo / Q-Lo)	dB(A)	38 / 25 / 20	40 / 27 / 20	42 / 33 / 20	43 / 35 / 29	44 / 37 / 34	45 / 37 / 34	47 / 38 / 35	48 / 38 / 35
Sound power level	Cooling / Heating (Hi)	dB	53 / 54	55 / 56	58 / 58	59 / 59	60 / 60	61 / 61	63 / 63	65 / 64
Dimensions / Net weight	H x W x D	mm / kg	295x870x255 / 10	295x870x255 / 10	295x870x255 / 10	295x870x255 / 10	295x1.070x255 / 13	295x1.070x255 / 13	295x1.070x255 / 13	295x1.070x255 / 13
Air purifier filter			Nanoe-G	Nanoe-G	Nanoe-G	Nanoe-G	Nanoe-G	Nanoe-G	Nanoe-G	Nanoe-G
Outdoor Unit										
Air volume	Cooling / Heating	m ³ /h	2.034 / 2.034	1.788 / 1.788	2.106 / 2.160	1.998 / 1.998	2.352 / 2.274	2.502 / 2.424	3.012 / 3.012	3.270 / 3.270
Sound pressure level ³⁾	Cooling / Heating (Hi)	dB(A)	45 / 46	46 / 47	48 / 50	49 / 51	47 / 47	48 / 49	52 / 52	53 / 53
Sound power level	Cooling / Heating (Hi)	dB	60 / 61	61 / 62	63 / 65	64 / 66	61 / 61	62 / 63	66 / 66	67 / 67
Dimensions ⁴⁾ / Net weight	H x W x D	mm / kg	542x780x289 / 31	542x780x289 / 33	619x824x299 / 35	619x824x299 / 33	695x875x320 / 46	695x875x320 / 47	795x875x320 / 67	795x875x320 / 67
Piping connections	Liquid pipe / Gas pipe	inch (mm)		1/4 (6,35) / 3/8 (9,52)			1/4 (6,35) / 1/2 (12,70)			1/4" (6,35) / 5/8" (15,88)
Refrigerant loading	R410A (GWP value)	kg	0,85	1,02	1,15	1,02	1,24	1,32	1,80	1,80
Elevation difference (in/out) ⁵⁾	Max	m	15	15	15	15	15	15	20	20
Piping length (Precharge)	Min / Max (Max)	m	3 / 15 (7,5)	3 / 15 (7,5)	3 / 15 (7,5)	3 / 15 (7,5)	3 / 20 (7,5)	3 / 20 (7,5)	3 / 30 (10)	3 / 30 (10)
Additional charge		g/m	20	20	20	20	20	20	30	30
Operating range	Cooling Min / Max	°C	-10 / +43	-10 / +43	-10 / +43	-10 / +43	-10 / +43	-10 / +43	-10 / +43	-10 / +43
	Heating Min / Max	°C	-15 / +24	-15 / +24	-15 / +24	-15 / +24	-15 / +24	-15 / +24	-15 / +24	-15 / +24

Rating Conditions: Cooling Indoor 27 °C DB / 19 °C WB. Cooling Outdoor 35 °C DB / 24 °C WB. Heating Indoor 20 °C DB. Heating Outdoor 7 °C DB / 6 °C WB. (DB: Dry Bulb; WB: Wet Bulb)

1) EER and COP classification is at 230 V in accordance with EU directive 2002/31/EC. 2) The annual energy consumption is calculated in accordance with the EU directive. 3) The sound pressure level of the units shows the value measured of a position 1 metre in front of the main body and 0,8 m below the unit. The sound pressure is measured in accordance with Eurovent 6/06-97 specification. Q-Lo: Quiet mode. Lo: The lowest fan speed. 4) Add 70 mm for piping port. 5) When installing the outdoor unit at a higher position than the indoor unit.

Specifications subject to change without notice. For detailed information about ErP, please visit our websites www.aircon.panasonic.co.uk or www.ptc.panasonic.eu.

Internet Control Ready

Energy saving

7,60 A++ SEER

4,80 A++ SCOP

Air purifier 99% removal bacteria-virus-mold

Up to 38% energy savings (cooling)

Improved comfort

Perfect humidity control

Silent air 20 dB(A)

Easy control by BMS

Possible to use on R22 pipings

5 year compressor warranty

INTERNET CONTROL READY: Optional. SEER and SCOP: For KIT-XE12-OKE and KIT-E12-OKE. MILD DRY: Maintains a Relative Humidity up to 10% higher than cooling operation. Ideal when sleeping with the air conditioner on. SUPER QUIET: For XE7, XE9, XE12, E7, E9 and E12. 5 YEARS COMPRESSOR WARRANTY: Only for PRO partners.

WALL MOUNTED RE TYPE STANDARD INVERTER



Included for RE9, and RE12
Included for RE18 and RE24
Optional wired remote control CZ-RD514C



CU-RE9RKE



CU-RE12RKE



CU-RE18RKE

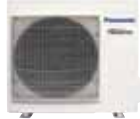

CU-RE24RKE



CS-RE18RKE // CS-RE24RKE

RE Inverter models are powerful and efficient, with an outstanding energy ranking of A++/A+, unique in the market! The RE works up to an outdoor temperature of -15 °C in heating mode and -10 °C up a outdoor temperature of -15 °C in heating and -10 °C in cooling and still with a high efficiency and capacity! Furthermore, the annual energy consumption has never been so low.

Technical focus

- Wired Controller (optional)
- This units can be installed on R22 pipings
- Complete line-up of standard Inverter models
- Quieter indoor units
- High energy savings
- Long connection distance (from 15 m up to 30 m)

Kit			KIT-RE9-RKE	KIT-RE12-RKE	KIT-RE18-RKE	KIT-RE24-RKE
Indoor			CS-RE9RKEW	CS-RE12RKEW	CS-RE18RKEW	CS-RE24RKEW
Outdoor			CU-RE9RKE	CU-RE12RKE	CU-RE18RKE	CU-RE24RKE
Cooling capacity	Nominal (Min - Max)	kW	2,50 (0,85 - 3,00)	3,50 (0,85 - 3,90)	5,00 (0,98 - 6,00)	6,80 (0,98 - 8,10)
EER ¹⁾	Nominal (Min - Max)	Energy Saving	3,73 (3,40 - 3,16) A	3,50 (3,33 - 3,28) A	3,40 (3,50 - 2,96) A	3,24 (2,58 - 3,03) A
SEER	Nominal	Energy Saving	6,10 A++	6,10 A++	6,70 A++	6,00 A+
Pdesign (cooling)		kW	2,5	3,5	5,0	6,8
Power input cooling	Nominal (Min - Max)	kW	0,670 (0,250 - 0,950)	1,000 (0,255 - 1,190)	1,470 (0,280 - 2,030)	2,100 (0,380 - 2,670)
Annual electricity consumption (cooling) ²⁾		kWh/a	143	201	261	397
Heating capacity	Nominal (Min - Max)	kW	3,30 (0,80 - 4,10)	4,00 (0,80 - 5,10)	5,80 (0,98 - 8,00)	8,60 (0,98 - 9,90)
Heating capacity at -7 °C	Nominal	kW	2,70	3,30	4,98	6,13
COP ¹⁾	Nominal (Min - Max)	Energy Saving	4,13 (4,10 - 3,63) A	3,81 (4,00 - 3,59) A	3,77 (2,88 - 3,08) A	3,30 (2,18 - 3,16) C
SCOP	Nominal	Energy Saving	4,00 A+	4,00 A+	4,10 A+	3,80 A
Pdesign at -10 °C		kW	2,4	2,8	4,4	5,5
Power input heating	Nominal (Min - Max)	kW	0,800 (0,195 - 1,130)	1,050 (0,200 - 1,420)	1,540 (0,340 - 2,600)	2,610 (0,450 - 3,130)
Annual electricity consumption (heating) ²⁾		kWh/a	840	980	1.502	2.026
Indoor Unit						
Connection (indoor/outdoor)		mm ²	4 x 1,5	4 x 1,5	4 x 1,5	4 x 1,5
Current (Nominal)	Cooling / Heating	A	2,95 / 3,50	4,40 / 4,60	6,60 / 6,90	9,60 / 11,70
Maximum current		A	5,0	6,2	11,4	14,5
Air volume	Cooling / Heating	m ³ /h	702 / 768	762 / 804	978 / 1.074	1.104 / 1.170
Moisture removal volume		l/h	1,5	2,0	2,8	3,9
Sound pressure level ³⁾	Cooling — Heating (Hi / Lo / Q-Lo)	dB(A)	41 / 26 / 22 — 41 / 27 / 24	42 / 30 / 22 — 42 / 33 / 25	44 / 37 / 34 — 44 / 37 / 34	47 / 38 / 35 — 47 / 38 / 35
Sound power level	Cooling / Heating (Hi)	dB	57 / 57	58 / 58	60 / 60	63 / 63
Dimensions / Net weight	H x W x D	mm / kg	290 x 870 x 214 / 9	290 x 870 x 214 / 9	290 x 1.070 x 240 / 12	290 x 1.070 x 240 / 12
Silver decoration sheet		Yes	Yes	Yes	Yes	Yes
Outdoor Unit						
Power source		V	230	230	230	230
Recommended fuse		A	16	16	16	16
Recommended power cable section		mm ²	1,5	1,5	2,5	2,5
Air volume	Cooling / Heating	m ³ /h	1.926 / 1.872	1.998 / 1.998	2.352 / 2.274	3.012 / 3.012
Sound pressure level ³⁾	Cooling / Heating (Hi)	dB(A)	47 / 48	48 / 50	47 / 47	52 / 52
Sound power level	Cooling / Heating (Hi)	dB	62 / 63	63 / 65	61 / 61	66 / 66
Dimensions ⁴⁾ / Net weight	H x W x D	mm / kg	542 x 780 x 289 / 31	619 x 824 x 299 / 34	695 x 875 x 320 / 46	795 x 875 x 320 / 67
Piping connections	Liquid / Gas pipe	inch (mm)	1/4 (6,35) / 3/8 (9,52)	1/4 (6,35) / 3/8 (9,52)	1/4 (6,35) / 1/2 (12,70)	1/4 (6,35) / 5/8 (15,88)
Refrigerant loading	R410A	kg	0,85	0,99	1,19	1,80
Elevation difference (in/out)	Max	m	15	15	15	20
Piping length	Min / Max	m	3 / 15	3 / 15	3 / 20	3 / 30
Precharge length	Max	m	7,5	7,5	7,5	10,0
Additional charge		g/m	20	20	20	30
Operating range	Cooling Min / Max	°C	-10 / +43	-10 / +43	-10 / +43	-10 / +43
	Heating Min / Max	°C	-15 / +24	-15 / +24	-15 / +24	-15 / +24

Rating Conditions: Cooling Indoor 27 °C DB / 19 °C WB. Cooling Outdoor 35 °C DB / 24 °C WB. Heating Indoor 20 °C DB. Heating Outdoor 7 °C DB / 6 °C WB. (DB: Dry Bulb; WB: Wet Bulb)

1) EER and COP classification is at 230 V in accordance with EU directive 2002/31/EC. 2) The annual energy consumption is calculated in accordance with the ErP directive. 3) The Sound pressure level of the units shows the value measured of a position 1 metre in front of the main body and 0,8 m below the unit. The sound pressure is measured in accordance with Eurovent 6/C/006-97 specification. Q-Lo: The lowest fan speed. Lo: The second lowest fan speed (the lowest fan speed for RE18/24). 4) Add 70 mm for piping port. Specifications subject to change without notice. For detailed information about ErP, please visit our websites www.aircon.panasonic.co.uk or www.ptc.panasonic.eu.

Internet Control Ready	Energy saving	6,70 A++ SEER	4,10 A+ SCOP	Silent air 22 dB(A)	Possible to use on R22 pipings	Dry contact with additional PCB-PAW-AC-DIO
INTERNET CONTROL	INVERTER	SEASONAL ENERGY EFFICIENCY RATIO	SEASONAL COEFFICIENT OF PERFORMANCE	SUPER QUIET	R22 RENEWAL	SIMPLE CONNECTION

5 year compressor warranty

INTERNET CONTROL READY: Optional. SEER and SCOP: For KIT-RE18-RKE. SUPER QUIET: For RE9 and RE12. 5 YEARS COMPRESSOR WARRANTY: Only for PRO partners.

4 WAY 60x60 CASSETTE INVERTER



Included



Optional wired remote control CZ-RD5ZCP



CU-E9PB4EA



CU-E12PB4EA
CU-E18RBEA



Panel CZ-BT20E



Specially designed for offices, retail and restaurant applications, this cassette fits perfectly into 60x60 or 70x70 ceiling grids. Featuring the best efficiency in its category (heating and cooling up to -10 °C, this new cassette in 9 and 12 kW versions can also be connected to KNX, Modbus, EnOcean interfaces for easy integration with your BMS systems. Interfaces have dry contacts (ON/OFF, error message) to enable easy integration. With the new Intesishome interface, you can also control the cassette from your smartphone and internet very easily! Fit Panasonic's Cassette Type, and start to save all year round!

Technical focus

- **NEW!** 18 and 21 kW models
- Cassettes can be controlled by Intesishome, KNX, EnOcean and Modbus
- This units can be installed on R22 pipings
- Easy installation in the standard European 60x60 ceiling grid
- Operation down to -10 °C in cooling and heating modes
- Piping length up to 30 m
- Maximum elevation difference up to 20 m
- Ultra compact outdoor units for easy installation
- Real time clock with single ON&OFF timer
- High pressure selector in case of high ceilings (higher than 2,7 m)
- Drain pump included (max 750 mm high)
- Air fresh entry available on the cassette

KIT			KIT-E9-PB4EA	KIT-E12-PB4EA	KIT-E18-RB4EA	KIT-E21-RB4EA
Indoor			CS-E9PB4EA	CS-E12PB4EA	CS-E18RB4EAW	CS-E21RB4EAW
Outdoor			CU-E9PB4EA	CU-E12PB4EA	CU-E18RBEA	CU-E21RBEA
Panel			CZ-BT20E	CZ-BT20E	CZ-BT20E	CZ-BT20E
Cooling capacity	Nominal (Min - Max)	kW	2,50 (0,85 - 3,00)	3,40 (0,85 - 4,00)	5,00 (0,90 - 5,80)	5,90 (0,90 - 6,30)
EER ¹⁾	Nominal (Min - Max)	Energy Saving	4,55 (3,54 - 4,05) A	3,82 (3,54 - 3,33) A	3,13 (3,53 - 2,97) B	2,88 (3,53 - 2,86) C
SEER		Energy Saving	5,80 A+	5,60 A+	5,80 A+	5,60 A+
Pdesign (cooling)		kW	2,50	3,40	5,00	5,90
Power input cooling	Nominal (Min - Max)	kW	0,550 (0,240 - 0,740)	0,890 (0,240 - 1,200)	1,600 (0,255 - 1,950)	2,050 (0,255 - 2,200)
Annual electricity consumption (cooling) ²⁾		kWh/a	151	213	302	369
Heating capacity	Nominal (Min - Max)	kW	3,20 (0,85 - 4,80)	4,50 (0,85 - 5,60)	5,60 (0,90 - 7,10)	7,00 (0,90 - 8,00)
Heating capacity at -7 °C	Nominal	kW	2,60	3,00		
COP ¹⁾	Nominal (Min - Max)	Energy Saving	4,00 (3,70 - 3,56) A	3,17 (3,7 - 2,80) D	3,01 (3,46 - 2,92) D	2,86 (3,46 - 2,84) D
SCOP	Nominal	Energy Saving	4,00 A+	3,80 A	4,10 A+	4,10 A+
Pdesign at -10 °C		kW	2,70	3,00	3,80	4,00
Power input heating	Nominal (Min - Max)	kW	0,800 (0,230 - 1,350)	1,420 (0,230 - 2,000)	1,860 (0,260 - 2,430)	2,450 (0,260 - 2,820)
Annual electricity consumption (heating) ²⁾		kWh/a	945	1.105	1.298	1.366
Indoor Unit						
Power source		V	230	230	230	230
Recommended fuse		A	16	16	16	16
Recommended power cable section		mm ²	1,5	1,5	1,5	1,5
Connection		mm ²	4 x 1,5 to 2,5	4 x 1,5 to 2,5	4 x 1,5 to 2,5	4 x 1,5 to 2,5
Current (Nominal)	Cooling / Heating	A	2,65 / 3,85	4,20 / 6,50	7,20 / 8,30	9,10 / 11,10
Air volume	Cooling / Heating	m ³ /h	630 / 648	630 / 648	690 / 708	744 / 876
Moisture removal volume		l/h	1,5	2,3	2,8	3,3
Sound pressure level ³⁾	Cooling — Heating (Hi / Lo / S-Lo)	dB(A)	34 / 26 / 23 — 35 / 28 / 25	34 / 26 / 23 — 35 / 28 / 25	37 / 28 / 25 — 38 / 29 / 26	42 / 33 / 30 — 43 / 34 / 31
Sound power level	Cooling / Heating (Hi)	dB	50 / 51	50 / 51	53 / 54	58 / 59
Dimensions / Net weight	Indoor (H x W x D)	mm / kg	260 x 575 x 575 / 18	260 x 575 x 575 / 18	260 x 575 x 575 / 18	260 x 575 x 575 / 18
	Panel (H x W x D)	mm / kg	51 x 700 x 700 / 2,5	51 x 700 x 700 / 2,5	51 x 700 x 700 / 2,5	51 x 700 x 700 / 2,5
Dust filter		Yes	Yes	Yes	Yes	Yes
Outdoor Unit						
Power source		V	230	230	230	230
Air volume	Cooling / Heating	m ³ /h	1.830 / 1.734	1.980 / 1.836	2.352 / 2.352	2.424 / 2.424
Sound pressure level ³⁾	Cooling / Heating (Hi)	dB(A)	45 / 46	45 / 47	47 / 48	49 / 50
Sound power level	Cooling / Heating (Hi)	dB	58 / 61	60 / 62	61 / 62	63 / 64
Dimensions ⁴⁾ / Net weight	H x W x D	mm / kg	622 x 824 x 299 / 36	695 x 875 x 320 / 45	695 x 875 x 320 / 47	695 x 875 x 320 / 47
Piping connections	Liquid / Gas pipe	Inch (mm)	1/4 (6,35) / 3/8 (9,52)	1/4 (6,35) / 3/8 (9,52)	1/4 (6,35) / 1/2 (12,70)	1/4 (6,35) / 1/2 (12,70)
Refrigerant loading	R410A	kg	1,13	1,13	1,23	1,30
Elevation difference (in/out)	Max	m	15	15	20	20
Piping length	Min / Max	m	3 / 20	3 / 20	3 / 30	3 / 30
Precharge length	Max	m	10	10	10	10
Additional charge		g/m	20	20	20	20
Operating range	Cooling (Min / Max)	°C	-10 / +43	-10 / +43	-10 / +43	-10 / +43
	Heating (Min / Max)	°C	-10 / +24	-10 / +24	-10 / +24	-10 / +24

Rating Conditions: Cooling Indoor 27 °C DB / 19 °C WB. Cooling Outdoor 35 °C DB / 24 °C WB. Heating Indoor 20 °C DB. Heating Outdoor 7 °C DB / 6 °C WB. (DB: Dry Bulb; WB: Wet Bulb)

1) EER and COP classification is at 230 V in accordance with EU directive 2002/31/EC. 2) The annual energy consumption is calculated in accordance with the ErP directive. 3) The Sound pressure level of the units shows the value measured of a position 1 metre in front of the main body and 1,5 m below the ceiling in the centre of the unit. The sound pressure is measured in accordance with Eurovent 6/C/006-97 specification. 4) Add 70 mm for piping port. Specifications subject to change without notice. For detailed information about ErP, please visit our websites www.aircon.panasonic.co.uk or www.ptc.panasonic.eu.

Internet Control Ready

Energy saving

5,80 A+ SEER

4,00 A+ SCOP

Down to -10°C in cooling mode

Down to -10°C in heating mode

Easy control by BMS

Possible to use on R22 pipings

5 year compressor warranty

INTERNET CONTROL READY: Optional. SEER and SCOP: For KIT-E9-PB4EA. 5 YEARS COMPRESSOR WARRANTY: Only for PRO partners.

LOW STATIC PRESSURE HIDE AWAY INVERTER



Included



CU-E9PD3EA



CU-E12PD3EA
CU-E18RBEA

Designed for homes, offices, retail and restaurants, this Duct is ideal for small rooms where the air conditioning and the heating should be nicely integrated and where high comfort and efficiency is needed.

The new 9 and 12kW duct can also be connected to KNX, Modbus, EnOcean interfaces for easy integration with your BMS systems. This interfaces have dry contacts (ON/OFF, error message) for easy integration.

With the new Intesishome interface, you can control the Duct also from your smartphone and internet very easily!

Technical focus

- **NEW!** 18 kW model
- Duct type can be controlled by Intesishome, KNX, EnOcean and Modbus
- This units can be installed on R22 pipings
- Eco mode for 20% energy saving
- Extremely compact indoor units without losing static pressure (only 235 mm high)
- Weekly timer, 42 settings per week
- Easy check mode for failure detection
- Drain pump included (max 200 mm)

KIT			KIT-E9-PD3EA	KIT-E12-QD3EA	KIT-E18-RD3EA
Indoor			CS-E9PD3EA	CS-E12QD3EAW	CS-E18RD3EAW
Outdoor			CU-E9PD3EA	CU-E12QD3EA	CU-E18RBEA
Cooling capacity	Nominal (Min-Max)	kW	2,50 (0,85 - 3,00)	3,40 (0,85 - 4,00)	5,10 (0,90 - 5,70)
EER ¹⁾	Nominal	Energy Saving	4,24 (3,54 - 3,95) A	3,86 (3,54 - 3,45) A	3,19 (3,53 - 3,13) B
SEER		Energy Saving	5,80 A+	5,60 A	5,80 A+
Pdesign (cooling)		kW	2,50	3,40	5,10
Power input cooling	Nominal (Min-Max)	kW	0,590 (0,240 - 0,760)	0,880 (0,240 - 1,160)	1,600 (0,255 - 1,820)
Annual electricity consumption (cooling) ²⁾		kWh/a	151	213	308
Heating capacity	Nominal (Min-Max)	kW	3,20 (0,85 - 4,60)	4,00 (0,85 - 5,10)	6,10 (0,90 - 7,10)
Heating capacity at -7°C	Nominal	kW	2,60	3,00	4,30
COP ¹⁾	Nominal	Energy Saving	3,72 (3,7 - 3,33) A	3,54 (3,7 - 3,29) B	3,33 (3,46 - 3,26) C
SCOP	Nominal	Energy Saving	4,20 A+	3,80 A	3,90 A
Pdesign at -10°C		kW	2,60	2,90	4,00
Power input heating	Nominal (Min-Max)	kW	0,860 (0,230 - 1,380)	1,130 (0,230 - 1,550)	1,830 (0,260 - 2,180)
Annual electricity consumption (heating) ²⁾		kWh/a	867	1.068	1.436
Indoor Unit					
Power source		V	230	230	230
Recommended fuse		A	16	16	16
Recommended power cable section		mm ²	1,5	1,5	1,5
Connection		mm ²	4 x 1,5 to 2,5	4 x 1,5 to 2,5	4 x 1,5 to 2,5
Current (Nominal)	Cooling / Heating	A	2,80 / 4,00	4,10 / 5,15	7,30 / 8,30
External static pressure ³⁾	S-Hi / Hi / Me / Lo	Pa	N/A	N/A	N/A
Air volume	Cooling / Heating	m ³ /h	414 / 486	558 / 624	918 / 918
Moisture removal volume		l/h	1,50	2,30	2,80
Sound pressure level ⁴⁾	Cooling — Heating (Hi / Lo / S-Lo)	dB(A)	33 / 27 / 24 — 35 / 28 / 25	34 / 27 / 24 — 36 / 28 / 25	41 / 30 / 27 — 41 / 32 / 29
Sound power level	Cooling / Heating (Hi)	dB	49 / 51	50 / 52	57 / 57
Dimensions / Net weight	H x W x D	mm / kg	235 x 750 x 370 / 17	235 x 750 x 370 / 17	200 x 750 x 640 / 19
Dust filter			No	No	
Outdoor Unit					
Power source		V	230	230	230
Air volume	Cooling/Heating	m ³ /h	1.878 / 1.782	2.160 / 1.944	2.352 / 2.352
Sound pressure level ⁴⁾	Cooling / Heating (Hi)	dB(A)	47 / 47	47 / 48	47 / 48
Sound power level	Cooling / Heating (Hi)	dB	62 / 62	62 / 63	61 / 62
Dimensions ⁵⁾ / Net weight	H x W x D	mm / kg	622 x 824 x 299 / 36	695 x 875 x 320 / 45	695 x 875 x 320 / 47
Piping connections	Liquid / Gas pipe	Inch (mm)	1/4 (6,35) / 3/8 (9,52)	1/4 (6,35) / 3/8 (9,52)	1/4 (6,35) / 1/2 (12,70)
Refrigerant loading	R410A	kg	1,10	1,14	1,23
Elevation difference (in/out)	Max	m	15	15	20
Piping length	Min / Max	m	3 / 20	3 / 20	3 / 30
Precharge length	Max	m	7,5	7,5	10
Additional charge		g/m	20	20	20
Operating range	Cooling Min/Max	°C	-10 / +43	-10 / +43	-10 / +43
	Heating Min/Max	°C	-10 / +24	-10 / +24	-10 / +24

Rating Conditions: Cooling Indoor 27 °C DB / 19 °C WB. Cooling Outdoor 35 °C DB / 24 °C WB. Heating Indoor 20 °C DB. Heating Outdoor 7 °C DB / 6 °C WB. (DB: Dry Bulb; WB: Wet Bulb)

1) EER and COP classification is at 230 V in accordance with EU directive 2002/31/EC. 2) The annual energy consumption is calculated in accordance with the ErP directive. 3) The specification listed on the table indicates values under the condition of 29 Pa (3,0 mmAq) which are applied for factory default setting. Change switch on PCB from Hi to Shi to have more than 6,0 mmAq. 4) The Sound pressure level of the units shows the value measured of a position of 1.5 m below the unit with 1 m duct on the suction side and 2 m duct on the discharge side. The sound pressure is measured in accordance with Eurovent 6/C/006-97 specification. 5) Add 100 mm for indoor unit or 70 mm for outdoor unit for piping port. Specifications subject to change without notice. For detailed information about ErP, please visit our websites www.aircon.panasonic.co.uk or www.ptc.panasonic.eu.

Internet Control Ready

INTERNET CONTROL

Energy saving

INVERTER

5,80 A+ SEER

SEASONAL ENERGY EFFICIENCY RATIO

4,20 A+ SCOP

SEASONAL COEFFICIENT OF PERFORMANCE

Selectable static pressure up to 7 mmAq

STATIC PRESSURE

Down to -10°C in cooling mode

OUTDOOR TEMPERATURE

Down to -10°C in heating mode

OUTDOOR TEMPERATURE

Easy control by BMS

CONNECTIVITY

Possible to use on R22 pipings

R22 RENEWAL

5 year compressor warranty

INTERNET CONTROL READY: Optional. SEER and SCOP: For KIT-E9-PD3EA. 5 YEARS COMPRESSOR WARRANTY: Only for PRO partners.

FLOOR CONSOLE TYPE INVERTER+



Included



CU-E9PFE
CU-E12PFE

CU-E18PFE



Console designed for discreet integration on walls, and for high performance, specifically in heat mode even when the outside temperature is as low as -20 °C.

Double airflow for improved comfort and temperature dispersion: through the top for an efficient cooling mode, through the bottom for quick heating.

Technical focus

- This units can be installed on R22 pipings
- More efficient than ever for improved energy consumption and higher savings
- Heating mode down to -20 °C with high efficiency
- Double airflow for better efficiency
- Powerful mode for quick temperature setting
- R410A refrigerant gas

KIT			KIT-E9-PFE	KIT-E12-PFE	KIT-E18-PFE
Indoor			CS-E9GFEW	CS-E12GFEW	CS-E18GFEW
Outdoor			CU-E9PFE	CU-E12PFE	CU-E18PFE
Cooling capacity	Nominal (Min - Max)	kW	2,50 (0,85 - 3,00)	3,50 (0,85 - 3,80)	5,00 (0,98 - 5,60)
EER ¹⁾	Nominal	Energy Saving	4,50 A	3,72 A	3,25 A
SEER	Nominal	Energy Saving	6,10 A++	5,80 A+	6,20 A++
Pdesign (cooling)		kW	2,50	3,50	5,00
Power input cooling	Nominal	kW	0,560	0,940	1,540
Annual electricity consumption (cooling) ²⁾		kWh/a	143	211	282
Heating capacity	Nominal (Min - Max)	kW	3,40 (0,85 - 5,00)	4,00 (0,85 - 6,00)	5,80 (0,98 - 7,10)
Heating capacity at -7 °C	Nominal	kW	2,35	2,86	3,87
COP ¹⁾	Nominal	Energy Saving	4,20 A	4,00 A	3,63 A
SCOP	Nominal	Energy Saving	3,80 A	3,80 A	3,90 A
Pdesign at -10 °C		kW	2,7	3,2	4,4
Power input heating	Nominal	kW	0,810	1,000	1,600
Annual electricity consumption (heating) ²⁾		kWh/a	995	1.179	1.579
Indoor Unit					
Power source		V	230	230	230
Recommended fuse		A	16	16	16
Recommended power cable section		mm ²	1,5	1,5	1,5
Connection		mm ²	4 x 1,5	4 x 1,5	4 x 1,5
Current (Nominal)	Cooling / Heating	A	2,60 / 3,75	4,40 / 4,60	7,20 / 7,50
Air volume	Cooling / Heating	m ³ /h	558 / 576	570 / 600	660 / 780
Moisture removal volume		l/h	1,4	2,0	2,8
Sound pressure level ³⁾	Cooling — Heating (Hi / Lo / S-Lo)	dB(A)	38 / 27 / 23 — 38 / 27 / 23	39 / 28 / 24 — 39 / 27 / 23	44 / 36 / 32 — 46 / 36 / 32
Sound power level	Cooling / Heating (Hi)	dB	54 / 54	55 / 55	60 / 62
Dimensions / Net weight	H x W x D	mm / kg	600 x 700 x 210 / 14	600 x 700 x 210 / 14	600 x 700 x 210 / 14
Outdoor Unit					
Air volume	Cooling / Heating	m ³ /h	1.788 / 1.788	1.998 / 1.998	2.352 / 2.274
Sound pressure level ³⁾	Cooling / Heating (Hi)	dB(A)	46 / 47	48 / 50	47 / 48
Sound power level	Cooling / Heating (Hi)	dB	61 / 62	63 / 65	61 / 62
Dimensions ⁴⁾ / Net weight	H x W x D	mm / kg	542 x 780 x 289 / 33	619 x 824 x 299 / 34	695 x 875 x 320 / 46
Piping connections	Liquid pipe / Gas pipe	inch (mm)	1/4 (6,35) / 3/8 (9,52)	1/4 (6,35) / 3/8 (9,52)	1/4 (6,35) / 1/2 (12,70)
Refrigerant loading	R410A	kg	0,970	1,000	1,120
Elevation difference (in/out)	Max	m	5	5	15
Piping length	Min / Max	m	3 / 15	3 / 15	3 / 20
Precharge length	Max	m	7,5	7,5	7,5
Additional charge		g/m	20	20	20
Operating range	Cooling Min / Max	°C	+16 / +43	+16 / +43	+16 / +43
	Heating Min / Max	°C	-15 / +24	-15 / +24	-15 / +24

Rating Conditions: Cooling Indoor 27 °C DB / 19 °C WB. Cooling Outdoor 35 °C DB / 24 °C WB. Heating Indoor 20 °C DB. Heating Outdoor 7 °C DB / 6 °C WB. (DB: Dry Bulb; WB: Wet Bulb)

1) EER and COP classification is at 230 V in accordance with EU directive 2002/31/EC. 2) The annual energy consumption is calculated in accordance with the ErP directive. 3) The Sound pressure level of the units shows the value measured of a position 1 metre in front of the main body and 1 m below the unit. The sound pressure is measured in accordance with Eurovent 6/C/006-97 specification. 4) Add 70 mm for piping port.

Specifications subject to change without notice. For detailed information about ErP, please visit our websites www.aircon.panasonic.co.uk or www.ptc.panasonic.eu.

Internet Control Ready	Energy saving	6,20 A++ SEER	3,90 A SCOP	Silent air 23 dB(A)	Down to -15°C in heating mode	Possible to use on R22 pipings	5 year compressor warranty
INTERNET CONTROL	INVERTER+	SEASONAL ENERGY EFFICIENCY RATIO	SEASONAL COEFFICIENT OF PERFORMANCE	SUPER QUIET	OUTDOOR TEMPERATURE	R22 RENEWAL	

INTERNET CONTROL READY: Optional. SEER and SCOP: For Kit-E18-PFE.

FREE MULTI SYSTEM

Up to 5 indoor units with a single outdoor unit

Connect up to five different rooms with a single outdoor unit using the Free Multi system.

With Free Multi you can take care of 2, 3, 4 or 5 rooms with a single outdoor unit.







With the Free Multi range, your clients will be able to save space at the time of installing the outdoor unit, and they will have more energy efficiency than with conventional 1x1 systems. They will be able to achieve energy savings of up to 30%.

Choose the indoor units according to the individual requirements of each of your client's rooms, and calculate which outdoor unit best adapts itself to the combinations of indoor units.

The combination table will help you to select the best option.

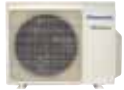
Internet Control Ready INTERNET CONTROL	Energy saving INVERTER+	7,00 A++ SEER SEASONAL ENERGY EFFICIENCY RATIO	4,00 A+ SCOP SEASONAL COEFFICIENT OF PERFORMANCE	Down to -15°C in heating mode OUTDOOR TEMPERATURE	Down to -10°C in cooling mode OUTDOOR TEMPERATURE	Easy control by BMS CONNECTIVITY	Dry contact with additional PCB:PAW-AC-DIO SIMPLE CONNECTION	Possible to use on R22 pipings R22 RENEWAL	5 year compressor warranty
---	-----------------------------------	--	--	---	---	--	--	--	-----------------------------------

INTERNET CONTROL READY: Optional for Ethera, Wall Mounted RE, Floor Console, Low Static Pressure Hide Away (CS-E9PD3EA and CS-E12PD3EA) and 4 Way 60x60 Cassette (CS-E9PB4EA and CS-E12PB4EA). EASY CONTROL by BMS: Optional only for Ethera, Low Static Pressure Hide Away (CS-E9PD3EA and CS-E12PD3EA) and 4 Way 60x60 Cassette (CS-E9PB4EA and CS-E12PB4EA). DRY CONTACT WITH ADDITIONAL PCB:PAW-AC-DIO:For Wall Mounted RE. 5 YEARS COMPRESSOR WARRANTY: Only for PRO partners.

Possible outdoor/indoor units combinations																			
Models	Capacity connected (Min-Max)	Piping connections		Pipe length					Capacity combinations	Indoor Unit Capacities									
		Liquid pipe (Inch)	Gas pipe (Inch)	Max. pipe length (1 room)	Max. pipe length (total)	Precharge length	Additional charge	Elevation difference (in/out)		5 1,6 kW	7 2,0 kW	9 2,5 kW	9 2,8 kW	12 3,2 kW	15 4,0 kW	18 5,0 kW	21 6,8 kW	24 7,1 kW	
2 ROOMS	CU-2E15PBE 	3,2-5,6 kW	1/4	3/8	20 m	30 m	20 m	15 g/m	10 m	For 2 indoor units	✓	✓	✓	✓	✓				
	CU-2E18PBE 	3,2-6,4 kW	1/4	3/8	20 m	30 m	20 m	15 g/m	10 m	For 2 indoor units	✓	✓	✓	✓	✓				
3 ROOMS	CU-3E18PBE 	4,5-9,0 kW	1/4	3/8	25 m	50 m	30 m	20 g/m	15 m	For 3 indoor units	✓	✓	✓	✓	✓	✓	✓		
4 ROOMS	CU-4E23PBE 	4,5-11,0 kW	1/4	3/8	25 m	60 m	30 m	20 g/m	15 m	For 4 indoor units	✓	✓	✓	✓	✓	✓	✓	✓	
	CU-4E27PBE 	4,5-13,6 kW	1/4	3/8	25 m	70 m	45 m	20 g/m	15 m	For 4 indoor units	✓	✓	✓	✓	✓	✓	✓	✓	✓
5 ROOMS	CU-5E34PBE 	4,5-17,5 kW	1/4	3/8	25 m	80 m	45 m	20 g/m	15 m	For 5 indoor units	✓	✓	✓	✓	✓	✓	✓	✓	✓

1) At least two indoor units must be connected.

2) The total nominal cooling capacity of indoor units that will be connected to outdoor unit must be within connectable capacity range of indoor unit.



Indoor Unit Capacities					
Capacity	Split Etherea	Split RE	Floor Console	Low Static Pressure Hide Away	4 Way 60x60 Cassette
5 - 1,6 kW	CS-ME5PKE				
7 - 2,0 kW	CS-XE7QKEW / CS-E7QKEW	CS-MRE7RKE			
9 - 2,5 kW (9 - 2,8 kW for Floor Console only)	CS-XE9QKEW / CS-E9QKEW	CS-RE9RKEW	CS-E9GFEW	CS-E9PD3EA	CS-E9PB4EA
12 - 3,2 kW	CS-XE12QKEW / CS-E12QKEW	CS-RE12RKEW	CS-E12GFEW	CS-E12D3EAW ¹⁾	CS-E12PB4EA ¹⁾
15 - 4,0 kW	CS-E15QKEW ¹⁾				
18 - 5,0 kW	CS-XE18QKEW ¹⁾ / CS-E18QKEW ¹⁾	CS-RE18RKEW	CS-E18GFEW ¹⁾	CS-ME18PD3EA / CS-E18RD3EAW	CS-ME18PB4EA ¹⁾ / CS-E18RB4EAW ¹⁾
21 - 6,8 kW	CS-E21QKEW ¹⁾				CS-ME21PB4EA ¹⁾ / CS-E21RB4EAW ¹⁾
24 - 7,1 kW	CS-E24QKEW ¹⁾	CS-RE24RKEW			

1) A CZ-MA1P pipe reducer is needed on the E15 and E18, a CZ-MA2P pipe expander is needed on the E21. And a CZ-MA2P pipe expander plus a CZ-MA3P pipe reducer are needed on the E24. * At least two indoor units must be connected.

Outdoor Units for Free Multi combinations



Outdoor Unit // Inverter+		3,2 to 5,6 kW	3,2 to 6,4 kW	4,5 to 9,0 kW	4,5 to 11,0 kW	4,5 to 13,6 kW	4,5 to 17,5 kW
Unit		CU-2E15PBE	CU-2E18PBE	CU-3E18PBE	CU-4E23PBE	CU-4E27PBE	CU-5E34PBE
Cooling capacity	Nominal (Min - Max)	kW 4,50 (1,50 - 5,20)	5,20 (1,50 - 5,40)	5,20 (1,80-7,30)	6,80 (1,90 - 8,80)	8,00 (3,00 - 9,20)	10,00 (2,9 - 11,5)
	Nominal (Min - Max)	kCal/h 3.870 (1.290 - 4.470)	4.472 (1.290 - 4.644)	4.470 (1.548-6.278)	5.850 (1.630 - 7.570)	6.880 (2.580 - 7.912)	8.600 (2.494 - 9.890)
EER	Nominal	W/W 3.66 (6.00 - 3.42) A	3.42 (6.00 - 3.42) A	4.33 (5.00 - 3.35) A	4.05 (5.59 - 3.56) A	4.04 (5.66 - 3.21) A	3.5 (5.27 - 2.98) A
SEER	Nominal	W/W 6,50 A++	6,50 A++	7,00 A++	7,00 A++	7,00 A++	6,50 A++
Pdesign (cooling)		4,50	5,20	5,20	6,80	8,00	10,00
Power input cooling	Nominal (Min - Max)	kW 1,230 (0,250 - 1,520)	1,490 (0,250 - 1,540)	1,210 (0,360-2,180)	1,680 (0,340 - 2,470)	1,980 (0,530 - 2,870)	2,860 (0,550 - 3,860)
Annual electricity consumption (cooling)		kWh/a 242	280	260	340	400	538
Heating capacity	Nominal (Min - Max)	kW 5,40 (1,10 - 7,00)	5,60 (1,10 - 7,20)	6,80 (1,60-8,30)	8,50 (3,00 - 10,60)	9,40 (4,20 - 10,60)	12,00 (3,40 - 14,50)
	Nominal (Min - Max)	kCal/h 4.640 (950 - 6.020)	4.820 (950 - 6.190)	4.820 (1.200-7.140)	7.130 (2.580 - 9.120)	8.084 (3.612 - 9.116)	10.320 (2.924 - 12.470)
Heating capacity at -7 °C	Nominal	kW 3,54	3,65	4,90	6,05	7,08	8,85
COP	Nominal	W/W 4.62 (5.24 - 4.19) A	4.63 (4.24 - 5.24) A	4.69 (3.93 - 5.00) A	4.47 (4.08 - 5.17) A	4.52 (6.00 - 3.46) A	4.20 (6.42 - 3.42) A
SCOP	Nominal	W/W 4,00 A+	4,00 A+	4,00 A+	4,00 A+	4,00 A+	4,00 A+
Pdesign at -10 °C		kW 4,00	3,80	4,80	5,50	8,00	10,00
Power input heating	Nominal (Min - Max)	kW 1,170 (0,210 - 1,670)	1,300 (0,240 - 1,700)	1,450 (0,320 - 2,110)	1,850 (0,580 - 2,600)	2,080 (0,700 - 3,060)	2,860 (0,530 - 4,240)
Annual electricity consumption (heating)		kWh/a 1.400	1.330	1.680	1.925	2.800	3.500
Current	Cooling / Heating	A 5,75 / 5,20	7,10 / 5,35	5,30 / 6,70	7,50 / 8,80	9,40 / 9,80	13,20 / 13,40
Power source		V 230	230	230	230	230	230
Recommended fuse		A 16	16	16	20	20	25
Recommended power cable section		mm ² 1,5	1,5	2,5	2,5	2,5	3,5
Sound pressure level ¹⁾	Cooling / Heating (Hi)	dB(A) 47 / 49	49 / 51	46 / 47	48 / 49	51 / 52	53 / 54
	Cooling / Heating (Hi)	dB 62 / 64	64 / 66	60 / 61	62 / 63	67 / 68	69 / 70
Dimensions / Net weight	H x W x D	mm / kg 619 x 824 (+70) x 299 / 39	619 x 824 x 229 / 39	795 x 875 (+95) x 320 / 71	795 x 875 (+95) x 320 / 72	999 x 940 x 340 / 80	999 x 940 x 340 / 81
Piping connections	Liquid / Gas pipe	inch (mm) 1/4 (6,35) / 3/8 (9,52)	1/4 (6,35) / 3/8 (9,52)	1/4 (6,35) / 3/8 (9,52)	1/4 (6,35) / 3/8 (9,52)	1/4 (6,35) / 3/8 (9,52)	1/4 (6,35) / 3/8 (9,52)
Refrigerant / Additional charge	R410A	kg / g/m 1,40 / 15	1,40 / 15	2,64 / 20	2,64 / 20	3,4 / 20	3,4 / 20
Elevation difference (in/out)	Max	m 10	10	15	15	15	15
Piping length total — to one unit	Min / Max	m 3 / 30 — 3 / 20	3 / 30 — 3 / 20	3 / 50 — 3 / 25	- / 60 — 3 / 25	- / 80 — 3 / 25	- / 80 — 3 / 25
Precharge length	Max	m 20	20	30	30	45	45
Operating range	Cooling Min / Max	°C -10 / +46	-10 / +46	-10 / +46	-10 / +46	-10 / +46	-10 / +46
	Heating Min / Max	°C -15 / +24	-15 / +24	-15 / +24	-15 / +24	-15 / +24	-15 / +24

Minimum quantity of connection: 2 indoor units. For detailed information about ErP, please visit our websites www.aircon.panasonic.co.uk or www.ptc.panasonic.eu

Indoor Units for Free Multi combinations



Etherea // Silver or White			1,6 kW	2,0 kW	2,5 kW	3,2 kW	4,0 kW	5,0 kW	6,0 kW	7,1 kW
Silver Indoor			—	CS-XE7QKEW	CS-XE9QKEW	CS-XE12QKEW	—	CS-XE18QKEW	—	—
White Indoor			CS-ME5PKE*	CS-E7QKEW	CS-E9QKEW	CS-E12QKEW	CS-E15QKEW	CS-E18QKEW	CS-E21QKEW	CS-E24QKEW
Cooling capacity	Nominal	kW / kCal/h	1,6 / 1.380	2,00 / 1.720	2,50 / 2.150	3,20 / 2.750	4,00 / 3.440	5,00 / 4.300	6,00 / 5.160	7,00 / 6.580
Heating capacity	Nominal	kW / kCal/h	2,6 / 2.240	3,20 / 2.750	3,60 / 3.010	4,50 / 3.870	5,60 / 4.820	6,80 / 5.850	8,50 / 7.310	8,70 / 8.260
Connection		mm ²	4 x 1,5	4 x 1,5	4 x 1,5	4 x 1,5	4 x 1,5	4 x 1,5	4 x 1,5	4 x 1,5
Sound pressure level ¹	Cooling (Hi / Lo / S-Lo)	dB(A)	39 / 29 / 23	40 / 26 / 23	40 / 26 / 23	44 / 32 / 26	44 / 32 / 26	46 / 33 / 30	46 / 33 / 30	49 / 38 / 35
	Heating (Hi / Lo / S-Lo)	dB(A)	39 / 29 / 23	40 / 26 / 23	40 / 26 / 23	44 / 32 / 26	44 / 33 / 32	46 / 35 / 32	46 / 35 / 32	48 / 38 / 35
Sound power level	Cooling (Hi)	dB	55	54	56	60	60	62	62	65
	Heating (Hi)	dB	55	56	56	60	60	62	62	64
Dimensions	H x W x D	mm	295 x 870 x 255	295 x 870 x 255	295 x 870 x 255	295 x 870 x 255	295 x 870 x 255	290 x 1.070 x 255	290 x 1.070 x 255	290 x 1.070 x 255
Net weight		kg	9	9	9	9	9	12	12	12
Piping connections	Liquid pipe / Gas pipe	inch (mm)	1/4 (6,35) / 3/8 (9,52)	1/4 (6,35) / 3/8 (9,52)	1/4 (6,35) / 3/8 (9,52)	1/4 (6,35) / 3/8 (9,52)	1/4 (6,35) / 1/2 (12,70)	1/4 (6,35) / 1/2 (12,70)	1/4 (6,35) / 1/2 (12,70)	1/4 (6,35) / 5/8 (15,88)

* NEW also for the 4x1 and 5x1.

Wall Mounted RE Type Standard Inverter			2,5 kW	3,2 kW	5,0 kW	7,1 kW
Indoor			CS-RE9RKEW	CS-RE12RKEW	CS-RE18RKEW	CS-RE24RKEW
Cooling capacity	Nominal	kW / kCal/h	2,50 / 2.150	3,20 / 2.750	5,00 / 4.300	7,00 / 6.580
Heating capacity	Nominal	kW / kCal/h	3,60 / 3.010	4,50 / 3.870	6,80 / 5.850	8,70 / 8.260
Connection		mm ²	4 x 1,5	4 x 1,5	4 x 1,5	4 x 1,5
Sound pressure level ¹	Cooling (Hi / Lo / Q-Lo)	dB(A)	43 / 28 / 24	44 / 32 / 24		
	Heating (Hi / Lo / Q-Lo)	dB(A)	43 / 29 / 26	44 / 35 / 27		
Sound power level	Cooling (Hi)	dB	59	60		
	Heating (Hi)	dB	59	60		
Dimensions	H x W x D	mm	290 x 870 x 214	290 x 870 x 214	290 x 1.070 x 240	290 x 1.070 x 240
Net weight		kg	9	9	12	12
Piping connections	Liquid pipe / Gas pipe	inch (mm)	1/4 (6,35) / 3/8 (9,52)	1/4 (6,35) / 3/8 (9,52)	1/4 (6,35) / 1/2 (12,70)	1/4 (6,35) / 5/8 (15,88)

Floor Console			2,8 kW	3,2 kW	5,0 kW	2,5 kW	3,2 kW	5,0 kW	5,0 kW
Indoor			CS-E9GFEW	CS-E12GFEW	CS-E18GFEW*	CS-E9PD3EA	CS-E12QD3EAW	CS-ME18PD3EA	CS-E18RD3EAW
Cooling capacity	Nominal	kW / kCal/h	2,80 / 2.410	3,20 / 2.750	5,00 / 4.300	2,50 / 2.150	3,4 / 2.920	5,00 / 4.300	5,10
Heating capacity	Nominal	kW / kCal/h	4,00 / 3.440	4,50 / 3.870	6,80 / 5.850	3,20 / 2.752	4,00 / 3.440	6,80 / 5.850	6,10
Connection		mm ²	4 x 1,5	4 x 1,5	4 x 1,5	4 x 1,5 to 2,5	4 x 1,5 to 2,5	4 x 1,5	4 x 1,5 to 2,5
External static pressure ²	S-Hi / Hi / Me / Lo	Pa				N/A	N/A	N/A	N/A
Sound pressure level ¹	Cooling (Hi / Lo / S-Lo)	dB(A)	38 / 27 / 23	39 / 28 / 24	44 / 36 / 32	33 / 27 / 24	34 / 27 / 24	27 / 30 / 41	41 / 30 / 27
	Heating (Hi / Lo / S-Lo)	dB(A)	38 / 27 / 23	39 / 27 / 23	46 / 36 / 32	35 / 28 / 25	36 / 28 / 25	29 / 32 / 41	41 / 32 / 29
Sound power level	Cooling (Hi)	dB	54	55	60	49	49	57	57
	Heating (Hi)	dB	54	55	62	51	51	57	57
Dimensions	H x W x D	mm	600 x 700 x 210	600 x 700 x 210	600 x 700 x 210 ¹	235 x 750 x 370	235 x 750 x 370	285 x 750 (+65) x 370	200 x 750 x 640
Net weight		kg	14	14	14	17	17	18	19
Piping connections	Liquid pipe / Gas pipe	inch (mm)	1/4 (6,35) / 3/8 (9,52)	1/4 (6,35) / 3/8 (9,52)	1/4 (6,35) / 1/2 (12,70)	1/4 (6,35) / 3/8 (9,52)	1/4 (6,35) / 3/8 (9,52)	1/4 (6,35) / 1/2 (12,70)	1/4 (6,35) / 1/2 (12,70)

* Available June 2015. Tentative.

4 Way 60x60 Cassette			2,5 kW	3,2 kW	5,0 kW	6,0 kW	5,0 kW	6,0 kW
Indoor			CS-E9PB4EA	CS-E12PB4EA	CS-ME18PB4EA	CS-ME21PB4EA	CS-E18RB4EAW	CS-E21RB4EAW
Cooling capacity	Nominal	kW / kCal/h	2,50 / 2.150	3,40 / 2.920	5,00 / 4.300	6,00 / 5.160	5,00 / 4.300	5,90 / 5.070
Heating capacity	Nominal	kW / kCal/h	3,20 / 2.752	4,50 / 3.870	6,80 / 5.850	8,50 / 7.310	5,60 / 4.820	7,00 / 6.020
Connection		mm ²	4 x 1,5 to 2,5	4 x 1,5 to 2,5	4 x 1,5	4 x 1,5	4 x 1,5 to 2,5	4 x 1,5 to 2,5
Sound pressure level ¹	Cooling (Hi / Lo / S-Lo)	dB(A)	34 / 26 / 23	34 / 26 / 23	36 / 28 / 25	37 / 28 / 25	37 / 28 / 25	42 / 33 / 30
	Heating (Hi / Lo / S-Lo)	dB(A)	35 / 28 / 25	35 / 28 / 25	37 / 29 / 26	42 / 34 / 31	38 / 29 / 26	43 / 34 / 31
Sound power level	Cooling / Heating (Hi)	dB	50 / 51	50 / 51	49 / 50	54 / 55	53 / 54	58 / 59
	Dimensions (H x W x D) / Net weight	Indoor	mm / kg	260 x 575 x 575 / 18	260 x 575 x 575 / 18	260 x 575 x 575 / 18	260 x 575 x 575 / 18	260 x 575 x 575 / 18
	Panel (CZ-BT20E)	mm / kg	51 x 700 x 700 / 2,5	51 x 700 x 700 / 2,5	51 x 700 x 700 / 2,5	51 x 700 x 700 / 2,5	51 x 700 x 700 / 2,5	51 x 700 x 700 / 2,5
Piping connections	Liquid pipe / Gas pipe	Inch (mm)	1/4 (6,35) / 3/8 (9,52)	1/4 (6,35) / 1/2 (12,70)	1/4 (6,35) / 1/2 (12,70)	1/4 (6,35) / 1/2 (12,70)	1/4 (6,35) / 1/2 (12,70)	1/4 (6,35) / 1/2 (12,70)

Outdoor Multi combination model	Accessory needed
CS-XE7*** // CS-E7*** // CS-XE9*** // CS-E9*** // CS-XE12*** // CS-E12***	CU-2E15*** // CU-2E18*** // CU-3E18*** // CU-4E23*** // CU-4E27*** // CU-5E34***
CS-E15*** // CS-XE18*** // CS-E18***	CU-3E18*** // CU-4E23*** // CU-4E27*** // CU-5E34***
CS-E21***	CU-4E23*** // CU-4E27*** // CU-5E34***
CS-E24***	CU-4E27*** // CU-5E34***



CZ-MA1P is to be used to reduce the connection size on the indoor unit from 1/2" to 3/8".
 CZ-MA2P is to be used to increase the connection size on the outdoor unit from 3/8" to 1/2".
 CZ-MA3P is to be used to reduce the connection size on the indoor unit from 5/8" to 1/2".

Rating Conditions: Cooling Indoor 27 °C DB / 19 °C WB. Cooling Outdoor 35 °C DB / 24 °C WB. Heating Indoor 20 °C DB. Heating Outdoor 7 °C DB / 6 °C WB. (DB: Dry Bulb; WB: Wet Bulb)

1) The Sound pressure level of the units shows the value measured at a position 1 metre in front of the main body. The sound pressure is measured in accordance with Eurovent 6/C/006-97 specification. 2) The specification listed on the table indicates values under the condition of 29 Pa (3,0 mmAq) which are applied for factory default setting. Change switch on PCB from Hi to S-Hi to have more than 6,0 mmAq. Specifications subject to change without notice.

Free Multi combinations table

Free Multi 2x1

Free Multi 2x1 CU-2E15PBE. Minimum capacity connected: 3,2 kW. Maximum capacity connected: 5,6 kW

Indoor unit capacity	Cooling capacity (kW)			EER	Current	Heating capacity (kW)			COP	Current
	Room A	Room B	Total (Min - Max)			W/W	230V (A)	Room A		
1 Room										
5	1.60		1.60 (1.10 - 2.30)	3.90 A	1.95	2.60		2.60 (0.70 - 3.80)	3.77 A	3.05
7	2.00		2.00 (1.10 - 2.90)	3.85 A	2.45	3.20		3.20 (0.70 - 4.80)	3.76 A	3.75
9 ¹	2.50		2.50 (1.10 - 3.50)	3.73 A	3.15	3.60		3.60 (0.70 - 5.50)	3.50 B	4.55
9 ²	2.80		2.80 (1.10 - 3.50)	3.73 A	3.50	4.00		4.00 (0.70 - 5.50)	3.48 B	5.10
12	3.20		3.20 (1.10 - 4.00)	3.48 A	4.30	4.50		4.50 (0.70 - 6.20)	3.60 B	5.55
2 Rooms										
5 + 5	1.60	1.60	3.20 (1.50 - 4.00)	3.76 A	4.00	2.60	2.60	5.40 (1.10 - 7.00)	4.60 A	5.00
5 + 7	1.60	2.00	3.60 (1.50 - 4.50)	3.71 A	4.55	2.40	3.00	5.40 (1.10 - 7.00)	4.58 A	5.25
5 + 9 ¹	1.60	2.50	4.10 (1.50 - 5.10)	3.63 A	5.30	2.11	3.29	5.40 (1.10 - 7.00)	4.58 A	5.25
5 + 9 ²	1.60	2.80	4.40 (1.50 - 5.20)	3.61 A	5.70	1.96	3.44	5.40 (1.10 - 7.00)	4.58 A	5.25
5 + 12	1.60	3.00	4.50 (1.50 - 5.20)	3.66 A	5.75	1.80	3.60	5.40 (1.10 - 7.00)	4.58 A	5.25
7 + 7	2.00	2.00	4.00 (1.50 - 5.00)	3.67 A	5.10	2.70	2.70	5.40 (1.10 - 7.00)	4.62 A	5.20
7 + 9 ¹	2.00	2.50	4.50 (1.50 - 5.20)	3.66 A	5.75	2.40	3.00	5.40 (1.10 - 7.00)	4.62 A	5.20
7 + 9 ²	1.85	2.65	4.50 (1.50 - 5.20)	3.66 A	5.75	2.25	3.15	5.40 (1.10 - 7.00)	4.62 A	5.20
7 + 12	1.75	2.75	4.50 (1.50 - 5.20)	3.66 A	5.75	2.10	3.30	5.40 (1.10 - 7.00)	4.62 A	5.20
9 ¹ + 9 ¹	2.25	2.25	4.50 (1.50 - 5.20)	3.66 A	5.75	2.70	2.70	5.40 (1.10 - 7.00)	4.62 A	5.20
9 ¹ + 9 ²	2.10	2.40	4.50 (1.50 - 5.20)	3.66 A	5.75	2.55	2.85	5.40 (1.10 - 7.00)	4.62 A	5.20
9 ² + 9 ²	2.25	2.25	4.50 (1.50 - 5.20)	3.66 A	5.75	2.70	2.70	5.40 (1.10 - 7.00)	4.62 A	5.20

Free Multi 2x1 CU-2E18PBE. Minimum capacity connected: 3,2 kW. Maximum capacity connected: 6,4 kW

Indoor unit capacity	Cooling capacity (kW)			EER	Current	Heating capacity (kW)			COP	Current
	Room A	Room B	Total (Min - Max)			W/W	230V (A)	Room A		
1 Room										
5	1.60		1.60 (1.10 - 2.30)	3.90 A	1.95	2.60		2.60 (0.70 - 3.80)	3.77 A	3.05
7	2.00		2.00 (1.10 - 2.90)	3.85 A	2.45	3.20		3.20 (0.70 - 4.80)	3.76 A	3.75
9 ¹	2.50		2.50 (1.10 - 3.50)	3.73 A	3.15	3.60		3.60 (0.70 - 5.50)	3.50 B	4.55
9 ²	2.80		2.80 (1.10 - 3.50)	3.73 A	3.50	4.00		4.00 (0.70 - 5.50)	3.48 B	5.10
12	3.20		3.20 (1.10 - 4.00)	3.48 A	4.30	4.50		4.50 (0.70 - 6.20)	3.60 B	5.55
2 Rooms										
5 + 5	1.60	1.60	3.20 (1.50 - 4.00)	3.76 A	4.00	2.60	2.60	5.40 (1.10 - 7.00)	4.60 A	5.00
5 + 7	1.60	2.00	3.60 (1.50 - 4.50)	3.71 A	4.55	2.40	3.00	5.40 (1.10 - 7.00)	4.58 A	5.25
5 + 9 ¹	1.60	2.50	4.10 (1.50 - 5.10)	3.63 A	5.30	2.11	3.29	5.40 (1.10 - 7.00)	4.58 A	5.25
5 + 9 ²	1.60	2.80	4.40 (1.50 - 5.20)	3.61 A	5.70	1.96	3.44	5.40 (1.10 - 7.00)	4.58 A	5.25
5 + 12	1.50	3.00	4.50 (1.50 - 5.20)	3.66 A	5.75	1.80	3.60	5.40 (1.10 - 7.00)	4.58 A	5.25
7 + 7	2.00	2.00	4.00 (1.50 - 5.00)	3.67 A	5.10	2.70	2.70	5.40 (1.10 - 7.00)	4.62 A	5.20
7 + 9 ¹	2.00	2.50	4.50 (1.50 - 5.20)	3.66 A	5.75	2.40	3.00	5.40 (1.10 - 7.00)	4.62 A	5.20
7 + 9 ²	1.85	2.65	4.50 (1.50 - 5.20)	3.66 A	5.75	2.25	3.15	5.40 (1.10 - 7.00)	4.62 A	5.20
7 + 12	2.00	3.20	4.80 (1.50 - 5.30)	3.62 A	7.10	2.15	3.45	5.40 (1.10 - 7.00)	4.63 A	5.35
9 ¹ + 9 ¹	2.50	2.50	4.80 (1.50 - 5.20)	3.67 A	6.70	2.80	2.80	5.40 (1.10 - 7.00)	4.63 A	5.35
9 ¹ + 9 ²	2.45	2.75	4.80 (1.50 - 5.20)	3.67 A	7.10	2.65	2.95	5.40 (1.10 - 7.00)	4.63 A	5.35
9 ² + 9 ²	2.30	2.90	5.00 (1.50 - 5.30)	3.62 A	7.10	2.45	3.15	5.40 (1.10 - 7.00)	4.63 A	5.35
9 ² + 9 ²	2.60	2.60	4.80 (1.50 - 5.20)	3.62 A	7.10	2.80	2.80	5.40 (1.10 - 7.00)	4.63 A	5.35
9 ² + 12	2.45	2.75	5.00 (1.50 - 5.30)	3.62 A	7.10	2.60	3.00	5.40 (1.10 - 7.00)	4.63 A	5.35
12 + 12	2.60	2.60	5.20 (1.50 - 5.40)	3.62 A	7.10	2.80	2.80	5.40 (1.10 - 7.00)	4.63 A	5.35

Free Multi 3x1

Free Multi 3x1 CU-3E18PBE. Minimum capacity connected: 4,5 kW. Maximum capacity connected: 9,0 kW

Indoor unit capacity	Cooling capacity (kW)				EER	Current	Heating capacity (kW)				COP	Current
	Room A	Room B	Room C	Total (Min - Max)			W/W	230V (A)	Room A	Room B		
1 Room												
5	1.60			1.60 (1.20 - 3.20)	4.00 A	2.00	2.60			2.60 (1.20 - 3.20)	4.33 A	3.00
7	2.00			2.00 (1.20 - 2.90)	4.00 A	2.50	3.20			3.20 (1.20 - 4.10)	4.32 A	3.70
9 ¹	2.50			2.50 (1.20 - 2.90)	3.97 A	3.00	3.60			3.60 (1.20 - 4.30)	3.83 A	4.50
9 ²	2.80			2.80 (1.20 - 2.90)	4.00 A	3.30	4.00			4.00 (1.20 - 4.30)	3.81 A	5.20
12	3.20			3.20 (1.20 - 3.80)	4.00 A	3.70	4.50			4.50 (1.20 - 5.80)	3.66 A	5.80
15	4.00			4.00 (1.20 - 4.30)	3.23 A	5.60	5.60			5.60 (1.20 - 6.80)	3.26 C	7.70
18	5.00			5.00 (1.20 - 5.70)	3.23 A	6.80	6.80			6.80 (1.20 - 6.90)	3.24 C	9.20
2 Rooms												
5 + 5	1.60	1.60		3.20 (1.80 - 6.20)	4.92 A	3.00	2.60	2.60		5.20 (1.40 - 7.00)	4.19 A	5.70
5 + 7	1.60	2.00		3.60 (1.80 - 6.20)	4.50 A	3.70	2.49	3.11		5.60 (1.40 - 7.00)	4.12 A	6.30
5 + 9 ¹	1.60	2.50		4.10 (1.80 - 6.20)	4.27 A	4.30	2.42	3.78		6.20 (1.40 - 7.00)	4.03 A	7.10
5 + 9 ²	1.60	2.80		4.40 (1.80 - 6.20)	4.00 A	4.90	2.33	4.07		6.40 (1.40 - 7.00)	3.98 A	7.40
5 + 12	1.60	3.20		4.80 (1.80 - 6.30)	3.72 A	5.70	2.13	4.27		6.40 (1.40 - 7.30)	4.10 A	7.20
5 + 15	1.49	3.71		5.20 (1.90 - 6.40)	3.51 A	6.50	1.94	4.86		6.80 (1.40 - 7.30)	4.05 A	7.80
5 + 18	1.26	3.94		5.20 (1.90 - 6.80)	4.06 A	5.60	1.65	5.15		6.80 (1.40 - 8.00)	4.42 A	7.10
7 + 7	2.00	2.00		4.00 (1.80 - 6.20)	4.30 A	4.20	2.90	2.90		5.80 (1.40 - 7.00)	4.20 A	6.40
7 + 9 ¹	2.00	2.50		4.50 (1.80 - 6.20)	3.95 A	5.10	2.84	3.56		6.40 (1.40 - 7.00)	4.00 A	7.40
7 + 9 ²	2.00	2.80		4.80 (1.80 - 6.20)	3.72 A	5.70	2.67	3.73		6.40 (1.40 - 7.00)	4.00 A	7.40
7 + 12	2.00	3.20		5.20 (1.80 - 6.30)	3.51 A	6.50	2.62	4.18		6.80 (1.40 - 7.30)	4.05 A	7.80
7 + 15	1.73	3.47		5.20 (1.90 - 6.40)	3.61 A	6.30	2.27	4.53		6.80 (1.40 - 7.30)	4.05 A	7.80
7 + 18	1.49	3.71		5.20 (1.90 - 6.80)	4.06 A	5.60	1.94	4.86		6.80 (1.40 - 8.00)	4.44 A	7.10
9 ¹ + 9 ¹	2.50	2.50		5.00 (1.80 - 6.20)	3.57 A	6.10	3.40	3.40		6.80 (1.40 - 7.00)	3.93 A	8.00
9 ¹ + 9 ²	2.45	2.75		5.20 (1.90 - 6.20)	3.42 A	6.70	3.21	3.59		6.80 (1.40 - 7.00)	3.93 A	8.00
9 ¹ + 12	2.28	2.92		5.20 (1.90 - 6.30)	3.51 A	6.50	2.98	3.82		6.80 (1.40 - 7.30)	4.05 A	7.80
9 ¹ + 15	2.00	3.20		5.20 (1.90 - 6.40)	3.61 A	6.30	2.62	4.18		6.80 (1.40 - 7.30)	4.05 A	7.80
9 ¹ + 18	1.73	3.47		5.20 (1.90 - 6.80)	4.06 A	5.60	2.27	4.53		6.80 (1.40 - 8.00)	4.44 A	7.10
9 ² + 9 ²	2.60	2.60		5.20 (1.90 - 6.20)	3.42 A	6.70	3.40	3.40		6.80 (1.40 - 7.00)	3.93 A	8.00
9 ² + 12	2.43	2.77		5.20 (1.90 - 6.30)	3.51 A	6.50	3.17	3.63		6.80 (1.40 - 7.30)	4.05 A	7.80
9 ² + 15	2.14	3.06		5.20 (1.90 - 6.40)	3.61 A	6.30	2.80	4.00		6.80 (1.40 - 7.30)	4.05 A	7.80
9 ² + 18	1.87	3.33		5.20 (1.90 - 6.80)	4.06 A	5.60	2.44	4.36		6.80 (1.40 - 8.00)	4.44 A	7.10
12 + 12	2.60	2.60		5.20 (1.90 - 6.40)	3.71 A	6.10	3.40	3.40		6.80 (1.40 - 7.50)	4.07 A	7.70
12 + 15	2.31	2.89		5.20 (1.90 - 6.50)	3.71 A	6.10	3.02	3.78		6.80 (1.40 - 7.50)	4.10 A	7.70
12 + 18	2.03	3.17		5.20 (1.90 - 6.90)	4.19 A	5.40	2.65	4.15		6.80 (1.40 - 8.00)	4.50 A	7.00
15 + 15	2.60	2.60		5.20 (1.90 - 6.50)	3.71 A	6.10	3.40	3.40		6.80 (1.40 - 7.60)	4.20 A	7.50
15 + 18	2.31	2.89		5.20 (1.90 - 6.90)	4.19 A	5.40	3.02	3.78		6.80 (1.40 - 8.00)	4.53 A	6.90
3 Rooms												
5 + 5 + 5	1.60	1.60	1.60	4.80 (1.80 - 7.20)	4.57 A	4.70	2.26	2.26	2.26	6.78 (1.50 - 8.10)	4.64 A	6.70
5 + 5 + 7	1.60	1.60	2.00	5.20 (1.80 - 7.30)	4.33 A	5.30	2.09	2.09	2.62	6.80 (1.60 - 8.30)	4.69 A	6.70
5 + 5 + 9 ¹	1.46	1.46	2.28	5.20 (1.90 - 7.20)	4.33 A	5.30	1.91	1.91	2.98	6.80 (1.60 - 8.30)	4.69 A	6.70
5 + 5 + 9 ²	1.39	1.39	2.42	5.20 (1.90 - 7.20)	4.33 A	5.30	1.81	1.81	3.18	6.80 (1.60 - 8.30)	4.69 A	6.70
5 + 5 + 12	1.30	1.30	2.60	5.20 (1.90 - 7.								

Free Multi combinations table

Free Multi 4x1

Free Multi 4x1 CU-4E23PBE. Minimum capacity connected: 4.5 kW. Maximum capacity connected: 11.0 kW																	
Indoor unit capacity	Cooling capacity (kW). Rooms				EER	Current	Heating capacity (kW). Rooms				COP	Current					
	Room A	Room B	Room C	Room D			Total (Min - Max)	W/W	230V (A)	Room A			Room B	Room C	Room D	Total (Min - Max)	W/W
1 Room																	
5	1.60				1.60 (1.30 - 2.30)	4.00 A	2.00					2.60			2.60 (1.20 - 3.20)	4.33 A	3.00
7	2.00				2.00 (1.80 - 2.90)	4.00 A	2.50					3.20			3.20 (1.20 - 4.10)	4.32 A	3.70
9 ¹	2.50				2.50 (1.80 - 2.90)	3.97 A	3.20					3.60			3.60 (1.20 - 4.30)	3.83 A	4.70
9 ²	2.80				2.80 (1.80 - 2.90)	4.00 A	3.50					4.00			4.00 (1.20 - 4.30)	3.81 A	5.20
12	3.20				3.20 (1.80 - 3.80)	4.00 A	3.90					4.50			4.50 (1.20 - 5.80)	3.66 A	6.00
15	4.00				4.00 (1.80 - 4.30)	3.23 A	5.00					5.60			5.60 (1.20 - 6.80)	3.26 A	8.00
18	5.00				5.00 (1.80 - 5.70)	3.23 A	7.20					6.80			6.80 (1.20 - 9.70)	3.24 A	9.70
21	6.00				6.00 (1.90 - 6.20)	2.96 A	9.20					8.50			8.50 (1.30 - 9.0)	3.54 B	11.10
2 Rooms																	
5+5	1.60	1.60			3.20 (1.90 - 6.40)	5.08 A	3.00	2.60	2.60			5.20			5.20 (2.70 - 9.80)	4.09 A	6.10
5+7	1.60	2.00			3.60 (1.90 - 6.40)	4.68 A	3.60	2.58	3.22			5.80			5.80 (2.70 - 9.80)	3.92 A	6.90
5+9 ¹	1.60	2.50			4.10 (1.90 - 6.40)	4.41 A	4.20	2.38	3.72			6.10			6.10 (2.70 - 9.80)	3.86 A	7.40
5+9 ²	1.60	2.80			4.40 (1.90 - 6.40)	4.11 A	4.80	2.22	3.88			6.10			6.10 (2.70 - 9.80)	3.86 A	7.40
5+12	1.60	3.20			4.80 (1.90 - 6.40)	3.87 A	5.50	2.13	4.27			6.40			6.40 (2.70 - 9.90)	3.95 A	7.50
5+15	1.60	4.00			5.60 (1.90 - 6.40)	3.33 A	6.50	2.29	5.71			8.00			8.00 (2.70 - 9.90)	3.60 A	10.20
5+18	1.60	5.00			6.60 (2.00 - 7.50)	3.24 A	9.00	2.06	6.44			8.50			8.50 (2.80 - 10.20)	3.76 A	10.40
5+21	1.43	5.27			6.80 (2.00 - 7.50)	3.12 A	9.60	1.79	6.71			8.50			8.50 (2.80 - 10.20)	3.76 A	10.40
7+7	2.00	2.00			4.00 (1.90 - 6.40)	4.44 A	1.00	2.90	2.90			5.80			5.80 (2.70 - 9.80)	4.03 A	6.70
7+9 ¹	2.00	2.50			4.50 (1.90 - 6.40)	4.09 A	2.90	2.71	3.39			6.10			6.10 (2.70 - 9.80)	3.89 A	7.30
7+9 ²	2.00	2.80			4.80 (1.90 - 6.40)	3.87 A	5.50	2.67	3.73			6.40			6.40 (2.70 - 9.80)	3.83 A	7.80
7+12	2.00	3.20			5.20 (1.90 - 6.40)	3.61 A	6.40	2.69	4.31			7.00			7.00 (2.70 - 9.90)	3.76 A	8.60
7+15	2.00	4.00			6.00 (1.90 - 6.40)	3.17 B	8.30	2.73	5.47			8.20			8.20 (2.70 - 9.90)	3.58 B	10.60
7+18	1.94	4.86			6.80 (2.00 - 7.50)	3.12 B	9.60	2.43	6.07			8.50			8.50 (2.80 - 10.20)	3.76 A	10.40
7+21	1.70	5.10			6.80 (2.00 - 7.50)	3.12 B	9.60	2.12	6.38			8.50			8.50 (2.80 - 10.20)	3.76 A	10.40
9+9 ¹	2.50	2.50			5.00 (1.90 - 6.80)	3.69 A	6.00	3.20	3.20			6.40			6.40 (2.70 - 9.80)	3.83 A	7.40
9+9 ²	2.50	2.80			5.30 (1.90 - 6.80)	3.51 A	6.70	3.30	3.70			7.00			7.00 (2.70 - 9.80)	3.74 A	8.60
9+12	2.50	3.20			5.70 (1.90 - 6.90)	3.31 A	7.60	3.55	4.55			8.00			8.00 (2.70 - 9.90)	3.60 B	10.40
9+15	2.50	4.00			6.50 (1.90 - 6.90)	2.81 B	10.10	3.27	5.23			8.50			8.50 (2.70 - 9.90)	3.48 B	11.30
9+18	2.27	4.53			6.80 (1.90 - 7.50)	3.12 B	9.60	2.83	5.63			8.50			8.50 (2.80 - 10.20)	3.76 A	10.40
9+21	2.00	4.80			6.80 (1.90 - 7.50)	3.12 B	9.60	2.50	6.00			8.50			8.50 (2.80 - 10.20)	3.76 A	10.40
9+9 ¹	2.80	2.80			5.60 (1.90 - 6.80)	3.26 A	7.60	4.00	4.00			8.50			8.50 (2.70 - 9.90)	3.54 B	10.40
9+12	2.80	3.20			6.00 (1.90 - 6.90)	2.99 B	8.50	3.97	4.53			8.50			8.50 (2.70 - 9.90)	3.48 B	11.30
9+15	2.80	4.00			6.80 (1.90 - 6.90)	3.57 B	11.60	3.58	5.80			8.50			8.50 (2.70 - 9.90)	3.48 B	11.30
9+18	2.44	4.36			6.80 (1.90 - 7.50)	3.12 B	9.60	3.05	5.45			8.50			8.50 (2.80 - 10.20)	3.76 A	10.40
9+21	2.16	4.64			6.80 (1.90 - 7.50)	3.12 B	9.60	2.70	5.80			8.50			8.50 (2.80 - 10.20)	3.76 A	10.40
12+12	3.20	3.20			6.40 (1.90 - 7.00)	2.93 A	9.50	4.25	4.25			8.50			8.50 (2.80 - 10.00)	3.56 B	11.00
12+15	3.02	3.78			6.80 (1.90 - 7.10)	2.71 A	11.00	3.78	4.72			8.50			8.50 (2.80 - 10.00)	3.56 B	11.00
12+18	2.65	4.14			6.80 (2.00 - 7.60)	3.25 A	10.20	3.32	5.18			8.50			8.50 (2.80 - 10.30)	3.86 A	10.10
12+21	2.37	4.43			6.80 (2.00 - 7.60)	3.25 A	10.20	2.96	5.54			8.50			8.50 (2.80 - 10.30)	3.86 A	10.10
15+15	3.40	3.40			6.80 (1.90 - 7.10)	2.71 A	11.00	4.25	4.25			8.50			8.50 (2.80 - 10.00)	3.57 B	11.00
15+18	3.02	3.78			6.80 (2.00 - 7.60)	3.25 A	9.20	3.78	4.72			8.50			8.50 (2.80 - 10.30)	3.86 A	10.10
15+21	2.72	4.08			6.80 (2.00 - 7.60)	3.25 A	9.20	3.40	5.10			8.50			8.50 (2.80 - 10.30)	3.86 A	10.10
18+18	3.40	3.40			6.80 (2.10 - 8.10)	3.66 A	8.20	4.25	4.25			8.50			8.50 (2.80 - 10.50)	4.15 A	9.50
18+21	3.09	3.71			6.80 (2.10 - 8.10)	3.66 A	8.20	3.86	4.64			8.50			8.50 (2.80 - 10.50)	4.15 A	9.50
3 Rooms																	
5+5+5	1.60	1.60	1.60		4.80 (1.90 - 8.00)	4.71 A	4.60	2.60	2.60	2.60		7.80			7.80 (3.30 - 10.40)	4.11 A	8.80
5+5+7	1.60	1.60	2.00		5.20 (1.90 - 8.00)	4.48 A	5.20	2.58	2.58	3.24		8.40			8.40 (3.30 - 10.40)	3.96 A	9.80
5+5+9 ¹	1.60	1.60	2.50		5.70 (1.90 - 8.00)	4.10 A	6.20	2.39	3.72			8.50			8.50 (3.30 - 10.40)	3.94 A	10.00
5+5+9 ²	1.60	1.60	2.80		6.00 (1.90 - 8.00)	3.97 A	6.70	2.27	3.96			8.50			8.50 (3.30 - 10.40)	3.94 A	10.00
5+5+12	1.60	1.60	3.20		6.40 (1.90 - 8.00)	3.81 A	7.50	2.13	4.24			8.50			8.50 (3.30 - 10.40)	4.05 A	9.70
5+5+15	1.51	1.51	3.78		6.80 (1.90 - 8.10)	3.56 A	8.60	1.89	4.72			8.50			8.50 (3.30 - 10.50)	4.07 A	9.60
5+5+18	1.33	1.33	4.14		6.80 (2.00 - 8.50)	3.84 A	7.80	1.66	5.18			8.50			8.50 (3.30 - 10.50)	4.34 A	9.00
5+5+21	1.18	1.18	4.44		6.80 (2.00 - 8.50)	3.84 A	7.80	1.48	5.54			8.50			8.50 (3.30 - 10.50)	4.34 A	9.00
5+7+7	1.60	2.00	2.00		5.60 (1.90 - 8.00)	4.27 A	6.00	2.42	3.04			8.50			8.50 (3.30 - 10.40)	3.95 A	9.90
5+7+9 ¹	1.60	2.00	2.50		6.10 (1.90 - 8.00)	3.91 A	6.90	2.23	2.79	3.48		8.50			8.50 (3.30 - 10.40)	3.95 A	9.90
5+7+9 ²	1.60	2.00	2.80		6.40 (1.90 - 8.00)	3.70 A	7.70	2.12	2.66	3.72		8.50			8.50 (3.30 - 10.40)	3.95 A	9.90
5+7+12	1.60	2.00	3.20		6.80 (1.90 - 8.00)	3.56 A	8.40	2.00	2.50	4.00		8.50			8.50 (3.30 - 10.40)	4.07 A	9.60
5+7+15	1.43	1.79	3.58		6.80 (1.90 - 8.10)	3.56 A	8.40	1.79	2.24	4.47		8.50			8.50 (3.30 - 10.50)	4.09 A	9.60
5+7+18	1.27	1.58	3.95		6.80 (2.00 - 8.50)	3.95 A	7.60	1.58	1.98	4.94		8.50			8.50 (3.30 - 10.50)	4.34 A	9.00
5+7+21	1.13	1.42	4.25		6.80 (2.00 - 8.50)	3.95 A	7.60	1.42	1.77	5.31		8.50			8.50 (3.30 - 10.50)	4.34 A	9.00
5+9+9 ¹	1.60	2.50	2.50		6.60 (1.90 - 8.00)	3.63 A	8.00	2.06	3.22			8.50			8.50 (3.30 - 10.40)	3.95 A	9.90
5+9+9 ²	1.58	2.46	2.76		6.80 (1.90 - 8.00)	3.49 A	8.60	1.97	3.08	3.45		8.50			8.50 (3.30 - 10.40)	3.95 A	9.90
5+9+12	1.47	2.33	2.98		6.80 (1.90 - 8.00)	3.56 A	8.40	1.86	2.91	3.73		8.50			8.50 (3.30 - 10.40)	4.07 A	9.60
5+9+15	1.34	2.10	3.36		6.80 (1.90 - 8.10)	3.56 A	8.40	1.68	2.62	4.20		8.50			8.50 (3.30 - 10.50)	4.09 A	9.60
5+9+18	1.19	1.87	3.74		6.80 (2.00 - 8.50)	3.95 A	7.60	1.49	2.34	4.67		8.50			8.50 (3.30 - 10.50)	4.36 A	9.00
5+9+21	1.08	1.68	4.04		6.80 (2.00 - 8.50)	3.95 A	7.60	1.35	2.10	5.05		8.50			8.50 (3.30 - 10.50)	4.36 A	9.00
5+9+9 ¹	1.52	2.64	2.64		6.80 (1.90												

Free Multi 4x1

Free Multi 4x1 CU-4E27PBE. Minimum capacity connected: 4,5 kW. Maximum capacity connected: 13,6 kW														
Indoor unit capacity	Cooling capacity (kW). Rooms				EER	Current	Heating capacity (kW). Rooms				COP	Current		
	Room A	Room B	Room C	Room D			Total (Min - Max)	W/W	230V (A)	Room A			Room B	Room C
1 Room														
5	1.60				4.00 A	2.00	2.60					2.60 (1.20 - 3.20)	4.33 A	3.00
7	2.00				4.00 A	2.50	3.20					3.20 (1.20 - 4.10)	4.32 A	3.70
9 ¹	2.50				3.97 A	3.20	3.60					3.60 (1.20 - 4.30)	3.83 A	4.70
9 ²	2.80				4.00 A	3.50	4.00					4.00 (1.20 - 4.30)	3.81 A	5.20
12	3.20				4.00 A	3.90	4.50					4.50 (1.20 - 5.80)	3.66 A	6.00
15	4.00				3.23 A	5.80	5.60					5.60 (1.20 - 8.00)	3.26 A	8.00
18	5.00				2.93 A	7.20	6.80					6.80 (1.20 - 6.90)	3.24 A	9.70
21	6.00				2.26 A	9.20	8.50					8.50 (1.30 - 9.00)	3.54 B	11.10
24	7.00				2.81 C	11.30	8.70					8.70 (1.40 - 9.20)	3.41 B	11.80
2 Rooms														
5 + 5	1.60	1.60			4.38 A	3.70	2.35	2.35				4.70 (2.20 - 8.20)	3.36 C	6.60
5 + 7	1.60	2.00			4.14 A	4.30	2.31	2.89				5.20 (2.20 - 8.20)	3.29 C	7.50
5 + 9 ¹	1.60	2.50			3.83 A	5.20	2.19	3.41				5.60 (2.20 - 8.20)	3.24 C	8.20
5 + 9 ²	1.60	2.80			4.40 (2.40 - 5.80)	3.76 A	2.15	3.75				5.90 (2.20 - 8.20)	3.33 C	8.30
5 + 12	1.60	3.20			3.64 A	6.30	2.13	4.27				6.40 (2.20 - 8.20)	3.40 B	8.80
5 + 15	1.60	4.00			5.60 (2.40 - 5.80)	3.41 A	1.99	2.11	5.29			7.40 (2.20 - 8.60)	3.47 B	10.00
5 + 18	1.60	5.00			6.00 (2.40 - 7.20)	3.33 A	2.06	2.64	6.44			8.50 (2.20 - 8.00)	3.62 A	11.80
5 + 21	1.60	6.00			7.60 (2.40 - 8.50)	3.02 B	1.98	2.42	7.45			9.40 (2.20 - 10.00)	3.73 A	11.80
5 + 24	1.69	6.51			8.00 (2.40 - 8.50)	3.01 B	1.74	2.65	7.65			9.40 (2.20 - 10.30)	3.82 A	11.60
7 + 7	2.00	2.00			4.00 (2.40 - 5.80)	3.96 A	2.90	2.90	2.90			5.80 (2.20 - 8.20)	3.39 C	8.10
7 + 9 ¹	2.00	2.50			4.50 (2.40 - 5.80)	3.69 A	2.71	3.39	3.39			6.10 (2.20 - 8.20)	3.39 C	8.50
7 + 9 ²	2.00	2.80			4.80 (2.40 - 5.80)	3.44 A	2.71	3.79	3.79			6.50 (2.20 - 8.20)	3.57 B	8.60
7 + 12	2.00	3.20			5.20 (2.40 - 5.80)	3.66 A	2.65	4.25	4.25			6.90 (2.20 - 8.60)	3.58 B	9.10
7 + 15	2.00	4.00			6.00 (2.40 - 6.70)	3.23 A	2.63	5.27	5.27			7.90 (2.20 - 9.80)	3.42 B	10.90
7 + 18	2.00	5.00			7.00 (2.40 - 8.10)	3.38 A	2.57	6.43	6.43			9.00 (2.20 - 10.00)	3.88 A	10.90
7 + 21	2.00	6.00			8.00 (2.40 - 8.50)	2.97 C	2.35	7.05	7.05			9.40 (2.20 - 10.00)	3.75 A	11.80
7 + 24	1.78	6.22			8.00 (2.50 - 8.50)	3.14 B	1.20	2.09	7.31			9.40 (2.20 - 10.30)	3.84 A	11.50
9 ¹ + 9 ¹	2.50	2.50			5.00 (2.40 - 5.80)	3.65 A	3.25	3.25	3.25			5.60 (2.20 - 8.60)	3.57 B	8.60
9 ¹ + 9 ²	2.50	2.80			5.30 (2.40 - 5.80)	3.46 A	3.20	3.59	3.59			6.80 (2.20 - 8.60)	3.47 B	9.20
9 ¹ + 12	2.50	3.20			5.70 (2.40 - 6.70)	3.37 A	3.10	3.20	4.10			7.30 (2.20 - 9.80)	3.51 B	9.80
9 ¹ + 15	2.50	4.00			6.50 (2.40 - 7.20)	3.00 C	3.19	3.11	5.11			8.30 (2.20 - 10.00)	3.36 C	11.60
9 ¹ + 18	2.50	5.00			7.50 (2.40 - 8.50)	3.14 B	3.13	6.27	6.27			9.40 (2.20 - 10.00)	3.75 A	11.80
9 ¹ + 21	2.35	5.65			8.00 (2.50 - 8.50)	2.97 C	2.76	6.64	6.64			9.40 (2.20 - 10.00)	3.75 A	11.80
9 ¹ + 24	2.11	5.89			8.00 (2.50 - 8.50)	3.14 B	1.20	2.47	6.93			9.40 (2.20 - 10.30)	3.84 A	11.50
9 ² + 9 ²	2.80	2.80			5.60 (2.40 - 5.80)	3.81 A	3.60	3.60	3.60			7.20 (2.20 - 8.60)	3.41 B	9.90
9 ² + 12	2.80	3.20			6.00 (2.40 - 6.70)	3.21 A	3.59	4.11	4.11			7.70 (2.20 - 9.80)	3.47 B	10.40
9 ² + 15	2.80	4.00			6.80 (2.40 - 7.20)	2.93 C	3.54	5.06	5.06			8.60 (2.20 - 10.00)	3.61 A	11.20
9 ² + 18	2.80	5.00			7.80 (2.40 - 8.50)	3.06 B	3.37	6.03	6.03			9.40 (2.20 - 10.00)	3.75 A	11.80
9 ² + 21	2.55	5.45			8.00 (2.50 - 8.50)	2.97 C	2.80	2.99	6.41			9.40 (2.20 - 10.30)	3.75 A	11.80
9 ² + 24	2.29	5.71			8.00 (2.50 - 8.50)	3.14 B	1.20	2.69	6.71			9.40 (2.20 - 10.30)	3.84 A	11.50
12 + 12	3.20	3.20			6.40 (2.40 - 7.20)	3.14 B	3.70	4.05	4.05			8.10 (2.20 - 10.00)	3.45 B	11.00
12 + 15	3.20	4.00			7.20 (2.40 - 8.10)	2.86 C	3.20	4.04	5.06			9.10 (2.20 - 10.00)	3.57 B	12.00
12 + 18	3.12	4.88			8.00 (2.50 - 8.50)	3.14 B	3.12	3.67	5.73			9.40 (2.20 - 10.00)	3.87 A	11.40
12 + 21	2.78	5.22			8.00 (2.50 - 8.50)	3.14 B	1.20	3.27	6.13			9.40 (2.20 - 10.30)	3.87 A	11.40
12 + 24	2.51	5.49			8.00 (2.50 - 8.50)	3.21 A	1.80	2.95	6.45			9.40 (2.20 - 10.30)	3.88 A	11.40
15 + 15	4.00	4.00			8.00 (2.50 - 8.50)	2.60 A	4.60	4.70	4.70			9.40 (2.20 - 10.00)	3.56 B	12.40
15 + 18	3.56	4.44			8.00 (2.50 - 8.50)	3.14 B	1.20	4.18	5.22			9.40 (2.20 - 10.30)	3.88 A	11.40
15 + 21	3.20	4.80			8.00 (2.50 - 8.50)	3.14 B	1.20	3.76	5.64			9.40 (2.20 - 10.30)	3.88 A	11.40
15 + 24	2.91	5.09			8.00 (2.50 - 8.60)	3.21 A	1.80	3.42	5.98			9.40 (2.20 - 10.50)	3.90 A	11.30
18 + 18	4.00	4.00			8.00 (2.50 - 8.60)	3.59 A	4.00	4.70	4.70			9.40 (2.20 - 10.30)	4.18 A	10.60
18 + 21	3.64	4.36			8.00 (2.50 - 8.60)	3.59 A	4.00	4.27	5.13			9.40 (2.20 - 10.50)	4.18 A	10.60
18 + 24	3.33	4.67			8.00 (2.50 - 8.60)	3.59 A	4.00	3.92	5.48			9.40 (2.20 - 10.50)	4.20 A	10.50
21 + 21	4.00	4.00			8.00 (2.50 - 8.60)	3.59 A	4.00	4.70	4.70			9.40 (2.20 - 10.50)	4.18 A	10.60
21 + 24	3.69	4.31			8.00 (2.50 - 8.60)	3.59 A	4.00	4.34	5.06			9.40 (2.20 - 10.50)	4.20 A	10.50
3 Rooms														
5 + 5 + 5	1.60	1.60	1.60		4.44 A	5.20	2.87	2.87	2.87			8.61 (3.20 - 10.40)	4.08 A	9.90
5 + 5 + 7	1.60	1.60	2.00		5.20 (3.00 - 8.50)	4.41 A	2.65	2.65	3.31			8.61 (3.20 - 10.40)	4.20 A	9.60
5 + 5 + 9 ¹	1.60	1.60	2.50		5.70 (3.00 - 8.50)	4.10 A	2.70	2.42	3.77			8.61 (3.20 - 10.40)	4.20 A	9.60
5 + 5 + 9 ²	1.60	1.60	2.80		6.00 (3.00 - 8.50)	4.00 A	2.30	2.30	4.01			8.61 (3.20 - 10.40)	4.20 A	9.60
5 + 5 + 12	1.60	1.60	3.20		6.40 (3.00 - 8.50)	3.83 A	2.15	2.15	4.31			8.61 (3.20 - 10.40)	4.26 A	9.50
5 + 5 + 15	1.60	1.60	4.00		7.20 (3.00 - 8.50)	3.71 A	1.92	1.91	4.79			8.61 (3.20 - 10.40)	4.28 A	9.40
5 + 5 + 18	1.56	1.56	4.88		8.00 (3.00 - 8.60)	3.81 A	1.68	1.68	5.25			8.61 (3.20 - 10.40)	4.53 A	8.90
5 + 5 + 21	1.39	1.39	5.22		8.00 (3.00 - 8.60)	3.81 A	1.00	1.50	5.61			8.61 (3.20 - 10.50)	4.53 A	8.90
5 + 5 + 24	1.25	1.25	5.50		8.00 (3.00 - 8.60)	3.92 A	1.35	1.35	5.91			8.61 (3.20 - 10.50)	4.56 A	8.90
5 + 7 + 7	1.60	2.00	2.00		5.60 (3.00 - 8.50)	4.18 A	2.45	3.08	3.08			8.61 (3.20 - 10.40)	4.22 A	9.60
5 + 7 + 9 ¹	1.60	2.00	2.50		6.10 (3.00 - 8.50)	3.93 A	2.26	2.82	3.53			8.61 (3.20 - 10.40)	4.22 A	9.60
5 + 7 + 9 ²	1.60	2.00	2.80		6.40 (3.00 - 8.50)	3.83 A	2.15	2.69	3.77			8.61 (3.20 - 10.40)	4.22 A	9.60
5 + 7 + 12	1.60	2.00	3.20		6.80 (3.00 - 8.50)	3.84 A	2.03	2.53	4.05			8.61 (3.20 - 10.40)	4.28 A	9.40
5 + 7 + 15	1.60	2.00	4.00		7.60 (3.00 - 8.50)	3.57 A	1.80	2.27	4.53			8.61 (3.20 - 10.40)	4.31 A	9.40
5 + 7 + 18	1.49	1.86	4.65		8.00 (3.00 - 8.60)	3.81 A	1.00	1.60	5.01			8.61 (3.20 - 10.50)	4.53 A	8.90
5 + 7 + 21	1.33	1.67	5.00		8.00 (3.00 - 8.60)	3.81 A	1.00	1.44	5.38			8.61 (3.20 - 10.50)	4.53 A	8.90
5 + 7 + 24	1.21	1.51	5.28		8.00 (3.00 - 8.60)	3.92 A	1.30	1.62	5.69			8.61 (3.20 - 10.50)	4.56 A	8.90
5 + 9 ¹ + 9 ¹	1.60	2.50	2.50		6.60 (3.00 - 8.50)	3.69 A	2.09	3.26	3.26			8.61 (3.20 - 10.40)	4.22 A	9.60
5 + 9 ¹ + 9 ²	1.60	2.50	2.80		7.00 (3.00 - 8.50)	3.77 A	1.80	2.00	3.12	3.49		8.61 (3.20 - 10.40)	4.22 A	9.60
5 + 9 ¹ + 12	1.60	2.50	3.20		7.30 (3.00 - 8.50)	3.65 A	1.89	2.95	3.77			8.61 (3.20 - 10.40)	4.	

Free Multi combinations table

Free Multi 4x1

Free Multi 4x1 CU-4E27PBE. Minimum capacity connected: 4,5 kW. Maxium capacity connected: 13,6 kW														
Indoor unit capacity	Cooling capacity (kW), Rooms				EER	Current	Heating capacity (kW), Rooms				COP	Current		
	Room A	Room B	Room C	Room D			Total (Min - Max)	W/W	230V (A)	Room A			Room B	Room C
4 Rooms														
5+5+5+5	1.60	1.60	1.60	1.60	6.40 (3.00 - 9.20)	4.30	7.10	2.35	2.35	2.35	2.35	9.40 (4.20 - 10.60)	4.43	10.00
5+5+5+7	1.60	1.60	1.60	2.00	6.80 (3.00 - 9.20)	4.28	7.60	2.21	2.21	2.21	2.77	9.40 (4.20 - 10.60)	4.45	9.90
5+5+5+9	1.60	1.60	1.60	2.50	7.30 (3.00 - 9.20)	4.15	8.30	2.06	2.06	2.06	3.22	9.40 (4.20 - 10.60)	4.45	9.90
5+5+5+12	1.60	1.60	1.60	3.20	8.00 (3.00 - 9.20)	4.04	9.40	1.88	1.88	1.88	3.76	9.40 (4.20 - 10.60)	4.50	9.80
5+5+5+15	1.45	1.45	1.45	3.65	8.00 (3.00 - 9.20)	4.04	9.40	1.71	1.71	1.71	4.27	9.40 (4.20 - 10.60)	4.52	9.80
5+5+5+18	1.31	1.31	1.31	4.07	8.00 (3.00 - 9.20)	4.28	8.90	1.53	1.53	1.53	4.81	9.40 (4.20 - 10.60)	4.59	9.60
5+5+5+21	1.19	1.19	1.19	4.43	8.00 (3.00 - 9.20)	4.28	8.90	1.39	1.39	1.39	5.23	9.40 (4.20 - 10.60)	4.59	9.60
5+5+5+24	1.08	1.08	1.08	4.76	8.00 (3.00 - 9.20)	4.28	8.90	1.27	1.27	1.27	5.59	9.40 (4.20 - 10.60)	4.61	9.60
5+5+7+7	1.60	1.60	2.00	2.00	7.20 (3.00 - 9.20)	4.24	8.10	2.09	2.09	2.61	2.61	9.40 (4.20 - 10.60)	4.48	9.90
5+5+7+9	1.60	1.60	2.00	2.50	7.70 (3.00 - 9.20)	4.14	8.80	1.95	1.95	2.44	3.06	9.40 (4.20 - 10.60)	4.48	9.90
5+5+7+12	1.52	1.52	1.90	3.06	8.00 (3.00 - 9.20)	4.17	9.10	1.79	1.79	2.24	3.58	9.40 (4.20 - 10.60)	4.52	9.90
5+5+7+15	1.39	1.39	1.74	3.48	8.00 (3.00 - 9.20)	4.17	9.10	1.63	1.63	2.04	4.10	9.40 (4.20 - 10.60)	4.54	9.90
5+5+7+18	1.25	1.25	1.57	3.93	8.00 (3.00 - 9.20)	4.28	8.90	1.47	1.47	1.84	4.62	9.40 (4.20 - 10.60)	4.61	9.60
5+5+7+21	1.14	1.14	1.43	4.29	8.00 (3.00 - 9.20)	4.28	8.90	1.34	1.34	1.68	5.04	9.40 (4.20 - 10.60)	4.63	9.60
5+5+7+24	1.05	1.05	1.31	4.59	8.00 (3.00 - 9.20)	4.28	8.90	1.23	1.23	1.54	5.40	9.40 (4.20 - 10.60)	4.63	9.60
5+5+9+9	1.56	1.56	2.44	2.44	8.00 (3.00 - 9.20)	4.04	9.40	1.83	1.83	2.87	2.87	9.40 (4.20 - 10.60)	4.63	9.90
5+5+9+12	1.51	1.51	2.34	2.64	8.00 (3.00 - 9.20)	4.04	9.40	1.77	1.77	2.76	3.10	9.40 (4.20 - 10.60)	4.68	9.90
5+5+9+15	1.44	1.44	2.24	2.88	8.00 (3.00 - 9.20)	4.17	9.10	1.69	1.69	2.64	3.38	9.40 (4.20 - 10.60)	4.68	9.90
5+5+9+18	1.32	1.32	2.06	3.00	8.00 (3.00 - 9.20)	4.17	9.10	1.55	1.55	2.42	3.88	9.40 (4.20 - 10.60)	4.68	9.90
5+5+9+21	1.20	1.20	1.86	3.74	8.00 (3.00 - 9.20)	4.28	8.90	1.41	1.41	2.19	4.39	9.40 (4.20 - 10.60)	4.61	9.60
5+5+9+24	1.09	1.09	1.71	4.11	8.00 (3.00 - 9.20)	4.28	8.90	1.29	1.29	2.00	4.82	9.40 (4.20 - 10.60)	4.61	9.60
5+5+9+27	1.01	1.01	1.57	4.41	8.00 (3.00 - 9.20)	4.28	8.90	1.18	1.18	1.85	5.19	9.40 (4.20 - 10.60)	4.63	9.60
5+5+9+30	1.45	1.45	2.55	2.55	8.00 (3.00 - 9.20)	4.04	9.40	1.71	1.71	2.99	2.99	9.40 (4.20 - 10.60)	4.68	9.90
5+5+9+33	1.39	1.39	2.43	2.79	8.00 (3.00 - 9.20)	4.17	9.10	1.63	1.63	2.86	3.28	9.40 (4.20 - 10.60)	4.65	9.90
5+5+9+36	1.28	1.28	2.24	3.20	8.00 (3.00 - 9.20)	4.17	9.10	1.50	1.50	2.63	3.77	9.40 (4.20 - 10.60)	4.65	9.90
5+5+9+39	1.16	1.16	2.04	3.64	8.00 (3.00 - 9.20)	4.28	8.90	1.37	1.37	2.39	4.27	9.40 (4.20 - 10.60)	4.61	9.60
5+5+9+42	1.07	1.07	1.86	4.00	8.00 (3.00 - 9.20)	4.28	8.90	1.25	1.25	2.19	4.71	9.40 (4.20 - 10.60)	4.61	9.60
5+5+9+45	0.98	0.98	1.72	4.32	8.00 (3.00 - 9.20)	4.28	8.90	1.16	1.16	2.02	5.06	9.40 (4.20 - 10.60)	4.63	9.60
5+5+12+12	1.33	1.33	2.67	2.67	8.00 (3.00 - 9.20)	4.17	9.10	1.57	1.57	3.13	3.13	9.40 (4.20 - 10.60)	4.56	9.90
5+5+12+15	1.23	1.23	2.46	3.08	8.00 (3.00 - 9.20)	4.17	9.10	1.45	1.45	2.88	3.62	9.40 (4.20 - 10.60)	4.59	9.60
5+5+12+18	1.12	1.12	2.25	3.51	8.00 (3.00 - 9.20)	4.28	8.90	1.32	1.32	2.64	4.12	9.40 (4.20 - 10.60)	4.63	9.60
5+5+12+21	1.03	1.03	2.06	3.88	8.00 (3.00 - 9.20)	4.28	8.90	1.21	1.21	2.43	4.55	9.40 (4.20 - 10.60)	4.63	9.60
5+5+12+24	0.96	0.96	1.90	4.18	8.00 (3.00 - 9.20)	4.28	8.90	1.12	1.12	2.24	4.92	9.40 (4.20 - 10.60)	4.65	9.60
5+5+15+15	1.14	1.14	2.86	2.86	8.00 (3.00 - 9.20)	4.17	9.10	1.34	1.34	3.36	3.36	9.40 (4.20 - 10.60)	4.61	9.60
5+5+15+18	1.05	1.05	2.62	3.28	8.00 (3.00 - 9.20)	4.28	8.90	1.23	1.23	3.08	3.86	9.40 (4.20 - 10.60)	4.65	9.60
5+5+15+21	0.97	0.97	2.42	3.64	8.00 (3.00 - 9.20)	4.28	8.90	1.14	1.14	2.85	4.27	9.40 (4.20 - 10.60)	4.65	9.60
5+5+18+18	0.97	0.97	3.03	3.03	8.00 (3.00 - 9.20)	4.26	8.90	1.14	1.14	3.56	3.56	9.40 (4.20 - 10.60)	4.56	9.60
5+7+7+7	1.60	2.00	2.00	2.00	7.60 (3.00 - 9.20)	4.06	8.90	1.99	2.47	2.47	2.47	9.40 (4.20 - 10.60)	4.50	9.80
5+7+7+9	1.57	1.98	1.98	2.47	8.00 (3.00 - 9.20)	4.04	9.40	1.86	2.32	2.32	2.90	9.40 (4.20 - 10.60)	4.50	9.80
5+7+7+12	1.52	1.90	1.98	2.68	8.00 (3.00 - 9.20)	4.04	9.40	1.79	2.24	2.24	3.13	9.40 (4.20 - 10.60)	4.50	9.80
5+7+7+15	1.45	1.82	1.82	2.91	8.00 (3.00 - 9.20)	4.17	9.10	1.70	2.14	2.14	3.42	9.40 (4.20 - 10.60)	4.54	9.60
5+7+7+18	1.33	1.67	1.67	3.33	8.00 (3.00 - 9.20)	4.17	9.10	1.56	1.96	1.96	3.92	9.40 (4.20 - 10.60)	4.56	9.60
5+7+7+21	1.21	1.51	1.51	3.77	8.00 (3.00 - 9.20)	4.28	8.90	1.42	1.77	1.77	4.44	9.40 (4.20 - 10.60)	4.63	9.60
5+7+7+24	1.10	1.38	1.38	4.14	8.00 (3.00 - 9.20)	4.28	8.90	1.30	1.62	1.62	4.86	9.40 (4.20 - 10.60)	4.63	9.60
5+7+9+9	1.48	1.86	2.33	2.33	8.00 (3.00 - 9.20)	4.04	9.40	1.75	2.19	2.73	2.73	9.40 (4.20 - 10.60)	4.63	9.60
5+7+9+12	1.43	1.80	2.25	2.52	8.00 (3.00 - 9.20)	4.04	9.40	1.69	2.11	2.64	2.96	9.40 (4.20 - 10.60)	4.50	9.80
5+7+9+15	1.38	1.72	2.15	2.75	8.00 (3.00 - 9.20)	4.17	9.10	1.62	2.02	2.55	3.23	9.40 (4.20 - 10.60)	4.63	9.60
5+7+9+18	1.27	1.58	1.98	3.17	8.00 (3.00 - 9.20)	4.17	9.10	1.49	1.86	2.33	3.72	9.40 (4.20 - 10.60)	4.65	9.60
5+7+9+21	1.15	1.44	1.80	3.61	8.00 (3.00 - 9.20)	4.28	8.90	1.35	1.69	2.12	4.24	9.40 (4.20 - 10.60)	4.63	9.60
5+7+9+24	1.06	1.32	1.65	3.97	8.00 (3.00 - 9.20)	4.28	8.90	1.24	1.55	1.94	4.67	9.40 (4.20 - 10.60)	4.63	9.60
5+7+9+27	0.98	1.22	1.53	4.27	8.00 (3.00 - 9.20)	4.28	8.90	1.15	1.44	1.79	5.02	9.40 (4.20 - 10.60)	4.63	9.60
5+7+9+30	0.94	1.16	1.43	4.59	8.00 (3.00 - 9.20)	4.04	9.40	1.06	1.35	1.86	5.36	9.40 (4.20 - 10.60)	4.50	9.80
5+7+9+33	0.92	1.13	1.37	4.91	8.00 (3.00 - 9.20)	4.17	9.10	1.07	1.36	2.13	5.64	9.40 (4.20 - 10.60)	4.50	9.80
5+7+9+36	0.91	1.12	1.34	5.23	8.00 (3.00 - 9.20)	4.17	9.10	1.04	1.31	2.41	5.92	9.40 (4.20 - 10.60)	4.54	9.60
5+7+9+39	0.90	1.11	1.31	5.55	8.00 (3.00 - 9.20)	4.17	9.10	1.01	1.28	2.69	6.20	9.40 (4.20 - 10.60)	4.54	9.60
5+7+9+42	0.89	1.10	1.29	5.87	8.00 (3.00 - 9.20)	4.17	9.10	0.98	1.25	2.97	6.48	9.40 (4.20 - 10.60)	4.63	9.60
5+7+12+12	1.28	1.60	2.56	2.56	8.00 (3.00 - 9.20)	4.17	9.10	1.50	1.88	3.01	3.01	9.40 (4.20 - 10.60)	4.59	9.60
5+7+12+15	1.19	1.48	2.37	2.96	8.00 (3.00 - 9.20)	4.17	9.10	1.39	1.74	2.79	3.48	9.40 (4.20 - 10.60)	4.61	9.60
5+7+12+18	1.08	1.36	2.17	3.39	8.00 (3.00 - 9.20)	4.28	8.90	1.27	1.59	2.55	3.99	9.40 (4.20 - 10.60)	4.65	9.60
5+7+12+21	1.00	1.25	2.00	3.75	8.00 (3.00 - 9.20)	4.28	8.90	1.17	1.47	2.35	4.41	9.40 (4.20 - 10.60)	4.65	9.60
5+7+15+15	1.10	1.38	2.76	2.76	8.00 (3.00 - 9.20)	4.17	9.10	1.30	1.62	3.24	3.24	9.40 (4.20 - 10.60)	4.61	9.60
5+7+15+18	1.02	1.27	2.54	3.17	8.00 (3.00 - 9.20)	4.28	8.90	1.19	1.49	2.98	3.74	9.40 (4.20 - 10.60)	4.65	9.60
5+7+15+21	0.94	1.18	2.35	3.53	8.00 (3.00 - 9.20)	4.28	8.90	1.11	1.38	2.76	4.15	9.40 (4.20 - 10.60)	4.65	9.60
5+7+18+18	0.94	1.18	2.94	2.94	8.00 (3.00 - 9.20)	4.23	9.00	1.10	1.38	3.46	3.46	9.40 (4.20 - 10.60)	4.56	9.60
5+9+9+9	1.40	2.20	2.20	2.20	8.00 (3.00 - 9.20)	4.04	9.40	1.66	2.58	2.58	2.58	9.40 (4.20 - 10.60)	4.63	9.90
5+9+9+12	1.36	2.13	2.13	2.38	8.00 (3.00 - 9.20)	4.04	9.40	1.60	2.50	2.50	2.80	9.40 (4.20 - 10.60)	4.50	9.80
5+9+9+15	1.31	2.04	2.04	2.61	8.00 (3.00 - 9.20)	4.17								

Free Multi 5x1

Free Multi 5x1 CU-5E34PBE. Minimum capacity connected: 4,5 kW. Maximum capacity connected: 17,5 kW																
Indoor unit capacity	Cooling capacity (kW). Rooms					EER Current Heating capacity (kW). Rooms					COP Current					
	A	B	C	D	E	Total (Min - Max)	W/W	230V (A)	A	B	C	D	E	Total (Min - Max)	W/W	230V (A)
1 Room																
5	1.60					1.60 (1.30 - 2.30)	4.00 A	2.00	2.40					2.60 (1.20 - 3.20)	4.33 A	3.00
7	2.00					2.00 (1.00 - 2.90)	4.00 A	2.50	3.20					3.20 (1.20 - 4.10)	4.32 A	3.70
9 ¹	2.50					2.50 (1.00 - 2.90)	3.97 A	3.20	3.40					3.60 (1.20 - 4.30)	3.83 A	4.70
9 ²	2.80					2.80 (1.00 - 2.90)	4.00 A	3.50	4.00					4.00 (1.20 - 3.00)	3.81 A	5.20
12	3.20					3.20 (1.00 - 3.80)	4.00 A	3.90	4.50					4.50 (1.20 - 6.00)	3.66 A	6.00
15	4.00					4.00 (1.00 - 4.30)	3.23 A	5.80	5.60					5.60 (1.20 - 6.80)	3.26 C	8.00
18	5.00					5.00 (1.90 - 5.70)	2.93 C	7.20	6.80					6.80 (1.20 - 6.90)	3.24 C	9.70
21	6.00					6.00 (1.90 - 6.20)	3.26 C	9.20	8.50					8.50 (1.30 - 9.00)	3.54 B	11.10
24	7.00					7.00 (2.00 - 7.20)	2.81 C	11.30	8.70					8.70 (1.40 - 9.20)	3.41 B	11.80
2 Rooms																
5 + 5	1.60	1.60				3.20 (2.40 - 5.80)	4.38 A	3.60	2.35	2.35				4.70 (2.00 - 8.20)	3.36 C	6.60
5 + 7	1.60	2.00				3.60 (2.40 - 5.80)	4.14 A	4.20	2.31	2.89				5.20 (2.00 - 8.20)	3.29 C	7.50
5 + 9 ¹	1.60	2.50				4.10 (2.40 - 5.80)	3.83 A	5.00	2.19	3.41				5.60 (2.00 - 8.20)	3.24 C	8.20
5 + 9 ²	1.60	2.80				4.40 (2.40 - 5.80)	3.70 A	5.60	2.15	3.75				5.90 (2.00 - 8.20)	3.22 C	8.60
5 + 12	1.60	3.20				4.80 (2.40 - 5.80)	3.58 A	6.20	2.13	4.27				6.40 (2.00 - 8.20)	3.28 C	9.20
5 + 15	1.60	4.00				5.60 (2.40 - 5.80)	3.33 A	7.80	2.11	5.29				7.40 (2.00 - 8.60)	3.23 C	10.80
5 + 18	1.60	5.00				6.60 (2.40 - 7.20)	3.25 A	9.40	2.06	6.44				8.50 (2.00 - 11.00)	3.36 C	11.90
5 + 21	1.60	6.00				7.60 (2.40 - 6.60)	2.89 C	12.10	2.11	7.89				10.00 (2.00 - 11.00)	3.25 C	14.50
5 + 24	1.60	7.00				8.60 (2.50 - 9.10)	2.64 A	15.00	1.90	8.30				10.20 (2.00 - 13.00)	3.31 C	14.50
7 + 7	2.00	2.00				4.00 (2.40 - 5.80)	3.96 A	4.80	2.90	2.90				5.80 (2.00 - 8.20)	3.28 C	8.30
7 + 9 ¹	2.00	2.50				4.50 (2.40 - 5.80)	3.63 A	5.80	2.71	3.39				6.10 (2.00 - 8.20)	3.26 C	8.80
7 + 9 ²	2.00	2.80				4.80 (2.40 - 5.80)	3.58 A	6.20	2.71	3.79				6.50 (2.00 - 8.20)	3.32 C	9.20
7 + 12	2.00	3.20				5.20 (2.40 - 5.80)	3.56 A	6.80	2.65	4.25				6.90 (2.00 - 8.60)	3.32 C	9.80
7 + 15	2.00	4.00				6.00 (2.40 - 6.70)	3.13 B	8.90	2.63	5.27				7.90 (2.00 - 10.10)	3.17 D	11.70
7 + 18	2.00	5.00				7.00 (2.40 - 8.10)	2.84 C	10.00	2.57	6.43				9.00 (2.00 - 11.00)	3.45 B	12.30
7 + 21	2.00	6.00				8.00 (2.40 - 6.60)	3.24 C	13.00	2.62	7.88				10.50 (2.00 - 11.90)	3.40 C	14.50
7 + 24	2.00	7.00				9.00 (2.50 - 10.00)	2.60 A	16.00	2.38	8.32				10.70 (2.00 - 13.00)	3.35 C	15.00
9 ¹ + 9 ¹	2.50	2.50				5.00 (2.40 - 5.80)	3.55 A	6.60	3.25	3.25				6.50 (2.00 - 8.60)	3.32 C	9.20
9 ¹ + 9 ²	2.50	2.80				5.30 (2.40 - 5.80)	3.38 A	7.30	3.21	3.59				6.80 (2.00 - 8.60)	3.21 C	10.00
9 ¹ + 12	2.50	3.20				5.70 (2.40 - 6.70)	3.28 A	8.10	3.20	4.10				7.30 (2.00 - 10.10)	3.26 C	10.50
9 ¹ + 15	2.50	4.00				6.50 (2.40 - 7.20)	2.91 C	10.30	3.19	5.11				8.30 (2.00 - 11.00)	3.12 D	12.50
9 ¹ + 18	2.50	5.00				7.50 (2.40 - 6.60)	2.80 B	11.50	3.13	6.27				9.40 (2.00 - 11.00)	3.32 C	13.30
9 ¹ + 21	2.50	6.00				8.50 (2.50 - 9.10)	2.61 A	15.00	3.21	7.69				10.90 (2.00 - 13.00)	3.40 C	15.10
9 ¹ + 24	2.50	7.00				9.50 (2.50 - 10.10)	2.45 A	17.90	2.92	8.18				11.10 (2.00 - 13.00)	3.40 B	15.30
9 ² + 9 ²	2.80	2.80				5.60 (2.40 - 5.80)	3.22 A	8.10	3.60	3.60				7.20 (2.00 - 8.60)	3.17 D	10.70
9 ² + 12	2.80	3.20				6.00 (2.40 - 6.70)	3.13 B	8.90	3.59	4.11				7.70 (2.00 - 11.00)	3.21 C	11.30
9 ² + 15	2.80	4.00				6.80 (2.40 - 7.20)	2.81 C	12.20	3.54	5.06				8.60 (2.00 - 11.00)	3.20 D	12.60
9 ² + 18	2.80	5.00				7.80 (2.40 - 6.60)	2.91 C	14.40	3.48	6.22				9.70 (2.00 - 11.00)	3.29 C	13.90
9 ² + 21	2.80	6.00				8.80 (2.50 - 9.10)	2.57 A	19.00	3.60	7.10				11.30 (2.00 - 13.00)	3.46 B	15.40
9 ² + 24	2.80	7.00				9.80 (2.50 - 10.10)	2.39 F	19.10	3.26	8.14				11.40 (2.00 - 13.00)	3.44 B	15.60
12 + 12	3.20	3.20				6.40 (2.40 - 7.20)	3.05 B	9.70	4.05	4.05				8.10 (2.00 - 11.00)	3.20 C	11.90
12 + 15	3.20	4.00				7.20 (2.40 - 8.10)	2.79 A	12.10	4.04	5.06				9.10 (2.00 - 11.00)	3.16 D	13.50
12 + 18	3.20	5.00				8.20 (2.50 - 9.10)	2.58 C	13.30	3.98	6.22				10.20 (2.00 - 11.90)	3.41 B	14.10
12 + 21	3.20	6.00				9.20 (2.50 - 10.00)	2.86 B	16.50	4.07	7.63				11.70 (2.00 - 13.00)	3.43 B	16.00
12 + 24	3.14	6.86				10.00 (2.50 - 10.40)	2.47 F	19.50	3.74	8.24				12.00 (2.00 - 13.80)	3.42 B	16.50
15 + 15	4.00	4.00				8.00 (2.50 - 6.60)	2.37 A	14.90	5.05	5.05				10.10 (2.00 - 11.90)	3.14 D	15.10
15 + 18	4.00	5.00				9.00 (2.50 - 10.00)	2.64 A	16.00	4.98	6.22				11.20 (2.00 - 13.00)	3.59 B	14.70
15 + 21	4.00	6.00				10.00 (2.50 - 10.40)	2.24 F	20.60	4.80	7.20				12.00 (2.00 - 13.80)	3.42 B	16.50
15 + 24	3.64	6.36				10.00 (2.50 - 10.40)	2.47 F	19.10	4.36	7.64				12.00 (2.00 - 13.80)	3.44 B	16.40
18 + 18	5.00	5.00				10.00 (2.50 - 10.40)	2.71 B	16.00	6.00	6.00				12.00 (2.00 - 13.80)	3.68 A	15.30
18 + 21	4.55	5.45				10.00 (2.50 - 10.40)	2.77 B	16.60	5.45	6.55				12.00 (2.00 - 13.80)	3.68 A	15.30
18 + 24	4.17	5.83				10.00 (2.50 - 10.40)	2.88 B	16.00	5.00	7.00				12.00 (2.00 - 13.80)	3.70 A	15.20
21 + 21	5.00	5.00				10.00 (2.50 - 10.40)	2.77 B	16.60	6.00	6.00				12.00 (2.00 - 13.80)	3.68 A	15.30
21 + 24	4.62	5.38				10.00 (2.50 - 10.40)	2.88 B	16.00	5.54	6.46				12.00 (2.00 - 13.80)	3.70 A	15.20
24 + 24	5.00	5.00				10.00 (2.50 - 10.40)	3.01 B	15.30	6.00	6.00				12.00 (2.00 - 13.80)	3.72 A	15.20
3 Rooms																
5 + 5 + 5	1.60	1.60	1.60			4.80 (2.90 - 8.50)	4.36 A	5.20	2.33	2.33	2.33			6.90 (2.70 - 12.30)	3.95 A	8.30
5 + 5 + 7	1.60	1.60	2.00			5.20 (2.90 - 8.50)	4.26 A	5.70	2.34	2.34	2.92			7.60 (2.70 - 12.30)	3.78 A	9.40
5 + 5 + 9 ¹	1.60	1.60	2.50			5.70 (2.90 - 8.50)	3.99 A	6.70	2.22	2.22	3.48			7.90 (2.70 - 12.30)	3.73 A	10.00
5 + 5 + 9 ²	1.60	1.60	2.80			6.00 (2.90 - 8.50)	3.90 A	7.20	2.21	2.21	3.88			8.30 (2.70 - 12.30)	3.64 A	10.70
5 + 5 + 12	1.60	1.60	3.20			6.40 (2.90 - 8.50)	3.72 A	8.00	2.18	2.18	4.34			8.70 (2.70 - 12.30)	3.73 A	10.90
5 + 5 + 15	1.60	1.60	4.00			7.20 (2.90 - 8.50)	3.55 A	9.40	2.16	2.16	5.38			9.60 (2.70 - 12.30)	3.51 B	13.00
5 + 5 + 18	1.60	1.60	5.00			8.20 (2.90 - 8.70)	3.58 A	10.80	2.11	2.11	6.58			10.80 (2.70 - 12.90)	3.56 A	12.80
5 + 5 + 21	1.60	1.60	6.00			9.20 (2.90 - 10.10)	3.38 A	12.50	2.09	2.09	7.82			12.00 (2.70 - 13.60)	3.77 A	14.90
5 + 5 + 24	1.57	1.57	6.86			10.00 (2.90 - 10.70)	3.22 A	14.30	1.88	1.88	8.24			12.00 (2.70 - 13.60)	3.80 A	14.80
5 + 7 + 7	1.60	2.00	2.00			5.60 (2.90 - 8.50)	4.06 A	6.60	2.32	2.89	2.89			8.10 (2.70 - 12.30)	3.75 A	10.20
5 + 7 + 9 ¹	1.60	2.00	2.50			6.10 (2.90 - 8.50)	3.81 A	7.50	2.23	2.79	3.48			8.50 (2.70 - 12.30)	3.59 B	11.10
5 + 7 + 9 ²	1.60	2.00	2.80			6.40 (2.90 - 8.50)	3.72 A	8.00	2.20	2.75	3.85			8.80 (2.70 - 12.30)	3.47 B	11.30
5 + 7 + 12	1.60	2.00	3.20			6.80 (2.90 - 8.50)	3.70 A	8.50	2.18	2.74	4.38			9.30 (2.70 - 12.30)	3.68 A	11.90
5 + 7 + 15	1.60															

Free Multi combinations table

Free Multi 5x1

Free Multi 5x1 CU-5E34PBE. Minimum capacity connected: 4.5 kW. Maximum capacity connected: 17.5 kW																		
Indoor unit capacity	Cooling capacity (kW). Rooms					EER	Current W/W	Heating capacity (kW). Rooms					COP	Current W/W				
	A	B	C	D	E			Total (Min - Max)	A	B	C	D			E	Total (Min - Max)		
4 Rooms																		
5+5+5+5	1.60	1.60	1.60	1.60	1.60	6.40	2.90	10.60	4.13	4.20	2.88	2.88	2.88	11.52	3.40	14.20	4.00	13.50
5+5+5+7	1.60	1.60	1.60	2.00	1.60	6.80	2.90	10.60	4.00	4.20	2.71	2.71	2.71	11.52	3.40	14.20	4.03	13.40
5+5+5+9	1.60	1.60	1.60	2.50	1.60	7.30	2.90	10.60	3.86	4.20	2.52	2.52	2.52	11.52	3.40	14.20	4.03	13.40
5+5+5+9	1.60	1.60	1.60	2.80	1.60	7.60	2.90	10.60	3.78	4.20	2.43	2.43	2.43	11.52	3.40	14.20	4.03	13.40
5+5+5+12	1.60	1.60	1.60	3.20	1.60	8.00	2.90	10.60	3.67	4.20	2.30	2.30	2.30	11.52	3.40	14.20	4.07	13.30
5+5+5+15	1.60	1.60	1.60	4.00	1.60	8.80	2.90	10.60	3.44	4.20	2.09	2.09	2.09	11.52	3.40	14.20	4.09	13.30
5+5+5+18	1.60	1.60	1.60	5.00	1.60	9.80	2.90	10.60	3.44	4.20	1.88	1.88	1.88	11.52	3.40	14.20	4.25	12.70
5+5+5+21	1.48	1.48	1.48	5.56	1.60	10.00	2.90	10.60	3.33	4.20	1.71	1.71	1.71	11.52	3.40	14.20	4.25	12.70
5+5+5+24	1.36	1.36	1.36	5.92	1.60	10.00	2.90	10.60	3.41	4.20	1.56	1.56	1.56	11.52	3.40	14.20	4.27	12.70
5+5+7+7	1.60	1.60	2.00	2.00	1.60	7.20	2.90	10.60	3.96	4.80	2.56	2.56	3.20	11.52	3.40	14.20	4.04	13.40
5+5+7+9	1.60	1.60	2.00	2.50	1.60	7.70	2.90	10.60	3.76	4.80	2.39	2.39	2.97	11.52	3.40	14.20	4.04	13.40
5+5+7+9	1.60	1.60	2.00	2.80	1.60	8.00	2.90	10.60	3.67	4.80	2.30	2.30	2.88	11.52	3.40	14.20	4.04	13.40
5+5+7+12	1.60	1.60	2.00	3.20	1.60	8.40	2.90	10.60	3.64	4.80	2.19	2.19	2.74	11.52	3.40	14.20	4.09	13.30
5+5+7+15	1.60	1.60	2.00	4.00	1.60	9.20	2.90	10.60	3.36	4.80	2.00	2.00	2.50	11.52	3.40	14.20	4.10	13.20
5+5+7+18	1.57	1.57	1.96	4.90	1.60	10.00	2.90	10.60	3.33	4.80	1.81	1.81	2.25	11.52	3.40	14.20	4.27	12.70
5+5+7+21	1.43	1.43	1.78	5.36	1.60	10.00	2.90	10.60	3.33	4.80	1.65	1.65	2.05	11.52	3.40	14.20	4.27	12.70
5+5+7+24	1.31	1.31	1.64	5.74	1.60	10.00	2.90	10.60	3.41	4.80	1.51	1.51	1.89	11.52	3.40	14.20	4.28	12.60
5+5+9+9	1.60	1.60	2.50	2.50	1.60	8.20	2.90	10.60	3.64	4.80	2.25	2.25	3.51	11.52	3.40	14.20	4.04	13.40
5+5+9+9	1.60	1.60	2.50	2.80	1.60	8.50	2.90	10.60	3.57	4.80	2.17	2.17	3.39	11.52	3.40	14.20	4.04	13.40
5+5+9+12	1.60	1.60	2.50	3.20	1.60	8.90	2.90	10.60	3.48	4.80	2.07	2.07	3.24	11.52	3.40	14.20	4.09	13.30
5+5+9+15	1.60	1.60	2.50	4.00	1.60	9.70	2.90	10.60	3.23	4.80	1.90	1.90	2.97	11.52	3.40	14.20	4.10	13.20
5+5+9+18	1.50	1.50	2.33	4.67	1.60	10.00	2.90	10.60	3.33	4.80	1.72	1.72	2.69	11.52	3.40	14.20	4.27	12.70
5+5+9+21	1.37	1.37	2.13	5.13	1.60	10.00	2.90	10.60	3.33	4.80	1.58	1.58	2.45	11.52	3.40	14.20	4.27	12.70
5+5+9+24	1.26	1.26	1.97	5.51	1.60	10.00	2.90	10.60	3.41	4.80	1.45	1.45	2.27	11.52	3.40	14.20	4.28	12.60
5+5+9+24	1.60	1.60	2.80	2.80	1.60	8.80	2.90	10.60	3.44	4.80	2.09	2.09	3.67	11.52	3.40	14.20	4.04	13.40
5+5+9+24	1.60	1.60	2.80	3.20	1.60	9.20	2.90	10.60	3.36	4.80	2.00	2.00	3.51	11.52	3.40	14.20	4.09	13.30
5+5+9+24	1.60	1.60	2.80	4.00	1.60	10.00	2.90	10.60	3.17	4.80	1.84	1.84	3.23	11.52	3.40	14.20	4.10	13.20
5+5+9+24	1.45	1.45	2.55	4.55	1.60	10.00	2.90	10.60	3.33	4.80	1.68	1.68	2.92	11.52	3.40	14.20	4.27	12.70
5+5+9+24	1.33	1.33	2.33	5.01	1.60	10.00	2.90	10.60	3.33	4.80	1.54	1.54	2.68	11.52	3.40	14.20	4.27	12.70
5+5+9+24	1.23	1.23	2.15	5.39	1.60	10.00	2.90	10.60	3.41	4.80	1.42	1.42	2.48	11.52	3.40	14.20	4.28	12.60
5+5+12+12	1.60	1.60	3.20	3.20	1.60	9.60	2.90	10.60	3.57	4.80	1.92	1.92	3.84	11.52	3.40	14.20	4.11	13.20
5+5+12+15	1.54	1.54	3.07	3.85	1.60	10.00	2.90	10.60	3.17	4.80	1.77	1.77	3.54	11.52	3.40	14.20	4.13	13.10
5+5+12+18	1.40	1.40	2.81	4.39	1.60	10.00	2.90	10.60	3.41	4.80	1.62	1.62	3.23	11.52	3.40	14.20	4.30	12.60
5+5+12+21	1.29	1.29	2.29	4.84	1.60	10.00	2.90	10.60	3.41	4.80	1.49	1.49	2.97	11.52	3.40	14.20	4.30	12.60
5+5+12+24	1.19	1.19	2.39	5.23	1.60	10.00	2.90	10.60	3.41	4.80	1.38	1.38	2.74	11.52	3.40	14.20	4.24	12.80
5+5+15+15	1.43	1.43	3.57	3.57	1.60	10.00	2.90	10.60	3.17	4.80	1.65	1.65	3.11	11.52	3.40	14.20	4.14	13.10
5+5+15+18	1.31	1.31	3.28	4.10	1.60	10.00	2.90	10.60	3.41	4.80	1.51	1.51	3.78	11.52	3.40	14.20	4.24	12.80
5+5+15+21	1.21	1.21	3.03	4.55	1.60	10.00	2.90	10.60	3.41	4.80	1.40	1.40	3.48	11.52	3.40	14.20	4.24	12.80
5+5+15+24	1.13	1.13	2.81	4.93	1.60	10.00	2.90	10.60	3.41	4.80	1.30	1.30	3.24	11.52	3.40	14.20	4.25	12.70
5+5+18+18	1.21	1.21	3.79	3.79	1.60	10.00	2.90	10.60	3.57	4.80	1.40	1.40	4.36	11.52	3.40	14.20	4.30	12.60
5+5+18+21	1.13	1.13	3.51	4.23	1.60	10.00	2.90	10.60	3.57	4.80	1.30	1.30	4.05	11.52	3.40	14.20	4.30	12.60
5+5+18+24	1.05	1.05	3.29	4.61	1.60	10.00	2.90	10.60	3.57	4.80	1.21	1.21	3.79	11.52	3.40	14.20	4.30	12.60
5+5+21+21	0.95	0.95	3.95	3.95	1.60	10.00	2.90	10.60	3.57	4.80	1.21	1.21	4.55	11.52	3.40	14.20	4.30	12.60
5+5+21+24	0.89	0.89	3.79	4.32	1.60	10.00	2.90	10.60	3.57	4.80	1.14	1.14	4.26	11.52	3.40	14.20	4.30	12.60
5+5+24+24	0.93	0.93	4.07	4.07	1.60	10.00	2.90	10.60	3.57	4.80	1.07	1.07	4.69	11.52	3.40	14.20	4.31	12.50
5+7+7+7	1.60	2.00	2.00	2.00	1.60	7.60	2.90	10.60	3.78	4.80	2.43	3.03	3.03	11.52	3.40	14.20	4.06	13.30
5+7+7+9	1.60	2.00	2.00	2.50	1.60	8.10	2.90	10.60	3.72	4.80	2.28	2.84	3.56	11.52	3.40	14.20	4.06	13.30
5+7+7+9	1.60	2.00	2.00	2.80	1.60	8.40	2.90	10.60	3.65	4.80	2.19	2.74	3.74	11.52	3.40	14.20	4.06	13.30
5+7+7+12	1.60	2.00	2.00	3.20	1.60	8.80	2.90	10.60	3.53	4.80	2.02	2.42	4.20	11.52	3.40	14.20	4.10	13.20
5+7+7+15	1.60	2.00	2.00	4.00	1.60	9.60	2.90	10.60	3.30	4.80	1.82	2.10	4.00	11.52	3.40	14.20	4.13	13.10
5+7+7+18	1.50	1.89	1.89	4.72	1.60	10.00	2.90	10.60	3.41	4.80	1.74	1.74	2.17	11.52	3.40	14.20	4.28	12.60
5+7+7+21	1.38	1.72	1.72	5.18	1.60	10.00	2.90	10.60	3.41	4.80	1.59	1.59	1.99	11.52	3.40	14.20	4.28	12.60
5+7+7+24	1.26	1.59	1.59	5.56	1.60	10.00	2.90	10.60	3.41	4.80	1.46	1.83	1.83	11.52	3.40	14.20	4.30	12.60
5+7+9+9	1.60	2.00	2.50	2.50	1.60	8.60	2.90	10.60	3.51	4.80	2.14	2.48	3.35	11.52	3.40	14.20	4.06	13.30
5+7+9+9	1.60	2.00	2.50	2.80	1.60	8.90	2.90	10.60	3.48	4.80	2.07	2.59	3.24	11.52	3.40	14.20	4.06	13.30
5+7+9+12	1.60	2.00	2.50	3.20	1.60	9.30	2.90	10.60	3.39	4.80	1.98	2.40	3.16	11.52	3.40	14.20	4.10	13.20
5+7+9+15	1.58	1.98	2.48	3.96	1.60	10.00	2.90	10.60	3.17	4.80	1.82	2.28	2.85	11.52	3.40	14.20	4.11	13.20
5+7+9+18	1.44	1.80	2.25	4.51	1.60	10.00	2.90	10.60	3.41	4.80	1.66	2.08	2.59	11.52	3.40	14.20	4.28	12.60
5+7+9+24	1.32	1.65</																

Free Multi 5x1

Free Multi 5x1 CU-5E34PBE. Minimum capacity connected: 4.5 kW. Maximum capacity connected: 17.5 kW																				
Indoor unit capacity	Cooling capacity (kW), Rooms					EER	W/W	Heating capacity (kW), Rooms					COP	Current (A)						
	A	B	C	D	E			Total (Min - Max)	A	B	C	D			E	Total (Min - Max)				
4 Room																				
7* 9* 12	1.42	2.00	2.29	4.29	10.00	2.90	10.80	3.41	A	13.50	1.71	2.40	2.74	5.15	12.00	3.40	14.40	4.20	A	13.40
7* 9* 12-14	1.33	1.87	2.13	4.67	10.00	2.90	11.00	3.50	A	13.20	1.60	2.24	2.56	4.60	12.00	3.40	14.40	4.21	A	13.40
7* 9* 15-15	1.55	1.19	3.13	3.13	10.00	2.90	10.80	3.26	A	14.20	1.87	2.63	3.75	3.75	12.00	3.40	14.40	4.12	A	13.40
7* 9* 15-18	1.45	2.03	2.90	4.62	10.00	2.90	11.00	3.41	A	13.50	1.74	2.43	3.48	4.35	12.00	3.40	14.40	4.21	A	13.40
7* 9* 15-21	1.35	1.89	2.70	4.06	10.00	2.90	11.00	3.41	A	13.50	1.62	2.27	3.24	4.87	12.00	3.40	14.40	4.21	A	13.40
7* 9* 15-24	1.27	1.77	2.53	4.43	10.00	2.90	11.20	3.50	A	13.20	1.51	2.13	3.04	3.32	12.00	3.40	14.40	4.23	A	13.40
7* 9* 18-18	1.35	1.89	3.38	3.38	10.00	2.90	11.00	3.57	A	12.90	1.62	2.28	4.05	4.05	12.00	3.40	14.40	4.20	A	13.40
7* 9* 18-21	1.27	1.77	3.16	3.80	10.00	2.90	11.20	3.57	A	12.90	1.51	2.13	3.80	4.56	12.00	3.40	14.40	4.20	A	13.40
7* 9* 18-24	1.18	1.67	2.98	4.17	10.00	2.90	11.20	3.57	A	12.90	1.43	2.00	3.57	5.00	12.00	3.40	14.40	4.20	A	13.40
7* 9* 21-21	1.19	1.67	3.57	3.57	10.00	2.90	11.20	3.57	A	12.90	1.40	2.00	4.29	4.29	12.00	3.40	14.40	4.20	A	13.40
7* 12-12-12	1.72	2.76	2.76	2.76	10.00	2.90	10.60	3.26	A	14.20	2.07	3.31	3.31	3.31	12.00	3.40	14.20	4.14	A	13.60
7* 12-15-15	1.61	2.58	2.58	3.23	10.00	2.90	10.80	3.26	A	14.20	1.93	3.10	3.10	3.87	12.00	3.40	14.20	4.07	A	13.90
7* 12-18-18	1.49	2.39	2.39	3.73	10.00	2.90	10.80	3.26	A	14.20	1.78	2.87	2.87	4.48	12.00	3.40	14.20	4.07	A	13.90
7* 12-21-21	1.39	2.22	2.22	4.17	10.00	2.90	11.00	3.50	A	13.20	1.66	2.67	2.67	5.00	12.00	3.40	14.40	4.23	A	13.30
7* 12-24-24	1.29	2.08	2.08	4.55	10.00	2.90	11.00	3.50	A	13.20	1.56	2.49	2.49	5.46	12.00	3.40	14.40	4.17	A	13.30
7* 12-15-15	1.52	2.42	3.03	3.03	10.00	2.90	10.80	3.26	A	14.20	1.81	2.91	3.64	3.64	12.00	3.40	14.40	4.08	A	13.80
7* 12-15-18	1.41	2.25	2.82	3.52	10.00	2.90	11.00	3.50	A	13.20	1.69	2.70	3.38	4.23	12.00	3.40	14.40	4.17	A	13.50
7* 12-15-21	1.31	2.11	2.63	3.95	10.00	2.90	11.00	3.50	A	13.20	1.57	2.53	3.16	4.74	12.00	3.40	14.40	4.17	A	13.50
7* 12-15-24	1.23	1.98	2.47	4.32	10.00	2.90	11.20	3.50	A	13.20	1.48	2.37	2.96	5.19	12.00	3.40	14.40	4.18	A	13.50
7* 12-18-18	1.31	2.11	3.29	3.29	10.00	2.90	11.00	3.57	A	12.90	1.57	2.53	3.95	3.95	12.00	3.40	14.40	4.21	A	13.40
7* 12-18-21	1.23	1.98	3.09	3.70	10.00	2.90	11.20	3.57	A	12.90	1.48	2.37	3.70	4.45	12.00	3.40	14.40	4.21	A	13.40
7* 12-18-24	1.16	1.86	2.91	4.07	10.00	2.90	11.20	3.57	A	12.90	1.40	2.23	3.49	4.88	12.00	3.40	14.40	4.23	A	13.30
7* 12-21-21	1.16	1.86	3.49	3.49	10.00	2.90	11.20	3.50	A	13.00	1.39	2.23	4.19	4.19	12.00	3.40	14.40	4.21	A	13.40
7* 15-15-15	1.42	2.86	2.86	2.86	10.00	2.90	10.80	3.33	A	13.80	1.71	3.43	3.43	3.43	12.00	3.40	14.40	4.10	A	13.80
7* 15-15-18	1.33	2.67	2.67	3.33	10.00	2.90	11.00	3.50	A	13.20	1.60	3.20	3.20	4.00	12.00	3.40	14.40	4.18	A	13.50
7* 15-15-21	1.25	2.50	2.50	3.75	10.00	2.90	11.20	3.50	A	13.20	1.50	3.00	3.00	4.50	12.00	3.40	14.40	4.18	A	13.50
7* 15-18-18	1.19	2.35	2.35	4.12	10.00	2.90	11.00	3.50	A	13.20	1.41	2.82	2.82	4.95	12.00	3.40	14.40	4.20	A	13.40
7* 15-18-21	1.24	2.50	3.13	3.13	10.00	2.90	11.20	3.57	A	12.90	1.50	3.00	3.75	3.75	12.00	3.40	14.40	4.23	A	13.30
7* 15-18-24	1.12	2.50	3.13	3.13	10.00	2.90	11.20	3.50	A	13.20	1.40	2.80	3.00	4.20	12.00	3.40	14.40	4.20	A	13.40
7* 15-21-21	1.18	2.35	2.94	3.53	10.00	2.90	11.20	3.57	A	12.90	1.41	2.82	3.53	4.24	12.00	3.40	14.40	4.23	A	13.30
7* 18-18-18	1.18	2.94	2.94	2.94	10.00	2.90	11.20	3.64	A	12.70	1.41	3.53	3.53	3.53	12.00	3.40	14.40	4.21	A	13.70
9* 9* 9* 9* 9*	2.50	2.50	2.50	2.50	10.00	2.90	10.60	3.18	A	14.80	3.00	3.00	3.00	3.00	12.00	3.40	14.20	4.01	A	14.10
9* 9* 9* 9* 9*	2.43	2.43	2.43	2.43	10.00	2.90	10.60	3.18	A	14.80	2.91	2.91	2.91	2.91	12.00	3.40	14.20	4.01	A	14.10
9* 9* 9* 9* 9*	2.34	2.34	2.34	2.34	10.00	2.90	10.60	3.17	A	14.80	2.80	2.80	2.80	2.80	12.00	3.40	14.20	4.01	A	13.90
9* 9* 9* 9* 9*	2.17	2.17	2.17	2.17	10.00	2.90	10.60	3.17	A	14.80	2.61	2.61	2.61	2.61	12.00	3.40	14.20	4.01	A	13.90
9* 9* 9* 9* 9*	2.00	2.00	2.00	2.00	10.00	2.90	10.80	3.41	A	13.50	2.40	2.40	2.40	2.40	12.00	3.40	14.20	4.15	A	13.60
9* 9* 9* 9* 9*	1.85	1.85	1.85	1.85	10.00	2.90	10.80	3.41	A	13.50	2.22	2.22	2.22	2.22	12.00	3.40	14.20	4.15	A	13.60
9* 9* 9* 9* 9*	1.72	1.72	1.72	1.72	10.00	2.90	11.00	3.41	A	13.50	2.07	2.07	2.07	2.07	12.00	3.40	14.20	4.17	A	13.50
9* 9* 9* 9* 9*	1.58	1.58	1.58	1.58	10.00	2.90	11.00	3.41	A	13.50	1.93	1.93	1.93	1.93	12.00	3.40	14.20	4.17	A	13.50
9* 9* 9* 9* 9*	1.42	1.42	1.42	1.42	10.00	2.90	11.00	3.41	A	13.50	1.79	1.79	1.79	1.79	12.00	3.40	14.20	4.17	A	13.50
9* 9* 9* 9* 9*	1.27	1.27	1.27	1.27	10.00	2.90	11.00	3.41	A	13.50	1.64	1.64	1.64	1.64	12.00	3.40	14.20	4.17	A	13.50
9* 9* 9* 9* 9*	1.12	1.12	1.12	1.12	10.00	2.90	11.00	3.41	A	13.50	1.54	1.54	1.54	1.54	12.00	3.40	14.20	4.17	A	13.50
9* 9* 9* 9* 9*	1.07	1.07	1.07	1.07	10.00	2.90	11.00	3.41	A	13.50	1.49	1.49	1.49	1.49	12.00	3.40	14.20	4.17	A	13.50
9* 9* 9* 9* 9*	1.02	1.02	1.02	1.02	10.00	2.90	11.00	3.41	A	13.50	1.44	1.44	1.44	1.44	12.00	3.40	14.20	4.17	A	13.50
9* 9* 9* 9* 9*	0.97	0.97	0.97	0.97	10.00	2.90	11.00	3.41	A	13.50	1.39	1.39	1.39	1.39	12.00	3.40	14.20	4.17	A	13.50
9* 9* 9* 9* 9*	0.92	0.92	0.92	0.92	10.00	2.90	11.00	3.41	A	13.50	1.34	1.34	1.34	1.34	12.00	3.40	14.20	4.17	A	13.50
9* 9* 9* 9* 9*	0.87	0.87	0.87	0.87	10.00	2.90	11.00	3.41	A	13.50	1.29	1.29	1.29	1.29	12.00	3.40	14.20	4.17	A	13.50
9* 9* 9* 9* 9*	0.82	0.82	0.82	0.82	10.00	2.90	11.00	3.41	A	13.50	1.24	1.24	1.24	1.24	12.00	3.40	14.20	4.17	A	13.50
9* 9* 9* 9* 9*	0.77	0.77	0.77	0.77	10.00	2.90	11.00	3.41	A	13.50	1.19	1.19	1.19	1.19	12.00	3.40	14.20	4.17	A	13.50
9* 9* 9* 9* 9*	0.72	0.72	0.72	0.72	10.00	2.90	11.00	3.41	A	13.50	1.14	1.14	1.14	1.14	12.00	3.40	14.20	4.17	A	13.50
9* 9* 9* 9* 9*	0.67	0.67	0.67	0.67	10.00	2.90	11.00	3.41	A	13.50	1.09	1.09	1.09	1.09	12.00	3.40	14.20	4.17	A	13.50
9* 9* 9* 9* 9*	0.62	0.62	0.62	0.62	10.00	2.90	11.00	3.41	A	13.50	1.04	1.04	1.04	1.04	12.00	3.40	14.20	4.17	A	13.50
9* 9* 9* 9* 9*	0.57	0.57	0.57	0.57	10.00	2.90	11.00	3.41	A	13.50	0.99	0.99	0.99	0.99	12.00	3.40	14.20	4.17	A	13.50
9* 9* 9* 9* 9*	0.52	0.52	0.52	0.52	10.00	2.90	11.00	3.41	A	13.50	0.94	0.94	0.94	0.94	12.00	3.40	14			

Free Multi combinations table

Free Multi 5x1

Free Multi 5x1 CU-5E34PBE. Minimum capacity connected: 4.5 kW. Maximum capacity connected: 17.5 kW																		
Indoor unit capacity	Cooling capacity (kW). Rooms					EER	Current	Heating capacity (kW). Rooms					COP	Current				
	A	B	C	D	E			Total (Min - Max)	W/W	230V (A)	A	B			C	D	E	Total (Min - Max)
5 Room																		
5+5+9+12+12	1.32	1.32	2.00	2.64	2.64	10.00	(2.90 - 11.50)	3.57	1.59	1.59	2.48	3.17	3.17	12.00	(3.40 - 14.50)	4.23	14.30	
5+5+9+12+15	1.26	1.24	1.94	2.40	3.10	10.00	(2.90 - 11.50)	3.57	1.59	1.59	2.48	3.17	3.17	12.00	(3.40 - 14.50)	4.24	13.30	
5+5+9+12+18	1.15	1.15	1.80	2.40	3.10	10.00	(2.90 - 11.50)	3.55	1.50	1.50	2.38	2.97	2.97	12.00	(3.40 - 14.50)	4.21	13.30	
5+5+9+12+21	1.07	1.07	1.68	2.15	4.03	10.00	(2.90 - 11.50)	3.55	1.50	1.50	2.38	2.97	2.97	12.00	(3.40 - 14.50)	4.21	13.30	
5+5+9+12+24	1.01	1.01	1.57	2.01	4.40	10.00	(2.90 - 11.50)	3.64	1.27	1.27	2.11	2.88	2.88	12.00	(3.40 - 14.50)	4.15	13.60	
5+5+9+15+15	1.17	1.17	1.82	2.92	2.92	10.00	(2.90 - 11.50)	3.57	1.29	1.29	2.00	3.50	3.50	12.00	(3.40 - 14.50)	4.18	13.50	
5+5+9+15+18	1.09	1.09	1.70	2.72	3.40	10.00	(2.90 - 11.50)	3.55	1.30	1.31	2.03	3.27	4.08	12.00	(3.40 - 14.50)	4.14	13.60	
5+5+9+15+21	1.02	1.02	1.59	2.55	3.82	10.00	(2.90 - 11.50)	3.55	1.30	1.22	2.21	3.91	4.59	12.00	(3.40 - 14.50)	4.14	13.60	
5+5+9+15+24	0.96	0.96	1.49	2.40	4.19	10.00	(2.90 - 11.50)	3.64	1.27	1.15	1.15	1.80	2.87	5.03	12.00	(3.40 - 14.50)	4.15	13.60
5+5+9+18+18	1.02	1.02	1.60	3.18	3.18	10.00	(2.90 - 11.50)	3.61	1.28	1.22	1.92	3.82	3.82	12.00	(3.40 - 14.50)	4.08	13.80	
5+5+9+18+21	0.96	0.96	1.50	2.99	3.59	10.00	(2.90 - 11.50)	3.61	1.28	1.15	1.15	1.80	3.59	4.31	12.00	(3.40 - 14.50)	4.08	13.80
5+5+9+9+9+9	1.38	1.38	2.41	2.41	2.41	9.99	(2.90 - 11.50)	3.49	1.30	1.65	1.65	2.90	2.90	12.00	(3.40 - 14.50)	4.17	13.50	
5+5+9+9+9+12	1.33	1.33	2.33	2.33	2.68	10.00	(2.90 - 11.50)	3.50	1.30	1.60	1.60	2.80	2.80	12.00	(3.40 - 14.50)	4.20	13.40	
5+5+9+9+9+15	1.25	1.25	2.19	2.19	3.12	10.00	(2.90 - 11.50)	3.48	1.30	1.50	1.50	2.63	3.74	12.00	(3.40 - 14.50)	4.21	13.40	
5+5+9+9+9+18	1.16	1.16	2.03	2.03	3.62	10.00	(2.90 - 11.50)	3.56	1.30	1.39	1.39	2.43	4.36	12.00	(3.40 - 14.50)	4.18	13.50	
5+5+9+9+9+21	1.08	1.08	1.89	1.89	4.06	10.00	(2.90 - 11.50)	3.56	1.30	1.30	2.27	2.77	4.86	12.00	(3.40 - 14.50)	4.18	13.50	
5+5+9+9+9+24	1.01	1.01	1.77	1.77	4.44	10.00	(2.90 - 11.50)	3.55	1.30	1.22	2.22	3.13	5.30	12.00	(3.40 - 14.50)	4.20	13.40	
5+5+9+12+12	1.29	1.29	2.26	2.58	2.58	10.00	(2.90 - 11.50)	3.57	1.29	1.55	1.55	2.70	3.10	12.00	(3.40 - 14.50)	4.23	13.30	
5+5+9+12+15	1.21	1.21	2.13	2.42	3.03	10.00	(2.90 - 11.50)	3.57	1.29	1.45	1.45	2.55	2.91	3.44	12.00	(3.40 - 14.50)	4.24	13.30
5+5+9+12+18	1.13	1.13	1.97	2.25	3.52	10.00	(2.90 - 11.50)	3.55	1.30	1.35	1.35	2.37	4.23	12.00	(3.40 - 14.50)	4.21	13.30	
5+5+9+12+21	1.05	1.05	1.84	2.11	3.95	10.00	(2.90 - 11.50)	3.55	1.30	1.24	1.24	2.21	2.53	4.74	12.00	(3.40 - 14.50)	4.21	13.30
5+5+9+12+24	0.99	0.99	1.72	1.98	4.32	10.00	(2.90 - 11.50)	3.64	1.27	1.19	1.19	2.06	3.27	5.19	12.00	(3.40 - 14.50)	4.15	13.60
5+5+9+15+15	1.14	1.14	2.00	2.86	2.86	10.00	(2.90 - 11.50)	3.57	1.29	1.37	1.37	2.40	3.43	3.43	12.00	(3.40 - 14.50)	4.18	13.50
5+5+9+15+18	1.07	1.07	1.86	2.67	3.33	10.00	(2.90 - 11.50)	3.55	1.30	1.28	1.28	2.24	3.20	4.00	12.00	(3.40 - 14.50)	4.14	13.60
5+5+9+15+21	1.00	1.00	1.75	2.50	3.75	10.00	(2.90 - 11.50)	3.55	1.30	1.20	1.20	2.10	3.00	4.50	12.00	(3.40 - 14.50)	4.14	13.60
5+5+9+15+24	0.94	0.94	1.65	2.35	4.12	10.00	(2.90 - 11.50)	3.64	1.27	1.13	1.13	1.98	2.82	4.94	12.00	(3.40 - 14.50)	4.15	13.60
5+5+9+18+18	1.00	1.00	1.75	3.12	3.12	10.00	(2.90 - 11.50)	3.61	1.28	1.20	1.20	2.10	3.75	3.75	12.00	(3.40 - 14.50)	4.08	13.80
5+5+9+18+21	0.94	0.94	1.65	2.94	3.53	10.00	(2.90 - 11.50)	3.61	1.28	1.13	1.13	1.97	3.53	4.24	12.00	(3.40 - 14.50)	4.08	13.80
5+5+12+12+12	1.25	1.25	2.50	2.50	2.50	10.00	(2.90 - 11.50)	3.57	1.29	1.50	1.50	3.00	3.00	12.00	(3.40 - 14.50)	4.18	13.50	
5+5+12+12+15	1.18	1.18	2.35	2.35	2.94	10.00	(2.90 - 11.50)	3.57	1.29	1.41	1.41	2.82	2.82	3.54	12.00	(3.40 - 14.50)	4.20	13.40
5+5+12+12+18	1.10	1.10	2.19	2.19	3.42	10.00	(2.90 - 11.50)	3.64	1.27	1.32	1.32	2.63	4.10	12.00	(3.40 - 14.50)	4.15	13.60	
5+5+12+12+21	1.03	1.03	2.05	2.05	3.84	10.00	(2.90 - 11.50)	3.64	1.27	1.23	1.23	2.46	4.46	12.00	(3.40 - 14.50)	4.15	13.60	
5+5+12+12+24	0.96	0.96	1.93	1.93	4.22	10.00	(2.90 - 11.50)	3.62	1.27	1.16	1.16	2.11	3.31	5.06	12.00	(3.40 - 14.50)	4.17	13.50
5+5+12+15+15	1.11	1.11	2.22	2.78	2.78	10.00	(2.90 - 11.50)	3.57	1.29	1.33	1.33	2.68	3.33	3.33	12.00	(3.40 - 14.50)	4.21	13.40
5+5+12+15+18	1.04	1.04	2.07	2.60	3.25	10.00	(2.90 - 11.50)	3.64	1.27	1.25	1.25	2.48	3.12	3.90	12.00	(3.40 - 14.50)	4.17	13.50
5+5+12+15+21	0.98	0.98	1.94	2.44	3.66	10.00	(2.90 - 11.50)	3.64	1.27	1.17	1.17	2.14	2.93	4.39	12.00	(3.40 - 14.50)	4.17	13.50
5+5+12+15+24	0.91	0.91	1.80	2.40	4.02	10.00	(2.90 - 11.50)	3.64	1.27	1.10	1.10	2.21	2.76	4.83	12.00	(3.40 - 14.50)	4.14	13.70
5+5+12+18+18	0.98	0.98	1.94	3.05	3.05	10.00	(2.90 - 11.50)	3.60	1.28	1.17	1.17	2.34	3.66	3.66	12.00	(3.40 - 14.50)	4.03	14.00
5+5+12+18+21	0.92	0.92	1.84	2.87	3.45	10.00	(2.90 - 11.50)	3.60	1.28	1.10	1.10	2.21	3.45	4.14	12.00	(3.40 - 14.50)	4.03	14.00
5+5+15+15+15	1.05	1.05	2.63	2.63	2.63	9.99	(2.90 - 11.50)	3.57	1.29	1.26	1.26	3.16	3.16	12.00	(3.40 - 14.50)	4.21	13.40	
5+5+15+15+18	0.99	0.99	2.47	2.47	3.08	10.00	(2.90 - 11.50)	3.64	1.27	1.19	1.19	2.96	2.96	3.70	12.00	(3.40 - 14.50)	4.10	13.80
5+5+15+15+21	0.93	0.93	2.33	2.33	3.48	10.00	(2.90 - 11.50)	3.64	1.27	1.12	1.12	2.79	4.12	12.00	(3.40 - 14.50)	4.10	13.80	
5+5+15+18+18	0.93	0.93	2.32	2.91	2.91	10.00	(2.90 - 11.50)	3.60	1.28	1.12	1.12	2.78	4.39	3.49	12.00	(3.40 - 14.50)	4.04	14.00
5+7+7+7+7	1.60	2.00	2.00	2.00	2.00	9.60	(2.90 - 11.50)	3.62	1.22	2.00	2.50	2.50	2.50	2.50	12.00	(3.40 - 14.50)	4.00	14.00
5+7+7+7+9	1.58	1.98	1.98	1.98	2.48	10.00	(2.90 - 11.50)	3.50	1.30	1.89	2.38	2.38	2.37	2.37	12.00	(3.40 - 14.50)	4.18	13.50
5+7+7+7+12	1.54	1.92	1.92	1.92	2.70	10.00	(2.90 - 11.50)	3.50	1.30	1.84	2.31	2.31	3.23	3.23	12.00	(3.40 - 14.50)	4.18	13.50
5+7+7+7+15	1.48	1.85	1.85	1.85	2.97	10.00	(2.90 - 11.50)	3.48	1.30	1.78	2.22	2.22	3.56	3.56	12.00	(3.40 - 14.50)	4.21	13.40
5+7+7+7+18	1.38	1.72	1.72	1.72	3.46	10.00	(2.90 - 11.50)	3.58	1.29	1.65	2.07	2.07	4.14	12.00	(3.40 - 14.50)	4.24	13.30	
5+7+7+7+21	1.26	1.59	1.59	1.59	3.97	10.00	(2.90 - 11.50)	3.56	1.30	1.52	1.90	1.90	4.78	12.00	(3.40 - 14.50)	4.20	13.40	
5+7+7+7+24	1.18	1.47	1.47	1.47	4.41	10.00	(2.90 - 11.50)	3.56	1.30	1.41	1.76	1.76	5.17	12.00	(3.40 - 14.50)	4.20	13.40	
5+7+9+9+9	1.50	1.89	1.89	2.36	2.36	10.00	(2.90 - 11.50)	3.50	1.30	1.82	2.64	2.64	3.73	3.73	12.00	(3.40 - 14.50)	4.18	13.50
5+7+9+9+12	1.47	1.83	1.83	2.29	2.58	10.00	(2.90 - 11.50)	3.50	1.30	1.76	2.20	2.20	3.75	3.75	12.00	(3.40 - 14.50)	4.18	13.50
5+7+9+9+15	1.42	1.79	1.79	2.25	2.53	10.00	(2.90 - 11.50)	3.50	1.30	1.70	2.12	2.12	4.05	3.41	12.00	(3.40 - 14.50)	4.21	13.40
5+7+9+9+18	1.32	1.65	1.65	2.07	3.31	10.00	(2.90 - 11.50)	3.58	1.29	1.59	1.98	1.98	4.68	3.97	12.00	(3.40 - 14.50)	4.23	13.30
5+7+9+9+21	1.21	1.53	1.53	1.91	3.82	10.00	(2.90 - 11.50)	3.58	1.30	1.47	1.83	1.83	4.58	3.97	12.00	(3.40 - 14.50)	4.20	13.40
5+7+9+9+																		

Free Multi 5x1

Free Multi 5x1 CU-5E34PBE. Minimum capacity connected: 4.5 kW. Maximum capacity connected: 17.5 kW																		
Indoor unit capacity	Cooling capacity (kW), Rooms					EER	Current	Heating capacity (kW), Rooms					COP	Current				
	A	B	C	D	E			Total (Min - Max)	W/W	230V (A)	A	B			C	D	E	Total (Min - Max)
5 Room																		
7+7+7+9+21	1.38	1.38	1.38	1.72	4.14	10.00	2.90	11.50	3.56	A13.00	1.66	1.66	1.66	2.05	4.97	12.00	3.40	13.40
7+7+7+9+24	1.29	1.29	1.29	1.61	4.52	10.00	2.90	11.50	3.64	A12.70	1.55	1.55	1.55	1.93	5.42	12.00	3.40	13.40
7+7+7+9+27	1.22	1.22	1.22	1.42	2.42	10.00	2.90	11.50	3.50	A13.20	2.06	2.06	2.06	2.91	2.91	12.00	3.40	14.50
7+7+7+9+30	1.67	1.67	1.67	2.32	2.67	10.00	2.90	11.50	3.57	A12.90	2.00	2.00	2.00	2.80	3.20	12.00	3.40	13.50
7+7+7+9+33	1.56	1.56	1.56	2.19	3.13	10.00	2.90	11.50	3.57	A12.90	1.88	1.88	1.88	2.61	3.75	12.00	3.40	14.50
7+7+7+9+36	1.45	1.45	1.45	2.03	3.62	10.00	2.90	11.50	3.56	A13.00	1.74	1.74	1.74	2.43	4.26	12.00	3.40	14.50
7+7+7+9+39	1.35	1.35	1.35	1.89	4.06	10.00	2.90	11.50	3.56	A13.00	1.62	1.62	1.62	2.27	4.87	12.00	3.40	14.50
7+7+7+9+42	1.27	1.27	1.27	1.76	4.43	10.00	2.90	11.50	3.64	A12.70	1.52	1.52	1.52	2.12	5.32	12.00	3.40	14.50
7+7+7+9+45	1.60	1.60	1.60	2.60	2.60	10.00	2.90	11.50	3.57	A12.90	1.94	1.94	1.94	3.09	3.09	12.00	3.40	14.50
7+7+7+9+48	1.52	1.52	1.52	2.41	3.03	10.00	2.90	11.50	3.57	A12.90	1.82	1.82	1.82	2.90	3.64	12.00	3.40	14.50
7+7+7+9+51	1.41	1.41	1.41	2.25	3.52	10.00	2.90	11.50	3.64	A12.70	1.69	1.69	1.69	2.70	4.23	12.00	3.40	14.50
7+7+7+9+54	1.32	1.32	1.32	2.09	3.95	10.00	2.90	11.50	3.64	A12.70	1.58	1.58	1.58	2.52	4.74	12.00	3.40	14.50
7+7+7+9+57	1.23	1.23	1.23	1.98	4.33	10.00	2.90	11.50	3.62	A12.70	1.48	1.48	1.48	2.37	5.19	12.00	3.40	14.50
7+7+7+9+60	1.42	1.42	1.42	2.87	2.87	10.00	2.90	11.50	3.57	A12.90	1.72	1.72	1.72	3.42	3.42	12.00	3.40	14.50
7+7+7+9+63	1.33	1.33	1.33	2.67	3.34	10.00	2.90	11.50	3.64	A12.70	1.60	1.60	1.60	3.20	4.00	12.00	3.40	14.50
7+7+7+9+66	1.25	1.25	1.25	2.50	3.75	10.00	2.90	11.50	3.64	A12.70	1.50	1.50	1.50	3.00	4.50	12.00	3.40	14.50
7+7+7+9+69	1.18	1.18	1.18	2.34	4.12	10.00	2.90	11.50	3.62	A12.70	1.41	1.41	1.41	2.82	4.95	12.00	3.40	14.50
7+7+7+9+72	1.24	1.24	1.24	3.14	3.14	10.00	2.90	11.50	3.60	A12.80	1.50	1.50	1.50	3.75	3.75	12.00	3.40	14.50
7+7+7+9+75	1.18	1.18	1.18	2.93	3.53	10.00	2.90	11.50	3.60	A12.80	1.41	1.41	1.41	3.53	4.24	12.00	3.40	14.50
7+7+7+9+78	1.73	1.73	1.73	2.18	2.18	10.00	2.90	11.50	3.50	A13.20	2.10	2.10	2.10	2.60	2.60	12.00	3.40	14.50
7+7+7+9+81	1.69	1.69	1.69	2.12	2.12	10.00	2.90	11.50	3.50	A13.20	2.03	2.03	2.03	2.54	2.54	12.00	3.40	14.50
7+7+7+9+84	1.64	1.64	1.64	2.05	2.62	10.00	2.90	11.50	3.57	A12.90	1.97	1.97	1.97	2.46	3.14	12.00	3.40	14.50
7+7+7+9+87	1.54	1.54	1.54	1.92	3.00	10.00	2.90	11.50	3.57	A12.90	1.85	1.85	1.85	2.31	3.68	12.00	3.40	14.50
7+7+7+9+90	1.43	1.43	1.43	1.79	3.56	10.00	2.90	11.50	3.56	A13.00	1.71	1.71	1.71	2.14	4.14	12.00	3.40	14.50
7+7+7+9+93	1.33	1.33	1.33	1.67	4.00	10.00	2.90	11.50	3.56	A13.00	1.60	1.60	1.60	2.00	4.80	12.00	3.40	14.50
7+7+7+9+96	1.25	1.25	1.25	1.56	4.38	10.00	2.90	11.50	3.64	A12.70	1.50	1.50	1.50	1.88	5.24	12.00	3.40	14.50
7+7+7+9+99	1.65	1.65	1.65	2.08	2.31	10.00	2.90	11.50	3.50	A13.20	1.98	1.98	1.98	2.48	2.78	12.00	3.40	14.50
7+7+7+9+102	1.60	1.60	1.60	2.00	2.54	10.00	2.90	11.50	3.57	A12.90	1.92	1.92	1.92	2.40	2.89	12.00	3.40	14.50
7+7+7+9+105	1.50	1.50	1.50	1.88	3.01	10.00	2.90	11.50	3.57	A12.90	1.80	1.80	1.80	2.26	3.31	12.00	3.40	14.50
7+7+7+9+108	1.40	1.40	1.40	1.74	3.50	10.00	2.90	11.50	3.56	A13.00	1.68	1.68	1.68	2.09	3.25	12.00	3.40	14.50
7+7+7+9+111	1.31	1.31	1.31	1.63	3.92	10.00	2.90	11.50	3.56	A13.00	1.57	1.57	1.57	1.95	3.71	12.00	3.40	14.50
7+7+7+9+114	1.23	1.23	1.23	1.53	4.29	10.00	2.90	11.50	3.64	A12.70	1.47	1.47	1.47	1.84	4.56	12.00	3.40	14.50
7+7+7+9+117	1.55	1.55	1.55	1.94	2.48	10.00	2.90	11.50	3.57	A12.90	1.86	1.86	1.86	2.32	2.98	12.00	3.40	14.50
7+7+7+9+120	1.46	1.46	1.46	1.82	2.94	10.00	2.90	11.50	3.57	A12.90	1.75	1.75	1.75	2.19	3.51	12.00	3.40	14.50
7+7+7+9+123	1.36	1.36	1.36	1.70	3.38	10.00	2.90	11.50	3.64	A12.70	1.63	1.63	1.63	2.04	3.91	12.00	3.40	14.50
7+7+7+9+126	1.27	1.27	1.27	1.60	3.82	10.00	2.90	11.50	3.64	A12.70	1.53	1.53	1.53	1.90	4.45	12.00	3.40	14.50
7+7+7+9+129	1.20	1.20	1.20	1.49	4.19	10.00	2.90	11.50	3.62	A12.70	1.44	1.44	1.44	1.79	5.03	12.00	3.40	14.50
7+7+7+9+132	1.38	1.38	1.38	1.72	2.76	10.00	2.90	11.50	3.57	A12.90	1.66	1.66	1.66	2.06	3.31	12.00	3.40	14.50
7+7+7+9+135	1.29	1.29	1.29	1.61	3.23	10.00	2.90	11.50	3.64	A12.70	1.55	1.55	1.55	1.93	3.87	12.00	3.40	14.50
7+7+7+9+138	1.21	1.21	1.21	1.52	3.64	10.00	2.90	11.50	3.64	A12.70	1.45	1.45	1.45	1.82	4.31	12.00	3.40	14.50
7+7+7+9+141	1.14	1.14	1.14	1.43	4.00	10.00	2.90	11.50	3.62	A12.70	1.37	1.37	1.37	1.71	4.74	12.00	3.40	14.50
7+7+7+9+144	1.21	1.21	1.21	1.52	3.03	10.00	2.90	11.50	3.60	A12.80	1.45	1.45	1.45	1.82	3.64	12.00	3.40	14.50
7+7+7+9+147	1.14	1.14	1.14	1.43	3.43	10.00	2.90	11.50	3.60	A12.80	1.37	1.37	1.37	1.71	4.03	12.00	3.40	14.50
7+7+7+9+150	1.61	1.61	1.61	2.26	2.26	10.00	2.90	11.50	3.50	A13.20	1.95	1.95	1.95	2.70	2.70	12.00	3.40	14.50
7+7+7+9+153	1.56	1.56	1.56	2.19	2.19	10.00	2.90	11.50	3.57	A12.90	1.88	1.88	1.88	2.63	2.63	12.00	3.40	14.50
7+7+7+9+156	1.47	1.47	1.47	2.06	2.06	10.00	2.90	11.50	3.57	A12.90	1.76	1.76	1.76	2.47	3.54	12.00	3.40	14.50
7+7+7+9+159	1.37	1.37	1.37	1.92	3.42	10.00	2.90	11.50	3.56	A13.00	1.64	1.64	1.64	2.30	4.12	12.00	3.40	14.50
7+7+7+9+162	1.28	1.28	1.28	1.79	3.86	10.00	2.90	11.50	3.56	A13.00	1.54	1.54	1.54	2.15	4.62	12.00	3.40	14.50
7+7+7+9+165	1.20	1.20	1.20	1.69	4.22	10.00	2.90	11.50	3.64	A12.70	1.45	1.45	1.45	2.02	5.06	12.00	3.40	14.50
7+7+7+9+168	1.52	1.52	1.52	2.42	2.42	10.00	2.90	11.50	3.57	A12.90	1.82	1.82	1.82	2.54	2.91	12.00	3.40	14.50
7+7+7+9+171	1.43	1.43	1.43	1.99	2.99	10.00	2.90	11.50	3.57	A12.90	1.71	1.71	1.71	2.14	3.44	12.00	3.40	14.50
7+7+7+9+174	1.33	1.33	1.33	1.87	3.34	10.00	2.90	11.50	3.64	A12.70	1.60	1.60	1.60	2.24	3.80	12.00	3.40	14.50
7+7+7+9+177	1.25	1.25	1.25	1.75	3.75	10.00	2.90	11.50	3.64	A12.70	1.50	1.50	1.50	2.10	4.50	12.00	3.40	14.50
7+7+7+9+180	1.18	1.18	1.18	1.64	4.12	10.00	2.90	11.50	3.62	A12.70	1.41	1.41	1.41	1.98	4.94	12.00	3.40	14.50
7+7+7+9+183	1.35	1.35	1.35	1.90	2.70	10.00	2.90	11.50	3.57	A12.90	1.62	1.62	1.62	2.28	3.24	12.00	3.40	14.50
7+7+7+9+186	1.27	1.27	1.27	1.77	3.13	10.00	2.90	11.50	3.64	A12.70	1.52	1.52	1.52	2.12	3.84	12.00	3.40	14.50
7+7+7+9+189	1.19	1.19	1.19	1.67	3.58	10.00	2.90	11.50	3.64	A12.70	1.43	1.43	1.43	1.99	4.29	12.00	3.40	14.50
7+7+7+9+192	1.19	1.19	1.19	1.66	2.98	10.00	2.90	11.50	3.60	A12.80	1.43	1.43	1.43	2.00	3.57	12.00	3.40	14.50
7+7+7+9+195	1.44	1.44	1.44	2.34	2.34	10.00	2.90	11.50	3.57	A12.90	1.71	1.71	1.71	2.82	2.82	12.00	3.40	14.50
7+7+7+9+198	1.39	1.39	1.39	2.22	2.78	10.00	2.90	11.50	3.57	A12.90	1.67	1.67	1.67	2.47	3.22	12.00	3.40	14.50
7+7+7+9+201	1.30	1.30	1.30	2.08	3.24	10.00	2.90	11.50	3.64	A12.70	1.56	1.56	1.56	2.04	3.90	12.00	3.40	14.50
7+7+7+9+204	1.22	1.22	1.22	1.95	3.66	10.00	2.90	11.50	3.64	A12.70	1.46	1.46	1.46	2.34	4.40	12.00	3.40	14.50
7+7+7+9+207	1.15	1.15	1.15	1.84	4.04	10.00	2.90	11.50	3.62	A12.70	1.38	1.38	1.38	2.21	4.82	12.00	3.40	14.50
7+7+7+9+210	1.32	1.32	1.32	2.10	2.63	10.00	2.90	11.50	3.57	A12.90	1.58	1.58	1.58	2.5				



PAC i



WELCOME TO THE COMMERCIAL RANGE

Here are some of your new air conditioner's major features.

Panasonic has developed an impressive range of highly efficient Commercial Air Conditioners. This range confirms our commitment to the environment. Our Inverter compressors optimise performance and thus reduce energy costs.



Highlighted Features

PACi Standard: For economy and value

With high quality design and engineering, the PACi Standard is the perfect solution for projects which demand quality on a limited budget. In addition, its compact size and light weight make it ideal for installations with limited space including small commercial and residential applications.

PACi Elite: Newly designed next generation of commercial air conditioning

Energy-saving concept. The use of energy saving design for the structure of fans, fan motors, compressors and heat exchangers resulted in high COP value which ranked as one the top class in the industry. In addition, use of highly efficient R410A refrigerant reduces CO₂ emission and lowers operating costs.



ENERGY SAVING



The new Cloud system from Panasonic allows you to have complete control of all your installations. In a simple click, all your units from several locations, receive status updates in real-time of all your installations, preventing breakdowns and optimizing costs.



Internet Control is a next generation system providing a user-friendly remote control of air conditioning or heat pump units from everywhere, using a simple Android or iOS smartphone, tablet or PC via internet.



Inverter plus products improve on the characteristics of standard Inverter range by over 20%. This means 20% less consumption and 20% off your electric bill. A Inverter plus is also A class on cooling and heating mode.



Econavi features intelligent Human Activity Sensor and new Sunlight Sensor technologies that can detect and reduce waste by optimising air conditioner operation according to room conditions. With just one touch of a button, you can save energy efficiently with uninterrupted cooling, comfort and convenience.



Exceptional Seasonal Cooling Efficiency based on the new ErP regulation. Higher SEER ratings mean greater efficiency. Save all the year while cooling!



Exceptional Seasonal Heating Efficiency based on the new ErP regulation. Higher SCOP ratings mean greater efficiency. Save all the year while heating!



The air conditioner works in cooling only mode with an outdoor temperature of -15°C.



The air conditioner works in heat pump mode even when outdoor temperatures are as low as -20°C or -15°C.



The communication port is integrated into the indoor unit and provides easy connection to, and control of, your Panasonic heat pump to your home or building management system.



R410A. Environmentally friendly refrigerant.



The Panasonic renewal system allows good quality existing R22 pipe work to be re-used whilst installing new high efficiency R410A systems.



5 Years Warranty. We guarantee the compressors in the entire range for five years. Only for PRO partners.



Energy
saving

INVERTER+

PACi Standard and Elite

PACi Standard

- Good balance, system cost vs energy efficiency
- Top class SEER/SCOP as a Standard Inverter category
SEER: A++ / SCOP: A+ at 10.0 kW (in Cassette 90x90)
- Interchangeable controller with ECOi
- Compact outdoor units
- Twin connection possible
- Cooling operation up to -15°C
- Heating operation up to -10°C

PACi Elite

- Meeting all necessary safety approvals to ensure quality and safety
- Top-class SEER: A++ / SCOP: A+ at 10.0 kW (in Cassette 90x90 and Ceiling)
- Cooling operation is possible when outdoor temperature as high as 46°C
- DC inverter technology combined with R410A for excellent efficiency
- Cooling operation is possible when outdoor temperature as low as -15°C
- Heating operation is possible when outdoor temperature as low as -20°C
- Compact outdoor units
- Auto restart from outdoor unit
- Twin, Triple and Doble-Twin connection possible

SEASONAL EFFICIENCY
SEER — SCOP
A++ A+



SEASONAL EFFICIENCY
SEER — SCOP
A++ A+



PACi Standard: outdoor unit

More compact

The outdoor unit is much more compact than the previous model. The slim and lightweight design means the PACi outdoor unit can be installed in a number of situations.

* Only for U-100PEY1E8, U-125PEY1E8, U-100PEY1E5 and U-125PEY1E5.

Old models (1.170 x 900 x 320)



-15%
SMALLER



On the 12,5 kW (996 x 940 x 340)

Product Quality and Safety

All Panasonic air conditioners undergo strict quality and safety tests before sale. This rigorous process includes obtaining all necessary safety approvals, to ensure that all air conditioners we sell are not only built to the highest market standards, but are also completely safe.

Quiet mode

2, 4 or 6 dB can be reduced by different setting on your choice. External input signal is also available.





Solutions for server rooms

High efficiency products for 24/7 applications

Panasonic has developed a complete range of solutions for server rooms which efficiently protect your servers, keeping them at an appropriate temperature even when the outdoor temperature is below -20°C.

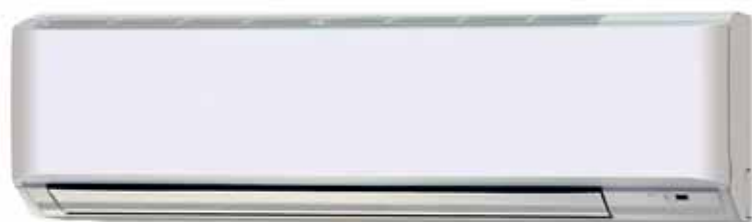

Key points

- From 2.5 kW to 5 kW with PKEA units
- From 5 kW to 25 kW with PACi units
- Backup function
- Redundancy function
- Alternative run function
- Error information by dry contact
- Operation even at -20°C outdoor temperature
- Excellent performance with excellent SEER
- Product design for 24/7 operation

High efficiency all the year

On 24/7 operation, the performance of the air conditioning is a key factor. When the efficiency is high, the return on investment of such units is quickly reached.

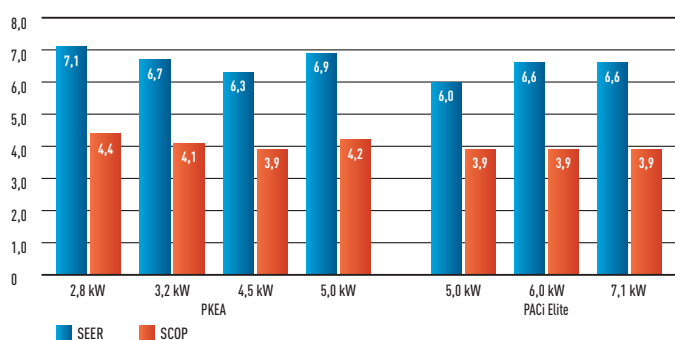

High durability for 24/7 operation

Indoor Fan. Cross-Flow-Fan

- High durability rolling bearings, large size (ω 105mm) fan
- High efficiency blade
- Random pitch blade (low sound)

Compressor

DC2P Panasonic original compressor, with high efficiency and reliability.

Why is the Panasonic R2 Rotary Compressor so efficient?

1. High Efficiency Motor The premium silicon steel motor meets industry efficiency requirements.
2. Improved Lubrication of High Volume Oil Pump The extended, high volume oil pump in conjunction with a larger capacity oil reservoir provides superior lubrication.
3. Accumulator has Larger Refrigerant Capacity The larger accumulator accommodates generous refrigerant amounts needed in longer line length installations.



Interfaces to run 2 (for PKEA) or up to 3 (for PACi) units on Backup and alternative run

PAW-SERVER-PKEA for PKEA

The PAW-SERVER-PKEA server room interface manages redundancy and backup of two PKEA units with two different selectable modes:

- Plug and play by embedded redundancy and backup algorithm (no external signal needed. Further details please refer to operation manual)
- External (third party PLC) redundancy and backup management by dry contact

All settings are possible without the need for a computer connection. A special Energy Saving Mode is selectable by deep switch (available only in plug and play mode). The level of remote control input prohibition can be set when external management is by dry contact.

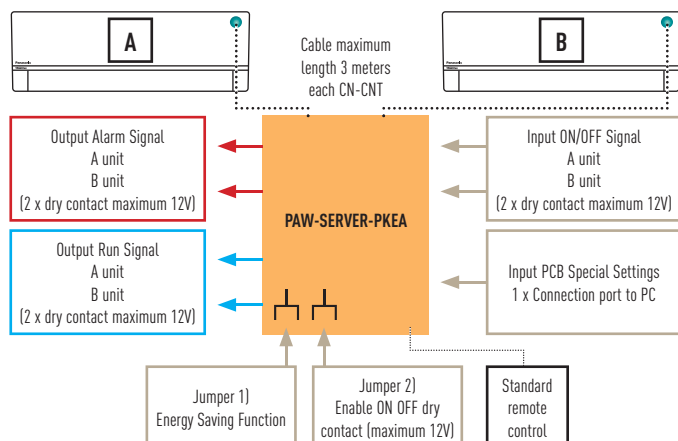

PAW-PACR3 for PACi and ECOi Range

PAW-PACR3, in combination with one PAW-T10V on each indoor unit, allows the redundant operation of 2 (or 3) PAC-i or VRF indoor units.

All units will be operated by programmable turns in order to achieve the same operating time (example turn every 8 hours with 24 hours). If the room temperature exceeds a freely set value, the 2nd (or 3rd) unit will be switched ON and an alarm will be activated.

In combination with 1x PAW-T10V on each indoor unit, 2 or 3 PACi of ECOi can be programmed to run redundant.

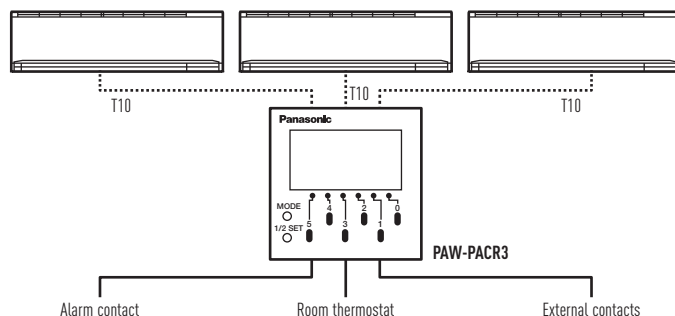

Display and Settings:

- Possible to select next unit manually
- Possible to reset operation
- LED display shows operation status of the 2 or 3 units
- Operation status output
- Alarm LED and alarm output
- Temperature limit can be set
- Temperature hysteresis can be set
- Room temperature is displayed
- Time counter displayed



PACi Standard and Elite: indoor units

360° Air Flow, 4 Way 90x90 Cassette PACi Standard and Elite

4 Way 90x90 Cassette. Wide & Comfortable Airflow

This proprietary design provides a wide and very comfortable airflow. The cassette's wide-angle discharge outlets and flaps are larger in the middle, featuring a shape that was selected based on geometrics and testing of actual prototype units. Air coming out of the center of the discharge outlets travels farther. From the sides of each outlet, where the openings are larger, airflow spreads out to reach the corners of the room. Air is discharged across a wide area from the four sides of the unit. The curves on the room temperature distribution graph expand gently out through 360° in a circle centered on the indoor unit.

Higher efficiency split fin.

Improved heat-transfer coefficient due to adoption of high efficiently grooved heat exchanger tube.

High-efficient & Silent turbo Fan.

The newly developed larger fan chassis and optimised design of the airflow path has resulted in increased air volume and quieter performance.



New DC-Fan motor.

Optimum airflow is achieved by a new DC-fan motor with independent control.

Individual flap control.

Flexible Air flow direction control by individual flap control is possible. 4 Flaps can be controlled individually by setting on wired timer remote controller. It can make more flexible Air-flow control to be matched to several demands in a room.

360° Air Flow for improved comfort

By redesigning the air-outlet and flap, Soft & 3D air flow circulates whole space and provides even temperature distribution in the room.

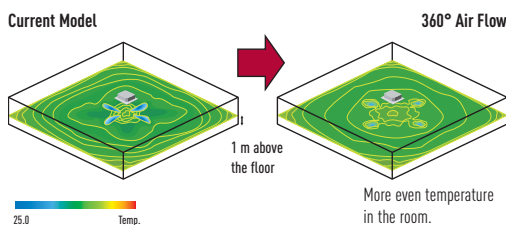

Simulated condition: Floor area: 225 m². Ceiling height: 3 m, Unit 12.5 kW type.

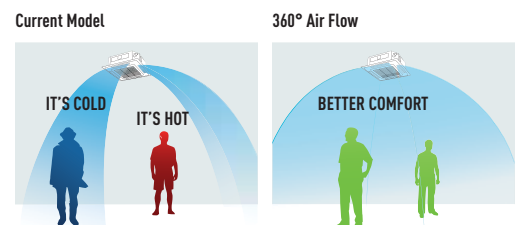

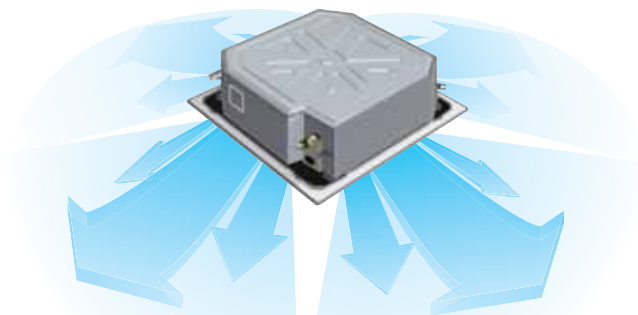

High airflow: 36 m³/min
Industry's highest in the 140 PU class.

Flexible 3D air-flow control

Comfort air flow control & proper energy use. Flexible Air flow direction control by individual flap control:

- 4 Flaps can be controlled individually (by standard wired remote controller*).
- Versatile air flow control to cover a wide variety of demands.

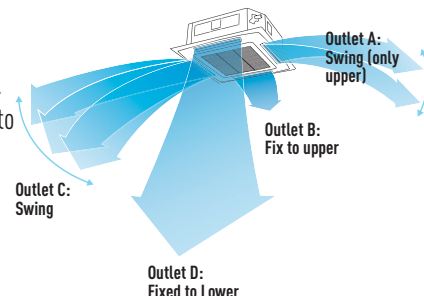

* Pre-setting is required for this function at System Test-run procedure.

High-Ceiling Installation (Up to 5 m for 100 PU and higher models)

The units can be installed in rooms with high ceilings, where they provide ample floor-level heating in the winter. (See ceiling height guidelines below.)

High Ceiling (Factory settings)

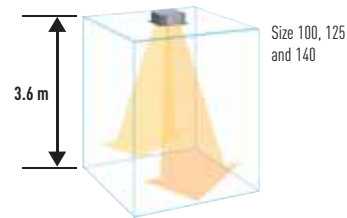

Industry's Top-Class

4-way discharge high ceiling settings²



3-way discharge with the optional air-blocking materials



2-way discharge with the optional air-blocking materials



Ceiling height guidelines

Settings ¹	4 - way discharge		3 - way discharge (optional air - blocking materials)		2 - way discharge (optional air - blocking materials) ²
	Factory settings ¹	High ceiling setting ¹	High ceiling setting ²		
Indoor unit: 60PU-71PU	3.0	3.3	3.6	3.8	4.2
Indoor unit: 100PU, 125PU, 140PU	3.6	3.9	4.5	4.7	5.0

1) When using the unit in a configuration other than the factory settings, it is necessary to make settings on site to increase airflow. 2) Use air-blocking materials (CZ-CFU2) to completely block two discharge outlets for 2-way airflow.

Easy Maintenance and Cleaning

The flap can be removed easily for washing with water.



Low-Profile 33.5 mm Panel

The square panel integrates seamlessly with the ceiling. Discharge outlets close when the unit is stopped.

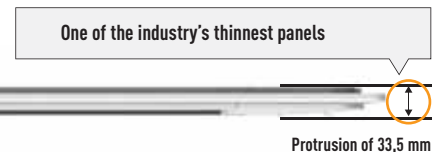

Lighter and Slimmer, Easier Installation

A lightweight unit at 24 kg, the unit is also very slim with a height of only 256 mm, making installation possible even in narrow ceiling voids.

A Drain Height of Approx. 850 mm from the Ceiling Surface

The drain height can be increased by approximately 350 mm over the conventional value by using a high-lift drain pump, and long horizontal piping is possible.

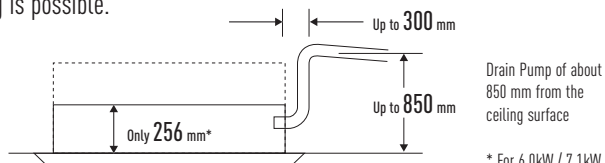

Drain Pump of about 850 mm from the ceiling surface

* For 6.0kW / 7.1kW

Dust Prevention

Wide direction air discharge by outlet design.

The Circle Flow Flap and re-designed air-outlet eliminate airflow along recessed parts of the ceiling which reduces contamination. If air flows only along these recessed parts, they will quickly become dirty. The new, improved air outlet design therefore greatly reduces dirt accumulation.

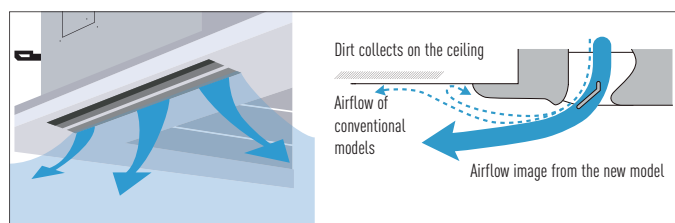



PACi Standard and Elite: indoor units

New 4-Way 60x60 Cassette

Lighter and slimmer, easier installation

Lightweight and very slim which makes installation possible even in narrow ceilings.

A drain height of approx. 850 mm from the ceiling surface

The drain height can be increased by approx. 350 mm over the conventional value by using a high-lift drain pump, and long horizontal piping is possible.

Significant reduction of power consumption by using highly developed DC fan motors with variable speed, special heat exchangers, etc.

Convenient cleaning. The flap can be removed easily for washing.

Wall Mounted

The unit's compact design and flat face ensure discreet installation, even in a small space.

Washable front panel.

The indoor unit's front panel can be easily removed and washed for trouble-free cleaning.

Closed discharge port

When the unit is turned OFF, the flap closes completely to prevent dust getting into the unit and to keep the equipment clean.

Quiet operation

These units are among the quietest in the industry, making them ideal for hotels and hospitals.

Smooth and durable design

The sleek, compact design ensures a discreet installation - even where space is limited.

Piping outlet in three directions

With three options for pipe outlets-rear, right and left - installation is made easy.

Air distribution is altered depending on the operational mode of the unit

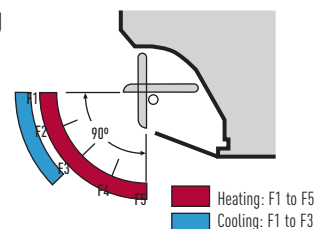

Low Static Pressure Hide Away (PN Type)

Ultra-slim profile: 250 mm height for all models.



Discharge air temperature control

• Possible to reduce cold drafts at heating operation.

Cold Drafts Reduction at Heating

• Accurate temperature measurement by E2 sensor to reduce cold drafts at heating.

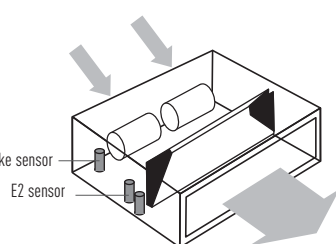

Before spec-in, please consult with an authorized Panasonic dealer.

System Example

An inspection port (450 mm x 450 mm or more) is required at the control-box side of the indoor unit body.

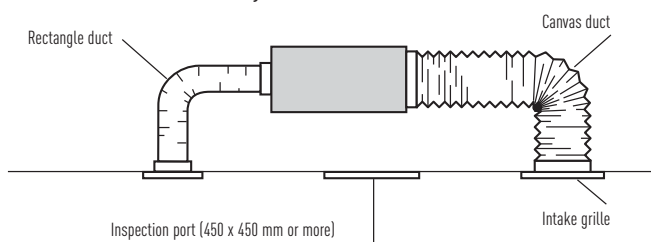

PF / F2 Advantages

Automatic learning function for the required static pressure, to be activated easily by the standard wired timer remote controller.

Possible to increase the sensible cooling capacity by adjusting the air volume flow in order to almost completely eliminate latent losses.

This is possible due to the outstanding big heat exchanger surface in combination with increasing the air volume flow by a manual selection of higher fan speed curves through the standard wired remote controller when commissioning the system together with the default active off-coil temperature control and the room load based variable evaporation temperature control.

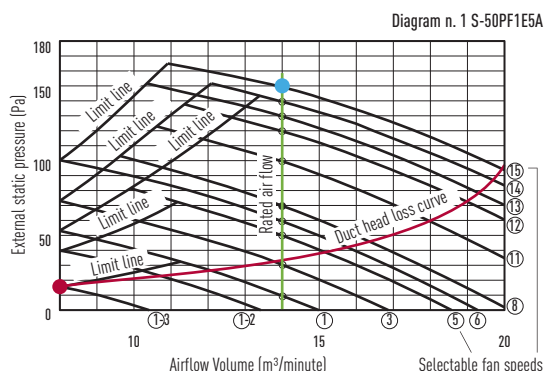

High Static Pressure Hide Away (PF Type)

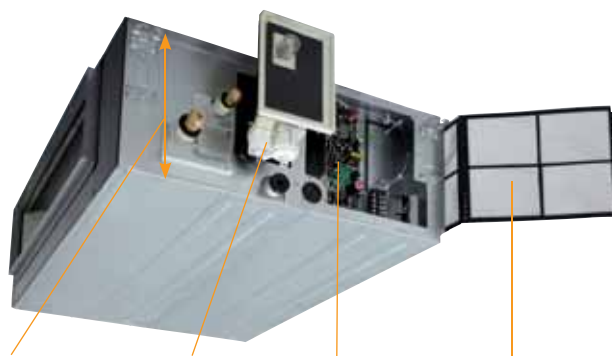

Standardized height of 290 mm for all models
Height standardization enables easy and uniform installation for models with different capacities.

Built-in Drain pump (DC motor pump)

External electrical equipment box makes maintenance easy
P-link PCB

- Built-in filter
- Side removable filter

The static pressure outside the unit can be increased up to 150 Pa.

Type	60	71	100	125	140
Standard	70 Pa	70 Pa	100 Pa	100 Pa	100 Pa
Maximum available setting	150 Pa	150 Pa	150 Pa	150 Pa	150 Pa

More powerful drain pump

Using a high-lift drain pump, drain piping can be elevated up to 785 mm from the base of the unit.

Air inlet

The unit features air inlet on one side, air outlet on the other side. The air inlet filter can be pulled out from the side of the unit and can be folded. Easy access if through the maintenance opening.



When air inlet duct (field supplied) is connected on suction side, remove the filter, frame and insulation materials on both sides of the unit. Connect the duct on the suction side of the unit by using prepared holes on the unit.

Air outlet site

A rectangular duct flange for the air outlet is fitted as standard. Round outlet flange kits are available as an optional accessory kit.

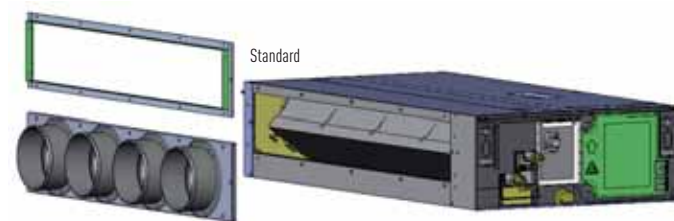

Round flange : CZ-160DAF2 3200 outlet frange x 4 ports























Circle duct flange (option)

Number of exits with diameters	Model Code
2 x Ø 200	CZ-56DAF2 (2 SA outlet)
3 x Ø 200	CZ-90DAF2 (3 SA outlet)
4 x Ø 200	CZ-160DAF2 (4 SA outlet)



Range of Commercial units

Wall Mounted for professional applications Wall Mounted PKEA*	2.8 kW	3.2 kW	4.5 kW	5.0 kW
				
	CS-E9PKEA	CS-E12PKEA	CS-E15PKEA	CS-E18PKEA

* PKEA indoor units are only compatible with PKEA Outdoor Units.

Indoor Units PACi Standard And Elite Wall PACi Inverter+	3.6 kW	4.5 kW	5.0 kW	6.0 kW
				
	S-36PK1E5A	S-45PK1E5A	S-50PK1E5A	S-60PK1E5A
4 Way 60x60 Cassette PACi Inverter+				
	S-36PY2E5A	S-45PY2E5A	S-50PY2E5A	
4 Way 90x90 Cassette PACi Inverter+				
	S-36PU1E5A	S-45PU1E5A	S-50PU1E5A	S-60PU1E5A
Low Static Pressure Hide Away PACi Inverter+				
	S-36PN1E5A	S-45PN1E5A	S-50PN1E5A	S-60PN1E5A
High Static Pressure Hide Away PACi Inverter+				
	S-36PF1E5A	S-45PF1E5A	S-50PF1E5A	S-60PF1E5A
Ceiling PACi Inverter+				
	S-36PT2E5A	S-45PT2E5A	S-50PT2E5A	S-60PT2E5A
High Static Pressure Hide Away 20.0 - 25.0 kW PACi Inverter+	NEW			
Air Curtain with DX Coil Jet-Flow				
Air Curtain with DX Coil Standard				

1) Available from November 2014. * The indoor units from 3.6 to 5.0 kW are only available only for Twin, Triple and Double-Twin combinations.

Outdoor Units PACi Standard and Elite PACi Standard			5.0 kW	6.0 kW
				
				U-60PE1E5 ¹
PACi Elite				
			U-50PE1E5 ¹	U-60PE1E5A ¹

¹ Single Phase ¹¹ Three Phase

Air Handling Unit 2 types of AHU Kit: Advanced and Standard. Up to 28 kW	28.0 kW  PAW-280PAH2 PAW-280PAH2L CZ-280PAH1
---	--

(Common use for all outdoor units. Only 1 by 1 connection is allowed.)

7.1 kW	10.0 kW	12.5 kW	14.0 kW	20.0 kW	25.0 kW
 S-71PK1E5A	 S-100PK1E5A (9,5 kW)				
 S-71PU1E5A	 S-100PU1E5A	 S-125PU1E5A	 S-140PU1E5A		
 S-71PN1E5A	 S-100PN1E5A	 S-125PN1E5A	 S-140PN1E5A		
 S-71PF1E5A	 S-100PF1E5A	 S-125PF1E5A	 S-140PF1E5A		
 S-71PT2E5A	 S-100PT2E5A	 S-125PT2E5A	 S-140PT2E5A		
				 S-200PE2E5	 S-250PE2E5
	 PAW-10PAIRC-MJ (9.2 kW)		 PAW-15PAIRC-MJ (17.5 kW)	 PAW-20PAIRC-MJ (23.1kW)	
	 PAW-10PAIRC-MS (9.2 kW)		 PAW-20PAIRC-MS (17.5 kW)		

7.1 kW	10.0 kW	12.5 kW	14.0 kW	20.0 kW	25.0 kW
 U-71PE1E5 ¹	 U-100PE1E5 ¹ // U-100PE1E8 ^{III}	 U-125PE1E5 ¹ // U-125PE1E8 ^{III}	 U-140PE1E8 ^{III}		
 U-71PE1E5A ¹ // U-71PE1E8A ^{III}	 U-100PE1E5A ¹ // U-100PE1E8A ^{III}	 U-125PE1E5A ¹ // U-125PE1E8A ^{III}	 U-140PE1E5A ¹ // U-140PE1E8A ^{III}	 U-200PE1E8 ^{III}	 U-250PE1E8 ^{III}

WALL MOUNTED PKEA

Complete line-up with high efficiency even at -15°C

This Wall Mounted air conditioner is especially designed for professional applications such as computer rooms where cooling inside the room is necessary even when the outside temperature is low. Furthermore this air conditioner has an automatic changeover system, in order to maintain the inside temperature even when sharp outside temperature changes occur.



Energy saving
INVERTER+

Internet Control Ready
INTERNET CONTROL

7,10 A++ SEER
SEASONAL ENERGY EFFICIENCY RATIO

4,40 A+ SCOP
SEASONAL COEFFICIENT OF PERFORMANCE

Down to -15°C in cooling mode
OUTDOOR TEMPERATURE

Down to -15°C in heating mode
OUTDOOR TEMPERATURE

Easy control by BMS
CONNECTIVITY

Possible to use on R22 pipings
R22 RENEWAL

5 year compressor warranty

SEER and SCOP: For KIT-E9-PKEA, 5 YEARS COMPRESSOR WARRANTY: Only for PRO partners.

		Single Phase				
		2.8 kW	3.2 kW	4.5 kW	5.0 kW	
KIT		KIT-E9-PKEA	KIT-E12-PKEA	KIT-E15-PKEA	KIT-E18-PKEA	
Indoor		CS-E9PKEA	CS-E12PKEA	CS-E15PKEA	CS-E18PKEA	
Outdoor		CU-E9PKEA	CU-E12PKEA	CU-E15PKEA	CU-E18PKEA	
Timer remote controller included		CZ-RD514C	CZ-RD514C	CZ-RD514C	CZ-RD514C	
Cooling capacity	Nominal (Min-Max)	kW	2.50 (0.85-3.00)	3.50 (0.85-4.00)	4.20 (0.98-5.00)	5.00 (0.98-6.00)
	Nominal (Min-Max)	kCal/h	2,150 (730-2,580)	3,010 (730-3,440)	3,610 (840-4,300)	4,300 (840-5,160)
EER ¹⁾	Nominal (Min - Max)	Energy Saving	4.85 (4.23-5.00) A	4.02 (3.57-5.00) A	3.50 (3.50-3.16) A	3.47 (3.50-3.02) A
Cooling capacity at -10°C	Nominal	kW	2.63	3.69	5.04	6.00
EER at -10°C	Nominal	W/W	7.19	5.96	6.01	6.00
Cooling capacity at -20°C	Nominal	kW	2.61	3.66	4.06	5.82
EER at -20°C	Nominal	W/W	6.71	5.56	4.39	5.39
SEER ²⁾	Nominal	W/W	7.1 A++	6.7 A++	6.3 A++	6.9 A++
Pdesign		kW	2.5	3.5	4.2	5.0
Power input cooling	Nominal (Min-Max)	kW	0.515 (0.170-0.710)	0.870 (0.170-1.120)	1.200 (0.280-1.580)	1.440 (0.280-1.990)
Annual electricity consumption (cooling) ³⁾		kWh/a	123	183	233	254
Heating capacity	Nominal (Min-Max)	kW	3.40 (0.85-5.40)	4.00 (0.85-6.60)	5.40 (0.98-7.10)	5.80 (0.98-8.00)
	Nominal (Min-Max)	kCal/h	2,920 (730-4,640)	3,440 (730-5,680)	4,640 (840-6,110)	4,990 (840-6,880)
Heating capacity at -7°C ⁴⁾	Nominal	kW	3.33	4.07	4.10	4.98
COP ¹⁾	Nominal (Min - Max)	Energy Saving	4.86 (4.12-5.15) A	4.35 (3.63-5.15) A	3.75 (2.88-3.24) A	3.82 (2.88-3.11) A
SCOP ⁵⁾	Nominal	W/W	4.4 A+	4.1 A+	3.9 A	4.2 A+
Pdesign at -10 °C		kW	2.8	3.6	3.6	4.4
Power input heating	Nominal (Min-Max)	kW	0.700 (0.165-1.310)	0.920 (0.165-1.820)	1.440 (0.340-2.190)	1.520 (0.340-2.570)
Annual electricity consumption (heating) ³⁾		kWh/a	891	1,229	1,292	1,467
Indoor Unit						
Power source		V	230	230	230	230
Recommended fuse		A	16	16	16	16
Connection indoor / outdoor		mm	4 x 1.5	4 x 1.5	4 x 1.5	4 x 2.5
Current (Nominal)	Cooling / Heating	A	2.5 / 3.3	4.0 / 4.2	5.4 / 6.5	6.4 / 6.8
Max. Current		A	7.8	8.4	9.6	11.3
Air Volume	Cooling / Heating	m³/h	798 / 876	816 / 882	846 / 900	1,074 / 1,158
Moisture removal volume		l/h	1.5	2.0	2.4	2.8
Sound pressure level ⁶⁾	Cooling (Hi / Lo / S-Lo)	dB(A)	39 / 26 / 23	42 / 29 / 26	43 / 32 / 29	44 / 37 / 34
	Heating (Hi / Lo / S-Lo)	dB(A)	40 / 27 / 24	42 / 33 / 29	43 / 35 / 29	44 / 37 / 34
Sound power level	Cooling / Heating (Hi)	dB	55 / 56	58 / 58	59 / 59	60 / 60
Dimensions / Net weight	H x W x D	mm / kg	295 x 870 x 255 / 10	295 x 870 x 255 / 10	295 x 870 x 255 / 10	295 x 1,070 x 255 / 13
Air purifier filter						
Outdoor Unit						
Air Volume	Cooling / Heating	m³/h	1,878 / 1,782	1,974 / 1,926	2,052 / 1,980	2,352 / 2,274
Sound pressure level ⁶⁾	Cooling / Heating (Hi)	dB(A)	46 / 47	48 / 50	46 / 46	47 / 47
Sound power level	Cooling / Heating (Hi)	dB	61 / 62	63 / 65	61 / 61	61 / 61
Dimensions ⁷⁾ / Net weight	H x W x D	mm / kg	622 x 824 x 299 / 36	622 x 824 x 299 / 36	695 x 875 x 320 / 45	695 x 875 x 320 / 46
Piping connections	Liquid pipe / Gas pipe	inch (mm)	1/4" (6.35) / 3/8" (9.52)	1/4" (6.35) / 3/8" (9.52)	1/4" (6.35) / 1/2" (12.70)	1/4" (6.35) / 1/2" (12.70)
Refrigerant loading	R410A	kg	1,100	1,100	1,060	1,240
Elevation difference (in/out) ⁸⁾	Max	m	5	5	15	15
Piping length	Min / Max	m	3-15	3-15	3-15	3-20
Precharge length	Max	m	7.5	7.5	7.5	7.5
Additional charge		g/m	20	20	20	20
Operating range	Cooling Min / Max	°C	-15 / +43	-15 / +43	-15 / +43	-15 / +43
	Heating Min / Max	°C	-15 / +24	-15 / +24	-15 / +24	-15 / +24

Rating Conditions: Cooling Indoor 27°C DB / 19°C WB. Cooling Outdoor 35°C DB / 24°C WB. Heating Indoor 20°C DB. Heating Outdoor 7°C DB / 6°C WB. (DB: Dry Bulb; WB: Wet Bulb).

Rating Conditions for cooling capacity at low temperature: Cooling Indoor 27°C DB / 19°C WB. Cooling Outdoor 0°C DB / -10°C WB.

1) EER and COP, Energy Saving Classification, is at 220 / 240 V (380 / 415 V) only in accordance with EU directive 2002/31/EC. 2) SEER is calculated in base Eurovent IPLV for SBEM for U1 indoor unit SEER=a(EER25)+b(EER50)+c(EER75)+d(EER100) where EER25, EER50, EER75 and EER100 are the EER measured value at 25%, 50%, 75% and 100% part load for temperatures 20, 25, 30 and 35°C DB, respectively. a, b, c and d are values assigned for an office type. These values are given as a=0.2, b=0.36, c=0.32 and d=0.03. The internal temperatures are taken at 27°C DB and 19°C WB. 3) The annual consumption (ErP) is calculated by formula determined by ErP regulation. 4) Heating capacity is calculated including defrost factor correction. 5) SCOP is calculated in base Eurovent IPLV for SBEM with U1 indoor unit including defrost correction factor. 6) The Sound pressure level of the units shows the value measured of a position 1 meter in front of the main body and 1.5 m from the ground. The sound pressure is measured in accordance with Eurovent 6/C/006-97 specification. 7) Add 70 mm for piping port. 8) When installing the outdoor unit at a higher position than the indoor unit. // Recommended fuse for the indoor 3A. // Specifications subject to change without notice.

For detailed information about ErP, please visit our websites www.aircon.panasonic.co.uk or www.ptc.panasonic.eu



Technical focus

- This units can be installed on R22 pipings
- Designed for 24h/7d a week operation
- Highly efficient even at -15°C
- High durability rolling bearings
- Additional piping sensors to prevent freezing

Features

Outdoor

- Cooling even when ambient temperature is as low as -15°C
- Electronic expansion valve (accurate sub-cooling and adjustable refrigerant flow)
- Outdoor DC fan motor to provide flexible air-flow to ensure optimum condensation pressure (works on outdoor pipe temperature sensor)

Interface option to manage server room operation

The PAW-SERVER-PKEA server room interface manages redundancy and backup of two PKEA units with two different selectable modes:

- Plug and play by embedded redundancy and backup algorithm (no external signal needed. Further details please refer to operation manual)
- External (third party PLC) redundancy and backup management by dry contact

All settings are possible without the need for a computer connection.

A special Energy Saving Mode is selectable by deep switch (available only in plug and play mode).

The level of remote control input prohibition can be set when external management is by dry contact.

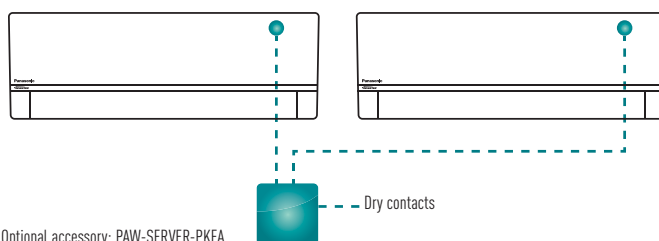

CU-E9PKEA
CU-E12PKEA



CU-E15PKEA
CU-E18PKEA



Included on the kit
Timer remote controller

WALL MOUNTED PACi STANDARD AND ELITE INVERTER+

New Wall Mounted PACi. The extension of the range to include a 10 kW unit allows for many more applications such as studios, gyms, high ceiling areas and even computer server rooms.

Technical Focus

- 10.0 kW capacity unit
- Flat face design for modern appearance
- Compact design offers over 15% reduction in overall size
- Washable front panel
- DC FAN for better efficiency and control
- Three directional piping outlet
- Easy connection and control of external fan or ERV using the connector PAW-FDC on the indoor unit PCB. The external device can be control by the remote control of the Panasonic indoor unit

STANDARD

		Single Phase		Three Phase	
		6.0 kW		10.0 kW	
KIT		KIT-60PKY1E5A*		KIT-100PKY1E5A*	
Indoor		S-60PK1E5A		S-100PK1E5A	
Outdoor		U-60PEY1E5		U-100PEY1E5	
Timer remote controller		CZ-RTC2 / CZ-RTC4		CZ-RTC2 / CZ-RTC4	
Cooling capacity	Nominal (Min - Max)	kW	6.0 (2.0 - 7.0)	7.1 (2.0 - 7.7)	9.0 (2.7 - 9.7)
EER ¹⁾	Nominal (Min - Max)	W/W	3.23 (6.15 - 2.55) A	2.90 (6.15 - 2.57) C	2.67 (5.09 - 2.55) D
SEER ²⁾		W/W	5.4 A	5.1 A	5.8 A+
Pdesign		kW	6.0	7.1	9.0
Power input cooling	Nominal (Min - Max)	kW	1.860 (0.325 - 2.750)	2.450 (0.325 - 3.000)	3.370 (0.530 - 3.800)
Annual energy consumption (ErP) ³⁾		kWh/a	389	487	543
Heating capacity	Nominal (Min - Max)	kW	6.0 (1.8 - 7.0)	7.1 (1.8 - 8.1)	9.0 (2.1 - 10.5)
Heating capacity at -7°C ⁴⁾	Nominal	kW	4.99	5.08	9.97
Heating capacity at -15°C ⁴⁾	Nominal	kW	4.20	4.37	8.43
COP ¹⁾	Nominal (Min - Max)	W/W	4.00 (6.55 - 3.18) A	3.74 (6.55 - 3.18) A	3.70 (5.12 - 3.50) A
SCOP ⁵⁾		W/W	3.9 A	3.9 A	3.8 A
Pdesign at -10°C		kW	6.0	6.0	9.0
Power input heating	Nominal (Min - Max)	kW	1.500 (0.275 - 2.200)	1.900 (0.275 - 2.550)	2.430 (0.410 - 3.000)
Annual energy consumption (ErP) ³⁾		kWh/a	2,154	2,154	3,316
Indoor unit					
Air volume	Cooling (Hi / Med / Lo)	m³/h	1,080 / 870 / 690	1,080 / 870 / 690	1,140 / 990 / 780
	Heating (Hi / Med / Lo)	m³/h	1,080 / 870 / 690	1,080 / 870 / 690	1,140 / 990 / 780
Moisture removal volume		l/h	3.4	4.2	5.4
Sound pressure level ⁶⁾	Cooling (Hi / Med / Lo)	dB(A)	47 / 44 / 40	47 / 44 / 40	49 / 45 / 41
	Heating (Hi / Med / Lo)	dB(A)	47 / 44 / 40	47 / 44 / 40	49 / 45 / 41
Sound power level	Cooling (Hi)	dB	64	64	65
	Heating (Hi)	dB	64	64	65
Dimensions / Net weight	H x W x D	mm / kg	300 x 1,065 x 230 / 14.5	300 x 1,065 x 230 / 14.5	300 x 1,065 x 230 / 14.5
Outdoor unit					
Power source		V	220 / 230 / 240	220 / 230 / 240	220 / 230 / 240
Recommended fuse		A	20	20	25
Connection		mm²	2.5	2.5	4.0
Current	Cooling	A	8.80 / 8.50 / 8.25	11.7 / 11.3 / 10.9	16.0 / 15.3 / 14.6
	Heating	A	7.05 / 6.80 / 6.60	9.00 / 8.70 / 8.40	11.2 / 10.8 / 10.4
Air volume	Cooling / Heating	m³/h	1,800 / 2,100	2,340 / 2,340	4,560 / 4,020
Sound pressure level	Cooling / Heating (Hi)	dB(A)	46 / 50	50 / 52	54 / 54
Sound power level	Cooling / Heating (Hi)	dB	65 / 69	70 / 70	70 / 70
Dimensions / Net weight	H x W x D	mm / kg	569 x 790 x 285 / 42	569 x 790 x 285 / 42	996 x 940 x 340 / 73
Piping connections	Liquid pipe	Inch (mm)	3/8 (9.52)	3/8 (9.52)	3/8 (9.52)
	Gas pipe	Inch (mm)	5/8 (15.88)	5/8 (15.88)	5/8 (15.88)
Refrigerant loading		kg	1.7	1.7	2.60
Elevation difference (in/out) ⁷⁾	Max	m	30	30	30
Piping length	Min / Max	m	5 / 50	5 / 50	5 / 50
Precharge length	Max	m	20	20	30
Additional charge		g/m	40	40	50
Operating range	Cooling Min / Max	°C	-10 / +43	-10 / +43	-10 / +43
	Heating Min / Max	°C	-15 / +24	-15 / +24	-15 / +24

Rating Conditions: Cooling Indoor 27°C DB / 19°C WB. Cooling Outdoor 35°C DB / 24°C WB. Heating Indoor 20°C DB. Heating Outdoor 7°C DB / 6°C WB. (DB: Dry Bulb; WB: Wet Bulb). // Specifications subject to change without notice.

1) EER and COP, Energy Saving Classification, is at 220 / 240 V (380 / 415 V) only in accordance with EU directive 2002/31/EC. 2) SEER is calculated in base Eurovent IPLV for SBEM for U1 indoor unit SEER=a(EER25)-b(EER50)+c(EER75)+d(EER100) where EER25, EER50, EER75 and EER100 are the EER measured value at 25%, 50%, 75% and 100% part load for temperatures 20, 25, 30 and 35°C DB, respectively. a, b, c and d are values assigned for an office type. These values are given as a=0.2, b=0.36, c=0.32 and d=0.03. The internal temperatures are taken at 27°C DB and 19°C WB. 3) The annual consumption (ErP) is calculated by formula determined by ErP regulation. 4) Heating capacity is calculated including defrost factor correction. 5) SCOP is calculated in base Eurovent IPLV for SBEM with U1 indoor unit including defrost correction factor. 6) The Sound pressure level of the units shows the value measured of a position 1 meter in front of the main body and 1.5 m from the ground. The sound pressure is measured in accordance with Eurovent 6/C/006-97 specification. 7) When installing the outdoor unit at a higher position than the indoor unit. // Recommended fuse for the indoor 3A. // * Available from June 2014. // For detailed information about ErP, please visit our websites www.aircon.panasonic.co.uk or www.ptc.panasonic.eu

STANDARD

Internet Control Ready
INTERNET CONTROL

Energy saving
INVERTER+

5,40 A SEER
SEASONAL ENERGY EFFICIENCY RATIO

3,90 A SCOP
SEASONAL COEFFICIENT OF PERFORMANCE

Down to -10°C in cooling mode
OUTDOOR TEMPERATURE

Down to -15°C in heating mode
OUTDOOR TEMPERATURE

Easy control by BMS
CONNECTIVITY

Possible to use on R22 pipings
R22 RENEWAL

5 year compressor warranty



HIGH HEATING CAPACITY AT -7°C



- Optional Controller**
Timer remote controller
CZ-RTC2
- Optional Controller**
Wired remote controller
CZ-RTC3 / CZ-RTC5
- Optional Controller**
Timer remote controller
CZ-RTC4
- Optional Controller**
Wireless remote controller
CZ-RWSK2
- Optional Controller**
Simplified remote controller
CZ-RE2C2



Compatible with all Panasonic connectivity solutions. For detailed information go to the Control Systems section.

ELITE

			Single Phase				Three Phase	
			5.0 kW	6.0 kW	7.1 kW	10.0 kW	7.1 kW	10.0 kW
			KIT-50PK1E5A*	KIT-60PK1E5A*	KIT-71PK1E5A*	KIT-100PK1E5A**	KIT-71PK1E8A*	KIT-100PK1E8A**
			S-50PK1E5A	S-60PK1E5A	S-71PK1E5A	S-100PK1E5A	S-71PK1E8A	S-100PK1E8A
			U-50PE1E5	U-60PE1E5A	U-71PE1E5A	U-100PE1E5A	U-71PE1E8A	U-100PE1E8A
			CZ-RTC2 / CZ-RTC4	CZ-RTC2 / CZ-RTC4	CZ-RTC2 / CZ-RTC4	CZ-RTC2 / CZ-RTC4	CZ-RTC2 / CZ-RTC4	CZ-RTC2 / CZ-RTC4
Cooling capacity	Nominal (Min - Max)	kW	5.0 (1.5 - 5.6)	6.0 (2.5 - 7.1)	7.1 (2.5 - 8.0)	9.5 (3.3 - 10.5)	7.1 (3.2 - 8.0)	9.5 (3.3 - 10.5)
EER ¹⁾	Nominal (Min - Max)	W/W	3.21 (5.77 - 2.49) A	3.85 (5.56 - 3.55) A	3.40 (5.56 - 3.02) A	3.25(3.93 - 3.09)A	3.40 (5.71 - 3.02) A	3.25(3.93 - 3.09)A
SEER ²⁾		W/W	6.0 A+	6.6 A++	6.6 A++	6.2 A++	6.1 A++	6.0 A+
Pdesign		kW	5.0	6.0	7.1	9.5	7.1	9.5
Power input cooling	Nominal (Min - Max)	kW	1.560 (0.260 - 2.250)	1.560 (0.450 - 2.000)	2.090 (0.450 - 2.650)	2.920 (0.840 - 3.400)	2.090 (0.560 - 2.650)	2.920 (0.840 - 3.400)
Annual energy consumption (ErP) ³⁾		kWh/a	292	318	376	536	407	554
Heating capacity	Nominal (Min - Max)	kW	5.6 (1.5 - 6.5)	7.0 (2.0 - 8.0)	8.0 (2.0 - 9.0)	9.5 (4.1 - 11.5)	8.0 (2.8 - 9.0)	9.5 (4.1 - 11.5)
Heating capacity at -7°C ⁴⁾	Nominal	kW	4.20	6.69	7.52	12.04	7.52	12.04
Heating capacity at -15°C ⁴⁾	Nominal	kW	3.58	6.56	7.65	11.20	7.65	11.20
COP ¹⁾	Nominal (Min - Max)	W/W	3.73 (6.82 - 2.65) A	3.85 (5.00 - 3.23) A	3.76 (5.00 - 3.10) A	3.85 (4.56 - 3.43) A	3.76 (5.60 - 3.10) A	3.85 (4.56 - 3.43) A
SCOP ⁵⁾		W/W	3.9 A	3.9 A	3.9 A	3.8 A	3.8 A	3.8 A
Pdesign at -10°C		kW	4.0	6.0	7.1	9.5	7.1	9.5
Power input heating	Nominal (Min - Max)	kW	1.500 (0.220 - 2.450)	1.820 (0.400 - 2.480)	2.130 (0.400 - 2.900)	2.470 (0.900 - 3.350)	2.130 (0.500 - 2.900)	2.470 (0.900 - 3.350)
Annual energy consumption (ErP) ³⁾		kWh/a	1,436	2,154	2,548	3,500	2,616	3,500
Indoor unit								
Air volume	Cooling (Hi / Med / Lo)	m³/h	840 / 720 / 630	1,080 / 870 / 690	1,080 / 870 / 690	1,140 / 990 / 780	1,080 / 870 / 690	1,140 / 990 / 780
	Heating (Hi / Med / Lo)	m³/h	840 / 720 / 630	1,080 / 870 / 690	1,080 / 870 / 690	1,140 / 990 / 780	1,080 / 870 / 690	1,140 / 990 / 780
Moisture removal volume		l/h	2.8	3.4	4.2	5.7	4.2	5.7
Sound pressure level ⁶⁾	Cooling (Hi / Med / Lo)	dB(A)	40 / 36 / 32	47 / 44 / 40	47 / 44 / 40	49/45/41	47 / 44 / 40	49/45/41
	Heating (Hi / Med / Lo)	dB(A)	40 / 36 / 32	47 / 44 / 40	47 / 44 / 40	49/45/41	47 / 44 / 40	49/45/41
Sound power level	Cooling (Hi)	dB	57	64	64	65	64	65
	Heating (Hi)	dB	57	64	64	65	64	65
Dimensions / Net weight	H x W x D	mm / kg	300 x 1,065 x 230 / 13.0	300 x 1,065 x 230 / 14.5	300 x 1,065 x 230 / 14.5	300 x 1065 x 230 / 14,5	300 x 1,065 x 230 / 14.5	300 x 1065 x 230 / 14,5
Outdoor unit								
Power source		V	220 / 230 / 240	220 / 230 / 240	220 / 230 / 240	220 / 230 / 240	380 / 400 / 415	380 / 400 / 415
Recommended fuse		A	16	20	20	25	16	16
Connection		mm²	2.5	2.5	2.5	4	2.5	2.5
Current	Cooling	A	7.25 / 7.00 / 6.80	7.45 / 7.15 / 6.95	9.75 / 9.40 / 9.10	13.4 / 12.9 / 12.4	3.25 / 3.15 / 3.05	4.60 / 4.40 / 4.30
	Heating	A	6.95 / 6.75 / 6.50	8.45 / 8.15 / 7.90	9.85 / 9.50 / 9.20	11.3 / 10.9 / 10.6	3.30 / 3.20 / 3.10	3.85 / 3.70 / 3.60
Air volume	Cooling / Heating	m³/h	1,800 / 2,100	3,600 / 3,600	3,600 / 3,600	6,600 / 5,700	3,600 / 3,600	6,600 / 5,700
Sound pressure level	Cooling / Heating (Hi)	dB(A)	46 / 50	48 / 50	48 / 50	52 / 52	48 / 50	52 / 52
Sound power level	Cooling / Heating (Hi)	dB	65 / 69	65 / 67	65 / 67	69 / 69	65 / 67	69 / 69
Dimensions / Net weight	H x W x D	mm / kg	569 x 790 x 285 / 42	996 x 940 x 340 / 68	996 x 940 x 340 / 69	1,416 x 940 x 340 / 98	996 x 940 x 340 / 71	1,416 x 940 x 340 / 98
Piping connections	Liquid pipe	Inch (mm)	1/4 (6.35)	3/8 (9.52)	3/8 (9.52)	3/8 (9.52)	3/8 (9.52)	3/8 (9.52)
	Gas pipe	Inch (mm)	1/2 (12.7)	5/8 (15.88)	5/8 (15.88)	5/8 (15.88)	5/8 (15.88)	5/8 (15.88)
Refrigerant loading	R410A	kg	1.65	2	2.35	3.4	2.35	3.4
Elevation difference (in/out) ⁷⁾	Max	m	30	30	30	30	30	30
Piping length	Min / Max	m	5 / 40	5 / 50	5 / 50	5 / 75	5 / 50	5 / 75
Precharge length	Max	m	30	30	30	30	30	30
Additional charge		g/m	20	50	50	50	50	50
Operating range	Cooling Min / Max	°C	-15 / +46	-15 / +46	-15 / +46	-15 / +46	-15 / +46	-15 / +46
	Heating Min / Max	°C	-20 / +24	-20 / +24	-20 / +24	-20 / +24	-20 / +24	-20 / +24

Rating Conditions: Cooling Indoor 27°C DB / 19°C WB. Cooling Outdoor 35°C DB / 24°C WB. Heating Indoor 20°C DB. Heating Outdoor 7°C DB / 6°C WB. (DB: Dry Bulb; WB: Wet Bulb). // Specifications subject to change without notice.
 1) EER and COP, Energy Saving Classification, is at 220 / 240 V (380 / 415 V) only in accordance with EU directive 2002/31/EC. 2) SEER is calculated in base Eurovent IPLV for SBEM for U1 indoor unit SEER=a(EER25)+b(EER50)+c(EER75)+d(EER100) where EER25, EER50, EER75 and EER100 are the EER measured value at 25%, 50%, 75% and 100% part load for temperatures 20, 25, 30 and 35°C DB, respectively. a, b, c and d are values assigned for an office type. These values are given as a=0.2, b=0.36, c=0.32 and d=0.03. The internal temperatures are taken at 27°C DB and 19°C WB. 3) The annual consumption (ErP) is calculated by formula determined by ErP regulation. 4) Heating capacity is calculated including defrost factor correction. 5) SCOP is calculated in base Eurovent IPLV for SBEM with U1 indoor unit including defrost correction factor. 6) The Sound pressure level of the units shows the value measured of a position 1 meter in front of the main body and 1.5 m from the ground. The sound pressure is measured in accordance with Eurovent 6/C/006-97 specification. 7) When installing the outdoor unit at a higher position than the indoor unit. // Recommended fuse for the indoor 3A. // * Available from June 2014. ** Available from July 2014. // For detailed information about ErP, please visit our websites www.aircon.panasonic.co.uk or www.ptc.panasonic.eu

ELITE

Internet Control Ready
INTERNET CONTROL

Energy saving
INVERTER+

6,60 A++ SEER*
SEASONAL ENERGY EFFICIENCY RATIO

3,90 A SCOP
SEASONAL COEFFICIENT OF PERFORMANCE

Down to -15°C in cooling mode
OUTDOOR TEMPERATURE

Down to -20°C in heating mode
OUTDOOR TEMPERATURE

Easy control by BMS
CONNECTIVITY

Possible to use on R22 pipings
R22 RENEWAL

5 year compressor warranty



INTERNET CONTROL READY: Optional. SEER and SCOP: For KIT-60PK1E5A and KIT-71PK1E5A. 5 YEARS COMPRESSOR WARRANTY: Only for PRO partners.

4 WAY 60x60 CASSETTE PACi STANDARD AND ELITE INVERTER+

Small and powerful, ideal for offices and restaurants.
Only for Twin, Triple and Double-twin combinations.

Technical Focus

- Fresh air knock out
- Multidirectional air flow
- Integrated drain pump gives 850 mm lift
- 3 speed centrifugal fan
- DC FAN for better efficiency and control
- Easy connection and control of external fan or ERV using the connector PAW-FDC on the indoor unit PCB. The external device can be control by the remote control of the Panasonic indoor unit

STANDARD

			3.6 kW	4.5 kW	5.0 kW
Indoor			S-36PY2E5A ¹⁾ *	S-45PY2E5A ¹⁾ *	S-50PY2E5A*
Panel			CZ-KPY3A / CZ-KPY3B	CZ-KPY3A / CZ-KPY3B	CZ-KPY3A / CZ-KPY3B
Cooling capacity	Nominal	kW	3.6	4.5	5.0
Heating capacity	Nominal	kW	4.2	5.2	5.6
Air volume	Cool/Heat	m ³ /h	582 / 594	600 / 618	666 / 666
Moisture removal volume		l/h	2.1	2.5	2.8
Sound pressure level ^{d)}	Cooling (Hi / Med / Lo)	dB(A)	36 / 32 / 26	38 / 34 / 28	40 / 37 / 33
	Heating (Hi / Med / Lo)	dB(A)	36 / 32 / 26	38 / 34 / 28	40 / 37 / 33
Sound power level	Cooling (Hi)	dB	51 / 47 / 41	53 / 49 / 43	55 / 52 / 48
	Heating (Hi)	dB	51 / 47 / 41	53 / 49 / 43	55 / 52 / 48
Dimensions (H x W x D)	Indoor	mm	288 x 583 x 583	288 x 583 x 583	288 x 583 x 583
	Panel CZ-KPY3A / CZ-KPY3B	mm	31 x 700 x 700 / 31 x 625 x 625	31 x 700 x 700 / 31 x 625 x 625	31 x 700 x 700 / 31 x 625 x 625
Net weight	Indoor (Panel)	kg	18 (2.4)	18 (2.4)	18 (2.4)

Rating Conditions: Cooling Indoor 27°C DB / 19°C WB. Cooling Outdoor 35°C DB / 24°C WB. Heating Indoor 20°C DB. Heating Outdoor 7°C DB / 6°C WB. (DB: Dry Bulb; WB: Wet Bulb). // Specifications subject to change without notice.

1) Only for multi combinations.
Recommended fuse for the indoor 3A.

STANDARD

HIGH HEATING CAPACITY AT -7°C



Panel
CZ-KPY3A (size 700 x 700mm)
CZ-KPY3B (size 625 x 625mm)



Optional Controller
Timer remote controller
CZ-RTC2



Optional Controller
Wired remote controller
CZ-RTC3 / CZ-RTC5



Optional Controller
Timer remote controller
CZ-RTC4



Optional Controller
Wireless remote controller
CZ-RWSK2



Optional Controller
Simplified remote controller
CZ-RE2C2

Compatible with all Panasonic connectivity solutions. For detailed information go to the Control Systems section.

ELITE

Indoor			5.0 kW
Outdoor			S-50PYZE5A
Panel			U-50PE1E5
Timer remote controller			CZ-KPY3A / CZ-KPY3B CZ-RTC2 / CZ-RTC4
Cooling capacity	Nominal (Min - Max)	kW	5.0 (1.5 - 5.6)
EER ¹⁾	Nominal (Min - Max)	W/W	3.04 (5.77 - 2.29)
SEER ²⁾		W/W	5.90 A+
Pdesign		kW	5.0
Power input cooling	Nominal (Min - Max)	kW	1.64 (0.260 - 2.45)
Annual energy consumption (ErP) ³⁾		kWh/a	297
Heating capacity	Nominal (Min - Max)	kW	5.6 (1.5 - 6.3)
Heating capacity at -7°C ⁴⁾	Nominal	kW	4.20
Heating capacity at -15°C ⁴⁾	Nominal	kW	3.58
COP ¹⁾	Nominal (Min - Max)	W/W	3.12 (6.82 - 2.45)
SCOP ⁵⁾		W/W	3.80 A
Pdesign at -10°C		kW	4.0
Power input heating	Nominal (Min - Max)	kW	1.79 (0.22 - 2.57)
Annual energy consumption (ErP) ³⁾		kWh/a	1,474
Indoor unit			
Air volume	Cooling / Heating	m ³ /h	666 / 666
Moisture removal volume		l/h	2.8
Sound pressure level ⁶⁾	Cooling (Hi / Me / Lo)	dB(A)	40 / 37 / 33
	Heating (Hi / Me / Lo)	dB(A)	40 / 37 / 33
Sound power level	Cooling (Hi)	dB	55 / 52 / 48
	Heating (Hi)	dB	55 / 52 / 48
Dimensions (H x W x D)	Indoor	mm	288 x 583 x 583
	Panel CZ-KPY3A / CZ-KPY3B	mm	31 x 700 x 700 / 31 x 625 x 625
Net weight	Indoor (Panel)	kg	18 (2.4)
Outdoor unit			
Power source		V	220 - 240
Recommended fuse		A	16
Connection		mm ²	2.5
Current	Cooling / Heating	A	7.5 / 8.2
Air volume	Cooling / Heating	m ³ /h	1,800 / 2,100
Sound pressure level	Cooling / Heating (Hi)	dB(A)	46 / 50
Sound power level	Cooling / Heating (Hi)	dB	65 / 69
Dimensions	H x W x D	mm	569 x 790 x 285
Net weight		kg	42
Piping connections	Liquid pipe / Gas pipe	Inch (mm)	1/4 (6.35) / 1/2 (12.7)
Refrigerant Loading	R410A	kg	1.65
Elevation difference (in/out) ⁷⁾	Max	m	30
Piping length	Min / Max	m	5 - 40
Precharge length	Max	m	30
Additional gas		g/m	20
Operating range	Cooling Min / Max	°C	-15 / +46
	Heating Min / Max	°C	-20 / +24

Rating Conditions: Cooling Indoor 27°C DB / 19°C WB. Cooling Outdoor 35°C DB / 24°C WB. Heating Indoor 20°C DB. Heating Outdoor 7°C DB / 6°C WB. (DB: Dry Bulb; WB: Wet Bulb). // Specifications subject to change without notice.
1) EER and COP, Energy Saving Classification, is at 220 / 240 V (380 / 415 V) only in accordance with EU directive 2002/31/EC. 2) SEER is calculated in base Eurovent IPLV for SBEM for U1 indoor unit SEER=a(EER25)+b(EER50)+c(EER75)+d(EER100) where EER25, EER50, EER75 and EER100 are the EER measured value at 25%, 50%, 75% and 100% part load for temperatures 20, 25, 30 and 35°C DB, respectively. a, b, c and d are values assigned for an office type. These values are given as a=0.2, b=0.36, c=0.32 and d=0.03. The internal temperatures are taken at 27°C DB and 19°C WB. 3) The annual consumption (ErP) is calculated by formula determined by ErP regulation. 4) Heating capacity is calculated including defrost factor correction. 5) SCOP is calculated in base Eurovent IPLV for SBEM with U1 indoor unit including defrost correction factor. 6) The Sound pressure level of the units shows the value measured at a position 1 meter in front of the main body and 1.5 m from the ground. The sound pressure is measured in accordance with Eurovent 6/C/006-97 specification. 7) When installing the outdoor unit at a higher position than the indoor unit. // Recommended fuse for the indoor 3A. // For detailed information about ErP, please visit our websites www.aircon.panasonic.co.uk or www.ptc.panasonic.eu

ELITE

Internet Control Ready
INTERNET CONTROL

Energy saving
INVERTER+

5.90 A+ SEER
SEASONAL ENERGY EFFICIENCY RATIO

3.80 A SCOP
SEASONAL COEFFICIENT OF PERFORMANCE

Down to -15°C in cooling mode
OUTDOOR TEMPERATURE

Down to -20°C in heating mode
OUTDOOR TEMPERATURE

Easy control by BMS
CONNECTIVITY

Possible to use on R22 pipings
R22 RENEWAL

5 year compressor warranty



U-50PE1E5

INTERNET CONTROL READY: Optional. 5 YEARS COMPRESSOR WARRANTY: Only for PRO partners.

4 WAY 90x90 CASSETTE PACi STANDARD AND ELITE INVERTER+

The 4 Way 90x90 Cassette incorporates many new benefits thanks to advances in design and technology.

Technical Focus

- Circle Flow Flap for more even temp. distribution
- Higher efficiency split fin
- New DC fan motor
- Highly efficient and silent turbo fan
- Individual flap control for flexible air flow direction
- Easy to clean suction grill & flap
- Special adjustment for high ceiling application
- DC FAN for better efficiency and control
- Easy connection and control of external fan or ERV using the connector PAW-FDC on the indoor unit PCB. The external device can be control by the remote control of the Panasonic indoor unit

STANDARD

		Single Phase				Three Phase			
		6.0 kW	7.1 kW	10.0 kW	12.5 kW	10.0 kW	12.5 kW	14.0 kW	
KIT		KIT-60PUY1E5A*	KIT-71PUY1E5A*	KIT-100PUY1E5A*	KIT-125PUY1E5A*	KIT-100PUY1E8A*	KIT-125PUY1E8A*	KIT-140PUY1E8A*	
Indoor		S-60PU1E5A	S-71PU1E5A	S-100PU1E5A	S-125PU1E5A	S-100PU1E5A	S-125PU1E5A	S-140PU1E5A	
Outdoor		U-60PEY1E5	U-71PEY1E5	U-100PEY1E5	U-125PEY1E5	U-100PEY1E8	U-125PEY1E8	U-140PEY1E8	
Panel		CZ-KPU21	CZ-KPU21	CZ-KPU21	CZ-KPU21	CZ-KPU21	CZ-KPU21	CZ-KPU21	
Timer remote controller		CZ-RTC2 / CZ-RTC4	CZ-RTC2 / CZ-RTC4	CZ-RTC2 / CZ-RTC4	CZ-RTC2 / CZ-RTC4	CZ-RTC2 / CZ-RTC4	CZ-RTC2 / CZ-RTC4	CZ-RTC2 / CZ-RTC4	
Cooling capacity	Nominal (Min - Max)	kW	6.0 (2.0 - 7.0)	7.1 (2.0 - 7.7)	10.0 (2.7 - 11.5)	12.5 (3.8 - 13.5)	10.0 (2.7 - 11.5)	12.5 (3.8 - 13.5)	14.0 (3.3 - 15.5)
EER ¹⁾	Nominal (Min - Max)	W/W	3.55 (6.15 - 2.80) A	3.24 (6.15 - 2.75) A	3.11 (5.09 - 2.74) B	3.11 (4.22 - 2.70) B	3.11 (5.09 - 2.74) B	3.11 (4.22 - 2.70) B	3.21 (3.93 - 2.58) A
SEER ²⁾	Nominal (Min - Max)	W/W	6.8 A++	6.3 A++	6.4 A++	—	6.2 A++	—	—
Pdesign		kW	6.0	7.1	10	—	10.0	—	—
Power input cooling	Nominal (Min - Max)	kW	1.690 (0.325 - 2.500)	2.190 (0.325 - 2.800)	3.220 (0.530 - 4.200)	4.020 (0.900 - 5.000)	3.220 (0.530 - 4.200)	4.020 (0.900 - 5.000)	4.36 (0.84 - 6.00)
Annual energy consumption (ErP) ³⁾		kWh/a	309	394	547	—	564	—	—
Heating capacity	Nominal (Min - Max)	kW	6.0 (1.8 - 7.0)	7.1 (1.8 - 8.1)	10.0 (2.1 - 13.8)	12.5 (3.4 - 15.0)	10.0 (2.1 - 13.8)	12.5 (3.4 - 15.0)	14.0 (4.1 - 16.0)
COP ¹⁾	Nominal (Min - Max)	W/W	4.05 (6.55 - 3.25) A	3.78 (6.55 - 3.23) A	3.80 (5.12 - 3.45) A	3.80 (4.66 - 3.41) A	3.80 (5.12 - 3.45) A	3.80 (4.66 - 3.41) A	3.89 (4.56 - 3.08) A
SCOP ⁵⁾	Nominal (Min - Max)	W/W	4.0 A+	4.0 A+	4.0 A+	—	4.0 A+	—	—
Pdesign at -10°C		kW	6.0	6.0	10.0	—	10.0	—	—
Power input heating	Nominal (Min - Max)	kW	1.480 (0.275 - 2.155)	1.880 (0.275 - 2.510)	2.630 (0.410 - 4.000)	3.290 (0.730 - 4.400)	2.630 (0.410 - 4.000)	3.290 (0.730 - 4.400)	3.60 (0.90 - 5.20)
Annual energy consumption (ErP) ³⁾		kWh/a	2,100	2,100	3,500	—	3,500	—	—
Indoor unit									
Air volume	Cooling (Hi / Med / Lo)	m³/h	1,260 / 1,020 / 840	1,320 / 1,020 / 840	1,980 / 1,620 / 1,260	2,100 / 1,680 / 1,320	1,980 / 1,620 / 1,260	2,100 / 1,680 / 1,320	2,160 / 1,740 / 1,380
	Heating (Hi / Med / Lo)	m³/h	1,260 / 1,020 / 840	1,320 / 1,020 / 840	1,980 / 1,620 / 1,260	2,100 / 1,680 / 1,320	1,980 / 1,620 / 1,260	2,100 / 1,680 / 1,320	2,160 / 1,740 / 1,380
Moisture removal volume		l/h	3.4	4.2	6.0	7.9	6.0	7.9	9.0
Sound pressure level ⁴⁾	Cooling (Hi / Med / Lo)	dB(A)	36 / 31 / 28	37 / 31 / 28	44 / 38 / 32	45 / 39 / 33	44 / 38 / 32	45 / 39 / 33	46 / 40 / 34
	Heating (Hi / Med / Lo)	dB(A)	36 / 31 / 28	37 / 31 / 28	44 / 38 / 32	45 / 39 / 33	44 / 38 / 32	45 / 39 / 33	46 / 40 / 34
Sound power level	Cooling (Hi / Med / Lo)	dB	53 / 48 / 45	54 / 48 / 45	62 / 55 / 49	63 / 56 / 50	62 / 55 / 49	63 / 56 / 50	64 / 57 / 51
	Heating (Hi / Med / Lo)	dB	53 / 48 / 45	54 / 48 / 45	62 / 55 / 49	63 / 56 / 50	62 / 55 / 49	63 / 56 / 50	64 / 57 / 51
Dimensions (H x W x D)	Indoor	mm	256 x 840 x 840	256 x 840 x 840	319 x 840 x 840	319 x 840 x 840	319 x 840 x 840	319 x 840 x 840	319 x 840 x 840
	Panel	mm	33.5 x 950 x 950	33.5 x 950 x 950	33.5 x 950 x 950	33.5 x 950 x 950	33.5 x 950 x 950	33.5 x 950 x 950	33.5 x 950 x 950
Net weight	Indoor (Panel)	kg	24 (4)	24 (4)	27 (4)	27 (4)	27 (4)	27 (4)	27 (4)
Outdoor unit									
Power source		V	220 / 230 / 240	220 / 230 / 240	220 / 230 / 240	220 / 230 / 240	380 / 400 / 415	380 / 400 / 415	380 / 400 / 415
Recommended fuse		A	20	20	25	30	16	16	16
Connection		mm²	2.5	2.5	4	6	2.5	2.5	2.5
Current	Cooling	A	8.30 / 7.90 / 7.60	10.70 / 10.30 / 9.80	15.10 / 14.40 / 13.80	19.2 / 18.4 / 17.6	5.10 / 4.85 / 4.70	6.35 / 6.05 / 5.80	6.85 / 6.50 / 6.25
	Heating	A	7.20 / 6.90 / 6.60	9.10 / 8.70 / 8.30	12.00 / 11.60 / 11.20	15.4 / 14.8 / 14.2	4.15 / 3.95 / 3.80	5.15 / 4.90 / 4.70	5.65 / 5.35 / 5.20
Air volume	Cooling / Heating	m³/h	1,800 / 2,100	2340	4,560 / 4,020	4,800 / 4,380	4,560 / 4,020	4,800 / 4,380	8,100 / 7,200
Sound pressure level	Cooling / Heating (Hi)	dB(A)	46 / 50	50 / 52	54 / 54	56 / 56	54 / 54	56 / 56	54 / 53
Sound power level	Cooling / Heating (Hi)	dB	65 / 69	70 / 70	70 / 70	73 / 73	70 / 70	73 / 73	71 / 70
Dimensions	H x W x D	mm	569 x 790 x 285	569 x 790 x 285	996 x 940 x 340	996 x 940 x 340	996 x 940 x 340	996 x 940 x 340	1,416 x 940 x 340
Net weight		kg	42	42	73	85	73	85	98
Piping connections	Liquid pipe / Gas pipe	Inch (mm)	3/8 (9.52) / 5/8 (15.88)	3/8 (9.52) / 5/8 (15.88)	3/8 (9.52) / 5/8 (15.88)	3/8 (9.52) / 5/8 (15.88)	3/8 (9.52) / 5/8 (15.88)	3/8 (9.52) / 5/8 (15.88)	3/8 (9.52) / 5/8 (15.88)
Refrigerant loading	R410A	kg	1.7	1.7	2.60	3.20	2.60	3.20	3.4
Elevation difference (in/out) ⁷⁾	Max	m	30	30	30	30	30	30	30
Piping length	Min / Max	m	5 / 50	5 / 50	5 / 50	5 / 50	5 / 50	5 / 50	5 / 50
Precharge length	Max	m	20	20	30	30	30	30	30
Additional charge		g/m	40	40	50	50	50	50	50
Operating range	Cooling Min / Max	°C	-10 / +43	-10 / +43	-10 / +43	-10 / +43	-10 / +43	-10 / +43	-10 / +43
	Heating Min / Max	°C	-15 / +24	-15 / +24	-15 / +24	-15 / +24	-15 / +24	-15 / +24	-15 / +24

Rating Conditions: Cooling Indoor 27°C DB / 19°C WB. Cooling Outdoor 35°C DB / 24°C WB. Heating Indoor 20°C DB. Heating Outdoor 7°C DB / 6°C WB. (DB: Dry Bulb; WB: Wet Bulb). // Specifications subject to change without notice.
 1) EER and COP, Energy Saving Classification, is at 220 / 240 V (380 / 415 V) only in accordance with EU directive 2002/31/EC. 2) SEER is calculated in base Eurovent IPLV for SBEM for U1 indoor unit SEER=a(EER25)+b(EER50)+c(EER75)+d(EER100) where EER25, EER50, EER75 and EER100 are the EER measured value at 25%, 50%, 75% and 100% part load for temperatures 20, 25, 30 and 35°C DB, respectively. a, b, c and d are values assigned for an office type. These values are given as a=0.2, b=0.36, c=0.32 and d=0.03. The internal temperatures are taken at 27°C DB and 19°C WB. 3) The annual consumption(ErP) is calculated by formula determined by ErP regulation. 4) Heating capacity is calculated including defrost factor correction. 5) SCOP is calculated in base Eurovent IPLV for SBEM with U1

STANDARD

Internet Control Ready

Energy saving

6,80 A++ SEER

4,00 A+ SCOP*

Down to -10°C in cooling mode

Down to -15°C in heating mode

Easy control by BMS

Possible to use on R22 pipings

5 year compressor warranty





INTERNET CONTROL READY: Optional. SEER and SCOP: For KIT-60PUY1E5A. 5 YEARS COMPRESSOR WARRANTY: Only for PRO partners.

HIGH HEATING CAPACITY AT -7°C



Panel CZ-KPU21



360° air flow



Optional Controller
Timer remote controller
CZ-RTC2



Optional Controller
Wired remote controller
CZ-RTC3 / CZ-RTC5



Optional Controller
Timer remote controller
CZ-RTC4



Optional Controller
Wireless remote controller
CZ-RWSK2



Optional Controller
Simplified remote controller
CZ-RE2C2

Compatible with all Panasonic connectivity solutions. For detailed information go to the Control Systems section.

ELITE

Single Phase						Three Phase			
5.0 kW	6.0 kW	7.1 kW	10.0 kW	12.5 kW	14.0 kW	7.1 kW	10.0 kW	12.5 kW	14.0 kW
KIT-50PU1E5A*	KIT-60PU1E5A*	KIT-71PU1E5A*	KIT-100PU1E5A*	KIT-125PU1E5A*	KIT-140PU1E5A*	KIT-71PU1E8A*	KIT-100PU1E8A*	KIT-125PU1E8A*	KIT-140PU1E8A*
S-50PU1E5A	S-60PU1E5A	S-71PU1E5A	S-100PU1E5A	S-125PU1E5A	S-140PU1E5A	S-71PU1E8A	S-100PU1E8A	S-125PU1E8A	S-140PU1E8A
U-50PE1E5	U-60PE1E5A	U-71PE1E5A	U-100PE1E5A	U-125PE1E5A	U-140PE1E5A	U-71PE1E8A	U-100PE1E8A	U-125PE1E8A	U-140PE1E8A
CZ-KPU21	CZ-KPU21	CZ-KPU21	CZ-KPU21	CZ-KPU21	CZ-KPU21	CZ-KPU21	CZ-KPU21	CZ-KPU21	CZ-KPU21
CZ-RTC2 / CZ-RTC4	CZ-RTC2 / CZ-RTC4	CZ-RTC2 / CZ-RTC4	CZ-RTC2 / CZ-RTC4	CZ-RTC2 / CZ-RTC4	CZ-RTC2 / CZ-RTC4	CZ-RTC2 / CZ-RTC4	CZ-RTC2 / CZ-RTC4	CZ-RTC2 / CZ-RTC4	CZ-RTC2 / CZ-RTC4
5.0 (1.5 - 5.6)	6.0 (2.5 - 7.1)	7.1 (2.5 - 8.0)	10.0 (3.3 - 12.5)	12.5 (3.3 - 14.0)	14.0 (3.3 - 15.5)	7.1 (3.2 - 8.0)	10.0 (3.3 - 12.5)	12.5 (3.3 - 14.0)	14.0 (3.3 - 15.5)
3.70 (5.77 - 2.80) A	4.05 (5.56 - 3.55) A	3.94 (5.56 - 3.02) A	4.20 (3.93 - 3.38) A	3.60 (3.93 - 3.04) A	3.25 (3.93 - 2.58) A	3.94 (5.56 - 3.02) A	4.20 (3.93 - 3.38) A	3.60 (3.93 - 3.04) A	3.25 (3.93 - 2.58) A
6.5 A+++	7.4 A+++	7.4 A+++	6.6 A+++	—	—	6.8 A+++	6.5 A+++	—	—
5.0	6.0	7.1	10.0	—	—	7.1	10.0	—	—
1.350 (0.260 - 2.000)	1.480 (0.450 - 2.000)	1.800 (0.450 - 2.650)	2.380 (0.840 - 3.700)	3.470 (0.840 - 4.600)	4.310 (0.840 - 6.000)	1.800 (0.560 - 2.650)	2.380 (0.840 - 3.700)	3.470 (0.840 - 4.600)	4.310 (0.840 - 6.000)
269	284	336	530	—	—	365	538	—	—
5.6 (1.5 - 6.5)	7.0 (2.0 - 8.0)	8.0 (2.0 - 9.0)	11.2 (4.1 - 14.0)	14.0 (4.1 - 16.0)	16.0 (4.1 - 18.0)	8.0 (2.8 - 9.0)	11.2 (4.1 - 14.0)	14.0 (4.1 - 16.0)	16.0 (4.1 - 18.0)
3.92 (6.82 - 2.83) A	3.87 (5.00 - 3.23) A	4.00 (5.00 - 3.10) A	4.31 (4.56 - 3.18) A	4.00 (4.56 - 3.08) A	3.70 (4.56 - 3.05) A	4.00 (5.60 - 3.10) A	4.31 (4.56 - 3.18) A	4.00 (4.56 - 3.08) A	3.70 (4.56 - 3.05) A
3.8 A	4.1 A+	4.1 A+	4.2 A+	—	—	4.0 A+	4.2 A+	—	—
4.0	6.0	7.1	10.0	—	—	7.1	10.0	—	—
1.430 (0.220 - 2.300)	1.810 (0.400 - 2.480)	2.000 (0.400 - 2.900)	2.600 (0.900 - 4.400)	3.500 (0.900 - 5.200)	4.330 (0.900 - 5.900)	2.000 (0.500 - 2.900)	2.600 (0.900 - 4.400)	3.500 (0.900 - 5.200)	4.330 (0.900 - 5.900)
1,474	2,047	2,424	3,333	—	—	2,485	3,333	—	—
960 / 810 / 720	1,260 / 1,020 / 840	1,320 / 1,020 / 840	1,980 / 1,620 / 1,260	2,100 / 1,680 / 1,320	2,160 / 1,740 / 1,380	1,320 / 1,020 / 840	1,980 / 1,620 / 1,260	2,100 / 1,680 / 1,320	2,160 / 1,740 / 1,380
960 / 810 / 720	1,260 / 1,020 / 840	1,320 / 1,020 / 840	1,980 / 1,620 / 1,260	2,100 / 1,680 / 1,320	2,160 / 1,740 / 1,380	1,320 / 1,020 / 840	1,980 / 1,620 / 1,260	2,100 / 1,680 / 1,320	2,160 / 1,740 / 1,380
2.8	3.4	4.2	6.0	7.9	9.0	4.2	6.0	7.9	9.0
32 / 29 / 27	36 / 31 / 28	37 / 31 / 28	44 / 38 / 32	45 / 39 / 33	46 / 40 / 34	37 / 31 / 28	44 / 38 / 32	45 / 39 / 33	46 / 40 / 34
32 / 29 / 27	36 / 31 / 28	37 / 31 / 28	44 / 38 / 32	45 / 39 / 33	46 / 40 / 34	37 / 31 / 28	44 / 38 / 32	45 / 39 / 33	46 / 40 / 34
49 / 46 / 44	53 / 48 / 45	54 / 48 / 45	62 / 55 / 49	63 / 56 / 50	64 / 57 / 51	54 / 48 / 45	62 / 55 / 49	63 / 56 / 50	64 / 57 / 51
49 / 46 / 44	53 / 48 / 45	54 / 48 / 45	62 / 55 / 49	63 / 56 / 50	64 / 57 / 51	54 / 48 / 45	62 / 55 / 49	63 / 56 / 50	64 / 57 / 51
256 x 840 x 840	256 x 840 x 840	256 x 840 x 840	319 x 840 x 840	319 x 840 x 840	319 x 840 x 840	256 x 840 x 840	319 x 840 x 840	319 x 840 x 840	319 x 840 x 840
33.5 x 950 x 950	33.5 x 950 x 950	33.5 x 950 x 950	33.5 x 950 x 950	33.5 x 950 x 950	33.5 x 950 x 950	33.5 x 950 x 950	33.5 x 950 x 950	33.5 x 950 x 950	33.5 x 950 x 950
23 (4)	24 (4)	24 (4)	27 (4)	27 (4)	27 (4)	24 (4)	27 (4)	27 (4)	27 (4)
220 / 230 / 240	220 / 230 / 240	220 / 230 / 240	220 / 230 / 240	220 / 230 / 240	220 / 230 / 240	380 / 400 / 415	380 / 400 / 415	380 / 400 / 415	380 / 400 / 415
16	20	20	25	30	30	16	16	16	16
2.5	2.5	2.5	4	6	6	2.5	2.5	2.5	2.5
6.50 / 6.20 / 5.95	7.15 / 6.90 / 6.70	8.40 / 8.10 / 7.90	10.7 / 10.3 / 9.90	15.8 / 15.3 / 14.8	19.6 / 19.0 / 18.4	2.80 / 2.70 / 2.60	3.70 / 3.50 / 3.40	5.45 / 5.15 / 5.00	6.75 / 6.45 / 6.20
6.90 / 6.60 / 6.30	8.50 / 8.20 / 7.95	9.30 / 9.00 / 8.70	11.8 / 11.4 / 11.0	15.9 / 15.4 / 14.9	19.8 / 19.2 / 18.6	3.10 / 3.00 / 2.90	4.05 / 3.85 / 3.75	5.50 / 5.20 / 5.05	6.85 / 6.50 / 6.25
1,800 / 2,100	3,600 / 3,600	3,600 / 3,600	6,600 / 5,700	7,800 / 6,600	8,100 / 7,200	3,600 / 3,600	6,600 / 5,700	7,800 / 6,600	8,100 / 7,200
46 / 50	48 / 50	48 / 50	52 / 52	53 / 53	54 / 55	48 / 50	52 / 52	53 / 53	54 / 55
65 / 69	65 / 67	65 / 67	69 / 69	70 / 70	71 / 71	65 / 67	69 / 69	70 / 70	71 / 71
569 x 790 x 285	996 x 940 x 340	996 x 940 x 340	1,416 x 940 x 340	1,416 x 940 x 340	1,416 x 940 x 340	996 x 940 x 340	1,416 x 940 x 340	1,416 x 940 x 340	1,416 x 940 x 340
42	68	69	98	98	98	71	98	98	98
1/4 (6.35) / 1/2 (12.7)	3/8 (9.52) / 5/8 (15.88)	3/8 (9.52) / 5/8 (15.88)	3/8 (9.52) / 5/8 (15.88)	3/8 (9.52) / 5/8 (15.88)	3/8 (9.52) / 5/8 (15.88)	3/8 (9.52) / 5/8 (15.88)	3/8 (9.52) / 5/8 (15.88)	3/8 (9.52) / 5/8 (15.88)	3/8 (9.52) / 5/8 (15.88)
1.65	2	2.35	3.4	3.4	3.4	2.35	3.4	3.4	3.4
30	30	30	30	30	30	30	30	30	30
5 / 40	5 / 50	5 / 50	5 / 75	5 / 75	5 / 75	5 / 50	5 / 75	5 / 75	5 / 75
30	30	30	30	30	30	30	30	30	30
20	50	50	50	50	50	50	50	50	50
-15 / +46	-15 / +46	-15 / +46	-15 / +46	-15 / +46	-15 / +46	-15 / +46	-15 / +46	-15 / +46	-15 / +46
-20 / +24	-20 / +24	-20 / +24	-20 / +24	-20 / +24	-20 / +24	-20 / +24	-20 / +24	-20 / +24	-20 / +24

indoor unit including defrost correction factor. 6) The Sound pressure level of the units shows the value measured of a position 1 meter in front of the main body and 1.5 m from the ground. The sound pressure is measured in accordance with Eurovent 6/C/006-97 specification. 7) When installing the outdoor unit at a higher position than the indoor unit. // Recommended fuse for the indoor 3A. // * Available from May 2014. For detailed information about ErP, please visit our websites www.aircon.panasonic.co.uk or www.ptc.panasonic.eu

ELITE

- Internet Control Ready** (INTERNET CONTROL)
- Energy saving** (INVERTER+)
- 7,40 A++ SEER** (SEASONAL ENERGY EFFICIENCY RATIO)
- 4,10 A+ SCOP** (SEASONAL COEFFICIENT OF PERFORMANCE)
- Down to -15°C in cooling mode** (OUTDOOR TEMPERATURE)
- Down to -20°C in heating mode** (OUTDOOR TEMPERATURE)
- Easy control by BMS** (CONNECTIVITY)
- Possible to use on R22 pipings** (R22 RENEWAL)
- 5 year compressor warranty**



INTERNET CONTROL READY: Optional. SEER and SCOP: For KIT-60PU1E5A and KIT-71PU1E5A. 5 YEARS COMPRESSOR WARRANTY: Only for PRO partners.

LOW STATIC PRESSURE HIDE AWAY PACi STANDARD AND ELITE INVERTER+

The depth of only 250mm provides greater installation flexibility and the unit can be used in more applications. Ideal for sites with narrow ceiling voids.

Technical Focus

- Compact indoor units without losing static pressure (Only 250 mm high)
- 50 Pa static pressure
- Easy maintenance and service via external electrical box
- 3 speed centrifugal fan through wired or wireless remote control
- DC FAN for better efficiency and control
- Easy connection and control of external fan or ERV using the connector PAW-FDC on the indoor unit PCB. The external device can be control by the remote control of the Panasonic indoor unit

STANDARD

		Single Phase				Three Phase			
		6.0 kW	7.1 kW	10.0 kW	12.5 kW	10.0 kW	12.5 kW	14.0 kW	
KIT		KIT-60PNY1E5A*	KIT-71PNY1E5A*	KIT-100PNY1E5A*	KIT-125PNY1E5A*	KIT-100PNY1E8A*	KIT-125PNY1E8A*	KIT-140PNY1E8A*	
Indoor		S-60PN1E5A	S-71PN1E5A	S-100PN1E5A	S-125PN1E5A	S-100PN1E5A	S-125PN1E5A	S-140PN1E5A	
Outdoor		U-60PEY1E5	U-71PEY1E5	U-100PEY1E5	U-125PEY1E5	U-100PEY1E8	U-125PEY1E8	U-140PEY1E8	
Timer remote controller		CZ-RTC2 / CZ-RTC4	CZ-RTC2 / CZ-RTC4	CZ-RTC2 / CZ-RTC4	CZ-RTC2 / CZ-RTC4	CZ-RTC2 / CZ-RTC4	CZ-RTC2 / CZ-RTC4	CZ-RTC2 / CZ-RTC4	
Cooling capacity	Nominal (Min - Max)	kW	6.0 (2.0 - 7.0)	7.1 (2.0 - 7.7)	10.0 (2.7 - 11.5)	12.5 (3.8 - 13.5)	10.0 (2.7 - 11.5)	12.5 (3.8 - 13.5)	
EER ¹⁾	Nominal (Min - Max)	W/W	3.02 (6.15 - 2.38) B	2.76 (6.15 - 2.38) D	2.81 (4.74 - 2.67) C	2.81 (4.00 - 2.60) C	2.81 (4.00 - 2.60) C	2.98 (3.93 - 2.58) C	
SEER ²⁾	Nominal (Min - Max)	W/W	4.7 B	5.0 B	5.3 A	—	5.2 A	—	
Pdesign		kW	6.0	7.1	10.0	—	10.0	—	
Power input cooling	Nominal (Min - Max)	kW	1.990 (0.325 - 2.940)	2.570 (0.325 - 3.230)	3.555 (0.570 - 4.300)	4.445 (0.950 - 5.200)	3.555 (0.570 - 4.300)	4.445 (0.950 - 5.200)	
Annual energy consumption (ErP) ³⁾		kWh/a	444	496	660	—	673	—	
Heating capacity	Nominal (Min - Max)	kW	6.0 (1.8 - 7.0)	7.1 (1.8 - 8.1)	10.0 (2.1 - 13.8)	12.5 (3.4 - 15.0)	10.0 (2.1 - 13.8)	12.5 (3.4 - 15.0)	
Heating capacity at -7°C ⁴⁾	Nominal	kW	4.99	5.08	9.97	10.97	10.97	13.35	
Heating capacity at -15°C ⁴⁾	Nominal	kW	4.20	4.37	8.43	9.03	8.43	12.38	
COP ¹⁾	Nominal (Min - Max)	W/W	3.61 (6.55 - 2.89) A	3.41 (6.55 - 2.91) B	3.41 (4.67 - 3.37) B	3.41 (4.36 - 3.26) B	3.41 (4.67 - 3.37) B	3.52 (4.56 - 3.08) B	
SCOP ⁵⁾	Nominal (Min - Max)	W/W	3.8 A	3.8 A	3.8 A	—	3.8 A	—	
Pdesign at -10°C		kW	4.8	5.3	7.6	—	7.6	—	
Power input heating	Nominal (Min - Max)	kW	1.660 (0.275 - 2.420)	2.080 (0.275 - 2.780)	2.935 (0.450 - 4.100)	3.665 (0.780 - 4.600)	2.935 (0.450 - 4.100)	3.665 (0.780 - 4.600)	
Annual energy consumption (ErP) ³⁾		kWh/a	1,757	1,952	2,800	—	2,800	—	
Indoor unit									
External static pressure ⁶⁾	Nominal (Min - Max)	Pa	50 (10 - 80)	50 (10 - 80)	50 (10 - 80)	50 (10 - 80)	50 (10 - 80)	50 (10 - 80)	
Air volume	Cooling / Heating	m³/h	1,320 / 1,320	1,320 / 1,320	2,160 / 2,160	2,280 / 2,280	2,160 / 2,160	2,280 / 2,280	
Moisture removal volume		l/h	3.4	4.2	6.0	7.9	6.0	7.9	
Sound pressure level ⁷⁾	Cooling (Hi / Med / Lo)	dB(A)	43 / 41 / 36	43 / 41 / 36	44 / 42 / 37	45 / 43 / 38	44 / 42 / 37	45 / 43 / 38	
	Heating (Hi / Med / Lo)	dB(A)	43 / 41 / 36	43 / 41 / 36	44 / 42 / 37	45 / 43 / 38	44 / 42 / 37	45 / 43 / 38	
Sound power level	Cooling (Hi / Med / Lo)	dB	60 / 58 / 53	60 / 58 / 53	65 / 63 / 58	66 / 64 / 59	65 / 63 / 58	66 / 64 / 59	
	Heating (Hi / Med / Lo)	dB	60 / 58 / 53	60 / 58 / 53	65 / 63 / 58	66 / 64 / 59	65 / 63 / 58	66 / 64 / 59	
Dimensions ⁸⁾	H x W x D	mm	250 x 1,000(+100) x 650	250 x 1,000(+100) x 650	250 x 1,200(+100) x 650	250 x 1,200(+100) x 650	250 x 1,200(+100) x 650	250 x 1,200(+100) x 650	
Net weight		kg	32	32	41	41	41	41	
Outdoor unit									
Power source		V	220 / 230 / 240	220 / 230 / 240	220 / 230 / 240	220 / 230 / 240	380 / 400 / 415	380 / 400 / 415	
Recommended fuse		A	20	20	25	30	16	16	
Connection		mm²	2.5	2.5	4	6	2.5	2.5	
Current	Cooling	A	9.1 / 8.7 / 8.4	12.0 / 11.5 / 11.0	16.0 / 15.3 / 14.8	20.1 / 19.3 / 18.7	5.45 / 5.20 / 5.05	6.85 / 6.50 / 6.25	
	Heating	A	7.5 / 7.2 / 6.9	9.6 / 9.2 / 8.9	13.0 / 12.5 / 12.1	16.5 / 15.8 / 15.2	4.45 / 4.25 / 4.10	5.55 / 5.30 / 5.10	
Air volume	Cooling / Heating	m³/h	1,800 / 2,100	2,340	4,560 / 4,020	4,800 / 4,380	4,560 / 4,020	4,800 / 4,380	
Sound pressure level	Cooling / Heating (Hi)	dB(A)	46 / 50	50 / 52	54 / 54	56 / 56	54 / 54	56 / 56	
Sound power level	Cooling / Heating (Hi)	dB	65 / 69	70 / 70	70 / 70	73 / 73	70 / 70	73 / 73	
Dimensions	H x W x D	mm	569 x 790 x 285	569 x 790 x 285	996 x 940 x 340	996 x 940 x 340	996 x 940 x 340	996 x 940 x 340	
Net weight		kg	42	42	73	85	73	85	
Piping connections	Liquid pipe	Inch (mm)	3/8 (9.52)	3/8 (9.52)	3/8 (9.52)	3/8 (9.52)	3/8 (9.52)	3/8 (9.52)	
	Gas pipe	Inch (mm)	5/8 (15.88)	5/8 (15.88)	5/8 (15.88)	5/8 (15.88)	5/8 (15.88)	5/8 (15.88)	
Refrigerant loading	R410A	kg	1.7	1.7	2.60	3.20	2.60	3.4	
Elevation difference (in/out) ⁹⁾	Max	m	30	30	30	30	30	30	
Piping length	Min / Max	m	5 / 50	5 / 50	5 / 50	5 / 50	5 / 50	5 / 50	
Precharge length	Max	m	20	20	30	30	30	30	
Additional charge		g/m	40	40	50	50	50	50	
Operating range	Cooling Min / Max	°C	-10 / +43	-10 / +43	-10 / +43	-10 / +43	-10 / +43	-10 / +43	
	Heating Min / Max	°C	-15 / +24	-15 / +24	-15 / +24	-15 / +24	-15 / +24	-15 / +24	

Rating Conditions: Cooling Indoor 27°C DB / 19°C WB. Cooling Outdoor 35°C DB / 24°C WB. Heating Indoor 20°C DB. Heating Outdoor 7°C DB / 6°C WB. (DB: Dry Bulb; WB: Wet Bulb). // Specifications subject to change without notice.
 1) EER and COP, Energy Saving Classification, is at 220 / 240 V (380 / 415 V) only in accordance with EU directive 2002/31/EC. 2) SEER is calculated in base Eurovent IPLV for SBEM for U1 indoor unit SEER=a(EER25)+b(EER50)+c(EER75)+d(EER100) where EER25, EER50, EER75 and EER100 are the EER measured value at 25%, 50%, 75% and 100% part load for temperatures 20, 25, 30 and 35°C DB, respectively. a, b, c and d are values assigned for an office type. These values are given as a=0.2, b=0.36, c=0.32 and d=0.03. The internal temperatures are taken at 27°C DB and 19°C WB. 3) The annual consumption(ErP) is calculated by formula determined by ErP regulation. 4) Heating capacity is calculated including defrost factor correction. 5) SCOP is calculated in base Eurovent IPLV for SBEM with U1

STANDARD

Internet Control Ready

INTERNET CONTROL

Energy saving

INVERTER+

5.30 A SEER

SEASONAL ENERGY EFFICIENCY RATIO

3.80 A SCOP

SEASONAL COEFFICIENT OF PERFORMANCE

Down to -10°C in cooling mode

OUTDOOR TEMPERATURE

Down to -15°C in heating mode

OUTDOOR TEMPERATURE

Easy control by BMS

CONNECTIVITY

Possible to use on R22 pipings

R22 RENEWAL

5 year compressor warranty



INTERNET CONTROL READY: Optional. SEER and SCOP: For KIT-100PNY1E5A. 5 YEARS COMPRESSOR WARRANTY: Only for PRD partners.

HIGH HEATING CAPACITY AT -7°C



- Optional Controller**
Timer remote controller
CZ-RTC2
- Optional Controller**
Wired remote controller
CZ-RTC3 / CZ-RTC5
- Optional Controller**
Timer remote controller
CZ-RTC4
- Optional Controller**
Wireless remote controller
CZ-RWSK2
- Optional Controller**
Simplified remote controller
CZ-RE2C2

Compatible with all Panasonic connectivity solutions. For detailed information go to the Control Systems section.



ELITE

Single Phase					Three Phase				
5.0 kW	6.0 kW	7.1 kW	10.0 kW	12.5 kW	14.0 kW	7.1 kW	10.0 kW	12.5 kW	14.0 kW
KIT-50PN1E5A*	KIT-60PN1E5A*	KIT-71PN1E5A*	KIT-100PN1E5A*	KIT-125PN1E5A*	KIT-140PN1E5A*	KIT-71PN1E8A*	KIT-100PN1E8A*	KIT-125PN1E8A*	KIT-140PN1E8A*
S-50PN1E5A	S-60PN1E5A	S-71PN1E5A	S-100PN1E5A	S-125PN1E5A	S-140PN1E5A	S-71PN1E8A	S-100PN1E8A	S-125PN1E8A	S-140PN1E8A
U-50PE1E5	U-60PE1E5A	U-71PE1E5A	U-100PE1E5A	U-125PE1E5A	U-140PE1E5A	U-71PE1E8A	U-100PE1E8A	U-125PE1E8A	U-140PE1E8A
CZ-RTC2 / CZ-RTC4	CZ-RTC2 / CZ-RTC4	CZ-RTC2 / CZ-RTC4	CZ-RTC2 / CZ-RTC4	CZ-RTC2 / CZ-RTC4	CZ-RTC2 / CZ-RTC4	CZ-RTC2 / CZ-RTC4	CZ-RTC2 / CZ-RTC4	CZ-RTC2 / CZ-RTC4	CZ-RTC2 / CZ-RTC4
5.0 (1.5 - 5.6)	6.0 (2.5 - 7.1)	7.1 (2.5 - 8.0)	10.0 (3.3 - 12.5)	12.5 (3.3 - 14.0)	14.0 (3.3 - 15.5)	7.1 (2.5 - 8.0)	10.0 (3.3 - 12.5)	12.5 (3.3 - 14.0)	14.0 (3.3 - 15.5)
3.21 (5.77 - 2.42) A	3.24 (4.55 - 3.37) A	3.30 (4.55 - 2.91) A	3.75 (3.79 - 3.29) A	3.21 (3.30 - 2.92) A	3.01 (3.30 - 2.50) B	3.30 (3.79 - 2.91) A	3.75 (3.79 - 3.29) A	3.21 (3.30 - 2.92) A	3.01 (3.30 - 2.50) A
4.6 B	5.5 A	5.5 A	6.0 A+	—	—	5.2 A	5.8 A+	—	—
5.0	6.0	7.1	10.0	—	—	7.1	10.0	—	—
1.560 (0.260 - 2.310)	1.850 (0.550 - 2.105)	2.150 (0.550 - 2.750)	2.670 (0.870 - 3.800)	3.890 (1.000 - 4.800)	4.650 (1.000 - 6.200)	2.150 (0.660 - 2.750)	2.670 (0.870 - 3.800)	3.890 (1.000 - 4.800)	4.650 (1.000 - 6.200)
380	382	452	583	—	—	477	603	—	—
5.6 (1.5 - 6.3)	7.0 (2.0 - 8.0)	8.0 (2.0 - 9.0)	11.2 (4.1 - 14.0)	14.0 (4.1 - 16.0)	16.0 (4.1 - 18.0)	8.0 (2.0 - 9.0)	11.2 (4.1 - 14.0)	14.0 (4.1 - 16.0)	16.0 (4.1 - 18.0)
4.20	6.69	7.52	12.04	13.48	14.24	7.52	12.04	13.48	14.24
3.58	6.56	7.65	11.20	12.38	12.69	7.65	11.20	12.38	12.69
3.22 (6.82 - 2.50) C	3.61 (4.00 - 3.09) A	3.54 (4.00 - 3.08) B	3.80 (4.18 - 3.11) A	3.61 (3.90 - 2.96) A	3.41 (3.90 - 2.95) B	3.54 (3.33 - 3.00) B	3.80 (4.18 - 3.11) A	3.61 (3.90 - 2.96) A	3.41 (3.90 - 2.95) B
3.8 A	3.8 A	3.7 A	3.9 A	—	—	3.7 A	3.8 A	—	—
3.8	5.6	6.5	10.0	—	—	6.5	10.0	—	—
1.740 (0.220 - 2.520)	1.940 (0.500 - 2.585)	2.260 (0.500 - 2.920)	2.950 (0.980 - 4.500)	3.880 (1.050 - 5.400)	4.690 (1.050 - 6.100)	2.260 (0.600 - 3.000)	2.950 (0.980 - 4.500)	3.880 (1.050 - 5.400)	4.690 (1.050 - 6.100)
1,400	2,061	2,458	3,590	—	—	2,458	3,684	—	—
50 (10 - 80)	50 (10 - 80)	50 (10 - 80)	50 (10 - 80)	50 (10 - 80)	50 (10 - 80)	50 (10 - 80)	50 (10 - 80)	50 (10 - 80)	50 (10 - 80)
960 / 960	1,320 / 1,320	1,320 / 1,320	2,160 / 2,160	2,280 / 2,280	2,400 / 2,400	1,320 / 1,320	2,160 / 2,160	2,280 / 2,280	2,400 / 2,400
2.8	3.4	4.2	6.0	7.9	9.0	4.2	6.0	7.9	9.0
41 / 39 / 35	43 / 41 / 36	43 / 41 / 36	44 / 42 / 37	45 / 43 / 38	46 / 44 / 39	43 / 41 / 36	44 / 42 / 37	45 / 43 / 38	46 / 44 / 39
41 / 39 / 35	43 / 41 / 36	43 / 41 / 36	44 / 42 / 37	45 / 43 / 38	46 / 44 / 39	43 / 41 / 36	44 / 42 / 37	45 / 43 / 38	46 / 44 / 39
58 / 56 / 52	60 / 58 / 53	60 / 58 / 53	65 / 63 / 58	66 / 64 / 59	67 / 65 / 60	60 / 58 / 53	65 / 63 / 58	66 / 64 / 59	67 / 65 / 60
58 / 56 / 52	60 / 58 / 53	60 / 58 / 53	65 / 63 / 58	66 / 64 / 59	67 / 65 / 60	60 / 58 / 53	65 / 63 / 58	66 / 64 / 59	67 / 65 / 60
250x780(+100)x650	250x1,000(+100)x650	250x1,000(+100)x650	250x1,200(+100)x650	250x1,200(+100)x650	250x1,200(+100)x650	250x1,000(+100)x650	250x1,200(+100)x650	250x1,200(+100)x650	250x1,200(+100)x650
29	32	32	41	41	41	32	41	41	41
220 / 230 / 240	220 / 230 / 240	220 / 230 / 240	220 / 230 / 240	220 / 230 / 240	220 / 230 / 240	380 / 400 / 415	380 / 400 / 415	380 / 400 / 415	380 / 400 / 415
16	20	20	25	30	30	16	16	16	16
2.5	2.5	2.5	4	6	6	2.5	2.5	2.5	2.5
7.10 / 6.80 / 6.60	8.20 / 8.00 / 7.80	9.70 / 9.40 / 9.20	11.6 / 11.2 / 10.9	17.4 / 16.9 / 16.4	20.5 / 20.1 / 19.5	3.25 / 3.10 / 3.00	3.95 / 3.75 / 3.60	5.80 / 5.50 / 5.30	6.95 / 6.60 / 6.35
8.00 / 7.70 / 7.40	8.60 / 8.40 / 8.20	10.2 / 9.90 / 9.70	12.8 / 12.5 / 12.2	17.3 / 16.8 / 16.3	20.6 / 20.2 / 19.6	3.35 / 3.20 / 3.10	4.35 / 4.15 / 4.00	5.80 / 5.50 / 5.30	7.00 / 6.65 / 6.45
1,800 / 2,100	3,600 / 3,600	3,600 / 3,600	6,600 / 5,700	7,800 / 6,600	8,100 / 7,200	3,600 / 3,600	6,600 / 5,700	7,800 / 6,600	8,100 / 7,200
46 / 50	48 / 50	48 / 50	52 / 52	53 / 53	54 / 55	48 / 50	52 / 52	53 / 53	54 / 55
65 / 69	65 / 67	65 / 67	69 / 69	70 / 70	71 / 71	65 / 67	69 / 69	70 / 70	71 / 71
569 x 790 x 285	996 x 940 x 340	996 x 940 x 340	1,416 x 940 x 340	1,416 x 940 x 340	1,416 x 940 x 340	996 x 940 x 340	1,416 x 940 x 340	1,416 x 940 x 340	1,416 x 940 x 340
42	68	69	98	98	98	71	98	98	98
1/4 (6.35)	3/8 (9.52)	3/8 (9.52)	3/8 (9.52)	3/8 (9.52)	3/8 (9.52)	3/8 (9.52)	3/8 (9.52)	3/8 (9.52)	3/8 (9.52)
1/2 (12.7)	5/8 (15.88)	5/8 (15.88)	5/8 (15.88)	5/8 (15.88)	5/8 (15.88)	5/8 (15.88)	5/8 (15.88)	5/8 (15.88)	5/8 (15.88)
1.65	2	2.35	3.4	3.4	3.4	2.35	3.4	3.4	3.4
30	30	30	30	30	30	30	30	30	30
5 - 40	5 - 50	5 - 50	5 - 75	5 - 75	5 - 75	5 - 50	5 - 75	5 - 75	5 - 75
30	30	30	30	30	30	30	30	30	30
20	50	50	50	50	50	50	50	50	50
-15 / +46	-15 / +46	-15 / +46	-15 / +46	-15 / +46	-15 / +46	-15 / +46	-15 / +46	-15 / +46	-15 / +46
-20 / +24	-20 / +24	-20 / +24	-20 / +24	-20 / +24	-20 / +24	-20 / +24	-20 / +24	-20 / +24	-20 / +24

indoor unit including defrost correction factor. 6) Medium External static pressure setting from factory. 7) The Sound pressure level of the units shows the value measured at a position 1 meter in front of the main body and 1.5 m from the ground. The sound pressure is measured in accordance with Eurovent 6/C/006-97 specification. 8) Add 100 mm for piping port. 9) When installing the outdoor unit at a higher position than the indoor unit. // Recommended fuse for the indoor 3A. // * Available from May 2014. For detailed information about ErP, please visit our websites www.aircon.panasonic.co.uk or www.ptc.panasonic.eu

ELITE

- Internet Control Ready**
- Energy saving**
- 6.00 A+ SEER**
- 3.90 A SCOP**
- Down to -15°C in cooling mode**
- Down to -20°C in heating mode**
- Easy control by BMS**
- Possible to use on R22 pipings**
- 5 year compressor warranty**



INTERNET CONTROL READY: Optional. SEER and SCOP: For KIT-100PN1E5A. 5 YEARS COMPRESSOR WARRANTY: Only for PRO partners.

HIGH STATIC PRESSURE HIDE AWAY PACi STANDARD AND ELITE INVERTER+

The ducted systems are the ideal solution for flexible, concealed air conditioning and the optional 200mm spigots ensure simple, hassle-free connection to spiral ductwork.

Technical Focus

- Extremely quiet operation from 26 dB(A)
- Auto restart after power failure
- Auto changeover
- Twin, triple and double-twin split options
- DC FAN for better efficiency and control
- Built in drain pump
- Easy connection and control of external fan or ERV using the connector PAW-FDC on the indoor unit PCB. The external device can be control by the remote control of the Panasonic indoor unit

STANDARD

		Single Phase				Three Phase			
		6.0 kW	7.1 kW	10.0 kW	12.5 kW	10.0 kW	12.5 kW	14.0 kW	
KIT		KIT-60PFY1E5A*	KIT-71PFY1E5A*	KIT-100PFY1E5A*	KIT-125PFY1E5A*	KIT-100PFY1E8A*	KIT-125PFY1E8A*	KIT-140PFY1E8A*	
Indoor		S-60PF1E5A	S-71PF1E5A	S-100PF1E5A	S-125PF1E5A	S-100PF1E8A	S-125PF1E8A	S-140PF1E8A	
Outdoor		U-60PEY1E5	U-71PEY1E5	U-100PEY1E5	U-125PEY1E5	U-100PEY1E8	U-125PEY1E8	U-140PEY1E8	
Timer remote controller		CZ-RTC2 / CZ-RTC4	CZ-RTC2 / CZ-RTC4	CZ-RTC2 / CZ-RTC4	CZ-RTC2 / CZ-RTC4	CZ-RTC2 / CZ-RTC4	CZ-RTC2 / CZ-RTC4	CZ-RTC2 / CZ-RTC4	
Cooling capacity	Nominal (Min - Max)	kW	6.0 (2.0 - 7.0)	7.1 (2.0 - 7.7)	10.0 (2.7 - 11.5)	12.5 (3.8 - 13.5)	10.0 (2.7 - 11.5)	12.5 (3.8 - 13.5)	14.0 (3.3 - 15.5)
EER ¹⁾	Nominal (Min - Max)	W/W	3.10 (6.15 - 2.46) B	2.76 (6.15 - 2.35) D	3.01 (5.09 - 2.74) B	3.05 (4.22 - 2.70) B	3.01 (5.09 - 2.74) B	3.05 (4.22 - 2.70) B	3.22 (3.93 - 2.58) A
SEER ²⁾	Nominal (Min - Max)	W/W	5.4 A	5.3 A	5.4 A	—	5.2 A	—	—
Pdesign		kW	6.0	7.1	10.0	—	10.0	—	—
Power input cooling	Nominal (Min - Max)	kW	1.930 (0.325 - 2.850)	2.570 (0.325 - 3.270)	3.320 (0.530 - 4.200)	4.100 (0.900 - 5.000)	3.320 (0.530 - 4.200)	4.100 (0.900 - 5.000)	4.350 (0.840 - 6.000)
Annual energy consumption (ErP) ³⁾		kWh/a	389	469	648	—	673	—	—
Heating capacity	Nominal (Min - Max)	kW	6.0 (1.8 - 7.0)	7.1 (1.8 - 8.1)	10.0 (2.1 - 13.8)	12.5 (3.4 - 15.0)	10.0 (2.1 - 13.8)	12.5 (3.4 - 15.0)	14.0 (4.1 - 16.0)
Heating capacity at -7°C ⁴⁾	Nominal	kW	4.99	5.08	9.97	10.97	10.97	13.35	13.35
Heating capacity at -15°C ⁴⁾	Nominal	kW	4.20	4.37	8.43	9.03	8.43	12.38	12.38
COP ¹⁾	Nominal (Min - Max)	W/W	4.25 (6.55 - 3.41) A	3.94 (6.55 - 3.40) A	3.80 (5.12 - 3.45) A	3.82 (4.66 - 3.41) A	3.80 (5.12 - 3.45) A	3.82 (4.66 - 3.41) A	3.91 (4.56 - 3.08) A
SCOP ⁵⁾	Nominal (Min - Max)	W/W	3.8 A	3.8 A	3.8 A	—	3.8 A	—	—
Pdesign at -10°C		kW	5.0	5.5	9.5	—	9.5	—	—
Power input heating	Nominal (Min - Max)	kW	1.410 (0.275 - 2.055)	1.800 (0.275 - 2.380)	2.630 (0.410 - 4.000)	3.270 (0.730 - 4.400)	2.630 (0.410 - 4.000)	3.270 (0.730 - 4.400)	3.580 (0.900 - 5.200)
Annual energy consumption (ErP) ³⁾		kWh/a	1,842	2,026	3,500	—	3,500	—	—
Indoor unit									
External static pressure ⁶⁾	Nominal (Min - Max)	Pa	70 (10 - 150)	70 (10 - 150)	100 (10 - 150)	100 (10 - 150)	100 (10 - 150)	100 (10 - 150)	100 (10 - 150)
Air volume	Cooling (Hi / Med / Lo)	m³/h	1,260 / 1,140 / 900	1,260 / 1,140 / 900	1,920 / 1,560 / 1,260	2,040 / 1,740 / 1,380	1,920 / 1,560 / 1,260	2,040 / 1,740 / 1,380	2,160 / 1,920 / 1,500
	Heating (Hi / Med / Lo)	m³/h	1,260 / 1,140 / 900	1,260 / 1,140 / 900	1,920 / 1,560 / 1,260	2,040 / 1,740 / 1,380	1,920 / 1,560 / 1,260	2,040 / 1,740 / 1,380	2,160 / 1,920 / 1,500
Moisture removal volume		l/h	3.4	4.2	6.0	7.9	6.0	7.9	9.0
Sound pressure level ⁷⁾	Cooling (Hi / Med / Lo)	dB(A)	35 / 32 / 26	35 / 32 / 26	38 / 34 / 31	39 / 35 / 32	38 / 34 / 31	39 / 35 / 32	40 / 36 / 33
	Heating (Hi / Med / Lo)	dB(A)	35 / 32 / 26	35 / 32 / 26	38 / 34 / 31	39 / 35 / 32	38 / 34 / 31	39 / 35 / 32	40 / 36 / 33
Sound power level	Cooling (Hi / Med / Lo)	dB	57 / 54 / 48	57 / 54 / 48	60 / 56 / 53	61 / 57 / 54	60 / 56 / 53	61 / 57 / 54	62 / 58 / 55
	Heating (Hi / Med / Lo)	dB	57 / 54 / 48	57 / 54 / 48	60 / 56 / 53	61 / 57 / 54	60 / 56 / 53	61 / 57 / 54	62 / 58 / 55
Dimensions	H x W x D	mm	290 x 1,000 x 700	290 x 1,000 x 700	290 x 1,400 x 700	290 x 1,400 x 700	290 x 1,400 x 700	290 x 1,400 x 700	290 x 1,400 x 700
Net weight		kg	33	33	45	45	45	45	45
Outdoor unit									
Power source		V	220 / 230 / 240	220 / 230 / 240	220 / 230 / 240	220 / 230 / 240	380 / 400 / 415	380 / 400 / 415	380 / 400 / 415
Recommended fuse		A	20	20	25	30	16	16	16
Connection		mm²	2.5	2.5	4	6	2.5	2.5	2.5
Current	Cooling	A	9.00 / 8.65 / 8.30	12.2 / 11.7 / 11.2	15.1 / 14.5 / 13.9	18.8 / 18.0 / 17.2	5.10 / 4.85 / 4.70	6.20 / 5.90 / 5.70	6.75 / 6.45 / 6.25
	Heating	A	6.40 / 6.10 / 5.90	8.30 / 7.90 / 7.60	11.8 / 11.2 / 10.7	14.6 / 14.0 / 13.4	4.05 / 3.80 / 3.65	4.90 / 4.65 / 4.50	5.60 / 5.40 / 5.20
Air volume	Cooling / Heating	m³/h	1,800 / 2,100	2,340 / 2,340	4,560 / 4,020	4,800 / 4,380	4,800 / 4,020	4,800 / 4,380	8,100 / 7,200
Sound pressure level	Cooling / Heating (Hi)	dB(A)	46 / 50	50 / 52	54 / 54	56 / 56	54 / 54	56 / 56	54 / 53
Sound power level	Cooling / Heating (Hi)	dB	65 / 69	70 / 70	70 / 70	73 / 73	70 / 70	73 / 73	71 / 70
Dimensions	H x W x D	mm	569 x 790 x 285	569 x 790 x 285	996 x 940 x 340	996 x 940 x 340	996 x 940 x 340	996 x 940 x 340	1,416 x 940 x 340
Net weight		kg	42	42	73	85	73	85	98
Piping connections	Liquid pipe	Inch (mm)	3/8 (9.52)	3/8 (9.52)	3/8 (9.52)	3/8 (9.52)	3/8 (9.52)	3/8 (9.52)	3/8 (9.52)
	Gas pipe	Inch (mm)	5/8 (15.88)	5/8 (15.88)	5/8 (15.88)	5/8 (15.88)	5/8 (15.88)	5/8 (15.88)	5/8 (15.88)
Refrigerant loading	R410A	kg	1.7	1.7	2.60	3.20	2.60	3.20	3.4
Elevation difference (in/out) ⁸⁾	Max	m	30	30	30	30	30	30	30
Piping length	Min / Max	m	5 / 50	5 / 50	5 / 50	5 / 50	5 / 50	5 / 50	5 / 50
Precharge length	Max	m	20	20	30	30	30	30	30
Additional charge		g/m	40	40	50	50	50	50	50
Operating range	Cooling Min / Max	°C	-10 / +43	-10 / +43	-10 / +43	-10 / +43	-10 / +43	-10 / +43	-10 / +43
	Heating Min / Max	°C	-15 / +24	-15 / +24	-15 / +24	-15 / +24	-15 / +24	-15 / +24	-15 / +24

Rating Conditions: Cooling Indoor 27°C DB / 19°C WB. Cooling Outdoor 35°C DB / 24°C WB. Heating Indoor 20°C DB. Heating Outdoor 7°C DB / 6°C WB. (DB: Dry Bulb; WB: Wet Bulb). // Specifications subject to change without notice.
 1) EER and COP, Energy Saving Classification, is at 220 / 240 V (380 / 415 V) only in accordance with EU directive 2002/31/EC. 2) SEER is calculated in base Eurovent IPLV for SBEM for U1 indoor unit SEER=a(EER25)+b(EER50)+c(EER75)+d(EER100) where EER25, EER50, EER75 and EER100 are the EER measured value at 25%, 50%, 75% and 100% part load for temperatures 20, 25, 30 and 35°C DB, respectively. a, b, c and d are values assigned for an office type. These values are given as a=0.2, b=0.36, c=0.32 and d=0.03. The internal temperatures are taken at 27°C DB and 19°C WB. 3) The annual consumption(ErP) is calculated by formula determined by ErP regulation. 4) Heating capacity is calculated including defrost factor correction. 5) SCOP is calculated in base Eurovent IPLV for SBEM with U1

STANDARD

Internet Control Ready

Energy saving

5.40 A SEER

3.80 A SCOP

Down to -10°C in cooling mode

Down to -15°C in heating mode

Easy control by BMS

Possible to use on R22 pipings

5 year compressor warranty



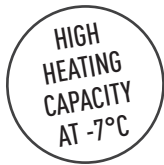

- Optional Controller**
Timer remote controller
CZ-RTC2
- Optional Controller**
Wired remote controller
CZ-RTC3 / CZ-RTC5
- Optional Controller**
Timer remote controller
CZ-RTC4
- Optional Controller**
Wireless remote controller
CZ-RWSK2
- Optional Controller**
Simplified remote controller
CZ-RE2C2

Compatible with all Panasonic connectivity solutions. For detailed information go to the Control Systems section.



S-100PF1E5A // S-125PF1E5A // S-140PF1E5A

Air Outlet Plenum (without regulation adaptor)			Air Inlet Plenum		
	Diameters	Model		Diameters	Model
60 & 71	3 x Ø 200	CZ-90DAF2	60 & 71	2 x Ø 250	CZ-DUMPA90MF2
100, 125 & 140	4 x Ø 200	CZ-160DAF2	100, 125 & 140	4 x Ø 200	CZ-DUMPA160MF2
36, 45 & 50		CZ-50DAF2	36, 45 & 50		CZ-DUMPA50MF2

ELITE

Single Phase					Three Phase				
5.0 kW	6.0 kW	7.1 kW	10.0 kW	12.5 kW	14.0 kW	7.1 kW	10.0 kW	12.5 kW	14.0 kW
KIT-50PF1E5A*	KIT-60PF1E5A*	KIT-71PF1E5A*	KIT-100PF1E5A*	KIT-125PF1E5A*	KIT-140PF1E5A*	KIT-71PF1E8A*	KIT-100PF1E8A*	KIT-125PF1E8A*	KIT-140PF1E8A*
S-50PF1E5A	S-60PF1E5A	S-71PF1E5A	S-100PF1E5A	S-125PF1E5A	S-140PF1E5A	S-71PF1E8A	S-100PF1E8A	S-125PF1E8A	S-140PF1E8A
U-50PE1E5	U-60PE1E5A	U-71PE1E5A	U-100PE1E5A	U-125PE1E5A	U-140PE1E5A	U-71PE1E8A	U-100PE1E8A	U-125PE1E8A	U-140PE1E8A
CZ-RTC2 / CZ-RTC4	CZ-RTC2 / CZ-RTC4	CZ-RTC2 / CZ-RTC4	CZ-RTC2 / CZ-RTC4	CZ-RTC2 / CZ-RTC4	CZ-RTC2 / CZ-RTC4	CZ-RTC2 / CZ-RTC4	CZ-RTC2 / CZ-RTC4	CZ-RTC2 / CZ-RTC4	CZ-RTC2 / CZ-RTC4
5.0 (1.5 - 5.6)	6.0 (2.5 - 7.1)	7.1 (2.5 - 8.0)	10.0 (3.3 - 12.5)	12.5 (3.3 - 14.0)	14.0 (3.3 - 15.5)	7.1 (3.2 - 8.0)	10.0 (3.3 - 12.5)	12.5 (3.3 - 14.0)	14.0 (3.3 - 15.5)
3.77 (5.58 - 2.80) A	3.90 (4.72 - 3.55) A	3.84 (4.72 - 3.02) A	4.10 (3.93 - 3.38) A	3.50 (3.93 - 3.04) A	3.25 (3.93 - 2.58) A	3.84 (5.0 - 3.02) A	4.10 (3.93 - 3.38) A	3.50 (3.93 - 3.04) A	3.25 (3.93 - 2.58) A
5.7 A*	6.4 A**	6.4 A**	5.8 A*	—	—	6.0 A	5.7 A*	—	—
5.0	6.0	7.1	10.0	—	—	7.1	10.0	—	—
1.350 (0.260 - 2.000)	1.540 (0.530 - 2.000)	1.850 (0.530 - 2.650)	2.440 (0.840 - 3.700)	3.570 (0.840 - 4.600)	4.310 (0.840 - 6.000)	1.850 (0.640 - 2.650)	2.440 (0.840 - 3.700)	3.570 (0.840 - 4.600)	4.310 (0.840 - 6.000)
307	328	388	603	—	—	414	614	—	—
5.6 (1.5 - 6.5)	7.0 (2.0 - 8.0)	8.0 (2.0 - 9.0)	11.2 (4.1 - 14.0)	14.0 (4.1 - 16.0)	16.0 (4.1 - 18.0)	8.0 (2.8 - 9.0)	11.2 (4.1 - 14.0)	14.0 (4.1 - 16.0)	16.0 (4.1 - 18.0)
4.20	6.69	7.52	12.04	13.48	14.24	7.52	12.04	13.48	14.24
3.58	6.56	7.65	11.20	12.38	12.69	7.65	11.20	12.38	12.69
3.73 (6.82 - 2.71) A	3.87 (4.17 - 3.23) A	3.85 (4.17 - 3.10) A	4.31 (4.56 - 3.18) A	4.02 (4.56 - 3.08) A	3.60 (4.56 - 3.05) A	3.85 (4.83 - 3.10) A	4.31 (4.56 - 3.18) A	4.02 (4.56 - 3.08) A	3.60 (4.56 - 3.05) A
3.8 A	3.9 A	4.0 A*	3.8 A	—	—	3.9 A	3.8 A	—	—
4.0	6.0	7.1	10.0	—	—	7.1	10.0	—	—
1.500 (0.220 - 2.400)	1.810 (0.480 - 2.480)	2.080 (0.480 - 2.900)	2.600 (0.900 - 4.400)	3.480 (0.900 - 5.200)	4.440 (0.900 - 5.900)	2.080 (0.580 - 2.900)	2.600 (0.900 - 4.400)	3.480 (0.900 - 5.200)	4.440 (0.900 - 5.900)
1,474	2,154	2,485	3,684	—	—	2,548	3,684	—	—
70 (10 - 150)	70 (10 - 150)	70 (10 - 150)	100 (10 - 150)	100 (10 - 150)	100 (10 - 150)	70 (10 - 150)	100 (10 - 150)	100 (10 - 150)	100 (10 - 150)
960 / 900 / 720	1,260 / 1,140 / 900	1,260 / 1,140 / 900	1,920 / 1,560 / 1,260	2,040 / 1,740 / 1,380	2,160 / 1,920 / 1,500	1,260 / 1,140 / 900	1,920 / 1,560 / 1,260	2,040 / 1,740 / 1,380	2,160 / 1,920 / 1,500
2.8	3.4	4.2	6.0	7.9	9.0	4.2	6.0	7.9	9.0
34 / 30 / 26	35 / 32 / 26	35 / 32 / 26	38 / 34 / 31	39 / 35 / 32	40 / 36 / 33	35 / 32 / 26	38 / 34 / 31	39 / 35 / 32	40 / 36 / 33
34 / 30 / 26	35 / 32 / 26	35 / 32 / 26	38 / 34 / 31	39 / 35 / 32	40 / 36 / 33	35 / 32 / 26	38 / 34 / 31	39 / 35 / 32	40 / 36 / 33
56 / 52 / 48	57 / 54 / 48	57 / 54 / 48	60 / 56 / 53	61 / 57 / 54	62 / 58 / 55	57 / 54 / 48	60 / 56 / 53	61 / 57 / 54	62 / 58 / 55
56 / 52 / 48	57 / 54 / 48	57 / 54 / 48	60 / 56 / 53	61 / 57 / 54	62 / 58 / 55	57 / 54 / 48	60 / 56 / 53	61 / 57 / 54	62 / 58 / 55
290 x 800 x 700	290 x 1,000 x 700	290 x 1,000 x 700	290 x 1,400 x 700	290 x 1,400 x 700	290 x 1,400 x 700	290 x 1,000 x 700	290 x 1,400 x 700	290 x 1,400 x 700	290 x 1,400 x 700
28	33	33	45	45	45	33	45	45	45
220 / 230 / 240	220 / 230 / 240	220 / 230 / 240	220 / 230 / 240	220 / 230 / 240	220 / 230 / 240	380 / 400 / 415	380 / 400 / 415	380 / 400 / 415	380 / 400 / 415
16	20	20	25	30	30	16	16	16	16
2.5	2.5	2.5	4	6	6	2.5	2.5	2.5	2.5
6.10 / 5.85 / 5.60	7.70 / 7.40 / 7.10	8.90 / 8.60 / 8.30	11.0 / 10.6 / 10.3	16.6 / 15.9 / 15.3	20.1 / 19.3 / 18.6	2.75 / 2.65 / 2.60	3.68 / 3.53 / 3.43	5.52 / 5.29 / 5.12	6.69 / 6.42 / 6.18
6.85 / 6.55 / 6.25	8.70 / 8.40 / 8.10	9.90 / 9.50 / 9.20	11.6 / 11.2 / 10.7	16.3 / 15.8 / 15.1	19.9 / 19.1 / 18.4	3.10 / 3.00 / 2.90	3.86 / 3.70 / 3.58	5.44 / 5.26 / 5.05	6.64 / 6.35 / 6.15
1,800 / 2,100	3,600 / 3,600	3,600 / 3,600	6,600 / 5,700	7,800 / 6,600	8,100 / 7,200	3,600 / 3,600	6,600 / 5,700	7,800 / 6,600	8,100 / 7,200
46 / 50	48 / 50	48 / 50	52 / 52	53 / 53	54 / 55	48 / 50	52 / 52	53 / 53	54 / 55
65 / 69	65 / 67	65 / 67	69 / 69	70 / 70	71 / 71	65 / 67	69 / 69	70 / 70	71 / 71
569 x 790 x 285	996 x 940 x 340	996 x 940 x 340	1,416 x 940 x 340	1,416 x 940 x 340	1,416 x 940 x 340	996 x 940 x 340	1,416 x 940 x 340	1,416 x 940 x 340	1,416 x 940 x 340
42	68	69	98	98	98	71	98	98	98
1/4 (6.35)	3/8 (9.52)	3/8 (9.52)	3/8 (9.52)	3/8 (9.52)	3/8 (9.52)	3/8 (9.52)	3/8 (9.52)	3/8 (9.52)	3/8 (9.52)
1/2 (12.7)	5/8 (15.88)	5/8 (15.88)	5/8 (15.88)	5/8 (15.88)	5/8 (15.88)	5/8 (15.88)	5/8 (15.88)	5/8 (15.88)	5/8 (15.88)
1.65	2	2.35	3.4	3.4	3.4	2.35	3.4	3.4	3.4
30	30	30	30	30	30	30	30	30	30
5 / 40	5 / 50	5 / 50	5 / 75	5 / 75	5 / 75	5 / 50	5 / 75	5 / 75	5 / 75
30	30	30	30	30	30	30	30	30	30
20	50	50	50	50	50	50	50	50	50
-15 / +46	-15 / +46	-15 / +46	-15 / +46	-15 / +46	-15 / +46	-15 / +46	-15 / +46	-15 / +46	-15 / +46
-20 / +24	-20 / +24	-20 / +24	-20 / +24	-20 / +24	-20 / +24	-20 / +24	-20 / +24	-20 / +24	-20 / +24

indoor unit including defrost correction factor. 6) Medium External static pressure setting from factory. 7) The Sound pressure level of the units shows the value measured of a position 1 meter in front of the main body and 1.5 m from the ground. The sound pressure is measured in accordance with Eurovent 6/C/006-97 specification. 8) When installing the outdoor unit at a higher position than the indoor unit. // Recommended fuse for the indoor 3A. // * Available from May 2014. For detailed information about ErP, please visit our websites www.aircon.panasonic.co.uk or www.ptc.panasonic.eu

ELITE

- Internet Control Ready**
- Energy saving**
- 6,40 A++ SEER**
- 4,00 A+ SCOP***
- Down to -15°C in cooling mode**
- Down to -20°C in heating mode**
- Easy control by BMS**
- Possible to use on R22 pipings**
- 5 year compressor warranty**

INTERNET CONTROL READY: Optional. SEER and SCOP: For KIT-71PF1E5A. 5 YEARS COMPRESSOR WARRANTY: Only for PRO partners.



U-50PE1E5
U-60PE1E5A
U-71PE1E8A
U-100PE1E5A
U-125PE1E5A
U-140PE1E5A
U-100PE1E8A
U-125PE1E8A
U-140PE1E8A

CEILING PACi STANDARD AND ELITE INVERTER+

This range of ceiling mounted units feature a DC fan motor for increased efficiency and reduced operating sound levels. All the units are the same height and depth for a uniform appearance in mixed installations. A knock out is provided to allow for supplementary fresh air for improved air quality.

Technical Focus

- Fresh air connection possible (Outside intake duct connection port of 100mm diameter is available on the unit)
- All units just 235 mm high
- Twin rotary compressor dramatically reduces vibration and noise during operation
- DC inverter control
- Large and wide air distribution
- Industry-leading low sound levels
- Twin, Triple and Double-twin split options
- Easy connection and control of external fan or ERV using the connector PAW-FDC on the indoor unit PCB. The external device can be control by the remote control of the Panasonic indoor unit

STANDARD

		Single Phase				Three Phase			
		6.0 kW	7.1 kW	10.0 kW	12.5 kW	10.0 kW	12.5 kW	14.0 kW	
KIT		KIT-60PTY2E5A*	KIT-71PTY2E5A*	KIT-100PTY2E5A*	KIT-125PTY2E5A*	KIT-100PTY2E8A*	KIT-125PTY2E8A*	KIP-140PTY2E8A*	
Indoor		S-60PT2E5A	S-71PT2E5A	S-100PT2E5A	S-125PT2E5A	S-100PT2E5A	S-125PT2E5A	S-140PT2E5A	
Outdoor		U-60PEY1E5	U-71PEY1E5	U-100PEY1E5	U-125PEY1E5	U-100PEY1E8	U-125PEY1E8	U-140PEY1E8	
Timer remote controller		CZ-RTC2 / CZ-RTC4	CZ-RTC2 / CZ-RTC4	CZ-RTC2 / CZ-RTC4	CZ-RTC2 / CZ-RTC4	CZ-RTC2 / CZ-RTC4	CZ-RTC2 / CZ-RTC4	CZ-RTC2 / CZ-RTC4	
Cooling capacity	Nominal (Min - Max)	kW	6.0 (2.0 - 7.0)	7.1 (2.2 - 7.7)	10.0 (2.7 - 11.5)	12.5 (3.8 - 13.5)	10.0 (2.7 - 11.5)	12.5 (3.8 - 13.5)	14.0 (3.3 - 15.0)
EER ¹⁾	Nominal (Min - Max)	W/W	3.61 (6.15 - 2.80) A	3.21 (6.15 - 2.73) A	3.01(5.09 - 2.65) B	3.01 (4.22 - 2.62) B	3.01 (5.09 - 2.65) B	3.01 (4.22 - 2.62) B	2.98 (3.93 - 2.63) C
SEER ²⁾	Nominal (Min - Max)	W/W	6.7 ◀A++	6.1 ◀A++	6.1 ◀A++	—	6.0 ◀A+	—	—
Pdesign		kW	6.0	7.1	10.0	—	10.0	—	—
Power input cooling	Nominal (Min - Max)	kW	1.660 (0.325 - 2.500)	2.210 (0.325 - 2.820)	3.320 (0.530 - 4.340)	4.150 (0.900 - 5.160)	3.320 (0.530 - 4.340)	4.150 (0.900 - 5.160)	4.700 (0.840 - 5.700)
Annual energy consumption (ErP) ³⁾		kWh/a	314	408	574	—	584	—	—
Heating capacity	Nominal (Min - Max)	kW	6.0 (1.8 - 7.0)	7.1 (1.8 - 8.1)	10.0 (2.1 - 13.8)	12.5 (3.4 - 15.0)	10.0 (2.1 - 13.8)	12.5 (3.4 - 15.0)	14.0 (4.1 - 16.0)
Heating capacity at -7°C ⁴⁾	Nominal	kW	4.99	5.08	9.97	10.97	10.97	13.35	13.35
Heating capacity at -15°C ⁴⁾	Nominal	kW	4.20	4.37	8.43	9.03	8.43	12.38	12.38
COP ¹⁾	Nominal (Min - Max)	W/W	4.20 A (6.55 - 3.25)	3.90 (6.55 - 3.23) A	3.85 (5.12 - 3.45) A	3.85 (4.66 - 3.41) A	3.85 (5.12 - 3.45) A	3.85 (4.66 - 3.41) A	3.88 (4.56 - 3.07) A
SCOP ⁵⁾	Nominal (Min - Max)	W/W	4.0 ◀A+	4.0 ◀A+	3.9 ◀A	3.40 ⁴⁾	3.9 ◀A	3.40 ⁴⁾	3.52 ⁴⁾
Pdesign at -10°C		kW	6.0	6.0	10.0	—	10.0	—	—
Power input heating	Nominal (Min - Max)	kW	1.430 (0.275 - 2.155)	1.820 (0.275 - 2.510)	2.600 (0.410 - 4.000)	3.250 (0.730 - 4.400)	2.600 (0.410 - 4.000)	3.250 (0.730 - 4.400)	3.610 (0.900 - 5.210)
Annual energy consumption (ErP) ³⁾		kWh/a	2,100	2,100	3,590	—	3,590	—	—
Indoor unit									
Air volume	Cooling (Hi / Med / Lo)	m³/h	1,200 / 1,020 / 870	1,260 / 1,080 / 930	1,800 / 1,500 / 1,380	2,040 / 1,680 / 1,440	1,800 / 1,500 / 1,380	2,040 / 1,680 / 1,440	2,100 / 1,740 / 1,500
	Heating (Hi / Med / Lo)		1,200 / 1,020 / 870	1,260 / 1,080 / 930	1,800 / 1,500 / 1,380	2,040 / 1,680 / 1,440	1,800 / 1,500 / 1,380	2,040 / 1,680 / 1,440	2,100 / 1,740 / 1,500
Moisture removal volume		l/h	3.4	4.2	6.0	7.9	6.0	7.9	9.0
Sound pressure level ⁴⁾	Cooling (Hi / Med / Lo)	dB(A)	38 / 34 / 30	39 / 35 / 31	42 / 37 / 35	46 / 40 / 36	42 / 37 / 35	46 / 40 / 36	47 / 41 / 37
	Heating (Hi / Med / Lo)	dB(A)	38 / 34 / 30	39 / 35 / 31	42 / 37 / 35	46 / 40 / 36	42 / 37 / 35	46 / 40 / 36	47 / 41 / 37
Sound power level	Cooling (Hi / Med / Lo)	dB	56 / 52 / 48	57 / 53 / 49	60 / 55 / 53	64 / 58 / 54	60 / 55 / 53	64 / 58 / 54	65 / 59 / 55
	Heating (Hi / Med / Lo)	dB	56 / 52 / 48	57 / 53 / 49	60 / 55 / 53	64 / 58 / 54	60 / 55 / 53	64 / 58 / 54	65 / 59 / 55
Dimensions	H x W x D	mm	235 x 1,275 x 690	235 x 1,275 x 690	235 x 1,590 x 690	235 x 1,590 x 690	235 x 1,590 x 690	235 x 1,590 x 690	235 x 1,590 x 690
Net weight		kg	33	33	40	40	40	40	40
Outdoor unit									
Power source		V	220 / 230 / 240	220 / 230 / 240	220 / 230 / 240	220 / 230 / 240	380 / 400 / 415	380 / 400 / 415	380 / 400 / 415
Recommended fuse		A	20	20	25	30	16	16	16
Connection		mm²	2.5	2.5	4	6	2.5	2.5	2.5
Current	Cooling	A	8.05 / 7.70 / 7.40	10.8 / 10.3 / 9.85	15.6 / 15.0 / 14.4	19.7 / 18.9 / 18.1	5.30 / 5.05 / 4.85	6.50 / 6.20 / 6.00	7.40 / 7.00 / 6.80
	Heating	A	6.90 / 6.60 / 6.30	8.75 / 8.35 / 8.00	11.9 / 11.5 / 11.1	15.2 / 14.6 / 13.9	4.10 / 3.90 / 3.75	5.10 / 4.80 / 4.65	5.65 / 5.35 / 5.15
Air volume	Cooling / Heating	m³/h	1,800 / 2,100	2,340 / 2,340	4,560 / 4,020	4,800 / 4,380	4,560 / 4,020	4,800 / 4,380	8,100 / 7,200
Sound pressure level	Cooling / Heating (Hi)	dB(A)	46 / 50	50 / 52	54 / 54	56 / 56	54 / 54	56 / 56	54 / 53
Sound power level	Cooling / Heating (Hi)	dB	65 / 69	70 / 70	73 / 73	73 / 73	70 / 70	73 / 73	71 / 70
Dimensions	H x W x D	mm	569 x 790 x 285	569 x 790 x 285	996 x 940 x 340	996 x 940 x 340	996 x 940 x 340	996 x 940 x 340	1,416 x 940 x 340
Net weight		kg	42	42	73	85	73	85	98
Piping connections	Liquid pipe	Inch (mm)	3/8 (9.52)	3/8 (9.52)	3/8 (9.52)	3/8 (9.52)	3/8 (9.52)	3/8 (9.52)	3/8 (9.52)
	Gas pipe	Inch (mm)	5/8 (15.88)	5/8 (15.88)	5/8 (15.88)	5/8 (15.88)	5/8 (15.88)	5/8 (15.88)	5/8 (15.88)
Refrigerant loading	R410A	kg	1.70	1.70	2.60	3.20	2.60	3.20	3.40
Elevation difference (in/out) ⁷⁾	Max	m	30	30	30	30	30	30	30
Piping length	Min / Max	m	5 / 50	5 / 50	5 / 50	5 / 50	5 / 50	5 / 50	5 / 50
Precharge length	Max	m	20	20	30	30	30	30	30
Additional charge		g/m	40	40	50	50	50	50	50
Operating range	Cooling Min / Max	°C	-10 / +43	-10 / +43	-10 / +43	-10 / +43	-10 / +43	-10 / +43	-10 / +43
	Heating Min / Max	°C	-15 / +24	-15 / +24	-15 / +24	-15 / +24	-15 / +24	-15 / +24	-15 / +24

Rating Conditions: Cooling Indoor 27°C DB / 19°C WB. Cooling Outdoor 35°C DB / 24°C WB. Heating Indoor 20°C DB. Heating Outdoor 7°C DB / 6°C WB. (DB: Dry Bulb; WB: Wet Bulb). // Specifications subject to change without notice.
 1) EER and COP, Energy Saving Classification, is at 220 / 240 V (380 / 415 V) only in accordance with EU directive 2002/31/EC. 2) SEER is calculated in base Eurovent IPLV for SBEM for U1 indoor unit SEER=a(EER25)+b(EER50)+c(EER75)+d(EER100) where EER25, EER50, EER75 and EER100 are the EER measured value at 25%, 50%, 75% and 100% part load for temperatures 20, 25, 30 and 35°C DB, respectively. a, b, c and d are values assigned for an office type. These values are given as a=0.2, b=0.36, c=0.32 and d=0.03. The internal temperatures are taken at 27°C DB and 19°C WB. 3) The annual consumption(ErP) is calculated by formula determined by ErP regulation. 4) Heating capacity is calculated including defrost factor correction. 5) SCOP is calculated in base Eurovent IPLV for SBEM with U1

STANDARD

Internet
Control
Ready

Energy
saving

6,10 A++
SEER

3,90 A
SCOP

Down to
-10°C in
cooling mode

Down to
-15°C in
heating mode

Easy
control
by BMS

Possible
to use on
R22 pipings

5 year
compressor
warranty



INTERNET CONTROL READY: Optional. SEER and SCOP: For KIT-100PTY2E5A. 5 YEARS COMPRESSOR WARRANTY: Only for PRO partners.

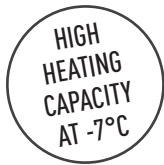

- Optional Controller**
Timer remote controller
CZ-RTC2
- Optional Controller**
Wired remote controller
CZ-RTC3 / CZ-RTC5
- Optional Controller**
Timer remote controller
CZ-RTC4
- Optional Controller**
Wireless remote controller
CZ-RWSK2
- Optional Controller**
Simplified remote controller
CZ-RE2C2

Compatible with all Panasonic connectivity solutions. For detailed information go to the Control Systems section.



ELITE

Single Phase					Three Phase				
5.0 kW	6.0 kW	7.1 kW	10.0 kW	12.5 kW	14.0 kW	7.1 kW	10.0 kW	12.5 kW	14.0 kW
KIT-50PT2E5A*	KIT-60PT2E5A*	KIT-71PT2E5A*	KIT-100PT2E5A*	KIT-125PT2E5A*	KIT-140PT2E5A*	KIT-71PT2E8A*	KIT-100PT2E8A*	KIT-125PT2E8A*	KIT-140PT2E8A*
S-50PT2E5A	S-60PT2E5A	S-71PT2E5A	S-100PT2E5A	S-125PT2E5A	S-140PT2E5A	S-71PT2E5A	S-100PT2E5A	S-125PT2E5A	S-140PT2E5A
U-50PE1E5	U-60PE1E5A	U-71PE1E5A	U-100PE1E5A	U-125PE1E5A	U-140PE1E5A	U-71PE1E8A	U-100PE1E8A	U-125PE1E8A	U-140PE1E8A
CZ-RTC2 / CZ-RTC4	CZ-RTC2 / CZ-RTC4	CZ-RTC2 / CZ-RTC4	CZ-RTC2 / CZ-RTC4	CZ-RTC2 / CZ-RTC4	CZ-RTC2 / CZ-RTC4	CZ-RTC2 / CZ-RTC4	CZ-RTC2 / CZ-RTC4	CZ-RTC2 / CZ-RTC4	CZ-RTC2 / CZ-RTC4
5.0 (1.5 - 5.6)	6.0 (2.5 - 7.1)	7.1 (2.5 - 8.0)	10.0 (3.3 - 12.5)	12.5 (3.3 - 14.0)	14.0 (3.3 - 15.0)	7.1 (2.5 - 8.0)	10.0 (3.3 - 12.5)	12.5 (3.3 - 14.0)	14.0 (3.3 - 15.0)
3.62 (5.77 - 2.73) A	4.03 (5.56 - 3.53) A	3.68 (5.56 - 2.88) A	3.95 (3.93 - 3.25) A	3.35 (3.93 - 2.88) A	3.01 (3.93 - 2.65) B	3.68 (5.56 - 2.88) A	3.95 (3.93 - 3.25) A	3.35 (3.93 - 2.88) A	3.01 (3.93 - 2.65) B
6.4 A++	6.8 A++	6.2 A++	6.7 A++	—	—	5.9 A+	6.6 A++	—	—
5.0	6.0	7.1	10.0	—	—	7.1	10.0	—	—
1.380 (0.260 - 2.050)	1.490 (0.450 - 2.010)	1.930 (0.450 - 2.780)	2.530 (0.840 - 3.850)	3.730 (0.840 - 4.860)	4.650 (0.840 - 5.650)	1.930 (0.450 - 2.780)	2.530 (0.840 - 3.850)	3.730 (0.840 - 4.860)	4.650 (0.840 - 5.650)
273	309	965	523	—	—	421	531	—	—
5.6 (1.5 - 6.5)	7.0 (2.0 - 8.0)	8.0 (2.0 - 9.0)	11.2 (4.1 - 14.0)	14.0 (4.1 - 16.0)	16.0 (4.1 - 18.0)	8.0 (2.0 - 9.0)	11.2 (4.1 - 14.0)	14.0 (4.1 - 16.0)	16.0 (4.1 - 18.0)
4.20	6.69	7.52	12.04	13.48	14.24	7.52	12.04	13.48	14.24
3.58	6.56	7.65	11.20	12.38	12.69	7.65	11.20	12.38	12.69
3.97 (6.82 - 2.83) A	4.02 (5.00 - 3.23) A	4.15 (5.00 - 3.10) A	4.31 (4.56 - 3.18) A	3.99 (4.56 - 3.07) A	3.67 (4.56 - 3.04) A	4.15 (5.00 - 3.10) A	4.31 (4.56 - 3.18) A	3.99 (4.56 - 3.07) A	3.67 (4.56 - 3.04) A
4.0 A	4.1 A+	4.0 A+	4.3 A+	3.63 ⁴⁾	3.41 ⁴⁾	4.0 A+	4.3 A+	3.63 ⁴⁾	3.41 ⁴⁾
4.0	6.0	7.1	10.0	—	—	7.1	10.0	—	—
1.410 (0.220 - 2.300)	1.740 (0.400 - 2.480)	1.930 (0.400 - 2.900)	2.600 (0.900 - 4.400)	3.510 (0.900 - 5.210)	4.360 (0.900 - 5.930)	1.930 (0.400 - 2.900)	2.600 (0.900 - 4.400)	3.510 (0.900 - 5.210)	4.360 (0.900 - 5.930)
1,400	2,049	2,485	3,256	—	—	2,485	3,256	—	—
900 / 750 / 630	1,200 / 1,020 / 870	1,260 / 1,080 / 930	1,800 / 1,500 / 1,380	2,040 / 1,680 / 1,440	2,100 / 1,740 / 1,500	1,260 / 1,080 / 930	1,800 / 1,500 / 1,380	2,040 / 1,680 / 1,440	2,100 / 1,740 / 1,500
2.8	3.4	4.2	6.0	7.9	9.0	4.2	6.0	7.9	9.0
37 / 33 / 29	38 / 34 / 30	39 / 35 / 31	42 / 37 / 35	46 / 40 / 36	47 / 41 / 37	39 / 35 / 31	42 / 37 / 35	46 / 40 / 36	47 / 41 / 37
37 / 33 / 29	38 / 34 / 30	39 / 35 / 31	42 / 37 / 35	46 / 40 / 36	47 / 41 / 37	39 / 35 / 31	42 / 37 / 35	46 / 40 / 36	47 / 41 / 37
55 / 51 / 47	56 / 52 / 48	57 / 53 / 49	60 / 55 / 53	64 / 58 / 54	65 / 59 / 55	57 / 53 / 49	60 / 55 / 53	64 / 58 / 54	65 / 59 / 55
55 / 51 / 47	56 / 52 / 48	57 / 53 / 49	60 / 55 / 53	64 / 58 / 54	65 / 59 / 55	57 / 53 / 49	60 / 55 / 53	64 / 58 / 54	65 / 59 / 55
235 x 960 x 690	235 x 1,275 x 690	235 x 1,275 x 690	235 x 1,590 x 690	235 x 1,590 x 690	235 x 1,590 x 690	235 x 1,275 x 690	235 x 1,590 x 690	235 x 1,590 x 690	235 x 1,590 x 690
27	33	33	40	40	40	33	40	40	40
220 / 230 / 240	220 / 230 / 240	220 / 230 / 240	220 / 230 / 240	220 / 230 / 240	220 / 230 / 240	380 / 400 / 415	380 / 400 / 415	380 / 400 / 415	380 / 400 / 415
16	20	20	25	30	30	16	16	16	16
2.5	2.5	2.5	4	6	6	2.5	2.5	2.5	2.5
6.55 / 6.25 / 6.00	7.15 / 6.90 / 6.70	9.00 / 8.70 / 8.40	11.5 / 11.1 / 10.6	17.0 / 16.4 / 15.8	21.2 / 20.5 / 19.8	3.00 / 2.90 / 2.80	3.95 / 3.75 / 3.65	5.85 / 5.55 / 5.35	7.30 / 6.95 / 6.70
6.70 / 6.40 / 6.15	8.10 / 7.80 / 7.60	8.90 / 8.60 / 8.30	11.8 / 11.4 / 11.0	16.0 / 15.4 / 14.9	19.8 / 19.2 / 18.5	3.00 / 2.90 / 2.80	4.05 / 3.85 / 3.75	5.50 / 5.20 / 5.05	6.85 / 6.50 / 6.25
1,800 / 2,100	3,600 / 3,600	3,600 / 3,600	6,600 / 5,700	7,800 / 6,600	8,100 / 7,200	3,600 / 3,600	6,600 / 5,700	7,800 / 6,600	8,100 / 7,200
46 / 50	48 / 50	48 / 50	52 / 52	53 / 53	54 / 55	48 / 50	52 / 52	53 / 53	54 / 55
65 / 69	65 / 67	65 / 67	69 / 69	70 / 70	71 / 71	65 / 67	69 / 69	70 / 70	71 / 71
569 x 790 x 285	996 x 940 x 340	996 x 940 x 340	1,416 x 940 x 340	1,416 x 940 x 340	1,416 x 940 x 340	996 x 940 x 340	1,416 x 940 x 340	1,416 x 940 x 340	1,416 x 940 x 340
42	68	69	98	98	98	71	98	98	98
1/4 (6.35)	3/8 (9.52)	3/8 (9.52)	3/8 (9.52)	3/8 (9.52)	3/8 (9.52)	3/8 (9.52)	3/8 (9.52)	3/8 (9.52)	3/8 (9.52)
1/2 (12.7)	5/8 (15.88)	5/8 (15.88)	5/8 (15.88)	5/8 (15.88)	5/8 (15.88)	5/8 (15.88)	5/8 (15.88)	5/8 (15.88)	5/8 (15.88)
1.65	2.00	2.35	3.40	3.40	3.40	2.35	3.40	3.40	3.40
30	30	30	30	30	30	30	30	30	30
5 / 40	5 / 50	5 / 50	5 / 75	5 / 75	5 / 75	5 / 50	5 / 75	5 / 75	5 / 75
30	30	30	30	30	30	30	30	30	30
20	50	50	50	50	50	50	50	50	50
-15 / +46	-15 / +46	-15 / +46	-15 / +46	-15 / +46	-15 / +46	-15 / +46	-15 / +46	-15 / +46	-15 / +46
-20 / +24	-20 / +24	-20 / +24	-20 / +24	-20 / +24	-20 / +24	-20 / +24	-20 / +24	-20 / +24	-20 / +24

indoor unit including defrost correction factor. 4) The Sound pressure level of the units shows the value measured of a position 1 meter in front of the main body and 1.5 m from the ground. The sound pressure is measured in accordance with Eurovent 6/C/006-97 specification. 7) When installing the outdoor unit at a higher position than the indoor unit. // Recommended fuse for the indoor 3A. // * Available from May 2014. For detailed information about ErP, please visit our websites www.aircon.panasonic.co.uk or www.ptc.panasonic.eu

ELITE

- Internet Control Ready** (INTERNET CONTROL)
- Energy saving** (INVERTER+)
- 6,80 A++ SEER** (SEASONAL ENERGY EFFICIENCY RATIO)
- 4,10 A+ SCOP** (SEASONAL COEFFICIENT OF PERFORMANCE)
- Down to -15°C in cooling mode** (OUTDOOR TEMPERATURE)
- Down to -20°C in heating mode** (OUTDOOR TEMPERATURE)
- Easy control by BMS** (CONNECTIVITY)
- Possible to use on R22 pipings** (R22 RENEWAL)
- 5 year compressor warranty**



INTERNET CONTROL READY: Optional. SEER and SCOP: For KIT-60PT2E5A. 5 YEARS COMPRESSOR WARRANTY: Only for PRO partners.

HIGH STATIC PRESSURE HIDE AWAY 20-25kW BIG PACi INVERTER+

Panasonic breaks new ground in offering high performance and power in a small space. The 20-25 kW from Panasonic is ideally suited for large retail applications and other large areas not needing the higher capacities of VRF systems. The lightweight and compact design enables easier installation in any commercial space. The twin fan system saves valuable footprint compared to traditional 20-25kW systems which are larger and therefore require more space.



INTERNET CONTROL READY: Optional. 5 YEARS COMPRESSOR WARRANTY: Only for PRO partners.

			Three Phase	
			20.0 kW	25.0 kW
KIT			KIT-200PE2E5	KIT-250PE2E5
Indoor			S-200PE2E5	S-250PE2E5
Outdoor			U-200PE1E8	U-250PE1E8
Timer remote controller			CZ-RTC2 / CZ-RTC4	CZ-RTC2 / CZ-RTC4
Cooling capacity	Nominal (Min - Max)	kW	19.5 (6.0 - 22.4)	25.0 (6.0 - 22.4)
EER ¹⁾	Nominal	W/W	3.04 B	3.04 B
SEER ²⁾		W/W		
Power input cooling	Nominal	kW	6.42	6.42
Running amperes		A	—	—
Heating capacity	Nominal (Min - Max)	kW	22.4 (6.0 - 25.0)	28.0 (6.0 - 25.0)
Heating capacity at -7°C ³⁾	Nominal	kW	17.34	21.85
Heating capacity at -15°C ³⁾	Nominal	kW	16.00	20.16
COP ¹⁾	Nominal	W/W	3.54 B	3.54 B
SCOP ⁴⁾		W/W		
Power input heating	Nominal	kW	6.32	6.32
Running amperes		A	—	—
Indoor unit				
Power source		V / ph / Hz	220 - 230 - 240 / 1 / 50	220 - 230 - 240 / 1 / 50
External static pressure at shipment (with booster cable)		Pa	60	72
Air volume	Hi / Med / Lo	m ³ /h	3,360 / 3,060 / 2,640	4,320 / 3,780 / 3,180
Moisture removal volume	Cooling	l/h	—	—
Sound pressure level ⁵⁾	Hi / Med / Lo	dB(A)	43 / 41 / 38	47 / 45 / 42
Sound power level	Hi / Med / Lo	dB(A)	75 / 73 / 70	79 / 77 / 74
Dimensions	H x W x D	mm	479 x 1,453 x 1,205	479 x 1,453 x 1,205
Net weight		kg	100	104
Outdoor unit				
Power source		V / ph / Hz	380 / 400 / 415 / 3+N / 50	380 / 400 / 415 / 3+N / 50
Recommended fuse		A	15	20
Air volume	Cooling / Heating	m ³ /h	7,740	7,740
Sound pressure level ⁵⁾	Cooling / Heating (Hi)	dB(A)	57 / 57	57 / 58
Sound power level		dB	72	72
Dimensions ⁶⁾	H x W x D	mm	1,526 x 940 x 340	1,526 x 940 x 340
Net weight		kg	118	118
Piping connections	Liquid pipe	mm (Inch)	9.52 (3/8)	12.7 (1/2)
	Gas pipe	mm (Inch)	25.4 (1)	25.4 (1)
Refrigerant loading		kg	5.3	5.3
Elevation difference (in/out) ⁷⁾	Max	m	30 / 30	30 / 30
Piping length	Min - Max	m	5 - 100	5 - 100
Precharge length	Max	m	30	30
Additional charge		g/m	40	40
Operating range	Cooling Min / Max	°C	-15 / +46	-15 / +46
	Heating Min / Max	°C	-20 / +24	-20 / +24

Rating Conditions: Cooling Indoor 27°C DB / 19°C WB. Cooling Outdoor 35°C DB / 24°C WB. Heating Indoor 20°C DB. Heating Outdoor 7°C DB / 4°C WB. (DB: Dry Bulb; WB: Wet Bulb)

1) EER and COP, Energy Saving Classification, is at 220 / 240 V (380 / 415 V) only in accordance with EU directive 2002/31/EC. 2) SEER is calculated in base Eurovent IPLV for SBEM for U1 indoor unit SEER=a(EER25)+b(EER50)+c(EER75)+d(EER100) where EER25, EER50, EER75 and EER100 are the EER measured value at 25%, 50%, 75% and 100% part load for temperatures 20, 25, 30 and 35°C DB, respectively. a, b, c and d are values assigned for an office type. These values are given as a=0.2, b=0.36, c=0.32 and d=0.03. The internal temperatures are taken at 27°C DB and 19°C WB. 3) Heating capacity is calculated including defrost factor correction. 4) SCOP is calculated in base Eurovent IPLV for SBEM with U1 indoor unit including defrost correction factor. 5) The sound pressure Level of the units shows the value measured of a position 1 meter in front of the main body and 1.5 m from the ground. The sound pressure is measured in accordance with Eurovent 6/C/006-97 specification. 6) Add 100 mm for indoor unit or 70 mm for outdoor unit for piping port. 7) When installing the outdoor unit at a higher position than the indoor unit.

Specifications subject to change without notice.

For detailed information about ErP, please visit our websites www.aircon.panasonic.co.uk or www.ptc.panasonic.eu

HIGH HEATING CAPACITY AT -7°C

NEW



Optional Controller
Timer remote controller
CZ-RTC2



Optional Controller
Wired remote controller
CZ-RTC3 / CZ-RTC5



Optional Controller
Timer remote controller
CZ-RTC4



Optional Controller
Wireless remote controller
CZ-RWSK2 + CZ-RWSC3



Optional Controller
Simplified remote controller
CZ-RE2C2

Compatible with all Panasonic connectivity solutions. For detailed information go to the Control Systems section.

Technical Focus

- High efficiency inverter system
- Cooling with low outdoor temperatures (down to -15°C)
- Maximum pipe length 100 m (more than 40% longer than other split systems)
- Multifunctional wireless remote control with built-in temperature control
- Fresh air supply for improved air quality

Features

ENERGY EFFICIENCY AND ECOLOGY

- Maximum efficiency Inverter system
- R410A environmentally friendly refrigerant gas

COMFORT

- Cooling with low outdoor temperatures (down to -15°C)
- Heating with low outdoor temperatures (down to -20°C)
- Selection of temperature sensor at indoor unit or wired remote control

EASY OF USE

- Weekly On/Off timer (6 settings per day and 42 per week)
- Selection of wired / Wireless and simplified wired remote controller

EASY INSTALLATION AND MAINTENANCE

- High static pressure units ideal for shops and offices

System example

An inspection port (450 x 450 mm or more) is required at the lower side of the indoor unit body. Distributor (field supply).

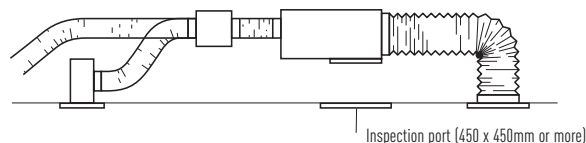

Plenums

Air Outlet Plenum (suitable for rigid + flexible duct)		
	N. of exits with diameters	Model
S-250PE1E8	1 x 500 mm	CZ-TREMIESPW706
S-200PE2E5 / S-250PE2E5	1 x 450 mm	CZ-TREMIESPW705



U-200PE1E8
U-250PE1E8



PACi Twin, Triple and Double-Twin System

With this system, a single outdoor unit can split capacity for up to 4 indoor areas simultaneously. This makes the system particularly apt for common areas. It reduces noise concentration and enables the same temperature to be reached around the room. A mix of indoor units can be installed (wall, cassette, duct, ceiling) in one system.

PACi Standard Single and Twin System from 10.0 to 12.5 kW

Up to 2 indoor units connectable on the same outdoor. Panasonic's PACi units can be installed as single and twin systems. The indoor units can be combined following the selection table. The operation will always be simultaneous. All the indoor units will work with the same settings.

PACi Elite Twin, Triple and Double-Twin System from 7.1 to 14.0 kW

Up to 4 indoor units can be connected to the same outdoor unit. Panasonic's PACi units 71, 100, 125 and 140 can be installed as twin, triple and double-twin systems. The indoor units can be combined as per the selection table. The operation will always be simultaneous. All the indoor units will work with the same settings.

Big PACi Elite Twin, Triple and Double-Twin System from 20.0 to 25.0 kW

Up to 4 indoor units can be connected to the same outdoor unit. Panasonic's PACi units 200 and 250 can be installed as twin, triple and double-twin systems. The indoor units can be combined as per the selection table. The operation will always be simultaneous. All the indoor units will work with the same settings.

Indoor unit capacities						
Capacity	Wall	4 Way 60x60 Cassette	4 Way 90x90 Cassette	Low Static Pressure Hide Away	High Static Pressure Hide Away	Ceiling
3.6 kW	S-36PK1E5A	S-36PY2E5A	S-36PU1E5A	S-36PN1E5A	S-36PF1E5A	S-36PT2E5A
4.5 kW	S-45PK1E5A	S-45PY2E5A	S-45PU1E5A	S-45PN1E5A	S-45PF1E5A	S-45PT2E5A
5.0 kW	S-50PK1E5A	S-50PY2E5A	S-50PU1E5A	S-50PN1E5A	S-50PF1E5A	S-50PT2E5A
6.0 kW	S-60PK1E5A		S-60PU1E5A	S-60PN1E5A	S-60PF1E5A	S-60PT2E5A
7.1 kW	S-71PK1E5A		S-71PU1E5A	S-71PN1E5A	S-71PF1E5A	S-71PT2E5A
10.0 kW	S-100PK1E5A		S-100PU1E5A	S-100PN1E5A	S-100PF1E5A	S-100PT2E5A
12.5 kW			S-125PU1E5A	S-125PN1E5A	S-125PF1E5A	S-125PT2E5A

Outdoor unit capacities			
Capacity	PACi Standard Single and Twin System	PACi Elite Twin, Triple and Double-Twin System from 7.1 to 14.0 kW	PACi Elite Twin, Triple and Double-Twin System from 20.0 to 25.0 kW
7.1 kW	U-71PEY1E5	U-71PE1E5A // U-71PE1E8A	
10.0 kW	U-100PEY1E5 // U-100PEY1E8		U-100PE1E5A // U-100PE1E8A
12.5 kW	U-125PEY1E5 // U-125PEY1E8		U-125PE1E5A // U-125PE1E8A
14.0 kW	U-140PEY1E8		U-140PE1E5A // U-140PE1E8A
20.0 kW			U-200PE1E8
25.0 kW			U-250PE1E8

U-__1E5 Single Phase // U-__1E8 Three Phase

PACi Standard Single/Simultaneous operation system combinations

kW	Outdoor			
	7.1	10.0	12.5	14.0
3.6	Twin U-71 S-36 S-36			
5.0		Twin U-100 S-50 S-50		
6.0			Twin U-125 S-60 S-60	
7.1	Single ¹ U-71 S-71			Twin U-140 S-71 S-71
10.0		Single ¹ U-100 S-100		
12.5			Single ¹ U-125 S-125	
14.0				Single ¹ U-140 S-140

PACi Elite from 20.0 to 25.0 kW Single/Simultaneous operation system combinations

kW	Outdoor	
	20.0	25.0
5.0	Double-Twin U-200 S-50 S-50 S-50 S-50	
6.0		Double-Twin U-250 S-60 S-60 S-60 S-60
7.1	Triple U-200 S-71 S-71 S-71	
10.0	Twin U-200 S-100 S-100	
12.5		Twin U-250 S-125 S-125
20.0	Single ¹ U-200 S-200	
25.0		Single ¹ U-250 S-250

1. PACi 1x1 Kit solution.

PACi Elite from 7.1 to 14.0 kW Single/Simultaneous operation system combinations

kW	Outdoor			
	7.1	10.0	12.5	14.0
3.6	Twin U-71 S-36 S-36	Triple U-100 S-36 S-36 S-36	Double-Twin U-125 S-36 S-36 S-36 S-36	
4.5			Triple U-125 S-45 S-45 S-45	
5.0		Twin U-100 S-50 S-50		Triple U-140 S-50 S-50 S-50
6.0			Twin U-125 S-60 S-60	
7.1	Single ¹ U-71 S-71			Twin U-140 S-71 S-71
10.0		Single ¹ U-100 S-100		
12.5			Single ¹ U-125 S-125	
14.0				Single ¹ U-140 S-140

1. PACi 1x1 Kit solution.

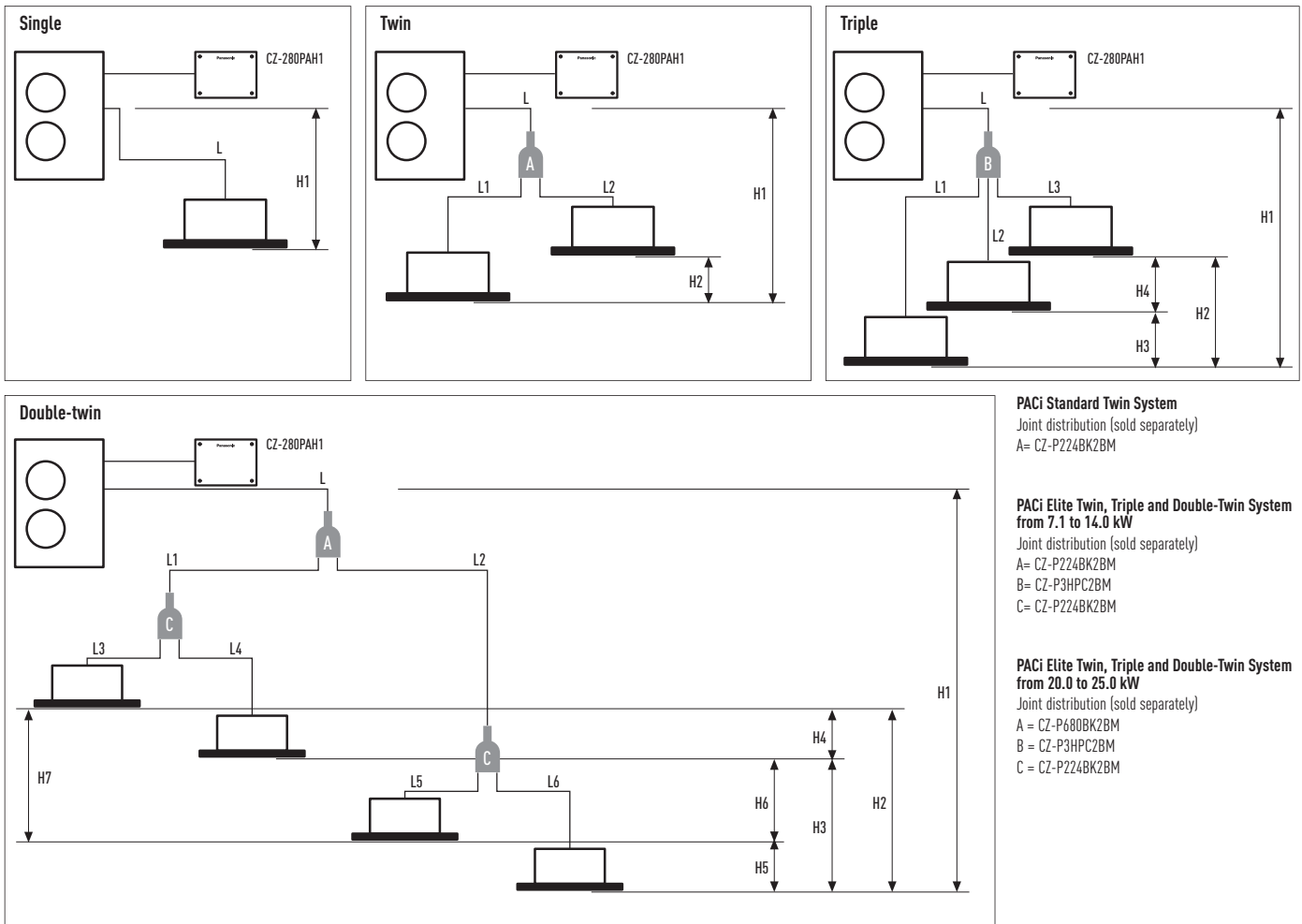

PACI Standard Twin System
Joint distribution (sold separately)
A= CZ-P224BK2BM

PACI Elite Twin, Triple and Double-Twin System from 7.1 to 14.0 kW
Joint distribution (sold separately)
A= CZ-P224BK2BM
B= CZ-P3HPC2BM
C= CZ-P224BK2BM

PACI Elite Twin, Triple and Double-Twin System from 20.0 to 25.0 kW
Joint distribution (sold separately)
A= CZ-P680BK2BM
B= CZ-P3HPC2BM
C= CZ-P224BK2BM

Twin System	PACI Standard Single and Twin System			PACI Elite Twin, Triple and Double-Twin System from 7.1 to 25 kW					
	Indoor unit combinations (see examples above)		Equivalent lengths and height differences (m) for outdoor unit sizes...	Indoor unit combinations (see examples above)				Equivalent lengths and height differences (m) for outdoor unit sizes from 7.1 to 14.0 kW	Equivalent lengths and height differences (m) for outdoor unit sizes from 20.0 to 25.0 kW
Single	Twin	Single		Twin	Triple	Double-Twin			
Total pipe length	L	L + L1 + L2	≤ 50 m	L	L + L1 + L2	L + L1 + L2 + L3	L + L1 + L2 + L3 + L4 + L5 + L6	U-60/U-71: ≤ 50 m U-100/125/140: ≤ 75 m	≤ 100 m
Maximum pipe length from outdoor unit to most distant indoor unit	-	-	-	-	L + L1 or L + L2	L + L1 or L + L2 or L + L3	L + L1 + L3 or L + L1 + L4 or L + L2 + L5 or L + L2 + L6	-	≤ 100 m
Maximum branch pipe length	-	L1 L2	≤ 15	-	L1 or L2	L1 or L2 or L3	L1 + L3 or L1 + L4 or L2 + L5 or L2 + L6	≤ 15 m	≤ 20 m
Maximum branch pipe length differences	-	L1 > L2 L1 - L2	≤ 10	-	L1 > L2: L1 - L2	L1 > L2 > L3: L1 - L2 L2 - L3 L1 - L3	L2 + L6 (Max.) L1 + L3 (Min.): (L2 + L6) - (L1 + L3)	≤ 10 m	≤ 10 m
Maximum pipe length differences after first branch (Double-Twin)	-	-	-	-	-	-	L2 > L1: L2 - L1	≤ 10 m	≤ 10 m
Maximum pipe length differences after second branch (Double-Twin)	-	-	-	-	-	-	L4 > L3: L4 - L3 L6 > L5: L6 - L5	≤ 10 m	≤ 10 m
Height difference (outdoor unit located higher)	H1	H1	≤ 30	H1	H1	H1	H1	≤ 30 m	≤ 30 m
Height difference (outdoor unit located lower)	H1	H1	≤ 15	H1	H1	H1	H1	≤ 15 m	≤ 15 m
Height difference between indoor units	-	H2	≤ 0.5	-	H2	H2 or H3 or H4	H2 or H3 or H4 or H5 or H6	≤ 0.5 m	≤ 0.5 m

Twin System	PACI Standard Single and Twin System				PACI Elite Twin, Triple and Double-Twin System from 7.1 to 14.0 kW						PACI Elite Twin, Triple and Double-Twin System from 20.0 to 25.0 kW				
	Outdoor unit main pipe diameter (L)		Indoor unit connection tube (L1, L2)		Outdoor unit main pipe diameter (L)	Indoor unit connection pipe diameter (L1, L2, L3, L4) (mm)					Outdoor unit main pipe diameter (L) (mm)		Double-Twin distribution pipe (L1, L2)*	Indoor unit connection pipe diameter	
Unit type capacity	100	125	50	60	71 - 140	36	45	50	60	71	200	250	100 - 125	50	60 - 125
Liquid pipe (mm)	Ø 9.52	Ø 12.7	Ø 6.35	Ø 9.52	Ø 9.52	Ø 6.35	Ø 6.35	Ø 6.35	Ø 9.52	Ø 9.52	Ø 9.52	Ø 12.7	Ø 9.52	Ø 6.35	Ø 9.52
Gas pipe (mm)	Ø 15.88	Ø 15.88	Ø 12.7	Ø 15.88	Ø 15.88	Ø 12.70	Ø 12.70	Ø 12.70	Ø 15.88	Ø 15.88	Ø 25.4	Ø 25.4	Ø 15.88	Ø 12.7	Ø 15.88
Additional charge (g/m)	50	50	20	50	50	20	20	20	50	50	40	80	40	20	40

1. Total capacity of indoor unit connected after the branch

Refrigerant charging: For the twin connection, the amount of refrigerant required for pipe length 30 m has been included in this unit at the factory while that required for pipe length 20 m has been included for the Triple / Double-Twin connections. No additional charge is required for the first 30 m pipe length in the case of the twin connection and for the first 20 m in the case of the Triple / Double-Twin connections. The amount of included refrigerant for each model is listed on NAMA PLATE. Make additional charges by adding up pipe length in an order of main (L branch pipe), (L1, L2, L3 wide diameter) and then selecting the amount of refrigerant corresponding to the remaining (after 30 m for the Twin connection and after 20 m for the Triple / Double-Twin connections) liquid side pipe diameter and pipe length from the below table.



Optional Controller
Timer remote controller
CZ-RTC2



Optional Controller
Wired remote controller
CZ-RTC3 / CZ-RTC5



Optional Controller
Timer remote controller
CZ-RTC4



Optional Controller
Wireless remote controller
Various type.



Optional Controller
Simplified remote controller
CZ-REZC2

Compatible with all Panasonic connectivity solutions. For detailed information go to the Control Systems section.

Compatible Indoor Units			3.6 kW	4.5 kW	5.0 kW	6.0 kW	7.1 kW	10.0 kW	12.5 kW
Capacity for all indoor units	Cooling	kW	3.6	4.5	5.0	6.0	7.1	10.0	12.5
	Heating	kW	4.2	5.2	5.6	7.0	8.0	11.2	14.0

Wall			S-36PK1E5A	S-45PK1E5A	S-50PK1E5A	S-60PK1E5A	S-71PK1E5A	S-100PK1E5A
Dimensions	H x W x D	mm	300 x 1,065 x 230	300 x 1,065 x 230	300 x 1,065 x 230	300 x 1,065 x 230	300 x 1,065 x 230	300 x 1,065 x 230
Sound pressure level	Cooling (Hi / Me / Lo)	dB(A)	35 / 31 / 27	38 / 34 / 30	40 / 36 / 32	47 / 44 / 40	47 / 44 / 40	47 / 44 / 40
	Heating (Hi / Me / Lo)	dB(A)	35 / 31 / 27	38 / 34 / 30	40 / 36 / 32	47 / 44 / 40	47 / 44 / 40	47 / 44 / 40
Air volume	Cooling (Hi / Me / Lo)	m ³ / h	660 / 570 / 450	720 / 630 / 510	840 / 720 / 630	1,080 / 870 / 690	1,080 / 870 / 690	1,140 / 990 / 780
	Heating (Hi / Me / Lo)	m ³ / h	660 / 570 / 450	720 / 630 / 510	840 / 720 / 630	1,080 / 870 / 690	1,080 / 870 / 690	1,140 / 990 / 780

4 Way 60x60 Cassette			S-36PY2E5A	S-45PY2E5A	S-50PY2E5A
Panel			CZ-KPY3A / CZ-KPY3B	CZ-KPY3A / CZ-KPY3B	CZ-KPY3A / CZ-KPY3B
Dimensions (H x W x D)	Indoor	mm	288 x 583 x 583	288 x 583 x 583	288 x 583 x 583
	Panel CZ-KPY3A	mm	31 x 700 x 700	31 x 700 x 700	31 x 700 x 700
	Panel CZ-KPY3B	mm	31 x 625 x 625	31 x 625 x 625	31 x 625 x 625
Sound pressure level	Cooling (Hi / Me / Lo)	dB(A)	36 / 32 / 26	38 / 34 / 28	40 / 37 / 33
	Heating (Hi / Me / Lo)	dB(A)	36 / 32 / 26	38 / 34 / 28	40 / 37 / 33
Air volume	Cooling / Heating	m ³ / h	582 / 594	600 / 618	666 / 666

4 Way 90x90 Cassette			S-36PU1E5A	S-45PU1E5A	S-50PU1E5A	S-60PU1E5A	S-71PU1E5A	S-100PU1E5A	S-125PU1E5A
Panel			CZ-KPU21	CZ-KPU21	CZ-KPU21	CZ-KPU21	CZ-KPU21	CZ-KPU21	CZ-KPU21
Dimensions	Indoor H x W x D	mm	256 x 840 x 840	256 x 840 x 840	256 x 840 x 840	256 x 840 x 840	256 x 840 x 840	319 x 840 x 840	319 x 840 x 840
	Panel H x W x D	mm	33.5 x 950 x 950	33.5 x 950 x 950	33.5 x 950 x 950	33.5 x 950 x 950	33.5 x 950 x 950	33.5 x 950 x 950	33.5 x 950 x 950
Sound pressure level	Cooling (Hi / Me / Lo)	dB(A)	30 / 28 / 27	31 / 28 / 27	32 / 29 / 27	36 / 31 / 28	37 / 31 / 28	44 / 38 / 32	45 / 39 / 33
	Heating (Hi / Me / Lo)	dB(A)	30 / 28 / 27	31 / 28 / 27	32 / 29 / 27	36 / 31 / 28	37 / 31 / 28	44 / 38 / 32	45 / 39 / 33
Air volume	Cooling (Hi / Me / Lo)	m ³ / h	840 / 780 / 720	900 / 780 / 720	960 / 810 / 720	1,260 / 1,020 / 840	1,320 / 1,020 / 840	1,980 / 1,620 / 1,260	2,100 / 1,680 / 1,320
	Heating (Hi / Me / Lo)	m ³ / h	840 / 780 / 720	900 / 780 / 720	960 / 810 / 720	1,260 / 1,020 / 840	1,320 / 1,020 / 840	1,980 / 1,620 / 1,260	2,100 / 1,680 / 1,320

Low Static Pressure Hide Away			S-36PN1E5A	S-45PN1E5A	S-50PN1E5A	S-60PN1E5A	S-71PN1E5A	S-100PN1E5A	S-125PN1E5A
Dimensions	H x W x D	mm	250 x 780(+100) x 650	250 x 780(+100) x 650	250 x 780(+100) x 650	250 x 1,000(+100) x 650	250 x 1,000(+100) x 650	250 x 1,200(+100) x 650	250 x 1,200(+100) x 650
Sound pressure level	Cooling (Hi / Me / Lo)	dB(A)	40 / 38 / 35	41 / 39 / 35	41 / 39 / 35	43 / 41 / 36	43 / 41 / 36	44 / 42 / 37	46 / 44 / 39
	Heating (Hi / Me / Lo)	dB(A)	40 / 38 / 35	41 / 39 / 35	41 / 39 / 35	43 / 41 / 36	43 / 41 / 36	44 / 42 / 37	46 / 44 / 39
External static pressure	High / Medium / Low	Pa	80 / 50 / 10	80 / 50 / 10	80 / 50 / 10	80 / 50 / 10	80 / 50 / 10	80 / 50 / 10	80 / 50 / 10
Air volume	Cooling / Heating	m ³ / h	840 / 840	960 / 960	960 / 960	1,320 / 1,320	1,320 / 1,320	2,160 / 2,160	2,280 / 2,280

Hide Away High Static Pressure			S-36PF1E5A	S-45PF1E5A	S-50PF1E5A	S-60PF1E5A	S-71PF1E5A	S-100PF1E5A	S-125PF1E5A
Dimensions	H x W x D	mm	290 x 800 x 700	290 x 800 x 700	290 x 800 x 700	290 x 1,000 x 700	290 x 1,000 x 700	290 x 1,400 x 700	290 x 1,400 x 700
Sound pressure level	Cooling (Hi / Me / Lo)	dB(A)	33 / 29 / 25	34 / 30 / 26	34 / 30 / 26	35 / 32 / 26	35 / 32 / 26	38 / 34 / 31	39 / 35 / 32
	Heating (Hi / Me / Lo)	dB(A)	33 / 29 / 25	34 / 30 / 26	34 / 30 / 26	35 / 32 / 26	35 / 32 / 26	38 / 34 / 31	39 / 35 / 32
External static pressure	High / Medium / Low	Pa	150 / 70 / 10	150 / 70 / 10	150 / 70 / 10	150 / 70 / 10	150 / 70 / 10	150 / 100 / 10	150 / 100 / 10
Air volume	Cooling (Hi / Me / Lo)	m ³ / h	840 / 780 / 600	840 / 780 / 600	960 / 900 / 720	1,260 / 1,140 / 900	1,260 / 1,140 / 900	1,920 / 1,560 / 1,260	2,040 / 1,740 / 1,380
	Heating (Hi / Me / Lo)	m ³ / h	840 / 780 / 600	840 / 780 / 600	960 / 900 / 720	1,260 / 1,140 / 900	1,260 / 1,140 / 900	1,920 / 1,560 / 1,260	2,040 / 1,740 / 1,380

Ceiling			S-36PT2E5A	S-45PT2E5A	S-50PT2E5A	S-60PT2E5A	S-71PT2E5A	S-100PT2E5A	S-125PT2E5A
Dimensions	H x W x D	mm	235 x 960 x 690	235 x 960 x 690	235 x 960 x 690	235 x 1,275 x 690	235 x 1,275 x 690	235 x 1,590 x 690	235 x 1,590 x 690
Sound pressure level	Cooling (Hi / Me / Lo)	dB(A)	35 / 32 / 30	38 / 33 / 30	38 / 33 / 30	39 / 36 / 33	39 / 36 / 33	42 / 38 / 35	45 / 40 / 37
	Heating (Hi / Me / Lo)	dB(A)	36 / 32 / 30	39 / 34 / 30	39 / 34 / 30	40 / 36 / 33	40 / 36 / 33	42 / 38 / 35	46 / 41 / 38
Air volume	Cooling (Hi / Me / Lo)	m ³ / h	840 / 720 / 630	900 / 750 / 630	900 / 750 / 630	1,200 / 1,020 / 870	1,260 / 1,080 / 930	1,800 / 1,500 / 1,380	1,800 / 1,680 / 1,440
	Heating (Hi / Me / Lo)	m ³ / h	840 / 720 / 630	900 / 750 / 630	900 / 750 / 630	1,200 / 1,020 / 870	1,260 / 1,080 / 930	1,800 / 1,500 / 1,380	2,040 / 1,680 / 1,440

Compatible Outdoor Units			7.1 kW	10.0 kW	12.5 kW	14.0 kW	7.1 kW	10.0 kW	12.5 kW	14.0 kW	20.0 kW	25.0 kW
Outdoor Single Phase			U-71PE1E5	U-100PE1E5	U-125PE1E5	—	U-71PE1E5A	U-100PE1E5A	U-125PE1E5A	U-140PE1E5A		
Outdoor Three Phase			—	U-100PE1E8	U-125PE1E8	U-140PE1E8	U-71PE1E8A	U-100PE1E8A	U-125PE1E8A	U-140PE1E8A	U-200PE1E8	U-250PE1E8
Cooling capacity	Nominal (Min - Max)	kW	7.1 (2.0 - 7.7)	10.0 (2.7 - 11.5)	12.5 (3.8 - 13.5)	14.0 (3.3 - 15.5)	7.1 (2.5 - 8.0)	10.0 (3.3 - 12.5)	12.5 (3.3 - 14.0)	14.0 (3.3 - 15.5)	20.0 (6.0 - 22.4)	25.0 (6.0 - 28.0)
Heating capacity	Nominal (Min - Max)	kW	7.1 (1.8 - 8.1)	10.0 (2.1 - 13.8)	12.5 (3.4 - 15.0)	14.0 (4.1 - 16.0)	8.0 (2.0 - 9.0)	11.2 (4.1 - 14.0)	14.0 (4.1 - 16.0)	16.0 (4.1 - 18.0)	21.8 (6.0 - 22.4)	28.0 (6.0 - 31.5)
Power source	Single Phase	V	220 / 230 / 240	220 / 230 / 240	220 / 230 / 240	—	220 / 240	220 / 240	220 / 240	220 / 240	380 / 415	380 / 415
	Three Phase	V	—	380 / 400 / 415	380 / 400 / 415	380 / 415	380 / 415	380 / 415	380 / 415	380 / 415	380 / 415	380 / 415
Connection		mm ²	2.50	4.00	6.00	2.50	2 x 1.5 or 2.5	2 x 1.5 or 2.5	2 x 1.5 or 2.5	2 x 1.5 or 2.5	—	—
Air volume	Cooling / Heating	m ³ /h	2,340	4,560 / 4,020	4,800 / 4,380	8,100 / 7,200	3,600 / 3,600	6,600 / 5,700	7,800 / 6,600	8,100 / 7,200	7740	7080
Sound pressure level	Cooling / Heating (Hi)	dB(A)	50 / 52	54 / 54	56 / 56	54 / 53	48 / 50	52 / 52	53 / 53	54 / 55	57 / 57	57 / 58
Sound power level	Cooling / Heating (Hi)	dB	70 / 70	70 / 70	73 / 73	71 / 70	65 / 67	69 / 69	70 / 70	71 / 71	72	73
Dimensions	H x W x D	mm	569x790x285	996x940x340	996x940x340	1,416x940x340	996x940x340	1,416x940x340	1,416x940x340	1,416x940x340	1526x940x340	1526x940x340
Net weight		kg	42	73	85	98	69	98	98	98	118	128
Piping connections	Liquid pipe	Inch (mm)	3/8 (9.52)	3/8 (9.52)	3/8 (9.52)	3/8 (9.52)	3/8 (9.52)	3/8 (9.52)	3/8 (9.52)	3/8 (9.52)	9.52 (3/8)	12.7 (1/2)
	Gas pipe	Inch (mm)	5/8 (15.88)	5/8 (15.88)	5/8 (15.88)	5/8 (15.88)	5/8 (15.88)	5/8 (15.88)	5/8 (15.88)	5/8 (15.88)	25.4 (1)	25.4 (1)
Refrigerant Loading	R410A	kg	1.7	2.60	3.20	3.4	2.35	3.4	3.4	3.4	6.5	
Elevation difference (in/out)	Max	m	30	30	30	30	30	30	30	30	30	
Piping length	Min / Max	m	5 / 50	5 / 50	5 / 50	5 / 50	5 / 50	5 / 75	5 / 75	5 / 100	5 / 100	
Operating range	Cooling Min / Max	°C	-10 / +43	-10 / +43	-10 / +43	-10 / +43	-15 / +46	-15 / +46	-15 / +46	-15 / +46	-15 / +43	-15 / +43
	Heating Min / Max	°C	-15 / +24	-15 / +24	-15 / +24	-15 / +24	-20 / +24	-20 / +24	-20 / +24	-20 / +24	-20 / +15	-20 / +15



Air Curtain with DX Coil

Connected to the PACi or VRF Systems

The Panasonic range of air curtains is designed for smooth operation and efficient performance. Air curtains produce a continuous stream of air blown from the top to the bottom of an open doorway and create a barrier that people and products can flow across, but air can't. Designed to improve energy efficiency, minimise heat loss from a building, and to allow retailers to keep doors open to encourage customers, our Air Curtains are suitable for connection to both PACi and VRF Systems.

- Super-efficient with new EC fan motor (40% lower running costs compared to a standard AC fan motor)
- Easy Cleaning and Servicing
- Can be connected to either Panasonic PACi or VRF systems
- Built-in drain for cooling operation
- Standard and Jet Flow air curtains can be controlled via Panasonic's range of remote internet controls

The new standard and jet-flow models are ideal for connection to a PACi or ECOi system. With simple 'plug and play' installation, both are fitted with an EC fan motor for a smooth operation and efficient performance. This new fan guarantees 40% lower running cost than with a standard AC fan motor. With air curtains often running for 12 hours a day as a minimum, this can lead to considerable savings.

Heating capacity comparison:
Electrical Air curtain / Panasonic Air Curtain

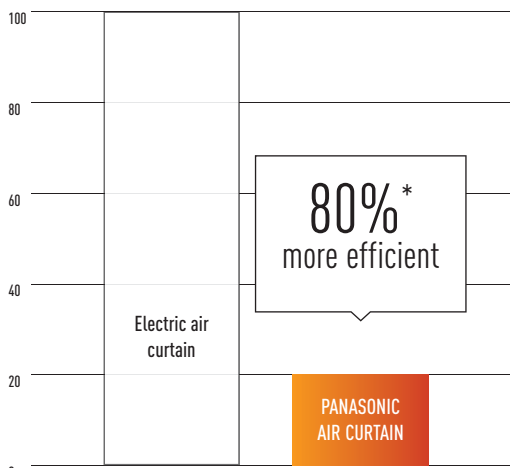

* With the U-100PE1E5 on the PAW-20PAIRC-MS.
Calculation method: Taking as consideration SCOP of the Panasonic combination of 6,0. If 100 is the energy needed for a air curtain, Panasonic Air curtain will need $1/(1-6) * 100 = 20$.

Highly efficient heating effect

The combined air stream, which has a desirable low air current induction factor (mixing factor), can carry the selected initial temperature effect over long distances, and will reach the floor area while still at room temperature. This is necessary to avoid cooling down the interior spaces.

Available in different lengths to suit requirements between 1 and 2.5m, both air curtains have outlet grilles that can be adjusted to five different positions. The jet flow model can be installed up to a height of 3.5m with the standard model up to 3.0m. The outlet grilles can be easily adjusted into five positions to suit different installations requirements and the air filter can be accessed without the need for specialist tools.

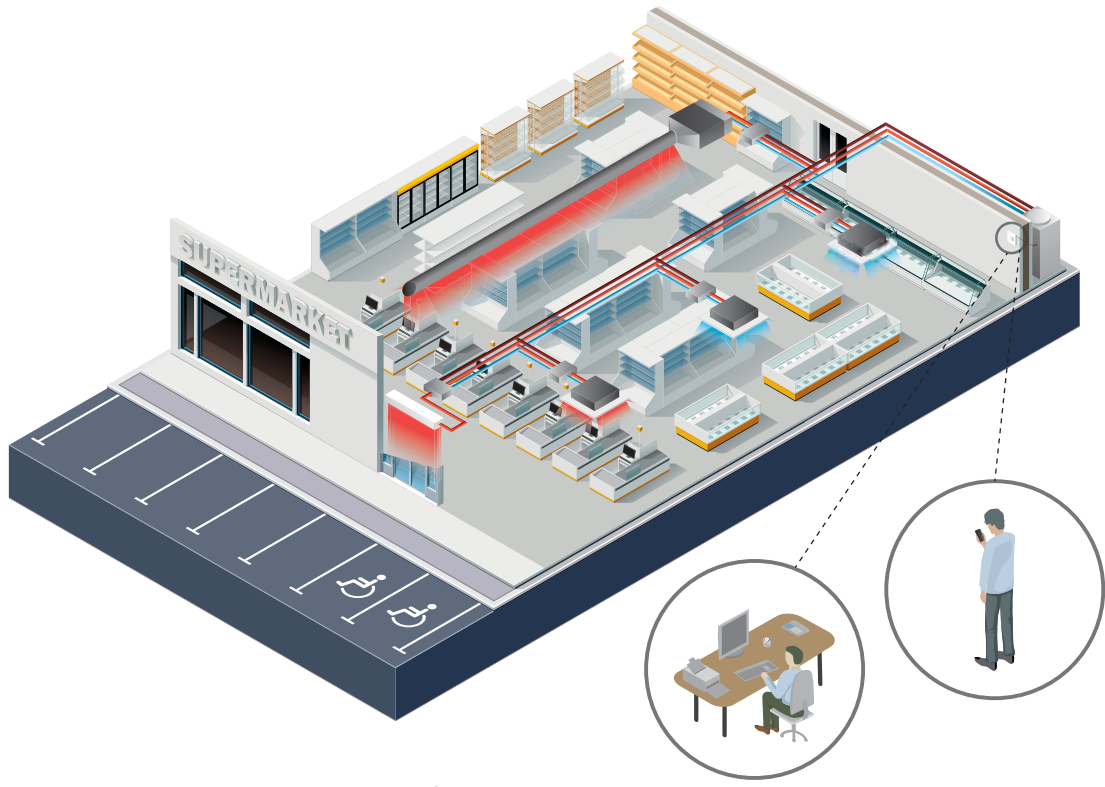

Intelligent Operation

Our air curtains combine air flow and heating / cooling technology to ensure optimum comfort and energy efficiency whilst also creating an effective barrier between indoor and outdoor environments. Design and installation is key to achieving the correct height / temperature settings to achieve optimum performance. Our air curtains are designed to answer the demands of the retail, commercial and industrial markets.

Internet Control

An app added to your tablet or smartphone or via the Internet allows you to control and manage the system remotely. There is also the option to integrate into existing BMS systems by using other Panasonic interfaces.

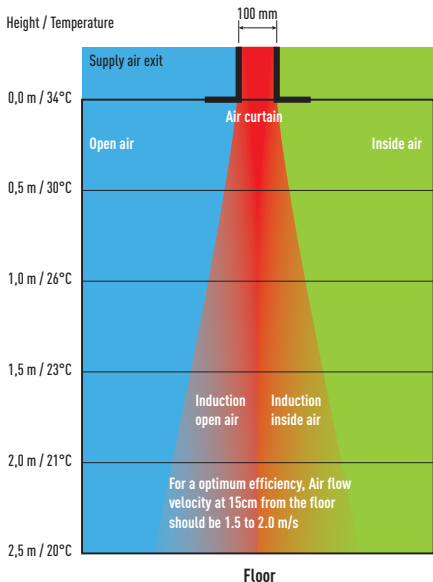

Optimised air flow velocity

1. Energy losses, no air curtain installed
2. Too low velocity air curtain – Air Curtain not efficient
3. Optimum results with the Tekadoor Air Curtain connected to Panasonic PACi
4. Too high velocity air curtain – considerable turbulence, energy lost to the outside, Air Curtain not efficient

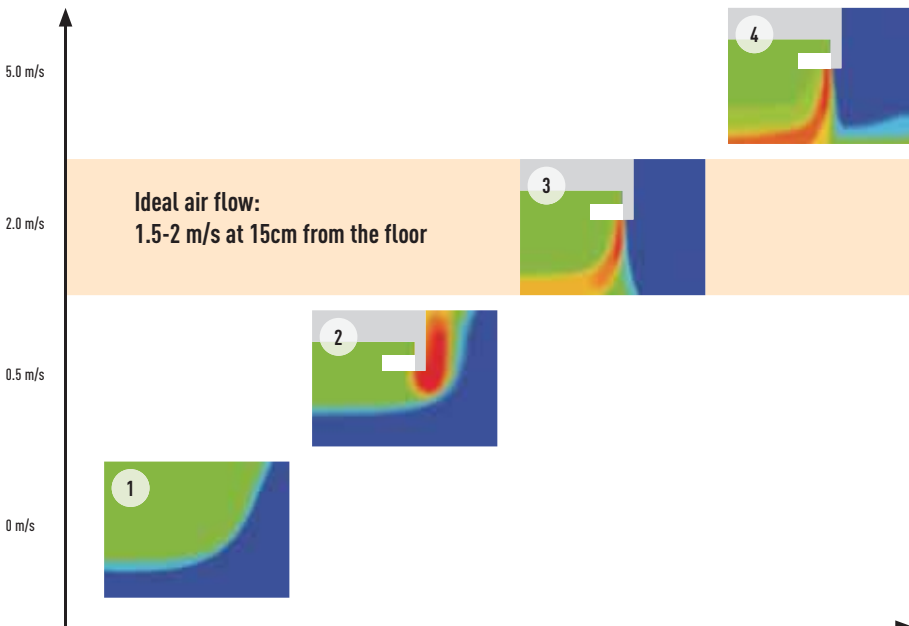

How does it work?

Stale air from the room is taken in and ejected near the door. This creates a 'roll of air' that shields the door area, mixing with the colder incoming air. It then turns away from the door, back into the room and toward the intake screen, where it is partly drawn in again. This flow of air helps to create a barrier for heat loss yet at the same time refreshes room air.

AIR CURTAIN WITH DX COIL

High efficiency Air curtain connected to your PACi installation on 1x1 connection!

Plug & Play Installation

EC Fan motor for a smooth operation and efficient performance.

2 types of Air flow available: Jet-Flow and Standard.

2015 Fan Standard available today.

Easy Cleaning and Servicing.

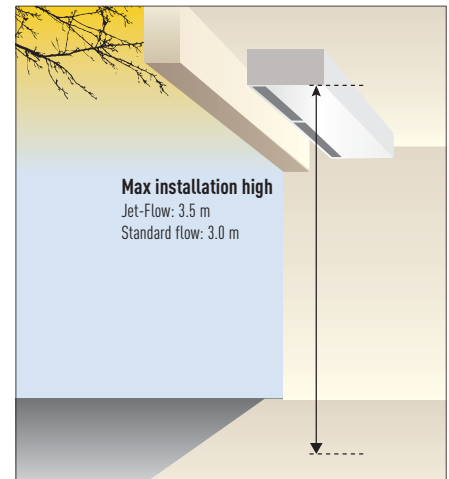

HP			4 HP	6 HP	8 HP	4 HP	8 HP		
Air Curtain			PAW-10PAIRC-MJ	PAW-15PAIRC-MJ	PAW-20PAIRC-MJ	PAW-10PAIRC-MS	PAW-20PAIRC-MS		
Air flow type			Jet-flow			Standard			
Air Flow Length (A)			m	1.0	1.5	2.0	1.0	2.0	
Air volume	High	m ² /h	1,800	2,700	3,600	1,800	2,700		
	Medium	m ² /h	1,500	2,300	3,000	1,500	2,300		
	Low	m ² /h	1,200	1,900	2,500	1,200	1,900		
Cooling capacity nominal ¹			kW	9.2	17.5	23.1	9.2	17.5	
Heating capacity with air in 20°C, air out 40°C			kW	11.9	17.9	23.9	11.9	17.9	
Heating capacity with air in 20°C, air out 35°C			kW	8.9	13.4	17.9	8.9	13.4	
Heating capacity with air in 20°C, air out 30°C			kW	5.9	8.9	11.9	5.9	8.9	
Max installation height	Good condition	m	3.5	3.5	3.5	3.0	3.0		
	Normal condition	m	3.1	3.1	3.1	2.7	2.7		
	Bad condition	m	2.7	2.7	2.7	2.4	2.4		
Refrigerant			R410A	R410A	R410A	R410A	R410A		
Liquid pipe			Inch (mm)	3/8 (9.52)	3/8 (9.52)	3/8 (9.52)	3/8 (9.52)	3/8 (9.52)	
Gas pipe			Inch (mm)	5/8 (15.88)	3/4 (19.05)	7/8 (22.22)	5/8 (15.88)	7/8 (22.22)	
Fan			230V / 50Hz / 1 / N / PE						
Fan type			EC						
Currency	High	A	2.1	2.8	4.2	2.1	4.2		
	Med	A	0.8	1.1	1.6	0.8	1.6		
	Low	A	0.3	0.4	0.6	0.3	0.6		
Electrical Consumption	High	kW	0.44	0.59	0.89	0.44	0.89		
	Med	kW	0.17	0.23	0.34	0.17	0.34		
	Low	kW	0.06	0.08	0.12	0.06	0.12		
Protecting Fuse			A M16A						
Noise			dB(A) 40-55						
Dimensions			W x H x D	mm	1,210 x 260 x 590	1,710 x 260 x 590	2,210 x 260 x 590	1,210 x 260 x 490	2,210 x 260 x 490
Weight			kg						
			70	100	138	60	128		

Outdoor combination with PACi Elite unit 40°C	U-100PE1E5/8	U-140PE1E5/8	U-200PE1E8	U-100PE1E5/8	U-140PE1E5/8
Outdoor combination with PACi Standard unit 40°C	U-100PEY1E5/8	—	—	U-100PEY1E5/8	—
Outdoor combination with PACi Elite unit 35°C	U-71PE1E5/8	U-100PE1E5/8	U-140PE1E5/8	U-71PE1E5/8	U-100PE1E5/8
Outdoor combination with PACi Standard unit 35°C	U-100PEY1E5/8	U-100PEY1E5/8	—	U-100PEY1E5/8	U-100PEY1E5/8
Outdoor combination with PACi Elite unit 30°C	U-50PE1E5	U-100PE1E5/8	U-100PE1E5/8	U-50PE1E5	U-100PE1E5/8
Outdoor combination with PACi Standard unit 30°C	U-60PEY1E5	U-100PEY1E5/8	U-100PEY1E5/8	U-60PEY1E5	U-100PEY1E5/8

All combinations under rated conditions: Heating Outdoor +7°C DB/+6°C WB Indoor +20°C DB. In case of lower outdoor temperatures a higher capacity outdoor unit model may be necessary
 1) Rated Conditions Cooling Outdoor +35°C DB Indoor +27°C DB/+19°C WB, Discharge temperature 3 16°C.

ELECTRIC AIR CURTAIN

Air curtains can help reduce whole building heating or cooling costs by helping to stop heat escaping the building or keeping cooled air in. Panasonic offers two sizes - 900mm and 1200mm electric air curtains. Ideal for separating areas and energy saving.



			FY-10ESPNAH	FY-10ELPNAH
Width			900	1.200
Watts	Hi / Lo	W	71,5 / 61,5	96 / 74
Current	Hi / Lo	A	0,40 / 0,29	0,54 / 0,35
Air speed	Hi / Lo	m/s	13,0 / 11,1	13,1 / 11,0
Air volume	Hi / Lo	m ³ /h	750 / 630	1.000 / 830
Noise lever	Hi / Lo	dB(A)	46 / 42	46 / 41
Weight			kg	11
			11	14



Technical focus

- Save up to 40% Energy Costs by use of the integrated EC Fan Technology (Higher efficiency than conventional AC fan, softstart and longer motor duration)
- 3 Lengths of Air Curtains Jet-Flow, from 1 to 2 m and 2 lengths of Air Curtains Standard, 1 and 2 m
- Installation Height up to 3.5 m (Jet-Flow) and 3.0 m (Standard)
- Outlet Grilles can be adjusted in five positions, to suite different Indoor and installation requirements (Jet-Flow)
- Control with Panasonic Remote Control systems (optional)
- Direct integration to BMS by optional Panasonic Interfaces
- Drain included for cooling operation
- Drain pump and float switch available for forced drainage

Features

COMFORT

- Easy redirection of Air-Flow by means of manual deflector (Jet-Flow)

EASE OF USE

- Speed selectable on remote controller with 3 speeds

EASY INSTALLATION AND MAINTENANCE

- Easy installation
- Compact dimensions improve installation and positioning (Jet-Flow)
- Easy cleaning of grid without opening of the unit
- Continuous operation even in case of 1 fan motor failure without stopping air curtain function or stopping the complete system
- Warning indication on remote controller display

Jet-flow dimensions

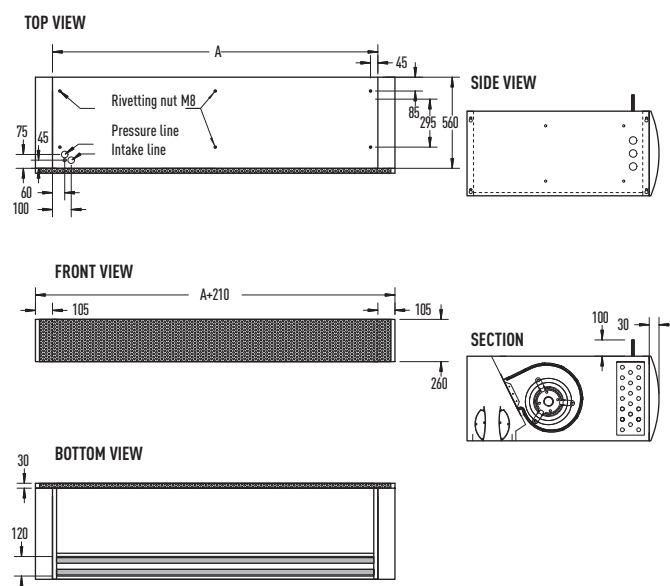

	PAW-10PAIRC-MJ	PAW-15PAIRC-MJ	PAW-20PAIRC-MJ	PAW-25EAIRC-MJ
A	1,000	1,500	2,000	2,500

Standard dimensions

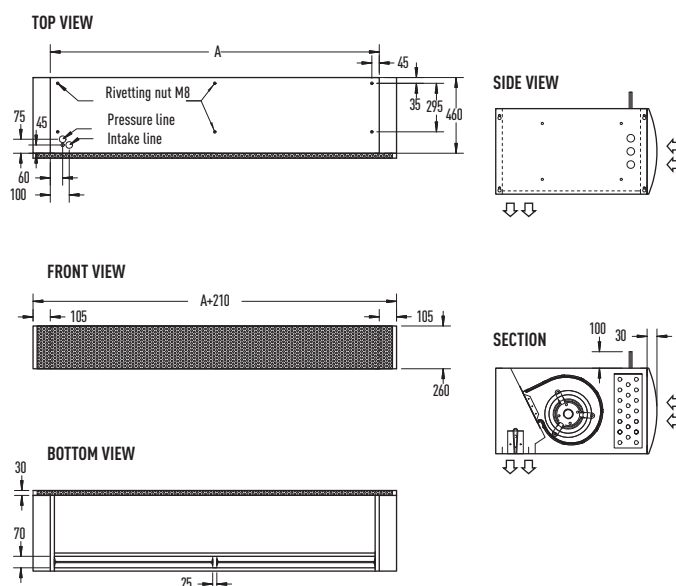

	PAW-10PAIRC-MS	PAW-20PAIRC-MS
A	1,000	2,000



Air Handling Unit Kit 10-25 kW for PACi

New AHU Kit connects PACi outdoor units to Air Handling Units system

The Panasonic AHU Kits offer a wealth of connectivity possibilities so can be easily integrated into many systems. Application: Hotels, offices, server rooms or all large buildings where air quality control such as humidity control and fresh air and is needed.

2 types of AHU Kit: Advanced and Standard

Model Code	IP 65	0-10V demand control	Outdoor temperature shift compensation. Cold draft prevention	Remote controller CZ-RTC2/C4
CZ-280PAH1	No	No	No	No
PAW-280PAH2	No	No	No	Yes
PAW-280PAHZL	Yes	No	No	Yes

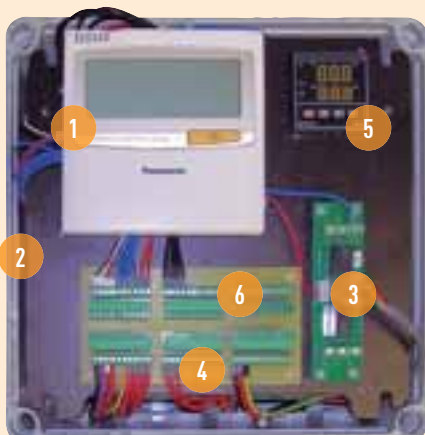

1. Remote control CZ-RTC4
2. New plastic IP 65 Box
3. PAW-T10 PCB for dry contact
4. 0-10V demand control PCB
5. Intelligent thermostat for:
 - Cold draft prevention
 - Outdoor temperature shift compensation
6. Terminal base for sensors and power supply

AHU Connection Kit



PCB, Power trans, Terminal block



Thermistor x2 (Refrigerant: E1, E3)



Thermistor (Air: TA; 1 sensor)

Remote controller



Standard wired remote controller. Can be installed inside the box.

Panasonic AHU Kit, 10-25 kW connected to PACi outdoor unit

The new Air Handling Unit Kit has been developed to better meet customer demand:

- IP 65 Box in order to be installed outside
- 0-10V demand control*
- Easy control by BMS

* Only available with Elite PACi, up to from 6kW to 14kW.

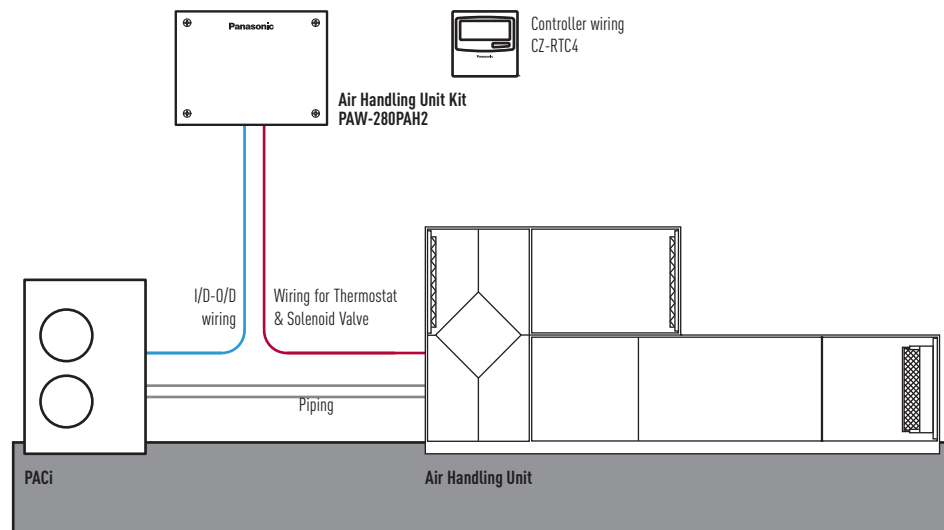

0-10V control

With the 0-10 v demand control the capacity of the outdoor unit can be controlled by 20 steps

Analog input (V)	Demand (%)
0 (not connect)	Free
0.5	Stop
1.0	40
1.5	45
2.0	50
2.5	55
3.0	60
3.5	65
4.0	70
4.5	75
5.0	80
5.5	85
6.0	90
6.5	95
7.0	100
7.5	105
8.0	110
8.5	115
9.0	120
9.5	Free
10.0	0 (TH. OFF)

Following functions are available by using different control accessories

CZ-RTC4 Timer remote controller

- Operation-ON/OFF
- Mode select
- Temperature setting

* Fan operation signal can be taken from the PCB.

CZ-T10 terminal

- Input signal= Operation ON/OFF
- Remote controller prohibition
- Output signal= Operating-ON status
- Alarm output (by DC12 V)

PAW-OCT, DC12 V outlet. OPTION terminal

- Output signal= Cooling / Heating/Fan status
- Defrost
- Thermostat-ON

PAW-T10, PCB to connect to T10 connector

- A Dry contact PCB has been developed to easily control the unit
- Input signal operation ON/OFF
- Remote control prohibition
- Output signal operation ON status maximum 230 V 5 A (NO/NC)
- Output signal alarm status maximum 230 V 5 A (NO/NC)
- **Additional available contacts:**
 - External humidifier control (ON/OFF) 230 VAC 3 A
 - External fan control (ON/OFF) 12V DC
 - External filter status signal potential free
 - External float switch signal potential free
 - External leakage detection sensor or TH. OFF contact potential free (possible usage for external blow out temperature control)

Combination table for PACi single outdoor unit

Combination shown in below table is available for PACi single system

Power	Size	PACi Standard	PACi Elite	AHU kit
Single Phase	5.0 kW	U-50PEY1E5		CZ-280PAH1 // PAW-280PAH2 // PAW-280PAH2L (Common use for all outdoor units. Only 1 by 1 connection is allowed.)
	6.0 kW	U-60PEY1E5		
	7.1 kW	U-71PEY1E5		
	10.0 kW		U-100PE1E5A	
	12.5 kW		U-125PE1E5A	
Three Phase	14.0 kW		U-140PE1E5A	
	10.0 kW		U-100PE1E8A	
	12.5 kW		U-125PE1E8A	
	14.0 kW		U-140PE1E8A	
	20.0 kW		U-200PE1E8	
	25.0 kW		U-250PE1E8	

* Additional notice/instruction for system design, installation work will be defined for PACi connection.

Possible to use on R22 pipings

R22 RENEWAL

R22 Renewal

Why renewal?

Unique R22 Renewal from Panasonic: Fast, easy to install and Cost effective

- Panasonic refrigerant oil doesn't react to the most common oil types used in air-conditioning systems. This ensures the mix of oil does not damage the units. Therefore installations are easier.
- All Panasonic PACi units can be installed in R22 pipings, no specific models are available.
- Up to 33 Bar! When there is any doubt about the strength of the piping, the maximum working pressure can be reduced to 33 Bar with a setting in the software of the outdoor unit.

An important drive to further reduce the potential damage to our ozone

It is often said that legislation is ruling our lives but sometimes it is there to help save lives. R22 phase out can be described as one of these and from Jan 1st 2010 the use of Virgin (new) R22 refrigerant was banned within the European Community.

Panasonic are doing our part

We at Panasonic are also doing our part – recognising that all finances are under pressure at the moment. Panasonic has developed a clean and cost effective solution to enable this latest legislation to be introduced with as minimum an effect on businesses and cash reserves as possible. The Panasonic renewal system allows good quality existing R22 pipe work to be re-used whilst installing new high efficiency R410A systems. By bringing a simple solution to the problem Panasonic can renew all Split Systems and PACi systems; and depending upon certain restrictions we don't even limit the manufacturer's equipment we are replacing. By installing a new high efficiency Panasonic R410A system you can benefit from around 30% running cost saving compared to the R22 system.

Yes...

1. Check the capacity of the system you wish to replace
2. Select from the Panasonic range the best system to replace it with
3. Follow the procedure detailed in the brochure and technical data

Simple...

R22 - The reduction of Chlorine critical for a cleaner future

Reuse of existing piping (Renewal Design & Installation)

Notes on reuse of existing refrigerant piping

It is possible for each series of PE1 type and PEY1 type outdoor unit to reuse the existing refrigerant piping without cleaning when obtained under certain conditions.. Make sure that the requirements under the section "Notes on reuse of existing refrigerant piping", "Measurement procedure for renewal" and "Refrigerant piping size and allowable piping length" will be satisfied in order to carry out .

Also, check the items with regard to section "Safety" and "Cleaning".

1. Prerequisite

- If the refrigerant used for the existing unit is other than R22, R407C and R410A, the existing refrigerant piping cannot be used.
- If the existing unit has another use than air conditioning, then existing refrigerant piping cannot be used.

2. Safety

- If there is a hollow, crack or corrosion on the piping, make sure to install new piping.
- If the existing piping is other than capable of reuse of piping as shown in the flowchart, make sure to install new piping.
- In case of multiple operation type, use our genuine branch piping for refrigerant R410A.

A local supplier shall assume responsibility for the defects and hollows on the reuse of existing piping surface and recognition of reliability of the piping strength. There is no guarantee that we take responsibility for such damages. The operational pressure of the refrigerant R410A becomes higher compared to R22. In the worst case, a lack of compressive strength may lead to piping explosion.

3. Cleaning

- When the refrigerant oil used for the existing unit is other than the listed below, make sure to install new piping or wash it thoroughly before reusing it.
[Mineral Oil] SUNISO, FIORE S, MS
[Synthesized oil] alkyl benzene oil (HAB, parallel freeze), ester oil, ether oil (PVE only)

If the existing unit is GHP type, it is necessary to wash the piping thoroughly.

- If the existing pipes in the outdoor and indoor units remain disconnected, make sure to install a new piping or wash it thoroughly before reusing it.
- If the discoloured oil or residue remains in the existing piping, make sure to install a new piping or wash it thoroughly before reusing it. See "Deterioration Criteria for Refrigerant Oil" in table 3.
- If the compressor of the existing air conditioner has a failure history, make sure to install a new piping or wash it through thoroughly before reusing it.

When reusing the existing piping as it is without removing dirt and dust, inadequate piping could result a renewal appliance in failure.

Notes on renewal for simultaneous operation of multiple units

Only main pipe is applicable for using the different diameter size.
 In case of different diameter size for the branch pipes, a new installation work for a standard size is necessary.
 Be sure to use our genuine branch piping for refrigerant R410A.

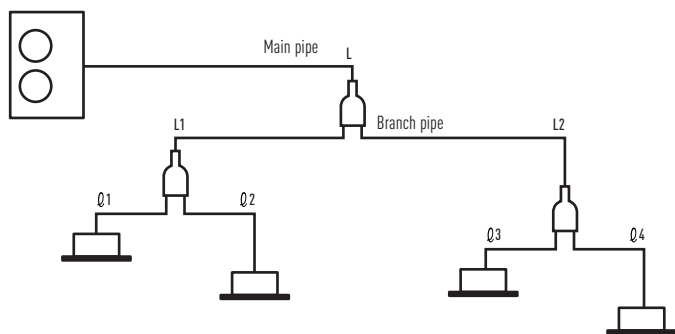

Notes on Renewal for Simultaneous Operation of Multiple Units		
Capacity class	Standard liquid pipe size	Standard gas pipe size
Type 50	Ø 6.35	Ø 12.7
Type from 60 to 140	Ø 9.52	Ø 15.88
Type 200	Ø 9.52	Ø 25.4
Type 250	Ø 12.7	

- Only the main pipe L can be used among different diameter's existing piping.
- Installation work as a standard size is capable for L1, L2, L1 - L4 piping.
- Be sure to use our genuine branch piping for refrigerant R410A.

1. In case of single unit

It is not necessary to charge with additional refrigerant until the chargeless pipe length in the table 2.
 If the pipe length is exceeding the chargeless pipe length, charge with additional refrigerant amount per 1 m according to the equivalent length.

2. In case of simultaneous operation of multiple units

Calculate the refrigerant charging amount according to the calculating method of the standard piping diameter.
 As to the additional refrigerant charging amount per 1 m, refer to the additional amount in the table 2.

Measurement Procedure for Renewal

Observe the following procedure when reusing the existing piping or carrying out renewal installation work.
 Flowchart of Existing Piping Measures Criteria for PE1 Type and PEY1 Type Outdoor Unit

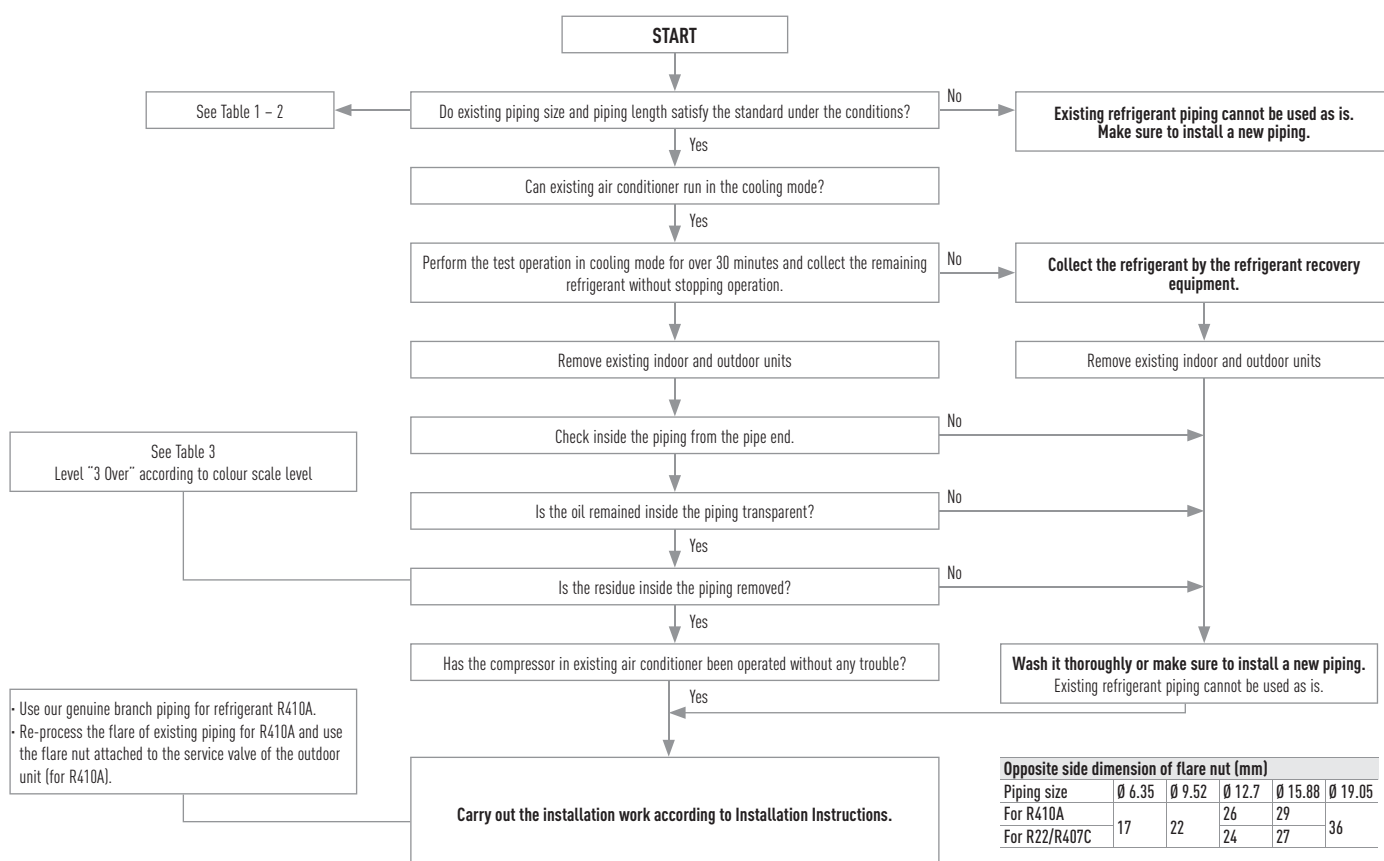

R22 Renewal

Refrigerant piping size and allowable piping length

Check if reuse of existing refrigerant piping is possible based on the following chart.

The standards other than this one (difference of elevation, etc.) are identical to the requirements of ordinary refrigerant piping.

Material	0								1/2 H, H*							
External diameter	Ø 6.35		Ø 9.52		Ø 12.7		Ø 15.88		Ø 19.05		Ø 22.22		Ø 25.4		Ø 28.58	
Thickness	0.80		0.80		0.80		1.00		1.00		1.00		1.00		1.00	

* It is impossible to reuse the size of Ø 19.05, Ø 22.22, Ø 25.4 and Ø 28.58 for material O. Change to material 1/2H or material H.

Liquid pipe		Ø 6.35		Ø 9.52		Ø 12.7		Ø 15.88		Ø 19.05		Ø 22.22		Ø 25.4		Ø 28.58		
Gas pipe		Ø 9.52		Ø 12.7		Ø 15.88		Ø 12.7		Ø 15.88		Ø 19.05		Ø 15.88		Ø 19.05		
PE	Type 50	×	Standard 40 m (30 m)	⊙ 40 m (30 m)	□ 20 m (15 m)	□ 20 m (15 m)	×	×	×	×	×	×	×	×	×	×	×	
PEY	Type 60 Type 71	×	▽ 10 m (10 m)	□ 10 m (10 m)	▽ 30 m (20 m)	Standard 50 m (20 m)	×	□ 25 m (10 m)	×	□ 25 m (10 m)	×	□ 25 m (10 m)	×	□ 25 m (10 m)	×	□ 25 m (10 m)	×	
Additional refrigerant charging amount per 1 m		20 g/m				40 g/m				80 g/m								
PE	Type 60 Type 71	×	▽ 10 m (10 m)	□ 10 m (10 m)	▽ 30 m (30 m)	Standard 50 m (30 m)	×	□ 25 m (15 m)	×	□ 25 m (15 m)	×	□ 25 m (15 m)	×	□ 25 m (15 m)	×	□ 25 m (15 m)	×	
	Type 100 Type 125 Type 140	×	×	×	×	Standard 75 m (30 m)	⊙ 75 m (30 m)	□ 35 m (15 m)	⊙ 75 m (30 m)	□ 35 m (15 m)	□ 35 m (15 m)	□ 35 m (15 m)	□ 35 m (15 m)	□ 35 m (15 m)	□ 35 m (15 m)	□ 35 m (15 m)	□ 35 m (15 m)	□ 35 m (15 m)
PEY	Type 100 Type 125 Type 140	×	×	×	×	Standard 50 m (30 m)	⊙ 50 m (30 m)	□ 25 m (15 m)	⊙ 50 m (30 m)	□ 25 m (15 m)	□ 25 m (15 m)	□ 25 m (15 m)	□ 25 m (15 m)	□ 25 m (15 m)	□ 25 m (15 m)	□ 25 m (15 m)	□ 25 m (15 m)	□ 25 m (15 m)
Additional refrigerant charging amount per 1 m		20 g/m				50 g/m				80 g/m								

How to see table definition (example):

In case of type 71, standard size is liquid pipe Ø 9.52 / gas pipe Ø 15.88,

There is a limitation to liquid pipe Ø 9.52 / gas pipe Ø 12.7 and to liquid pipe Ø 12.7 / gas pipe Ø 15.88,

However, they are applicable for different diameter's pipes.

Liquid pipe		Ø 9.52			Ø 12.7			Ø 15.88					
Gas pipe		Ø 22.22			Ø 22.22			Ø 25.4			Ø 28.58		
PE	Type 200	▽ 80 m (30 m)	Standard 100 m (30 m)	⊙ 100 m (30 m)	▽ 50 m (15 m)	□ 50 m (15 m)	□ 50 m (15 m)	×	×	×	×	×	×
	Type 250	×	×	×	▽ 80 m (30 m)	Standard 100 m (30 m)	⊙ 100 m (30 m)	▽ 65 m (20 m)	□ 65 m (20 m)	□ 65 m (20 m)	□ 65 m (20 m)	□ 65 m (20 m)	□ 65 m (20 m)
Additional refrigerant charging amount per 1 m		40 g/m			80 g/m			120 g/m					

- ⊙ Allowable
- ▽ Cooling capacity down
- Limited piping length
- × Unallowable
- 50 m Maximum piping length
- (50 m) Charge less piping length in a single connection

Table 3 Deterioration Criteria for Refrigerant Oil

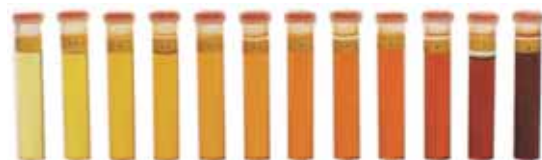
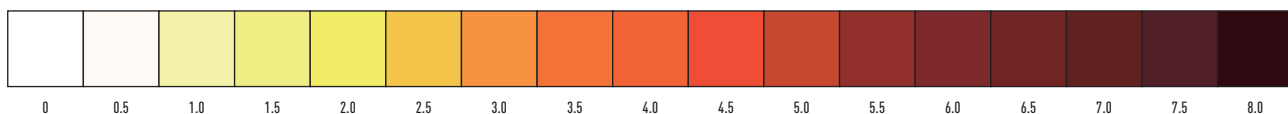

Control equipment external dimensions

Control Systems

Timer remote controller
(CZ-RTC4)

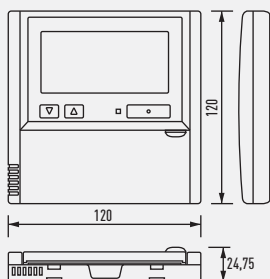

Wireless remote controller

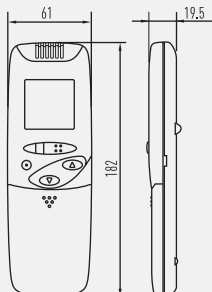

Separate receiver for wireless remote controller

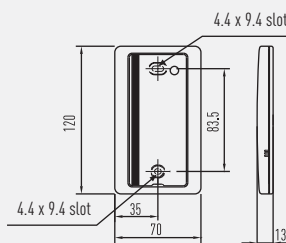

Simplified remote controller
(CZ-RE2C2)
Remote sensor
(CZ-CSRC2)

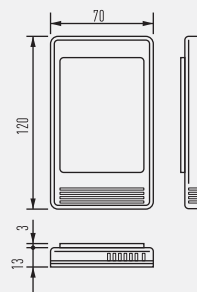

System controller
(CZ-64ESMC2)

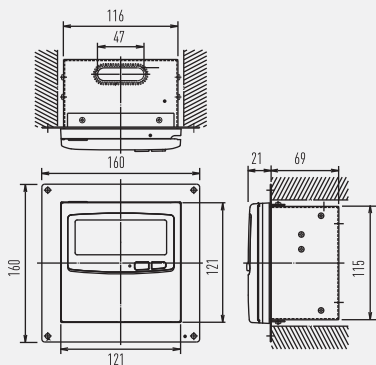

Intelligent controller
(CZ-256ESMC2)

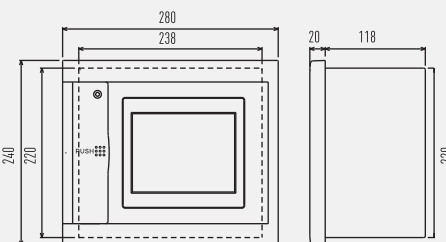

Communication adapter
(CZ-CFUNC2)

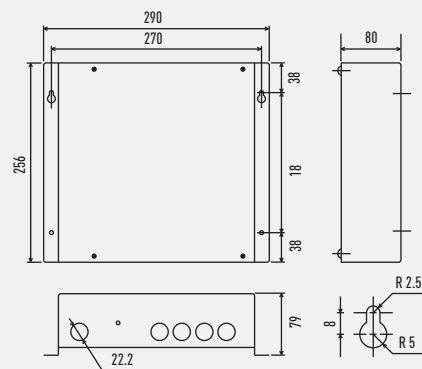

ON/OFF controller
(CZ-ANC2)

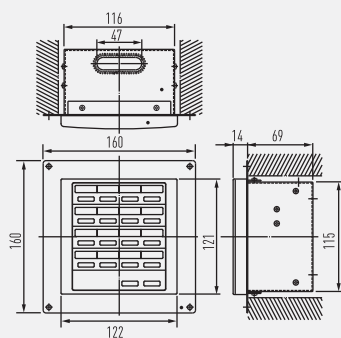

Seri-Para I/O unit for each indoor unit
(CZ-CAPBC2)

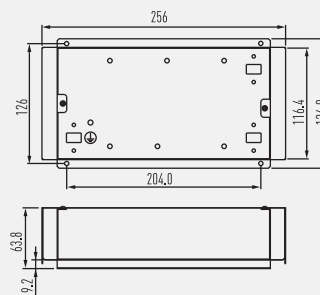

LonWorks interface
(CZ-CLNC2)

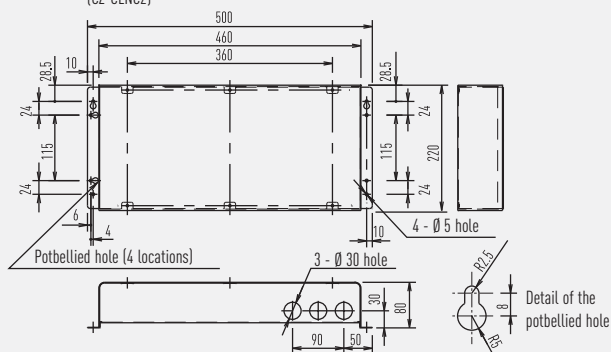

Seri-Para I/O unit for outdoor unit
(CZ-CAPDC2)

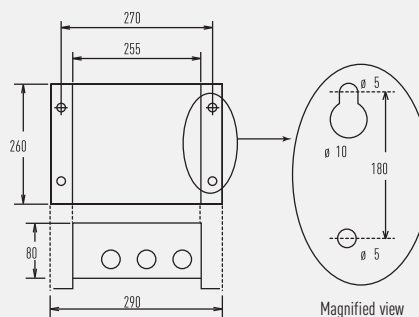

PKEA dimensions

Wall Mounted PKEA

CS-E9PKEA // CS-E12PKEA

CS-E15PKEA // CS-E18PKEA

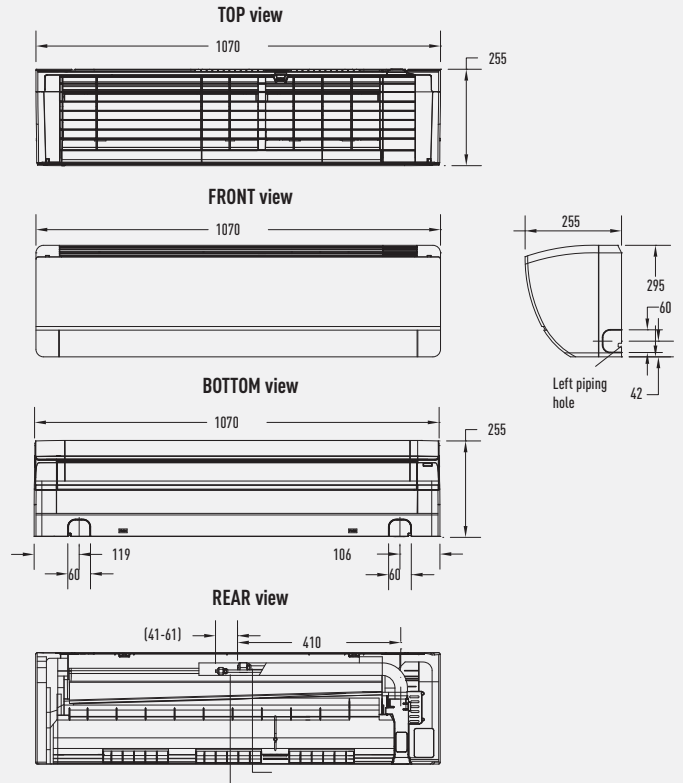
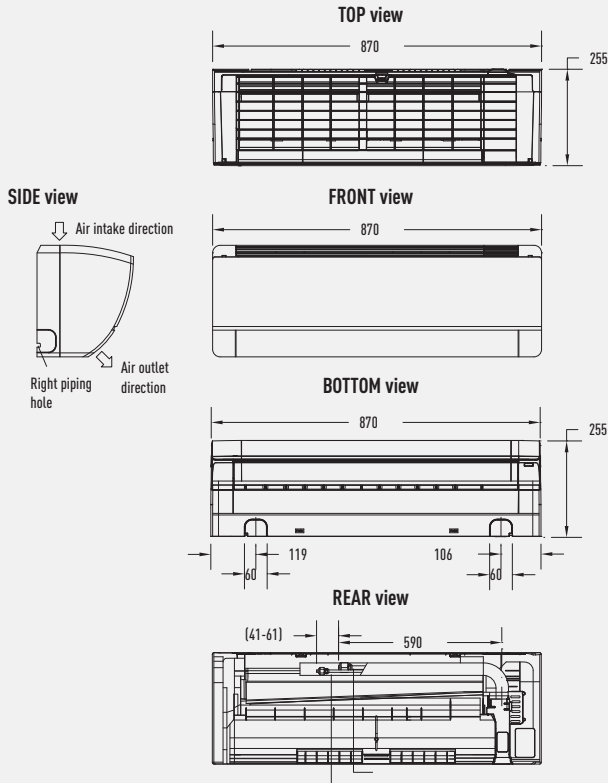

CU-E9PKEA // CU-E12PKEA

CU-E15PKEA // CU-E18PKEA

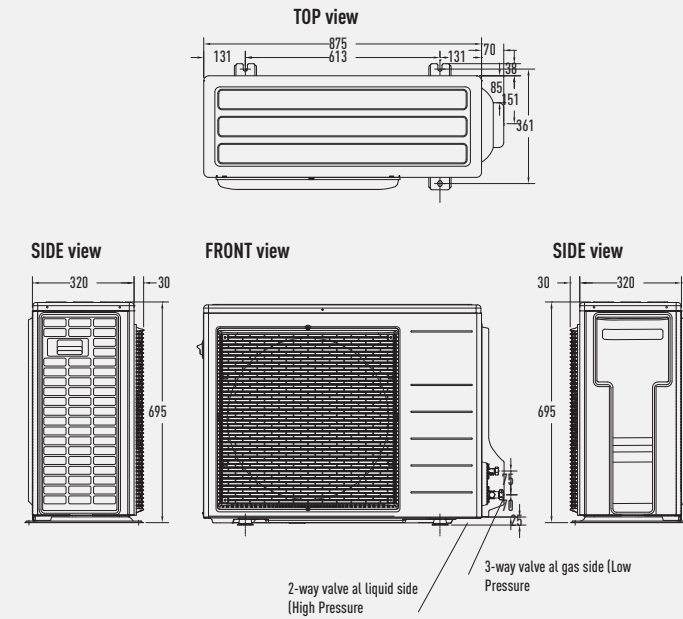
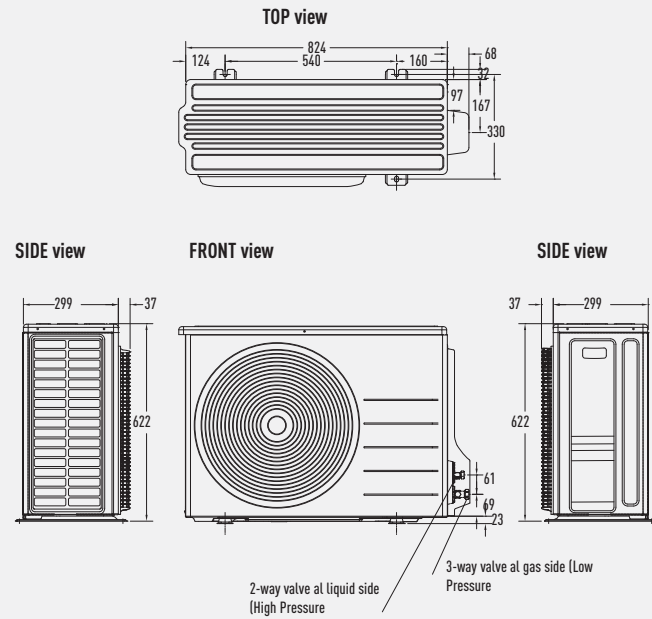

Dimensions: mm

PACi Standard and Elite dimensions

Wall

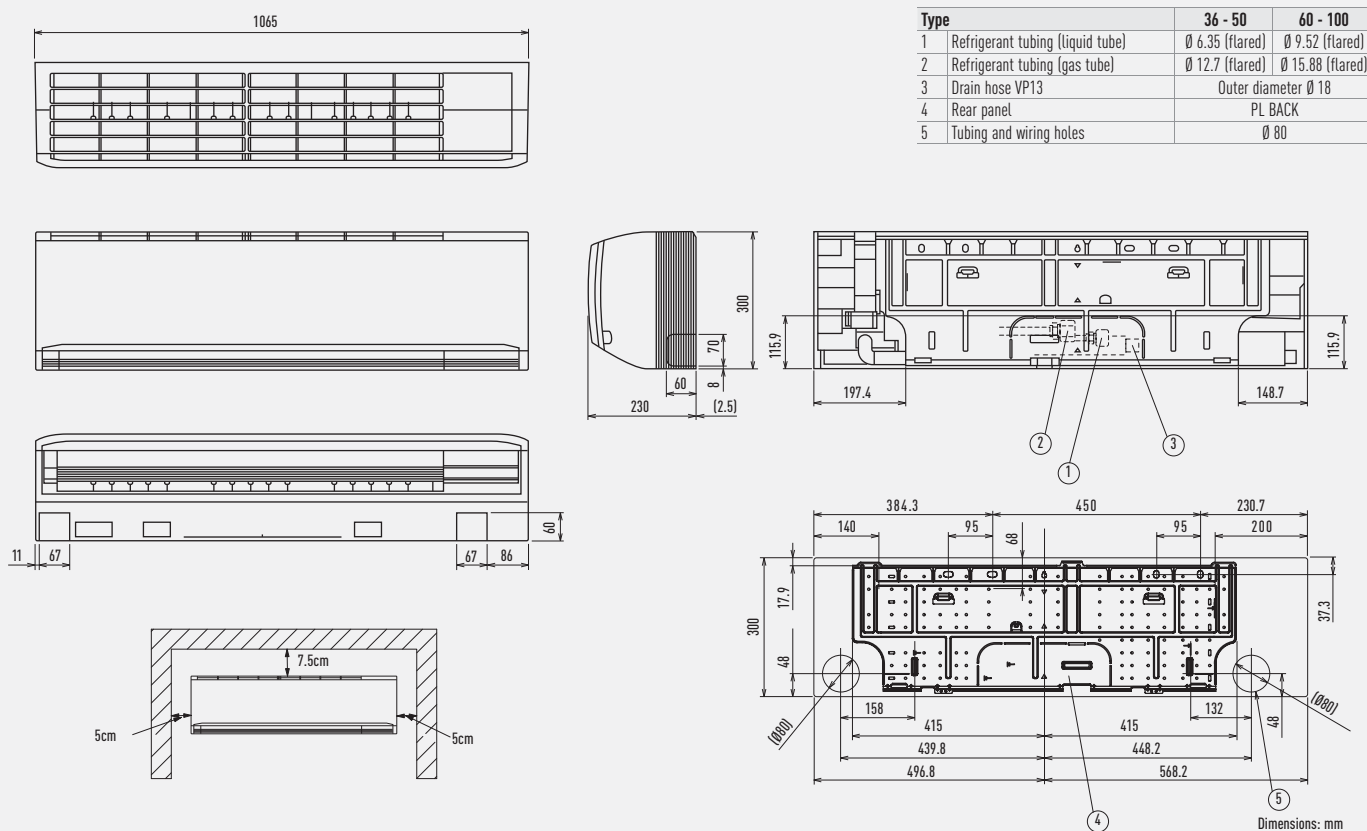

4-Way 60x60 Cassette

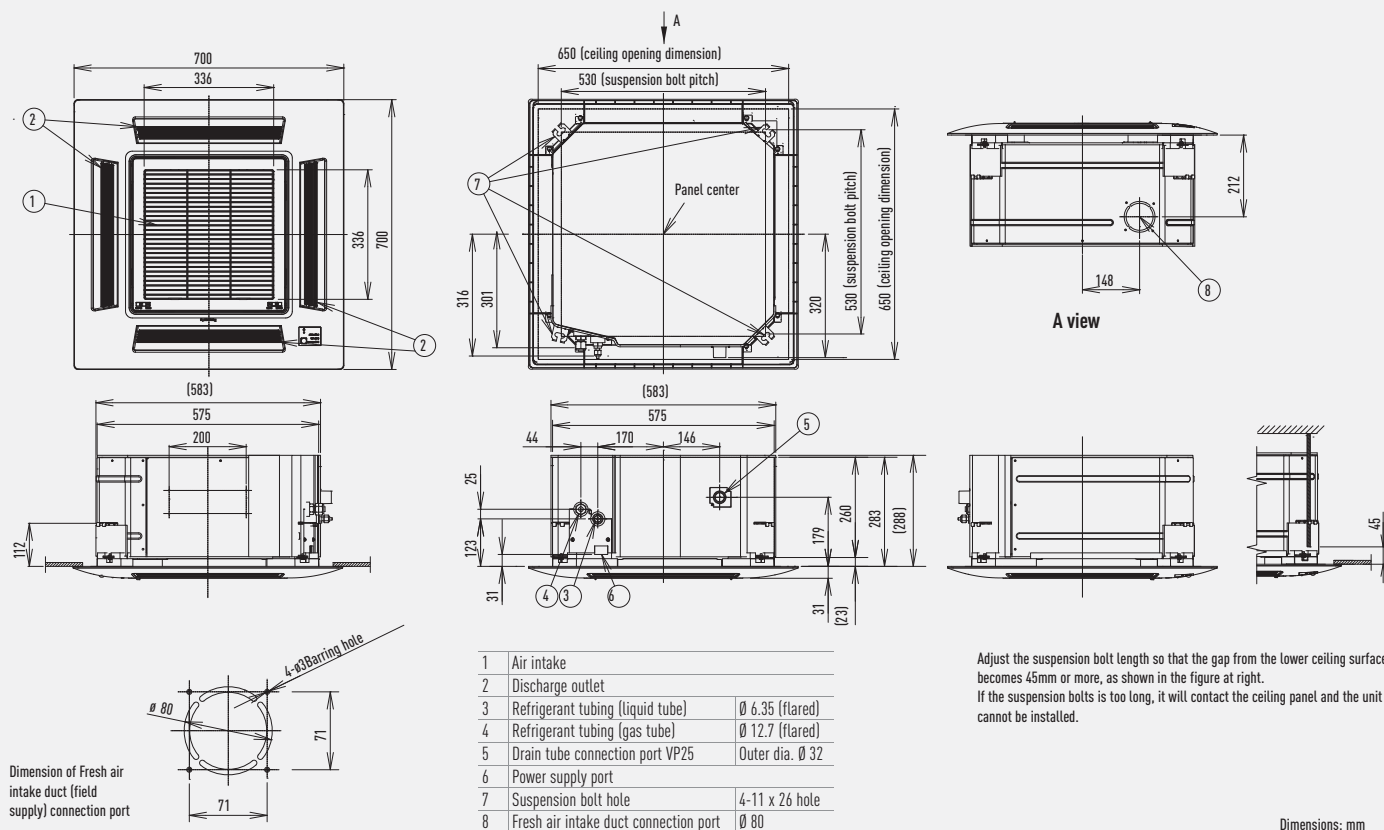

PACi Standard and Elite dimensions

4 Way 90x90 Cassette

Type	36 - 71	100 - 140
1	Air intake grill	
2	Air discharge outlet	
3	Refrigerant piping (liquid pipes)	
4	Ø 6.35 (flared)	Ø 9.52 (flared)
5	Refrigerant piping (gas pipes)	
6	Ø 12.7 (flared)	Ø 15.88 (flared)
7	Drain outlet VP50	
8	Outer diameter 32mm	
9	Power supply port	
10	Discharge duct	
11	Ø 150	
12	Suspension bolt hole	
13	4-12x30 slot	
14	Fresh air intake duct connection port	
15	Ø 100 ¹	

1 Air inlet kit is necessary.
Filter size: 520 x 520 x 16

Type	36 - 71	100 - 140
A	256	319
B	124	187

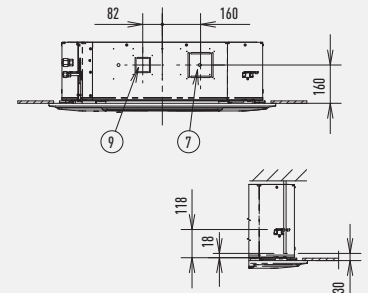
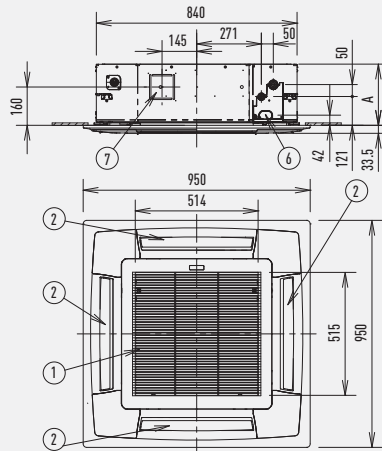
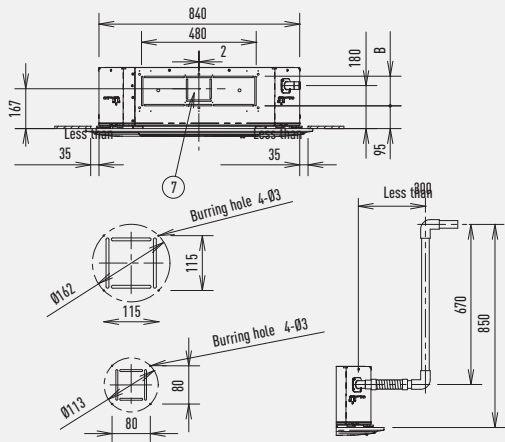
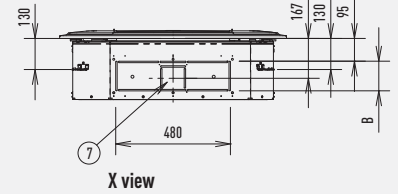
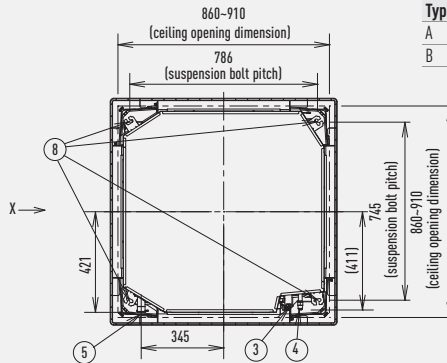

Adjust the suspension bolt length so that the gap from the lower ceiling surface becomes 30mm or more (18mm or more from the lower surface of the body) as shown in the figure. When the suspension bolt length is long, it hits the ceiling panel and installation is not possible.

Dimensions: mm

Low Static Pressure Hide Away

S-36PN1E5A // S-45PN1E5A // S-50PN1E5A

S-60PN1E5A // S-71PN1E5A

S-100PN1E5A // S-125PN1E5A // S-140PN1E5A

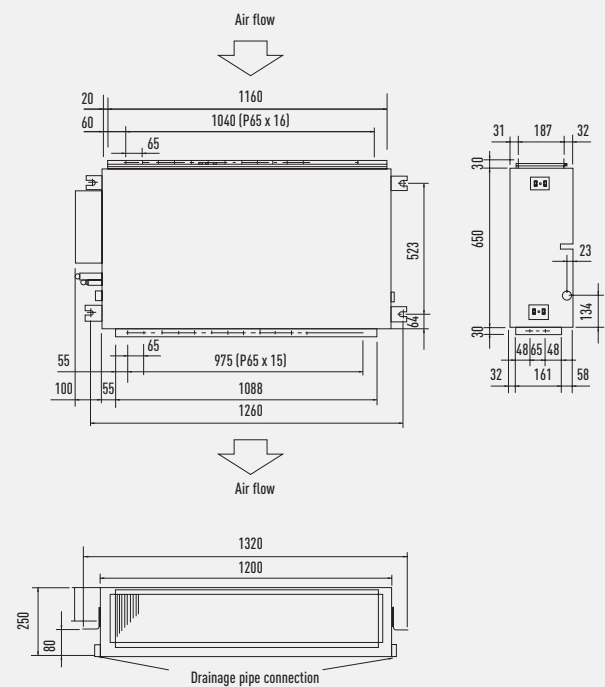
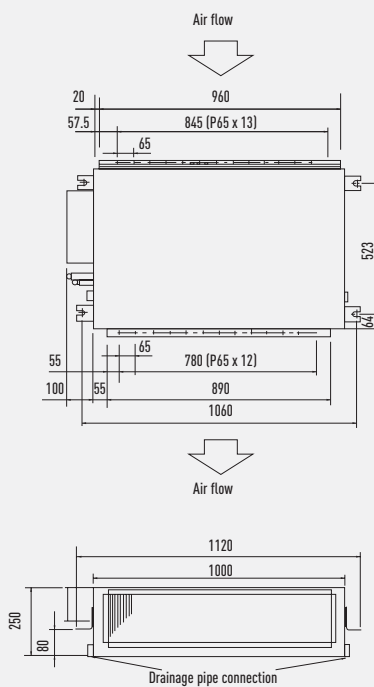
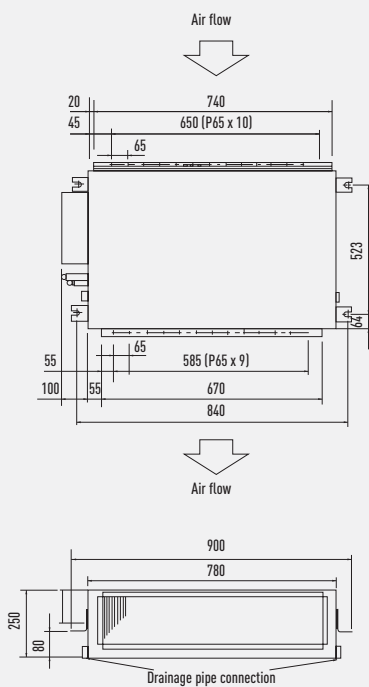

Dimensions: mm

High Static Pressure Hide Away

S-36PF1E5A // S-45PF1E5A // S-50PF1E5A

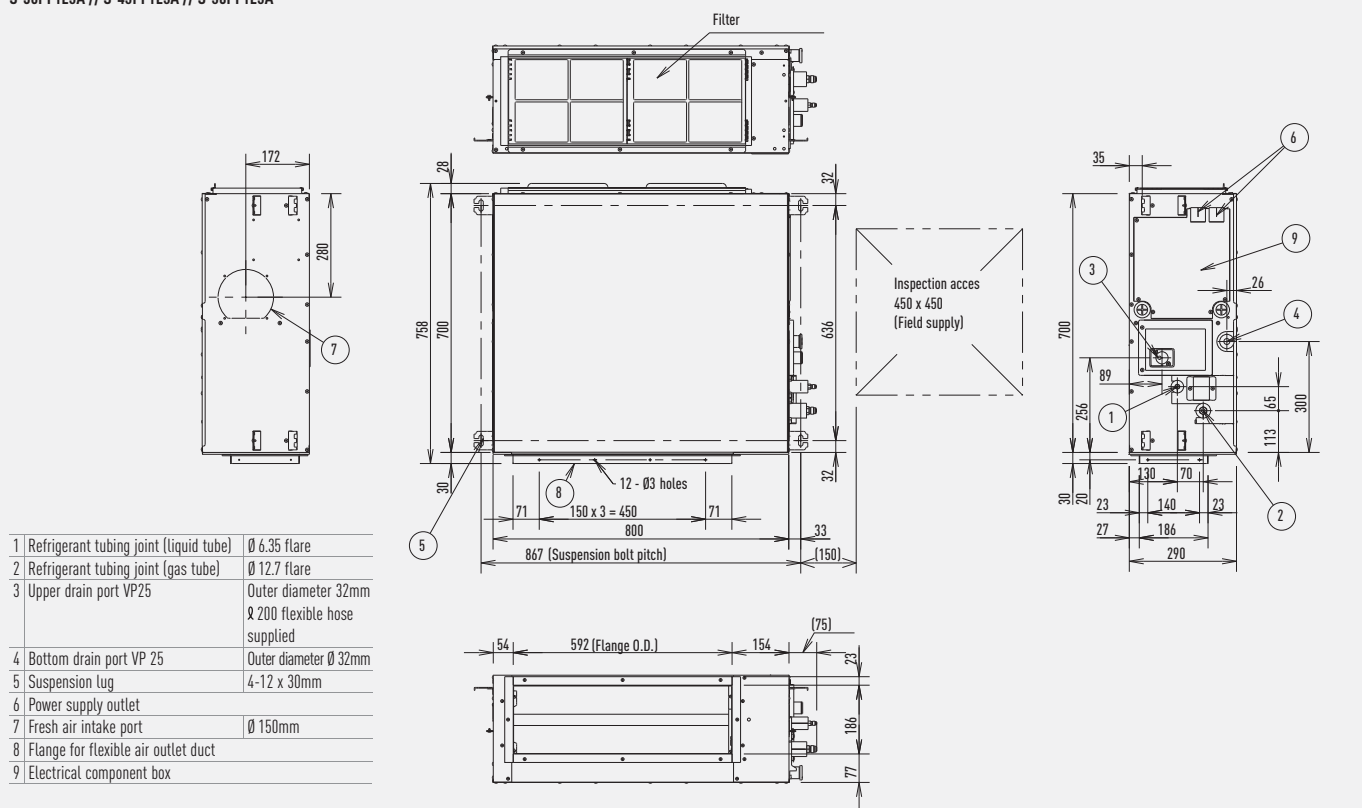

S-60PF1E5A // S-71PF1E5A

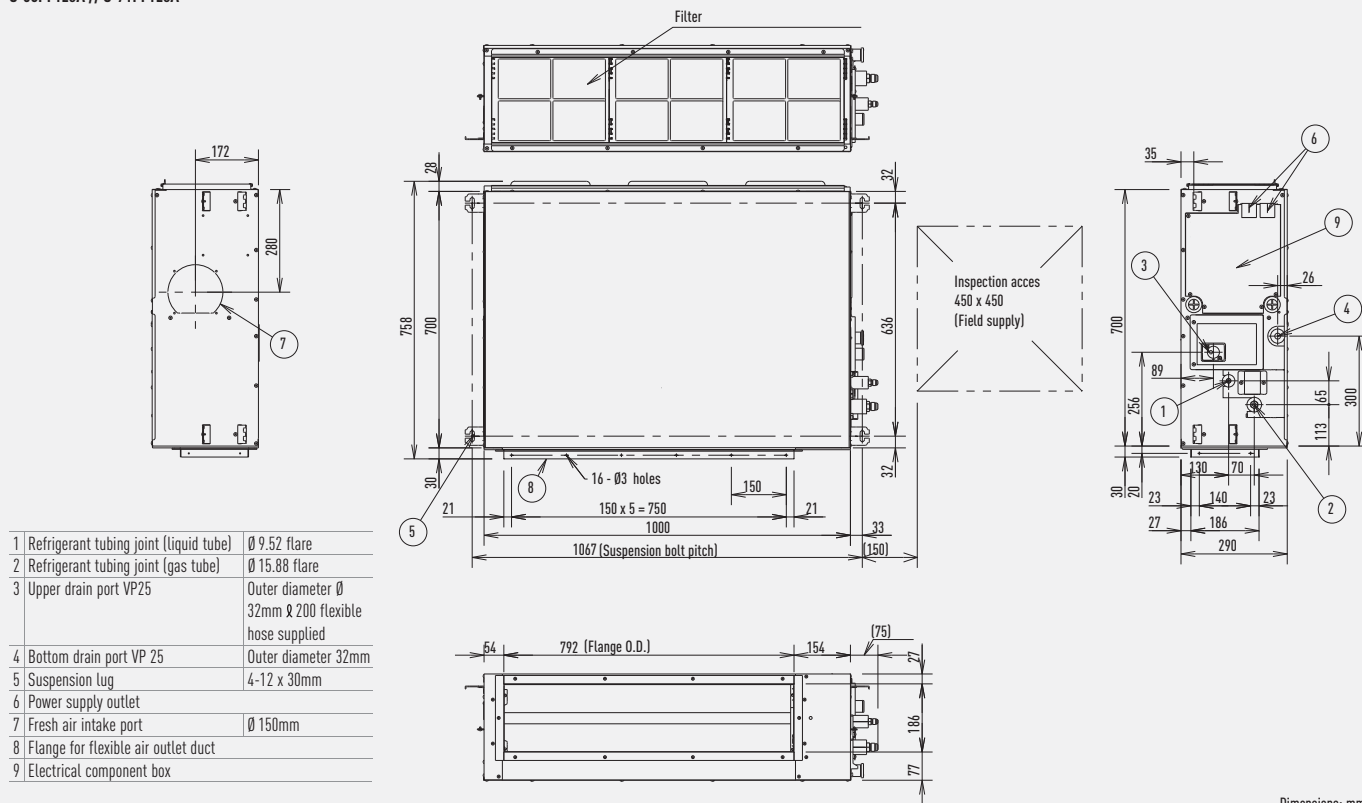

Dimensions: mm

PACi Standard and Elite dimensions

High Static Pressure Hide Away (Cont.)

S-100PF1E5A // S-125PF1E5A // S-140PF1E5A

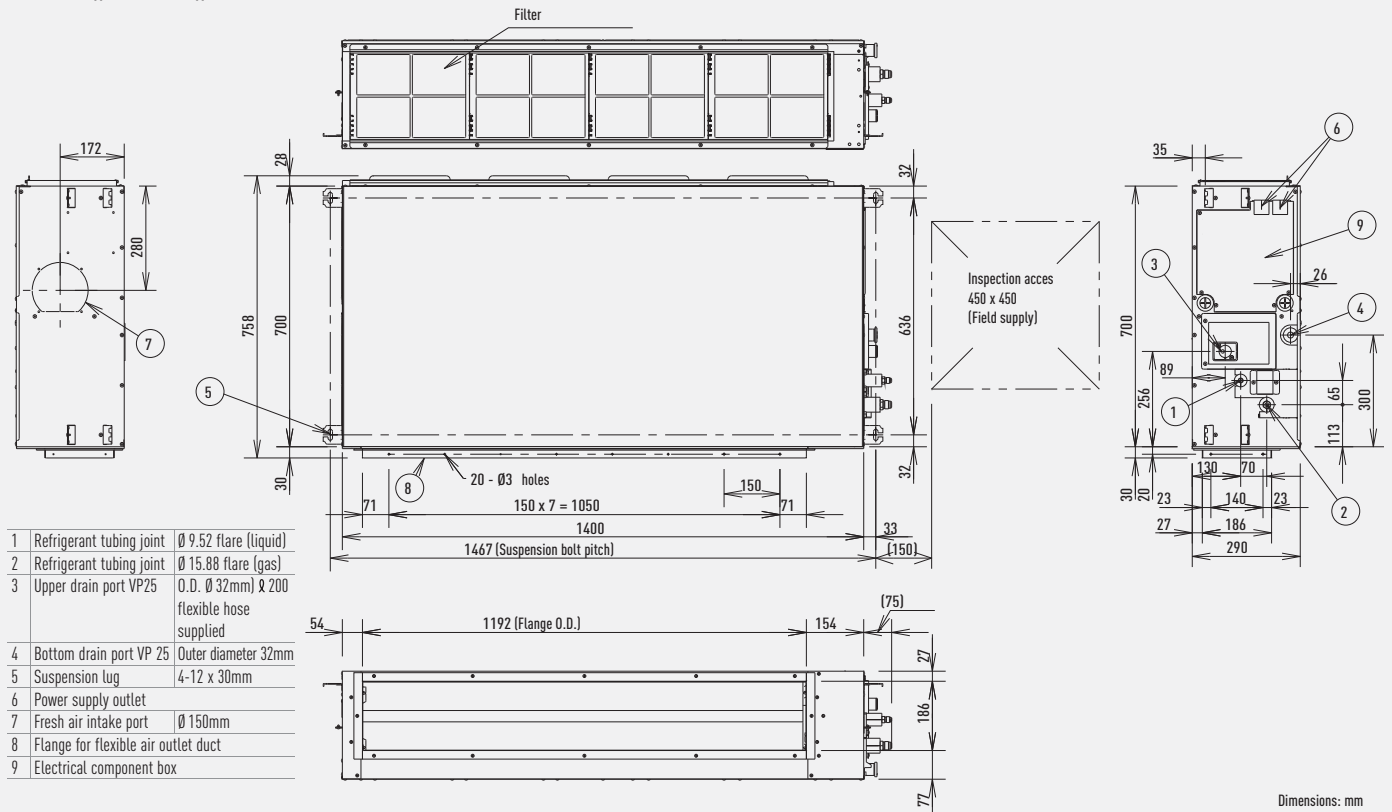

Ceiling

S-60PT2E5A // S-71PT2E5A

1 Drain port VP20	Inside diameter Ø 26mm, drain hose supplied
2 Left drain position	
3 Refrigerant liquid tubing	Ø 9.52mm, flare connection
4 Refrigerant gas tubing	Ø 15.88mm, flare connection
5 Left side drain hose outlet port (cutout)	
6 Tubing hole on wall surface	Ø 100mm
7 Upper side tubing port	
8 Right side drain hose outlet port (cutout)	
9 Wireless remote controller receiver installation location	

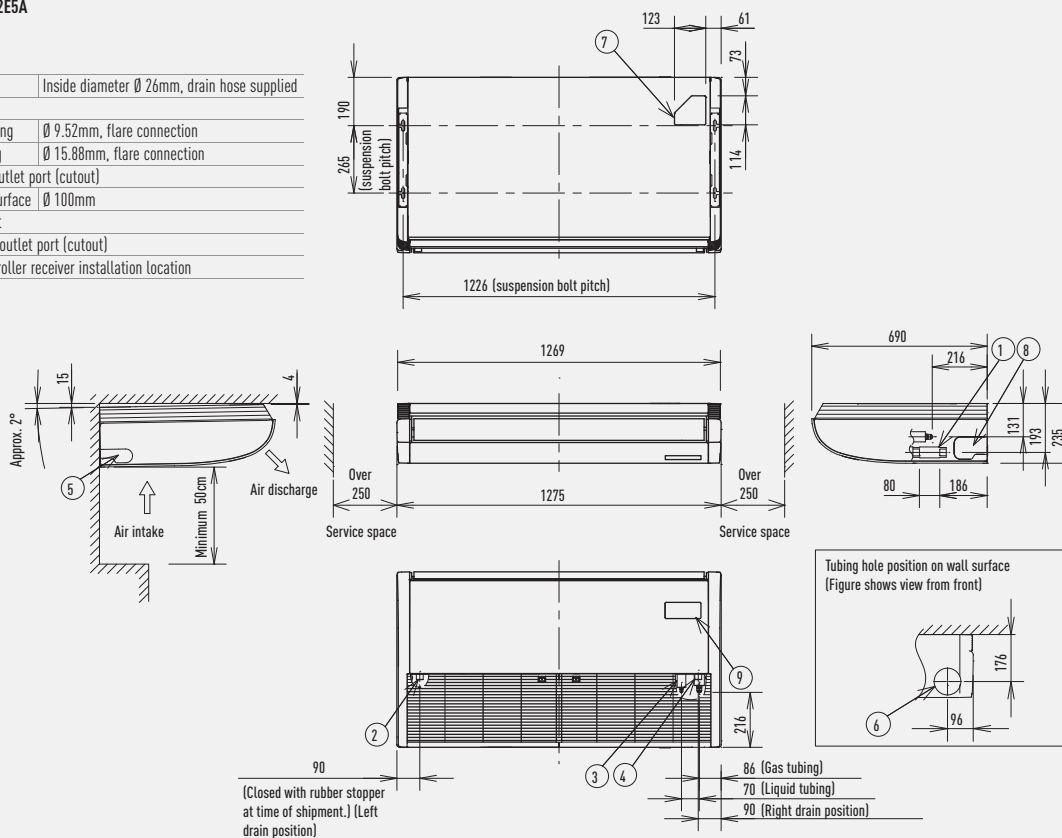

S-100PT2E5A // S-125PT2E5A // S-140PT2E5A

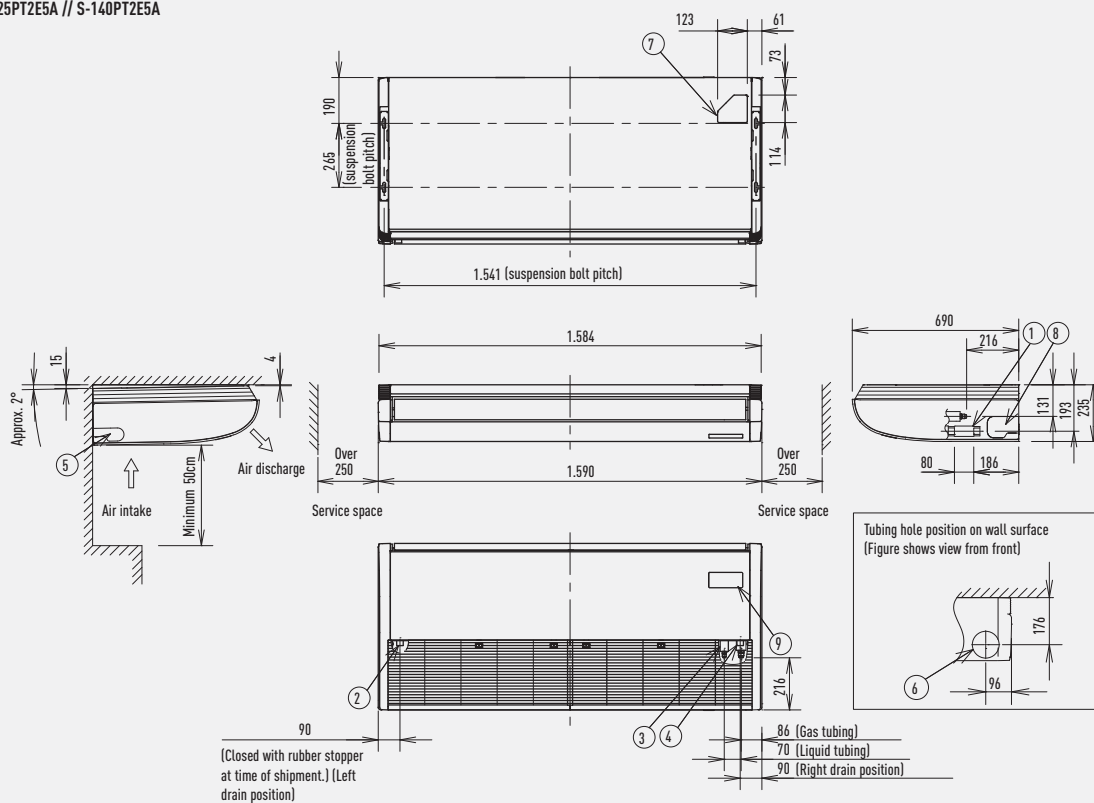

Dimensions: mm

PACi Standard and Elite dimensions

High Static Pressure Hide Away 20,0-25,0 kW

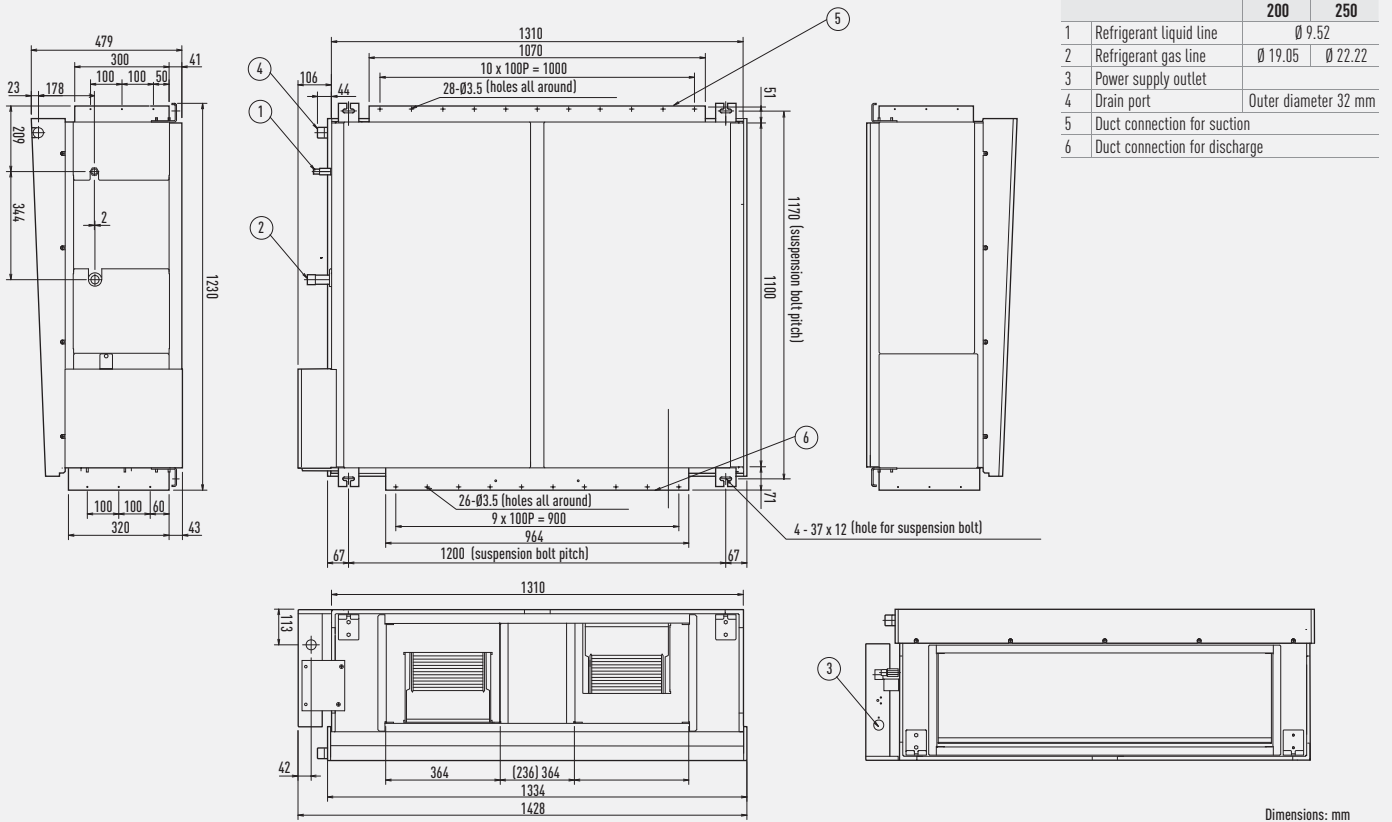

Outdoor Unit PACi Standard 6,0 and 7,1 kW and PACi Elite 5,0 kW

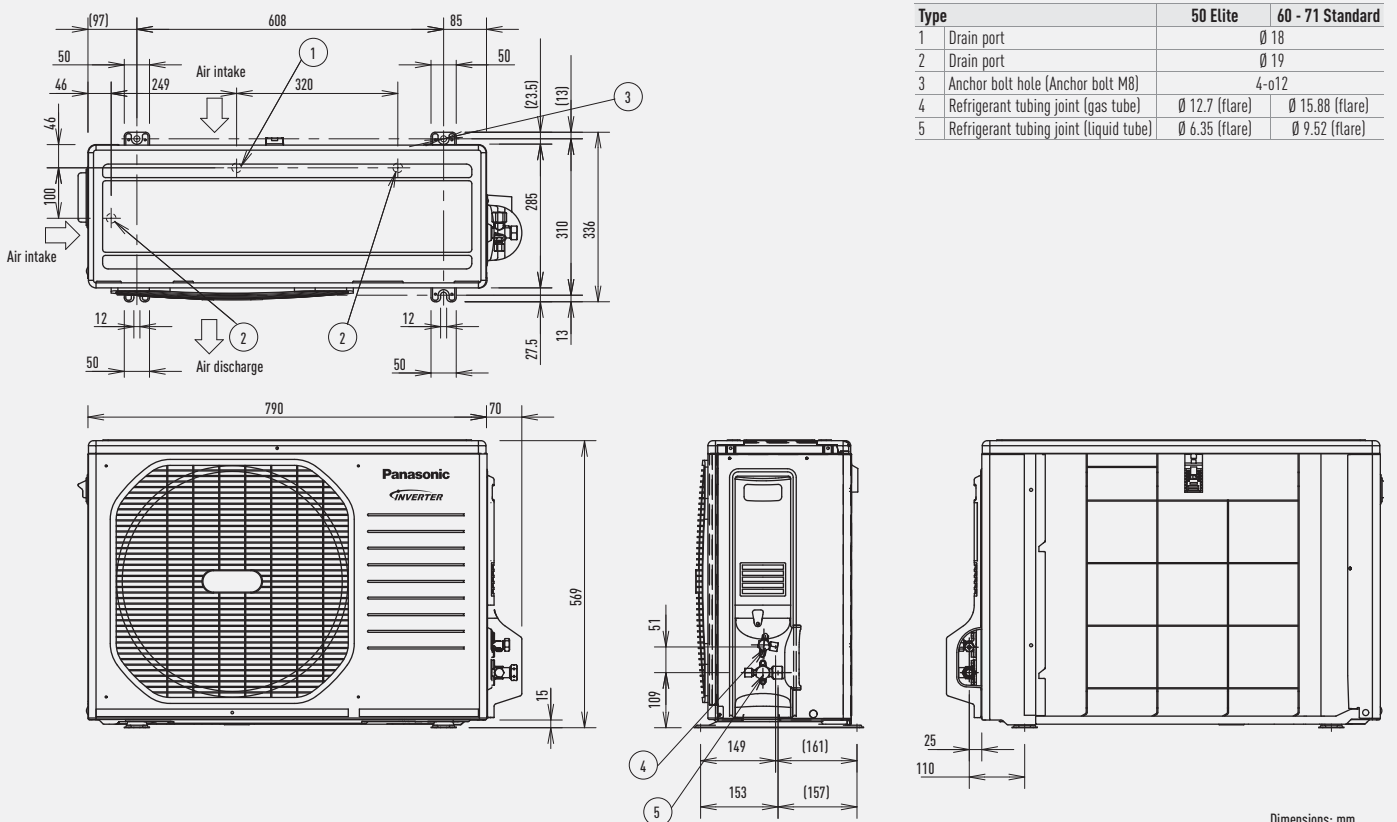

Outdoor unit PACi Standard 10,0 and 12,5 kW and PACi Elite 6,0 and 7,1 kW

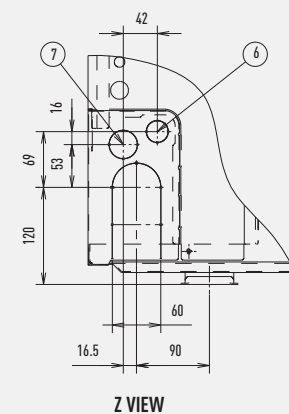
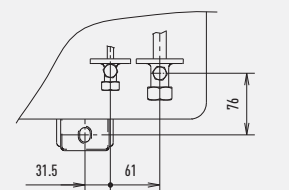
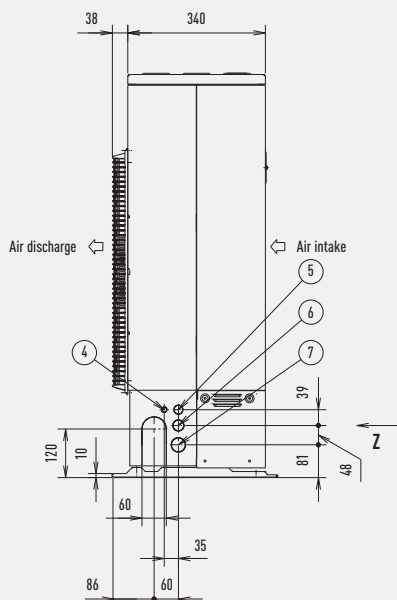
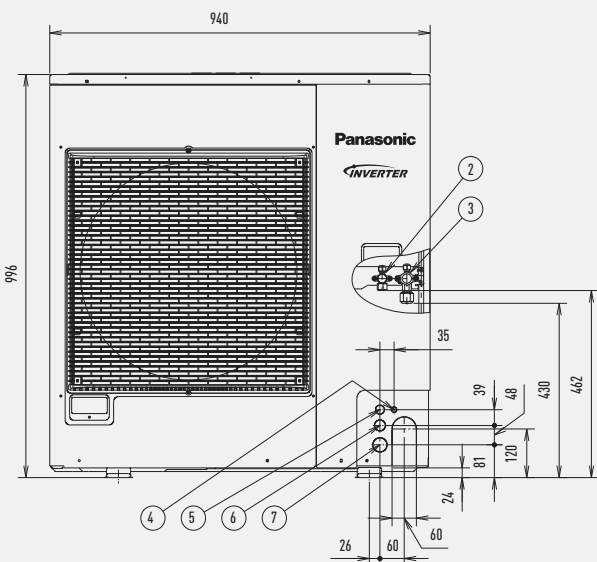
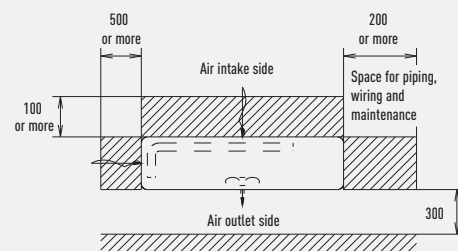
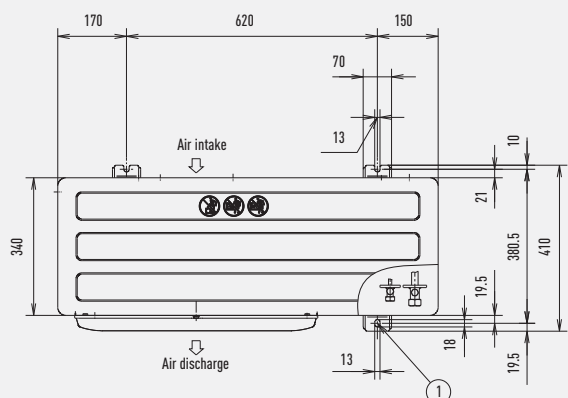

Dimensions: mm

1	Mounting hole (4-R6.5), anchor bolt	M10
2	Refrigerant piping (liquid pipe)	Ø 9.52 (flared)
3	Refrigerant piping (gas pipe)	Ø 15.88 (flared)
4	Electrical wiring port	Ø 13
5	Electrical wiring port	Ø 22
6	Electrical wiring port	Ø 27
7	Electrical wiring port	Ø 35

PACi Standard and Elite dimensions

Outdoor unit PACi Standard 14,0 kW and PACi Elite from 10,0 to 14,0 kW

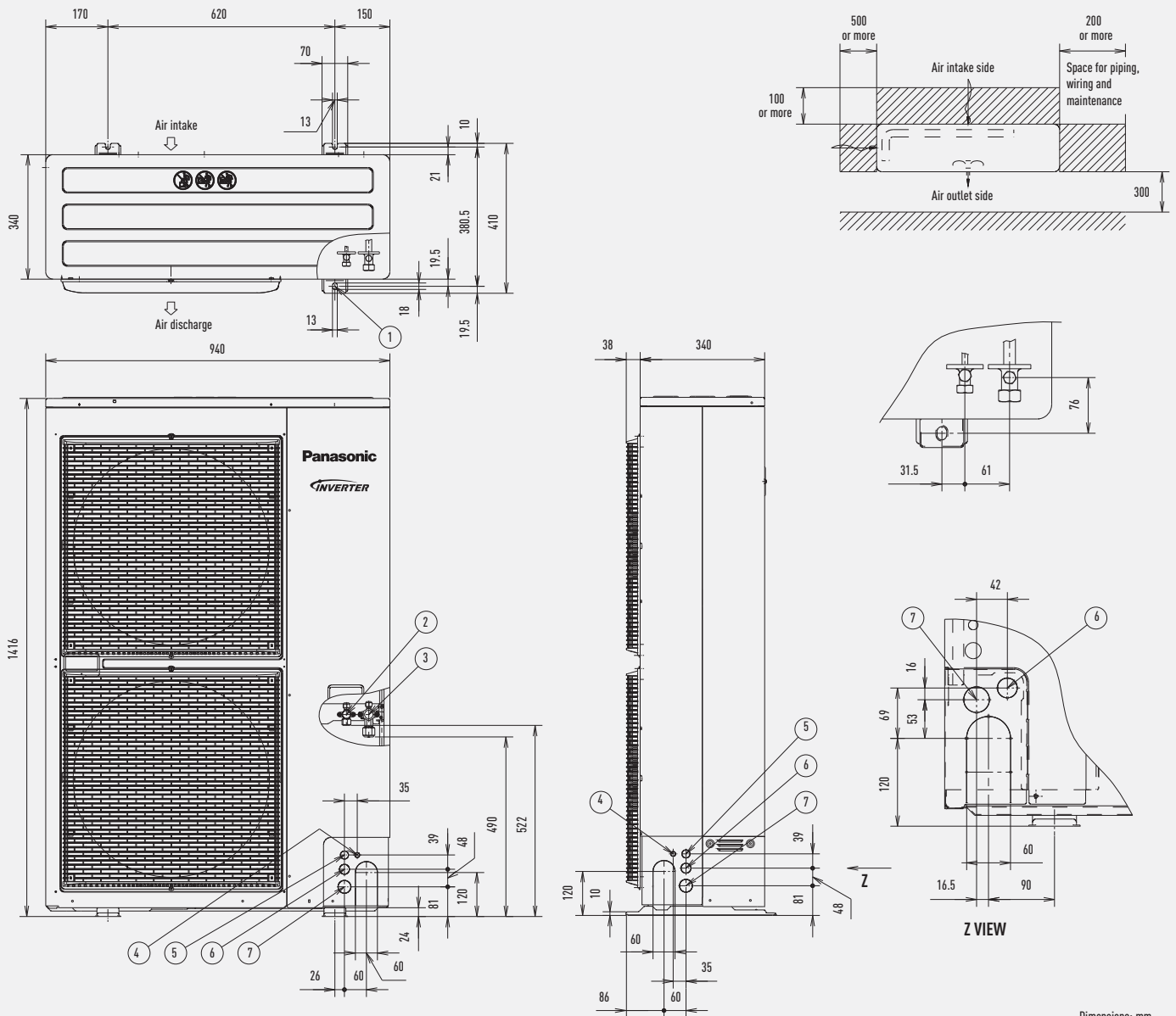

Dimensions: mm

1	Mounting hole (4-R6.5), anchor bolt	M10
2	Refrigerant piping (liquid pipe)	∅ 9.52 (flared)
3	Refrigerant piping (gas pipe)	∅ 15.88 (flared)
4	Electrical wiring port	∅ 13
5	Electrical wiring port	∅ 22
6	Electrical wiring port	∅ 27
7	Electrical wiring port	∅ 35



ECO i

ECO G

VENTILATION



PANASONIC INDUSTRIAL VRF SYSTEMS

Professional solutions for all types of projects

The new Panasonic VRF system is specifically designed for energy saving, easy installation and high efficiency performance, with a wide choice of outdoor and indoor unit models and unique features which are designed for the most demanding offices and big buildings.



Highlighted Features

ECOi VRF Systems

ECOi VRF Systems: 2-Pipe Mini ECOi 6 Series 2-Pipe ECOi 6N Series 3-Pipe ECOi MF2 6N Series. ECOi electrical VRF is specifically designed for the most demanding offices and big buildings. High efficiency system. From 8 to 20 HP in only one chassis. Extended operating range to provide heating at outdoor temperature as low as -25°C . Suitable for refurbishment projects. Example applications: Complexes. High Rise Buildings Commercial Buildings. Hotels.

ECO G VRF Systems

ECO G gas VRF is specially designed for buildings where the electricity is restricted or CO_2 emissions must be reduced. Very high primary energy efficiency ratio. Very low electrical consumption. Compatible with all ECOi indoor units and remote controls. Sanitary hot water is produced freely in summer and winter (outside temperature $>7^{\circ}\text{C}$). Example applications: Complexes. High Rise Buildings. Commercial Buildings. Hotels.

Ventilation VRF Systems

Increase the efficiency of an installation with the use of AHU ventilation, a wide range of air curtains and energy recovery ventilation system.

ENERGY SAVING



The new Cloud system from Panasonic allows you to have complete control of all your installations. In a simple click, all your units from several locations, receive status updates in real-time of all your installations, preventing breakdowns and optimizing costs.



Internet Control is a next generation system providing a user-friendly remote control of air conditioning or heat pump units from everywhere, using a simple Android or iOS smartphone, tablet or PC via internet.



The Inverter range provides greater efficiency, more comfort, more precise temperature control, without highs and lows, and keeps the ambient temperature constant with lower energy consumption and a significant reduction in noise and vibration levels.



GHP technology offers the best in energy efficiency.



The ECOi system works in heating mode at outdoor temperatures down to -25°C (2-Pipe series) or -20°C (3-Pipe series and Mini ECOi).

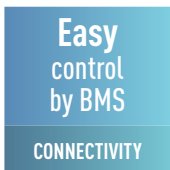

The communication port is integrated into the indoor unit and provides easy connection to, and control of, your Panasonic heat pump to your home or building management system.



R410A. Environmentally friendly refrigerant.



5 Years Warranty. We guarantee the outdoor unit compressors in the entire range for five years. Only for PRO partners.

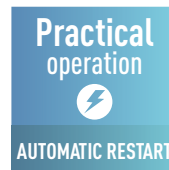

Automatic restart function for power failure. Even when power failure occurs, preset programmed operation can be reactivated once power is resumed.

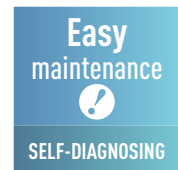

Self-diagnosing function. By using electronic control valves past warnings are stored and can be verified on the liquid crystal display. This makes it easier to diagnose malfunctions, greatly reducing service labour and therefore costs.



Automatic fan operation. Convenient microprocessor control automatically adjusts fan speed to High, Medium or Low, corresponding to room sensor and maintains comfortable airflow throughout the room.



Air Sweep. The air sweep function moves the flap up and down in the air outlet, directing air in a "sweeping" motion around the room and providing comfort in every corner.



Mild dry. By intermittent control of compressor and indoor unit's fan, "New Mild Dry" gives you comfort. It realizes efficient dehumidification according to room temperature.

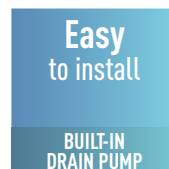

Built-in drain pump. Maximum head 50cm (or 75cm for U type) from the bottom of the unit.



Comfortable auto-flap control. When the unit is first turned on, flap position is automatically adjusted in accordance with the cooling or heating operation. This initial flap position can be preset within a certain range, for both cooling and heating. Auto button is included for continuous movement of flap to vary airflow direction.



Panasonic is definitely the most efficient system throughout the years

And highly adapted to retail, hotels and offices applications

- Super high efficiency at part load conditions.
- Efficient defrost operation.
- Panasonic ECOi operates up to -25°C. This unique feature demonstrate the supremacy of Panasonic ECOi 6N Series.
- The system will still operate up to 25% of the connected indoor units.
- High safety operation in case of breakdown! Ensures heating and cooling.





1. Super high efficiency at part load conditions:

Comparison with competitors: When many others do not declare performance data under 50% part load, Panasonic covers up to 30% part load with extremely high efficiency.

Load %	110 %	100 %	60 %	50 %	40 %	30 %
Other competitors	3.52	3.38	3.45	3.50		
Panasonic VRF 6N Series 32HP Standard	3.38	3.41	4.41	4.69	4.85	4.93
Panasonic VRF 6N Series 32HP HI COP	3.91	3.94	5.14	5.54	6.03	6.51

Conditions: Outdoor temperature 0°C DB, Room temperature 20°C DB.

COP comparison Panasonic Vs Other competitors at different load

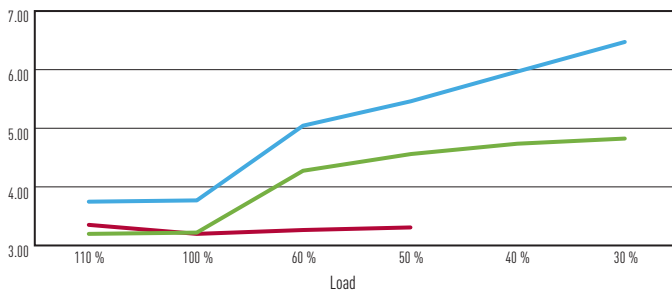

Panasonic VRF 6N Series 32HP HI COP Panasonic VRF 6N Series 32HP Standard Other competitors

Conditions: Outdoor temperature 0°C DB, Room temperature 20°C DB. Data extracted by Panasonic and competitor official technical data book.

2. Efficient defrost operation

Panasonic use the second unit to defrost the first unit. This makes the system more efficient during defrost and does not affect comfort.

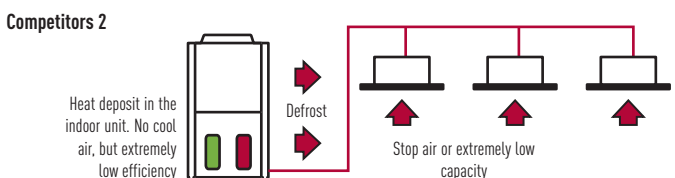
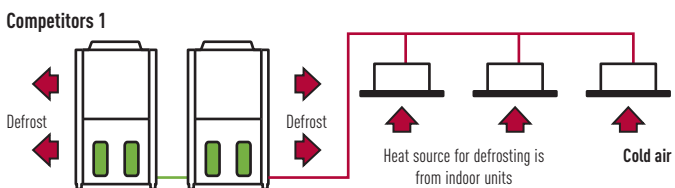
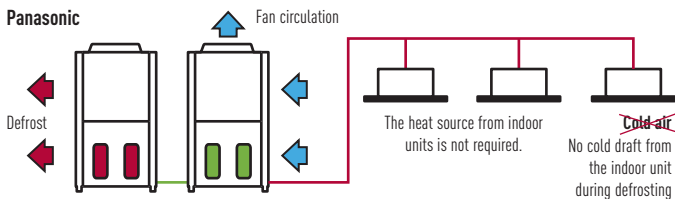

3. Panasonic ECOi operates up to -25°C. This unique feature demonstrate the supremacy of Panasonic ECOi 6N Series

Panasonic use the second unit to defrost the first unit. This makes the system more efficient during defrost and does not affect the comfort.

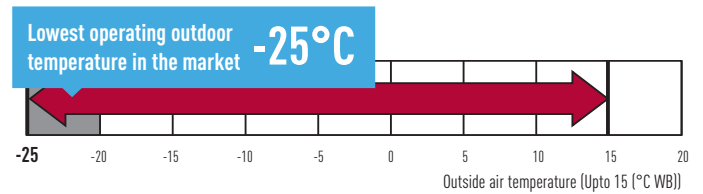

Wide temperature setting range.

4. The system will still operate up to 25% of the connected indoor units

System will not stop when up to 25% of indoor units have power supply breakdown when they are ON Mode.

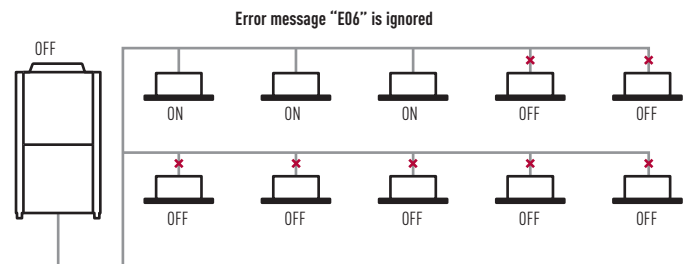

5. High safety operation in case of breakdown! Ensures heating and cooling

AUTOMATIC BACK-UP OPERATION

It is possible for the system to keep working, even if the compressors, fan motor and the temperature sensor are damaged (even when compressor fails in single unit with 2 or more compressor inside).

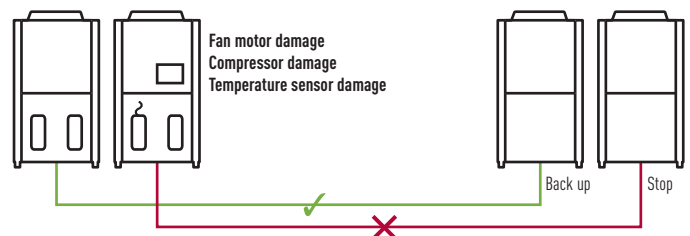



Your entire hotel with maximum savings, maximum control and maximum comfort

Panasonic helps your entire hotel achieve maximum savings, maximum control and maximum comfort. Panasonic offers the widest range in HVAC, DHW and ventilation available. That enables us to offer the most suitable solution to ANY project. And this all with the peace of mind provided by a fast customer service which is available 24 hours a day, 365 days a year. The energy savings provided by our solutions, plus the available choice between electricity and gas, will enable you to reduce your CO₂ emissions. Panasonic solutions not only ensure a higher customer satisfaction but also the peace of mind that the wide Panasonic experience brings about in this field, plus a lower energy bill.



Hydronic units

For obtaining hot and cold water for heating and refrigeration (Aquarea Air radiators, underfloor heating, radiators...)

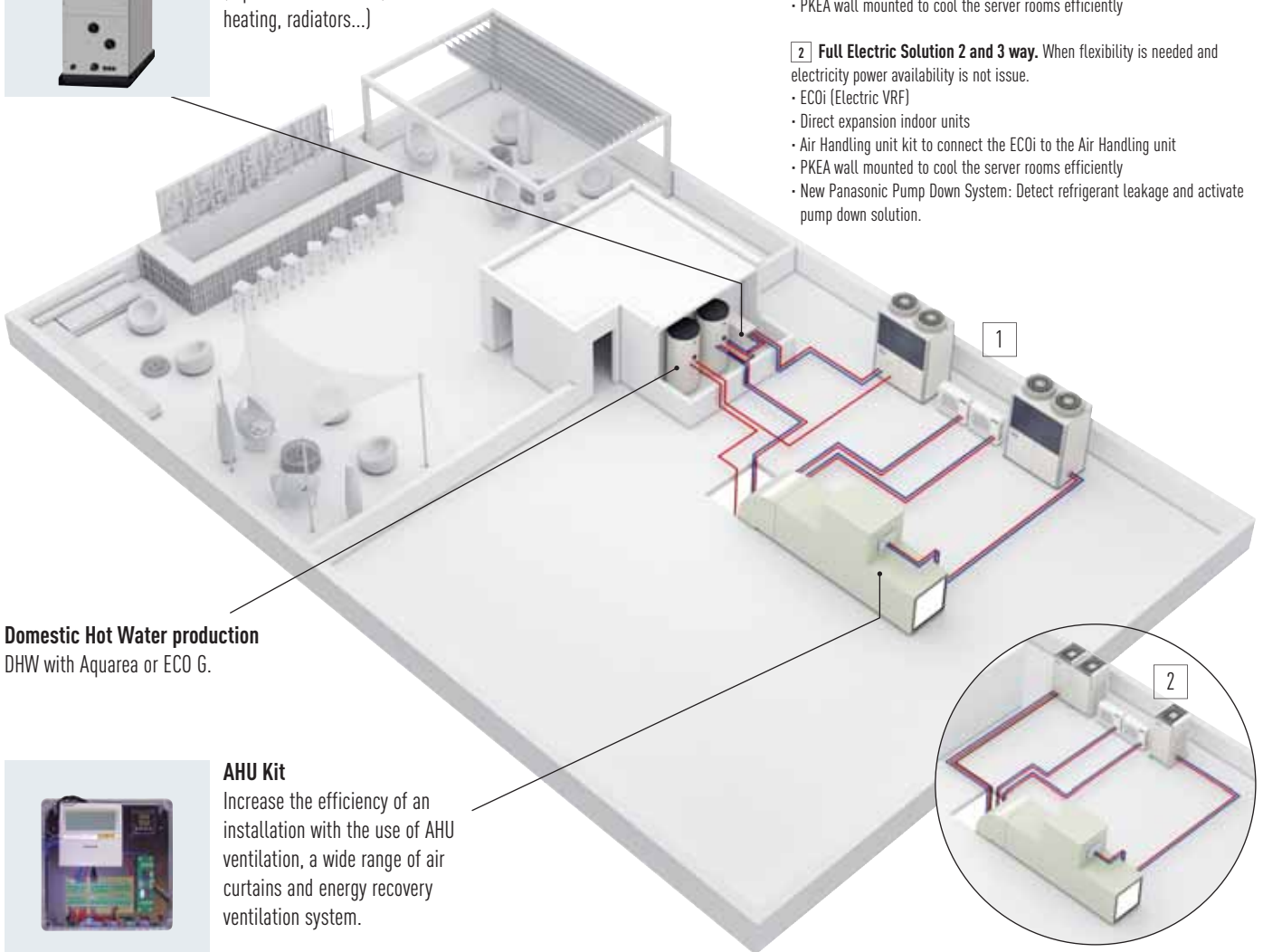

Domestic Hot Water production
DHW with Aquarea or ECO G.



AHU Kit

Increase the efficiency of an installation with the use of AHU ventilation, a wide range of air curtains and energy recovery ventilation system.

1 Hibride Solution

Gas + Electric: When high quantity of hot cold water is needed.

- ECO G (Gas heat pump)
- Water heat exchanger
- Aquarea HT to produce hot water up to 65°C
- Air Handling Unit kit to connect the ECO G to the Air Handling Unit
- PKEA wall mounted to cool the server rooms efficiently

2 Full Electric Solution 2 and 3 way.

When flexibility is needed and electricity power availability is not issue.

- ECOi (Electric VRF)
- Direct expansion indoor units
- Air Handling unit kit to connect the ECOi to the Air Handling unit
- PKEA wall mounted to cool the server rooms efficiently
- New Panasonic Pump Down System: Detect refrigerant leakage and activate pump down solution.

Additional available space
Due to the modularity applied to our systems, our customers have freed space for public use: Terraces, swimming pools, meeting rooms, parkings.

Cutoff valves

When there are plans for future expansion, the installation can be built using the units sized for future expansion requirements.



Wide range of indoor units

Complete range of indoor units that fits any need. All units provided with supply air temperature sensor and low operation sound level to warranty maximum guests comfort. From 1,5kW up to 30kW.



Control your way

Wide variety of controls, from simply user control to remotely full system control. Touch panel, web server, consumption control, smartphone control... everything is possible.

Maximum savings on hot water production

Hot water for swimming pool, spa and laundry for free thanks to the residual heat generated by the ECO G units.

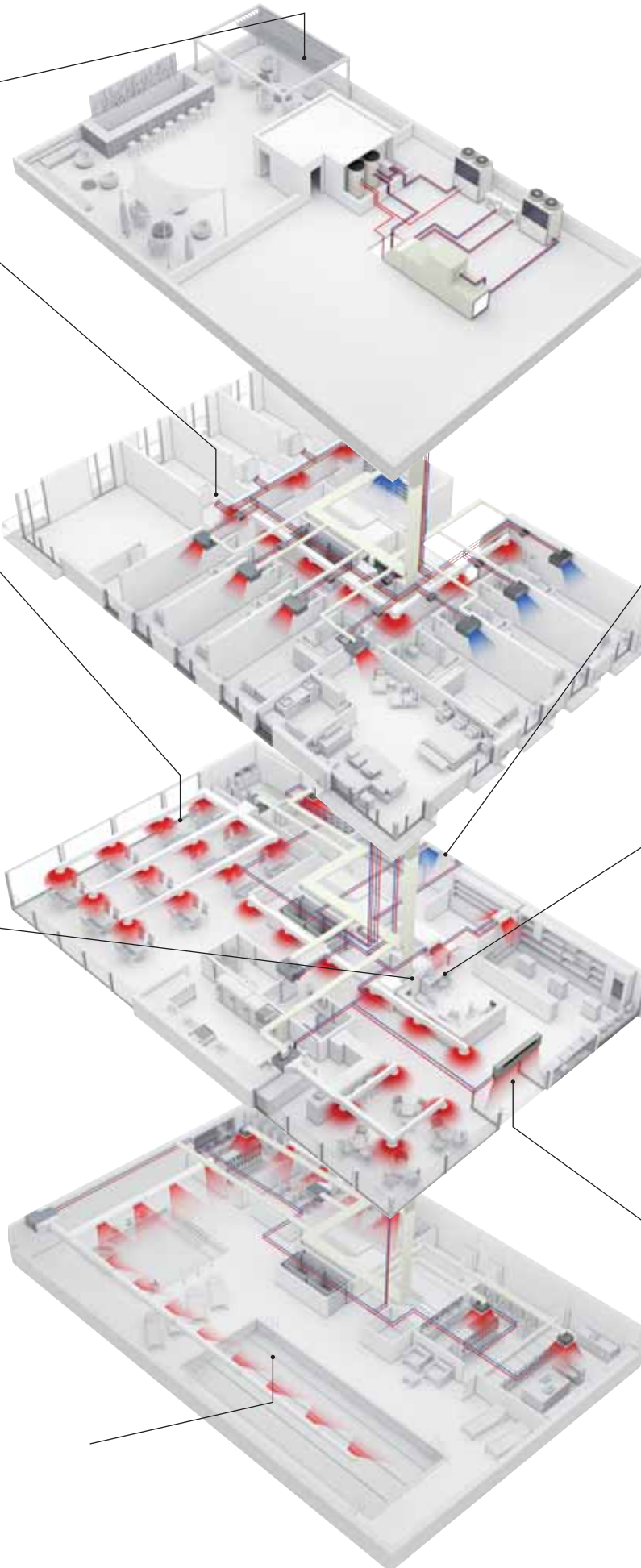

PKEA indoor unit for server room

Steady cooling, nonstop, even at -20°C and still with high efficiency. Ready for continuous operation and easily to connect 2 systems to automatically alternate and smartly keep cooling server room with maximum warranties.



Protocol friendly

Great flexibility for integration into your KNX / EnOcean / Modbus / LonWorks / BACnet projects allows fully bi-directional monitoring and control of all the functioning parameters. Range of solutions to control locally or remotely the full system in bi-directional.



Air Curtain with DX Coil

The Panasonic range of air curtains is designed for smooth operation and efficient performance.



Innovative solutions for retail

Heating and cooling solutions for retail applications

Panasonic has developed solutions for retail applications and offices applications where return on investment is a key factor! The comfort inside the shop is key for a good customer experience in the shop.

From local control or from Panasonic new cloud control system, a detail status of the heating and cooling system can be displayed, analysed and optimized in order to improve the efficiency, reduce the running time and increase the life time of the units.

8 reason why Panasonic is the best solution for your Retail:

1. Complete solution
2. Flexibility and adaptation
3. Go green retail: lowest CO₂ emissions
4. Comfort - maximum satisfaction
5. Future expansion
6. Panasonic is definitely the most efficient system over the years
7. High quality of service with Panasonic pro-partner installation team
8. The system will still operate up to 25% of the connected indoor units.
System will not stop when up to 25% of indoor units have power supply breakdown when they are on mode



Web Interface Device
(remote access from internet)



System Controller
(local access)



4 Way 90x90 Cassette
360°, power and
silence



PKEA Wall Mounted
indoor unit for server
room applications



Air Handling unit kit
connected to the ECOi
and PACi system.



Energy Recovery unit
connected to the ECOi
system for high
efficiency of the
system



Hide Away indoor unit
for, powerful and
efficient



Super efficient Air
Curtain with DX Coil,
connected to the ECOi
or PACi system

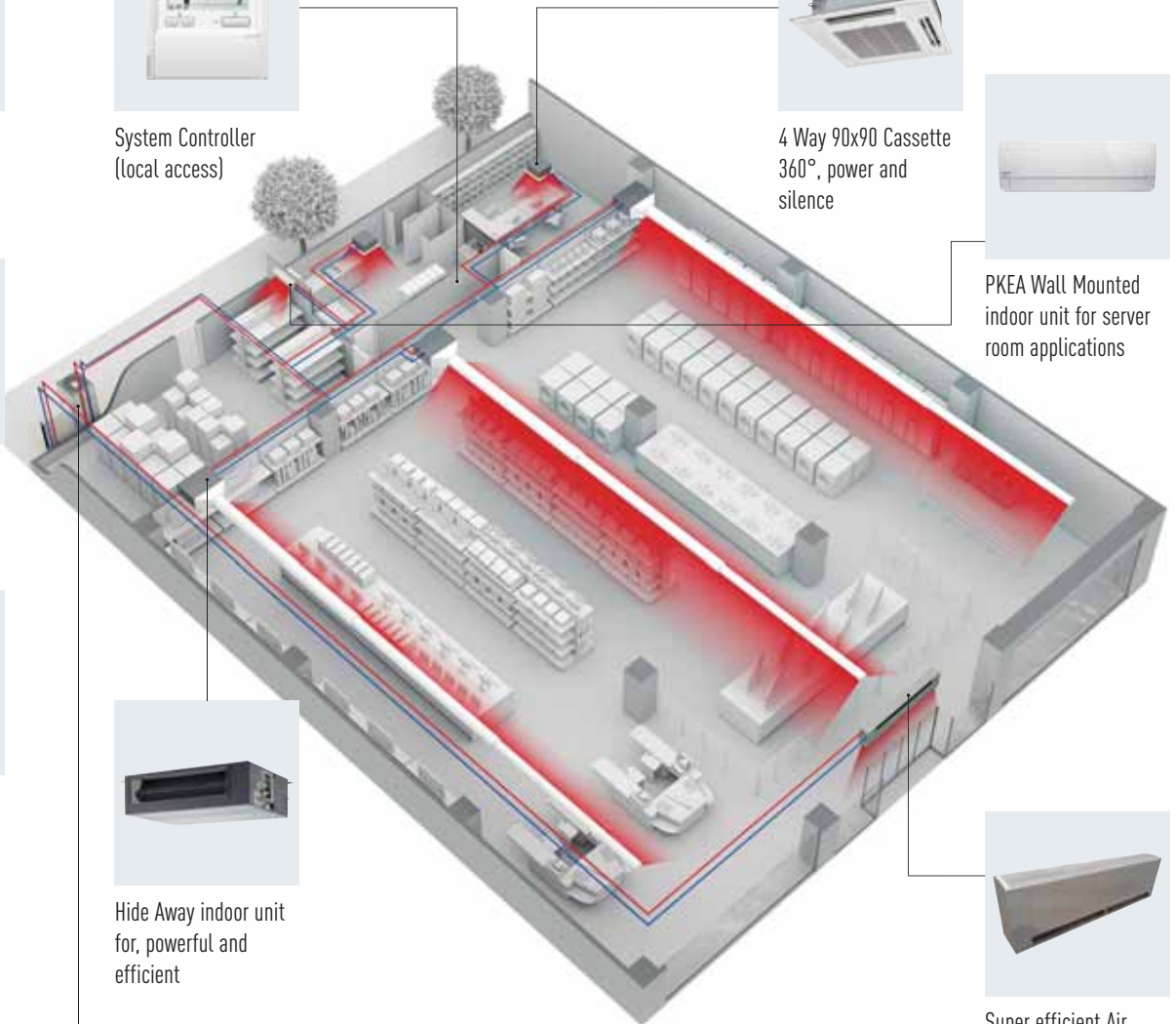

Multi energy solutions, gas or electrical



Gas VRF

ECO G



Electrical VRF

ECOi



Mini ECOi



Electrical 1x1

PACi



Electrical A2W

Aquarea

The Multi energy solution (Gas and Electric) from Panasonic to gives the best of the energy saving and on the flexibility of the installation. Panasonic solutions can be connect to direct expansion systems, water chiller installations and ventilation systems as air handling units.



Leak Detection and Automatic Refrigerant Pump down

Improving Safety and the Environment

Panasonic has developed an innovative solution to detect refrigerant leaks that offer complete assurance and protection for end users, building occupiers and the environment. Panasonic's Pump Down System is ideal for hotels, offices and public buildings where safety for occupants and the building owners is of utmost importance.

The system monitors refrigerant leakage continually and provides a warning before refrigerant leaks, preventing major refrigerant loss and potentially damaging the system's efficiency. The new system can improve potential refrigerant loss to approximately 90%.

As well as ensuring safe and reliable operation, Panasonic's Pump Down System contributes to a building qualifying for additional BREEAM points and enables compliance with current EN378 2008 standards, covering applications where refrigeration concentration levels exceed practical safety limits of 0.44 kg/m³.

Panasonic has developed two detection methods that can operate simultaneously to offer complete protection for owners, building occupiers and the environment.

Pump down system

This innovative pump down system can be connected in two ways:

- With sensor leakage
- Without sensor leakage, using only the innovative algorithm.

Basic pump down function:

- Detect the leakage
- Activate pump down process
- Collect the gas on the tank
- Close the valves to isolate the gas

Key points:

- Comply with legislation
- Protect personnel
- Protect the environment
- Save on operating costs



Panasonic offers a purposely engineered solution which allows for a quick and simple installation. The unit contains 5 actuating ball valves, a 30l storage vessel and PLC all housed in an IP54 rated container. Terminals on the front of the unit allow for easy wiring to the alarm terminal, high / low pressure transducers and discharge temperature sensor(s) of the condensing unit(s).

Direct Leak Detection Method: The Safest Solution for Small Rooms

This option should be implemented in any area in non-compliance with BS EN 378:2008. The leak detector is connected directly to the indoor unit via the dedicated PAW-EXCT connector and the Pump Down System is directly connected to the outdoor unit PCB.

The Pump Down System will activate when a leak is detected in the room and initiate a refrigerant reclaim operation immediately, the refrigerant will be collected inside the outdoor units' heat exchanger and optional receiver tank for larger systems. This immediate reaction and large refrigerant storage capacity offers very high level of safety for end users, building occupiers as well as being environmentally friendly.

Due to the exclusive ECOi software the leak detection sensors are able to communicate directly via the P-link which means no additional communication panels, cabling or software is required.

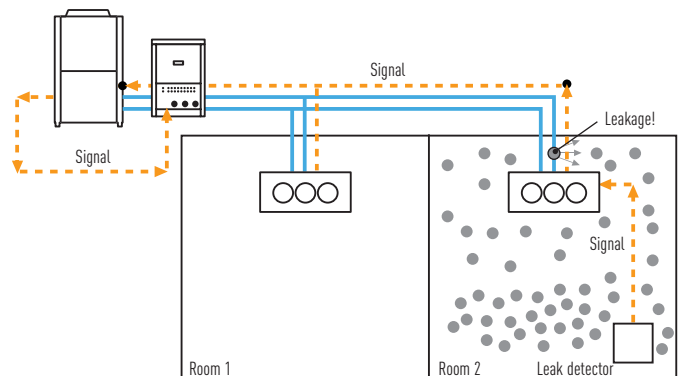

In-Direct Leak Detection Method: Unique PLC Algorithm to Determine Refrigerant Leakage

Pressure and temperature sensors constantly monitor the low / high pressure and discharge of the condensing unit to protect against potential leakage in areas not covered by leak detectors. If low pressure decreases and compressor discharge temperature increases at pre-defined values according to a pre-set algorithm then the unit will trigger a pump down sequence. The new innovative algorithm is able to detect leakage of R410A based on abnormal changes in the following conditions, high pressure, low pressure and compressor discharge temperature.

Once initiated via either direct or in-direct detection, the unit will immediately close the liquid / discharge actuating ball valves close the alarm terminals on the Pump Down PCB allowing an alarm to be raised at any nominated location.

Reclaim of the refrigerant is via the suction line to the heat exchanger(s) of the outdoor unit(s), any surplus refrigerant is collected in the 30l receiver tank. Once fully pumped down the suction line is closed and the unit awaits a 'Reset' and 'Recharge' command.

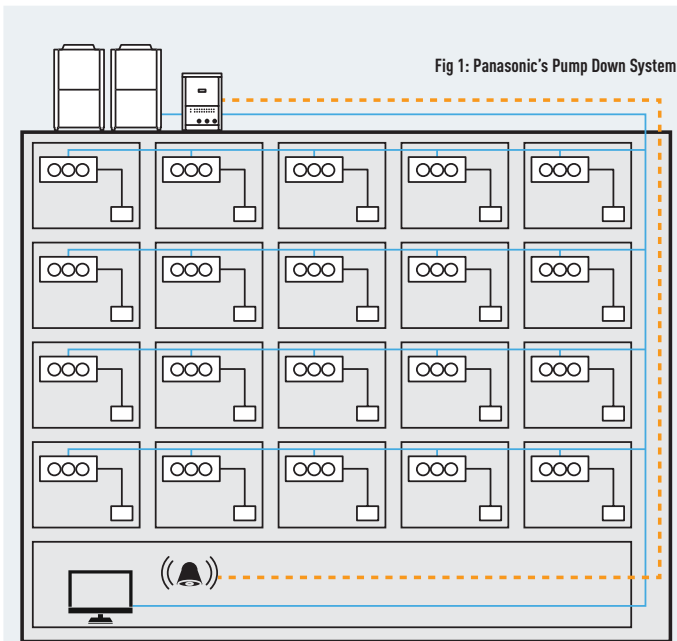

Fig 1: Panasonic's Pump Down System

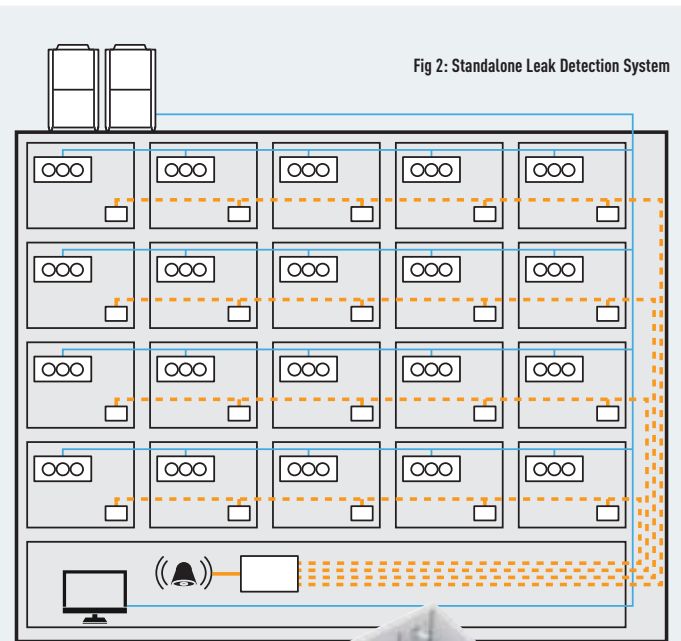
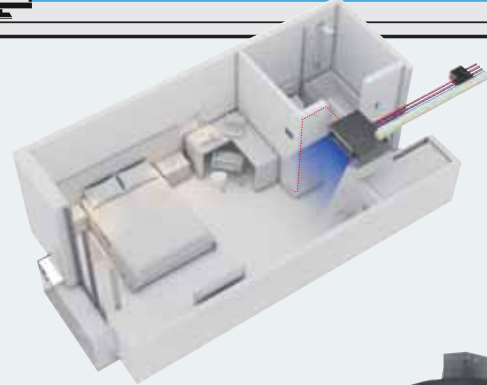

Fig 2: Standalone Leak Detection System

Due to the simplistic installation and control interfacing, shown in Fig 1, Panasonic's ECOi Pump Down System can provide dramatic reduction in capital cost and installation time when compared to a standalone leak detection system, shown in Fig 2. This option is ideal for hotels, offices and public buildings where safety of building occupiers is a must and is extremely cost effective, savings of 40% can be easily achieved.



Pump Down system in case of leakage

Number of outdoor units	2-Pipe without receiver	2-Pipe with receiver	3-Pipe without receiver	3-Pipe with receiver
1	✓	✓	✓	✓
2	✓	✓	✓	✓
3	✓	✓	✓	✓

ECOi System	Model code	Description
ECOi 2 Way	PAW-PUDME1A-1	Pump down for 1 outdoor unit system
	PAW-PUDME1A-2	Pump down for 2 outdoor units system
	PAW-PUDME1A-3	Pump down for 3 outdoor units system
ECOi 3 Way	PAW-PUDMF2A-1	Pump down for 1 outdoor unit system
	PAW-PUDMF2A-2	Pump down for 2 outdoor units system
	PAW-PUDMF2A-3	Pump down for 3 outdoor units system
ECOi 2 Way	PAW-PUDME1A-1R	Pump down for 1 outdoor unit system + Receiver Kit 30l
	PAW-PUDME1A-2R	Pump down for 2 outdoor units system + Receiver Kit 30l
	PAW-PUDME1A-3R	Pump down for 3 outdoor units system + Receiver Kit 30l
ECOi 3 Way	PAW-PUDMF2A-1R	Pump down for 1 outdoor unit system + Receiver Kit 30l
	PAW-PUDMF2A-2R	Pump down for 2 outdoor units system + Receiver Kit 30l
	PAW-PUDMF2A-3R	Pump down for 3 outdoor units system + Receiver Kit 30l
Accessory (common)	PAW-PUDRK30L	Receiver Kit 30l
Leak detectors	PAW-SCLEAKD-S01	Stainless Steel Face Semi Conductor Leak Detector
	PAW-SCLEAKD-W01	White Face Semi Conductor Leak Detector

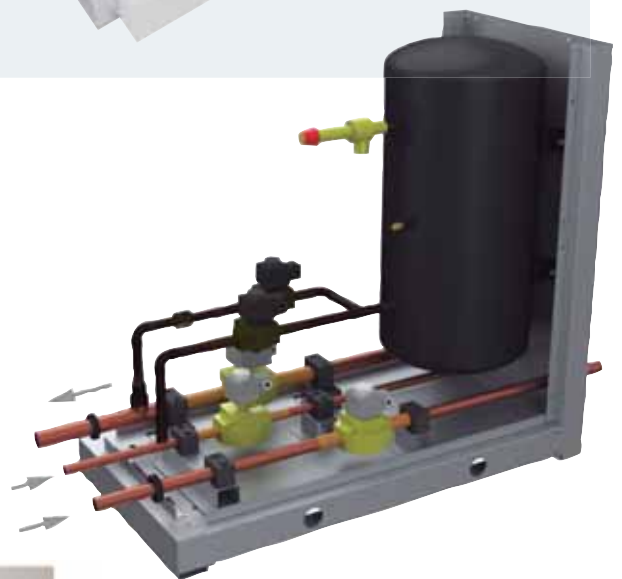

Leak detectors



Best efficiency ECOi series from Panasonic

Lower running and life cycle costs

Panasonic ECOi 6N systems are amongst the most efficient VRF systems on the market, offering COPs in excess of 4.0 at full load conditions. The system is also designed to make sure that we reduce the running cost of each system by using our unique road map control routine to ensure that the most efficient combination of compressors are running at any one time. Improved defrost sequencing also reduces running costs by defrosting each outdoor coil in turn when conditions allow.

The range of outdoor unit modules consists of 7 models from 8 HP to 20 HP. The module sizes from 14 HP to 20 HP can be configured for HI-COP.

Standard mode offers the highest capacity while still delivering excellent efficiency, while HI-COP mode delivers exceptional efficiency and low running costs with a slight reduction in capacity.

Up to 64 indoor units can be connected up to a capacity of 200% indexed indoor unit loads, enabling the system to be used effectively on highly diversified building loads: this large connectability feature makes it an easy-to-design solution for schools, hotels, hospitals and other large buildings. Up to 1,000 m in pipe length enables the New VRF ECOi 6N series to be used in very large buildings, with maximum design flexibility.

The ECOi 6N system is also easy to control. It has more than 8 types of control from standard wired remote controls to touch screen panels or web access interfaces.

DC-inverter control technology for rapid and powerful cooling & heating.

The ever-evolving Panasonic ECOi 6N series

The ECOi 6N series is designed for energy savings, easy installation, and high efficiency. Always continuing to evolve, Panasonic uses advanced technologies to meet the requirements of diverse situations and contribute to the creation of comfortable living spaces.

Mini ECOi 6 Series

Panasonic's policy of product development continues with the expansion of the Mini ECOi 6 Series, the 2-Pipe heat pump small VRF system specifically designed for the European market.



2-Pipe ECOi 6N Series

The 2-Pipe ECOi 6N series is specifically designed for energy saving, easy installation and high efficiency performance as its main focus.



3-Pipe ECOi MF2 6N Series

ECOi 3-Pipe is one of the most advanced VRF systems available. Not only offering high-efficiency and performance for simultaneous heating and cooling, its sophisticated design makes installation and maintenance much easier.



* At full load

ECOi 6N Series benefits

Ease of installation

R410A has a higher operating pressure with a lower pressure loss than previous refrigerants. This enables smaller pipe sizes to be used and allows reduced refrigerant charges.

Simple to design

Panasonic recognise that designing, selecting and preparing a professional VRF quotation can be a time consuming and costly process, especially as it is often also a speculative exercise. So we have designed proprietary software which is quick and easy to use and produces a full schematic layout of pipework and controls, as well as a full materials list and performance data.

Easy to control

A wide variety of control options are available to ensure that the ECOi 6N system provides the user with the degree of control that they desire, from simple room controllers through to state of the art BMS controls.

Simple to commission

Simple set-up procedure including automatic addressing of connected indoor units. Configuration settings can be made from an outdoor unit or via a remote controller.

Accurate capacity control

To ensure that the compressor capacity is matched to building load as accurately and efficiently as possible, Panasonic has designed its range of 2 and 3-Pipe ECOi systems to operate with DC inverter and high-efficiency fixed speed compressors. The system selects the most efficient compressor to operate by dynamically monitoring the building load and choosing the best compressor combination to run.

Easy to position

The compact design of the ECOi 6N outdoor units means that sizes 8 HP to 12 HP fit into a standard lift and are easy to handle and position when on site. The small footprint and modular appearance of the units ensure a cohesive appearance to an installation.

Off-coil temperature control

Panasonic ducted units offer the unique advantage of being able to offer OFF coil temperature control as standard. This allows designers to select units using an OFF coil temperature between 2°C and 22°C. This allows room environments to be cooled without subjecting its occupants to cold drafts or uncomfortable conditions. This is achieved without any extra controls or wiring to each unit.

Wide selection and connectivity

With 11 indoor model styles available, ECOi 6N systems are the ideal choice for multiple small capacity indoor unit installations, with the ability to connect up to 40 indoor units to systems of 24 HP or greater for 3-Pipe ECOi MF2 6N Series.

Easy to maintain

Each system allows the use of prognostic and diagnostic controls routines, from refrigerant charge control through to complex fault code diagnostics, all designed to reduce the speed of maintenance calls and unit down time.

Lower running and life cycle costs

Panasonic ECOi 6N systems are amongst the most efficient VRF systems on the market. The system is also designed to make sure that we reduce the running cost of each system by using our unique road map control routine to ensure that the most efficient combination of compressors are running at any one time. Improved defrost sequencing also reduces running costs by defrosting each outdoor coil in turn when conditions allow.

ECOi 6N 2-Pipe with Water Heat Exchanger for chilled and hot water production

For hydronic applications.





2-Pipe Mini ECOi LE1 Series

Cooling and Heating type Single Phase
Cooling and Heating type Three Phase

For small-scale commercial and residential use

Panasonic 2-Pipe Mini ECOi, the 2-pipe heat pump is specifically designed for the most demanding applications. Mini ECOi is available in 3 sizes with cooling capacities ranging from 12.1 kW to 15.5 kW and connectable up to 9 indoor units (applicable for 15.5 kW).

An expansion from the Panasonic VRF line up, the Mini ECOi is compatible with the same indoor units and controls as the rest of the ECOi range.



Energy saving

Environmentally friendly refrigerant
 R410A

Down to -20 °C in heating mode
 OUTDOOR TEMPERATURE

5 year compressor warranty



Energy saving concept

The energy saving designs for the structure of fans, fan motors, compressors and heat exchangers has resulted in high COP values, which rank as one of the top classed in the industry. In addition, use of highly efficient R410A refrigerant reduces CO₂ emission and lowers operating costs.

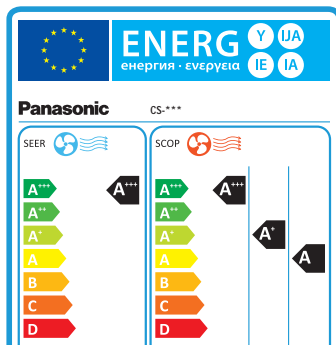

All Mini ECOi VRF systems are rated as EEL Category A, which confirms that they are amongst the most energy efficient systems available. Power consumption during operation is substantially less than that of lower rated units and consequently both the day to day running costs and full life cycle costs are significantly reduced.

Improved energy saving

The operation efficiency has been improved using highly efficient R410A refrigerant, new DC inverter compressor, new DC motor and new design of heat exchanger.

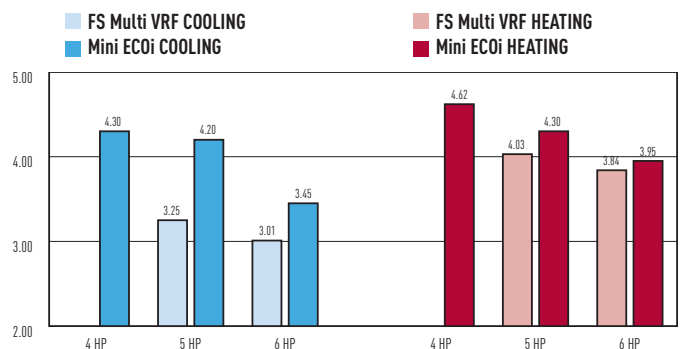

2-Pipe Mini ECOi LE1 Series

Drastically reduced sound level

The pressure sound level has been reduced drastically thanks to the new DC Inverter compressor, newly designed heat exchanger and Fan.

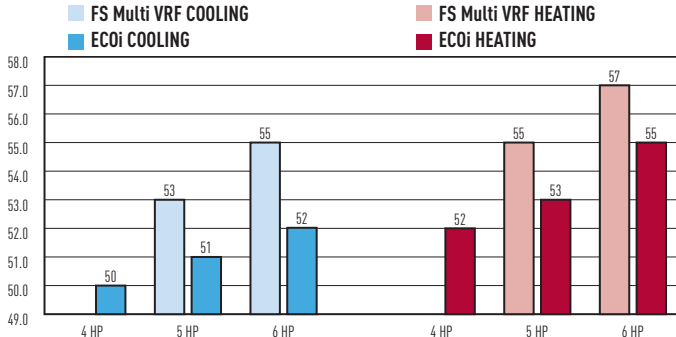

Wide operating range

The operating range for heating operation is to -20°C, the cooling range is to -10°C. The remote controller temperature setting offers a range from 16°C to 30°C.

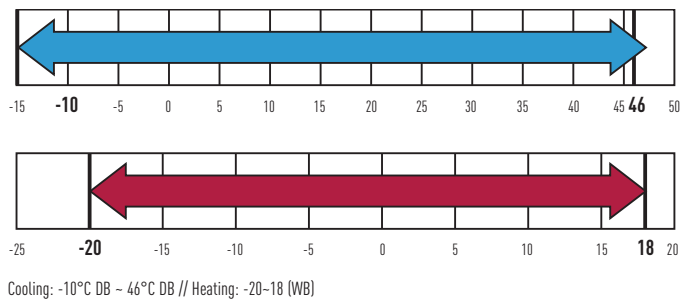

Lightweight

In case of 5/6 HP, the weight has been reduced from 123 kg into 104 kg.



Increased piping length for Greater design flexibility

Adaptable to various building types and sizes.

Actual piping length: 120 m (equivalent piping length 140 m).

Maximum piping length: 150 m.

Maximum total length: 150 m

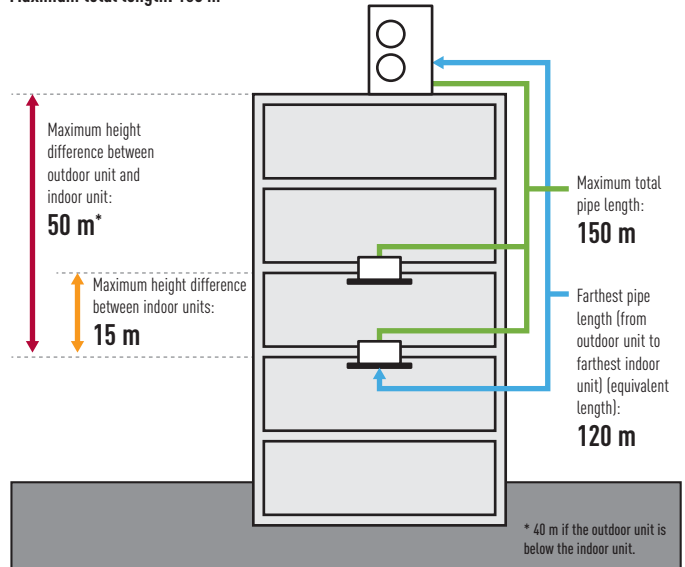

Silent mode

3 dB can be reduced by setting. External input signal is also available.

Up to 9 indoor units per system

System / HP	4 HP	5 HP	6 HP
Connectable Indoor Unit	6	8	9

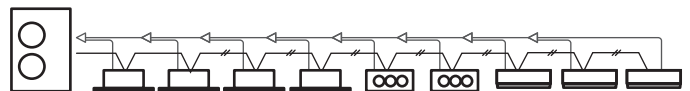

Compact & Flexibility-design

The slim and lightweight design can be installed in various small spaces.

For balconies

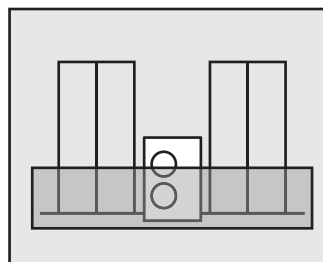

For narrow spaces

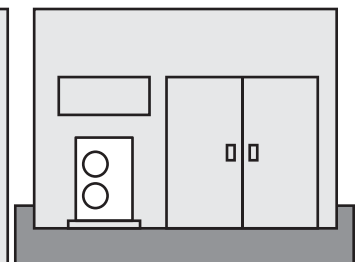

Mini ECOi

- 1 Inverter compressor. Large-capacity inverter compressor has been adopted. The inverter compressor is superior in performance with improved partial-load capacity.
- 2 Printed Circuit Board. PCBs have been reduced to two, to improve maintenance.
- 3 Accumulator. Larger accumulator has been adopted to maintain compressor reliability and because of the increased refrigerant quantity, extended maximum piping length can be achieved. Furthermore, the refrigerant pressure loss was reduced, which contributes to an improved operating efficiency.
- 4 DC Fan motor. Checking load and outside temperature, the DC motor is controlled for optimum air volume.
- 5 Newly designed Big Edgy Fan. The newly designed Fan edge has been realized to inhibit air turbulent and to increase efficiency. As Fan diameter has been sized up to 490mm, the air volume has been increased by 12% keeping low sound level.
- 6 Heat exchanger & copper tubes. The heat exchanger size and the copper tube sizes in the heat exchanger has been redesigned to increase efficiency.
- 7 Oil separator. New centrifugal separator has been adopted to improve oil separation efficiency and reduce refrigerant pressure loss.

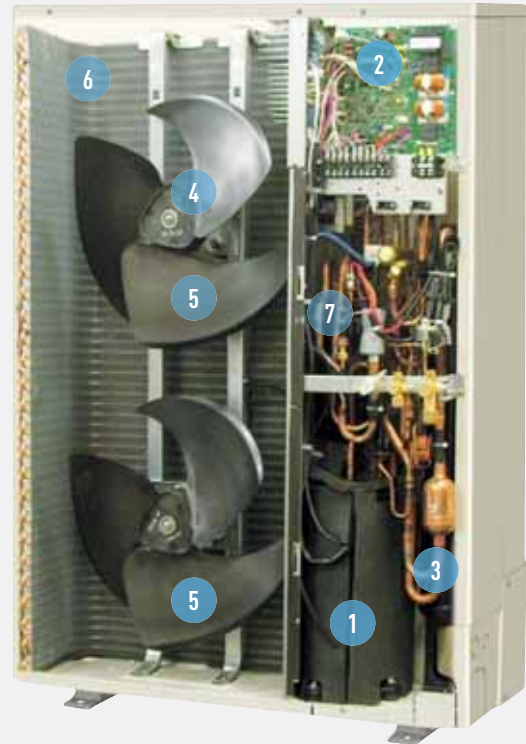

Demand control Kit information

		Mini ECOi	ECOi 6N	ECO G	PACi
CZ-CAPDC2	Seri-Para I/O unit for outdoor unit	Yes	Yes	Yes	Yes
CZ-CAPDC3	Demand Control Kit	Yes	Yes	Yes	Yes

Function of Demand control

This function limits the maximum operating input at peak time. 3 levels as 100%/70%/0% is set at the factory¹.

The limit value setting for level 1 & 2 can be changed from 40% ~ 100% by 5% at the system commissioning.

1. The 3rd level is available only for CZ-CAPDC3 & CZ-CAPDC4.)

	Power input level (vs. rated condition)	
Level 1	100% (at ship)	From 40%-100% setting can be changed (by 5% step)
Level 2	70% (at ship)	
Level 3	0% (Forcible thermo-OFF)	

OPERATING IMAGE

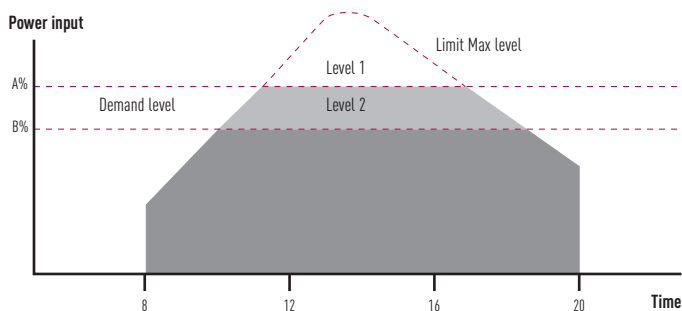

CZ-CAPDC2

Demand control input signals sent to this outdoor interface will be transferred to the system via inter-unit control wiring. Other controls (ex. Operation ON/OFF, Mode switch Cool/Heat) are also available. Demand level 1 & 2 are available. Up to 4 systems can be connected and controlled independently or all together by one interface.

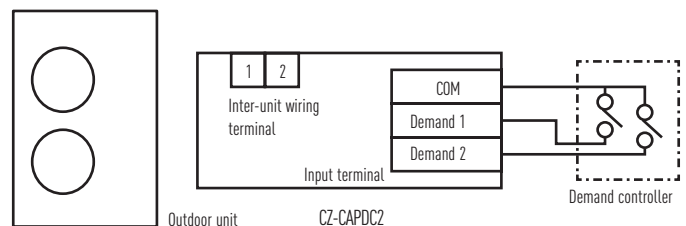

CZ-CAPDC3 for PACi and Mini ECOi

Optional terminal block kit for demand control to be mounted in the outdoor unit. Via this interface, the demand control signals go directly to the outdoor unit control PCB. 3 control levels are available.

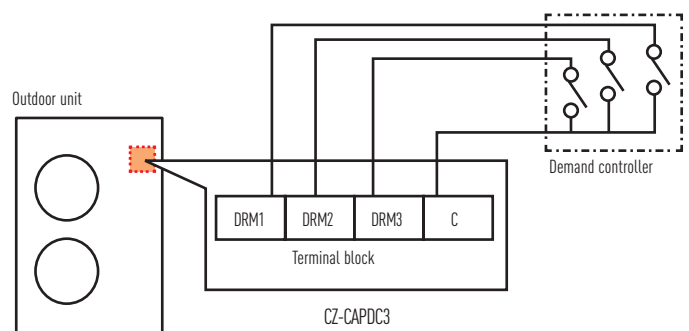

Only for 6N series ECO-i outdoor unit, "Regular Demand control" setting is available. (The system will be limited the maximum input level for all the time without any signal input.) (The setting to be done at the time of system start-up or service by maintenance remote controller.)

MINI ECOi HIGH EFFICIENCY

For light commercial use

Panasonic's Mini ECOi, the 2-Pipe heat pump small VRF system, is specifically designed for the most demanding applications. Offering between 12,1 kW and 15,5 kW cooling capacity in 3 sizes and up to 9 indoor units connected, the Mini ECOi sets standards of performance and flexibility.

Utilising R410A and DC inverter technology, Panasonic offers VRF to a new and growing market.

Forming a new key part of the Panasonic VRF line up, the Mini ECOi is compatible with the same indoor units and controls as the rest of the ECOi range.

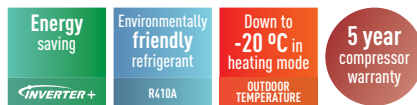

5 YEARS COMPRESSOR WARRANTY. Only for PRO partners.

HP		4 HP						5 HP						6 HP								
Model		U-4LE1E5			U-4LE1E8			U-5LE1E5			U-5LE1E8			U-6LE1E5			U-6LE1E8					
Power supply		V			220 230 240			380 400 415			220 230 240			380 400 415			220 230 240			380 400 415		
		Single Phase / 50Hz			Three Phase / 50Hz			Single Phase / 50Hz			Three Phase / 50Hz			Single Phase / 50Hz			Three Phase / 50Hz					
Cooling capacity	Nominal	kW			12.1			12.1			14.0			14.0			15.5			15.5		
EER ¹⁾	Nominal	W/W			4.30			4.30			4.20			4.20			3.45			3.45		
Running amperes	A	13.9	13.3	12.7	4.9	4.7	4.5	16.3	15.6	14.9	5.7	5.4	5.2	21.5	20.5	19.7	7.5	7.1	6.9			
Power input cooling	Nominal	kW			2.81			3.33			3.33			4.49			4.49					
Heating capacity	Nominal	kW			12.5			16.0			16.0			18.0			18.0					
COP ¹⁾	Nominal	W/W			4.62			4.30			4.30			3.95			3.95					
Running amperes	A	13.2	12.7	12.1	4.7	4.5	4.3	18.0	17.2	16.5	6.3	6.0	5.8	21.6	20.7	19.8	7.5	7.2	6.9			
Power input heating	Nominal	kW			2.71			3.72			3.72			4.56			4.56					
Starting amperes	A	1	1	1	1	1	1	1	1	1	1	1	1	1	1	1	1	1	1			
Maximum amperes	A	21.0	21.0	21.0	8.5	8.5	8.5	24.5	24.5	24.5	10.0	10.0	10.0	28.0	28.0	28.0	12.0	12.0	12.0			
Maximum power input	kW	4.44	4.64	4.84	5.15	5.42	5.62	5.17	5.41	5.64	6.06	6.37	6.61	5.91	6.18	6.45	7.27	7.65	7.94			
Maximum number of connectable indoor units		6			6			8			8			9			9					
Air volume	Cooling / Heating	m ³ /min			95			95			104			104			104					
Sound pressure level	Cooling (Hi / Lo)	dB(A)			50 / 47			50 / 47			51 / 48			51 / 48			52 / 49			52 / 49		
	Heating (Hi / Lo)	dB(A)			52 / 49			52 / 49			53 / 50			53 / 50			55 / 52			55 / 52		
Sound power level	Cooling (Hi)	dB			68			68			69			69			70			70		
	Heating (Hi)	dB			70			70			71			71			73			73		
Dimensions	H x W x D	mm			1,330 x 940 x 340			1,330 x 940 x 340			1,330 x 940 x 340			1,330 x 940 x 340			1,330 x 940 x 340			1,330 x 940 x 340		
Net weight	kg	104			103			104			103			104			103					
Piping connections	Liquid pipe	inch (mm)			9.52 (3/8)			9.52 (3/8)			9.52 (3/8)			9.52 (3/8)			9.52 (3/8)					
	Gas pipe	inch (mm)			15.88 (5/8)			15.88 (5/8)			15.88 (5/8)			15.88 (5/8)			19.05 (3/4)			19.05 (3/4)		
Refrigerant loading	R410A	kg			3.5			3.5			3.5			3.5			3.5					
Operating range	Cooling Min / Max	°C			-10 / 46°C DB			-10 / 46°C DB			-10 / 46°C DB			-10 / 46°C DB			-10 / 46°C DB			-10 / 46°C DB		
	Heating Min / Max	°C			-20 / 24°C DB			-20 / 24°C DB			-20 / 24°C DB			-20 / 24°C DB			-20 / 24°C DB			-20 / 24°C DB		
		°C			-20 / 18°C WB			-20 / 18°C WB			-20 / 18°C WB			-20 / 18°C WB			-20 / 18°C WB			-20 / 18°C WB		

Rating Conditions: Cooling Indoor 27 °C DB / 19 °C WB. Cooling Outdoor 35 °C DB / 24 °C WB. Heating Indoor 20 °C DB. Heating Outdoor 7 °C DB / 6 °C WB. DB: Dry Bulb; WB: Wet Bulb

¹⁾ EER and COP classification is at 400 V in accordance with EU directive 2002/31/EC. Specifications subject to change without notice.

For detailed information about ErP, please visit our websites www.aircon.panasonic.co.uk or www.ptc.panasonic.eu



Technical focus

- Single Phase or Three Phase power supply
- One Amp start current
- DC inverter technology combined with R410A
- Diversity ratio 50-130%
- Cooling operation to -10°C
- Compact outdoor unit 1,330 x 940 x 410mm

Flexible pipework

Category	Item	Description	Max length (m)
Allowable pipework length	L1	Maximum pipe run	Actual length 120
			Equivalent length 140
	L2-L3	Difference between maximum length and minimum length from the first distribution joint	40
	L3 L4 Ln	Maximum length of each distribution joint	30
Allowable height difference	L1+L3+L4	Maximum total pipe run length	150
	H1	When outdoor unit installed higher	50
	H2	When outdoor unit installed lower	40
		Maximum difference between indoor units	15

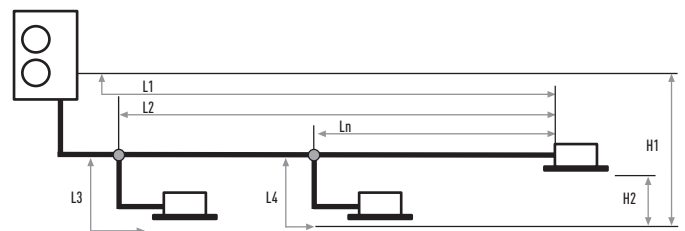

4 x Ø 32 holes (holes for drain)
Of the 4 Ø 32 holes, use 1 of the 2 holes specified for drain use to install the port.
Use rubber plugs to seal the remaining 3 holes.

Top view

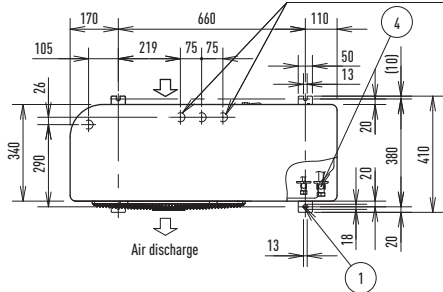

Front view

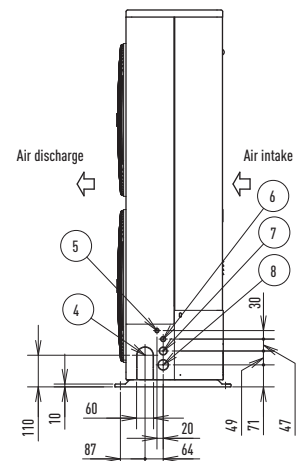
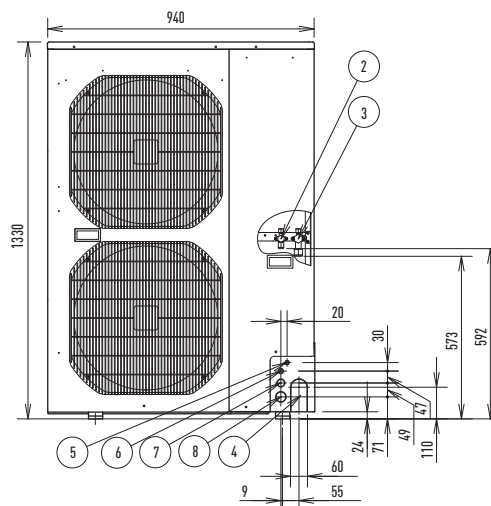

	Size (mm)
1 Mounting hole (4-R6.5), anchor bolt:	M10
2 Refrigerant tubing (liquid tube), flared connection	Ø 9.52
3 Refrigerant tubing (gas tube), flared connection	15.88 or 19.05
4 Refrigerant tubing port	
5 Electrical wiring port	Ø 16
6 Electrical wiring port	Ø 19
7 Electrical wiring port	Ø 29
8 Electrical wiring port	Ø 38



2-Pipe ECOi 6N series. High-efficiency and large-capacity VRF system

Large-capacity VRF systems using R410A with advanced technology.

Newly designed next generation VRF!



Energy saving

Environmentally friendly refrigerant
 R410A

Down to -25 °C in heating mode
 OUTDOOR TEMPERATURE

5 year
 compressor
 warranty



HIGH EFFICIENCY

Energy savings

The operation efficiency has been improved using highly efficient R410A refrigerant, new DC inverter compressor, new DC motor and new design of heat exchanger.

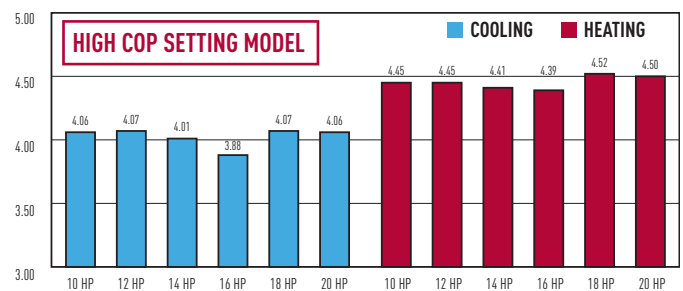
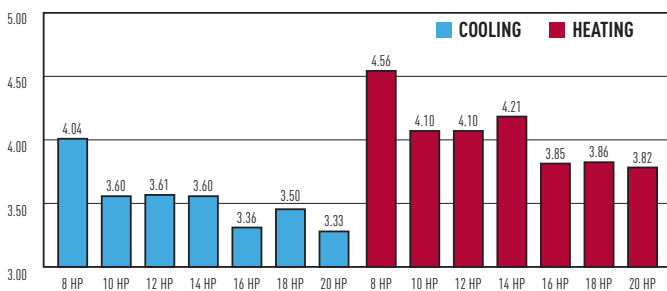

Extended operating range

Heating operation range: Extended heating operation range enables heating even when outdoor temperature as low as -25°C. Using a wired remote control, indoor heating temperature range can be set from 16°C to 30°C.

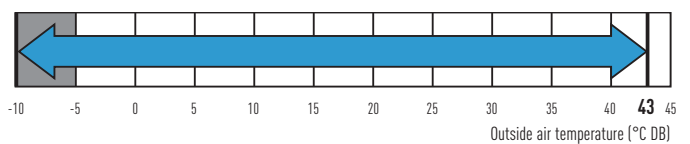
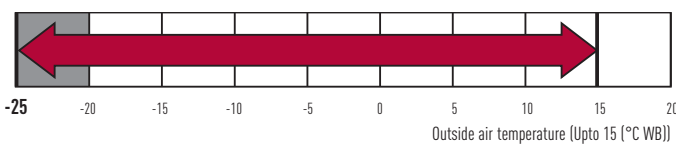

Wide temperature setting range.

Cooling operation range: -10°C DB to +43°C DB.

2-Pipe ECOi 6N series

Connectable indoor/outdoor unit capacity ratio up to 200%

VRF systems attain maximum indoor unit connection capacity of up to 200 % of the unit's connection range, depending on the outdoor and indoor models selected. So for a reasonable investment, VRF systems provide an ideal air conditioning solution for locations where full cooling/heating are not always required.

System (HP)	8	10	12	14	16	18	20	22	24	26	28	30	32	34	36	38	40	42	44	46	48	50	52	54	56	58	60
Connectable indoor units: 130%	13	16	19	23	26	29	33	36	40	43	47	50	53	56	59												
Connectable indoor units: 200%	20	25	30	35	40	45	50	55	60											64							

If more than 100% indoor units are operated with a high load, the units may not perform at the rated capacity. For the details, please consult with an authorized Panasonic dealer.

Increased piping lengths and design flexibility

Adaptable to various building types and sizes. Actual piping length: 180m.
Maximum piping length: 1,000m.

Maximum total length: 1,000 m

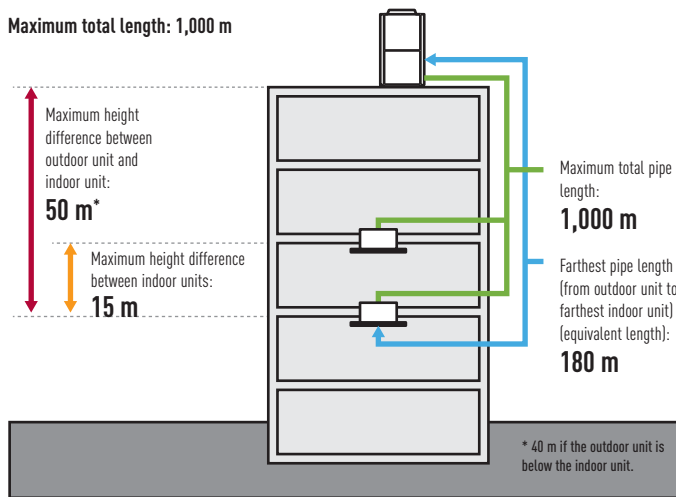

Extended compressor life by uniform compressor operation times

Total compressors run-time is monitored by a built-in microcomputer, which ensures that operation times of all compressors within the same refrigerant circuit are balanced. Compressors with histories showing shorter run times are selected first, ensuring equal wear and tear across all units and extended working life for the system.

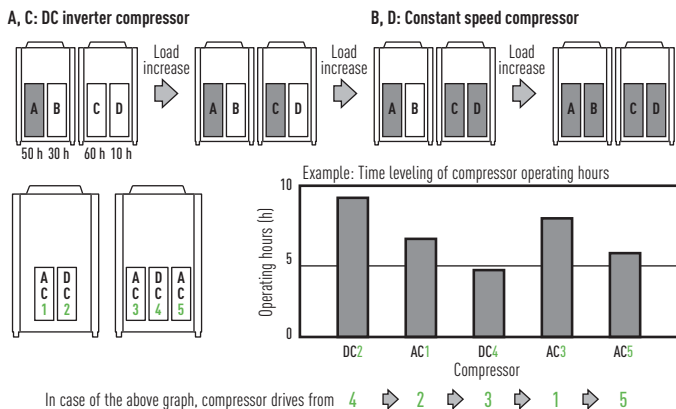

Newly designed fan. Optimized air flow and noise reduction

Newly designed fan and bell-mouth reduces stress to fan by dispersing higher wind speeds. Thus, lower air resistance results in lower energy consumption. The turbulent flow (blue part) can be suppressed and the noise can be reduced. Even though the high speed circulation is utilized, the noise level is held at the same level as normal.



Non-stop operation during maintenance

In the event of an indoor unit malfunctioning, other indoor units can be set to continue operation even during maintenance.

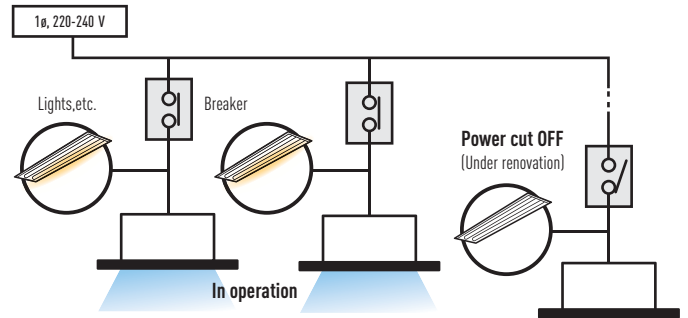

Automatic Backup operation in the case of compressor and outdoor units malfunction

Backup operation is applied in the case of emergencies. If error message is displayed, please contact your local service office. (Except for 8 and 10 HP single unit installation).



Easy to design solutions for schools, hotels, hospitals and other large buildings

Difference between maximum and minimum pipe runs after first branch can be a maximum of 50 m; larger pipe runs can be up to 180 m.

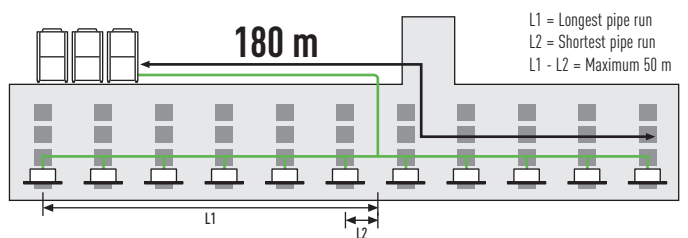

ECOi 2-Pipe and 3-Pipe wind protection shield

PAW-WPH1	1 long side of the outdoor unit (624 x 983 x 489)
PAW-WPH2	1 long side of the outdoor units (853 x 983 x 489)
PAW-WPH3	2 long sides of the outdoor units (744 x 983 x 289) (2ER SET)

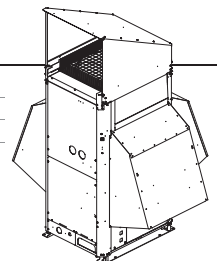



Anti-corrosion model available for all ECOi and ECO G models

For bespoke projects: for use in coastal areas and other locations where sea air can easily cause salt damage to units. The unit is treated with anti-corrosion solution to provide exceptional durability in adverse salty environments.

Note: Using this unit does not completely eliminate the possibility of rust developing. For details concerning unit installation and maintenance, please consult with an authorized dealer.



Demand control Kit information

		Mini ECOi	ECOi 6N	ECO G	PACi
CZ-CAPDC2	Seri-Para I/O unit for outdoor unit	Yes	Yes	Yes	Yes
CZ-CAPDC3	Demand Control Kit	Yes	Yes	Yes	Yes

Function of Demand control

This function limits the maximum operating input at peak time.

3 levels as 100%/70%/0% is set at the factory¹.

The limit value setting for level 1 & 2 can be changed from 40% ~ 100% by 5% at the system commissioning.

1. The 3rd level is available only for CZ-CAPDC3 & CZ-CAPDC4.)

	Power input level (vs. rated condition)	
Level 1	100% (at ship)	From 40%-100% setting can be changed (by 5% step)
Level 2	70% (at ship)	
Level 3	0% (Forcible thermo-OFF)	

OPERATING IMAGE

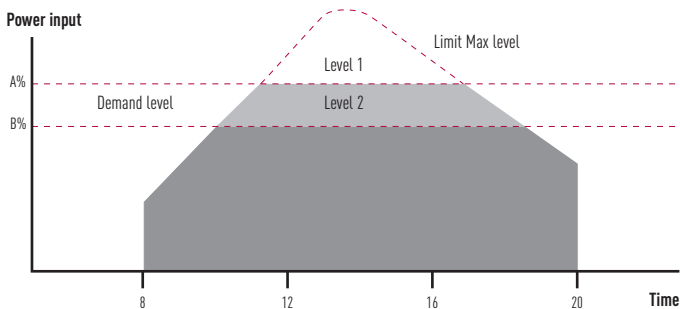

CZ-CAPDC2

Demand control input signals sent to this outdoor interface will be transferred to the system via inter-unit control wiring. Other controls (ex. Operation ON/OFF, Mode switch Cool/Heat) are also available. Demand level 1 & 2 are available. Up to 4 systems can be connected and controlled independently or all together by one interface.

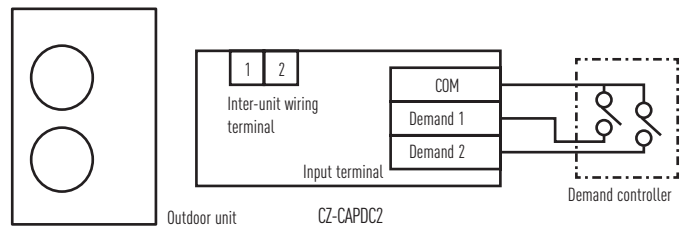

CZ-CAPDC3 for PACi and Mini ECOi

Optional terminal block kit for demand control to be mounted in the outdoor unit. Via this interface, the demand control signals go directly to the outdoor unit control PCB. 3 control levels are available.

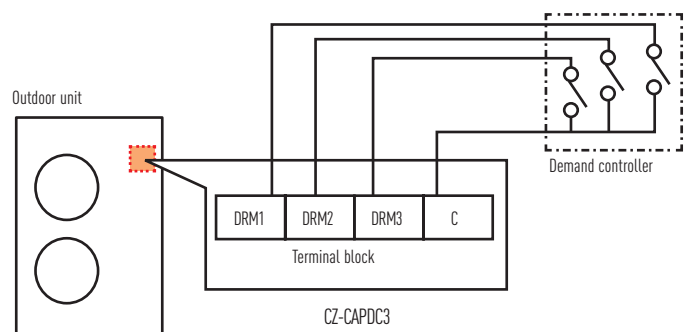

* Only for 6N series ECO-i outdoor unit, "Regular Demand control" setting is available. (The system will be limited the maximum input level for all the time without any signal input.) (The setting to be done at the time of system start-up or service by maintenance remote controller.)

2-PIPE ECOi 6N SERIES 8-12 HP

Next generation VRF newly-redesigned!

At start up stage a unit can have Hi COP function selected - this lowers capacity but increases the COP. It's your choice.

- Top class COP= 4.56 (In case of 8 HP heating)
- Heating operation at outdoor temperatures down to -25°C
- Extended pipe runs of up to 180 m

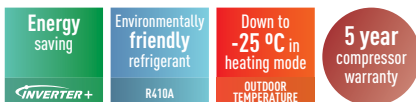

5 YEARS COMPRESSOR WARRANTY. Only for PRO partners.

HP	8 HP		10 HP		12 HP	
Standard model	U-8ME1E81		U-10ME1E81		U-12ME1E81	
Power supply	400 V / Three Phase / 50 Hz		400 V / Three Phase / 50 Hz		400 V / Three Phase / 50 Hz	
Cooling capacity	kW	22.4	28.0	33.5		
EER ¹⁾	Nominal W/W	4.04	3.60	3.61		
Operating current	A	8.5	12.2	14.6		
Power input cooling	kW	5.54	7.78	9.29		
Heating capacity	kW	25.0	31.5	37.5		
COP ¹⁾	Nominal W/W	4.56	4.10	4.10		
Operating current	A	8.4	12.1	14.4		
Power input heating	kW	5.48	7.68	9.15		
Starting current	A	1	1	1		
External static pressure	Pa	80	80	80		
Air volume	m ³ /h	8,820	9,180	11,400		
Sound pressure level	Normal mode	dB(A)	56.5	59.0	61.0	
	Silent mode	dB(A)	53.5	56.0	58.0	
Sound power level	Normal mode	dB	71.0	73.5	75.5	
Dimensions	H x W x D	mm	1,758 x 770 x 930	1,758 x 770 x 930	1,758 x 770 x 930	
Net weight	kg	234	234	281		
Piping connections	Gas pipe	inch (mm)	3/4 (19.05)	7/8 (22.22)	1 (25.4)	
	Liquid pipe	inch (mm)	3/8 (9.52)	3/8 (9.52)	1/2 (12.7)	
	Balance pipe	inch (mm)	1/4 (6.35)	1/4 (6.35)	1/4 (6.35)	
Refrigerant amount at shipment	kg	6.5	6.8	6.8		
Demand control			13 steps (0 - 100 %)	13 steps (0 - 100 %)	13 steps (0 - 100 %)	
Operating range	Cooling Min / Max	°C	-10°C DB / +43°C DB	-10°C DB / +43°C DB	-10°C DB / +43°C DB	
	Heating Min / Max	°C	-25°C WB / +15°C WB	-25°C WB / +15°C WB	-25°C WB / +15°C WB	

Rating Conditions: Cooling Indoor 27 °C DB / 19 °C WB. Cooling Outdoor 35 °C DB / 24 °C WB. Heating Indoor 20 °C DB. Heating Outdoor 7 °C DB / 6 °C WB.
DB: Dry Bulb; WB: Wet Bulb

¹⁾ EER and COP classification is at 400 V in accordance with EU directive 2002/31/EC.

Specifications subject to change without notice.

For detailed information about ErP, please visit our websites www.aircon.panasonic.co.uk or www.ptc.panasonic.eu



Technical focus

- Compact casing
- Longer maximum piping length up to 1,000m
- Extended operating range to provide heating at outdoor temperature as low as -25°C
- Suitable for refurbishment projects (Refer to technical data book)

Compact design

The 8-12 HP unit is designed to fit inside a lift for easy on-site handling.

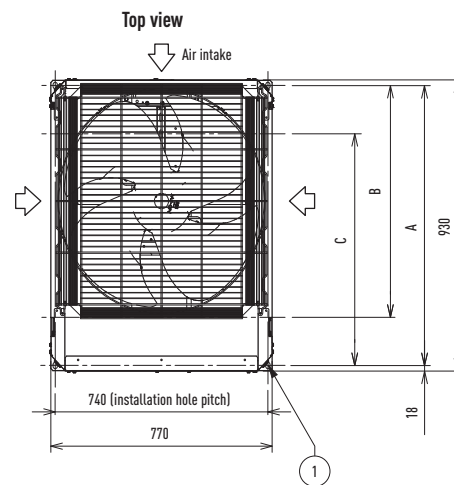
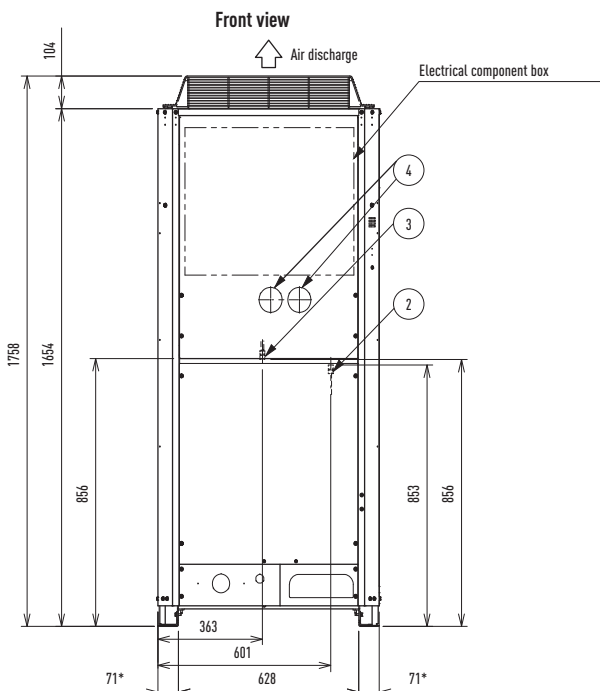
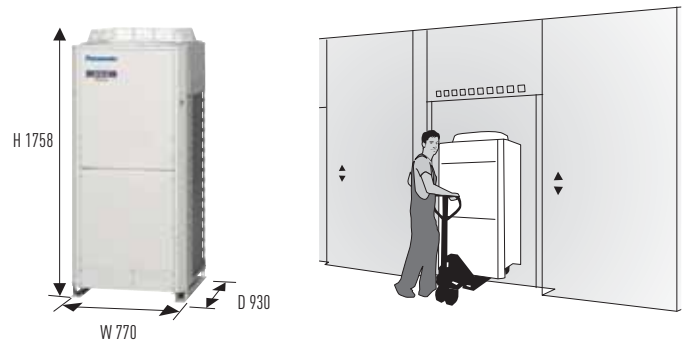

A	Ø94 (installation hole pitch). The tubing is routed out from the front
B	730 (installation hole pitch). The tubing is routed out from the front
C	730 (installation hole pitch)
1	Installation holes (8-15x21 elongated holes) anchor bolts M12 or larger
2	Pressure outlet port (for high pressure: Ø 7.94 Scradler-type connection)
3	Pressure outlet port (for low pressure: Ø 7.94 Scradler-type connection)
4	Knock-out hole for connecting pressure gauge (optional)
5	Terminal board
6	Terminal board (for inter-outdoor-unit control wiring)

* Installation fixing bracket, installation side.

2-PIPE ECOi 6N SERIES 14-16 HP

Next generation VRF newly-redesigned!

At start up stage a unit can have Hi COP function selected - this lowers capacity but increases the COP. It's your choice.

- Heating operation at outdoor temperatures down to -25°C
- Extended pipe runs of up to 180 m

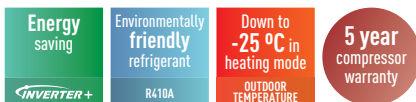

5 YEARS COMPRESSOR WARRANTY. Only for PRO partners.

HP			14 HP	16 HP
Standard model			U-14ME1E81	U-16ME1E81
Power supply			400 V / Three Phase / 50 Hz	
Cooling capacity			kW	40.0
EER ¹⁾	Nominal	W/W	3.60	3.36
Operating current			A	17.1
Power input cooling			kW	11.1
Heating capacity			kW	45.0
COP ¹⁾	Nominal	W/W	4.21	3.85
Operating current			A	16.5
Power input heating			kW	10.7
Starting current			A	77
External static pressure			Pa	80
Air volume			m ³ /h	12,720
Sound pressure level	Normal mode	dB(A)	62.0	62.0
	Silent mode	dB(A)	59.0	59.0
Sound power level	Normal mode	dB	76.5	76.5
Dimensions			H x W x D	mm
Net weight			kg	309
Piping connections	Gas pipe	inch (mm)	1 (25.40)	1-1/8 (28.58)
	Liquid pipe	inch (mm)	1/2 (12.70)	1/2 (12.70)
	Balance pipe	inch (mm)	1/4 (6.35)	1/4 (6.35)
Refrigerant amount at shipment			kg	8.5
Demand control			13 steps (0 - 100 %)	
Operating range	Cooling Min / Max	°C	-10°C DB / +43°C DB	
	Heating Min / Max	°C	-25°C WB / +15°C WB	

Rating Conditions: Cooling Indoor 27 °C DB / 19 °C WB. Cooling Outdoor 35 °C DB / 24 °C WB. Heating Indoor 20 °C DB. Heating Outdoor 7 °C DB / 6 °C WB.
DB: Dry Bulb; WB: Wet Bulb

1) EER and COP classification is at 400 V in accordance with EU directive 2002/31/EC.
Specifications subject to change without notice.

For detailed information about ErP, please visit our websites www.aircon.panasonic.co.uk or www.ptc.panasonic.eu



Technical focus

- Longer Max piping length up to 1,000 m
- Extended operating range to provide heating at outdoor temperature as low as -25°C
- Suitable for refurbishment projects (Refer to technical data book)

High external static pressure

Special setting at site allows all models to provide up to 80 Pa due to newly designed fan, fan motor and casing. The flexible design requires an air discharge duct to avoid a reduction in performance due to shortcut of air circulation. This new feature allows the outdoor unit to be installed inside plant rooms on any floor of the building.

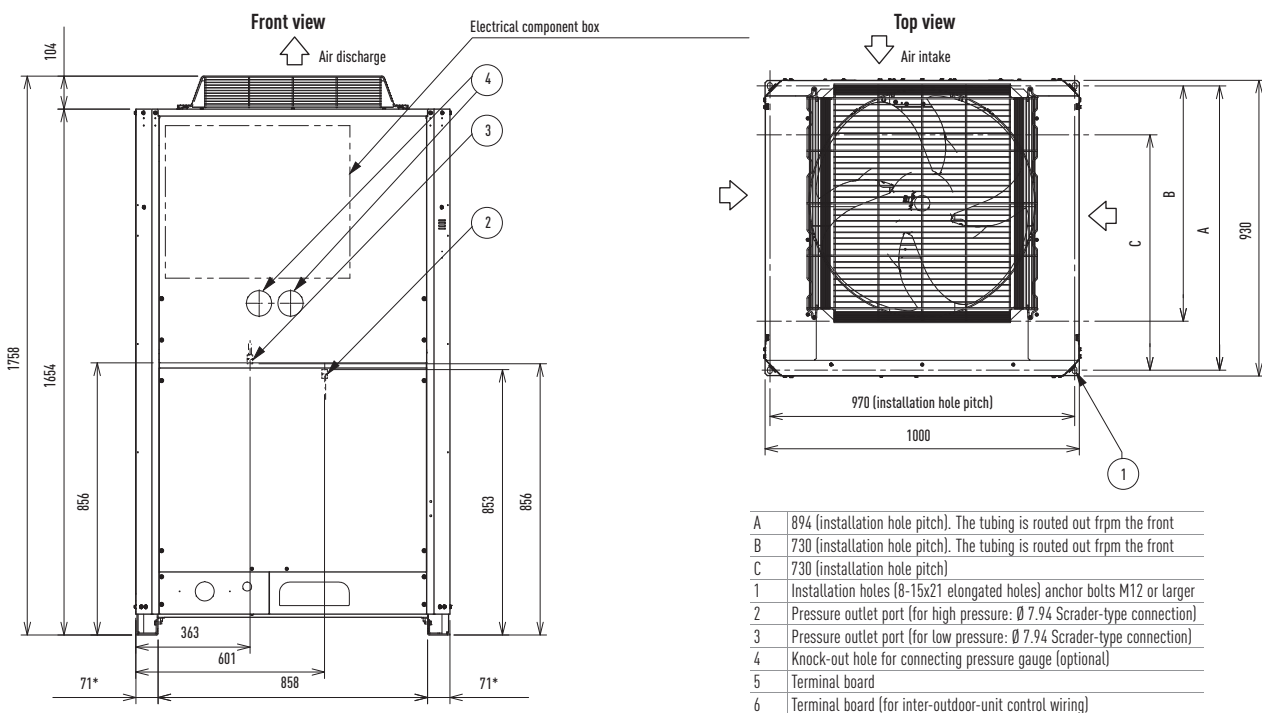

* Installation fixing bracket, installation side.

2-PIPE ECOi 6N SERIES 18-20 HP

Next generation VRF newly-redesigned!

At start up stage a unit can have Hi COP function selected - this lowers capacity but increases the COP. It's your choice.

- Heating operation at outdoor temperatures down to -25°C
- Extended pipe runs of up to 180 m

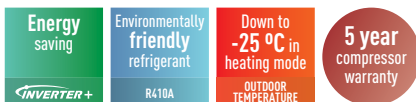

5 YEARS COMPRESSOR WARRANTY. Only for PRO partners.

HP	18 HP		20 HP	
Standard model	U-18ME1E81		U-20ME1E81	
Power supply	400 V / Three Phase / 50 Hz		400 V / Three Phase / 50 Hz	
Cooling capacity	kW	50.0	56.0	
EER ¹⁾	Nominal W/W	3.50	3.33	
Operating current	A	22.8	26.8	
Power input cooling	kW	14.3	16.8	
Heating capacity	kW	56.0	63.0	
COP ¹⁾	Nominal W/W	3.86	3.82	
Operating current	A	23.1	26.3	
Power input heating	kW	14.5	16.5	
Starting current	A	93	101	
External static pressure	Pa	80	80	
Air volume	m ³ /h	14,640	16,980	
Sound pressure level	Normal mode	dB(A)	60.0	
	Silent mode	dB(A)	57.0	
Sound power level	Normal mode	dB	74.5	
Dimensions	H x W x D	mm	1,758 x 1,540 x 930	
Net weight		kg	421	
Piping connections	Gas pipe	inch (mm)	1-1/8 (28.58)	
	Liquid pipe	inch (mm)	5/8 (15.88)	
	Balance pipe	inch (mm)	1/4 (6.35)	
Refrigerant amount at shipment		kg	9.0	
Demand control			13 steps (0 - 100 %)	
Operating range	Cooling Min / Max	°C	-10°C DB / +43°C DB	
	Heating Min / Max	°C	-25°C WB / +15°C WB	

Rating Conditions: Cooling Indoor 27 °C DB / 19 °C WB. Cooling Outdoor 35 °C DB / 24 °C WB. Heating Indoor 20 °C DB. Heating Outdoor 7 °C DB / 6 °C WB.
DB: Dry Bulb; WB: Wet Bulb

1) EER and COP classification is at 400 V in accordance with EU directive 2002/31/EC.
Specifications subject to change without notice.

For detailed information about ErP, please visit our websites www.aircon.panasonic.co.uk or www.ptc.panasonic.eu



Technical focus

- Bigger capacity in one casing
- Longer Max piping length up to 1,000 m
- Extended operating range to provide heating at outdoor temperature as low as -25°C
- Suitable for refurbishment projects (Refer to technical data book)

Compact design

2-Pipe ECOi 6N series has reduced the installation space required by 1 chassis for sizes up to 20 HP.

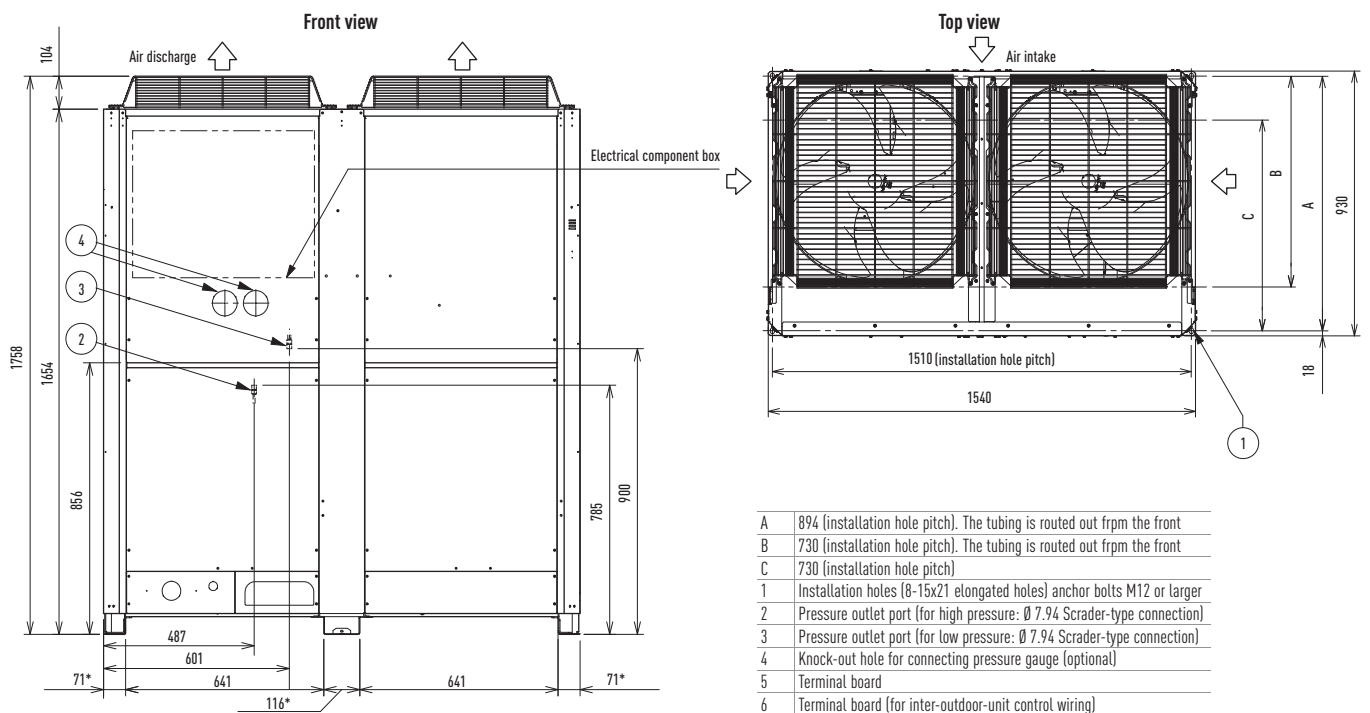
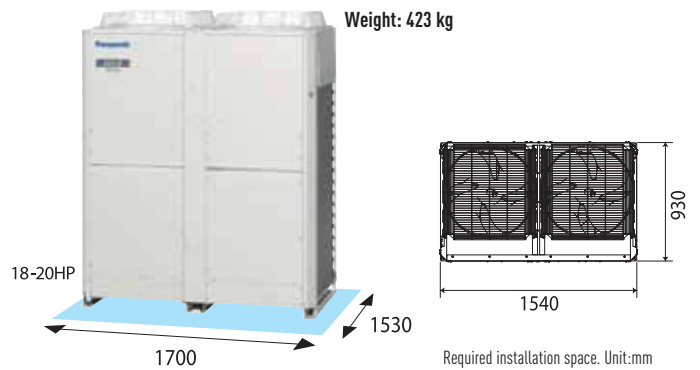

2-PIPE ECOi 6N SERIES COMBINATION FROM 22 TO 60 HP

Next generation VRF newly-redesigned!

At start up stage a unit can have Hi COP function selected - this lowers the capacity and increases the COP. It's your choice.

- Wide range of system up to 60 HP
- Heating operation at outdoor temperatures down to -25°C
- Extended pipe runs of up to 180 m

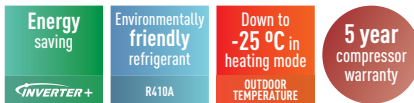

5 YEARS COMPRESSOR WARRANTY. Only for PRO partners.

HP		22 HP	24 HP	26 HP	28 HP	30 HP	32 HP	34 HP	36 HP	
Standard model		U-14ME1E81 U-8ME1E81	U-14ME1E81 U-10ME1E81	U-14ME1E81 U-12ME1E81	U-16ME1E81 U-12ME1E81	U-16ME1E81 U-14ME1E81	U-16ME1E81 U-16ME1E81	U-18ME1E81 U-16ME1E81	U-20ME1E81 U-16ME1E81	
Power supply		400 V / Three Phase / 50 Hz								
Cooling capacity	kW	61.5	68.0	73.0	78.5	85.0	90.0	96.0	101.0	
EER ¹⁾	Nominal W/W	3.75	3.60	3.60	3.47	3.47	3.35	3.43	3.34	
Operating current	A	25.2	29.4	31.6	35.2	37.8	41.5	44.0	47.5	
Power input cooling	kW	16.4	18.9	20.3	22.6	24.5	26.9	28.0	30.2	
Heating capacity	kW	69.0	76.5	81.5	87.5	95.0	100.0	108.0	113.0	
COP ¹⁾	Nominal W/W	4.34	4.09	4.12	3.96	4.03	3.86	3.86	3.83	
Operating current	A	24.5	29.1	30.8	34.4	36.4	40.0	44.0	46.4	
Power input heating	kW	15.9	18.7	19.8	22.1	23.6	25.9	28.0	29.5	
Starting current	A	86	94	98	102	98	102	114	122	
External static pressure	Pa	80	80	80	80	80	80	80	80	
Air volume	m ³ /h	21,540	21,900	24,120	24,120	25,440	25,440	27,360	29,700	
Sound pressure level	Normal mode	dB(A)	63.0	63.5	64.5	64.5	65.0	65.0	64.0	65.5
	Silent mode	dB(A)	60.0	60.5	61.5	61.5	62.0	62.0	61.0	62.5
Sound power level	Normal mode	dB	77.5	78.0	79.0	79.0	79.5	79.5	78.5	80.0
Dimensions	H x W x D	mm	1,758 x 1,830 x 930	1,758 x 1,830 x 930	1,758 x 1,830 x 930	1,758 x 1,830 x 930	1,758 x 2,060 x 930	1,758 x 2,060 x 930	1,758 x 2,600 x 930	
Net weight	kg	543	543	590	590	618	618	730	730	
Piping connections	Gas pipe	inch (mm)	1-1/8 (28.58)	1-1/8 (28.58)	1-1/4 (31.75)	1-1/4 (31.75)	1-1/4 (31.75)	1-1/4 (31.75)	1-1/4 (31.75)	1-1/12 (38.10)
	Liquid pipe	inch (mm)	5/8 (15.88)	5/8 (15.88)	3/4 (19.05)	3/4 (19.05)	3/4 (19.05)	3/4 (19.05)	3/4 (19.05)	3/4 (19.05)
	Balance pipe	inch (mm)	1/4 (6.35)	1/4 (6.35)	1/4 (6.35)	1/4 (6.35)	1/4 (6.35)	1/4 (6.35)	1/4 (6.35)	1/4 (6.35)
Refrigerant amount at shipment	kg	15.0	15.3	15.3	15.3	17.0	17.0	17.5	17.5	
Demand control		13 steps (0-100%)	13 steps (0-100%)	13 steps (0-100%)	13 steps (0-100%)	13 steps (0-100%)	13 steps (0-100%)	13 steps (0-100%)	13 steps (0-100%)	
Operating range	Cooling Min / Max	°C	-10°C DB / +43°C DB							
	Heating Min / Max	°C	-25°C WB / +15°C WB							

Rating Conditions: Cooling Indoor 27 °C DB / 19 °C WB. Cooling Outdoor 35 °C DB / 24 °C WB. Heating Indoor 20 °C DB. Heating Outdoor 7 °C DB / 6 °C WB.
DB: Dry Bulb; WB: Wet Bulb

1) EER and COP classification is at 400 V in accordance with EU directive 2002/31/EC.

Specifications subject to change without notice.

For detailed information about ErP, please visit our websites www.aircon.panasonic.co.uk or www.ptc.panasonic.eu



38 HP	40 HP	42 HP	44 HP	46 HP	48 HP	50 HP	52 HP	54 HP	56 HP	58 HP	60 HP
U-20ME1E81 U-18ME1E81	U-20ME1E81 U-20ME1E81	U-16ME1E81 U-14ME1E81 U-12ME1E81	U-16ME1E81 U-16ME1E81 U-12ME1E81	U-16ME1E81 U-16ME1E81 U-14ME1E81	U-16ME1E81 U-16ME1E81 U-16ME1E81	U-18ME1E81 U-16ME1E81 U-16ME1E81	U-20ME1E81 U-18ME1E81 U-16ME1E81	U-20ME1E81 U-18ME1E81 U-16ME1E81	U-20ME1E81 U-18ME1E81 U-18ME1E81	U-20ME1E81 U-20ME1E81 U-18ME1E81	U-20ME1E81 U-20ME1E81 U-20ME1E81
400 V / Three Phase / 50 Hz											
107.0	113.0	118.0	124.0	130.0	135.0	140.0	145.0	151.0	156.0	162.0	168.0
3.44	3.36	3.51	3.43	3.43	3.35	3.41	3.35	3.39	3.44	3.38	3.33
49.6	53.6	52.1	56.2	58.5	62.2	64.2	67.7	70.3	72.4	76.4	80.4
31.1	33.6	33.6	36.2	37.9	40.3	41.1	43.3	44.5	45.4	47.9	50.4
119.0	127.0	132.0	138.0	145.0	150.0	155.0	160.0	169.0	175.0	182.0	189.0
3.84	3.85	4.04	3.92	3.96	3.86	3.86	3.84	3.85	3.85	3.83	3.81
49.4	52.6	50.8	54.6	56.5	60.1	62.8	65.2	69.3	72.4	75.8	79.1
31.0	33.0	32.7	35.2	36.6	38.9	40.2	41.7	43.9	45.4	47.5	49.6
123	127	119	122	119	122	134	142	144	146	149	153
80	80	80	80	80	80	80	80	80	80	80	80
31,620	33,960	36,840	36,840	38,160	38,160	40,080	42,420	44,340	46,260	48,600	50,940
65.0	66.0	66.5	66.5	67.0	67.0	66.0	67.0	66.5	66.0	67.0	68.0
62.0	63.0	63.5	63.5	64.0	64.0	63.0	64.0	63.5	63.0	64.0	65.0
79.5	80.5	81.0	81.0	81.5	81.5	80.5	81.5	81.0	80.5	81.5	82.5
1,758 x 3,140 x 930	1,758 x 3,140 x 930	1,758 x 2,890 x 930	1,758 x 2,890 x 930	1,758 x 3,120 x 930	1,758 x 3,120 x 930	1,758 x 3,660 x 930	1,758 x 3,660 x 930	1,758 x 4,200 x 930	1,758 x 4,740 x 930	1,758 x 4,740 x 930	1,758 x 4,740 x 930
842	842	899	899	927	927	1,039	1,039	1,151	1,263	1,263	1,263
1-1/12 (38.10)	1-1/12 (38.10)	1-1/12 (38.10)	1-1/12 (38.10)	1-1/12 (38.10)	1-1/12 (38.10)	1-1/12 (38.10)	1-1/12 (38.10)	1-1/12 (38.10)	1-1/12 (38.10)	1-1/12 (38.10)	1-1/12 (38.10)
3/4 (19.05)	3/4 (19.05)	3/4 (19.05)	3/4 (19.05)	3/4 (19.05)	3/4 (19.05)	3/4 (19.05)	3/4 (19.05)	3/4 (19.05)	3/4 (19.05)	3/4 (19.05)	3/4 (19.05)
1/4 (6.35)	1/4 (6.35)	1/4 (6.35)	1/4 (6.35)	1/4 (6.35)	1/4 (6.35)	1/4 (6.35)	1/4 (6.35)	1/4 (6.35)	1/4 (6.35)	1/4 (6.35)	1/4 (6.35)
18.0	18.0	23.8	23.8	25.5	25.5	26.0	26.0	26.5	27.0	27.0	27.0
13 steps (0-100%)	13 steps (0-100%)	13 steps (0-100%)	13 steps (0-100%)	13 steps (0-100%)	13 steps (0-100%)	13 steps (0-100%)	13 steps (0-100%)	13 steps (0-100%)	13 steps (0-100%)	13 steps (0-100%)	13 steps (0-100%)
-10°C DB / +43°C DB -25°C WB / +15°C WB											

Technical focus

- Increased connectable I_U/O_U cap. ratio up to 200%
- Increased Max no. of connectable I_U up to 64 units
- Increased high external static pressure up to 80 Pa
- Extended operating range to provide heating at outdoor temperature as low as -25°C

2-PIPE ECOi 6N SERIES 10-12 HP HIGH COP SETTING MODEL

Next generation VRF newly-redesigned!

- Heating operation at outdoor temperatures down to -25°C
- Extended pipe runs of up to 180 m



5 YEARS COMPRESSOR WARRANTY. Only for PRO partners.

HP			10 HP	12 HP
High COP setting model			U-14ME1E81	U-16ME1E81
Power supply			400 V / Three Phase / 50 Hz	
Cooling capacity		kW	28.0	33.5
EER ¹⁾	Nominal	W/W	4.06	4.07
Operating current		A	10.7	12.7
Power input cooling		kW	6.90	8.23
Heating capacity		kW	31.5	37.5
COP ¹⁾	Nominal	W/W	4.45	4.45
Operating current		A	10.9	13.0
Power input heating		kW	7.08	8.43
Starting current		A	77	81
External static pressure		Pa	80	80
Air volume		m ³ /h	12,720	12,720
Sound pressure level	Normal mode	dB(A)	62.0	62.0
	Silent mode	dB(A)	59.0	59.0
Sound power level	Normal mode	dB	76.5	76.5
Dimensions		H x W x D	1,758 x 1,000 x 930	
Net weight		kg	307	
Piping connections	Gas pipe	inch (mm)	7/8 (22.22)	
	Liquid pipe	inch (mm)	3/8 (9.52)	
	Balance pipe	inch (mm)	1/4 (6.35)	
Demand control			13 steps (0 - 100 %)	
Refrigerant amount at shipment		kg	8.5	
Operating range	Cooling Min / Max	°C	-10°C DB / +43°C DB	
	Heating Min / Max	°C	-25°C WB / +15°C WB	

Rating Conditions: Cooling Indoor 27 °C DB / 19 °C WB. Cooling Outdoor 35 °C DB / 24 °C WB. Heating Indoor 20 °C DB. Heating Outdoor 7 °C DB / 6 °C WB.
DB: Dry Bulb; WB: Wet Bulb

1) EER and COP classification is at 400 V in accordance with EU directive 2002/31/EC.
Specifications subject to change without notice.

For detailed information about ErP, please visit our websites www.aircon.panasonic.co.uk or www.ptc.panasonic.eu



Technical focus

- Longer Max piping length up to 1,000 m
- Extended operating range to provide heating at outdoor temperature as low as -25°C
- Suitable for refurbishment projects (Refer to technical data book)

High external static pressure

Special setting at site allows all models to provide up to 80 Pa due to newly designed fan, fan motor and casing. The flexible design requires an air discharge duct to avoid a reduction in performance due to shortcut of air circulation. This new feature allows the outdoor unit to be installed inside plant rooms on any floor of the building.

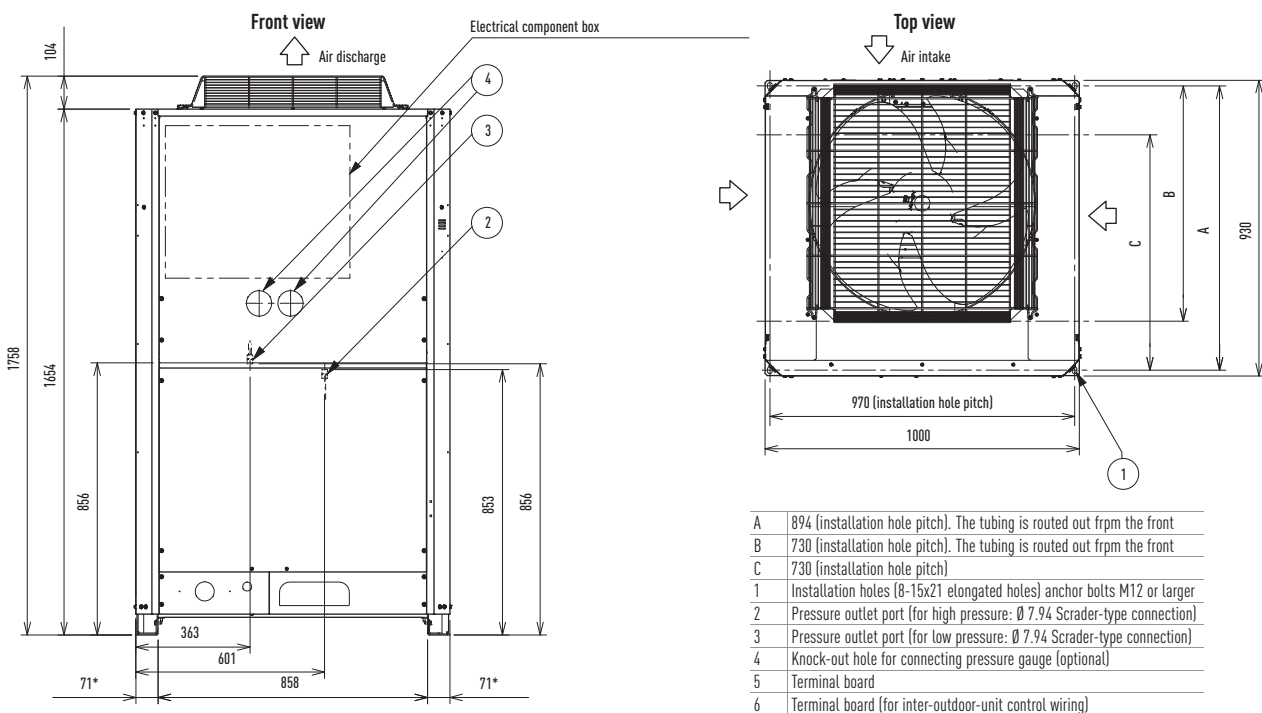

* Installation fixing bracket, installation side.

2-PIPE ECOi 6N SERIES 14-16 HP HIGH COP SETTING MODEL

Next generation VRF newly-redesigned!

- Heating operation at outdoor temperatures down to -25°C
- Extended pipe runs of up to 180 m

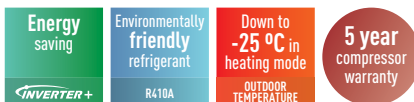

5 YEARS COMPRESSOR WARRANTY. Only for PRO partners.

HP	14 HP		16 HP	
High COP setting model	U-18ME1E81		U-20ME1E81	
Power supply	400 V / Three Phase / 50 Hz		400 V / Three Phase / 50 Hz	
Cooling capacity	kW	40.0	45.0	
EER ¹⁾	Nominal W/W	4.01	3.88	
Operating current	A	15.4	17.9	
Power input cooling	kW	9.98	11.6	
Heating capacity	kW	45.0	50.0	
COP ¹⁾	Nominal W/W	4.41	4.39	
Operating current	A	15.8	17.6	
Power input heating	kW	10.2	11.4	
Starting current	A	92	98	
External static pressure	Pa	80	80	
Air volume	m ³ /h	14,640	16,980	
Sound pressure level	Normal mode	dB(A)	60.0	
	Silent mode	dB(A)	57.0	
Sound power level	Normal mode	dB	74.5	
Dimensions	H x W x D	mm	1,758 x 1,540 x 930	
Net weight		kg	423	
Piping connections	Gas pipe	inch (mm)	1 (25.40)	
	Liquid pipe	inch (mm)	1/2 (12.70)	
	Balance pipe	inch (mm)	1/4 (6.35)	
Demand control			13 steps (0 – 100 %)	
Refrigerant amount at shipment	kg	9.0	9.0	
Operating range	Cooling Min / Max	°C	-10°C DB / +43°C DB	
	Heating Min / Max	°C	-25°C WB / +15°C WB	

Rating Conditions: Cooling Indoor 27 °C DB / 19 °C WB. Cooling Outdoor 35 °C DB / 24 °C WB. Heating Indoor 20 °C DB. Heating Outdoor 7 °C DB / 6 °C WB.
DB: Dry Bulb; WB: Wet Bulb

¹⁾ EER and COP classification is at 400 V in accordance with EU directive 2002/31/EC.
Specifications subject to change without notice.

For detailed information about ErP, please visit our websites www.aircon.panasonic.co.uk or www.ptc.panasonic.eu



Technical focus

- Bigger capacity in one casing
- Longer Max piping length up to 1,000 m
- Extended operating range to provide heating at outdoor temperature as low as -25°C
- Suitable for refurbishment projects (Refer to technical data book)

Compact design

2-Pipe ECOi 6N series has reduced the installation space required by 1 chassis for sizes up to 20 HP.

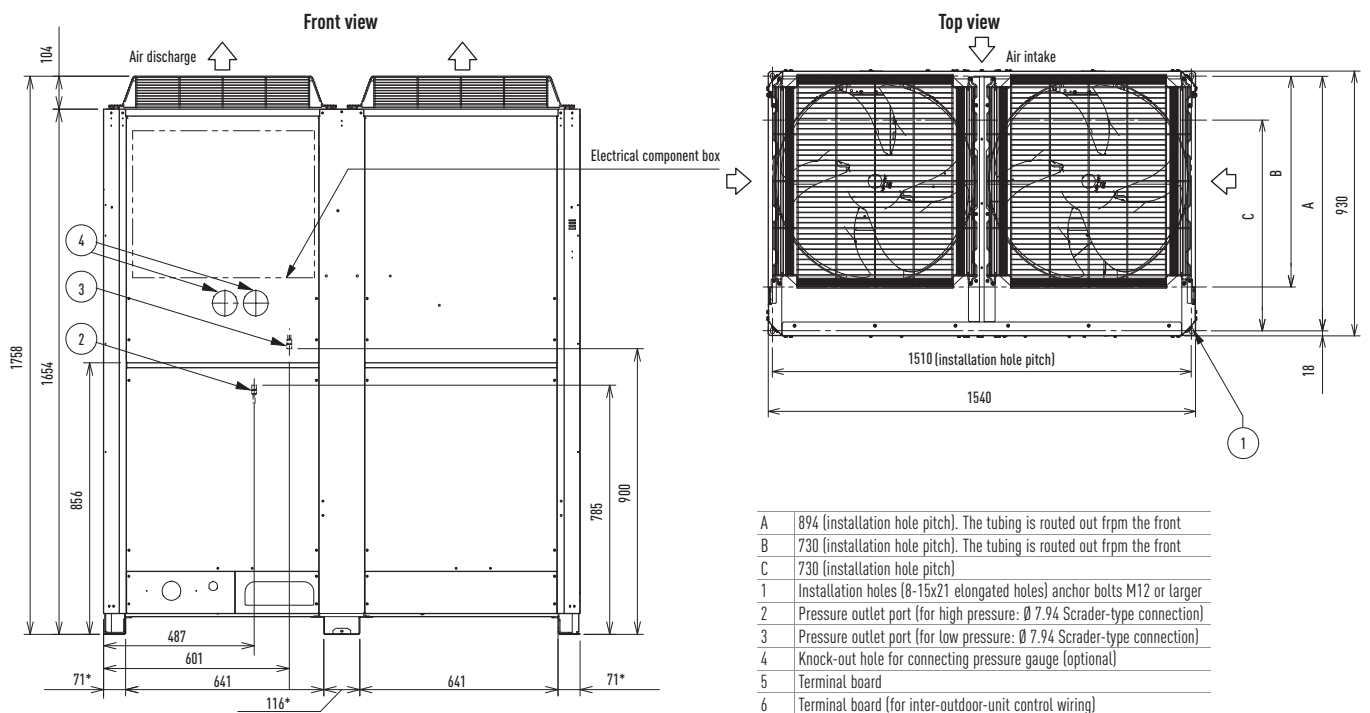
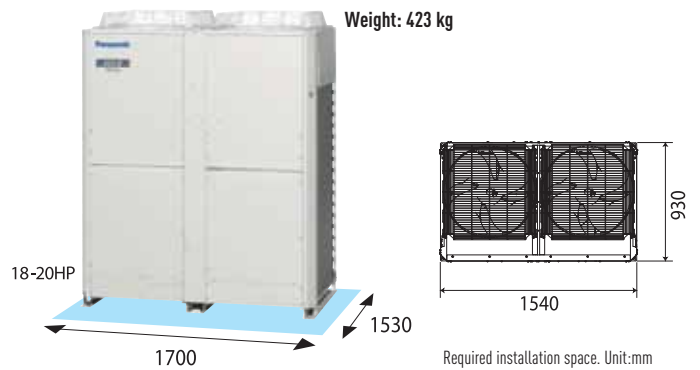

2-PIPE ECOi 6N SERIES HIGH COP SETTING MODEL COMBINATION FROM 18 TO 48 HP

Next generation VRF newly-redesigned!

- Wide range of systems now available to 48 HP
- Heating operation at outdoor temperatures down to -25°C
- Extended pipe runs of up to 180 m

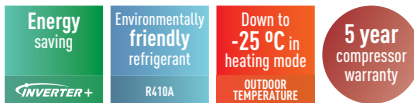

5 YEARS COMPRESSOR WARRANTY. Only for PRO partners.

HP			18 HP	20 HP	22 HP	24 HP	26 HP	28 HP	30 HP
High COP setting model			U-14ME1E81 U-8ME1E81	U-16ME1E81 U-8ME1E81	U-18ME1E81 U-8ME1E81	U-16ME1E81 U-16ME1E81	U-18ME1E81 U-16ME1E81	U-20ME1E81 U-16ME1E81	U-20ME1E81 U-18ME1E81
Power supply			400 V / Three Phase / 50 Hz						
Cooling capacity		kW	50.0	56.0	61.5	68.0	73.0	78.5	85.0
EER ¹⁾	Nominal	W/W	4.07	4.06	3.97	4.07	4.01	3.96	3.94
Operating current		A	18.9	21.2	23.9	25.8	28.1	30.6	33.4
Power input cooling		kW	12.3	13.8	15.5	16.7	18.2	19.8	21.6
Heating capacity		kW	56.0	63.0	69.0	76.5	81.5	87.5	95.0
COP ¹⁾	Nominal	W/W	4.52	4.50	4.39	4.45	4.38	4.42	4.40
Operating current		A	19.1	21.5	24.2	26.6	28.7	30.6	33.4
Power input heating		kW	12.4	14.0	15.7	17.2	18.6	19.8	21.6
Starting current		A	86	90	101	94	105	111	114
External static pressure		Pa	80	80	80	80	80	80	80
Air volume		m ³ /h	21,540	21,540	23,460	25,440	27,360	29,700	31,620
Sound pressure level	Normal mode	dB(A)	63.0	63.0	61.5	65.0	64.0	65.5	65.0
	Silent mode	dB(A)	60.0	60.0	58.5	62.0	61.0	62.5	62.0
Sound power level	Normal mode	dB	77.5	77.5	76.0	79.5	78.5	80.0	79.5
Dimensions	H x W x D	mm	1,758 x 1,830 x 930	1,758 x 1,830 x 930	1,758 x 2,370 x 930	1,758 x 2,060 x 930	1,780 x 2,600 x 930	1,780 x 2,600 x 930	1,758 x 3,140 x 930
Net weight		kg	537	537	653	614	730	730	846
Piping connections	Gas pipe	inch (mm)	1-1/8 (28.58)	1-1/8 (28.58)	1-1/8 (28.58)	1-1/8 (28.58)	1-1/4 (31.75)	1-1/4 (31.75)	1-1/4 (31.75)
	Liquid pipe	inch (mm)	5/8 (15.88)	5/8 (15.88)	5/8 (15.88)	5/8 (15.88)	3/4 (19.05)	3/4 (19.05)	3/4 (19.05)
	Balance pipe	inch (mm)	1/4 (6.35)	1/4 (6.35)	1/4 (6.35)	1/4 (6.35)	1/4 (6.35)	1/4 (6.35)	1/4 (6.35)
Demand control			13 steps (0 - 100 %)	13 steps (0 - 100 %)	13 steps (0 - 100 %)	13 steps (0 - 100 %)	13 steps (0 - 100 %)	13 steps (0 - 100 %)	13 steps (0 - 100 %)
Refrigerant amount at shipment		kg	15.0	15.0	15.5	17.0	17.5	17.5	18.0
Operating range	Cooling Min / Max	°C	-10°C DB / +43°C DB						
	Heating Min / Max	°C	-25°C WB / +15°C WB						

Rating Conditions: Cooling Indoor 27 °C DB / 19 °C WB. Cooling Outdoor 35 °C DB / 24 °C WB. Heating Indoor 20 °C DB. Heating Outdoor 7 °C DB / 6 °C WB.
DB: Dry Bulb; WB: Wet Bulb

¹⁾ EER and COP classification is at 400 V in accordance with EU directive 2002/31/EC.

Specifications subject to change without notice.

For detailed information about ErP, please visit our websites www.aircon.panasonic.co.uk or www.ptc.panasonic.eu



32 HP	34 HP	36 HP	38 HP	40 HP	42 HP	44 HP	46 HP	48 HP
U-20ME1E81 U-20ME1E81	U-18ME1E81 U-16ME1E81 U-8ME1E81	U-16ME1E81 U-16ME1E81 U-16ME1E81	U-18ME1E81 U-16ME1E81 U-16ME1E81	U-20ME1E81 U-16ME1E81 U-16ME1E81	U-20ME1E81 U-18ME1E81 U-16ME1E81	U-20ME1E81 U-18ME1E81 U-18ME1E81	U-20ME1E81 U-20ME1E81 U-18ME1E81	U-20ME1E81 U-20ME1E81 U-18ME1E81
400 V / Three Phase / 50 Hz								
90.0	96.0	101.0	107.0	113.0	118.0	124.0	130.0	135.0
3.88	4.09	4.07	4.08	4.04	3.96	3.97	3.92	3.88
35.9	36.2	38.3	40.5	43.3	46.1	48.3	51.4	53.8
23.2	23.5	24.8	26.2	28.0	29.8	31.2	33.2	34.8
100.0	108.0	113.0	119.0	127.0	132.0	138.0	145.0	150.0
4.41	4.54	4.45	4.44	4.47	4.40	4.42	4.41	4.40
35.1	36.7	39.2	41.4	43.9	46.4	48.3	50.9	52.8
22.7	23.8	25.4	26.8	28.4	30.0	31.2	32.9	34.1
116	113	107	118	124	127	130	131	134
80	80	80	80	80	80	80	80	80
33,960	36,180	38,160	40,080	42,420	44,340	46,260	48,600	50,940
66.0	64.5	66.5	66.0	67.0	66.5	66.0	67.0	67.5
63.0	61.5	63.5	63.0	64.0	63.5	63.0	64.0	64.5
80.5	79.0	81.0	80.5	81.5	81.0	80.5	81.5	82.0
1,758 x 3,140 x 930	1,758 x 3,430 x 930	1,758 x 3,120 x 930	1,758 x 3,660 x 930	1,758 x 3,660 x 930	1,758 x 4,200 x 930	1,758 x 4,740 x 930	1,758 x 4,740 x 930	1,758 x 4,740 x 930
846	960	921	1,037	1,037	1,153	1,269	1,269	1,269
1-1/4 (31.75)	1-1/4 (31.75)	1-1/2 (38.10)	1-1/2 (38.10)	1-1/2 (38.10)	1-1/2 (38.10)	1-1/2 (38.10)	1-1/2 (38.10)	1-1/2 (38.10)
3/4 (19.05)	3/4 (19.05)	3/4 (19.05)	3/4 (19.05)	3/4 (19.05)	3/4 (19.05)	3/4 (19.05)	3/4 (19.05)	3/4 (19.05)
1/4 (6.35)	1/4 (6.35)	6.1/4 (6.35)	1/4 (6.35)	1/4 (6.35)	1/4 (6.35)	1/4 (6.35)	1/4 (6.35)	1/4 (6.35)
13 steps (0 – 100 %)	13 steps (0 – 100 %)	13 steps (0 – 100 %)	13 steps (0 – 100 %)	13 steps (0 – 100 %)	13 steps (0 – 100 %)	13 steps (0 – 100 %)	13 steps (0 – 100 %)	13 steps (0 – 100 %)
18.0	24.0	25.5	26.0	26.0	26.5	27.0	27.0	27.0
-10°C DB / +43°C DB -25°C WB / +15°C WB								

Technical focus

- Increased connectable I_U/O_U cap. ratio up to 200%
- Increased Max no. of connectable I_U up to 64 units
- Increased high external static pressure up to 80 Pa
- Extended operating range to provide heating at outdoor temperature as low as -25°C



**HIGH
EFFICIENCY**

3-Pipe ECOi MF2 6N Series

Simultaneous heating and cooling VRF system

The New Panasonic 3-Pipe MF2 series offers the best solution for the most demanding customers.

- The new 3-Pipe units have only one chassis size, with a very small footprint (only 0.93 m²)
- 1 body for all sizes: H1.758 x W1.000 x D930mm, for 8, 10, 12, 14 and 16 HP
- Maximum capacity size as 48 HP by 3 unit combinations (16 HP x 3 = 48 HP)
- Up to 52 indoor units connectable
- Maximum capacity ratio of 150%

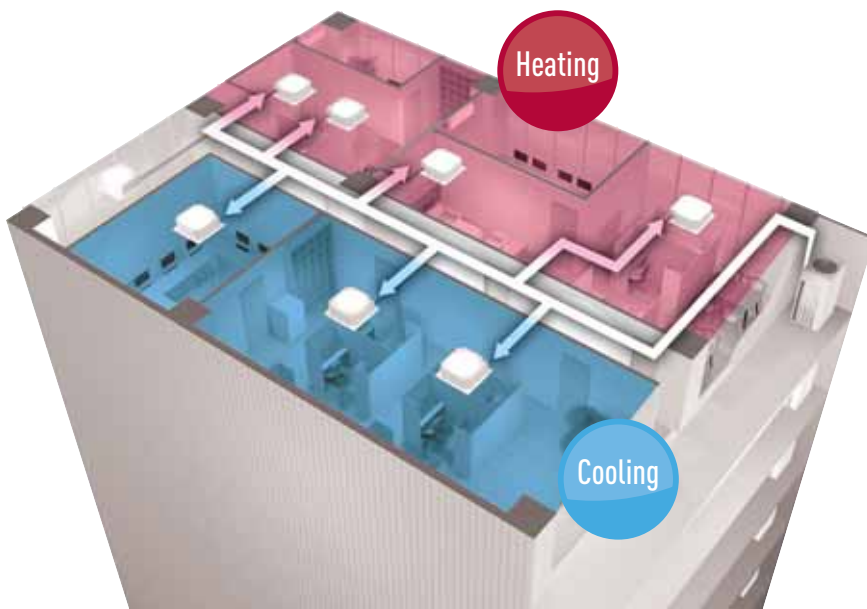

Energy saving
INVERTER+

Environmentally friendly refrigerant
R410A

Down to **-20 °C** in heating mode
OUTDOOR TEMPERATURE

5 year compressor warranty



Large combination of outdoor units, up to 48 HP

Unit	System (HP)																					
	8	10	12	14	16	18	20	22	24	26	28	30	32	34	36	38	40	42	44	46	48	
8	1					1	1	1	1						1	1	1	1				
10		1				1																
12			1				1			1				1								
14				1				1			1	2	1		1	2	1		3	2	1	
16					1				1			1	2			1	2		1	2	3	

High efficiency combination

Unit	System (HP)					
	16	24	26	28	30	32
8	2	3	2	2	2	1
10			1			
12				1		2
14					1	

3-Pipe control box kit / Multiple connection type

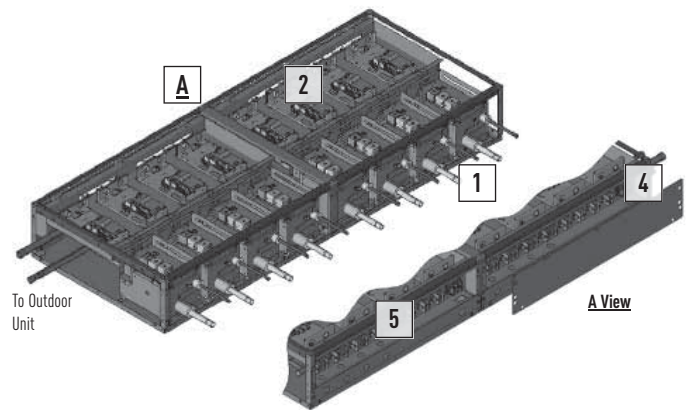

- 1. 8 connection port type (indoor unit side)
- 2. 3-Pipe control PCB included
- 3. Interface relay terminal included (to be mounted on indoor unit side)
- 4. Power supply terminal block
- 5. Control line wire terminal block

Market-leading COP (at full load), standard efficiency

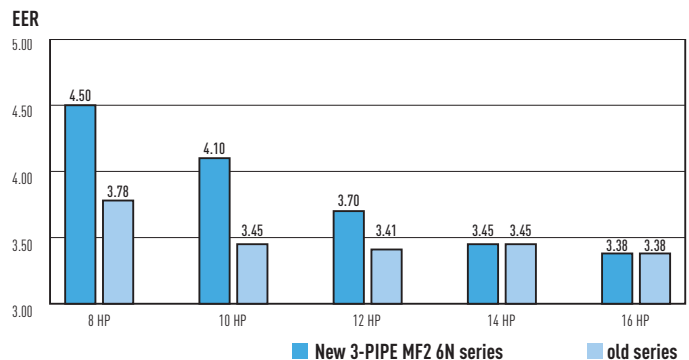
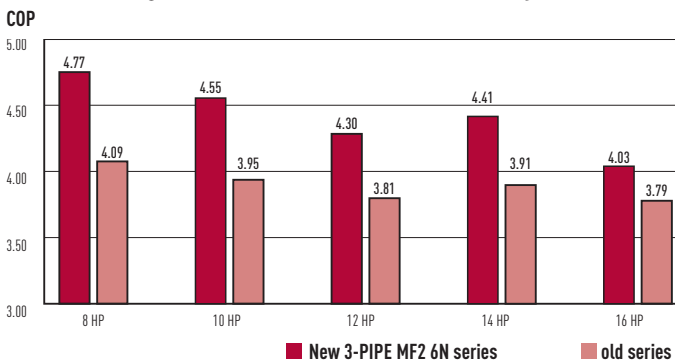

3-Pipe ECOi MF2 6N Series

Connectable indoor/outdoor unit capacity ratio up to 150%

Extended operating range

Cooling operation range: The cooling operation range has been extended to -10°C by changing the outdoor fan to an inverter type.

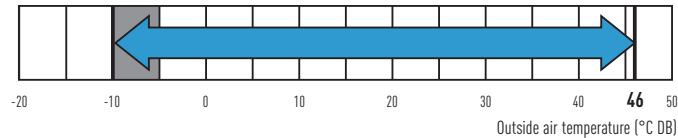

Heating operation range: Stable heating operation even with an outside air temperature of -20°C. The heating operation range has been extended to -20°C by use of a compressor with a high-pressure vessel.

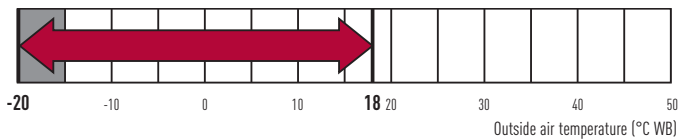

Wide temperature setting range

Wired remote control heating temperature setting range is 16 to 30°C.

Increased piping lengths and design flexibility

Adaptable to various building types and sizes. Actual piping length: 180 m. Maximum piping length: 500 m.

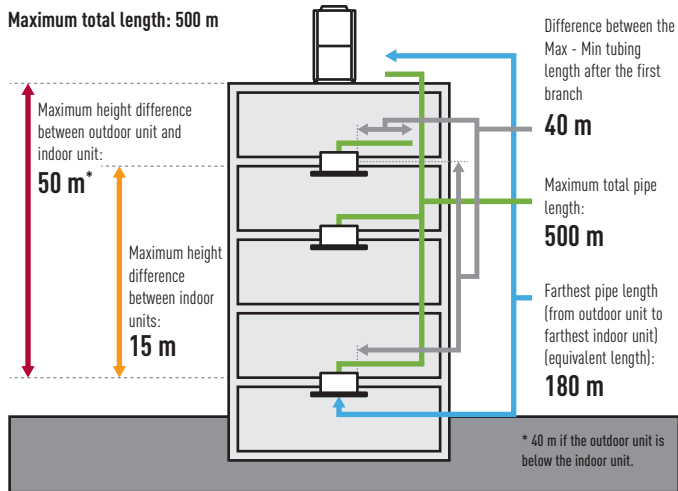

Compact design for superb space saving and low noise level

5 types of outdoor units with different capacities have been standardized to one compact casing. Uniquely constructed with two compartments, the upper chamber contains the heat exchange, with the lower chamber stores the compressors. The benefits are two-fold - superb space saving and low noise level.

Installation space: 0.93 m²

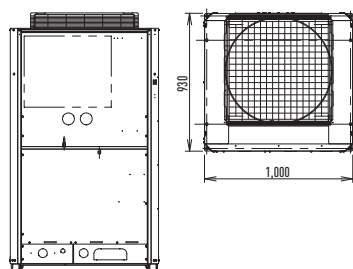

Operating sound dB(A)

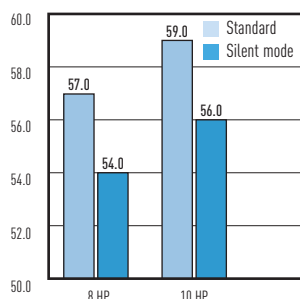

Solenoid valve kit

Oil-recovery operation to gives more stable comfort air-conditioning control.

3-Pipe control Solenoid valve kit



CZ-P56HR3
Up to 5.6 kW
CZ-P160HR3
From 5.7 to 16 kW

KIT-P56HR3
(CZ-P56HR3+CZ-CAPE2)
KIT-P160HR3
(CZ-P160HR3+CZ-CAPE2)

3-Pipe control PCB



3-Pipe control PCB CZ-CAPE2*.
Must be added to the CZ-P56HR3 OR CZ-P160HR3.
* For wall mounted.

Valve Dimensions

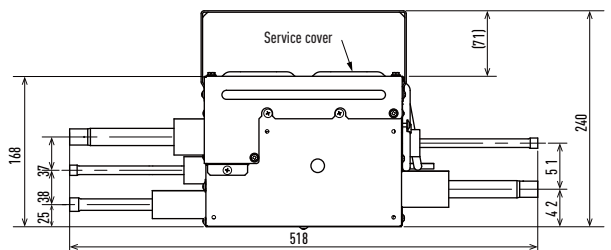
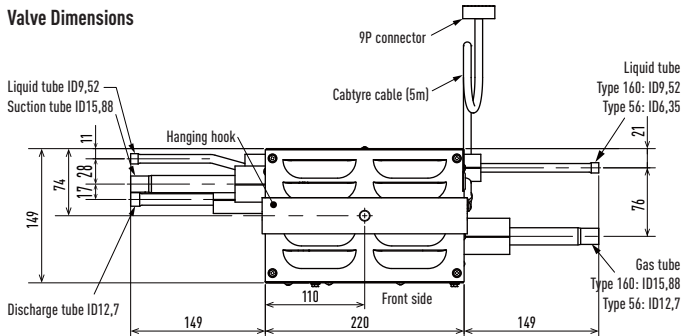

Individual control of multiple indoor units with solenoid valve kits

- Any design and layout can be used in a single system.
- Cooling operation is possible up to an outdoor temperature of -10°C.

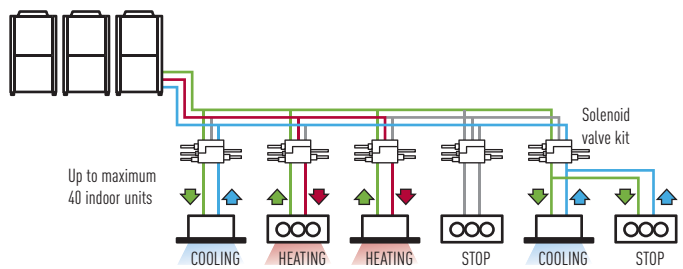

Liquid pipe (medium-temperature, medium-pressure liquid pipe) | Discharge pipe (high-temperature, high-pressure gas pipe) | Suction pipe (low-temperature, low-pressure gas pipe) | Individual control

Non-stop operation during maintenance

Even when an indoor unit needs maintenance, the other indoor units can be kept operating by setting. (Not applicable for all situations)

Power suppression control for energy saving (Demand control)¹

The 3-Pipe ECOi MF2 6N Series has a built-in demand function which uses the inverter characteristics. With this demand function, the power consumption can be set in three steps, and operation² at optimum performance is performed according to the setting and the power consumption. This function is useful to reduce the annual power consumption and to save electricity costs while maintaining comfort.

¹ An outdoor Seri-Para I/O unit is required for demand input.
² Setting is possible as 0% or in the range from 40 to 100% (in steps of 5%). At the time of shipping, setting has been done to the three steps of 0%, 70%, and 100%.

Excellent cost saving and smaller piping size

By using R410a with low pressure loss, pipe sizes for discharge, suction and liquid are all reduced.

This makes it possible to aim for reduced piping space, improved workability at the site, and reduction of the piping material costs.

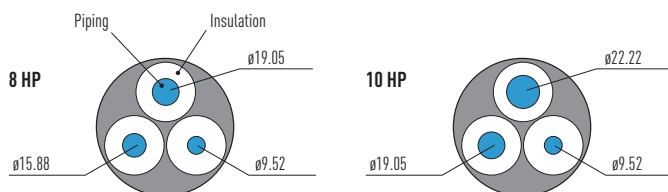

3-Pipe ECOi MF2

HP	Suction pipe	Discharge pipe	Liquid pipe
8	∅ 19.05	∅ 15.88	∅ 9.52
10	∅ 22.22	∅ 19.05	∅ 9.52

Extended compressor life

The total operation time of the compressors is monitored by a microcomputer, so that there is no imbalance for the operation times of all compressors in the same refrigerant system, and compressors with a shorter operation time are operated with preference.

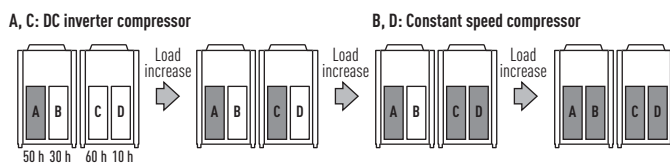

ECOi 2-Pipe and 3-Pipe wind protection shield

PAW-WPH1	1 long side of the outdoor unit (624 x 983 x 489)
PAW-WPH2	1 long side of the outdoor units (853 x 983 x 489)
PAW-WPH3	2 long sides of the outdoor units (744 x 983 x 289) (2ER SET)

Piping design

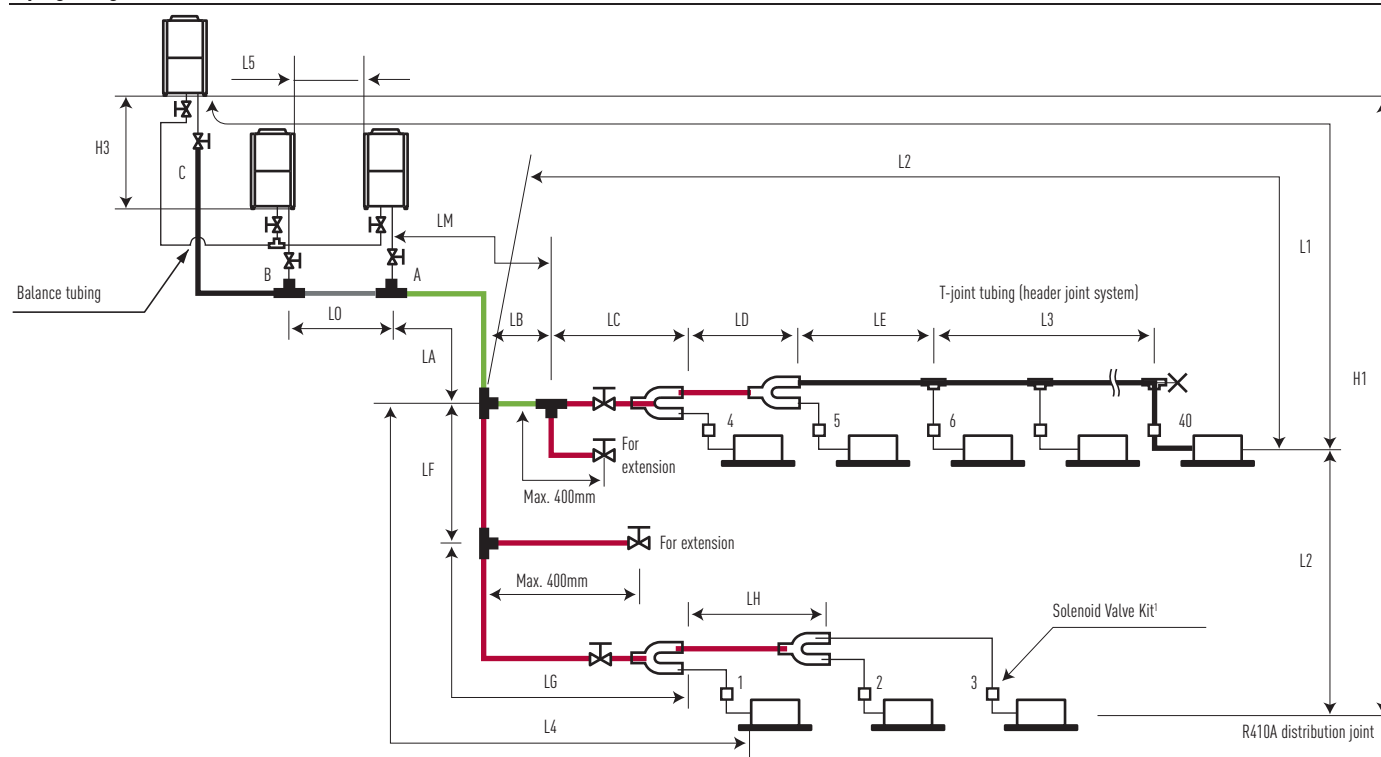

Main piping length
LM = LA + LB...

Main distribution pipes LC-LH are selected according to the capacity after the distribution joint.

Size of indoor unit connection piping 1-40 is determined by the connection piping size on the indoor units.

Distribution joint (CZ, option).

Ball valve (BV, option)

T-joint (field supply)

Solidly welded shut (pinch weld)

The outdoor connection main tubing (LO portion) is determined by the total capacity of the outdoor units that are connected to the tube end.

Note: Do not use commercial T-pieces for the liquid pipes of the distribution joint.

Ranges that apply to refrigerant piping lengths and to differences in installation heights

Items	Marks	Contents	Length (m)
Allowable piping length	L1	Maximum piping length	≤180 ¹
		Actual piping length	≤200
		Equivalent piping length	≤200
	Δ L (L2-L4)	Difference between the Maximum length and the minimum length from the No. 1 distribution	≤40
	LM	Maximum length of main piping (at Maximum diameter)	— ²
Allowable elevation difference	Q1, Q2-Q40	Maximum length of each distribution	≤30
	L1+Q1+Q2...Q39+QA+QB+LF+LG+LH	Total Maximum piping length including length of each distribution (only liquid tubing)	≤500 ³
	L5	Distance between outdoor units	≤10
	H1	When outdoor unit is installed higher than indoor unit	≤50
	H2	When outdoor unit is installed lower than indoor unit	≤40
Allowable length of joint tubing	H3	Maximum difference between indoor units	≤15
		Maximum difference between outdoor units	≤4
	L3	T-joint tubing (field-supply); Maximum tubing length between the first T-joint and solidly welded-shut end point	≤2

L = Length, H = Height

1) If the longest tubing length (L1) exceeds 90 m (equivalent length), increase the sizes of the main tubes (LM) by 1 rank for the discharge tubes, suction tubes, and narrow tubes. (field supplied).

2) If the longest main tube length (LM) exceeds 50 m, increase the main tube size at the portion before 50 m by 1 rank for the suction tubes and discharge tubes. (field supplied).

(For the portion that exceeds 50 m, set based on the main tube sizes (LA) listed in the table on the following page).

3) 24 HP - 30HP of high efficiency combination is 300 m.

3-PIPE ECOi MF2 6N SERIES 8-16 HP

With simultaneous heating and cooling operation heat recovery type

ECOi 3-Pipe is one of the most advanced VRF systems available. Not only offering high-efficiency and performance for simultaneous heating and cooling, but also its sophisticated installation and maintenance much easier.

- Achieves COP 4.77 as the top class in the industry (Average cooling and heating value for 8 HP outdoor unit).
- Simultaneous cooling or heating operation for up to 52 indoor units.
- Small installation space, top class in the industry.
- Rotation operation function and back-up operation function provided.



HP			8 HP	10 HP	12 HP	14 HP	16 HP	
Standard model			U-8MF2E8	U-10MF2E8	U-12MF2E8	U-14MF2E8	U-16MF2E8	
Power supply			380 / 400 / 415 V - Three Phase / 50 Hz	380 / 400 / 415 V - Three Phase / 50 Hz	380 / 400 / 415 V - Three Phase / 50 Hz	380 / 400 / 415 V - Three Phase / 50 Hz	380 / 400 / 415 V - Three Phase / 50 Hz	
Cooling capacity			kW	22.4	28.0	33.5	40.0	
EER ¹⁾	Nominal	W/W	4.50	4.10	3.70	3.45	3.38	
Running current	380 / 400 / 415 V	A	8.60 / 8.17 / 7.96	11.3 / 10.8 / 10.6	15.1 / 14.5 / 14.1	19.2 / 18.4 / 17.9	22.0 / 21.1 / 20.6	
Power input			kW	4.98	6.83	9.05	11.60	
Heating capacity			kW	25.0	31.5	37.5	45.0	
COP ¹⁾	Nominal	W/W	4.77	4.55	4.30	4.41	4.03	
Running current	380 / 400 / 415 V	A	8.95 / 8.50 / 8.28	11.6 / 11.0 / 10.7	14.7 / 14.1 / 13.8	17.0 / 16.4 / 15.9	20.7 / 19.9 / 19.4	
Power input			kW	5.24	6.92	8.72	10.2	
Air volume			m ³ /min	158	178	212	212	
Sound pressure level	High / Low	dB(A)	57.0 / 54.0	59.0 / 56.0	61.0 / 58.0	62.0 / 59.0	62.0 / 59.0	
Sound power level	Normal mode	dB	71.5 / 68.5	73.5 / 70.5	75.5 / 72.5	76.5 / 73.5	76.5 / 73.5	
Dimensions			H x W x D	mm	1,758 x 1,000 x 930	1,758 x 1,000 x 930	1,758 x 1,000 x 930	
Net weight			kg	269	269	314	322	
Piping connections			Suction pipe	mm (Inch)	19.05 (3/4)	22.22 (7/8)	25.40 (1)	28.58 (1-1/8)
			Discharge pipe	mm (Inch)	15.88 (5/8)	19.05 (3/4)	22.22 (7/8)	22.22 (7/8)
			Liquid pipe	mm (Inch)	9.52 (3/8)	9.52 (3/8)	12.70 (1/2)	12.70 (1/2)
			Balance pipe	mm (Inch)	6.35 (1/4)	6.35 (1/4)	6.35 (1/4)	6.35 (1/4)
Refrigerant amount at shipment			kg	8.3	8.5	8.8	9.3	
Operating range			Cooling Min / Max	°C	-10°C DB / +46°C DB	-10°C DB / +46°C DB	-10°C DB / +46°C DB	-10°C DB / +46°C DB
			Heating Min / Max	°C	-20°C WB / +18°C WB	-20°C WB / +18°C WB	-20°C WB / +18°C WB	-20°C WB / +18°C WB
			Simultaneous operation	°C	-10°C DB / +24°C DB	-10°C DB / +24°C DB	-10°C DB / +24°C DB	-10°C DB / +24°C DB

Solenoid valve kit		
KIT-P56HR3	KIT-P56HR3	3-Pipe control Solenoid valve kit (up to 5.6kW)
	CZ-P56HR3	Solenoid valve kit (up to 5.6kW)
	CZ-CAPE2	3-Pipe control PCB
KIT-P160HR3	KIT-P160HR3	3-Pipe control Solenoid valve kit (from 5.6kW to 10.6kW)
	CZ-P160HR3	Solenoid valve kit (from 5.6kW to 10.6kW)
	CZ-CAPE2	3-Pipe control PCB
CZ-CAPEK2		3-Pipe control PCB for wall mounted

3-Pipe control box kit*	
CZ-P456HR3	4 ports 3 pipe box (up to 5.6kW)
CZ-P656HR3	6 ports 3 pipe box (up to 5.6kW)
CZ-P856HR3	8 ports 3 pipe box (up to 5.6kW)
CZ-P4160HR3	4 ports 3 pipe box (from 5.6 to 10.6kW)

* Available from December 2015.

Rating Conditions: Cooling Indoor 27 °C DB / 19 °C WB. Cooling Outdoor 35 °C DB / 24 °C WB. Heating Indoor 20 °C DB. Heating Outdoor 7 °C DB / 6 °C WB. DB: Dry Bulb; WB: Wet Bulb

1) EER and COP classification is at 400 V in accordance with EU directive 2002/31/EC. Specifications subject to change without notice.

For detailed information about ErP, please visit our websites www.aircon.panasonic.co.uk or www.ptc.panasonic.eu

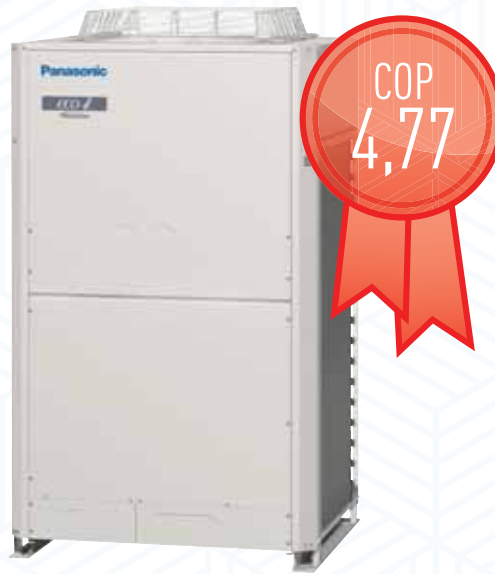

Technical focus

- Standardization of O_U to one compact casing size
- Improved operation efficiency
- The constant-speed compressor adopts a high-performance internal high-pressure scroll
- Improvement of the heat exchanger
- Redesign of structural parts
- Close side-by-side installation is possible

System limitations

Maximum number of combined outdoor units	3
Maximum HP of combined outdoor units	135 kW (48 HP)
Maximum number of connectable indoor units	52
Indoor/outdoor unit capacity ratio	50 -150%

Additional refrigerant charge

Liquid piping size	6.35	9.52	12.7	15.88	19.05	22.22	25.40
Amount of refrigerant charge (g/m)	26	56	128	185	259	366	490

Refrigerant piping

Piping size (mm)								
O material	Outer diameter	6.35	9.52	12.70	15.88	19.05	22.22	
	Wall thickness	0.80	0.80	0.80	1.00	1.00	1.15	
1/2 H, H material	Outer diameter	25.40	28.58	31.75	38.10	41.28		
	Wall thickness	1.00	1.00	1.10	over 1.35	over 1.45		

Note: When pipe bending is to be performed, the bending radius shall be at least 4 times the outer diameter. Also, take sufficient care to prevent pipe collapse and damage at the time of bending.

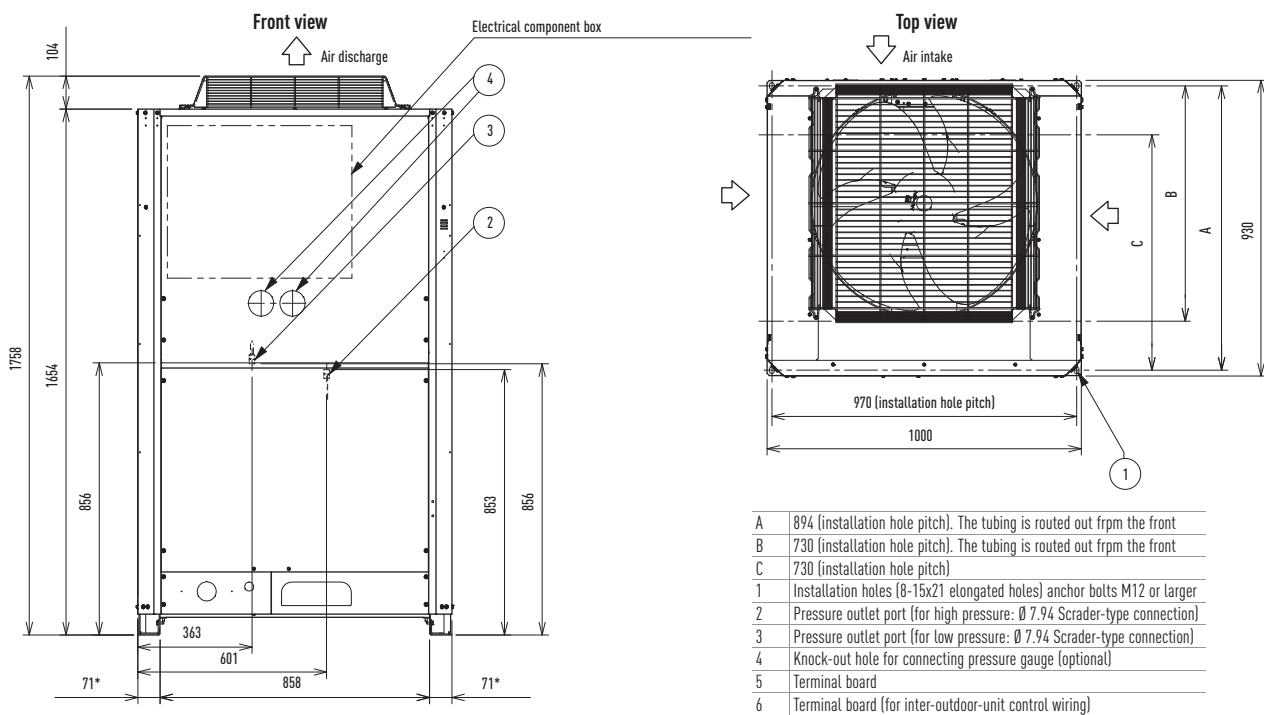

* Installation fixing bracket, installation side.

A	894 (installation hole pitch). The tubing is routed out from the front
B	730 (installation hole pitch). The tubing is routed out from the front
C	730 (installation hole pitch)
1	Installation holes (8-15x21 elongated holes) anchor bolts M12 or larger
2	Pressure outlet port (for high pressure: Ø 7.94 Scradler-type connection)
3	Pressure outlet port (for low pressure: Ø 7.94 Scradler-type connection)
4	Knock-out hole for connecting pressure gauge (optional)
5	Terminal board
6	Terminal board (for inter-outdoor-unit control wiring)

3-PIPE ECOi MF2 6N SERIES COMBINATION FROM 18 TO 48 HP

With simultaneous heating and cooling operation heat recovery type

ECOi 3-Pipe is one of the most advanced VRF systems available. Not only offering high-efficiency and performance for simultaneous heating and cooling, its sophisticated design makes installation and maintenance much easier.

- Achieves COP 4.63 as the top class in the industry (Average cooling and heating value for 18 HP outdoor unit).
- Simultaneous cooling or heating operation for up to 52 indoor units.
- Small installation space, top class in the industry.
- Rotation operation function and back-up operation function provided.



5 YEARS COMPRESSOR WARRANTY. Only for PRO partners.

HP			18 HP	20 HP	22 HP	24 HP	26 HP	28 HP	30 HP
Standard model			U-8MF2E8 U-10MF2E8	U-8MF2E8 U-12MF2E8	U-8MF2E8 U-14MF2E8	U-8MF2E8 U-16MF2E8	U-12MF2E8 U-14MF2E8	U-14MF2E8 U-16MF2E8	U-14MF2E8 U-16MF2E8
Power supply			380 / 400 / 415 V - Three Phase / 50 Hz						
Cooling capacity		kW	50.4	56.0	61.5	68.0	73.0	78.5	85.0
EER ¹⁾	Nominal	W/W	4.27	3.97	3.80	3.68	3.58	3.49	3.41
Running current	380 / 400 / 415 V	A	19.7 / 18.9 / 18.4	23.8 / 22.9 / 22.3	27.0 / 26.0 / 25.3	30.9 / 29.7 / 28.9	33.7 / 32.4 / 31.5	37.2 / 35.7 / 34.8	41.1 / 39.5 / 38.5
Power input		kW	11.8	14.1	16.2	18.5	20.4	22.5	24.90
Heating capacity		kW	56.5	63.0	69.0	76.5	81.5	87.5	95.0
COP ¹⁾	Nominal	W/W	4.63	4.47	4.57	4.20	4.38	4.49	4.20
Running current	380 / 400 / 415 V	A	20.4 / 19.6 / 19.1	23.8 / 22.9 / 22.3	25.2 / 24.2 / 23.6	30.4 / 29.2 / 28.5	31.1 / 29.8 / 29.1	32.6 / 31.3 / 30.5	37.7 / 36.2 / 35.3
Power input		kW	12.2	14.1	15.1	18.2	18.6	19.5	22.6
Air volume		m ³ /min	336	370	370	370	424	424	424
Sound pressure level	High / Low	dB(A)	61.0 / 58.0	62.5 / 59.5	63.0 / 60.0	63.0 / 60.0	64.5 / 61.5	65.0 / 62.0	65.0 / 62.0
Sound power level	Normal mode	dB	75.5 / 72.5	77.0 / 74.0	77.5 / 74.5	77.5 / 74.5	79.0 / 76.0	79.5 / 76.5	79.5 / 76.5
Dimensions	H x W x D	mm	1,758 x 2,060 x 930	1,758 x 2,060 x 930	1,758 x 2,060 x 930	1,758 x 2,060 x 930	1,758 x 2,060 x 930	1,758 x 2,060 x 930	1,758 x 2,060 x 930
Net weight		kg	538	538	591	591	636	644	644
Piping connections	Suction pipe	mm (Inch)	28.58 (1-1/8)	28.58 (1-1/8)	28.58 (1-1/8)	28.58 (1-1/8)	31.75 (1-1/4)	31.75 (1-1/4)	31.75 (1-1/4)
	Discharge pipe	mm (Inch)	22.22 (7/8)	22.22 (7/8)	25.40 (1)	25.40 (1)	25.40 (1)	28.58 (1-1/8)	28.58 (1-1/8)
	Liquid pipe	mm (Inch)	15.88 (5/8)	15.88 (5/8)	15.88 (5/8)	15.88 (5/8)	19.05 (3/4)	19.05 (3/4)	19.05 (3/4)
	Balance pipe	mm (Inch)	6.35 (1/4)	6.35 (1/4)	6.35 (1/4)	6.35 (1/4)	6.35 (1/4)	6.35 (1/4)	6.35 (1/4)
Refrigerant amount at shipment		kg	16.8	17.1	17.6	17.6	18.1	18.6	18.6
Operating range	Cooling Min / Max	°C	-10°C DB / +46°C DB	-10°C DB / +46°C DB	-10°C DB / +46°C DB	-10°C DB / +46°C DB	-10°C DB / +46°C DB	-10°C DB / +46°C DB	-10°C DB / +46°C DB
	Heating Min / Max	°C	-20°C WB / +18°C WB	-20°C WB / +18°C WB	-20°C WB / +18°C WB	-20°C WB / +18°C WB	-20°C WB / +18°C WB	-20°C WB / +18°C WB	-20°C WB / +18°C WB
	Simultaneous operation	°C	-10°C DB / +24°C DB	-10°C DB / +24°C DB	-10°C DB / +24°C DB	-10°C DB / +24°C DB	-10°C DB / +24°C DB	-10°C DB / +24°C DB	-10°C DB / +24°C DB

Solenoid valve kit		
KIT-P56HR3	KIT-P56HR3	3-Pipe control Solenoid valve kit (up to 5.6kW)
	CZ-P56HR3	Solenoid valve kit (up to 5.6kW)
	CZ-CAPE2	3-Pipe control PCB
KIT-P160HR3	KIT-P160HR3	3-Pipe control Solenoid valve kit (from 5.6kW to 10.6kW)
	CZ-P160HR3	Solenoid valve kit (from 5.6kW to 10.6kW)
	CZ-CAPE2	3-Pipe control PCB
CZ-CAPEK2		3-Pipe control PCB for wall mounted

3-Pipe control box kit*	
CZ-P456HR3	4 ports 3 pipe box (up to 5.6kW)
CZ-P656HR3	6 ports 3 pipe box (up to 5.6kW)
CZ-P856HR3	8 ports 3 pipe box (up to 5.6kW)
CZ-P4160HR3	4 ports 3 pipe box (from 5.6 to 10.6kW)

* Available from December 2015.

Rating Conditions: Cooling Indoor 27 °C DB / 19 °C WB. Cooling Outdoor 35 °C DB / 24 °C WB. Heating Indoor 20 °C DB. Heating Outdoor 7 °C DB / 6 °C WB. DB: Dry Bulb; WB: Wet Bulb

1) EER and COP classification is at 400 V in accordance with EU directive 2002/31/EC.

Specifications subject to change without notice.

For detailed information about ErP, please visit our websites www.aircon.panasonic.co.uk or www.ptc.panasonic.eu

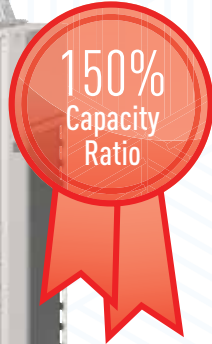

32 HP	34 HP	36 HP	38 HP	40 HP	42 HP	44 HP	46 HP	48 HP
U-16MF2E8 U-16MF2E8	U-8MF2E8 U-12MF2E8 U-14MF2E8	U-8MF2E8 U-14MF2E8 U-14MF2E8	U-8MF2E8 U-14MF2E8 U-16MF2E8	U-8MF2E8 U-14MF2E8 U-16MF2E8	U-14MF2E8 U-14MF2E8 U-14MF2E8	U-14MF2E8 U-14MF2E8 U-16MF2E8	U-14MF2E8 U-16MF2E8 U-16MF2E8	U-16MF2E8 U-16MF2E8 U-16MF2E8
380 / 400 / 415 V - Three Phase / 50 Hz								
90.0	96.0	101.0	107.0	113.0	118.0	124.0	130.0	135.0
3.38	3.74	3.66	3.60	3.55	3.48	3.43	3.40	3.38
43.9 / 42.2 / 41.1	42.9 / 41.2 / 39.7	46.1 / 44.3 / 43.1	49.6 / 47.6 / 46.4	53.1 / 51.0 / 49.7	56.0 / 53.8 / 52.4	59.6 / 57.3 / 55.8	63.8 / 61.3 / 59.7	65.9 / 63.3 / 61.7
26.6	25.7	27.6	29.7	31.8	33.9	36.1	38.2	39.9
100.0	108.0	113.0	119.0	127.0	132.0	138.0	145.0	150.0
4.03	4.44	4.52	4.33	4.12	4.46	4.30	4.14	4.03
41.7 / 40.1 / 39.1	41.0 / 39.4 / 38.4	41.6 / 39.9 / 38.9	46.1 / 44.3 / 43.1	52.2 / 49.6 / 47.8	49.3 / 47.3 / 46.1	53.8 / 51.6 / 50.3	58.8 / 56.5 / 55.0	62.6 / 60.1 / 58.6
24.8	24.3	25.0	27.5	30.8	29.6	32.1	35.0	37.2
424	582	582	582	582	636	636	636	636
65.0 / 62.0	65.0 / 62.0	65.5 / 62.5	65.5 / 62.5	65.5 / 62.5	67.0 / 64.0	67.0 / 64.0	67.0 / 64.0	67.0 / 64.0
79.5 / 76.5	79.5 / 76.5	80.0 / 77.0	80.0 / 77.0	80.0 / 77.0	81.5 / 78.5	81.5 / 78.5	81.5 / 78.5	81.5 / 78.5
1,758 x 2,060 x 930	1,758 x 3,120 x 930	1,758 x 3,120 x 930	1,758 x 3,120 x 930	1,758 x 3,120 x 930	1,758 x 3,120 x 930	1,758 x 3,120 x 930	1,758 x 3,120 x 930	1,758 x 3,120 x 930
644	905	913	913	913	966	966	966	966
31.75 (1-1/4)	31.75 (1-1/4)	38.10 (1-1/2)	38.10 (1-1/2)	38.10 (1-1/2)	38.10 (1-1/2)	38.10 (1-1/2)	38.10 (1-1/2)	38.10 (1-1/2)
28.58 (1-1/8)	28.58 (1-1/8)	28.58 (1-1/8)	31.75 (1-1/4)	31.75 (1-1/4)	31.75 (1-1/4)	31.75 (1-1/4)	31.75 (1-1/4)	31.75 (1-1/4)
19.05 (3/4)	19.05 (3/4)	19.05 (3/4)	19.05 (3/4)	19.05 (3/4)	19.05 (3/4)	19.05 (3/4)	19.05 (3/4)	19.05 (3/4)
6.35 (1/4)	6.35 (1/4)	6.35 (1/4)	6.35 (1/4)	6.35 (1/4)	6.35 (1/4)	6.35 (1/4)	6.35 (1/4)	6.35 (1/4)
18.6	26.4	26.9	26.9	26.9	27.9	27.9	27.9	27.9
-10°C DB / +46°C DB	-10°C DB / +46°C DB	-10°C DB / +46°C DB	-10°C DB / +46°C DB	-10°C DB / +46°C DB	-10°C DB / +46°C DB	-10°C DB / +46°C DB	-10°C DB / +46°C DB	-10°C DB / +46°C DB
-20°C WB / +18°C WB	-20°C WB / +18°C WB	-20°C WB / +18°C WB	-20°C WB / +18°C WB	-20°C WB / +18°C WB	-20°C WB / +18°C WB	-20°C WB / +18°C WB	-20°C WB / +18°C WB	-20°C WB / +18°C WB
-10°C DB / +24°C DB	-10°C DB / +24°C DB	-10°C DB / +24°C DB	-10°C DB / +24°C DB	-10°C DB / +24°C DB	-10°C DB / +24°C DB	-10°C DB / +24°C DB	-10°C DB / +24°C DB	-10°C DB / +24°C DB

Technical focus

- Standardization of O_U to one compact casing size
- Improved operation efficiency
- The constant-speed compressor adopts a high-performance internal high-pressure scroll
- Improvement of the heat exchanger
- Redesign of structural parts
- Close side-by-side installation is possible

System Example

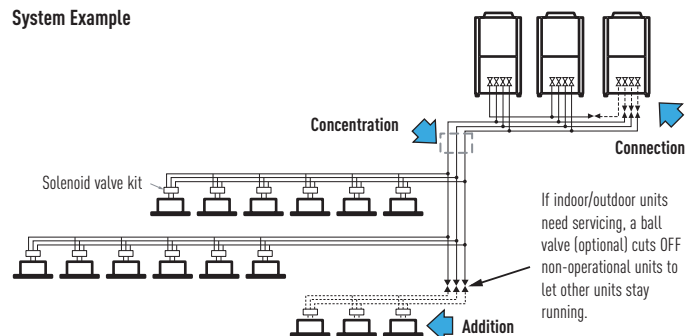

- Panasonic makes it possible to link outdoor units together for a large capacity (48 HP)
- Since all pipes are concentrated into one pipe shaft, you can minimise pipe space and construction labour.
- If your indoor capacity load changes in the future, it's easy to add on both indoor and outdoor units using the same pipings. If the additional instalment of outdoor and indoor units is expected, the size of refrigerant piping should be decided according to the total capacity after the addition.

3-PIPE ECOi MF2 6N SERIES HIGH EFFICIENCY COMBINATION 16 TO 32 HP

With simultaneous heating and cooling operation heat recovery type

ECOi 3-Pipe is one of the most advanced VRF systems available. Not only offering high-efficiency and performance for simultaneous heating and cooling, its sophisticated design makes installation and maintenance much easier.

- Achieves COP 4.76 as the top class in the industry (Average cooling and heating value for 8 HP outdoor unit).
- Simultaneous cooling or heating operation for up to 52 indoor units.
- Small installation space, top class in the industry.
- Rotation operation function and back-up operation function provided.



5 YEARS COMPRESSOR WARRANTY. Only for PRO partners.

HP			16 HP	24 HP	26 HP	28 HP	30 HP	32 HP
High Efficiency model			U-8MF2E8 U-8MF2E8	U-8MF2E8 U-8MF2E8 U-8MF2E8	U-8MF2E8 U-8MF2E8 U-10MF2E8	U-8MF2E8 U-8MF2E8 U-12MF2E8	U-8MF2E8 U-8MF2E8 U-14MF2E8	U-8MF2E8 U-12MF2E8 U-12MF2E8
Power supply			380 / 400 / 415 V - Three Phase / 50 Hz	380 / 400 / 415 V - Three Phase / 50 Hz	380 / 400 / 415 V - Three Phase / 50 Hz	380 / 400 / 415 V - Three Phase / 50 Hz	380 / 400 / 415 V - Three Phase / 50 Hz	380 / 400 / 415 V - Three Phase / 50 Hz
Cooling capacity		kW	45.0	68.0	73.0	78.5	85.0	90.0
EER ¹⁾	Nominal	W/W	4.50	4.47	4.32	4.11	3.94	3.86
Running current	380 / 400 / 415 V	A	17.3 / 16.4 / 16.0	26.2 / 24.9 / 24.3	28.5 / 27.4 / 26.7	32.2 / 31.0 / 30.2	36.5 / 35.0 / 34.1	38.9 / 37.4 / 36.4
Power input		kW	10.0	15.2	16.9	19.1	21.6	23.3
Heating capacity		kW	50.0	76.5	81.5	87.5	95.0	100.0
COP ¹⁾	Nominal	W/W	4.76	4.72	4.68	4.56	4.59	4.41
Running current	380 / 400 / 415 V	A	17.9 / 17.0 / 16.6	27.7 / 26.3 / 25.6	29.4 / 27.9 / 27.5	32.4 / 31.1 / 30.4	35.0 / 33.6 / 32.7	38.3 / 36.8 / 35.9
Power input		kW	10.5	16.2	17.4	19.2	20.7	22.7
Air volume		m ³ /min	316	474	494	528	528	582
Sound pressure level	High / Low	dB(A)	60.0 / 57.0	62.0 / 59.0	62.5 / 59.5	63.5 / 60.5	64.0 / 61.0	65.0 / 62.0
Sound power level	Normal mode	dB	74.5 / 71.5	76.5 / 73.5	77.0 / 74.0	78.0 / 75.0	78.5 / 75.5	79.5 / 76.5
Dimensions (Combination)	H x W x D	mm	1,758 x 2,060 x 930	1,758 x 3,120 x 930	1,758 x 3,120 x 930	1,758 x 3,120 x 930	1,758 x 3,120 x 930	1,758 x 3,120 x 930
Net weight		kg	538	807	807	852	860	897
Piping connections	Suction pipe	mm	28.58 (1-1/8)	28.58 (1-1/8)	31.75	31.75 (1-1/4)	31.75 (1-1/4)	31.75 (1-1/4)
	Discharge pipe	mm	22.22 (7/8)	25.40 (1)	25.40 (1)	28.58 (1-1/8)	28.58 (1-1/8)	28.58 (1-1/8)
	Liquid pipe	mm	12.70 (1/2)	15.88 (5/8)	19.05 (3/4)	19.05 (3/4)	19.05 (3/4)	19.05 (3/4)
	Balance pipe	mm	6.35 (1/4)	6.35 (1/4)	6.35 (1/4)	6.35 (1/4)	6.35 (1/4)	6.35 (1/4)
Refrigerant amount at shipment		kg	16.6	24.9	25.1	25.4	25.9	25.9
Operating range	Cooling Min / Max	°C	-10°C DB / +46°C DB	-10°C DB / +46°C DB	-10°C DB / +46°C DB	-10°C DB / +46°C DB	-10°C DB / +46°C DB	-10°C DB / +46°C DB
	Heating Min / Max	°C	-20°C WB / +18°C WB	-20°C WB / +18°C WB	-20°C WB / +18°C WB	-20°C WB / +18°C WB	-20°C WB / +18°C WB	-20°C WB / +18°C WB
	Simultaneous operation	°C	-10°C DB / +24°C DB	-10°C DB / +24°C DB	-10°C DB / +24°C DB	-10°C DB / +24°C DB	-10°C DB / +24°C DB	-10°C DB / +24°C DB

Solenoid valve kit		
KIT-P56HR3	KIT-P56HR3	3-Pipe control Solenoid valve kit (up to 5.6kW)
	CZ-P56HR3	Solenoid valve kit (up to 5.6kW)
	CZ-CAPE2	3-Pipe control PCB
KIT-P160HR3	KIT-P160HR3	3-Pipe control Solenoid valve kit (from 5.6kW to 10.6kW)
	CZ-P160HR3	Solenoid valve kit (from 5.6kW to 10.6kW)
	CZ-CAPE2	3-Pipe control PCB
CZ-CAPEK2		3-Pipe control PCB for wall mounted

3-Pipe control box kit*	
CZ-P456HR3	4 ports 3 pipe box (up to 5.6kW)
CZ-P656HR3	6 ports 3 pipe box (up to 5.6kW)
CZ-P856HR3	8 ports 3 pipe box (up to 5.6kW)
CZ-P4160HR3	4 ports 3 pipe box (from 5.6 to 10.6kW)

* Available from December 2015.

Rating Conditions: Cooling Indoor 27 °C DB / 19 °C WB. Cooling Outdoor 35 °C DB / 24 °C WB. Heating Indoor 20 °C DB. Heating Outdoor 7 °C DB / 6 °C WB.
DB: Dry Bulb; WB: Wet Bulb

1) EER and COP classification is at 400 V in accordance with EU directive 2002/31/EC.
Specifications subject to change without notice.

For detailed information about ErP, please visit our websites www.aircon.panasonic.co.uk or www.ptc.panasonic.eu

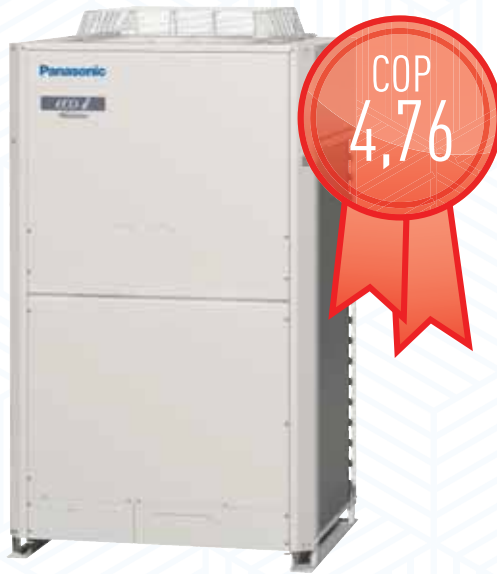

Technical focus

- Standardization of O_U to one compact casing size
- Improved operation efficiency
- The constant-speed compressor adopts a high-performance internal high-pressure scroll
- Improvement of the heat exchanger
- Redesign of structural parts
- Close side-by-side installation is possible

Market-leading COP (at full load), standard efficiency

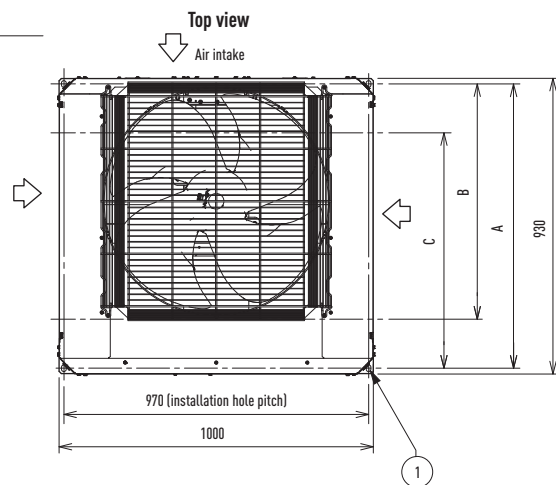
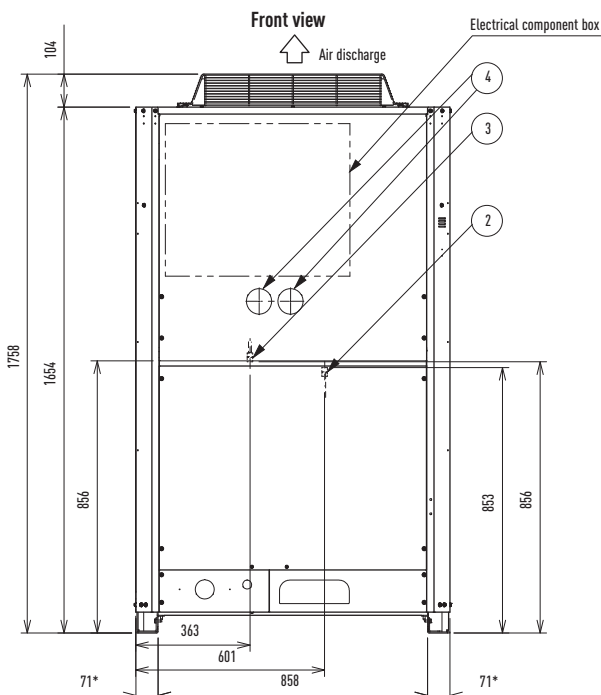
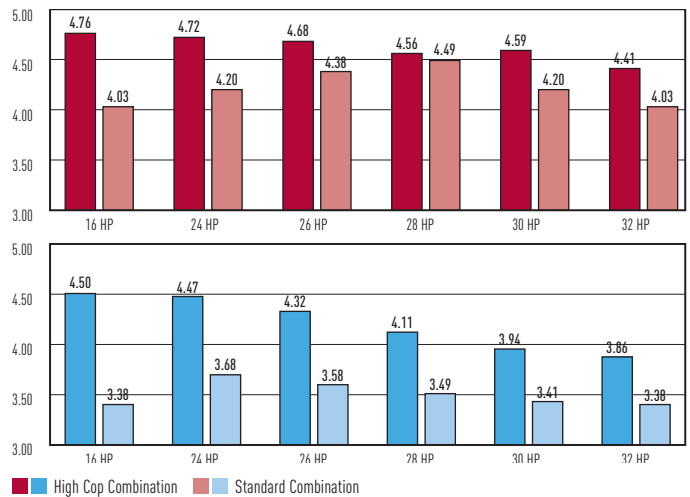

A	894 (installation hole pitch). The tubing is routed out from the front
B	730 (installation hole pitch). The tubing is routed out from the front
C	730 (installation hole pitch)
1	Installation holes (8-15x21 elongated holes) anchor bolts M12 or larger
2	Pressure outlet port (for high pressure: \varnothing 7.94 Scradler-type connection)
3	Pressure outlet port (for low pressure: \varnothing 7.94 Scradler-type connection)
4	Knock-out hole for connecting pressure gauge (optional)
5	Terminal board
6	Terminal board (for inter-outdoor-unit control wiring)

* Installation fixing bracket, installation side.



High savings

ECO G

ECO G

Panasonic introducing the gas driven VRF

Panasonic's GHP range is extensive and covers the 2-Pipe and 3-Pipe system. Our GHP VRF range of commercial systems is leading the industry in the development of efficient and flexible systems, and is the natural choice for commercial projects, especially those where power restrictions apply. As you would expect, all our gas-driven VRF systems have the highest reliability rates in the industry and a leading customer service programme. The torque and rpm control functions of the GHP's motor are comparable with an inverter-type electric air conditioner. Thus, the GHP ensures individual, and efficient control and performance - just as you expect from an electric inverter controlled air conditioner.

Easy to position

- Up to 71 kW of cooling from a current consumption of 0,1 kW/h
- Single Phase power supply across the range
- The option of natural gas or LPG as its main power source
- Embedded Water Heat Exchanger to connect to domestic hot water systems 16–25 HP (2-Pipe units only)
- Option of DX or chilled water for indoor heat exchange
- Reduced CO₂ emissions

ECO G and ECO G Multi, S Series

The advanced Gas Driven VRF system offers increased efficiency and performance across the range. Now more powerful than ever before, it can connect up to 48 indoor units. Improvements include increased part load performance, reduced gas consumption with a Miller-cycle engine and reduced electrical consumption by using DC fan motors.

ECO G High Power

1% this is what the new ECO G High Power is consuming versus your Electrical VRF. Your savings start now! Ideal for locations with low electricity grid, for chiller, ventilation and air conditioning application.



ECO G and ECO G Multi

The S Series 2-Pipe not only offers improved performance but also increased flexibility.



ECO G 3 Way

3 Way heat recovery system with simultaneous heating & cooling.



ECO G and ECO G Multi benefits

High-efficiency operation

All models are equipped with a high-performance air exchanger and a newly developed refrigerant heat exchanger for high efficiency operation, making them one of the most energy efficient solutions on the market.

Lowest nitrogen oxide emissions

The GHP VRF systems have the lowest nitrogen oxide emissions. In a pioneering development, the Panasonic GHP features a brand new lean-burn combustion system that utilises air fuel ratio feedback control to reduce NOx emissions to an all time low.

High performance

With its advanced heat exchanger design, this new GHP system offers improved efficiency and reduced running costs, which, coupled with improved engine management systems, have greatly improved the system COP rating.

Excellent economy

The Panasonic GHP provides quick and powerful cooling/heating and increases delivery of heat into the space by the efficient recovery of heat from the engine cooling water, which is injected into the refrigerant circuit by a highly efficient plate heat exchanger. In addition, the use of engine waste heat ensures that our gas heat pump air conditioner requires no defrost cycle, therefore providing continuous 100% heating performance in severe weather conditions with an outside air temperature as low as -20°C. During cooling mode the rejected heat from the engine is available for use with in a DHW system and can supply up to 30 kW of hot water at 75°C. The DHW is also available in heating when the outside air temp is above 7°C.

Water chiller option

Our GHP system is also available with a water chiller option, which can be combined with individual outdoor units or as part of a DX chilled water mix of indoor units. The system can be operated via a BMS system or a Panasonic supplied control panel, with chilled water set points from -15°C – +15°C and heating set points 35°C – +55°C.

No defrost requirements



Below 4°C ambient in heating mode, the outdoor fans switch OFF, saving further running costs and CO₂ emissions.

ECO G with Water Heat Exchanger for chilled and hot water production

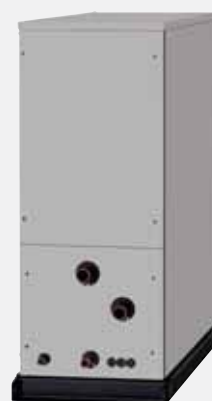
For hydronic applications.



ECO G Outdoor Units Range

	16 HP	20 HP	25 HP	30 HP	32 HP	36 HP	40 HP	45 HP	50 HP
Capacity (Cooling / Heating)	45.00 / 50.00 kW	56.00 / 63.00 kW	71.00 / 80.00 kW	85.00 / 95.00 kW	90.00 / 100.00 kW	101.00 / 113.00 kW	112.00 / 126.00 kW	127.00 / 143.00 kW	142.00 / 160.00 kW
									
ECO G High Power	U-16GEP2E5	U-20GEP2E5	U-25GEP2E5						
ECO G and ECO G Multi	U-16GE2E5	U-20GE2E5	U-25GE2E5	U-30GE2E5	U-16GE2E5 U-16GE2E5	U-16GE2E5 U-20GE2E5	U-20GE2E5 U-20GE2E5	U-20GE2E5 U-25GE2E5	U-25GE2E5 U-25GE2E5
ECO G 3 Way	U-16GF2E5	U-20GF2E5	U-25GF2E5						

Comparison of heating capacity

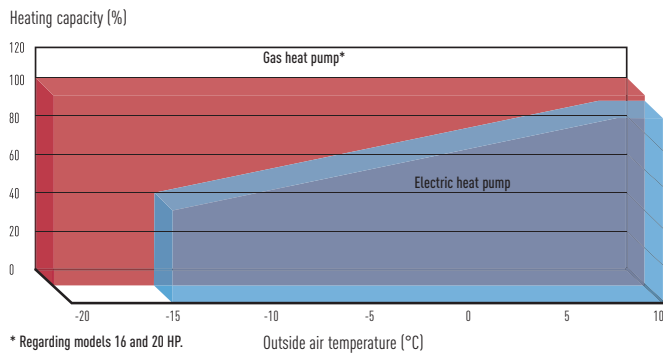

Comparison of the start times for heating operation

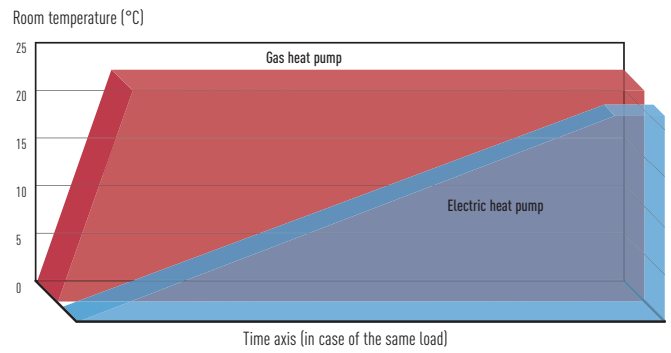

The Gas Heat Pump (GHP)

Panasonic Gas Heat Pump is the natural choice for commercial projects, especially for those projects where power restrictions apply. As you would expect, all of our Gas Driven VRF systems are designed to give the highest reliability rates. The GHP engine or (internal combustion engine) varies the engine speed to match the building load functions that are comparable with an inverter type electric air conditioner.

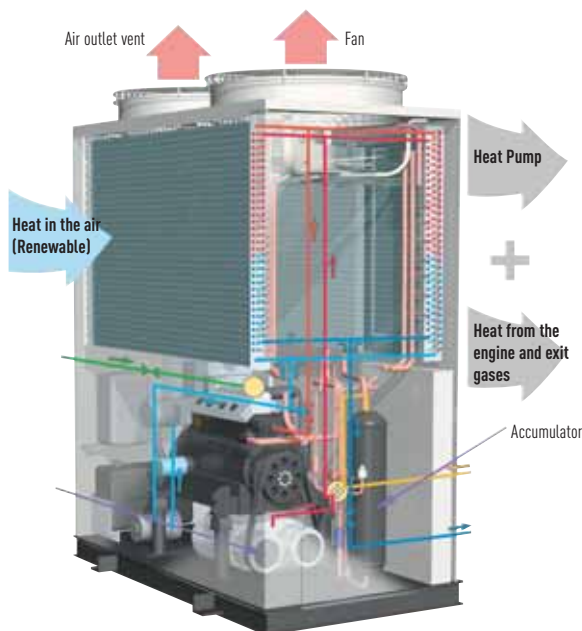

Power supply problems?

If you are short of electrical power, our gas heat pump could be the perfect solution:

- Runs on natural gas or LPG and just needs Single Phase supply
- Enables the building's electrical power supply to be used for other critical electrical demands
- Reduces capital cost to upgrade power substations to run heating and cooling systems
- Reduces power loadings within a building especially during peak periods
- Electricity supply freed up for other uses such as IT servers, commercial refrigeration, manufacturing, lighting etc.

GHP Outdoor Heat Exchanger

- Integrated DX and hot water coil
- No defrost required
- Faster reaction to demand for heating

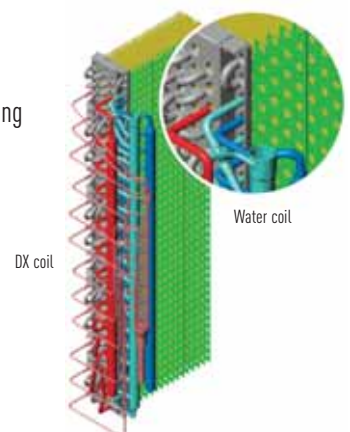



ECO G High Power

2-Pipe Heat Pump System with Electrical Power Generator

Production of electricity

Generates up to 2 kW depending on air conditioning load.

Panasonic innovates again introducing a new GHP producing his own electricity.

Equipped with a small, high-performance generator. Compressor and generator are driven by gas engine. The generated electricity is used for the fan motor and cooling water pump of its own unit. The generating efficiency is more than 40%.

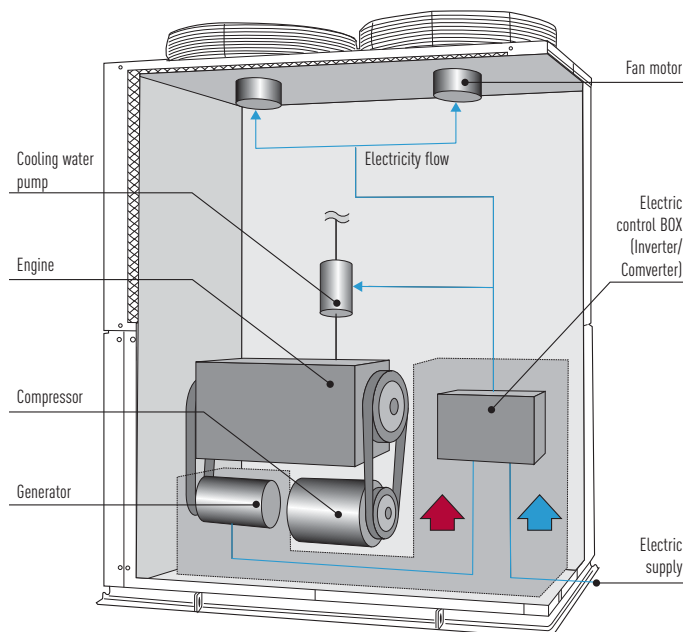

ECO G High Power

GHP with electrical generator. Only consumes 1% of the electricity required by standard VRF systems!

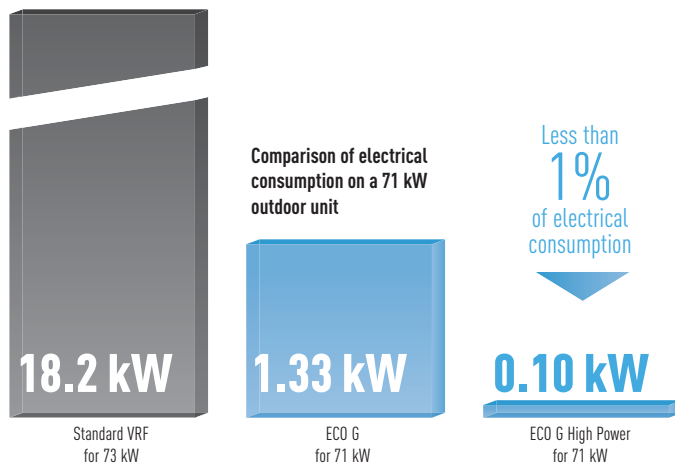

ECO G High Power, ECO G and ECO G Multi

2-Pipe Heat Pump System

Easy to add additional units in the future

Load can easily be increased in the future by the addition of indoor and outdoor units without having to plumb pipe shafts.

* When specifying refrigerant pipe work, please choose the size according to the horsepower after the increase of units.

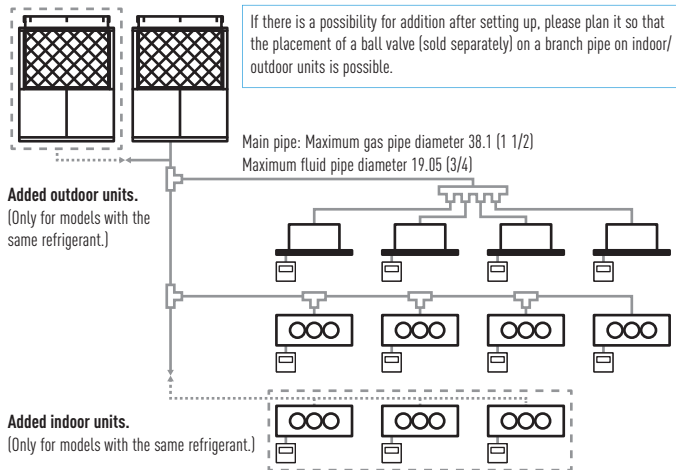

Maximum possible number of outdoor units to be combined	2 units
Maximum horsepower of combined outdoor units	50 HP
Maximum possible number of indoor units to be connected	48 units ¹
Indoor/outdoor units capacity ratio	50%~130% ²

1) When 2 outdoor units are connected. 2) Capacity of indoor units connection is: Minimum; 50% of the capacity of the smallest outdoor unit within the system, Maximum; 130%: total capacity of the system outdoor units. Indoor units are same as multi series for buildings.

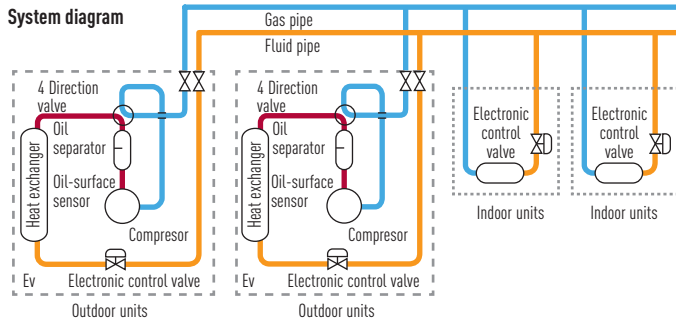

Saving Energy

- Energy savings achieved by the appropriate capacity.
- Equational program function.

Energy savings are achieved by the appropriate load divider function, which enables efficient operation by concentrating the cooling/heating capacity to one outdoor unit and stopping the other. Compared to conventional machines with a similar COP, this function allows energy savings and thus reduces the running costs, especially in part-load seasons like spring and autumn.

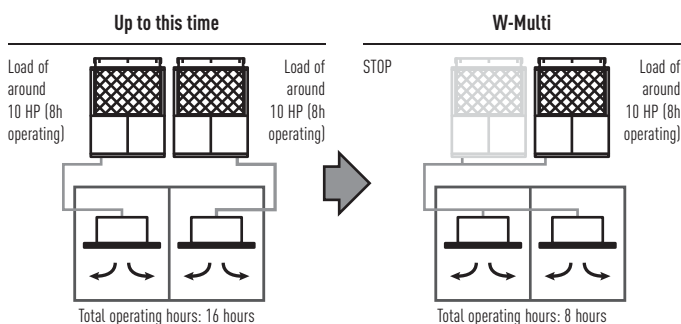

Non-stop operation, even during maintenance

- System will not stop even during maintenance, due to Manual Backup Operating Function.
 - Maintenance is possible during weekdays because it can continue operating during maintenance.
 - Automatic Backup Operating Function enables continuous operation.
- If one outdoor unit stops the backup function will automatically start on the remaining unit and continue operating. During service intervals, the system being serviced can be isolated by a closing valve in the outdoor unit, enabling continuous operation with the still operative outdoor unit.

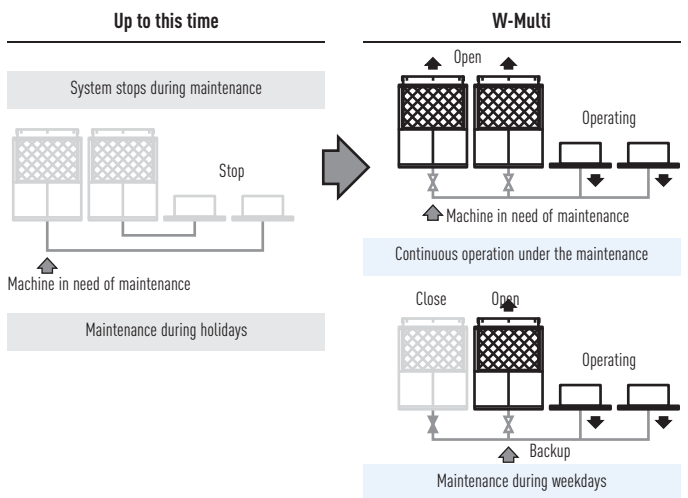

Long lifetime

- Renewal period prolonged due to rotation function.
- Rotation function, which is run from outdoor units with low operating time, will average the operating hours of each outdoor unit. This extends the periods between maintenance or replacement.

Example of the rotation function

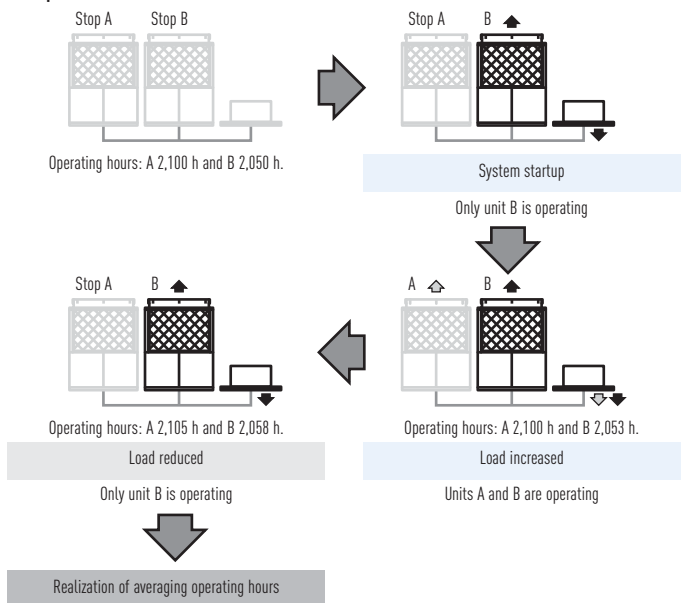

ECO G 3 Way

Ease of construction

• By using common header pipe work the installation cost and time is significantly reduced.

By combining all pipes, which were needed for each indoor unit, into a common pipe in each system, the number of pipes are reduced by half* which leads to ease of construction. Furthermore, space of pipes within pipe shafts can be reduced by 2/3.*

Combining all pipes, which were needed for each outdoor unit, into a pipe in each system. (Number of pipes is reduced by half).

*System with approximately 40HP (20HP x 2 units)

Example of a system with approximately 40 HP

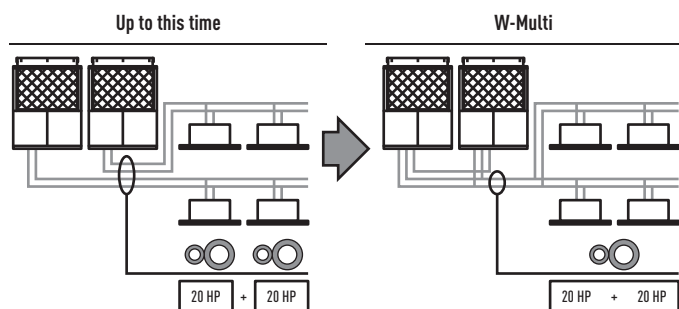

Hot Water Supply Function

• System Advantage.

The engine waste heat, which is normally exhausted into the atmosphere, is recovered via the heat exchanger and effectively used to heat water, so the GHP Chiller acts as embedded sub system that alleviates the load on the client's main hot water system, and therefore offers 'free' hot water.

Capacity at cooling standard point		Outlet temperature 75°C	
Outdoor unit	U-16GE2E5	kW	15.00
	U-20GE2E5		20.00
	U-25GE2E5		30.00
	U-30GE2E5		30.00
Hot water piping allowable pressure		MPa	0.7
Hot water circulation rate		m ³ /h	3.9
Hot water tube size		Rp	3/4

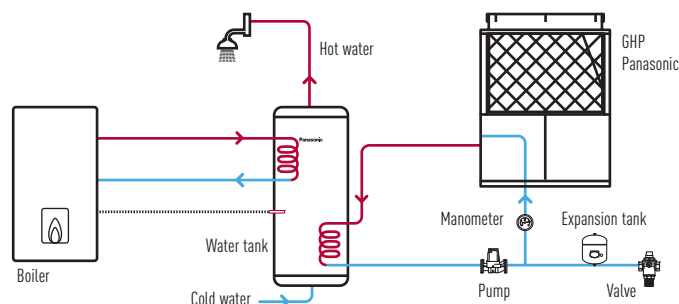
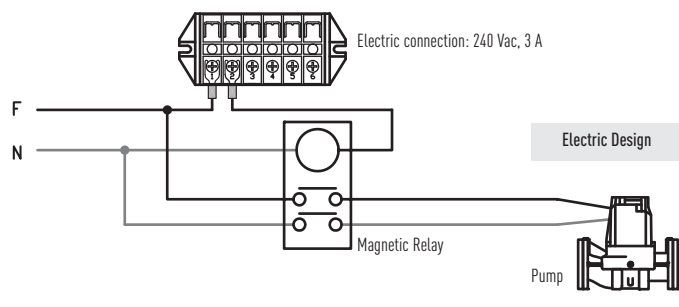

• All the items illustrated in this drawing (except the outdoor unit) are not supplied by Panasonic.
• During start up, set temperature value of the water in the outdoor unit's parameter.

Excellent performance

Panasonic 3 WAY Multi system is capable of simultaneous heating/cooling and individual operation of each indoor unit by only one outdoor unit. As a result, efficient individual air conditioning is possible in buildings having diverse room temperatures.

System example

Improved maintenance intervals. The unit only needs to be serviced every 10,000 hours. This is the best in the industry.

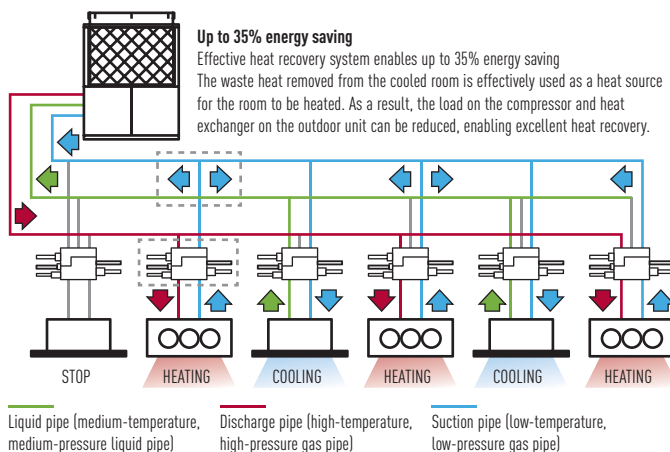

Solenoid valve kit

To be fitted on all 'zones' to allow simultaneous heating and cooling. Up to 36 indoor units are capable of simultaneous heating/cooling operation. Oil-recovery operation to gives more stable comfort air-conditioning control.

3-Pipe control Solenoid valve kit



CZ-P56HR3

Up to 5.6 kW
CZ-P160HR3
From 5.7 to 16 kW

KIT-P56HR3

(CZ-P56HR3+CZ-CAPE2)
KIT-P160HR3
(CZ-P160HR3+CZ-CAPE2)

3-Pipe control PCB



3-Pipe control PCB CZ-CAPE2*

Must be added to the CZ-P56HR3 OR CZ-P160HR3.
* For wall mounted.

Valve Dimensions

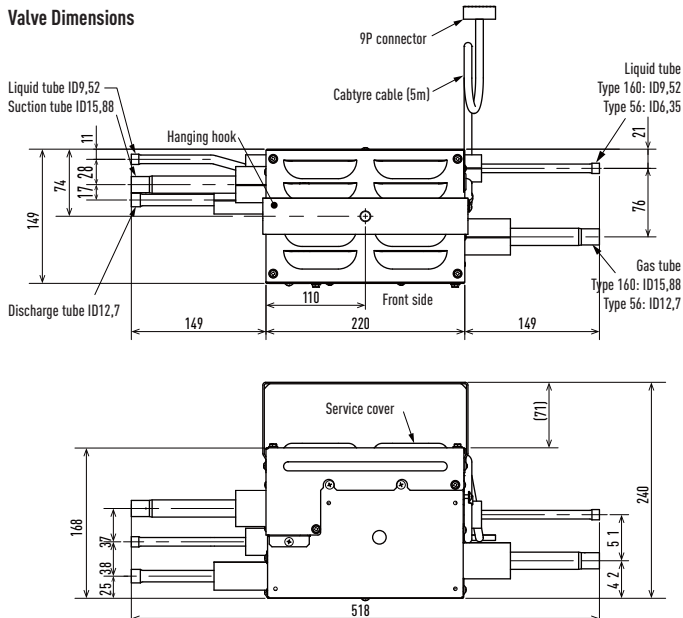



ECO G Water Heat Exchanger for hydronic applications

Connection to chilled water coils in air handling equipment.

Air Handling application

When a top London restaurant opened, it needed large volumes of fresh air to ensure the optimum dining environment. GHP units connected to the cooling coils within the air handling equipment ensured the air was introduced in the right condition in both summer and winter.



Chiller replacement. Chilled water supply to fan coils.

Chiller replacement

When some old chillers needed replacing at the end of their operational lifetime, GHPs with Water Heat Exchangers enabled the project to be carried out in stages whilst still utilising the existing water pipe work and fan coils. This enabled the project to be delivered on time, to a restricted budget and avoided all issues regarding refrigerant in confined spaces.



Connection to 'close control' computer equipment.

Computer room applications

When all available electrical power needed to be utilised for the IT equipment for a leading international bank, the cooling load of over 450 kW had to be powered by gas. The outdoor units were connected via Water Heat Exchangers to cooling coils inside the 'close control' units thereby maintaining a conditioned environment for temperature and humidity. By utilising the hot water function over 100 kW of hot water are supplied to the building and therefore the additional benefit of considerable CO₂ savings is ensured.

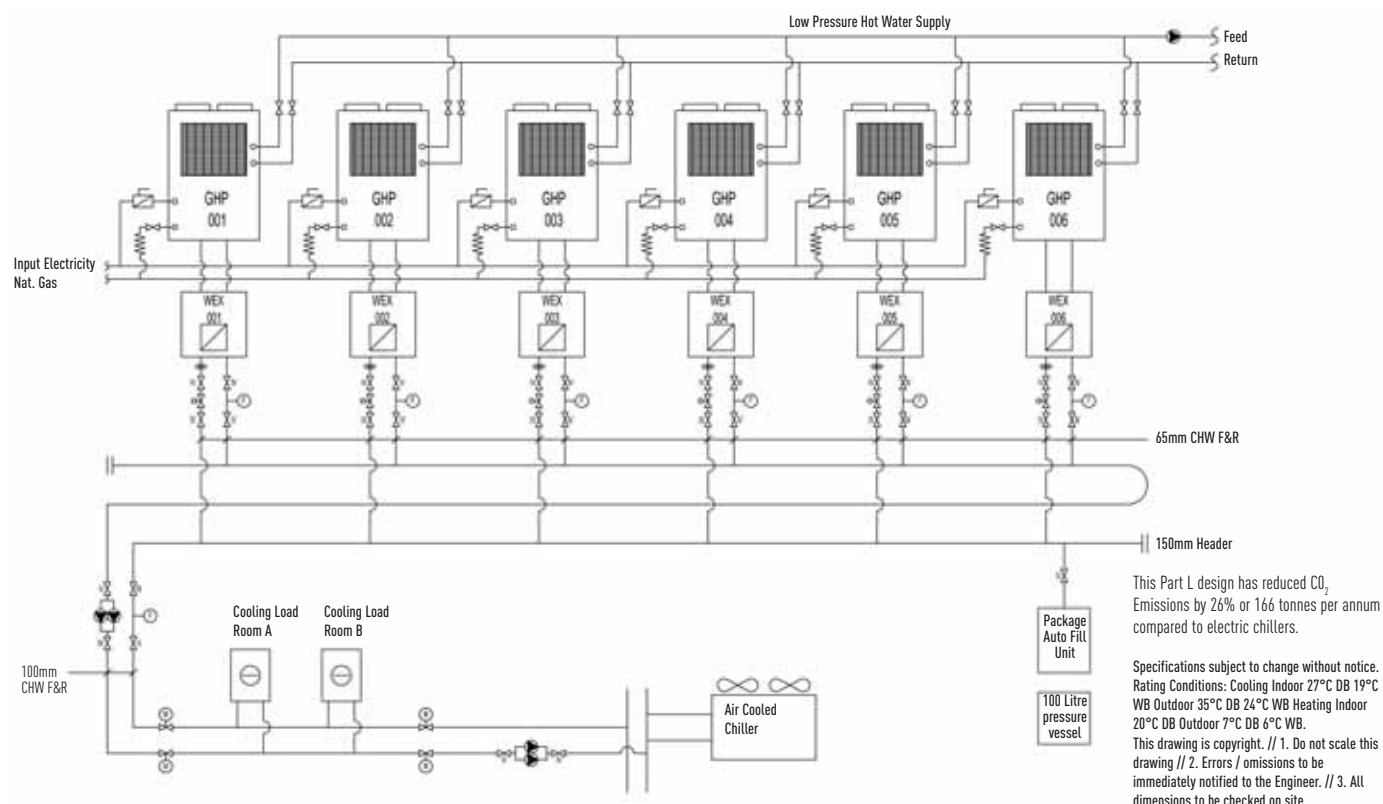

This Part L design has reduced CO₂ Emissions by 26% or 166 tonnes per annum compared to electric chillers.

Specifications subject to change without notice.
 Rating Conditions: Cooling Indoor 27°C DB 19°C WB
 Outdoor 35°C DB 24°C WB Heating Indoor 20°C DB Outdoor 7°C DB 6°C WB.
 This drawing is copyright. // 1. Do not scale this drawing // 2. Errors / omissions to be immediately notified to the Engineer. // 3. All dimensions to be checked on site.

ECO G HIGH POWER

The 2-Pipe Gas Driven VRF with an electrical power generator

ECO G High Power is a revolution in air conditioning design. Fitted with a permanent magnet, non-bearing type generator, it is the first VRF system that can supply heating, cooling, hot water and now also supply electrical power. Each ECO G High Power unit has a 2.0 kW generator, drastically reducing the outdoor unit's electricity consumption.



5 YEARS COMPRESSOR WARRANTY. Only for PRO partners.

HP			16 HP	20 HP	25 HP
Model			U-16GEP2E5	U-20GEP2E5	U-25GEP2E5
Cooling capacity		kW	45.00	56.00	71.00
Hot water (cooling mode)		kW	15.0	20.0	30.0
Power Input		kW	0.1 (220-230) 0.36 (240)	0.1 (220-230) 0.36 (240)	0.1 (220-230) 0.36 (240)
EER	Nominal	W/W			
Max COP (inc hot water)					
Gas consumption		kW	31.3	41.4	63.5
Heating capacity	STD / Low temp ¹	kW	50.0 / 53.0	63.0 / 67.0	80.0 / 78.0
Power Input		kW	0.1 (220-230) 0.36 (240)	0.1 (220-230) 0.36 (240)	0.1 (220-230) 0.36 (240)
COP	Nominal	W/W			
Gas consumption	STD	kW	33.8	43.9	55.1
	Low temperature ¹	kW			
COP	Average				
Starter amperes		A	30	30	30
Sound pressure level		dB(A)	57	58	62
Dimensions	H x W x D	mm	2,273 x 1,650 x 1,000 (+80)	2,273 x 1,650 x 1,000 (+80)	2,273 x 1,650 x 1,000 (+80)
Net weight		kg	770	795	825
Pipe Connections	Gas	Inch (mm)	1 1/8 (28.58)	1 1/8 (28.58)	1 1/8 (28.58)
	Liquid	Inch (mm)	1/2 (12.70)	5/8 (15.88)	5/8 (15.88)
	Fuel gas		R3/4 (bolt thread)	R3/4 (bolt thread)	R3/4 (bolt thread)
	Exhaust drain port	mm	25	25	25
Indoor/outdoor capacity ratio			50-200% ²	50-200% ²	50-200% ²
Number of connections indoor ²			24	24	24

Service kits model	Kit CZ-PSK560SP
Outdoor unit reference	U-16GEP2E5 / U-20GEP2E5 / U-25GEP2E5
Material included	
Oil Filter	1
Air Cleaner Element	1
Plug	4
V BELT (for compressor)	1
V Belt (for generator)	1
Oil Strainer	1
Drain Filter Packing	1

Rating Conditions: Cooling Indoor 27°C DB / 19°C WB. Cooling Outdoor 35°C DB. Heating (standard) Indoor 20°C DB. Heating (standard) Outdoor 7°C DB / 6°C WB. Heating (low temp.) Indoor 20°C DB / 15°C WB or less. Heating (low temp.) Outdoor 2°C DB / 1°C WB. DB: Dry Bulb; WB: Wet Bulb

1) Low temp condition: outdoor temperature 2°C.
2) Indoor unit can be connected to up to 16 kW model (model size 160)
Specifications subject to change without notice.

Cooling and heating capacities in the tables are determined under the test conditions of JIS B 8627.
Effective heating requires that the outdoor air intake temperature be at least -20°C DB or -21°C WB.

- Gas consumption is the total (high) calorific value standard. - Outdoor unit operating sound is measured 1 meter from the front and 1.5 meters above the floor (in an anechoic environment). Actual installations may have larger values due to ambient noise and reflections. - Specifications are subject to change without notice. - Hot water heating capacity is applicable during cooling operation. - The maximum water temperature that can be obtained is 75°C. Water heating performance and temperature vary with the air conditioning load. Because the hot water heating system uses waste heat from the engine, which runs the air conditioning, its ability to heat water is not guaranteed.



Technical focus

- 2-Pipe air conditioning system providing cooling or heating
- Up to 2 kW electricity generated (used on the outdoor unit)
- Very efficient generator
- Can connect to up to 24 indoor units
- IU/OU capacity ratio 50–200%
- 15 to 30 kW hot water generation capacity
- Free Hot water provided when in cooling throughout temperature range and in heating when the ambient is above 7°C*
- 200 m maximum allowable piping length (L1)

* Referring to outside temperature.

Generates electricity during heating or cooling operation

Generates electricity and air conditioning (heating or cooling) at the same time by using remaining engine power. ECO G High Power can generate 2.0 kW electricity at a generation efficiency of more than 40%.

Service clearances for installation

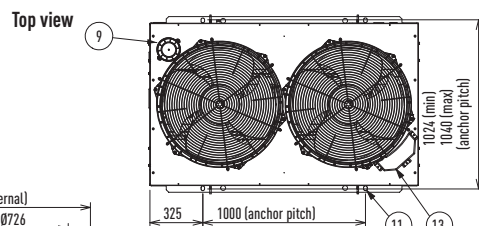
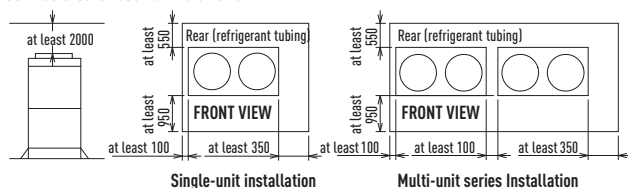

kW	45.0	56.0-71.0
1 Suction refrigerant pipe	Ø 28.58	
2 Liquid refrigerant pipe	Ø 12.7	Ø 15.88
3 Exhaust gas drain port	HOSE OD Ø 25 (accessory)	
4 Electrical power supply port	Ø 28	
5 Inter-unit cable port	Ø 28	
6 Fuel gas port	R3/4	
7 Condensation drain opening	Ø 20	
8 Rain and condensation outlet		
9 Engine exhaust outlet		
10 Suspension holes 4-Ø 20x30		
11 Anchor holes 4-Ø 22x30		
12 Segmented display		
13 Coolant intake (top)		
14 Vent		
15 Hot water inlet	Rp 3/4	
16 Hot water outlet	Rp 3/4	

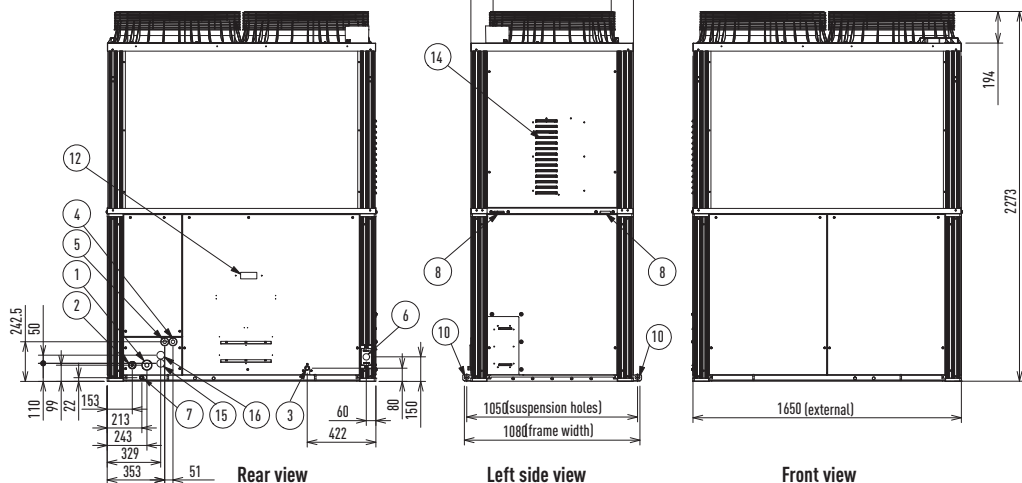

ECO G AND ECO G MULTI

2-Pipe Heat Pump System

ECO G and ECO G Multi 2-Pipe for Heat Pump Applications.

The S Series 2-Pipe not only offers improved performance but also increased flexibility. Now available as multi-systems, many combinations are possible, from 16 HP to 50 HP, allowing for more power and enabling accurate matching of a system building load. Additional new features include part load engine management and compressor run hour equalisation.



5 YEARS COMPRESSOR WARRANTY. Only for PRO partners.

HP		16 HP	20 HP	25 HP	30 HP	32 HP	36 HP*	40 HP*	45 HP*	50 HP
Model		U-16GE2E5	U-20GE2E5	U-25GE2E5	U-30GE2E5	U-16GE2E5 U-16GE2E5	U-16GE2E5 U-20GE2E5	U-20GE2E5 U-20GE2E5	U-20GE2E5 U-25GE2E5	U-25GE2E5 U-25GE2E5
Cooling capacity	kW	45.00	56.00	71.00	85.00	90.00	101.00	112.00	127.00	142.00
Hot water (cooling mode)	kW	15.00	20.00	30.00	30.00	30.00	35.00	40.00	50.00	60.00
Power Input	kW	0.71	1.02	1.33	1.70	1.42	1.73	2.04	2.35	2.66
EER (Calorific Value) ¹	High / Low	W/W	1.48 / 1.64	1.40 / 1.55	1.15 / 1.28	1.22 / 1.35	1.48 / 1.64	1.43 / 1.59	1.40 / 1.55	1.25 / 1.39
Max COP (inc hot water)			1.97	1.89	1.64	1.65	1.97	1.93	1.89	1.64
Gas consumption	kW	29.70	39.10	60.40	67.9	59.40	68.80	78.20	99.50	120.80
Heating capacity	STD / Low temperature ²	kW	50.00 / 53.00	63.00 / 67.00	80.00 / 78.00	95.00 / 90.00	100.00 / 106.00	113.00 / 120.00	126.00 / 134.00	143.00 / 145.00
Power Input	kW	0.60	0.64	0.83	1.45	1.20	1.24	1.28	1.47	1.66
COP (Calorific Value) ¹	High / Low	W/W	1.51 / 1.68	1.46 / 1.62	1.48 / 1.64	1.37 / 1.52	1.51 / 1.68	1.48 / 1.64	1.46 / 1.62	1.47 / 1.63
Gas consumption	STD	kW	32.50	42.50	53.20	68.10	65.00	75.00	85.00	95.70
	Low temperature ²	kW	41.50	56.40	62.30	78.00	83.00	97.90	112.80	124.60
COP	Average		1.50	1.43	1.32	1.29	1.50	1.46	1.43	1.36
Starter amperes	A	30	30	30	30	30	30	30	30	30
Sound pressure level	dB(A)	57	58	62	63	60	61	61	63	65
Dimensions	Height	mm	2,273	2,273	2,273	2,273	2,273	2,273	2,273	2,273
	Width	mm	1,650	1,650	1,650	2,026	1,650+100+1,650	1,650+100+1,650	1,650+100+1,650	1,650+100+1,650
	Depth	mm	1,000 (+80)	1,000 (+80)	1,000 (+80)	1,000 (+80)	1,000 (+80)	1,000 (+80)	1,000 (+80)	1,000 (+80)
Net weight	kg	755	780	810	840	755 + 775	755 + 780	780 + 780	780 + 810	810 + 810
Pipe Connections	Gas	Inch (mm)	1 1/8 (28.58)	1 1/8 (28.58)	1 1/8 (28.58)	1 1/4 (31.75)	1 1/4 (31.75)	1 1/4 (31.75)	1 1/2 (38.10)	1 1/2 (38.10)
	Liquid	Inch (mm)	1/2 (12.70)	5/8 (15.88)	5/8 (15.88)	3/4 (19.05)	3/4 (19.05)	3/4 (19.05)	3/4 (19.05)	3/4 (19.05)
	Fuel gas		R3/4 (bolt thread)	R3/4 (bolt thread)	R3/4 (bolt thread)	R3/4 (bolt thread)	R3/4 (bolt thread)	R3/4 (bolt thread)	R3/4 (bolt thread)	R3/4 (bolt thread)
	Exhaust drain port	mm	25 rubber hose	25 rubber hose	25 rubber hose	25 rubber hose	25 rubber hose	25 rubber hose	25 rubber hose	25 rubber hose
Indoor/outdoor capacity ratio		50-200 %	50-200 %	50-200 %	50-170 %	50-130 %	50-130 %	50-130 %	50-130 %	50-130 %
Number of connections indoor		24	24	24	32	48	48	48	48	48

GHP Service kits model names	Kit CZ-PSK560SP	Kit CZ-PSK850S
Outdoor unit reference	U-16GE2E5 / U-20GE2E5 / U-25GE2E5	U-30GE2E5
Material included on the kit		
Oil Filter	1	1
Air Cleaner Element (Air Filter)	1	1
Plug	4	4
V BELT (for compressor)	1	1
V Belt (for generator)	-	-
Oil Strainer	1	1
Drain Filter Packing	1	1

Rating Conditions: Cooling Indoor 27°C DB / 19°C WB. Cooling Outdoor 35°C DB. Heating (standard) Indoor 20°C DB. Heating (standard) Outdoor 7°C DB / 6°C WB. Heating (low temp.) Indoor 20°C DB / 15°C WB or less. Heating (low temp.) Outdoor 2°C DB / 1°C WB. DB: Dry Bulb; WB: Wet Bulb

* In these combinations, GE2E5 is able to connect to a W-multi system Specifications subject to change without notice instead of a GE2E5.

1) Referred to Natural Gas (HCV=55,489 MJ/kg; LCV=50,013 MJ/kg). 2) Low temperature condition: outdoor temperature 2°C. Specifications subject to change without notice.

Cooling and heating capacities in the tables are determined under the test conditions of JIS B 8627. Effective heating requires that the outdoor air intake temperature be at least -20°C DB or -21°C WB.

- Gas consumption is the total (high) calorific value standard. - Outdoor unit operating sound is measured 1 meter from the front and 1.5 meters above the floor (in an anechoic environment). Actual installations may have larger values due to ambient noise and reflections. - Specifications are subject to change without notice. - Hot water heating capacity is applicable during cooling operation. - The maximum water temperature that can be obtained is 75°C. Water heating performance and temperature vary with the air conditioning load. Because the hot water heating system uses waste heat from the engine, which runs the air conditioning, its ability to heat water is not guaranteed.



Technical focus

- Reduced gas consumption by Miller-cycle engine
- Reduced electrical power consumption by using DC Motors
- Lightweight design reduces weight
- Capacity ratio 50-130% (single models only)
- Quiet mode offers a further 2 dB(A) reduction
- Part load efficiencies increased
- Connectivity increased - now up to 48 indoor units
- Multi-systems with combinations from 13 HP up to 50 HP
- 10,000 run hours between engine service intervals (equivalent to one maintenance every 3.2 years*)
- 200 m maximum allowable piping length (L1)
- Extended pipe runs (total 780 m)
- Full heating capacity down to -20°C

- No defrost cycle

* Assuming 3,120 running hours per year - 12 h x 5 days x 52 weeks

Sample installation



kW	45	56 - 71	85
1 Gas refrigerant pipe	Ø 28.58	Ø 31.75	Ø 31.75
2 Liquid refrigerant pipe	Ø 12.7	Ø 15.88	Ø 19.05
3 Exhaust gas drain port	HOSE OD Ø 25 (accessory)		
4 Electrical power supply port	Ø 28		
5 Inter-unit cable port	Ø 28		
6 Fuel gas port	R3/4		
7 Condensation drain opening	Ø 20		
8 Rain and condensation outlet			
9 Engine exhaust outlet			
10 Suspension holes 4-Ø 20x30			
11 Anchor holes 4-Ø 22x30			
12 Segmented display			
13 Coolant intake (top)			
14 Vent			
15 Hot water intake	Rp3/4		
16 Hot water outlet	Rp3/4		

U-16GE2E5 // U-20GE2E5 // U-25GE2E5

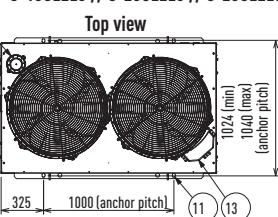

U-30GE2E5

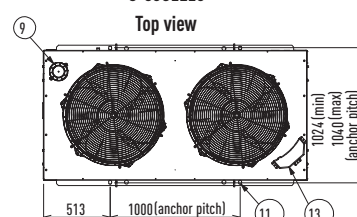

Service clearances for installation

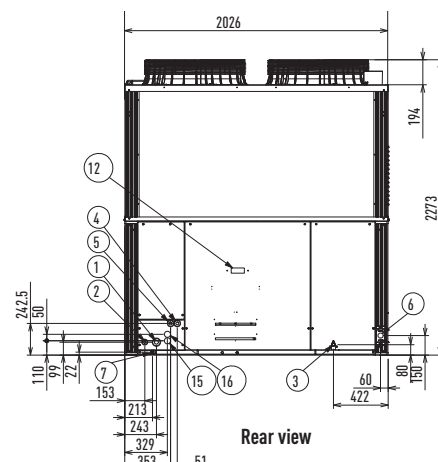
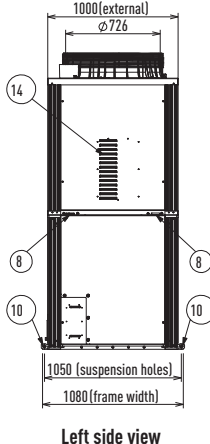
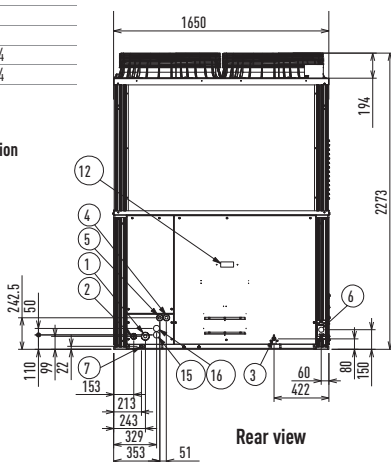
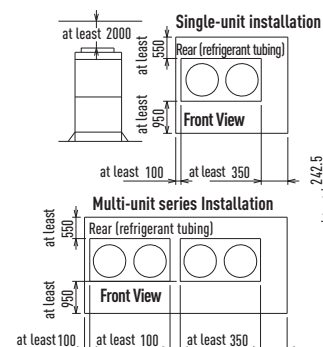

ECO G 3 WAY

3 Way Heat Recovery System with Simultaneous Heating & Cooling

The only 3 Way GHP system in Europe, the S Series ECO G 3 Way offers even more performance and outstanding features when you need simultaneous heating and cooling. Now with capacities available from 16 HP to 25 HP, Panasonic offers the greatest choice and flexibility to solve any power problem or site requirement.



5 YEARS COMPRESSOR WARRANTY. Only for PRO partners.

HP			16 HP	20 HP	25 HP
Model			U-16GF2E5	U-20GF2E5	U-25GF2E5
Cooling capacity		kW	45.00	56.00	71.00
Power input cooling		kW	0.71	1.02	1.33
EER (Calorific Value) ¹	High / Low	W/W	1.48 / 1.64	1.40 / 1.55	1.15 / 1.28
Cooling gas consumption		kW	29.7	39.1	60.4
Heating capacity	STD	kW	50.00	63.00	80.00
	Low temperature ²	kW	53.00	67.00	78.00
Power input heating		kW	0.60	0.64	0.83
COP (Calorific Value) ¹	High / Low	W/W	1.51 / 1.68	1.46 / 1.62	1.48 / 1.64
Gas consumption	STD	kW	32.5	42.5	53.2
	Low temperature ²	kW	41.5	56.4	62.3
COP	Average		1.50	1.43	1.32
Starter amperes		A	30	30	30
Operation sound		dB(A)	57	58	62
Dimensions	H x W x D	mm	2.273 x 1.650 x 1.000 (+80)		2.273 x 1.650 x 1.000 (+80)
Net weight		kg	775	775	805
Pipe Connections	Gas	Inch (mm)	1 1/8 (28.58)	1 1/8 (28.58)	1 1/8 (28.58)
	Liquid	Inch (mm)	3/4 (19.05)	3/4 (19.05)	3/4 (19.05)
	Discharge	Inch (mm)	7/8 (22.22)	1 (25.40)	1 (25.40)
	Fuel gas		R3/4	R3/4	R3/4
	Exhaust drain port	mm	25	25	25
Indoor/outdoor capacity ratio			50-200% ³	50-200% ³	50-200% ³
Number of connected indoor units			24	24	24

Solenoid valve kit		
KIT-P56HR3	KIT-P56HR3	3-Pipe control Solenoid valve kit (up to 5,6kW)
	CZ-P56HR3	Solenoid valve kit (up to 5,6kW)
	CZ-CAPE2	3-Pipe control PCB
KIT-P160HR3	KIT-P160HR3	3-Pipe control Solenoid valve kit (from 5,6kW to 10,6kW)
	CZ-P160HR3	Solenoid valve kit (from 5,6kW to 10,6kW)
	CZ-CAPE2	3-Pipe control PCB
CZ-CAPEK2		3-Pipe control PCB for wall mounted

GHP Service kits model name	Kit CZ-PSK560SP
Outdoor unit reference	U-16GF2E5 / U-20GF2E5 / U-25GF2E5
Material included on the kit	
Oil Filter	1
Air Cleaner Element (Air Filter)	1
Plug	4
V BELT (for compressor)	1
V Belt (for generator)	-
Oil Strainer	1
Drain Filter Packing	1

3-Pipe control box kit*	
CZ-P456HR3	4 ports 3 pipe box (up to 5,6kW)
CZ-P656HR3	6 ports 3 pipe box (up to 5,6kW)
CZ-P856HR3	8 ports 3 pipe box (up to 5,6kW)
CZ-P4160HR3	4 ports 3 pipe box (from 5,6 to 10,6kW)

* Available from December 2015.

Rating Conditions: Cooling Indoor 27°C DB / 19°C WB. Cooling Outdoor 35°C DB. Heating (standard) Indoor 20°C DB. Heating (standard) Outdoor 7°C DB / 6°C WB. Heating (low temp.) Indoor 20°C DB / 15°C WB or less. Heating (low temp.) Outdoor 2°C DB / 1°C WB. DB: Dry Bulb; WB: Wet Bulb

1) Referred to Natural Gas (HCV=55,489 MJ/kg; LCV=50,013 MJ/kg). 2) Low temperature condition: outdoor temperature 2°C. 3) Indoor unit can be connected to up to 16 kW model (model size 60) Specifications subject to change without notice.

Cooling and heating capacities in the tables are determined under the test conditions of JIS B 8627. Effective heating requires that the outdoor air intake temperature be at least -20°C DB or -21°C WB.

- Gas consumption is the total (high) calorific value standard. - Outdoor unit operating sound is measured 1 meter from the front and 1.5 meters above the floor (in an anechoic environment). Actual installations may have larger values due to ambient noise and reflections. - Specifications are subject to change without notice.



Technical focus

- Simultaneous heating and cooling for total control
- Reduced gas consumption by Miller-cycle engine
- Reduced electrical power consumption by using DC Motors
- Part load efficiencies increased
- Connectability increased to up to 24 indoor units
- 145 m maximum allowable piping length, L1
- Capacity ratio 50–200%
- Extended pipe runs (total 780 m)
- Quiet mode offers a further 2 dB(A) reduction
- Full heating capacity down to -21°C
- Option of using LPG as a power supply (increases flexibility and avoids problems of potential site restrictions in the future. The purer fuel is also excellent for further reductions in CO₂ emissions)
- No defrost cycle

- 10,000 run hours between engine service intervals (equivalent to one maintenance every 3.2 years*)

* Assuming 3,120 running hours per year - 12 h x 5 days x 52 weeks

Additional parts



3-Pipe control Solenoid valve kit
 CZ-P56HR3: Up to 5.6 kW
 CZ-P160HR3: From 5.7 to 16 kW
 KIT-P56HR3: (CZ-P56HR3+CZ-CAPE2)
 KIT-P160HR3: (CZ-P160HR3+CZ-CAPE2)

* For conference rooms and other locations where low noise is required, pay attention to the installation location and install in a corridor etc.



3-Pipe control PCB CZ-CAPE2*.

Must be added to the CZ-P56HR3 OR CZ-P160HR3.
 * For wall mounted.

Service clearances for installation

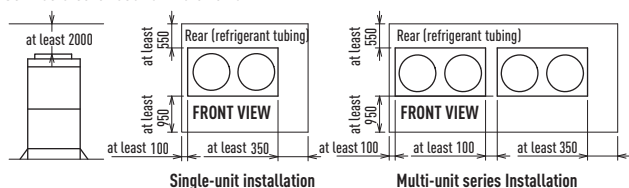

Top view

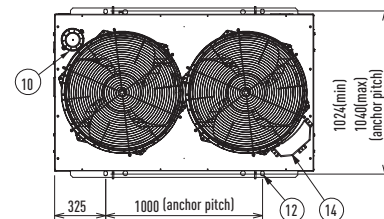

kW		45.0	56.0-71.0
1	Suction refrigerant pipe	Ø 28.58	
2	Discharge refrigerant pipe	Ø 22.22	Ø 25.4
3	Liquid refrigerant pipe	19.05	
4	Exhaust gas drain port	HOSE OD Ø 25 (accessory)	
5	Electrical power supply port	Ø 28	
6	Inter-unit cable port	Ø 28	
7	Fuel gas port	R3/4	
8	Condensation drain opening	Ø 20	
9	Rain and condensation outlet		
10	Engine exhaust outlet		
11	Suspension holes 4-Ø 20x30		
12	Anchor holes 4-Ø 22x30		
13	Segmented display		
14	Coolant intake (top)		
15	Vent		

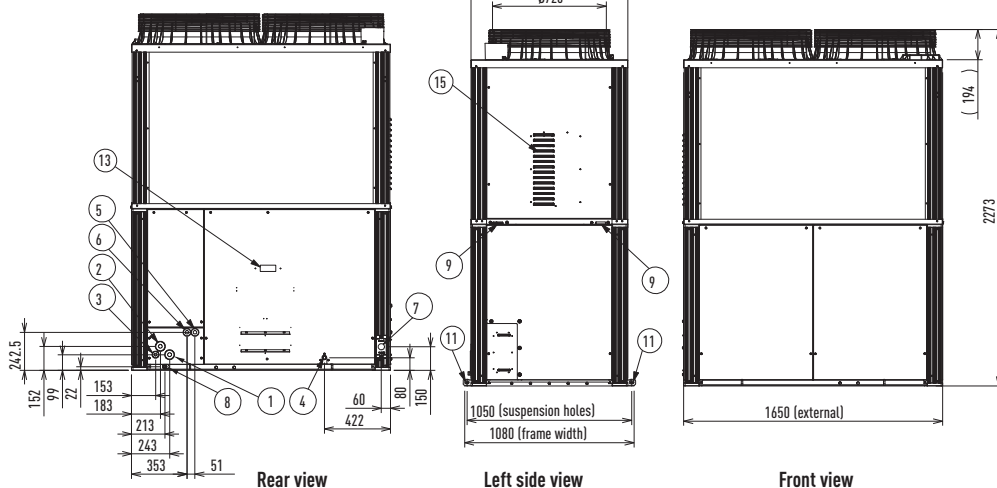



- A CLASS PUMP INCLUDED
- 4 WAY VALVE INCLUDED
- OPTIMIZED HEAT EXCHANGER
- 1,056 x 570 x 1,010 (H x W x D)
- WATER CONNECTIONS R2" F

The Panasonic solution for chilled and hot water production!

From 28 kW to 80 kW

Key benefits:

- No cascade installation up to 80 kW with GHP outdoor unit and 51.3 kW with ECOi
- Full line-up of outdoor units which can cover up to 80 kW heat demand
- Large choice of remote controls and interfaces
- 3.25 COP with water at 45°C and outdoor temperature of +7°C

Energy saving
INVERTER +

Environmentally friendly refrigerant
 R410A



With ECOi outdoor units

- Maximum hot water outlet temperature: 45°C
- Minimum chilled water outlet temperature: 5°C
- Outdoor temperature range in cooling mode: +5°C to +43°C
- Outdoor temperature range in heating mode: -11°C to +15°C

ECOi Water Heat Exchanger

Electrical VRF with Water Heat Exchanger

- With this easy to install Water Heat Exchanger unit, you can now cover projects up to 51 kW hot water demand or 44 kW on chilled application on a efficient way and cost effective.

SYSTEM EXAMPLE

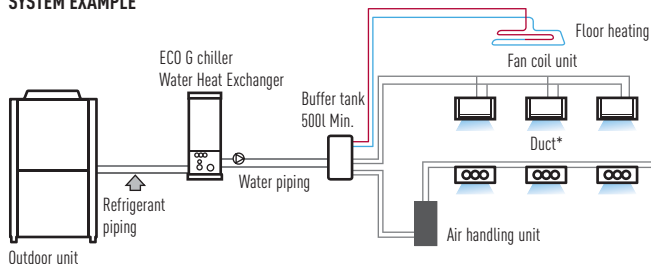

A Buffer Tank of minimum 500L is always needed.

New Electrical panel with new algorithm

- Optimized heat exchanger to increase drastically the efficiency
- Liquid receiver to outperform the functionality of the WHE
- Unique 4 way valve in order always have counterflow fluid circulation in heating and cooling fluid circulation on both sides of the cross flow. This optimizes efficiency!

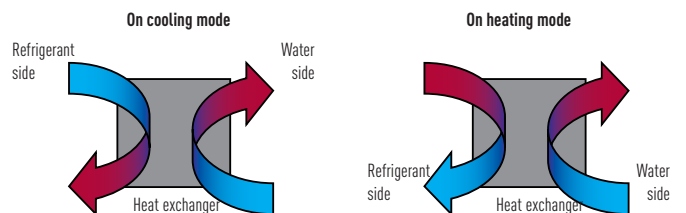

Built in A class water pump with high efficiency and capacity

WHE	Power consumption	Water flow
S-250 / S-500	9 - 130W	4.3 / 8.6
S-710	12 - 310W	12.2

ECOi 2-PIPE WITH WATER HEAT EXCHANGER FOR CHILLED AND HOT WATER PRODUCTION

For hydronic Applications

Water Heat Exchanger for GHP and ECOi, dimensions reduced by 45 %. Operation and control by timer remote control CZ-RTC4. Energy-efficient capacity control. Stainless steel plate heat exchanger with anti-freeze protection control. Change-over between heating and cooling operation.

- A CLASS PUMP INCLUDED
- 4 WAY VALVE INCLUDED
- OPTIMIZED HEAT EXCHANGER
- 1,010 X 570 X 960 (H x W x D)
- WATER CONNECTIONS R2" F



5 YEARS COMPRESSOR WARRANTY. Only for PRO partners.

Water Heat Exchanger*		PAW-250WX2E5	PAW-500WX2E5	PAW-710WX2E5
Nominal cooling capacity at 35 °C, water outlet 7 °C		25,0	50,0	67
Nominal heating capacity		28,0	56	75
Heating capacity at +7°C, heating water temperature at 45°C kW		28,0	56	75
COP at +7°C with heating water temperature at 45°C		3,25	3,10	3,32
Dimensions	H x W x D	mm	1,010 x 570 x 960	1,010 x 570 x 960
Net weight		kg	120	145
Water pipe connector			Rp2 Female Thread (50A)	Rp2 Female Thread (50A)
A class pump			Included	Included
Heating water flow (ΔT=5 K, 35°C)		m³/h	4,3	8,6
Capacity of integrated electric heater		kW	Not equipped	Not equipped
Input power		kW	0,01 + (min. 0,05 / max. 0,13 for water pump)	0,01 + (min. 0,19 / max. 0,31 for water pump)
Maximum current		A	0,07 + (min. 0,37 / max. 0,95 for water pump)	0,07 + (min. 0,88 / max. 1,37 for water pump)
Outdoor unit			U-10ME1E81	U-20ME1E81
Sound pressure level		dB(A)	59	63
Sound power level		dB	73,5	77,5
Dimensions		H x W x D	mm	1,758 x 770 x 930
Net weight		kg	283	423
Piping connections				
		Liquid pipe	mm	22,22
		Gas pipe	mm	9,52
Refrigerant (R410A)		kg	6,3 *Need Additional charge at site	9,0 *Need Additional charge at site
Pipe length range		Max.	m	170
Pipe length for nominal capacity			m	7,5
Pipe length for additional gas			m	0 <
Additional charge (R410A)		g/m	Refer to manual	Refer to manual
Elevation difference (in/out)		m	50 (OD above) 35 (OD below)	50 (OD above) 35 (OD below)
Operation Range				
		Outdoor ambient	°C	-11 — +15 **
		Water outlet (at -2/-7/-15)²	°C	35 — 45

Rating Conditions: Cooling Indoor 27 °C DB / 19 °C WB. Cooling Outdoor 35 °C DB / 24 °C WB. Heating Indoor 20 °C DB. Heating Outdoor 7 °C DB / 6 °C WB.

DB: Dry Bulb; WB: Wet Bulb

** With accessory low temperature kit -25 -- +15°C

Performance calculation in agreement with Eurovent.

Sound pressure measured at 1 m from the outdoor unit and at 1.5-m height.



Technical focus

- Maximum distance between outdoor unit and Water Heat Exchanger: 170 m
- Maximum hot water outlet temperature: 45°C
- Minimum chilled water outlet temperature: 7°C
- Outdoor temperature range in cooling mode: +5°C to +43°C
- Outdoor temperature range in heating mode: -20°C to +15°C

Slim & Light design

Due to the unit's internal redesign, the width and weight are drastically reduced.

Installation space **45%** reduction

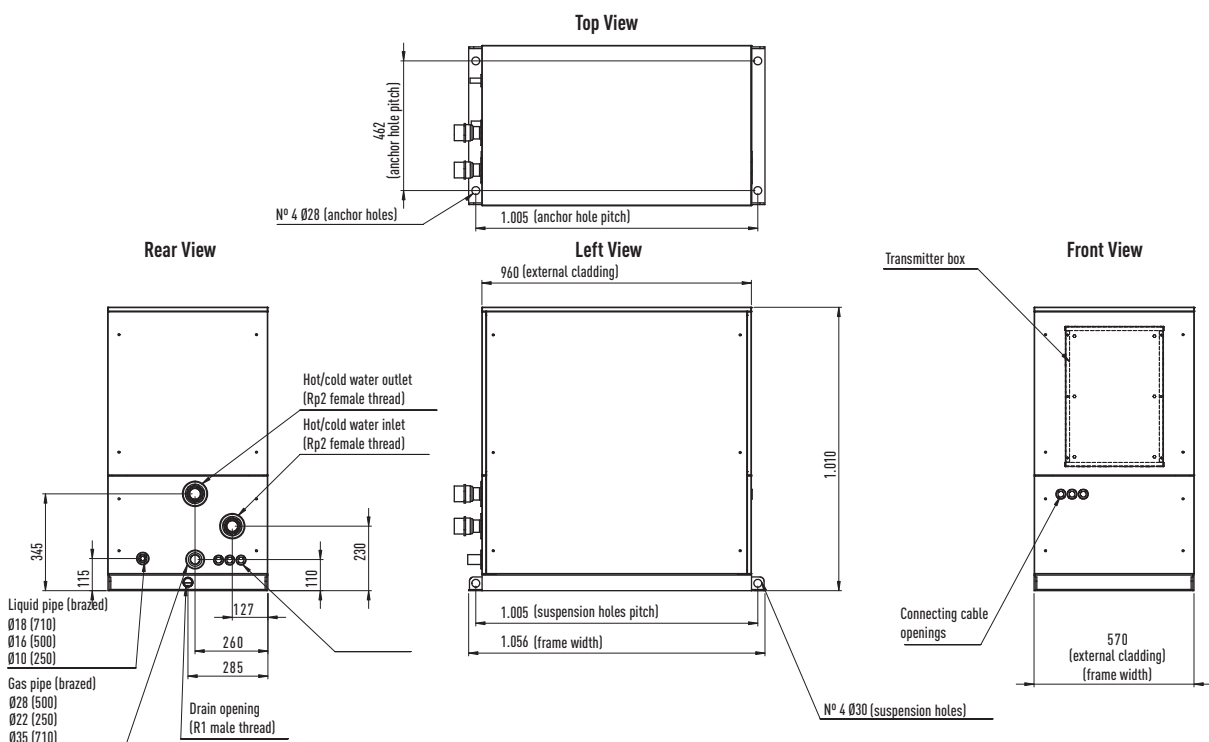
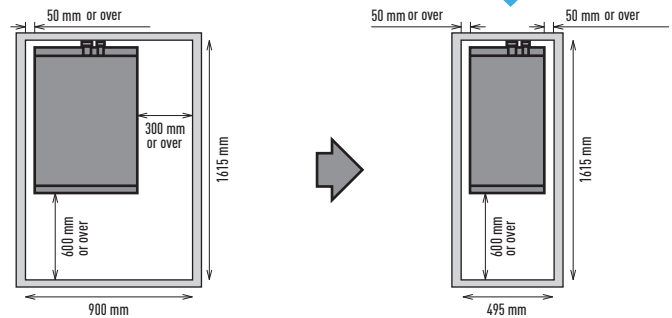



- MORE EFFICIENT THAN GAS BOILERS AND CHILLERS
- HEATING, COOLING AND DHW
- INCREASED ENERGY EFFICIENCY AND LOW CO₂ EM

GHP + WHE heating, cooling and DHW

The ECO G solution for gas boiler replacement

- Combined with a Water Heat Exchanger unit, the Panasonic GHP can create a flexible system, the ideal replacement for existing chiller and boiler systems in order to increase efficiency and reduce CO₂ emissions.
- Reused heat from the engine is an alternative to thermal solar energy
- No defrost cycle
- Super silent outdoor units
- No glycol needed as the hydromodule can be placed in heated part of building
- Keep existing water installation and fan coils
- Oversizing is reduced by keeping the power at a low temperature.
- No need for cooling towers
- Electrical demand spikes or possible costs derived from investments in new electrical infrastructures are lowered.

Excellent applicability when there is a thermal demand for heat, DHW and cooling, as well as additional thermal usages such as swimming pools, SPA, laundries: Hotels, sports centers, hospitals, gymnasiums, homes, shopping centers, etc.

**35% SAVINGS
BEST ECO SOLUTION**

High savings
ECO G

Environmentally friendly refrigerant
R410A



Case Study, Hotel Application

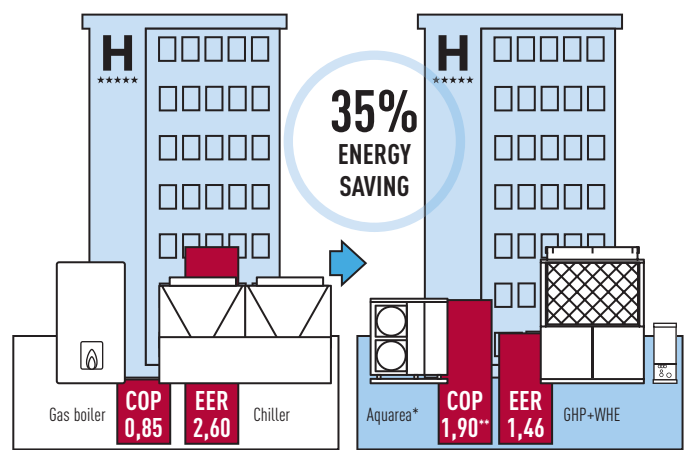

* Electric to support pick of consumption on domestic hot water. ** COP including HSW (U-20GE2E8). EER and COP calculated in primary energy.

Example of Hotel renewal of existing Chiller and Boiler system with Panasonic GHP and Aqueara mixed solution

GHP and Aqueara are the smart solution for renewal Chiller/Boiler applications with annual running cost savings around 13.600€.

			Load kW/h year	Power Input	Running cost €
Cooling	Chiller+Boiler	Chiller	231.653	89.097	12.474
	GHP+A2W	GHP	231.653	183.852	7.354
Heating	Chiller+Boiler	Boiler	96.749	113.823	4.553
	GHP+A2W	GHP	96.749	73.630	2.945
HSW	Chiller+Boiler	Boiler	204.213	240.251	9.610
		GHP (*)	118.225	0	0
	GHP+A2W	Aqueara	77.031	16.390	2.295
		Back up Boiler	8.957	10.538	422
Total	Chiller+Boiler		532.616	443.171	26.637
	GHP+A2W		532.616	284.409	13.015
	GHP+A2W savings			158.762	13.621

Hotel example: 2.000 m² Hotel 4*, 75 rooms, in Barcelona. Cooling load 170 kWh, Heating Load 142 kWh, HSW 204 kWh/year. Part load calculation at 70%, and 33% of total year at heating mode. Including 10% capacity drop with Water Heat Exchanger. 3 units GHP U-20GE2E5 and Aqueara 9 kW.

With GHP outdoor units:

In heating mode, at very low outdoor temperature -21°C, the available power is maintained. No defrost cycle happens and stable heating comfort is guaranteed.

- Hot water outlet temperatures from 35°C to 55°C
- Chilled water outlet temperatures from -15°C to 15°C
- Outdoor temperature range in cooling mode: -10°C to +43°C
- Minimum outdoor temperature in heating mode: -21°C

ECO G Water Heat Exchanger. Mixed System Application

The GHP Multi System can have an indoor unit plus a GHP chiller. When the two systems are operated independently, an outdoor unit with 130% capacity can be connected.

SYSTEM EXAMPLE

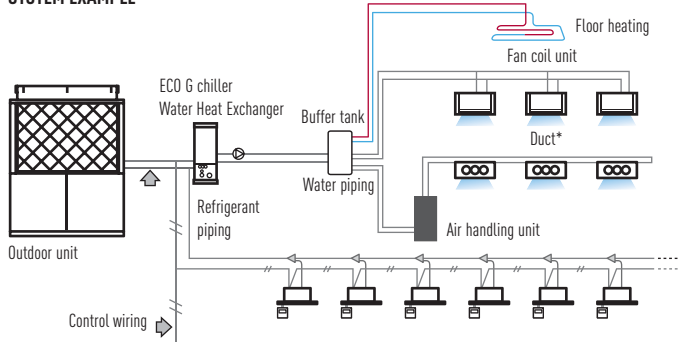

Note: The mode of running of outdoor unit depends on the Water Heat Exchanger's mode. The water pump is not included in the Water Heat Exchanger unit. For simultaneous operation, however, the maximum capacity is 130%. Please inquire details of this system design of Panasonic. * Standard DX type indoor unit system.

ECO G WITH WATER HEAT EXCHANGER FOR CHILLED AND HOT WATER PRODUCTION

For hydronic applications

Water Heat Exchanger, dimensions reduced by 45 % (250 W x 2 and 500 W x 2). Operation and control by timer remote control CZ-RTC4. Energy-efficient capacity control. Stainless steel plate heat exchanger with anti-freeze protection control. Change-over between heating and cooling operation.

- MORE EFFICIENT THAN GAS BOILERS AND CHILLERS
- HEATING, COOLING AND DHW
- INCREASED ENERGY EFFICIENCY AND LOW CO₂ EM



5 YEARS COMPRESSOR WARRANTY. Only for PRO partners.

Water Heat Exchanger*		PAW-250WX2E5	PAW-500WX2E5	PAW-710WX2E5
Nominal Heating Capacity		30	60	80
Heating Capacity at +7°C, heating water temperature at 35°C	kW		62	82.8
COP at +7°C with heating water temperature at 35°C			1.49	1.34
Heating Capacity at +7°C, heating water temperature at 45°C	kW	30	60	80
COP at +7°C with heating water temperature at 45°C			1.30	1.17
Heating Capacity at -7°C, heating water temperature at 35°C	kW		57.2	74.6
COP at -7°C, heating water temperature at 35°C			0.76	0.77
Heating Capacity at -15°C, heating water temperature at 35°C	kW		59.2	77.4
COP at -15°C with heating water temperature at 35°C			0.75	0.76
Nominal Cooling Capacity		25	50	71
Cooling capacity at +35°C, outlet tp 7°C, inlet tp 12°C	kW		50	71
EER at +35°C, outlet tp 7°C, inlet tp 12°C			1.15	1.05
Dimensions	H x W x D	mm	1.010 x 570 x 960	1.010 x 570 x 960
Weight		kg	120	145
Water pipe connector			Rp2 Female Thread (50A)	Rp2 Female Thread (50A)
Pump (included)			Included	Included
Heating water flow [ΔT=5 K, 35°C]		l/min	4,3	8,6
Capacity of integrated electric heater			Not equipped	Not equipped
Input Power		kW	0,01 + (min. 0,05 / max. 0,13 for water pump)	0,01 + (min. 0,19 / max. 0,31 for water pump)
Maximum Current		A	0,07 + (min. 0,37 / max. 0,95 for water pump)	0,07 + (min. 0,85 / max. 1,37 for water pump)
Outdoor unit			U-20GE2E5	U-30GE2E5
Sound pressure		dB(A)	58	63
Sound power level		dB	83	86
Dimensions	H x W x D	mm	2,273 x 1,650 x 1,000	2,273 x 2,026 x 1,000
Weight		kg	780	840
Piping connections	Liquid pipe	mm	28.58	31.75
	Gas pipe	mm	15.88	19.05
Refrigerant (R410A)		kg	11.5 (Need additional charge at site)	11.5 (Need additional charge at site)
Pipe length range	Max.	m	170	170
Pipe length for nominal capacity		m	7	7
Pipe length for additional gas		m	0<	0<
Additional charge (r410a)		g/m		
Elevation difference (in/out)		m	50 (OD above) 35 (OD below)	50 (OD above) 35 (OD below)
Operation range	Outdoor ambient	°C	-21 — 15.5	-21 — 15.5
	Water outlet (at -2/-7/-15) ²	°C	35 — 55	35 — 55

Rating Conditions: Cooling Indoor 27 °C DB / 19 °C WB. Cooling Outdoor 35 °C DB / 24 °C WB. Heating Indoor 20 °C DB. Heating Outdoor 7 °C DB / 6 °C WB. DB: Dry Bulb; WB: Wet Bulb

Performance calculation in agreement with Eurovent.

Sound pressure measured at 1 m from the outdoor unit and at 1.5 m height.

* Only with indoors combination. Can not be used as 1 to 1.



Technical focus

- **New!** A class pump included
- Maximum distance between O_U and WHE: 170 m
- Possibility to mix DX and Water Heat Exchanger systems
- Hot water outlet temperatures from 35°C to 55°C
- Chilled water outlet temperatures from -15°C to +15°C
- Outdoor temperature range in cooling mode: -10°C to +43°C
- Minimum outdoor temperature in heating mode: -21°C

Slim & Light design

Due to the unit's internal redesign, the width and weight are drastically reduced.

Installation space **45%** reduction

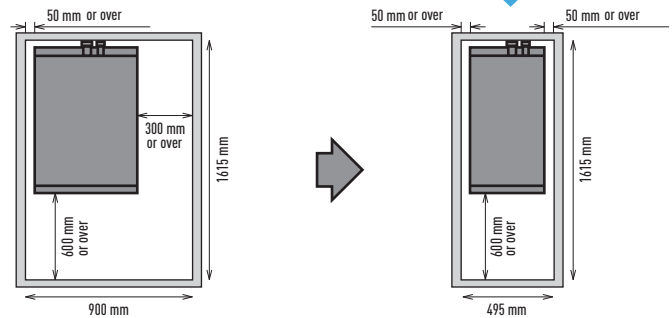

Top View

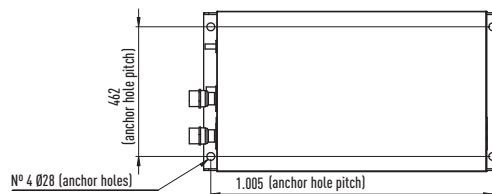

Rear View

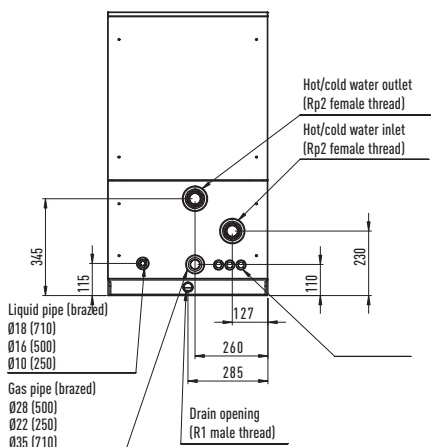

Left View

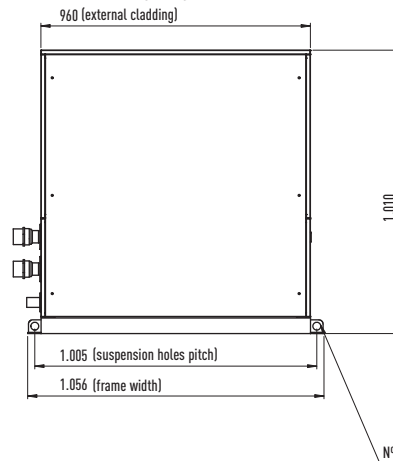

Front View

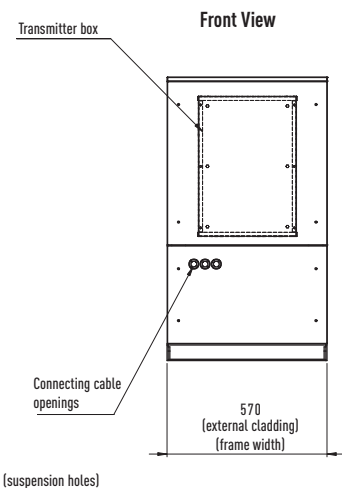

AQUAREA AIR RADIATORS

New line up of Super low temperature radiators for Heat Pump application: Aquarea Air 200/700/900 with radiating effect

The slimline Panasonic Aquarea Air radiators deliver high efficiency climate control. With a depth of just under 13 cm they are at the cutting edge of the market. Blending easily into the home, Aquarea Air's elegant design and product refinements are clear to see in every detail.

The Aquarea Air's slimline profile has been achieved thanks to the innovative layout of the ventilation unit and the heat exchanger. The fan is tangential with asymmetric blades and the large surface heat exchanger enables high airflows to be achieved with low pressure loss and low noise levels. Exceptional ventilation efficiency means the motor uses considerably less energy (low wattage). The fan speed is continuously modulated by the temperature controller with proportional integral logic, with undoubted advantages for regulating the temperature and humidity in summer mode.

All temperature curves and capacity are available on www.panasonicproclub.com

Fan Coils for Heat Pump application	PAW-AAIR-200					PAW-AAIR-700					PAW-AAIR-900					
Total heating capacity	W	138	160	217	470	570	223	360	708	1032	1188	273	475	886	1420	1703
Water flow	kg/h	23.7	27.5	37.3	80.8	98.0	38.4	61.9	121.8	177.5	204.3	47.0	81.7	152.4	244.2	292.9
Water pressure drop	kPa	0.1	0.2	0.4	2.0	2.9	0.1	0.1	0.3	0.8	1.0	0.1	0.2	0.5	1.6	2.2
Air flow	m ³ /h	28	37	55	113	162	44	84	155	252	320	54	110	248	367	461
	Speed	Main Fan Off	Super Min	Min	Med	Max	Main Fan Off	Super Min	Min	Med	Max	Main Fan Off	Super Min	Min	Med	Max
Maximum input power	W	2	5	7	9	13	3	9	14	18	22	3	11	16	20	24
Sound pressure level	dB(A)	17.6	18.8	24.7	33.2	39.4	18.4	19.6	25.8	34.1	40.2	18.4	22.3	26.2	34.4	42.2
Inlet water temperature	°C	35	35	35	35	35	35	35	35	35	35	35	35	35	35	35
Outlet water temperature	°C	30	30	30	30	30	30	30	30	30	30	30	30	30	30	30
Inlet air temperature	°C	19	19	19	19	19	19	19	19	19	19	19	19	19	19	19
Outlet air temperature	°C	34.5	32.6	38.9	32.0	30.0	34.9	32.4	33.3	31.8	30.6	34.8	32.5	30.2	31.1	30.6
Dimensions (H x W x D)	mm	735 x 576 x 129					935 x 579 x 129					1,135 x 579 x 129				
Weight	kg	17					20					23				
3 ways valve included		Yes					Yes					Yes				
Touch screen thermostat		Yes					Yes					Yes				

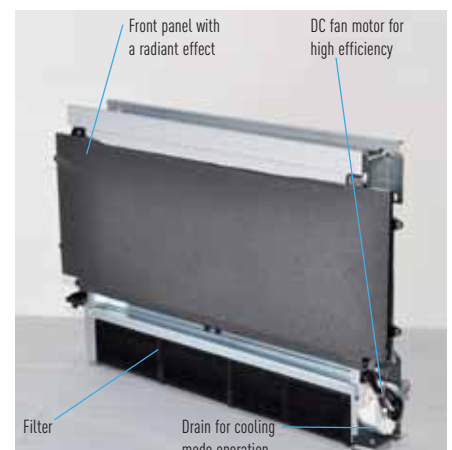
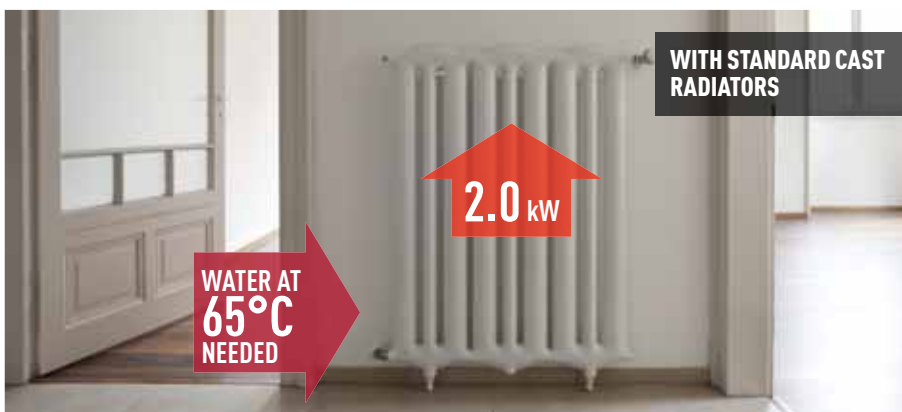



PAW-AAIR-900



PAW-AAIR-700

PAW-AAIR-200

AQUAREA AIR

Technical focus

- Front panel heating with radiant effect
- High heating capacity (without main fan running)
- 4 fan speeds and capacities
- Exclusive design
- Extremely compact (only 12.9cm deep)
- Cooling and dehumidification functions possible (drain is needed)
- 3-way valve included (no overflow valve needed on the installation if more than 3 radiators installed)
- Touch screen thermostat

During winter, the operating principle is based on micro fans of very low power consumption and minimum noise that send hot air, coming from the heat exchanger, to the inside of the front panel of the device and therefore heat it effectively. With this principle, the terminal also provides significant power while heating, without running the main fan. Comfort temperatures therefore maintained, without air movements and in silence. In summer mode, the airflow generated by the micro fans is stopped to avoid any dew formation on the terminal's front surface.

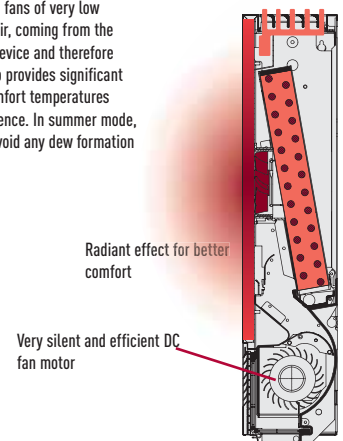

Operating on heating mode with radiator using only radiant effect

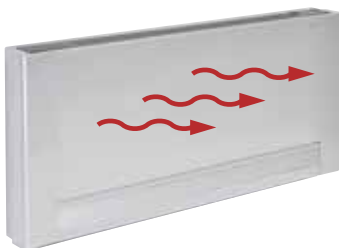

Operating on heating mode with radiant effect and fan mode

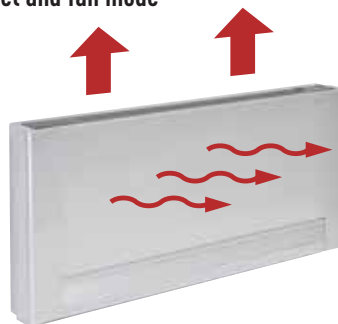

Operating on cooling mode with fan

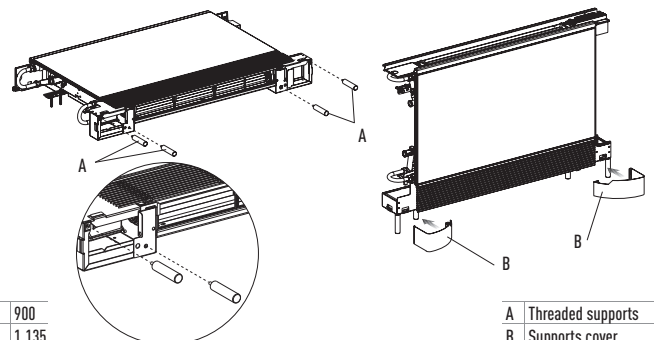
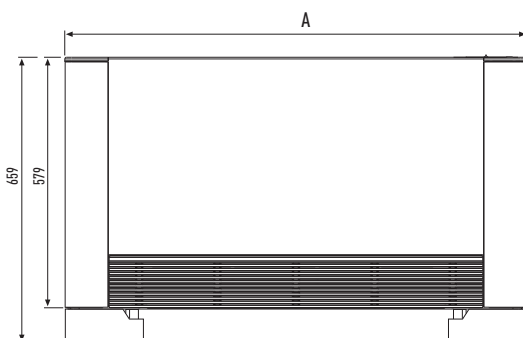

	200	700	900
A	735	935	1.135

A	Threaded supports
B	Supports cover

Features

High technology features

Down to
-25 °C in
heating mode
OUTDOOR
TEMPERATURE

Wider operation

Thanks to wide operation range of Panasonic ECOi and ECOg systems with Aquarea Air fan coils is possible to cover outdoor temperatures of as -10 °C DB for cooling and -21 °C WB for heating.

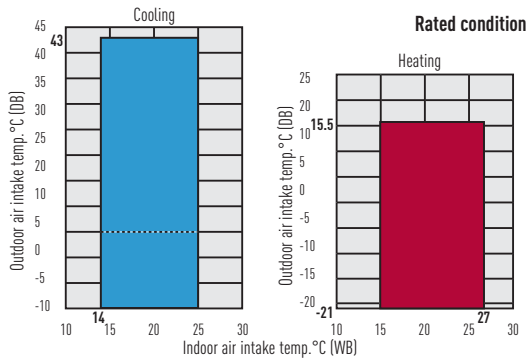

Practical
operation
AUTOMATIC RESTART

Automatic restart function for power failure

Even when power failure occurs, preset programmed operation can be reactivated once power is resumed.

Easy
maintenance
SELF-DIAGNOSING

Self-diagnosing function

By using electronic control valves past warnings are stored and can be verified on the liquid crystal display. This makes it easier to diagnose malfunctions, greatly reducing service labour and therefore costs.

Refrigerant Volume “self check” procedure

ECOi 2 and 3-Pipe systems have an inbuilt self judgement mode to indicate the present system refrigerant volume. From the outdoor unit you can start the self judgement mode, after completion (approx. 30 minutes) the LED display's the results. It ensures unit efficiency, avoids refrigerant wastage and assists with F-Gas compliance.

	LED 1	LED 2
Judgment mode	Blinking	Blinking
Normal	ON	ON
Insufficient gas	Blinking	OFF
Overcharge	OFF	Blinking
Judgment not possible	Blinking alternately	

Simple, convenient features (Indoor Units)

For more
comfort
AUTOMATIC FAN

Automatic fan operation

Convenient microprocessor control automatically adjusts fan speed to High, Medium or Low, corresponding to room sensor and maintains comfortable airflow throughout the room.

Comfort
everywhere
AIR SWEEP

Air Sweep

The air sweep function moves the flap up and down in the air outlet, directing air in a “sweeping” motion around the room and providing comfort in every corner.

Perfect
humidity
control
MILD DRY

Mild dry

By intermittent control of compressor and indoor unit's fan, “New Mild Dry” gives you comfort. It realizes efficient dehumidification according to room temperature.

Easy
to install
BUILT-IN
DRAIN PUMP

Built-in drain pump

Maximum head 50 cm (or 75 cm for U type) from the bottom of the unit.

Further
comfort
AUTO-FLAP
CONTROL

Comfortable auto-flap control

When the unit is first turned on, flap position is automatically adjusted in accordance with the cooling or heating operation. This initial flap position can be preset within a certain range, for both cooling and heating. Auto button is included for continuous movement of flap to vary airflow direction.

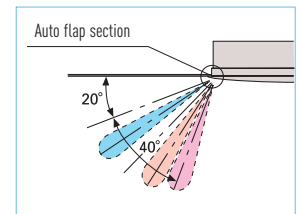

Maintenance and inspection is a must for gas heat pump air-conditioning systems.

Just like an automobile, a heat pump air-conditioning system requires periodic servicing so that it can perform efficiently.

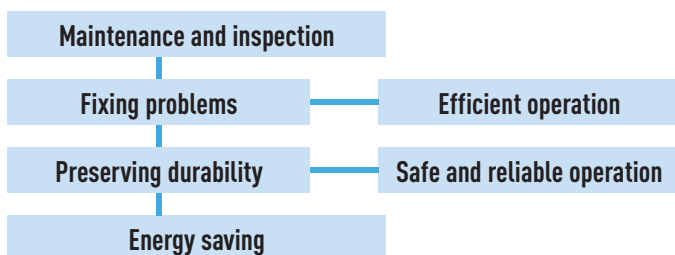

Main maintenance and inspection items

1. Changing the engine oil
2. Checking the coolant level
3. Inspecting the engine system
4. Checking the safety protection system
5. Checking and adjusting the running conditions, collecting operating data, etc.

Since a heat pump air-conditioning system uses a gas engine as its power source, it should be periodically inspected to avoid trouble and keep it running efficiently. We recommend a maintenance contract for your Panasonic Gas Heat Pump, a great value because it not only ensures that problems will be fixed, but it helps reduce running costs and improve comfort and economical efficiency as well.

Panasonic's software

ECOi VRF Designer

Panasonic is pleased to announce the launch of its new Advanced VRF Designer software. Building on the success of the ECOi VRF Designer software, this package provides air conditioning system designers, installers and dealers with a program to design and size projects for Panasonic's VRF ranges. Similar to the standard VRF Designer software, it is possible to create wiring diagrams, electrical power wiring and issue bills of quantities with a simple push of a button. With Panasonic's Advanced software, designers are now able to work directly from AutoCAD files, making the process extremely easy to manage and time-saving. AutoCAD drawings, print outs and scans from existing designs can be imported and altered with the system therein.

Super-efficient and built for the designers' every need, Panasonic's Advanced VRF software can create life-sized piping designs and automatic length calculation based on their imported drawings.

The Panasonic VRF Designer system software can be used for all Panasonic ECOi 6N and FS Multi VRF.

Features include:

- Easy to use system wizards.
- Auto piping and wiring features.
- Converted duties for conditions and pipework.
- Auto CAD (DXF), Excel and PDF export.
- Detailed wiring and pipework diagram.

Panasonic's Advanced VRF software with AutoCAD® compatibility makes design easier than ever

Panasonic provides bespoke software helping system designers, installers and dealers to very quickly design and size systems, create wiring diagrams and issue bills of quantities at the push of a button.



Panasonic
VRF
DESIGNER

GHP Checker Software

The handy tool for optimising the running of your system:

Diagnosis for start ups, maintenance and system supervising.

Features:

- Diagnosis with a PC
- Endless recording function allows analysis diagnosis even for long term running
- The GHP checker software needs no additional communication adaptor
- The communication between the PC and GHP is done by RS232

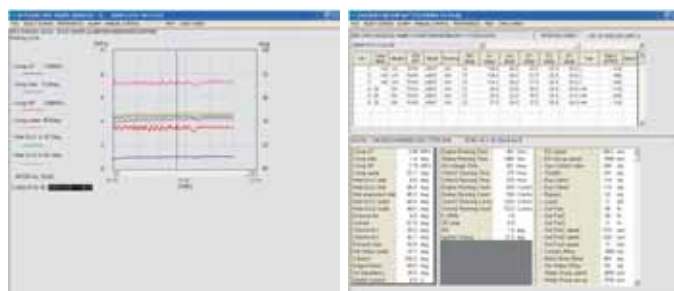

Panasonic VRF Service Checker

Panasonic will make available to installers and commissioning companies the VRF Service Checker as a communication interface to Panasonic VRF systems. This easy to manage tool checks all parameters of the system.

The VRF Service Checker allows:

- On ECOi and Mini ECOi connect anywhere on the P-Link
- Search the P-Link to validate systems that are connected
- Monitor all indoor and outdoor units simultaneously on 1 screen
- Monitor all Temperature data, Pressure data, Valve position, and alarm status on 1 screen
- Data can be viewed in Graph or number format
- Controlling the indoor unit ON/OFF, MODE, SET POINT, FAN, and TEST mode
- Switching between various systems on same communication P-Link (ECOi only)
- Monitor and record at a set interval time
- Record and review the data at a later date
- Update software as ROM flash writer

This Panasonic VRF Service Checker is available from your service partner.



Interface Box





Indoor units for ECOi and ECO G

Wide choice of models depending on the indoor requirements.



4 Way 90x90 Cassette

Wide & Comfortable Airflow

This proprietary design has wide-angle discharge outlets and flaps are larger in the middle, featuring a shape based on a combination of geometrics and the testing of prototype units. Air coming out of the center of the discharge outlets travels farther. From the sides of each outlet, where the openings are larger, airflow spreads out to reach the corners of the room. Air is discharged across a wide area from the four sides of the unit.

The curves on the room temperature distribution graph expand gently out through 360° in a circle centered on the indoor unit.

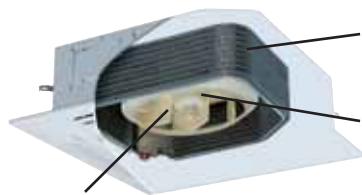

Higher efficiency split fin.

Improved heat-transfer coefficient due to adoption of high efficiently grooved heat exchanger tube.

New DC-Fan motor.

It is realized more optimum air-flow by a new DC-fan motor with independent control.

Individual flap control.

Flexible Air flow direction control by individual flap control is possible. 4 Flaps can be controlled individually by setting on wired timer remote controller. Several demands can be accommodated in one space.

High-efficient & Silent turbo Fan.

It is realized more air volume and more silent due to new development of a bigger fan chassis than previous one and optimization design of airflow path.

360°
air flow



Flexible 3D air-flow control

Comfort air flow control & proper energy use. Flexible Air flow direction control by individual flap control:

- 4 Flaps can be controlled individually (by standard wired remote controller*).
- It can make more flexible Air-flow control to be matched to several demands can be accommodated in one space.

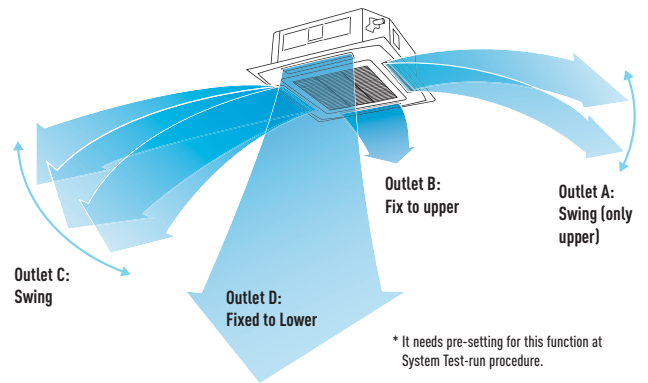

* It needs pre-setting for this function at System Test-run procedure.

New 360° Air Flow for better comfort

By redesigning the air-outlet and flap, Soft & 3D air flow circulates whole space and provides even temperature distribution in the room.

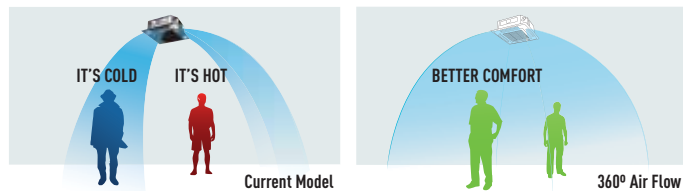
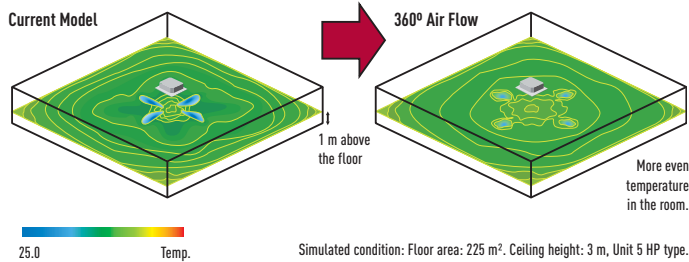

New design

Wide direction air discharge by outlet design.

The Circle Flow Flap and redesigned air outlet eliminate airflow along recessed parts on the ceiling to reduce contamination. If air flows only along these recessed parts, they will quickly become dirty. These new features greatly reduce accumulations of dirt.

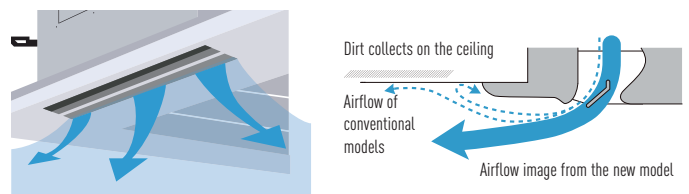

Air Discharge Temperature Control



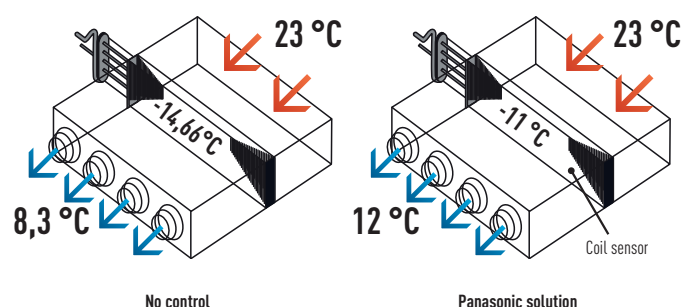



Available in all VRF indoor units, this control provides excellent comfort. Discharge air at below 10 °C is uncomfortable and can cause draughts. With Panasonic air discharge temperature control, air off temperature can be controlled between 7 °C - 22 °C.



ECOi and ECO G systems indoor units range

	1.5 kW	2.2 kW	2.8 kW	3.0 kW	3.6 kW	4.0 kW	4.5 kW
U1 Type // 4 Way 90x90 Cassette		 S-22MU1E5A	 S-28MU1E5A		 S-36MU1E5A		 S-45MU1E5A
Y2 TYPE // 4 Way 60x60 Cassette	 S-15MY2E5A	 S-22MY2E5A	 S-28MY2E5A		 S-36MY2E5A		 S-45MY2E5A
L1 Type // 2 Way Cassette		 S-22ML1E5	 S-28ML1E5		 S-36ML1E5		 S-45ML1E5
D1 Type // 1 Way Cassette			 S-28MD1E5		 S-36MD1E5		 S-45MD1E5
F2 Type // Variable Static Pressure Hide Away	 S-15MF2E5A	 S-22MF2E5A	 S-28MF2E5A		 S-36MF2E5A		 S-45MF2E5A
M1 Type // Slim Variable Static Pressure Hide Away	 S-15MM1E5A	 S-22MM1E5A	 S-28MM1E5A		 S-36MM1E5A		 S-45MM1E5A
E2 Type // High Static Pressure Hide Away							
Heat Recovery With DX Coil				 PAW-500ZDX2		 PAW-800ZDX2	 PAW-01KZDX2
T2 Type // Ceiling					 S-36MT2E5A		 S-45MT2E5A
K2/K1 Type // Wall Mounted	 S-15MK2E5A	 S-22MK2E5A	 S-28MK2E5A		 S-36MK2E5A		 S-45MK1E5A
P1 Type // Floor Standing		 S-22MP1E5	 S-28MP1E5		 S-36MP1E5		 S-45MP1E5
R1 Type // Concealed Floor Standing		 S-22MR1E5	 S-28MR1E5		 S-36MR1E5		 S-45MR1E5
Hydrokit for ECOi, water at 45°C							

Wide choice of models depending on the indoor requirements.

	16.0 kW	28.0 kW	56.0 kW	84.0 kW	112.0 kW	140.0 kW	168.0 kW
AHU Connection Kit 16, 28 and 56 kW for ECOi and ECO G	 PAW-160MAH2	 PAW-280MAH2	 PAW-560MAH2	 PAW-280MAH2 + PAW-560MAH2	 PAW-560MAH2 x 2	 PAW-280MAH2 + PAW-560MAH2 x 2	 PAW-560MAH2 x 3

5.6 kW	6.0 kW	7.3 kW	9.0 kW	10.6 kW	14.0 kW	16.0 kW	22.4 kW	28.0 kW
 S-56MU1E5A	 S-60MU1E5A	 S-73MU1E5A	 S-90MU1E5A	 S-106MU1E5A	 S-140MU1E5A	 S-160MU1E5A		
 S-56MY2E5A								
 S-56ML1E5		 S-73ML1E5						
 S-56MD1E5		 S-73MD1E5						
 S-56MF2E5A	 S-60MF2E5A	 S-73MF2E5A	 S-90MF2E5A	 S-106MF2E5A	 S-140MF2E5A	 S-160MF2E5A		
 S-56MM1E5A								
							 S-180ME2E5	 S-224ME2E5
								 S-280ME2E5
 S-56MT2E5A		 S-73MT2E5A		 S-106MT2E5A	 S-140MT2E5A			
 S-56MK1E5A		 S-73MK1E5A		 S-106MK1E5A				
 S-56MP1E5		 S-71MP1E5						
 S-56MR1E5		 S-71MR1E5						
			 S-80MW1E5		 S-125MW1E5			

	11.4 kW	25.0 kW	31.5 kW	37.5 kW
Air Curtain Jet-Flow with DX Coil	 PAW-10EAIRC-MJ	 PAW-15EAIRC-MJ	 PAW-20EAIRC-MJ	 PAW-25EAIRC-MJ
Air Curtain Standard with DX Coil	 PAW-10EAIRC-MS		 PAW-20EAIRC-MS	

U1 TYPE 4 WAY 90X90 CASSETTE SEMI CONCEALED CASSETTE



360°
air flow

The award winning range of U1 type cassettes are smaller, shallower and lighter than previous models and feature a 950 x 950mm panel throughout. The DC fan motor and air discharge louvre ensure quiet, optimum air distribution.

Technical focus

- Compact design
- Reduced sound levels (from previous models)
- DC fan motor for increased efficiency
- Powerful drain pump gives 850mm lift
- Lightweight design
- Fresh air knockout
- Branch duct connection
- Optional air-intake plenum CZ-FDU2

A drain height of approx. 850mm from the ceiling surface

The drain height can be increased by approximately 350mm over the conventional value by using a high-lift drain pump, and long horizontal piping is possible.

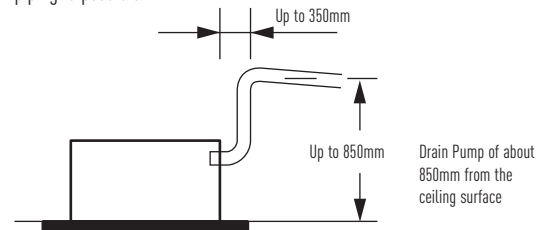

Air intake chamber

1. Air intake box CZ-BCU2 for main unit.
2. Air intake box CZ-ATU2* for Air intake plenum. CZ-CFU2 Part to close air flow for the cassette 90x90 series U1.

* When using Air intake box (CZ-ATU2), Air intake plenum (CZ-FDU2) is required.



Panel
CZ-KPU21



Optional Controller
Wired remote controller
CZ-RTC5



Optional Controller
Timer remote controller
CZ-RTC4



Optional Controller
Wireless remote controller
CZ-RWSU2



Optional Controller
Simplified remote controller
CZ-RE2C2

Model		S-22MU1E5A	S-28MU1E5A	S-36MU1E5A	S-45MU1E5A	S-56MU1E5A	S-60MU1E5A	S-73MU1E5A	S-90MU1E5A	S-106MU1E5A	S-140MU1E5A	S-160MU1E5A	
Power source		230 V / Single Phase / 50 Hz											
Cooling capacity	kW	2.2	2.8	3.6	4.5	5.6	6.0	7.3	9.0	10.6	14.0	16.0	
Power input cooling	W	20	20	20	20	25	35	40	40	95	100	115	
Operating current cooling	A	0.19	0.19	0.19	0.19	0.22	0.31	0.33	0.36	0.71	0.76	0.89	
Heating capacity	kW	2.5	3.2	4.2	5.0	6.3	7.1	8.0	10.0	11.4	16.0	18.0	
Power input heating	W	20	20	20	20	25	35	40	40	85	100	105	
Operating current heating	A	0.17	0.17	0.17	0.17	0.20	0.30	0.32	0.34	0.65	0.73	0.80	
Fan type		Turbo fan	Turbo fan	Turbo fan	Turbo fan	Turbo fan	Turbo fan	Turbo fan	Turbo fan	Turbo fan	Turbo fan	Turbo fan	
Air volume	Hi / Med / Lo	m ³ /h	840/720/660	840/720/660	840/720/660	900/780/720	960/810/720	1,260/1,020/840	1,320/1,020/840	1,380/1,140/900	1,980/1,620/1,260	2,100/1,680/1,320	2,160/1,740/1,380
Sound pressure level	Hi / Med / Lo	dB(A)	30 / 29 / 28	30 / 29 / 28	30 / 29 / 28	31 / 29 / 28	33 / 30 / 28	36 / 32 / 29	37 / 32 / 29	38 / 35 / 32	44 / 38 / 34	45 / 39 / 35	46 / 40 / 38
Dimensions	H x W x D	mm	256 (+33.5) x 840 (950) x 840 (950)										
Net weight	kg	23	23	23	23	23	24	24	24	27	27	27	
Pipe connections	Liquid	inch (mm)	1/4 (6.35)	1/4 (6.35)	1/4 (6.35)	1/4 (6.35)	1/4 (6.35)	3/8 (9.52)	3/8 (9.52)	3/8 (9.52)	3/8 (9.52)	3/8 (9.52)	3/8 (9.52)
	Gas	inch (mm)	1/2 (12.7)	1/2 (12.7)	1/2 (12.7)	1/2 (12.7)	1/2 (12.7)	5/8 (15.88)	5/8 (15.88)	5/8 (15.88)	5/8 (15.88)	5/8 (15.88)	5/8 (15.88)
Drain piping			VP-25	VP-25	VP-25	VP-25	VP-25	VP-25	VP-25	VP-25	VP-25	VP-25	

Rating Conditions: Cooling Indoor 27 °C DB / 19 °C WB. Cooling Outdoor 35 °C DB / 24 °C WB. Heating Indoor 20 °C DB. Heating Outdoor 7 °C DB / 6 °C WB.
DB: Dry Bulb; WB: Wet Bulb.

Optional

Internet Control Ready	Energy saving	Environmentally friendly refrigerant	Easy maintenance	For more comfort	Perfect humidity control	Further comfort	Practical operation	Comfort everywhere	Easy to install	Easy control by BMS
INTERNET CONTROL	INVERTER+	R410A	SELF-DIAGNOSING	AUTOMATIC FAN	MILD DRY	AUTO-FLAP CONTROL	AUTOMATIC RESTART	AIR SWEEP	BUILT-IN DRAIN PUMP	CONNECTIVITY

Y2 TYPE 4 WAY 60X60 CASSETTE MINI SEMI CONCEALED CASSETTE



Designed to fit exactly into a 600 x 600mm ceiling grid without the need to alter the bar configuration, the Y2 is ideal for small commercial and retrofit applications. In addition, the improvements to efficiency make this one of the most advanced units in the industry.

Technical focus

- Mini cassette fits into a 600 x 600mm ceiling grid
- Fresh air knock out
- Multidirectional air flow
- Powerful drain pump gives 850mm lift
- Turbo fans and heat exchanger fins with improved design
- DC fan motors with variable speed, new heat exchangers, etc. ensure an efficient power consumption

Special designed flap

The flap can be removed easily for washing with water.



A drain height of approx. 850mm from the ceiling surface

The drain height can be increased by approximately 350mm over the conventional value by using a high-lift drain pump, and long horizontal piping is possible.

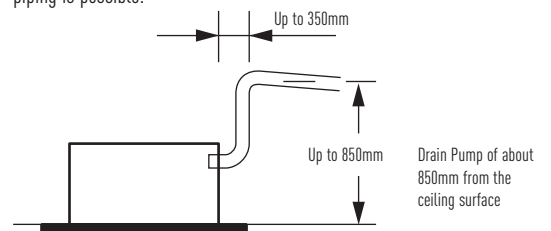

A lightweight unit at 18.4 kg the unit is also very slim with a height of only 288mm, making installation possible even in narrow ceilings.

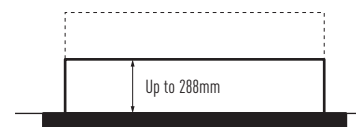

Panel
CZ-KPY3A (size 700 x 700mm)
CZ-KPY3B (size 625 x 625mm)



Optional Controller
Wired remote controller
CZ-RTC5



Optional Controller
Timer remote controller
CZ-RTC4



Optional Controller
Wireless remote controller
CZ-RWSK2



Optional Controller
Simplified remote controller
CZ-RE2C2

Model		S-15MY2E5A	S-22MY2E5A	S-28MY2E5A	S-36MY2E5A	S-45MY2E5A	S-56MY2E5A	
Power source		230 V / Single Phase / 50 Hz						
Cooling capacity	kW	1.5	2.2	2.8	3.6	4.5	5.6	
Power input cooling	W	35	35	35	40	40	45	
Operating current cooling	A	0.30	0.30	0.30	0.30	0.32	0.35	
Heating capacity	kW	1.7	2.5	3.2	4.2	5.0	6.3	
Power input heating	W	30	30	30	35	35	40	
Operating current heating	A	0.25	0.25	0.30	0.30	0.30	0.30	
Fan type		Centrifugal fan						
Air volume (Hi / Med / Lo)	Cooling	m ³ /h	534 / 492 / 336	546 / 492 / 336	558 / 504 / 336	582 / 522 / 360	600 / 558 / 492	624 / 588 / 510
	Heating	m ³ /h	546 / 504 / 336	558 / 504 / 336	576 / 522 / 336	594 / 546 / 360	618 / 576 / 492	666 / 588 / 522
Sound pressure level	Hi / Med / Lo	dB(A)	34 / 31 / 25	35 / 31 / 25	35 / 31 / 25	36 / 32 / 26	38 / 34 / 28	40 / 37 / 34
Dimensions	H x W x D	mm	288 x 583 x 583	288 x 583 x 583	288 x 583 x 583	288 x 583 x 583	288 x 583 x 583	288 x 583 x 583
Net weight		kg	20.4 (18 + 2.4)	20.4 (18 + 2.4)	20.4 (18 + 2.4)	20.4 (18 + 2.4)	20.4 (18 + 2.4)	20.4 (18 + 2.4)
Pipe connections	Liquid	inch (mm)	1/4 (6.35)	1/4 (6.35)	1/4 (6.35)	1/4 (6.35)	1/4 (6.35)	1/4 (6.35)
	Gas	inch (mm)	1/2 (12.7)	1/2 (12.7)	1/2 (12.7)	1/2 (12.7)	1/2 (12.7)	1/2 (12.7)
	Drain piping		VP-25	VP-25	VP-25	VP-25	VP-25	VP-25

Rating Conditions: Cooling Indoor 27 °C DB / 19 °C WB. Cooling Outdoor 35 °C DB / 24 °C WB. Heating Indoor 20 °C DB. Heating Outdoor 7 °C DB / 6 °C WB.
DB: Dry Bulb; WB: Wet Bulb.

Optional

Internet Control Ready INTERNET CONTROL	Energy saving INVERTER+	Environmentally friendly refrigerant R410A	Easy maintenance SELF-DIAGNOSING	For more comfort AUTOMATIC FAN	Perfect humidity control MILD DRY	Further comfort AUTO-FLAP CONTROL	Practical operation AUTOMATIC RESTART	Comfort everywhere AIR SWEEP	Easy to install BUILT-IN DRAIN PUMP	Easy control by BMS CONNECTIVITY
---	-----------------------------------	--	--	--	---	---	---	--	---	--

L1 TYPE 2 WAY CASSETTE



Slim, compact and lightweight units. Remarkable size and weight reductions have been achieved by improvement of the design around the fan, the weight of all models now being 30 kg.

Technical focus

- Airflow and distribution is automatically altered depending on the operational mode of the unit
- Drain up is possible up to 500mm from the drain port
- Simple maintenance

Simple maintenance

The drain pan is equipped with site wiring and can be removed. The fan case has a split construction, and the fan motor can be removed easily when the lower case is removed.

Airflow and distribution is automatically altered depending on the operational mode of the unit.

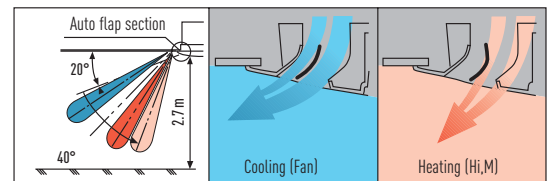

Drain up is possible up to 500mm from the drain port.

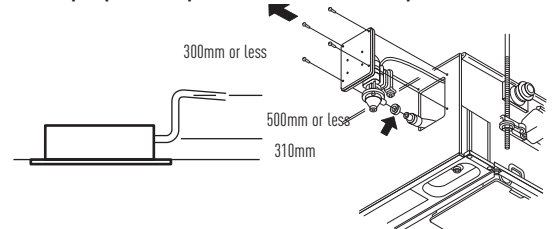

Maintenance of the drain pump is possible from two sides, from the left side (piping side) and from the inside of the unit.



Panel
CZ-02KPL2
CZ-03KPL2 (for S-73ML1E5)



Optional Controller
Wired remote controller
CZ-RTC5



Optional Controller
Timer remote controller
CZ-RTC4



Optional Controller
Wireless remote controller
CZ-RWSL2



Optional Controller
Simplified remote controller
CZ-RE2C2

Model		S-22ML1E5	S-28ML1E5	S-36ML1E5	S-45ML1E5	S-56ML1E5	S-73ML1E5
Power source		230 V / Single Phase / 50 Hz					
Cooling capacity	kW	2.2	2.8	3.6	4.5	5.6	7.3
Power input cooling	W	90	92	93	97	97	145
Operating current cooling	A	0.45	0.45	0.45	0.45	0.45	0.65
Heating capacity	kW	2.5	3.2	4.2	5.0	6.3	8.0
Power input heating	W	58	60	61	65	65	109
Operating current heating	A	0.29	0.29	0.29	0.29	0.29	0.48
Fan type		Sirocco fan					
Air volume	Hi / Med / Lo m ³ /h	480 / 420 / 360	540 / 480 / 420	580 / 520 / 460	660 / 540 / 480	660 / 540 / 480	1,140 / 960 / 840
Sound pressure level	Hi / Med / Lo dB(A)	30 / 27 / 24	33 / 29 / 26	34 / 31 / 28	35 / 33 / 29	35 / 33 / 29	38 / 35 / 33
Dimensions	H x W x D mm	350(+8)x840 (1,060)x600 (680)	350(+8)x840 (1,060)x600 (680)	350(+8)x840 (1,060)x600 (680)	350(+8)x840 (1,060)x600 (680)	350(+8)x840 (1,060)x600 (680)	350(+8)x1,140 (1,360)x600 (680)
Net weight	kg	28.5 (23 + 5.5)	28.5 (23 + 5.5)	28.5 (23 + 5.5)	28.5 (23 + 5.5)	28.5 (23 + 5.5)	39 (30 + 9)
Pipe connections	Liquid inch (mm)	1/4 (6.35)	1/4 (6.35)	1/4 (6.35)	1/4 (6.35)	1/4 (6.35)	3/8 (9.52)
	Gas inch (mm)	1/2 (12.7)	1/2 (12.7)	1/2 (12.7)	1/2 (12.7)	1/2 (12.7)	5/8 (15.88)
Drain piping		VP-25					

Rating Conditions: Cooling Indoor 27 °C DB / 19 °C WB. Cooling Outdoor 35 °C DB / 24 °C WB. Heating Indoor 20 °C DB. Heating Outdoor 7 °C DB / 6 °C WB.
DB: Dry Bulb; WB: Wet Bulb.

Optional



D1 TYPE 1 WAY CASSETTE



Designed for installation within the ceiling void, the D1 range of slimline 1 way blow cassettes feature powerful yet quiet fans for up to 4.2 m.

Technical focus

- Ultra-Slim
- Suitable for standard and high ceilings
- Built-in drain pump provides 590mm lift
- Easy to install and maintain
- Hanging height can be easily adjusted
- Uses a DC fan motor to improve energy-efficiency

Drain height

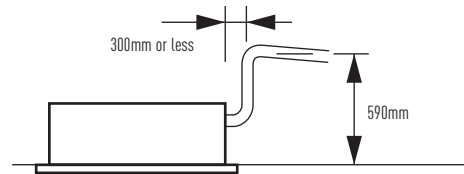

Panel
CZ-KPD2



Optional Controller
Wired remote controller
CZ-RTC5



Optional Controller
Timer remote controller
CZ-RTC4



Optional Controller
Wireless remote controller
CZ-RWST2



Optional Controller
Simplified remote controller
CZ-RE2C2

Model		S-28MD1E5	S-36MD1E5	S-45MD1E5	S-56MD1E5	S-73MD1E5
Power source		230 V / Single Phase / 50 Hz				
Cooling capacity	kW	2.8	3.6	4.5	5.6	7.3
Power input cooling	W	51	51	51	60	87
Operating current cooling	A	0.39	0.39	0.39	0.46	0.7
Heating capacity	kW	3.2	4.2	5.0	6.3	8.0
Power input heating	W	40	40	40	48	76
Operating current heating	A	0.35	0.35	0.35	0.41	0.65
Fan type		Sirocco fan	Sirocco fan	Sirocco fan	Sirocco fan	Sirocco fan
Air volume	Hi / Med / Lo m ³ /h	720 / 600 / 540	720 / 600 / 540	720 / 660 / 600	780 / 690 / 600	1,080 / 900 / 780
Sound pressure level	Hi / Med / Lo dB(A)	36 / 34 / 33	36 / 34 / 33	36 / 35 / 34	38 / 36 / 34	45 / 40 / 36
Dimensions	H x W x D mm	200 (+20)x1,000 (1,230)x710 (800)	200 (+20)x1,000 (1,230)x710 (800)	200 (+20)x1,000 (1,230)x710 (800)	200 (+20)x1,000 (1,230)x710 (800)	200 (+20)x1,000 (1,230)x710 (800)
Net weight	kg	26.5 (21 + 5.5)	26.5 (21 + 5.5)	26.5 (21 + 5.5)	26.5 (21 + 5.5)	27.5 (22 + 5.5)
Pipe connections	Liquid	inch (mm)	1/4 (6.35)	1/4 (6.35)	1/4 (6.35)	3/8 (9.52)
	Gas	inch (mm)	1/2 (12.7)	1/2 (12.7)	1/2 (12.7)	5/8 (15.88)
Drain piping		VP-25	VP-25	VP-25	VP-25	VP-25

Rating Conditions: Cooling Indoor 27 °C DB / 19 °C WB. Cooling Outdoor 35 °C DB / 24 °C WB. Heating Indoor 20 °C DB. Heating Outdoor 7 °C DB / 6 °C WB.
DB: Dry Bulb; WB: Wet Bulb.

Optional

Internet Control Ready INTERNET CONTROL	Energy saving INVERTER+	Environmentally friendly refrigerant R410A	Easy maintenance SELF-DIAGNOSING	For more comfort AUTOMATIC FAN	Perfect humidity control MILD DRY	Further comfort AUTO-FLAP CONTROL	Practical operation AUTOMATIC RESTART	Comfort everywhere AIR SWEEP	Easy to install BUILT-IN DRAIN PUMP	Easy control by BMS CONNECTIVITY
--	----------------------------	---	-------------------------------------	-----------------------------------	--------------------------------------	--------------------------------------	--	---------------------------------	--	-------------------------------------

F2 TYPE VARIABLE STATIC PRESSURE HIDE AWAY



S-15MF2E5A // S-22MF2E5A // S-28MF2E5A // S-36MF2E5A // S-45MF2E5A // S-56MF2E5A

S-60MF2E5A // S-73MF2E5A // S-90MF2E5A

S-106MF2E5A // S-140MF2E5A // S-160MF2E5A

The new F2 type is designed specifically for applications requiring fixed square ducting. The internal filter is equipped as standard.

Technical focus

- Industry-leading low sound levels from 25 dB(A)
- Built-in drain pump provides 785mm lift
- Easy to install and maintain
- Air OFF sensor avoids cold air dumping
- Configurable air temperature control

More powerful drain pump

Using a high-lift drain pump, drain piping can be elevated up to 785mm from the base of the unit.

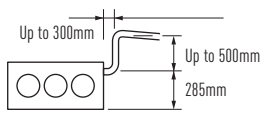

Air Outlet & Inlet Plenum

S-...MF2E5A	Diameters	Air Outlet Plenum	Diameters	Air Inlet Plenum
22, 28, 36, 45 & 56	2 x Ø 200	CZ-56DAF2	2 x Ø 200	CZ-DUMPA56MF2
60, 73 & 90	3 x Ø 200	CZ-90DAF2	2 x Ø 250	CZ-DUMPA90MF2
106, 140 & 160	4 x Ø 200	CZ-160DAF2	4 x Ø 200	CZ-DUMPA160MF2



New Variable Static Pressure Hide Away MF2 series

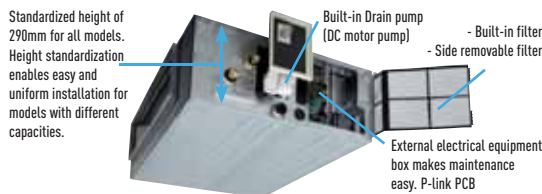

Full range of External Static Pressure and Airflow Volumes available by special setting

To meet all design needs thanks to DC fan motor it is possible to select the best fitted airflow/ static pressure curve.

The table below shows the airflow and noise data at minimum airflows curve selectable (Example S-22MF2E5A: see red dot in the diagram n.1)

and noise data at maximum rated static pressure with maximum airflow curve selectable (example S-22MF2E5A blu dot in diagram n.1). Specific diagrams per each units are available in ECOi Technical Data Book.

Model		15-36	45	56	60-73	90	106	140	160
Minimum air volume - the red dot - on minimum airflow curve selectable (curve 1-3)	m³/h	480	480	600	780	960	1.140	1.200	1.320
Min Static Pressure value - the red dot - on minimum airflow curve selectable (curve 1-3)	Pa	15	15	15	10	10	20	15	15
Noise level at minimum static pressure - the red dot - on minimum airflow curve selectable (curve 1-3)	dB(A)	24	26	26	24	26	29	30	31
Noise level at maximum rated static pressure - the blue dot - on maximum airflow curve selectable (curve 15)	dB(A)	34	35	35	40	41	42	42	43

F2 Advantages

Automatic learning function for the required static pressure, to be activated easily by the standard wired timer remote controller. Possible to increase the sensible cooling capacity by adjusting the air volume flow in order to almost completely eliminate latent losses. This is possible due to the outstanding big heat exchanger surface in combination with increasing the air volume flow by a manual selection of higher fan speed curves through the standard wired remote controller when commissioning the system together with the default active off-coil temperature control and the room load based variable evaporation temperature control.

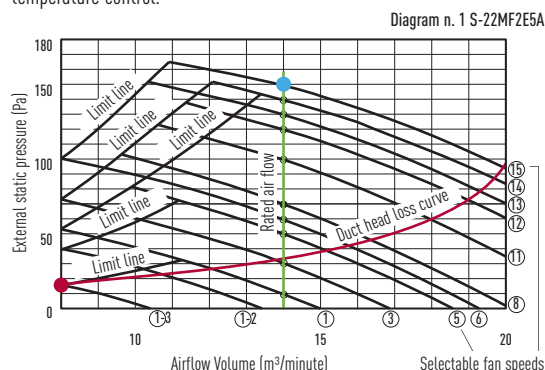

Optional Controller
Wired remote controller
CZ-RTC5



Optional Controller
Timer remote controller
CZ-RTC4



Optional Controller
Wireless remote controller
CZ-RWSK2 + CZ-RWSC3



Optional Controller
Simplified remote controller
CZ-RE2C2

Model	S-15MF2E5A	S-22MF2E5A	S-28MF2E5A	S-36MF2E5A	S-45MF2E5A	S-56MF2E5A	S-60MF2E5A	S-73MF2E5A	S-90MF2E5A	S-106MF2E5A	S-140MF2E5A	S-160MF2E5A		
Power source	230 V / Single Phase / 50 Hz													
Cooling capacity	kW	1.5	2.2	2.8	3.6	4.5	5.6	6.0	7.3	9.0	10.6	14.0	16.0	
Power input cooling	W	70	70	70	70	70	100	120	120	135	195	215	225	
Operating current cooling	A	0.57	0.57	0.57	0.57	0.57	0.74	0.89	0.89	0.97	1.30	1.44	1.50	
Heating capacity	kW	1.7	2.5	3.2	4.2	5.0	6.3	7.1	8.0	10.0	11.4	16.0	18.0	
Power input heating	W	70	70	70	70	100	100	120	120	135	200	210	225	
Operating current heating	A	0.57	0.57	0.57	0.57	0.57	0.74	0.89	0.89	0.97	1.34	1.42	1.50	
Fan type	Sirocco fan													
Air volume ¹⁾	Hi / Med / Lo	m³/h	840/780/540	840/780/540	840/780/540	840/780/540	840/780/600	960/900/720	1,260/1,140/900	1,260/1,140/900	1,500/1,380/1,140	1,920/1,560/1,260	2,040/1,740/1,380	2,160/1,920/1,500
External static pressure	Pa	70 (10-150)	70 (10-150)	70 (10-150)	70 (10-150)	70 (10-150)	70 (10-150)	70 (10-150)	70 (10-150)	70 (10-150)	100 (10-150)	100 (10-150)	100 (10-150)	
Sound power level ²⁾	Hi / Med / Lo	dB	55 / 51 / 44	55 / 51 / 44	55 / 51 / 44	55 / 51 / 44	56 / 54 / 47	56 / 54 / 47	57 / 54 / 48	57 / 54 / 48	59 / 56 / 50	60 / 56 / 53	61 / 57 / 54	62 / 58 / 55
Sound pressure level ²⁾	Hi / Med / Lo	dB(A)	33 / 29 / 22	33 / 29 / 22	33 / 29 / 22	33 / 29 / 22	34 / 32 / 25	34 / 32 / 25	35 / 32 / 26	35 / 32 / 26	37 / 34 / 28	38 / 34 / 31	39 / 35 / 32	40 / 36 / 33
Dimensions	H x W x D	mm	290x800x700	290x800x700	290x800x700	290x800x700	290x800x700	290x800x700	290x1,000x700	290x1,000x700	290x1,400x700	290x1,400x700	290x1,400x700	
Net weight	kg	29	29	29	29	29	29	34	34	34	46	46	46	
Pipe connections	Liquid	inch (mm)	1/4 (6.35)	1/4 (6.35)	1/4 (6.35)	1/4 (6.35)	1/4 (6.35)	1/4 (6.35)	3/8 (9.52)	3/8 (9.52)	3/8 (9.52)	3/8 (9.52)	3/8 (9.52)	
	Gas	inch (mm)	1/2 (12.7)	1/2 (12.7)	1/2 (12.7)	1/2 (12.7)	1/2 (12.7)	1/2 (12.7)	5/8 (15.88)	5/8 (15.88)	5/8 (15.88)	5/8 (15.88)	5/8 (15.88)	
	Drain piping		VP-25	VP-25	VP-25	VP-25	VP-25	VP-25	VP-25	VP-25	VP-25	VP-25	VP-25	

Rating Conditions: Cooling Indoor 27 °C DB / 19 °C WB. Cooling Outdoor 35 °C DB / 24 °C WB. Heating Indoor 20 °C DB. Heating Outdoor 7 °C DB / 6 °C WB. DB: Dry Bulb; WB: Wet Bulb.

1)) Value referred to standard settings at shipment (H curve 8, M curve 5, L curve 1). 2) Sound pressure without refrigerant flow.

Optional



M1 TYPE SLIM VARIABLE STATIC PRESSURE HIDE AWAY CONCEALED DUCT



The ultra slim M1 type is one of the leading products of its type in the industry. With a depth of only 200mm it provides greater flexibility and can be used in far more applications. In addition, its high-efficiency and extremely quiet sound levels make it very popular with many users, including hotels and small offices.

Technical focus

- Ultra-slim profile: 200mm for all models
- DC fan motor greatly reduces power consumption
- Ideal for hotel application with very narrow false ceilings
- Easy maintenance and service by external electrical box
- 40 Pa static pressure enables ductwork to be fitted.
- Includes drain pump

Air Outlet & Inlet Plenum

S-...MM1E5A	Diameters	Air Outlet Plenum	Diameters	Air Inlet Plenum
22, 28 & 36	2 x Ø 200	CZ-DUMPA22MMS2	2 x Ø 200	CZ-DUMPA22MMR2
45 & 56	3 x Ø 160	CZ-DUMPA45MMS3	2 x Ø 200	CZ-DUMPA22MMR3

Ultra-slim profile for all models



Drain pump with increased power!

By adoption of a high-lift drain pump, the drain piping rise height can be increased to 785mm from the lower surface of the body.

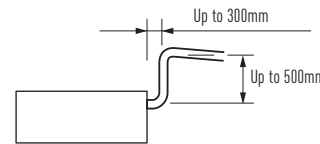

Optional Controller
Wired remote controller
CZ-RTC5



Optional Controller
Timer remote controller
CZ-RTC4



Optional Controller
Wireless remote controller
CZ-RWSK2 + CZ-RWSC3



Optional Controller
Simplified remote controller
CZ-RE2C2

Model		S-15MM1E5A	S-22MM1E5A	S-28MM1E5A	S-36MM1E5A	S-45MM1E5A	S-56MM1E5A
Power source		230 V / Single Phase / 50 Hz					
Cooling capacity	kW	1.5	2.2	2.8	3.6	4.5	5.6
Power input cooling	W	36	36	40	42	49	64
Operating current cooling	A	0.26	0.26	0.30	0.31	0.37	0.48
Heating capacity	kW	1.7	2.5	3.2	4.2	5.0	6.3
Power input heating	W	26	26	30	32	39	54
Operating current heating	A	0.23	0.23	0.27	0.28	0.34	0.45
Fan type		Sirocco fan					
Air volume	Hi / Med / Lo	m³/h	480 / 420 / 360	480 / 420 / 360	510 / 450 / 390	540 / 480 / 420	630 / 570 / 480
External static pressure		Pa	10 (30)	10 (30)	15 (30)	15 (40)	15 (40)
Sound pressure level	Hi / Med / Lo (1)	dB(A)	28 / 27 / 25 (30 / 29 / 27)	28 / 27 / 25 (30 / 29 / 27)	30 / 29 / 27 (32 / 31 / 29)	32 / 30 / 28 (34 / 32 / 30)	34 / 32 / 30 (36 / 34 / 32)
Dimensions	H x W x D	mm	200 x 750 x 640	200 x 750 x 640	200 x 750 x 640	200 x 750 x 640	200 x 750 x 640
Net weight		kg	19	19	19	19	19
Pipe connections	Liquid	inch (mm)	1/4 (6.35)	1/4 (6.35)	1/4 (6.35)	1/4 (6.35)	1/4 (6.35)
	Gas	inch (mm)	1/2 (12.7)	1/2 (12.7)	1/2 (12.7)	1/2 (12.7)	1/2 (12.7)
	Drain piping		VP-20	VP-20	VP-20	VP-20	VP-20

Rating Conditions: Cooling Indoor 27 °C DB / 19 °C WB. Cooling Outdoor 35 °C DB / 24 °C WB. Heating Indoor 20 °C DB. Heating Outdoor 7 °C DB / 6 °C WB.
DB: Dry Bulb; WB: Wet Bulb.

1) With booster cable using short circuit connection.

Optional

Internet Control Ready INTERNET CONTROL	Energy saving INVERTER+	Environmentally friendly refrigerant R410A	Easy maintenance SELF-DIAGNOSING	For more comfort AUTOMATIC FAN	Perfect humidity control MILD DRY	Practical operation AUTOMATIC RESTART	Comfort everywhere AIR SWEEP	Easy to install BUILT-IN DRAIN PUMP	Easy control by BMS CONNECTIVITY
---	-----------------------------------	--	--	--	---	---	--	---	--

E2 TYPE HIGH STATIC PRESSURE HIDE AWAY



2 products in 1: High pressure duct and 100% Fresh air duct function. The E2 range of ducted units offers improved design flexibility for extended duct layouts as a result of their increased external static pressures and reduces energy consumption.

Technical focus

- **NEW!** No need of rap valve
- **NEW!** 100% Fresh air duct function
- **NEW!** DC fan motor for more savings
- Complete flexibility for ductwork design
- Can be located into a weatherproof housing for external siting
- Air OFF sensor avoids cold air dumping
- Configurable air temperature control

System example

An inspection port (450 x 450mm or more) is required at the lower side of the indoor unit body (field supply).

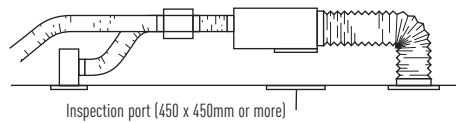

100% Fresh air duct function

The New E2 duct with 100% fresh air duct function have exceptional discharge temperature.

	Discharge Range		
	Min	Max	Default
Cooling	15°C	24°C	18°C
Heating	17°C	45°C	40°C

Plenums

Air Outlet Plenum (suitable for rigid + flexible duct)		
	N. of exits with diameters	Model
S-224ME1E5A / S-280ME1E5	1 x 500mm	CZ-TREMIESPW706

Kit for 100% Fresh air function

For 2 Way systems		For 3 Way systems	
2x CZ-P160RVK2	Rap valve kit	2x CZ-P160HR3	3 way valve kit
2x CZ-CAPE2	3way control PCB	2x CZ-CAPE2	3 way control PCB
CZ-P680BK2	Distribution Joint kit	CZ-P680BH2	Distribution Joint kit
1x Remocon		1x Remocon	



Optional Controller
Wired remote controller
CZ-RTC5



Optional Controller
Timer remote controller
CZ-RTC4



Optional Controller
Wireless remote controller
CZ-RWSK2 + CZ-RWSC3



Optional Controller
Simplified remote controller
CZ-RE2C2

Model	100% Fresh air duct function (by using Kit for 100% Fresh air)			High pressure duct		
	S-180ME2E5	S-224ME2E5	S-280ME2E5	S-180ME2E5	S-224ME2E5	S-280ME2E5
Power source		230 V / Single Phase / 50 Hz	230 V / Single Phase / 50 Hz		230 V / Single Phase / 50 Hz	230 V / Single Phase / 50 Hz
Cooling capacity	kW	22.4	28.0		22.4	28.0
Power input cooling	W	290	350		440	715
Operating current cooling	A	1.85	2.20		2.45	3.95
Heating capacity	kW	21.2	26.5		25.0	31.5
Power input heating	W	290	350		440	715
Operating current heating	A	1.85	2.20		2.45	3.95
Fan type		Sirocco fan	Sirocco fan		Sirocco fan	Sirocco fan
Air volume	Hi / Med / Lo	700 / - / -	2,100 / - / -		3,360 / 3,060 / 2,640	4,320 / 3,780 / 3,180
External static pressure	Pa	200	200		140 (60 / 270) ¹⁾	140 (72 / 270) ¹⁾
Sound pressure level ²⁾	Hi / Med / Lo	- / - / 43	- / - / 44		45 / 43 / 41	49 / 47 / 43
Dimensions	H x W x D	479 x 1,453 x 1,205	479 x 1,453 x 1,205		479 x 1,453 x 1,205	479 x 1,453 x 1,205
Net weight	kg	102	106		102	106
Pipe connections	Liquid	inch (mm)	3/8 (9.52)		3/8 (9.52)	3/8 (9.52)
	Gas	inch (mm)	3/4 (19.05)		3/4 (19.05)	7/8 (22.22)
	Drain piping		VP-25		VP-25	VP-25

Rating Conditions: Cooling Indoor 27 °C DB / 19 °C WB. Cooling Outdoor 35 °C DB / 24 °C WB. Heating Indoor 20 °C DB. Heating Outdoor 7 °C DB / 6 °C WB.
Rating Conditions for 100% Fresh air duct function: Cooling Outdoor 33°C DB / 28°C WB. Heating Outdoor 0°C DB / -2.9°C WB.
DB: Dry Bulb; WB: Wet Bulb.

1) Available to select the setting by initial setup.
2) Values with 140Pa setting.

Optional

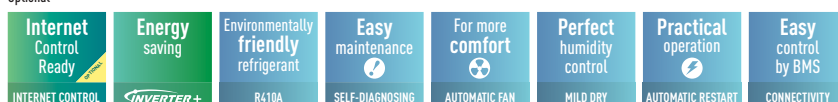

HEAT RECOVERY WITH DX COIL



Optional Controller
Wired remote controller
CZ-RTC5



Optional Controller
Timer remote controller
CZ-RTC4

Technical focus

- Motorised heat recovery by-pass device automatically controlled by unit control to use fresh air free-cooling when convenient
- The Bioxygen® purifying system, activates when the fan runs, provides an efficient antibacterial treatment, ensuring optimum health of supplied air

General characteristics

- Galvanized steel self-supporting panels, internally and externally insulated
- Counterflow air-to-air heat recovery device, made of sheets of special paper with special sealing to keep airflows separate and only permeable to water vapor. Total heat exchange with temperature efficiency up to 77% and enthalpy efficiency up to 63%, also at high level during summer season
- G4 efficiency class filters with synthetic cleanable media, both on fresh air and return air intake
- Removable side panel to access filters and heat recovery in the event of scheduled maintenance
- Low consumption, high efficiency & low noise direct driven fans with 3-speed EC motors
- Supply section complete with DX coil (R410A) fitted with solenoid control valve, freon filter, contact temperature sensors on liquid and gas line, NTC sensors upstream and downstream airflow
- Built-in electric box equipped with PCB to control internal fan speed and to interconnect outdoor/indoor units
- Duct connection by circular plastic collars
- CZ-RTC4 Timer remote controller (option)

Balanced Ventilation

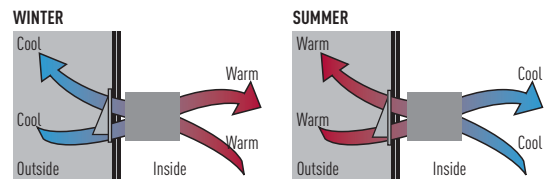

Interconnection to outdoor/indoor units

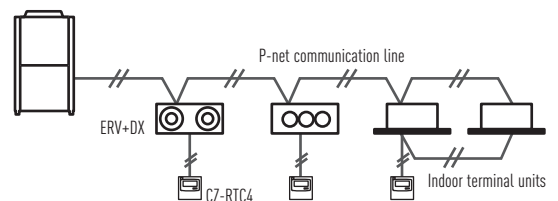

Characteristic curves

The following curves show the unit external static pressure at maximum fan speed for each model.

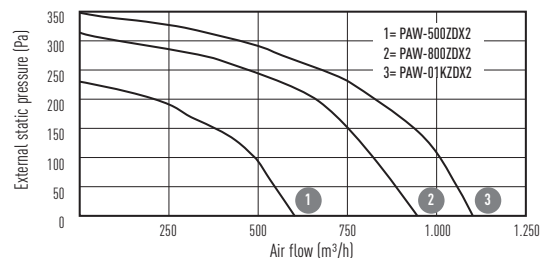

Model ¹	PAW-500ZDX2		PAW-800ZDX2		PAW-01KZDX2	
Power source	230 V / Single Phase / 50 Hz		230 V / Single Phase / 50 Hz		230 V / Single Phase / 50 Hz	
Air volume	Hi / Med / Lo	m ³ /h	500 / 500 / 360	800 / 800 / 625	1,000 / 780 / 650	
External static pressure ²	Hi / Med / Lo	Pa	85 / 45 / 21	117 / 68 / 18	104 / 69 / 17	
Maximum current		A	1.1	2.3	2.5	
Maximum power input		W	135	300	310	
Sound pressure level ³	Hi / Med / Lo	dB(A)	33 / 31 / 27	38 / 36 / 32	39 / 37 / 33	
Pipe connections	Liquid / Gas	inch (mm)	1/4 (6.35) / 1/2 (12.7)	1/4 (6.35) / 1/2 (12.7)	1/4 (6.35) / 1/2 (12.7)	
HEAT RECOVERY						
Temperature efficiency summer mode	%		62.5	59	59.5	
Enthalpy efficiency summer mode	%		60	57	57.5	
Saved power summer mode	kW		1.7	2.5	3.2	
Temperature efficiency winter mode	%		76.5 (76.5)	73 (73)	73.5 (73.5)	
Enthalpy efficiency winter mode	%		62.3 (64.1)	59 (60.8)	59.5 (61.2)	
Saved power winter mode	kW		4.3 (4.8)	6.5 (7.3)	8.2 (9.0)	
DX COIL						
Total cooling capacity	kW		3.7	4.9	5.6	
Sensible cooling capacity	kW		2.3	3.3	3.8	
Off temperature	Cooling	°C	14.4	16.2	17.0	
Off relative humidity	Cooling	%	87	83	82	
Total heating capacity	kW		3.9 (4.1)	5.4 (5.7)	6.3 (6.7)	
Off temperature	Heating	°C	35.4 (34.6)	32.6 (31.7)	31.3 (30.3)	
Off relative humidity	Heating	%	11 (11)	12 (13)	13 (14)	

Nominal summer conditions: Outside air: 32°C DB, RH 50%. Ambient air: 26°C DB, RH 50%. Nominal winter conditions: Outside air: -5°C (-10°C) DB, RH 80%. Ambient air: 20°C DB, RH 50%. Cooling mode air inlet condition: 28.5°C DB, RH 50%; evaporating temp. 4°C. Heating mode air inlet condition: 13°C DB, RH 40% (11°C DB, RH 45%); condensating temperature 49°C. DB: Dry Bulb; RH: Relative Humidity.

1) Available in December 2014. 2) Referred to the nominal air flow after filter and plate heat exchanger. 3) Referred to 1.5 meters from inlet in free field condition.

Optional

Internet Control Ready	Energy saving	Environmentally friendly refrigerant	Easy maintenance	For more comfort	Perfect humidity control	Further comfort	Practical operation	Comfort everywhere	Easy control by BMS
INTERNET CONTROL	INVERTER+	R410A	SELF-DIAGNOSING	AUTOMATIC FAN	MILD DRY	AUTO-FLAP CONTROL	AUTOMATIC RESTART	AIR SWEEP	CONNECTIVITY

T2 TYPE CEILING



S-36MT2E5A // S-45MT2E5A // S-56MT2E5A



S-106MT2E5A // S-140MT2E5A

The T2 TYPE ceiling mounted units feature a DC fan motor for increased efficiency and reduced operating sound levels. All the units are the same height and depth for a uniform appearance in mixed installations and feature a fresh air knockout for improved air quality.

Technical focus

- Low sound levels
- New design, all units just 235mm high
- Large and wide air distribution
- Easy to install and maintain
- Fresh air knockout

Further comfort improvement

The wide air discharge opening widens the air flow to the left and the right, so that a comfortable temperature is obtained in the entire room.

The unpleasant feeling caused when the air flow directly hits the human body is prevented by the "Draft prevention position", which changes the swing width, so that the degree of comfort is increased.

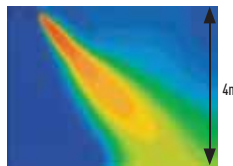

Further comfort improvement with airflow distribution

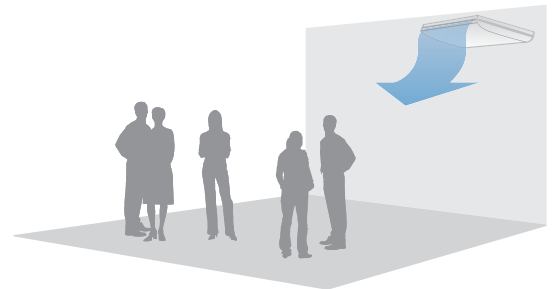

Air distribution is automatically altered depending on the operational mode of the unit

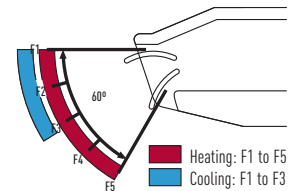

Optional Controller
Wired remote controller
CZ-RTC5



Optional Controller
Timer remote controller
CZ-RTC4



Optional Controller
Wireless remote controller
CZ-RWSK2 + CZ-RWST3



Optional Controller
Simplified remote controller
CZ-RE2C2

Model		S-36MT2E5A	S-45MT2E5A	S-56MT2E5A	S-73MT2E5A	S-106MT2E5A	S-140MT2E5A
Power source		230 V / Single Phase / 50 Hz					
Cooling capacity	kW	3.6	4.5	5.6	7.3	10.6	14.0
Power input cooling	W	35	40	40	55	80	100
Operating current cooling	A	0.36	0.38	0.38	0.44	0.67	0.79
Heating capacity	kW	4.2	5.0	6.3	8.0	11.4	16.0
Power input heating	W	35	40	40	55	80	100
Operating current heating	A	0.36	0.38	0.38	0.44	0.67	0.79
Fan type		Sirocco fan	Sirocco fan	Sirocco fan	Sirocco fan	Sirocco fan	Sirocco fan
Air volume	Hi / Med / Lo m ³ /h	840 / 720 / 630	900 / 750 / 630	900 / 750 / 630	1,260 / 1,080 / 930	1,800 / 1,500 / 1,380	1,920 / 1,680 / 1,440
Sound pressure level	L ₁ ¹⁾ / Hi / Med / Lo dB(A)	- / 36 / 32 / 30	- / 37 / 33 / 30	- / 37 / 33 / 30	- / 39 / 35 / 33	- / 42 / 37 / 36	- / 46 / 40 / 37
Dimensions	H x W x D mm	235 x 960 x 690	235 x 960 x 690	235 x 960 x 690	235 x 1,275 x 690	235 x 1,590 x 690	235 x 1,590 x 690
Net weight	kg	27	27	27	33	40	40
Pipe connections	Liquid inch (mm)	1/4 (6.35)	1/4 (6.35)	1/4 (6.35)	3/8 (9.52)	3/8 (9.52)	3/8 (9.52)
	Gas inch (mm)	1/2 (12.7)	1/2 (12.7)	1/2 (12.7)	5/8 (15.88)	5/8 (15.88)	5/8 (15.88)
	Drain piping	VP-20	VP-20	VP-20	VP-20	VP-20	VP-20

Rating Conditions: Cooling Indoor 27 °C DB / 19 °C WB. Cooling Outdoor 35 °C DB / 24 °C WB. Heating Indoor 20 °C DB. Heating Outdoor 7 °C DB / 6 °C WB. DB: Dry Bulb; WB: Wet Bulb.

1) Sound pressure level with fan only.
* Preliminary data.

Optional

Internet Control Ready INTERNET CONTROL	Energy saving INVERTER+	Environmentally friendly refrigerant R410A	Easy maintenance SELF-DIAGNOSING	For more comfort AUTOMATIC FAN	Perfect humidity control MILD DRY	Further comfort AUTO-FLAP CONTROL	Practical operation AUTOMATIC RESTART	Comfort everywhere AIR SWEEP	Easy control by BMS CONNECTIVITY
---	-----------------------------------	--	--	--	---	---	---	--	--

K2/K1 TYPE WALL MOUNTED



S-15MK2E5A // S-22MK2E5A // S-28MK2E5A // S-36MK2E5A



S-45MK1E5A // S-56MK1E5A // S-73MK1E5A // S-106MK1E5A

The K2/K1 Type wall mounted unit has a stylish smooth panel which not only looks good but is also easy to clean.

The unit is also smaller, lighter and substantially quieter than previous models making it ideal for small offices and other commercial applications.

Technical focus

- Closed discharge port
- Lighter and smaller units make the installation easy
- Quiet operation
- Smooth and durable design
- Piping outlet in three directions
- Washable front panel
- Air distribution is automatically altered depending on the operational mode of the unit

Closed discharge port

When the unit is turned OFF, the flap closes completely to prevent entry of dust into the unit and to keep the equipment clean.

Lighter and smaller units make the installation easy

The width has been decreased by 17% and the units are lighter.

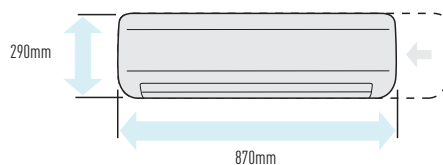

Quiet operation

These units are among the quietest in the industry, making them ideal for hotels and hospitals.

Smooth and durable design

The smooth cover means these units match most modern interiors. Their compact size enables them to blend in, even in small spaces.

Piping outlet in three directions

Piping outlet is possible in the three directions of rear, right, and left, making the installation work easier.

Washable front panel

The indoor unit's front panel can be easily removed and washed for trouble-free cleaning.

Air distribution is automatically altered depending on the operational mode of the unit

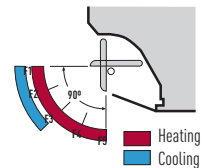

External valve (Optional)

CZ-P56SVK2 (model sizes 15 to 56)
CZ-P160SVK2 (model sizes 73 to 106)



Optional Controller
Wired remote controller
CZ-RTC5



Optional Controller
Timer remote controller
CZ-RTC4



Optional Controller
Wireless remote controller
CZ-RWSK2



Optional Controller
Simplified remote controller
CZ-RE2C2

Model		S-15MK2E5A	S-22MK2E5A	S-28MK2E5	S-36MK2E5	S-45MK1E5A	S-56MK1E5A	S-73MK1E5A	S-106MK1E5A	
Power source						230 V / Single Phase / 50 Hz				
Cooling capacity	kW	1.5	2.2	2.8	3.6	4.5	5.6	7.3	10.6	
Power input cooling	W	25	25	25	30	20	30	57	60	
Operating current cooling	A	0.20	0.21	0.23	0.25	0.26	0.35	0.58	0.62	
Heating capacity	kW	1.7	2.5	3.2	4.2	5.0	6.3	8.0	11.4	
Power input heating	W	25	25	25	30	20	30	57	68	
Operating current heating	A	0.20	0.21	0.23	0.25	0.26	0.35	0.58	0.70	
Fan type		Cross flow	Cross flow	Cross flow	Cross flow	Cross flow	Cross flow	Cross flow	Cross flow	
Air volume	Hi / Med / Lo	m ³ /h	474 / 444 / 390	540/450/390	570/498/390	654/540/390	720 / 630 / 510	840 / 720 / 630	1,080 / 870 / 690	1,140 / 990 / 780
		m ³ /h	540 / 462 / 408	552/498/408	582/510/408	672/570/408				
Sound pressure level	L1 / Hi / Med / Lo	dB(A)	— / 34 / 32 / 29	— / 36 / 33 / 29	— / 37 / 34 / 29	— / 40 / 36 / 29	— / 40 / 36 / 32	— / 47 / 44 / 40	— / 49 / 45 / 42	
Dimensions	H x W x D	mm	290 x 870 x 214	290 x 870 x 214	290 x 870 x 214	290 x 870 x 214	300 x 1,065 x 230	300 x 1,065 x 230	300 x 1,065 x 230	300 x 1,065 x 230
Net weight		kg	9	9	9	9	13	13	14.5	14.5
Pipe connections	Liquid	inch (mm)	1/4 (6.35)	1/4 (6.35)	1/4 (6.35)	1/4 (6.35)	1/4 (6.35)	3/8 (9.52)	3/8 (9.52)	
	Gas	inch (mm)	1/2 (12.7)	1/2 (12.7)	1/2 (12.7)	1/2 (12.7)	1/2 (12.7)	5/8 (15.88)	5/8 (15.88)	
	Drain piping (O.D.)	φ	φ 16	φ 16	φ 16	φ 16	φ 18	φ 18	φ 18	

Rating Conditions: Cooling Indoor 27 °C DB / 19 °C WB. Cooling Outdoor 35 °C DB / 24 °C WB. Heating Indoor 20 °C DB. Heating Outdoor 7 °C DB / 6 °C WB.
DB: Dry Bulb; WB: Wet Bulb.

1) Sound pressure level with fan only.

Optional

Internet Control Ready INTERNET CONTROL	Energy saving INVERTER+	Environmentally friendly refrigerant R410A	Easy maintenance SELF-DIAGNOSING	For more comfort AUTOMATIC FAN	Perfect humidity control MILD DRY	Further comfort AUTO-FLAP CONTROL	Practical operation AUTOMATIC RESTART	Comfort everywhere AIR SWEEP	Easy control by BMS CONNECTIVITY
---	-----------------------------------	--	--	--	---	---	---	--	--

P1 TYPE FLOOR STANDING

R1 TYPE CONCEALED FLOOR STANDING



Optional Controller
Wired remote controller
CZ-RTC5



Optional Controller
Timer remote controller
CZ-RTC4



Optional Controller
Wireless remote controller
CZ-RWSK2 + CZ-RWSC3



Optional Controller
Simplified remote controller
CZ-RE2C2

P1 Type

The compact floor standing P1 units are the ideal solution for providing perimeter air conditioning. The standard wired controller can be incorporated into the body of the unit.

Technical focus

- Pipes can be connected to either side of the unit from the bottom or rear
- Easy to install
- Front panel opens fully for easy maintenance
- Removable air discharge grille gives flexible air flow
- Room for condensate pump
- For build-in remote control, only CZ-RTC2 is suitable

Effective perimeter handling

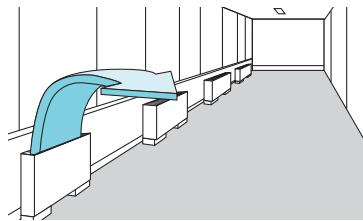

A standard wired remote control can be installed in the body



R1 Type

At just 229 mm deep, the R1 unit can be easily concealed in perimeter areas to provide powerful and effective air conditioning.

Technical focus

- Chassis unit for discreet installation
- Complete with removable filters
- Pipes can be connected to either side of the unit from the bottom or rear
- Easy to install

Perimeter air conditioning with high interior quality

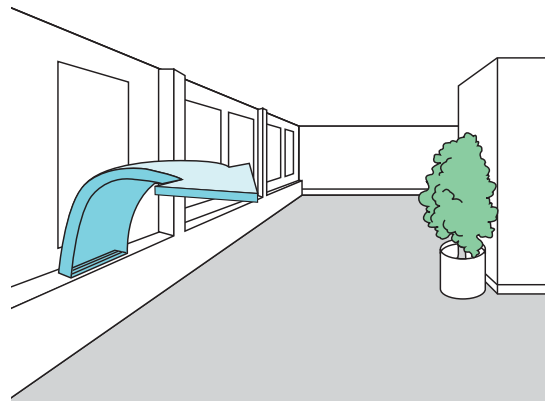

Model P1 Type		S-22MP1E5	S-28MP1E5	S-36MP1E5	S-45MP1E5	S-56MP1E5	S-71MP1E5
Model R1 Type		S-22MR1E5	S-28MR1E5	S-36MR1E5	S-45MR1E5	S-56MR1E5	S-71MR1E5
Power source		230 V / Single Phase / 50 Hz					
Cooling capacity	kW	2.2	2.8	3.6	4.5	5.6	7.1
Power input cooling	W	56	56	85	126	126	160
Operating current cooling	A	0.25	0.25	0.38	0.56	0.56	0.72
Heating capacity	kW	2.5	3.2	4.2	5.0	6.3	8.0
Power input heating	W	40	40	70	91	91	120
Operating current heating	A	0.18	0.18	0.31	0.41	0.41	0.54
Fan type		Sirocco fan					
Air volume	Hi / Med / Lo	m ³ /h	420 / 360 / 300	420 / 360 / 300	540 / 420 / 360	720 / 540 / 480	900 / 780 / 660
Sound pressure level	Hi / Med / Lo	dB(A)	33 / 30 / 28	33 / 30 / 28	39 / 35 / 29	38 / 35 / 31	41 / 38 / 35
Dimensions P1 Type	H x W x D	mm	615 x 1,065 x 230	615 x 1,065 x 230	615 x 1,065 x 230	615 x 1,380 x 230	615 x 1,380 x 230
Net weight P1 Type		kg	29	29	29	39	39
Dimensions R1 Type	H x W x D	mm	616 x 904 x 229	616 x 904 x 229	616 x 904 x 229	616 x 1,219 x 229	616 x 1,219 x 229
Net weight R1 Type		kg	21	21	21	28	28
Pipe connections							
	Liquid	inch (mm)	1/4 (6.35)	1/4 (6.35)	1/4 (6.35)	1/4 (6.35)	3/8 (9.52)
	Gas	inch (mm)	1/2 (12.7)	1/2 (12.7)	1/2 (12.7)	1/2 (12.7)	5/8 (15.88)
	Drain piping		VP-20	VP-20	VP-20	VP-20	VP-20

Rating Conditions: Cooling Indoor 27 °C DB / 19 °C WB. Cooling Outdoor 35 °C DB / 24 °C WB. Heating Indoor 20 °C DB. Heating Outdoor 7 °C DB / 6 °C WB.
DB: Dry Bulb; WB: Wet Bulb.

Optional

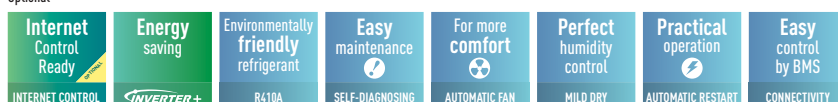

HYDROKIT FOR ECOi WATER AT 45 °C



Optional Controller
Wired remote controller
CZ-RTC5

Connect the Hydrokit to your VRF system, together with other indoor units.

Technical focus

- Only with 3-Pipe ECOi MF2 6N Series outdoor units
- Remote controller CZ-RTC5 common use with DX Coil indoor units ECOi and PACi

Basic principle & advantage

Hydrokit module provides hot water by using waste heat that is recovered from standard air-conditioning indoor unit in cooling mode. Total system performs high energy efficiency by this heat recovering operation, and it gives an advantage for the environmental-friendly assessment scheme (ex. BREEAM in UK).

Hydrokit control function / CZ-RTC5

- CZ-RTC5 is updated version from CZ-RTC3. It can be used for hydrokit and also normal indoor unit. CZ-RTC5 checks the type of connected unit and switch hydrokit or air conditioner style of display automatically
- Operating mode on hydrokit style to be set at initial setting of the system from following modes: tank mode or air conditioning mode

Overview: hydromodule in VRF system

- Multiple hydromodule connection in same circuit is available
- Each module can be set different operation mode either hot water supply mode or space heating mode (both operation modes are not able to set at 1 hydromodule)
- 3-Pipe control solenoid valve kit is necessary for each indoor unit and hydromodule

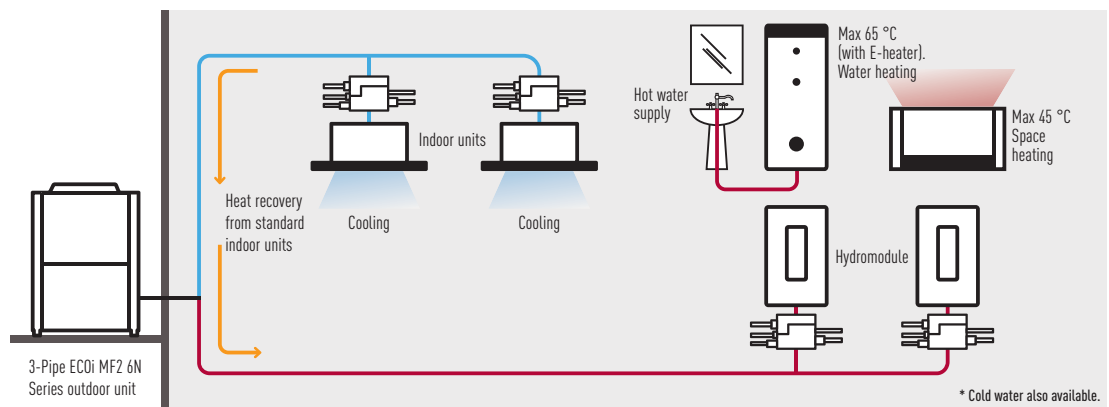

Model*		S-80MW1E5		S-125MW1E5	
Power source		230 V / Single Phase / 50 Hz		230 V / Single Phase / 50 Hz	
Cooling capacity		kW	8.0	12.5	
Heating capacity		kW	9.0	14.0	
Power input heating (hydrokit)		W	—	—	
Operating current heating (hydrokit)		A	—	—	
Maximum temperature		°C	-45 / -65 ¹	-45 / -65 ¹	
Dimensions		H x W x D	mm 892 x 502 x 353	892 x 502 x 353	
Net weight		kg	—	—	
Water pipe connector		inch	R1 1/4	R1 1/4	
Water pump (built-in)		DC motor (A class)		DC motor (A class)	
Water flow rate					
		Cooling	l/min 22.9	35.8	
		Heating	l/min 25.8	40.1	
Sound pressure level			dB(A) —	—	
Pipe connections					
		Liquid	inch (mm) 3/8 (9.52)	3/8 (9.52)	
		Gas	inch (mm) 5/8 (15.88)	5/8 (15.88)	
		Drain piping	15 - 17 mm (inner size)		15 - 17 mm (inner size)
Operation range					
		Cooling	Ambient	°C +10 / +43	+10 / +43
			Water	°C +5 / +20	+5 / +20
		Heating	Ambient	°C -20 / +32	-20 / +32
			Water	°C +25 / +45	+25 / +45
Connectable system		3-Pipe (heat recovery type) VRF system (system capable up to 48 HP)			
Maximum Indoor ratio (connectable hydrokit module capacity ratio)		Total indoor unit + Hydrokit capacity: up to 130 % (** - **% vs, total outdoor unit capacity)			

Rating Conditions: Cooling Indoor 27 °C DB / 19 °C WB. Cooling Outdoor 35 °C DB / 24 °C WB. Heating Indoor 20 °C DB. Heating Outdoor 7 °C DB / 6 °C WB.
DB: Dry Bulb; WB: Wet Bulb.

1) Max 45 °C by refrigerant circuit (heat pump cycle), over 45 °C is provided by electric heater operation.

* Tentative Data. Available from October 2015.



Panasonic Ventilation Solutions

For maximum savings and easy integration.

Air Handling Unit Kit

Connects easily to your ECOi and ECO G systems.

Energy Recovery Ventilator

Energy recovery ventilators offer ventilation which increases comfort and saves energy. They efficiently recover the heat lost in ventilation during the heat recovery process.

Air Handling Unit Kit

New AHU Kits connect ECOi and GHP systems to air handling unit systems, using the same refrigerant circuit as the VRF system.



Air Curtain with DX Coil

High efficiency Air curtain connected to your VRF installation. EC Fan motor for a smooth operation and efficient performance.



Energy Recovery Ventilator

Suppresses indoor temperature changes while providing fresh air.

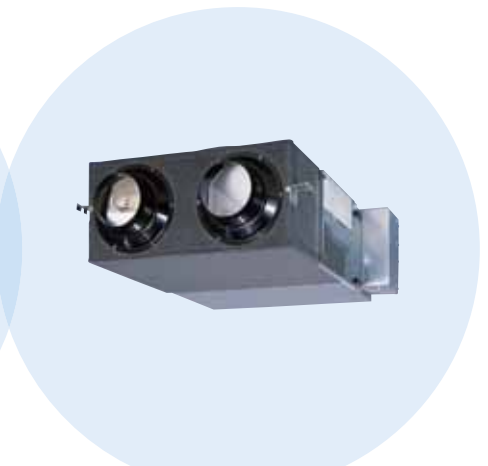

AHU connection kit 16 kW, 28 kW and 56 kW for ECOi and GHP

Heat exchanger, Fan & Fan motor to be mounted in AHU Kit shall be provided in the field.

AHU connection Kit (field supplied) AHU Kit system. (Contents of kit: Control for PCB, expansion valve, sensors).

Application: Hotels, offices, server rooms or all large buildings where air quality control such as humidity control and fresh air and is needed.

AHU Kit combine air conditioning and fresh air in just one solution.

Air Curtain with DX Coil

Highly efficient heating effect

The combined air stream, which has a desirable low air current induction factor (mixing factor), can carry the selected initial temperature effect over long distances, and will reach the floor area while still at room temperature. This is necessary to avoid cooling down the interior spaces.

Energy Recovery Ventilator

- Counter-flow heat exchange element used for reduced noise and slimmer, more compact body shape
- All maintenance can be performed through a single inspection hole
- Straight air supply / exhaust system used for easier installation
- Each unit can be mounted in reverse position.
- Equipped with an Extra-High setting
- Can incorporate a medium performance filter (optional, installed on site)



NEW

**16kW // IP65 //
COMPACT BODY**

Air Handling Unit Kit

New AHU Kits connect ECOi and ECO G systems to air handling unit systems, using the same refrigerant circuit as the VRF system. Large connectivity possibilities mean the Panasonic AHU Kit can be easily integrated. Application: Hotels, offices, server rooms or all large buildings where air quality control such as humidity control and fresh air and is needed.

2 types of AHU Kit: Advanced and Light

Model Code	IP 65	0-10V demand control	Outdoor temperature shift compensation. Cold draft prevention
PAW-160MAH2 / PAW-280MAH2 / PAW-560MAH2	Yes	Yes	Yes
PAW-160MAH2L / PAW-280MAH2L / PAW-560MAH2L	Yes	No	No

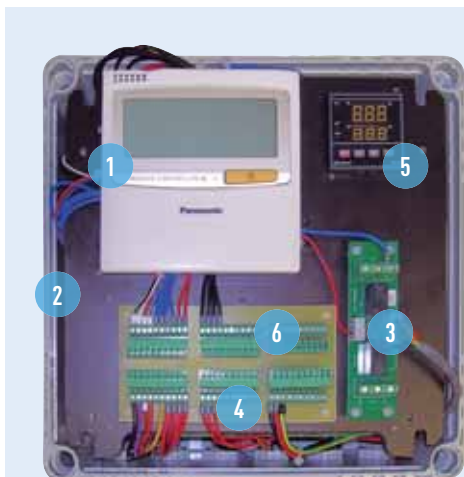

1. Remote control CZ-RTC4
2. New plastic IP 65 Box
3. PAW-T10 PCB for dry contact
4. 0-10V demand control PCB
5. Intelligent thermostat for:
 - Cold draft prevention
 - Outdoor temperature shift compensation
6. Terminal base for sensors and power supply

AHU Connection Kit



PCB, Power trans, Terminal block



Expansion valve



Thermistor x2 (Refrigerant: E1, E3)

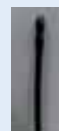

Thermistor x2 (Air: Tf, Tb)

Remote controller



Standard wired remote controller. Can be installed inside the box.

Panasonic AHU Kit, 16-56 kW connected to ECOi or ECO G outdoor unit

PCB, Transformer, Solenoid Control Valve, Thermistor x 4 pcs, Terminal Base and Electrical Component Box.

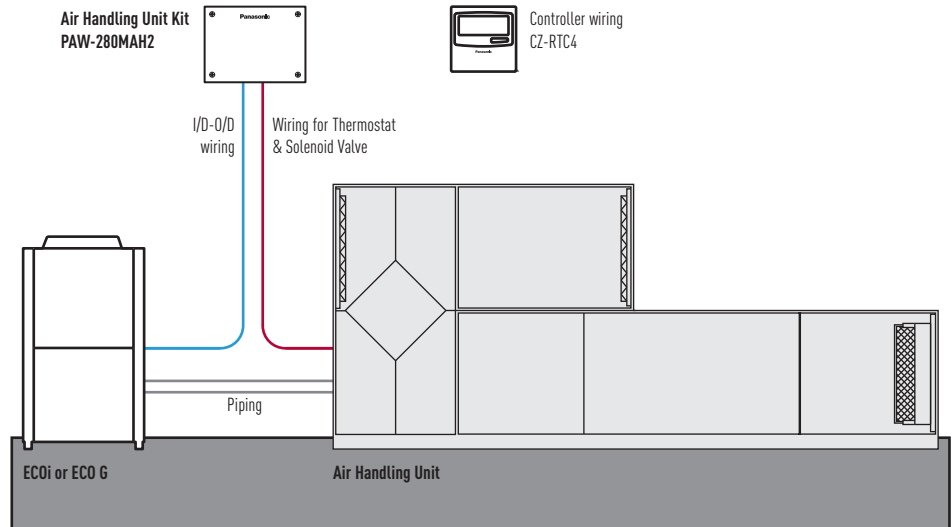

System example for large capacity (more than 56 kW)

3 x [PCB, Transformer, Solenoid Control Valve, Thermistor x 4 pcs, Terminal Base and Electrical Component Box].

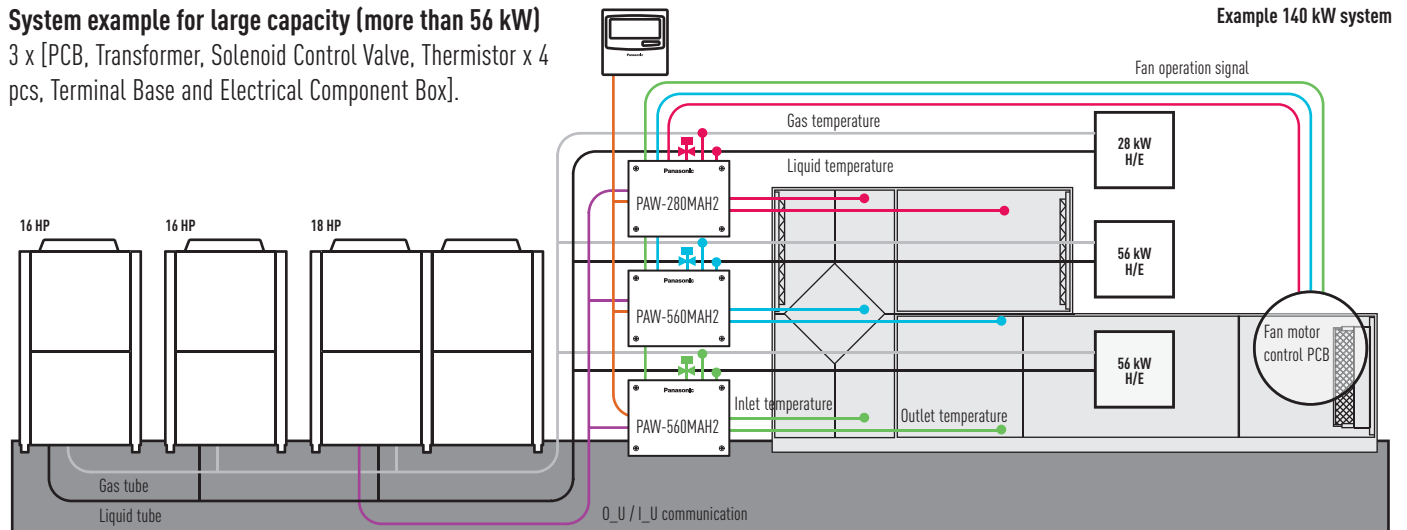

Optional parts: Following functions are available by using different control accessories:

CZ-RTC4 Timer remote controller

- Operation-ON/OFF
- Mode select
- Temperature setting

* Fan operation signal can be taken from the PCB.

CZ-T10 terminal

- Input signal= Operation ON/OFF
- Remote controller prohibition
- Output signal= Operating-ON status
- Alarm output (by DC12V)

PAW-OCT, DC12 V outlet. OPTION terminal

- Output signal= Cooling/Heating/Fan status
- Defrost
- Thermostat-ON

PAW-T10 PCB to connect to T10 connector

- A Dry contact PCB has been developed to easily control the unit
- Input signal operation ON/OFF
- Remote control prohibition
- Output signal Operation ON status maximum 230 V 5 A (NO/NC)
- Output signal Alarm status maximum 230 V 5 A (NO/NC)

Additional available contacts:

- External humidifier control (ON/OFF) 230 VAC 3 A
- External fan control (ON/OFF) 12V DC
- External filter status signal potential free
- External float switch signal potential free
- External leakage detection sensor or TH. OFF contact potential free (possible usage for external blow out temperature control)

CZ-CAPBC2 Mini seri-para I/O unit

- Demand control 40% to 120% (5% steps) by 0-10V input signal
- Temperature setting by 0-10 V or 0-140 Ω input signal
- Room (inlet air) temp outlet by 4-20 mA
- Mode select or/and ON/OFF control
- Fan operation control
- Operation status output/ Alarm output
- Thermostat ON/OFF control

AHU CONNECTION KIT 16, 28 AND 56 kW FOR ECOi AND GHP



6N series 2-Pipe ECOi outdoor unit shall be used for AHU connection KIT.

3 models for VRF system: 5 HP (PAW-160MAH2), 10 HP (PAW-280MAH2) and 20 HP (PAW-560MAH2).

With GHP outdoor units:

- One AHU kit may be used for one GHP unit (2 way, 56 kW). Multiple AHU kits cannot be used
- Mixed with standard indoor units is not allowed
- Power specifications are Single Phase 220 V to 240 V

HP			5 HP	10 HP	20 HP	30 HP	40 HP	50 HP	60 HP
Model			PAW-160MAH2	PAW-280MAH2	PAW-560MAH2	PAW-280MAH2 + PAW-560MAH2	PAW-560MAH2 + PAW-560MAH2	PAW-560MAH2 + PAW-560MAH2 + PAW-280MAH2	PAW-560MAH2 + PAW-560MAH2 + PAW-560MAH2
Nominal cooling capacity @ 50Hz	kW		14.0	28.0	56.0	84.0	112.0	140.0	168.0
Nominal heating @ 50Hz	kW		16.0	31.5	63.0	95.0	127.0	155.0	189.0
Cooling airflow	High	m ³ /min	2,160	5,000	10,000	15,000	20,000	25,000	30,000
	Low	m ³ /min	1,140	3,500	7,000	10,500	14,000	17,500	21,000
Bypass factor			0.9 (recommended)	0.9 (recommended)	0.9 (recommended)	0.9 (recommended)	0.9 (recommended)	0.9 (recommended)	0.9 (recommended)
Dimensions of the box	H x W x D	mm	303 x 232 x 110	404 x 425 x 78	404 x 425 x 78	404 x 425 x 78	404 x 425 x 78	404 x 425 x 78	404 x 425 x 78
Weight	kg		3.2	6.3	6.3	6.3	6.3	6.3	6.3
Piping length	Min / Max	m	10 / 100	10 / 100	10 / 100	10 / 100	10 / 100	10 / 100	10 / 100
Elevation difference (in/out)	Max	m	10	10	10	10	10	10	10
Piping connections	Liquid pipe	Inch (mm)	3/8 (9.52)	3/8 (9.52)	5/8 (15.88)	3/4 (19.05)	3/4 (19.05)	3/4 (19.05)	3/4 (19.05)
	Gas pipe	Inch (mm)	5/8 (15.88)	7/8 (22.22)	1 1/8 (28.58)	1 1/4 (31.75)	1 1/2 (38.15)	1 1/2 (38.15)	1 1/2 (38.15)
Intake temperature of AHU Kit	Cooling (Min / Max)	°C	18-32°C DB (13-23°C WB)	18 - 32°C DB (13 - 23°C WB)	18 - 32°C DB (13 - 23°C WB)	18 - 32°C DB (13 - 23°C WB)	18 - 32°C DB (13 - 23°C WB)	18 - 32°C DB (13 - 23°C WB)	18 - 32°C DB (13 - 23°C WB)
	Heating (Min / Max)	°C	16-30°C DB	16 - 30°C TK	16 - 30°C TK	16 - 30°C TK	16 - 30°C TK	16 - 30°C TK	16 - 30°C TK
Ambient temperature of outdoor unit	Cooling (Min / Max)	°C	-10 - 34°C DB	-10 - 34°C DB	-10 - 34°C DB	-10 - 34°C DB	-10 - 34°C DB	-10 - 34°C DB	-10 - 34°C DB
	Heating (Min / Max)	°C	-10 - 15°C WB	-10 - 15°C WB	-10 - 15°C WB	-10 - 15°C WB	-10 - 15°C WB	-10 - 15°C WB	-10 - 15°C WB

AHU connection kit / System combination		
Capacity (HP)	Outdoor unit combination	AHU kit combination
28 kW (10 HP)	U-10ME1E81	PAW-280MAH2
56 kW (20 HP)	U-20ME1E81	PAW-560MAH2
84 kW (30 HP)	U-16ME1E81	PAW-560MAH2
112 kW (40 HP)	U-20ME1E81	PAW-280MAH2
140 kW (50 HP)	U-18ME1E81	PAW-560MAH2
168 kW (60 HP)	U-20ME1E81	PAW-560MAH2
56 kW (20 HP)	U-20GE2E5	PAW-560MAH2



Timer remote controller
CZ-RTC2/C4

Technical focus

- Maximum capacity: 60HP (168 kW)
- Maximum piping length: 100 m (120 m equivalent)
- Elevation difference (O_U-I_U): 50 m (O_U above)
- Elevation difference (I_U-I_U): 4 m
- In/Out capacity ratio: 50~100%
- Maximum I_U number: 3 units*
- Outdoor temperature range in Heating: -20 - 15°C
- Available temperature range for the suction air at AHU Kit:
Cool: 18 - 32°C / Heat: 16 - 30°C

* To be simultaneous operation controlled by one remote controller sensor.

- The systems is controlled by the suction air (or room return air) temperature (same as standard indoor unit). (Selectable mode: Automatic / Cooling / Heating / Fan / Dry (but same as Cool))
- The discharge air temperature is also controlled to prevent too-low air discharge in cooling or too-high air discharge in heating (in case of VRF)
- Demand control (Forcible thermostat-OFF control by operating current)
- Defrost operation signal, Thermo-ON/OFF states output
- Drain pump control (Drain-pump and the float switch to be supplied in local)
- External target temperature setting via Indoor/Outdoor signal interface is available with CZ-CAPBC2 (Ex. 0 - 10 V)
- Demand control 40% to 120% (5% steps) by 0-10V input signal
- Connectable with P-LINK system. Special care for electrical noise may be necessary depending on the on-side system
- Fan control signal from the PCB can be used for control the air volume (High/Mid/Low and LL for Th-OFF). Need to change the fan control circuit wiring at field

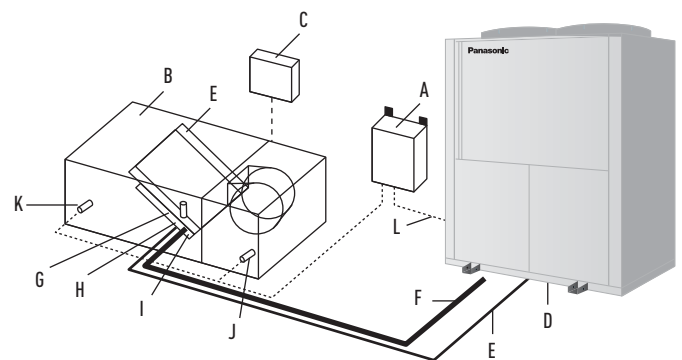
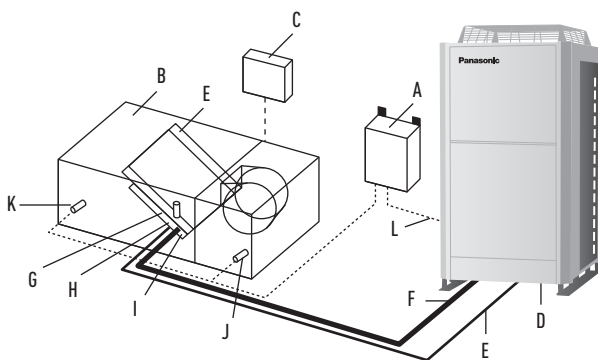

System & regulations. System overview

- A: AHU Kit controller box (with control PCB)
- B: AHU Kit equipment (Field supplied)
- C: AHU Kit system controller (Field supplied)
- D: Outdoor unit
- E: Gas piping (Field supplied)
- F: Liquid piping (Field supplied)
- G: Electronic expansion valve
- H: Thermistor for Gas pipe
- I: Thermistor for Liquid pipe
- J: Thermistor for Suction air
- K: Thermistor for Discharge air
- L: Inter-unit wiring



Air Curtain with DX Coil, connected to the VRF or PACi Systems

The Panasonic range of air curtains is designed for smooth operation and efficient performance. Air curtains produce a continuous stream of air blown from the top to the bottom of an open doorway and create a barrier that people and products can flow across, but air can't. Designed to improve energy efficiency, minimise heat loss from a building, and to allow retailers to keep doors open to encourage customers, our Air Curtains are suitable for connection to both VRF and PACi Systems.

- Super-efficient with new EC fan motor (40% lower running costs compared to a standard AC fan motor)
- Easy Cleaning and Servicing
- Can be connected to either Panasonic VRF or PACi systems
- Built-in drain for cooling operation
- Standard and Jet Flow air curtains can be controlled via Panasonic's range of remote internet controls

The new standard and jet-flow models are ideal for connection to a ECOi or PACi system. With simple 'plug and play' installation, both are fitted with an EC fan motor for a smooth operation and efficient performance. This new fan guarantees 40% lower running cost than with a standard AC fan motor. With air curtains often running for 12 hours a day as a minimum, this can lead to considerable savings.

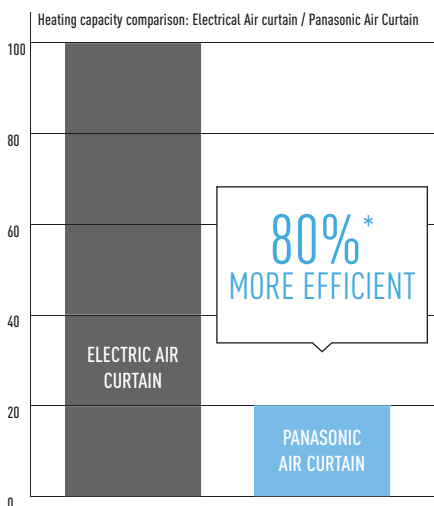

Highly efficient heating effect

The combined air stream, which has a desirable low air current induction factor (mixing factor), can carry the selected initial temperature effect over long distances, and will reach the floor area while still at room temperature. This is necessary to avoid cooling down the interior spaces.

Available in different lengths to suit requirements between 1 and 2.5m, both air curtains have outlet grilles that can be adjusted to five different positions. The jet flow model can be installed up to a height of 3.5m with the standard model up to 3.0m. The outlet grilles can be easily adjusted into five positions to suit different installations requirements and the air filter can be accessed without the need for specialist tools.

* With the U-100PE1E5 on the PAW-20PAIRC-MS.
Calculation method: Taking as consideration SCOP of the Panasonic combination of 6.0. If 100 is the energy needed for a air curtain, Panasonic Air curtain will need $1/(1-6) * 100 = 20$.

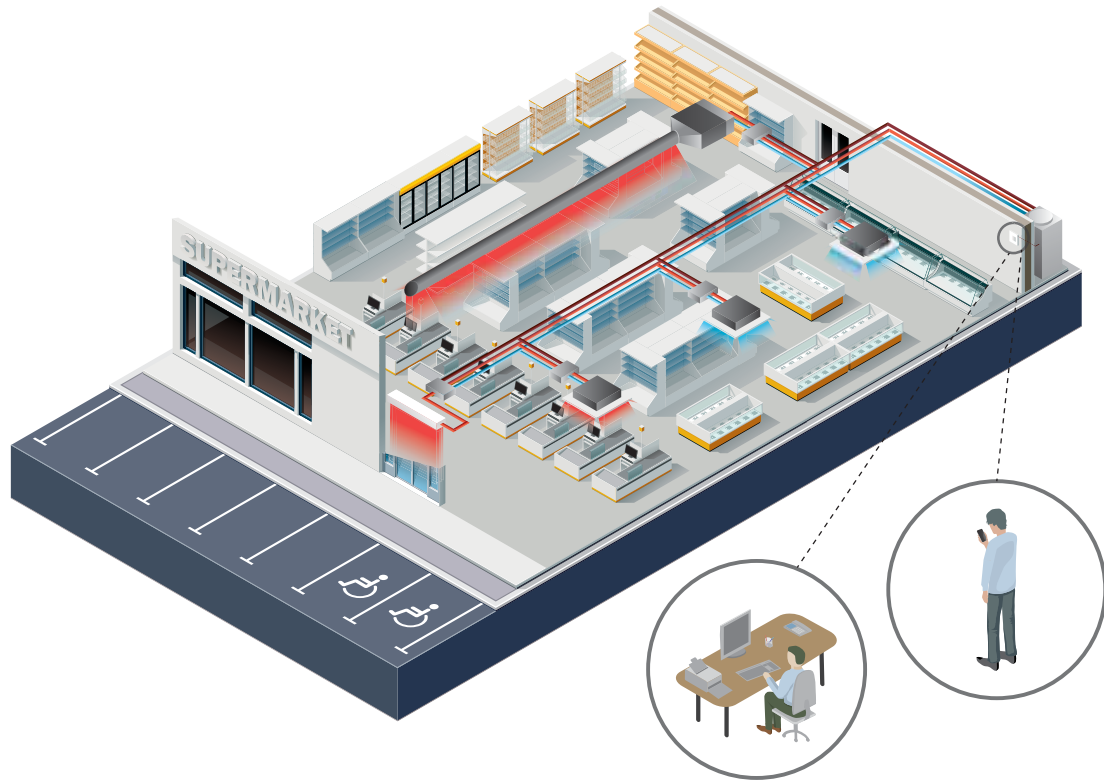

Intelligent Operation

Our air curtains combine air flow and heating / cooling technology to ensure optimum comfort and energy efficiency whilst also creating an effective barrier between indoor and outdoor environments. Design and installation is key to achieving the correct height / temperature settings to achieve optimum performance. Our air curtains are designed to answer the demands of the retail, commercial and industrial markets.

Internet Control

An app added to your tablet or smartphone or via the Internet allows you to control and manage the system remotely. There is also the option to integrate into existing BMS systems by using other Panasonic interfaces.

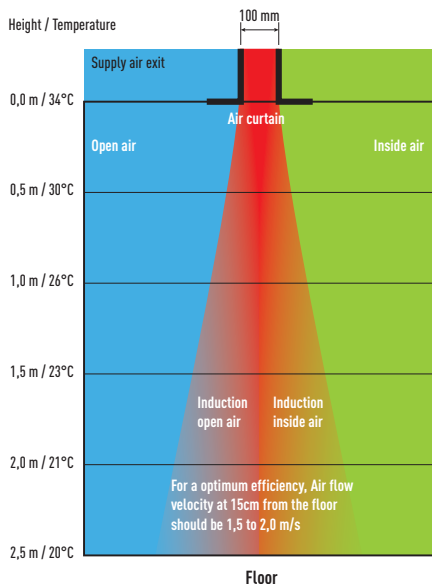

Optimised air flow velocity

1. Energy losses, no air curtain installed
2. Too low velocity air curtain – Air Curtain not efficient
3. Optimum results with the Tekadoor Air Curtain connected to Panasonic VRF
4. Too high velocity air curtain – considerable turbulence, energy lost to the outside, Air Curtain not efficient

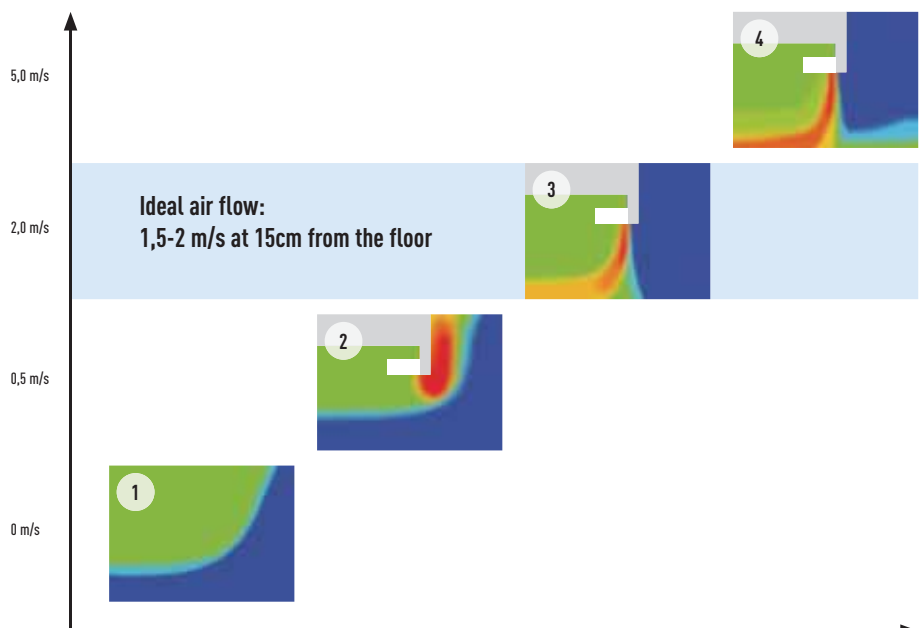

How does it work?

Stale air from the room is taken in and ejected near the door. This creates a 'roll of air' that shields the door area, mixing with the colder incoming air. It then turns away from the door, back into the room and toward the intake screen, where it is partly drawn in again. This flow of air helps to create a barrier for heat loss yet at the same time refreshes room air.

AIR CURTAIN WITH DX COIL

High efficiency Air curtain connected to your VRF installation. EC Fan motor for a smooth operation and efficient performance.

2 types of Air flow available: Jet-Flow and Standard.

2015 Fan Standard available today.

Easy Cleaning and Servicing.

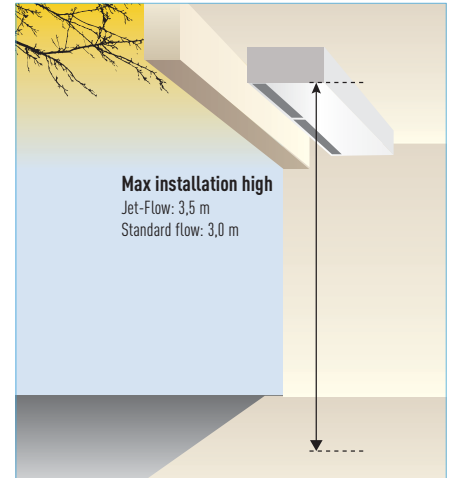

HP			4 HP	6 HP	8 HP	14 HP	4 HP	8 HP
Air Curtain			PAW-10EAIRC-MJ	PAW-15EAIRC-MJ	PAW-20EAIRC-MJ	PAW-25EAIRC-MJ	PAW-10EAIRC-MS	PAW-20EAIRC-MS
Air flow type			Jet-flow					
Air Flow Length (A)		m	1.0	1.5	2.0	2.5	1.0	2.0
Air volume	High	m ² /h	1,800	2,700	3,600	4,500	1,800	2,700
	Medium	m ² /h	1,500	2,300	3,000	3,800	1,500	2,300
	Low	m ² /h	1,200	1,900	2,500	3,100	1,200	1,900
Cooling capacity nominal ²		kW	9.2	17.5	23.1	24.4	9.2	17.5
Heating capacity nominal		kW	11.4	25.0	31.5	31.5	11.4	31.5
Heating capacity with air in 20°C, air out 40°C		kW	11.9	17.9	23.9	29.9	11.9	17.9
Heating capacity with air in 20°C, air out 35°C		kW	8.9	13.4	17.9	22.4	8.9	13.4
Heating capacity with air in 20°C, air out 30°C		kW	5.9	8.9	11.9	14.9	5.9	8.9
Max installation height	Good condition	m	3.5	3.5	3.5	3.5	3	3
	Normal condition	m	3.1	3.1	3.1	3.1	2.7	2.7
	Bad condition	m	2.7	2.7	2.7	2.7	2.4	2.4
Refrigerant			R410A	R410A	R410A	R410A	R410A	R410A
Hot gas temperature		°C	70	70	70	70	70	70
Condensing temperature		°C	50	50	50	50	50	50
Subcooling		K	5	5	5	5	5	5
Pressure		bar	45	45	45	45	45	45
Liquid pipe		Inch (mm)	3/8 (9.52)	3/8 (9.52)	3/8 (9.52)	3/8 (9.52)	3/8 (9.52)	3/8 (9.52)
Gas pipe		Inch (mm)	5/8 (15.88)	3/4 (19.05)	7/8 (22.22)	7/8 (22.22)	5/8 (15.88)	7/8 (22.22)
Fan			230V / 50Hz / 1 / N / PE	230V / 50Hz / 1 / N / PE	230V / 50Hz / 1 / N / PE	230V / 50Hz / 1 / N / PE	230V / 50Hz / 1 / N / PE	230V / 50Hz / 1 / N / PE
Fan type			EC	EC	EC	EC	EC	EC
Currency	High	A	2.1	2.8	4.2	4.9	2.1	4.2
	Med	A	0.8	1.1	1.6	1.9	0.8	1.6
	Low	A	0.3	0.4	0.6	0.7	0.3	0.6
Electrical Consumption	High	kW	0.44	0.59	0.89	1.03	0.44	0.89
	Med	kW	0.17	0.23	0.34	0.4	0.17	0.34
	Low	kW	0.06	0.08	0.12	0.14	0.06	0.12
Protecting Fuse		A	M16A	M16A	M16A	M16A	M16A	M16A
Noise		dB(A)	40-55	40-56	40-57	40-58	40-55	40-57
Dimensions	W x H x D	mm	1,210 x 260 x 590	1,710 x 260 x 590	2,210 x 260 x 590	2,710 x 260 x 590	1,210 x 260 x 490	2,210 x 260 x 490
Weight		kg	70	100	138	160	60	128

Mini ECOi with air out 40°C	U-4LE1E5/8 ¹	U-6LE1E5/8 ¹	—	—	U-4LE1E5/8 ¹	U-6LE1E5/8 ¹
Mini ECOi with air out 35°C	U-4LE1E5/8 ¹	U-4LE1E5/8 ¹	U-6LE1E5/8 ¹	—	U-4LE1E5/8 ¹	U-4LE1E5/8 ¹
Mini ECOi with air out 30°C	U-4LE1E5/8 ¹	U-4LE1E5/8 ¹	U-4LE1E5/8 ¹	U-5LE1E5/8 ¹	U-4LE1E5/8 ¹	U-4LE1E5/8 ¹
ECOi with air out 40°C	All models	All models	All models	All models without 8HP	All models	All models
ECOi with air out 30°C or 35°C	All models	All models	All models	All models	All models	All models
GHP all temperatures	All models	All models	All models	All models	All models	All models

1) or bigger size.

All combinations under rated conditions: Heating Outdoor +7°C DB/+6°C WB Indoor +20°C DB. In case of lower outdoor temperatures a higher capacity outdoor unit model may be necessary.

2) Rated Conditions Cooling Outdoor +35°C DB Indoor +27°C DB/+19°C WB, Discharge temperature ³ 16°C.



Technical focus

- Save up to 40% Energy Costs by use of the integrated EC Fan Technology (Higher efficiency than conventional AC fan, softstart and longer motor duration)
- 3 Lengths of Air Curtains Jet-Flow, from 1.0 to 2.0 m and 2 lengths of Air Curtains Standard, 1.0 and 2.0 m
- Installation Height up to 3.5 m (Jet-Flow) and 3.0 m (Standard)
- Outlet Grilles can be adjusted in five positions, to suite different Indoor and installation requirements (Jet-Flow)
- Control with Panasonic Remote Control systems (optional)
- Direct integration to BMS by optional Panasonic Interfaces
- Drain included for cooling operation

Features

COMFORT

- Easy redirection of Air-Flow by means of manual deflector (Jet-Flow)

EASE OF USE

- Speed selector (high and low) on the unit itself

EASY INSTALLATION AND MAINTENANCE

- Easy installation
- Compact dimensions improve installation and positioning (Jet-Flow)
- Easy cleaning of grid without opening of the unit

Jet-flow dimensions

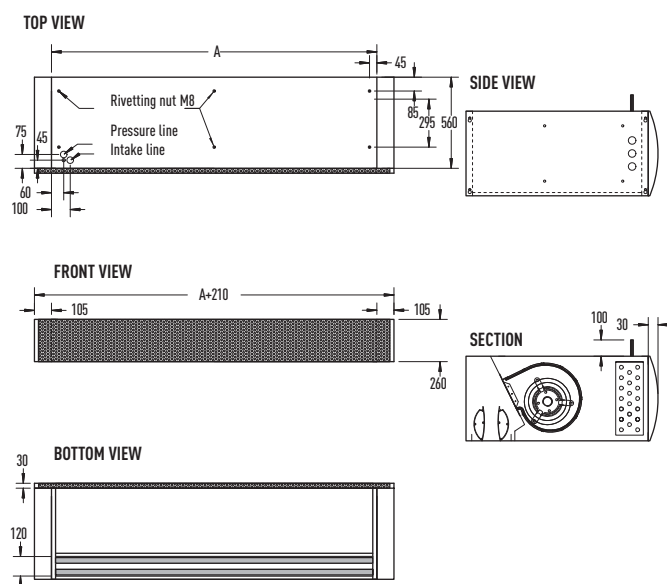

	PAW-10PAIRC-MJ	PAW-15PAIRC-MJ	PAW-20PAIRC-MJ	PAW-25EAIRC-MJ
A	1,000	1,500	2,000	2,500

Standard dimensions

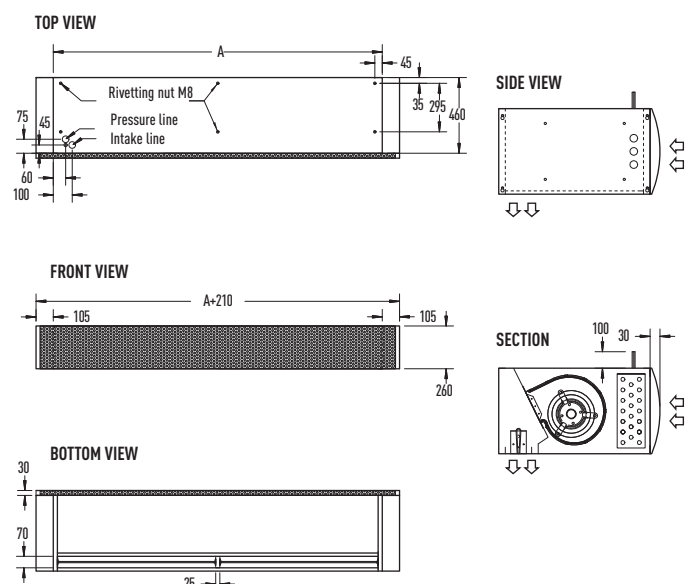

	PAW-10PAIRC-MS	PAW-20PAIRC-MS
A	1,000	2,000



Energy Recovery Ventilator

Suppresses indoor temperature changes while providing fresh air

Energy efficiency and ecology

Energy consumption is dramatically reduced by using a counter-flow heat-exchange element. Air conditioning load is reduced by approximately 20%, resulting in significant energy savings.

Heat exchanger characteristics

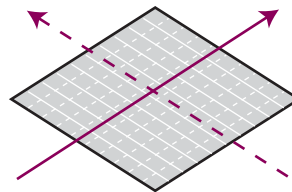

Former (cross-flow element)

20% energy savings

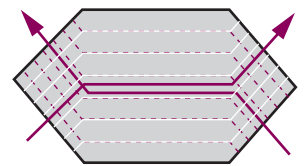

New (counter-flow element)

Heat exchange ventilation and normal ventilation

Heat exchange ventilation

When a room is cooled or heated, the exhausted cooling / heating energy is recovered by heat-exchange ventilation.

Normal ventilation

This is used in the spring and autumn, when rooms are not cooled or heated, that is, when there is little difference between the indoor and outdoor air conditions. In addition, at night during the hot season, when the outside air temperature drops the outside air is drawn inside without heat exchange, alleviating the load on the air conditioning equipment.

The heat exchanger is made up of a membrane manufactured from a special material covered in resin for optimal heat transmission. The nylon/polyester fibre filter offers high dust retention capacity. We have also redesigned the air ducts to obtain a long-lasting heat exchange system which does not need periodic cleaning.

Adopts a highly efficient counter-flow heat exchange element

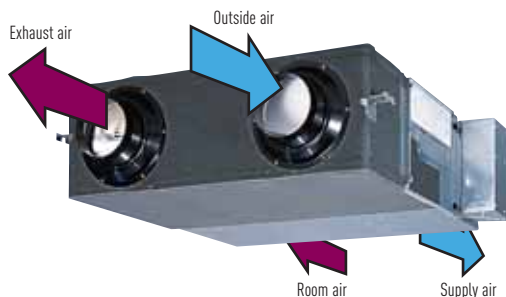

Heat exchanger

With the cross-flow element, air moves in a straight line across the element. With the counter-flow element, air flows through the element for a longer time (longer distance), so the heat-exchange effect remains unchanged even if the element is made thinner.

More Comfort

Quiet operation

Low noise operation results in noticeably quieter units. All models with capacities below 500 m³/h run at noise levels below 32 dB (High setting) and even our largest 1,000 m³/h-capacity model runs at only 37.5 dB (High setting).

Long heat-exchange element service life

Cleaning reduced due to the special material heat exchanger. The nylon/polyester fibre filter offers high dust retention capacity.

Changes in airflow resistance based on number of years in service

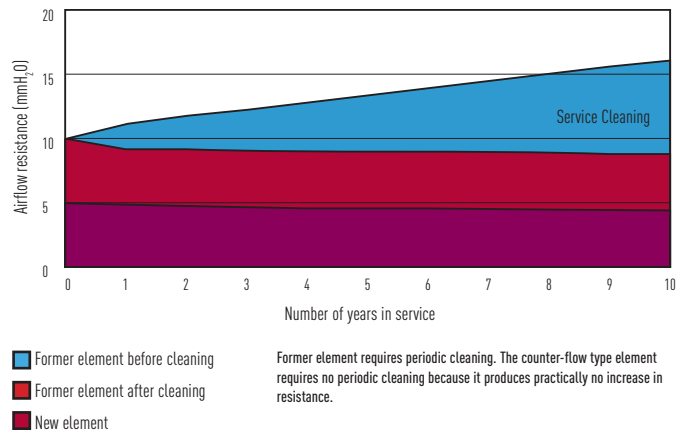

Easy Installation and Maintenance

Slim shape and easier installation

Counter-flow heat exchange element used for reduced noise and slimmer, more compact body shape.

270mm Height: FY-250ZDY8 // FY-350ZDY8 // FY-500ZDY8

388mm Height: FY-650ZDY8 // FY-800ZDY8 // FY-01KZDY8A

Reverse mountable direct air supply / exhaust system

Adoption of straight air supply / exhaust system: Duct design is simplified because the air supply / exhaust ducts are straight.

Since each unit can be mounted in reverse position, only one inspection hole is needed for two units: Two units can share one inspection hole so duct work is easier and more flexible.

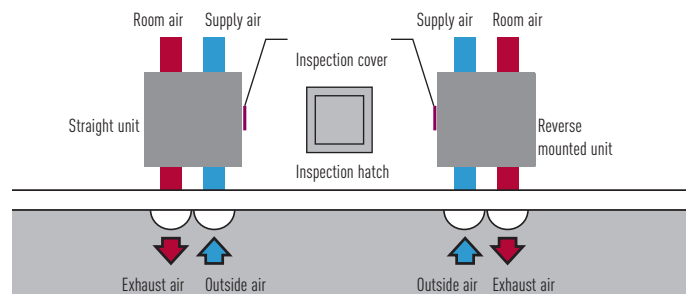

Balanced Ventilation

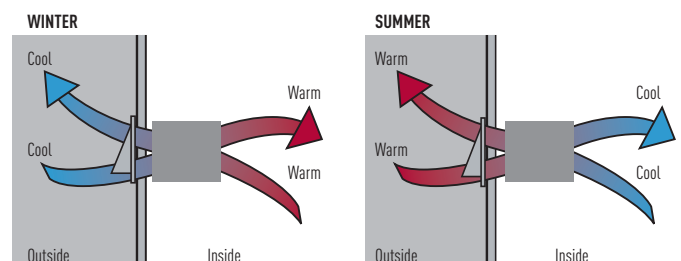

ENERGY RECOVERY VENTILATION SYSTEM

Recovers up to 77% of the heat in the outgoing air, for an ecological and energy efficient building.



Rated flow rate	250 m³/h			350 m³/h			500 m³/h			650 m³/h			800 m³/h			1000 m³/h			
Models	FY-250ZDY8			FY-350ZDY8			FY-500ZDY8			FY-650ZDY8			FY-800ZDY8			FY-01KZDY8A			
Power Source	220 - 240 V - 50 Hz			220 - 240 V - 50 Hz			220 - 240 V - 50 Hz			220-240 V - 50 Hz			220 - 240 V - 50 Hz			220 - 240 V - 50 Hz			
Heat Exchange Ventilation	E - High High Low			E - High High Low			E - High High Low			E-High High Low			E - High High Low			E - High High Low			
	Input	W	112 - 128	108 - 123	87 - 96	182 - 190	178 - 185	175 - 168	263 - 289	204 - 225	165 - 185	326-347	269-295	200-210	387 - 418	360 - 378	293 - 295	437 - 464	416 - 432
Air Volume	m³/h	250	250	190	350	350	240	500	500	440	650	650	460	800	800	630	1,000	1,000	700
External Static Pressure	Pa	105	95	45	140	60	45	120	60	35	65	40	40	140	110	55	105	80	75
Noise	dB	30.0 - 31.5	29.5 - 30.5	23.5 - 26.5	32.5 - 33.0	30.5 - 31.0	22.5 - 25.5	36.5 - 37.5	34.5 - 35.5	31.0 - 32.5	36.5-37.5	34.5-35.5	30.0-32.0	37.0 - 37.5	36.5 - 37.0	33.5 - 34.5	37.5 - 38.5	37.0 - 37.5	33.5 - 34.5
Temp. Exchange Efficiency	%	75	75	77	75	75	78	75	75	76	75	75	79	75	75	76	75	75	79
Normal Ventilation	E - High High Low			E - High High Low			E - High High Low			E-High High Low			E - High High Low			E - High High Low			
	Input	W	112 - 128	108 - 123	87 - 96	182 - 190	178 - 185	175 - 168	263 - 289	204 - 225	165 - 185	326-347	269-295	200-210	387 - 418	360 - 378	293 - 295	437 - 464	416 - 432
Air Volume	m³/h	250	250	190	350	350	240	500	500	440	650	650	460	800	800	630	1,000	1,000	700
External Static Pressure	Pa	105	95	45	140	60	45	120	60	35	65	40	40	140	110	55	105	80	75
Noise	dB	30.0 - 31.5	29.5 - 30.5	23.5 - 26.5	32.5 - 33.0	30.5 - 31.0	22.5 - 25.5	37.5 - 38.5	37.0 - 38.0	31.0 - 32.5	36.5-37.5	35.0-35.5	30.0-32.0	37.0 - 37.5	36.5 - 37.0	33.5 - 34.5	39.5 - 40.5	39.0 - 39.5	35.5 - 36.5
Temp. Exchange Efficiency	%	-	-	-	-	-	-	-	-	-	-	-	-	-	-	-	-	-	-
Dimensions (W x D x H)	mm	882 x 599 x 270			1,050 x 804 x 317			1,090 x 904 x 317			1,204 x 884 x 388			1,322 x 884 x 388			1,322 x 1,134 x 388		
Weight	kg	29			49			57			68			71			83		

This noise of the product is the value which was measured at the acoustic room. Actually, in the established condition, that undergo influence by the echoing of the room and so that become bigger than the display numerical value. The input, the current and the exchange efficiency are values at the time of the mentioned air volume. The noise level shall be measured 1.5m below the centre of the unit. The temperature exchange efficiency averages that of when cooling and when heating.

Typical system linked to a cassette type air conditioner

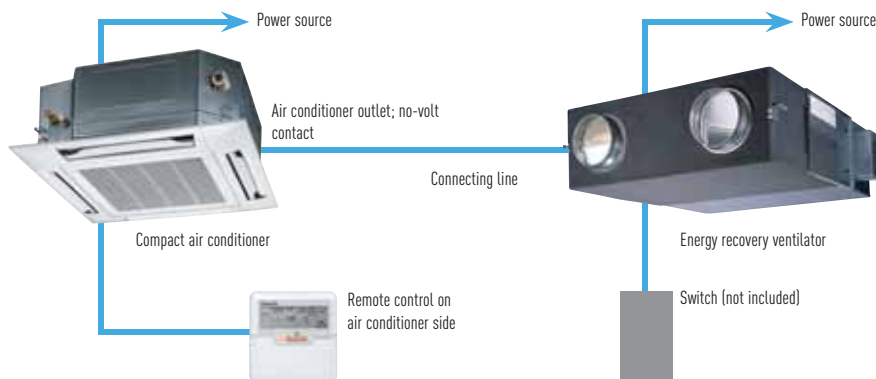

Use conditions

Outdoor air conditions

Temperature range: -10°C - 40°C
Relative humidity: 85% or less

Indoor air conditions

Temperature range: -10°C - 40°C
Relative humidity: 85% or less

Requirements for installation

Use is to be avoided in refrigerated chambers or other places where the temperature may undergo significant fluctuations, even when the temperature range is acceptable.



Technical focus

- High energy saving, up to 20%
- Counter Cross Flow technology for better efficiency
- Long life element core
- Easy installation and 20% less thickness
- Easy connection to air conditioning units
- Super quiet units

Features

HEALTHY AIR

- The filter guarantees healthier air

ENERGY EFFICIENCY AND ECOLOGY

- Up to 20% energy saving in the installation
- Recovers up to 77% of the heat in the outgoing air

COMFORT

- Cleaning reduced due to the revolutionary structure of the exchanger (recommended every 6 months)
- Ideal for indoor spaces without windows

EASY INSTALLATION AND MAINTENANCE

- 6 models for easier selection
- Reduced system height (270 mm and 388 mm)
- Side opening for cleaning (inspection of filter, motor and other parts)
- Installation can be reversed to share an inspection opening between 2 machines
- Easy connection to the air conditioning unit (without additional elements)
- Installation in false ceilings
- Units operate at 220 - 240 V
- High static pressure for easier installation

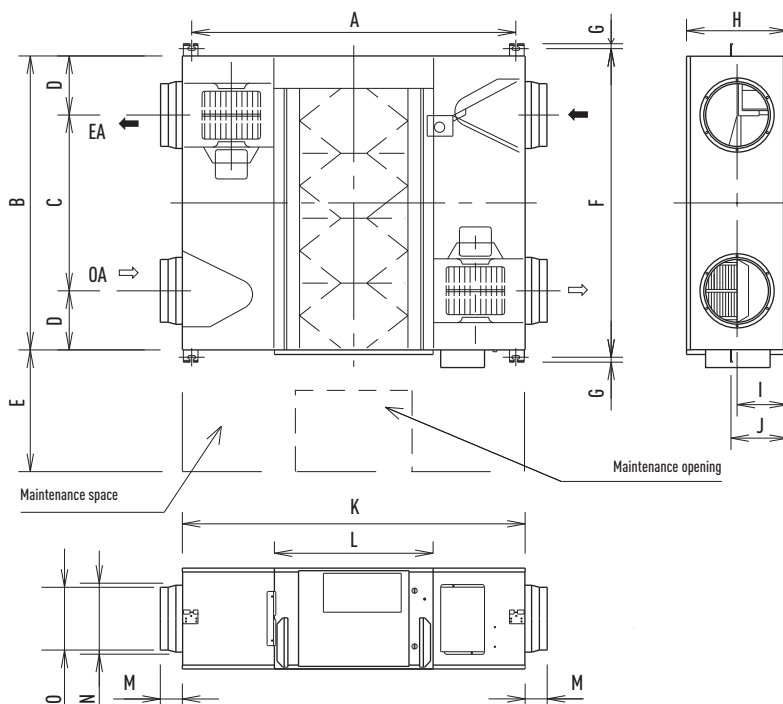

	FY-250ZDY8	FY-350ZDY8	FY-500ZDY8	FY-650ZDY8	FY-800ZDY8	FY-01KZDY8A
A	810	810	890	1,132	1,250	1,250
B	599	804	904	884	884	1,134
C	315	480	500	620	428	678
D	142	162	202	132	228	228
E	600	600	600	600	600	600
F	655	860	960	940	940	1,190
G	19	19	19	19	19	19
H	270	317	317	388	288	388
I	135	145	145	194	194	194
J	159	159	159	218	218	218
K	882	882	962	1,204	1,322	1,322
L	414	414	414	560	612	612
M	95	95	107	70	85	85
N	219	219	246	210	258	258
O	144	144	194	194	242	242

Possible to use on R22 pipings
R22 RENEWAL

R22 Renewal

An important drive to further reduce the potential damage to our ozone

Unique R22 Renewal from Panasonic: Fast, easy to install and cost effective

- Panasonic refrigerant oil that doesn't react to the most common oil types used in air-conditioning systems. This make the mix of oil does not damage the units. The installations is easier
- All Panasonic ECOi units can be install in R22 pipings, no specific models are available
- Up to 33 Bar! When there is any doubt about the strength of the piping, the maximum working pressure can be reduced to 33 bar with a setting in the software of the outdoor unit

Required Parameter setting for the renewal system			
Model type	Item code	Setting data	Remarks
3-Pipe VRF System	4B	Set to 0001 = Renewal system operation (Factory set = 0000)	Setting only for Master unit
2-Pipe VRF System (ME1E81 series only)	4B	Set to 0000 = Renewal system operation (Factory set = 0002)	Setting only for Master unit
Mini VRF System	4B	Set to -001 = Renewal system operation (Factory set = 0000)	

Depending on the outdoor unit type to be used for renewal installation, one additional setting has to be changed properly before starting a test-run operation of the new system. The renewal system operating condition (design pressure: 3.3MPa) will be set by this parameter change. Refer to the following table and be sure to change the parameter accordingly. A maintenance remote controller for the outdoor unit is required to change the relevant parameter. (See the maintenance remote controller's instruction manual for further details on connections and usage methods.)

Why renewal?

It is often said that legislation is ruling our lives but sometimes it is there to help save lives. R22 phase out can be described as one of these and from Jan 1st 2010 the use of Virgin (new) R22 refrigerant was banned within the European Community.

Panasonic are doing our part

We at Panasonic are also doing our part – recognising that all finances are under pressure at the moment. Panasonic have developed a clean and cost effective solution to enable this latest legislation to be introduced with as minimum an effect on businesses and cash reserves as possible. The Panasonic renewal system allows good quality existing R22 pipe work to be re-used whilst installing new high efficiency R410A systems. By bringing a simple solution to the problem Panasonic can renew all Split Systems and VRF systems; and depending upon certain restrictions we don't even limit the manufactures equipment we are replacing.

By installing a new high efficiency Panasonic R410A system you can benefit from around 30% running cost saving compared to the R22 system. Yes...

1. Check the capacity of the system you wish to replace
 2. Select from the Panasonic range the best system to replace it with
 3. Follow the procedure detailed in the brochure and technical data
- Simple...

R22 - The reduction of Chlorine critical for a cleaner future.

Panasonic's Renewal system allows a completely new VRF system, indoor and outdoor units, to be installed using the existing systems pipe work. Panasonic's advanced technology enables the system to work with previously installed pipe work by managing the working pressure within the system down to R22 (33 bar) levels, this ensures the system works safely and efficiently without loss of capacity.

The new equipment can offer increased COP/EER by using state of the art inverter compressor and heat exchanger technology.

Having contacted your Panasonic supplier regarding pipe work restrictions and gained approval to use the Panasonic Renewal System there are three main tests that have to be carried out to ensure that the system can be used effectively.

Firstly a thorough inspection of the pipe work must be carried out and any damage must be repaired.

Secondly an oil test has to be carried out to ensure that the system has not been subject to a compressor burnout during its lifetime, Lastly a VRF Renewal Kit (CZ-SLK2) has to be installed within the pipe work to ensure that the system is cleaned of any remnants of oil.

VRF Renewal Kit (CZ-SLK2) and Sight Glass

The following shows an overview of the VRF Renewal Kit (CZ-SLK2) that is required when existing tubing is reused. If the exact tube length and tube size of the existing tubing are uncertain, attach a sight glass in accordance with the figure below. It will be used for checking the amount of additional refrigerant charge.

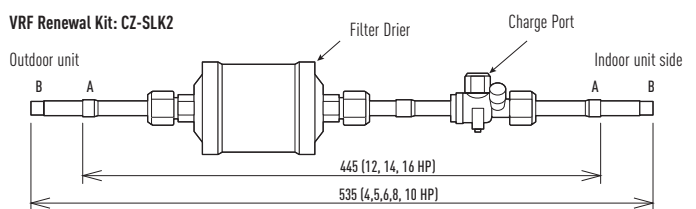

Connecting tube dimensions (Inch (mm)): A Ø 1/2 (12.7) (12, 14, 16 HP) - B Ø 3/8 (9.52) (4, 5, 6, 8, 10 HP)

Note: If the tube size does not match that of the existing tubing, use a reducer (field supply) to adjust the tube diameter.

Sight glass (field supply)

If the exact tube length and tube size of the existing tubing are uncertain, attach a sight glass to the liquid tubing, and use it to check whether there is an appropriate amount of additional refrigerant charge.

Attaching the Filter Drier Kit and sight glass

- To adjust the limited pressure level into 3.3 MPa only, special setting is necessary at site.
- A filter Drier shall be attached to the liquid tubing of each outdoor unit.
- High-Pressure switches shall be attached to both the liquid and the gas tubings of each outdoor unit.
- There is no need to remove the Filter Drier Kit after a test run is performed because normal operation continues while it is attached (High pressure switches need to be replaced by 3.3 MPa type (field supplied)).
- When attaching the Filter Drier Kit, care shall be taken with regards to the installation location and orientation of the filter drier and ball valve. If a mistake is made, the refrigerant in the system needs to be recovered when the filter drier is replaced, which will make maintenance difficult.

- Thermal insulation material (field supply: heat resistance of 80°C or higher and thickness of 10mm or greater) shall be applied to the Filter Drier Kit.
- The filter drier of the Filter Drier Kit may need to be replaced depending on the condition of the existing unit. Use a Danfoss DMB 164 as the replacement filter drier (field supply).

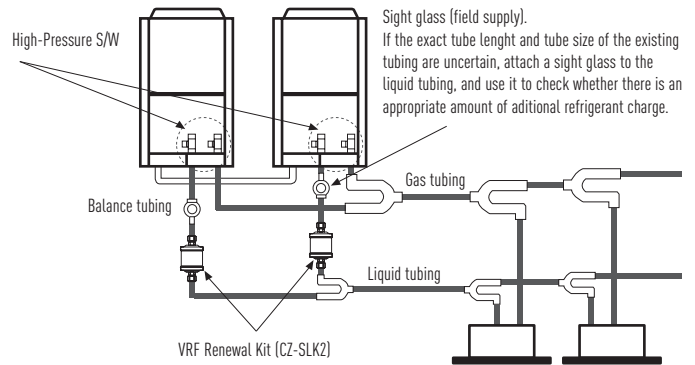

Procedure for VRF Renewal

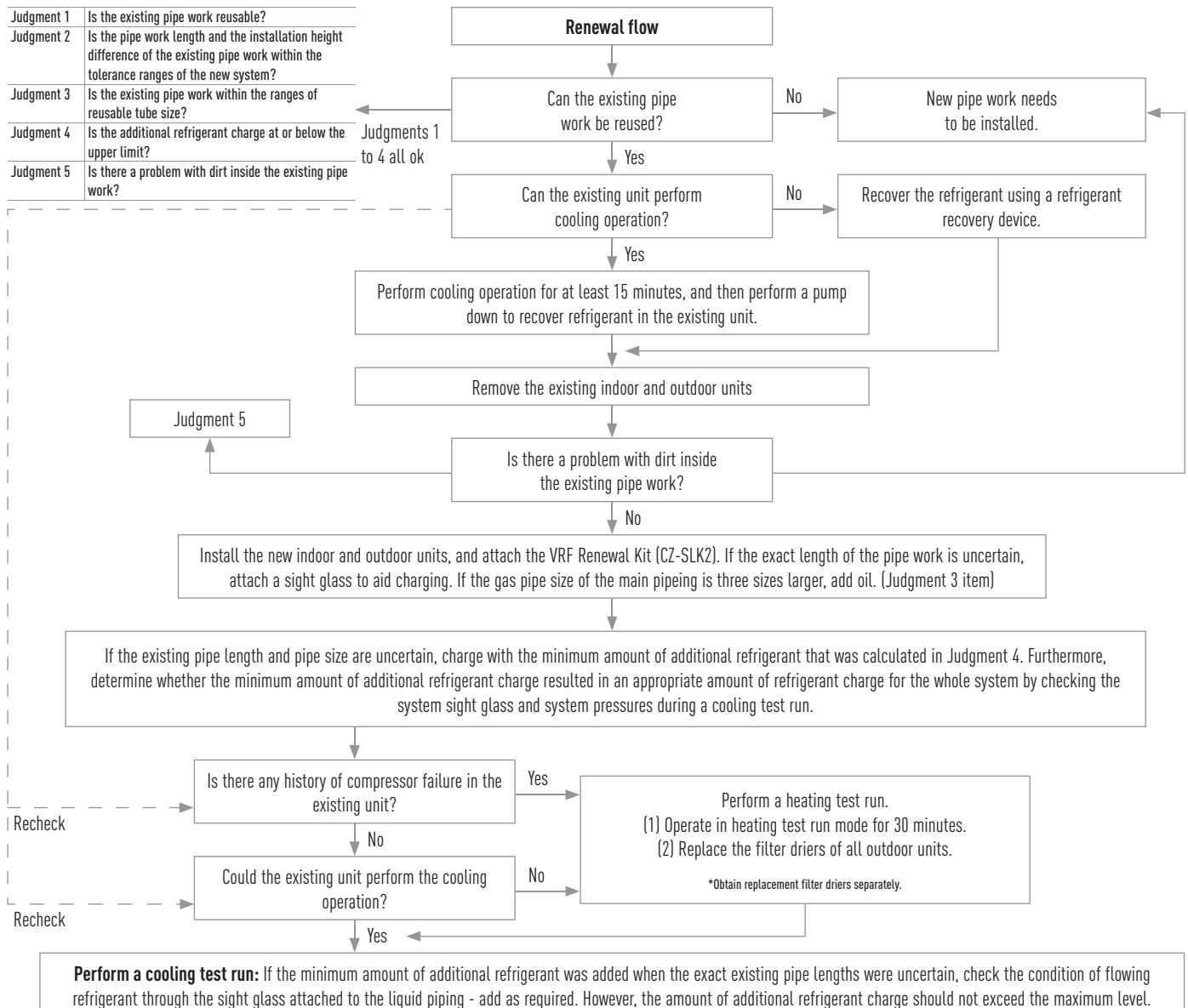

Dimensions and Tube Sizes of Branches and Headers for 2-Pipe ECOi 6N Systems

Optional Distribution Joint Kits

See the installation instructions packaged with the distribution joint kit for the installation procedure.

	Cooling capacity after distribution	Remarks
Outdoor unit side	68.0 kW or less	CZ-P680PH2BM
	From 68.0 kW to 168.0 kW	CZ-P1350PH2BM
Indoor unit side	22.4 kW or less	CZ-P224BK2BM
	From 22.4 kW to 68.0 kW	CZ-P680BK2BM
	From 68.0 kW 168.0 kW or less	CZ-P1350BK2BM

Tubeing size (with thermal insulation)

CZ-P680PH2BM

For outdoor unit side (Capacity after distribution joint is 68.0 kW or less).

Gas tubing

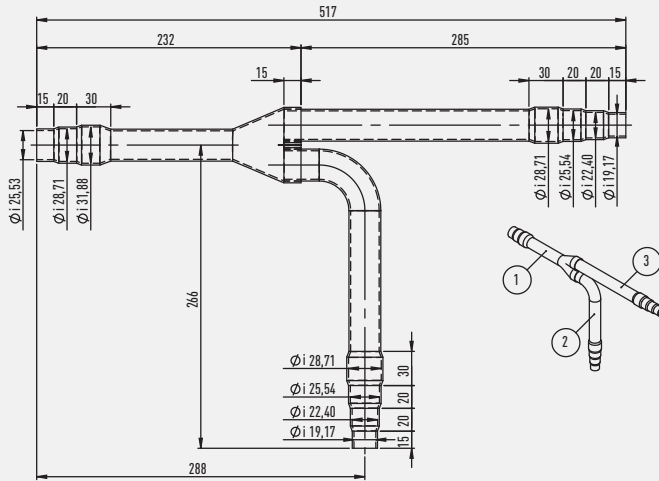

Liquid tubing

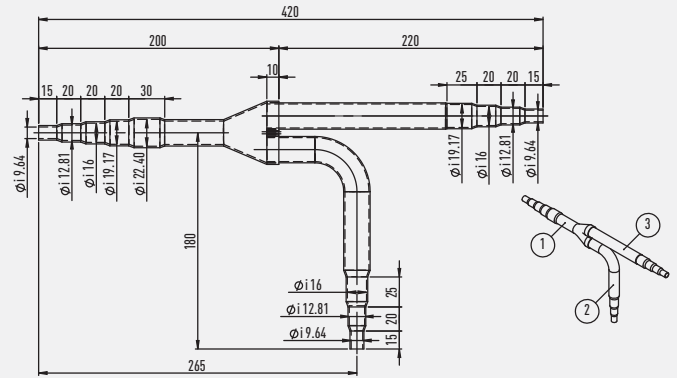

Unit:mm

CZ-P1350PH2BM

For outdoor unit side (Capacity after distribution joint is greater than 68.0 kW and no more than 168.0 kW).

Gas tubing

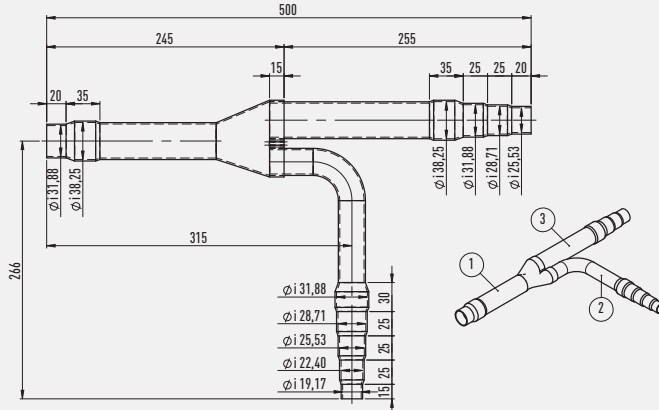

Liquid tubing

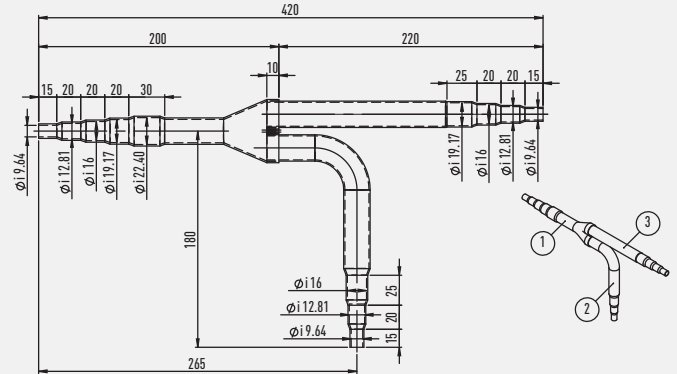

Unit:mm

CZ-P224BK2BM

For indoor unit side (Capacity after distribution joint is 22.4 kW or less).

Gas tubing

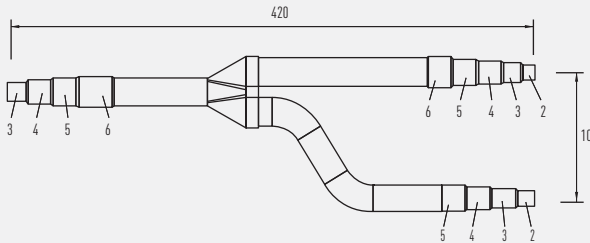

Liquid tubing

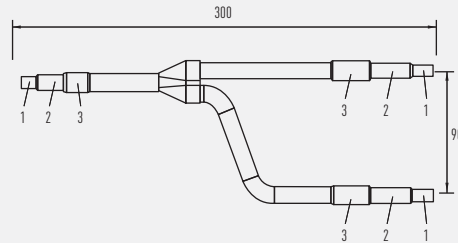

Unit:mm

CZ-P680BK2BM

For indoor unit side (Capacity after distribution joint is greater than 22.4 kW and no more than 68.0 kW).

Gas tubing

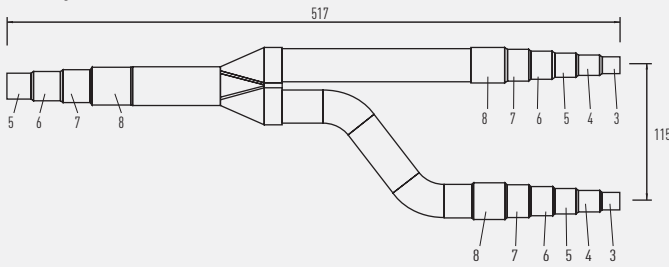

Liquid tubing

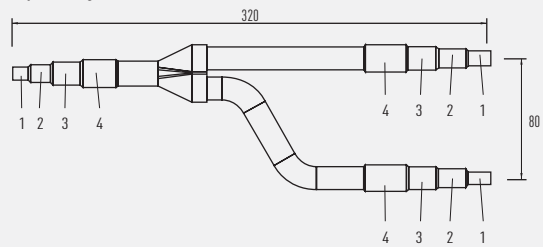

Unit:mm

CZ-P1350BK2BM

For indoor unit side (Capacity after distribution joint is greater than 68.0 kW and no more than 168.0 kW).

Gas tubing

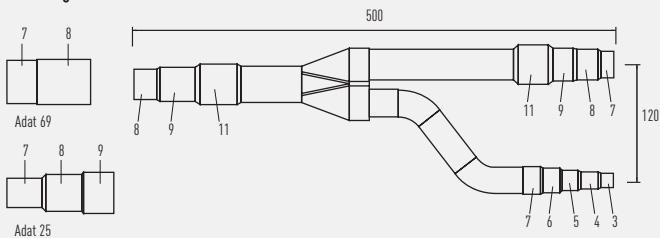

Liquid tubing

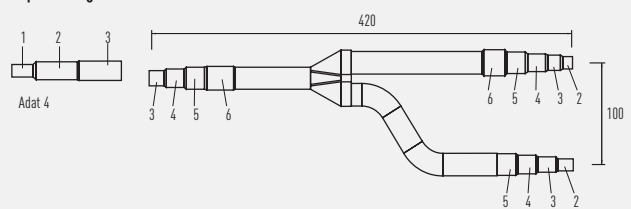

Unit:mm

Diameters		Diameters		Diameters	
1	6.35 mm 1/4"	6	22.40 mm 7/8"	11	38.10 mm 1 1/2"
2	9.52 mm 3/8"	7	25.40 mm 1"	12	41.28 mm 1 5/8"
3	12.70 mm 1/2"	8	28.57 mm 1 1/8"	13	44.45 mm 1 3/4"
4	15.88 mm 5/8"	9	31.75 mm 1 1/4"	14	50.80 mm 2"
5	19.05 mm 3/4"	10	34.92 mm 1 3/8"		

Dimensions and Tube Sizes of Branches and Headers for 3-Pipe ECOi 6N Systems (MF2)

Optional Distribution Joint Kits

See the installation instructions packaged with the distribution joint kit for the installation procedure.

	Capacity after distribution joint	Remarks
For outdoor unit	68.0 kW or less	CZ-P680PJ2BM
	Greater than 68.0 kW and no more than 135.0 kW	CZ-P1350PJ2BM
For indoor unit	22.4 kW or less	CZ-P224BH2BM
	Greater than 22.4 kW and no more than 68.0 kW	CZ-P680BH2BM
	Greater than 68.0 kW and no more than 135.0 kW	CZ-P1350BH2BM

Tubing size (with thermal insulation)

CZ-P680PJ2BM

For outdoor unit side (Capacity after distribution joint is 68.0 kW or less).

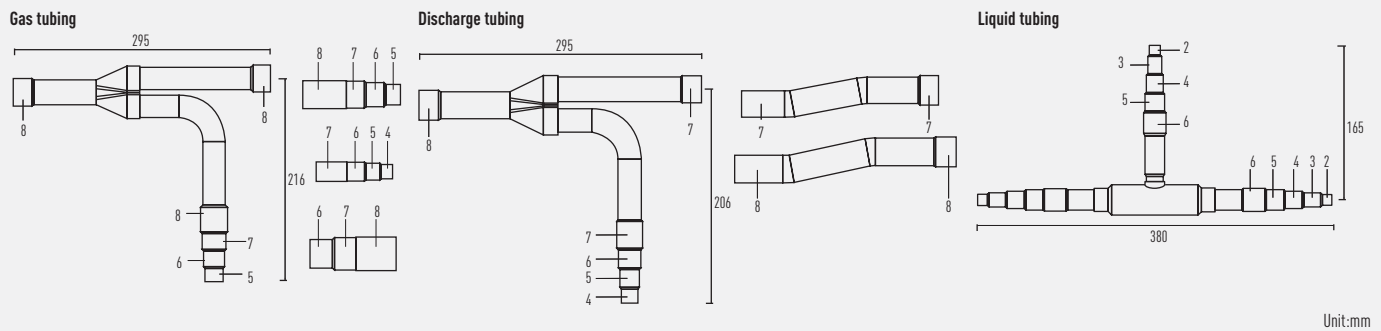

CZ-P1350PJ2BM

For outdoor unit side (Capacity after distribution joint is greater than 68.0 kW and no more than 135.0 kW).

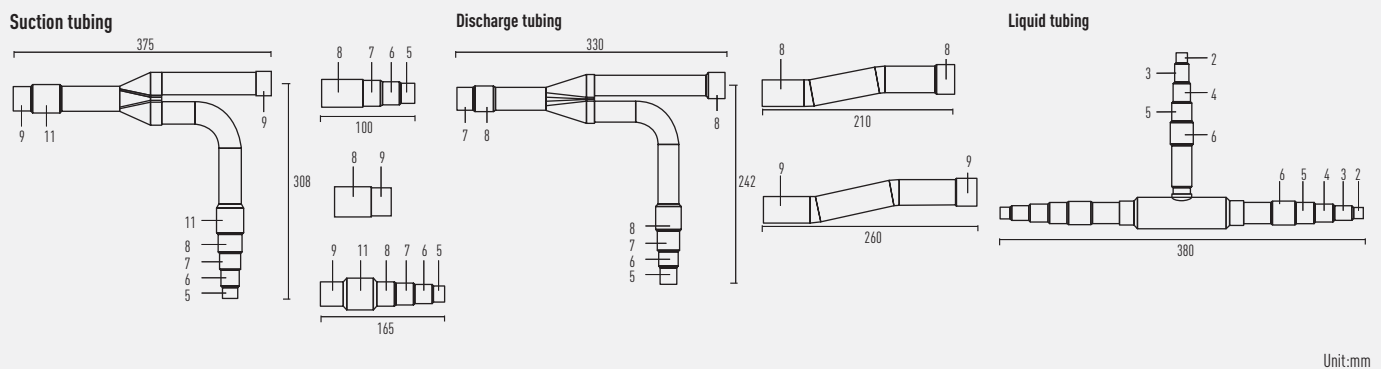

CZ-P224BH2BM

For outdoor unit side (Capacity after distribution joint is 22.4 kW or less).

Suction tubing

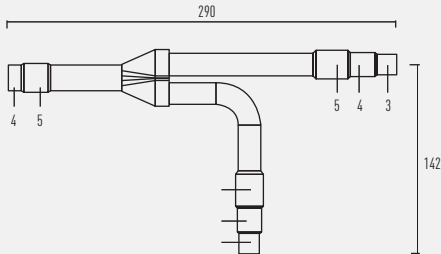

Discharge tubing

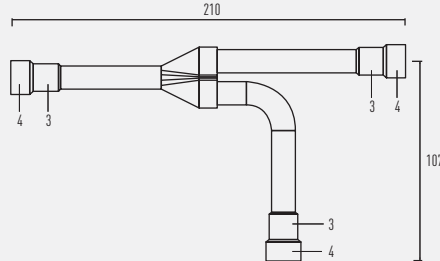

Liquid tubing

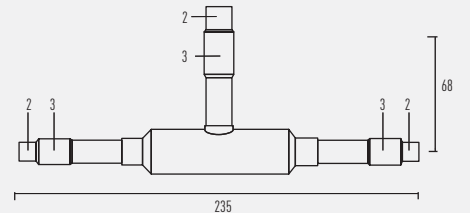

Unit:mm

CZ-P680BH2BM

For outdoor unit side (Capacity after distribution joint is greater than 22.4 kW and no more than 68.0 kW).

Suction tubing

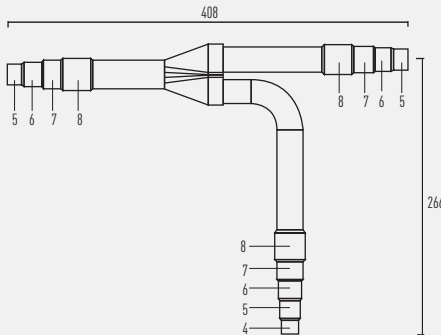

Discharge tubing

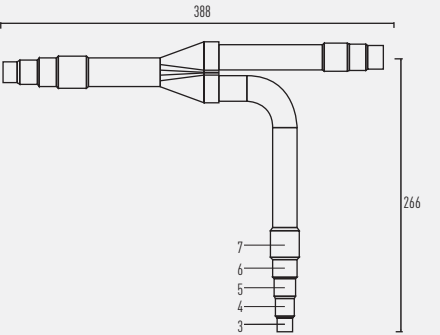

Liquid tubing

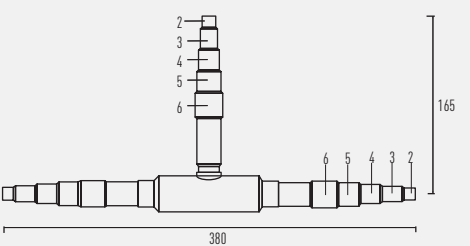

Unit:mm

CZ-P1350BH2BM

For outdoor unit side (Capacity after distribution joint is greater than 68.0 kW and no more than 135.0 kW).

Suction tubing

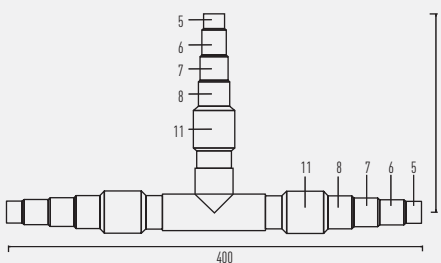

Discharge tubing

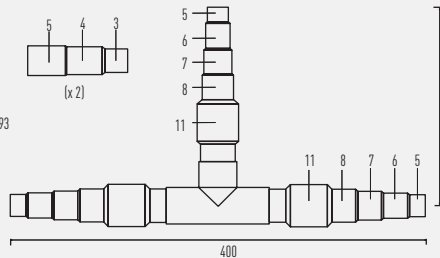

Liquid tubing

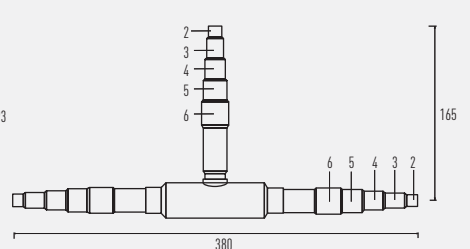

Unit:mm

Diameters		Diameters		Diameters	
1	6.35 mm 1/4"	6	22.40 mm 7/8"	11	38.10 mm 1 1/2"
2	9.52 mm 3/8"	7	25.40 mm 1"	12	41.28 mm 1 5/8"
3	12.70 mm 1/2"	8	28.57 mm 1 1/8"	13	44.45 mm 1 3/4"
4	15.88 mm 5/8"	9	31.75 mm 1 1/4"	14	50.80 mm 2"
5	19.05 mm 3/4"	10	34.92 mm 1 3/8"		

Headers

Header pipe set for ECOi 6N 2-Pipe system

CZ-P4HP4C2BM

Header pipe models for 2-Pipe systems.

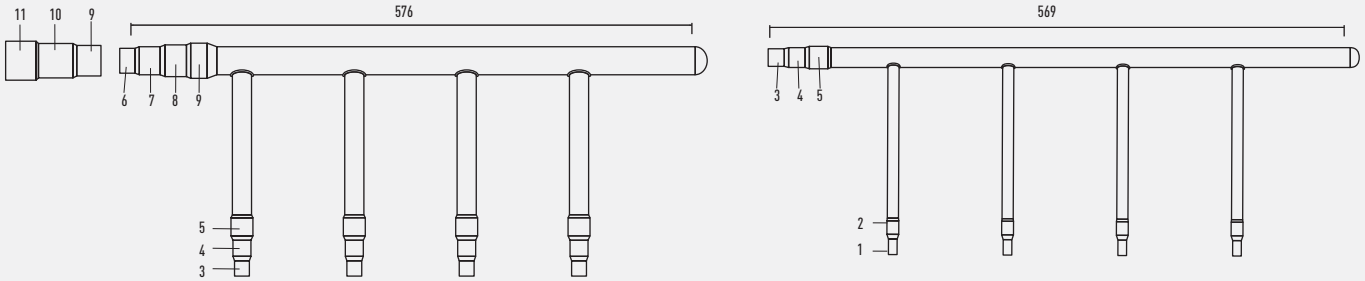

Header pipe set for ECOi 6N 3-Pipe system

CZ-P4HP3C2BM

Header pipe model for 3-Pipe systems.

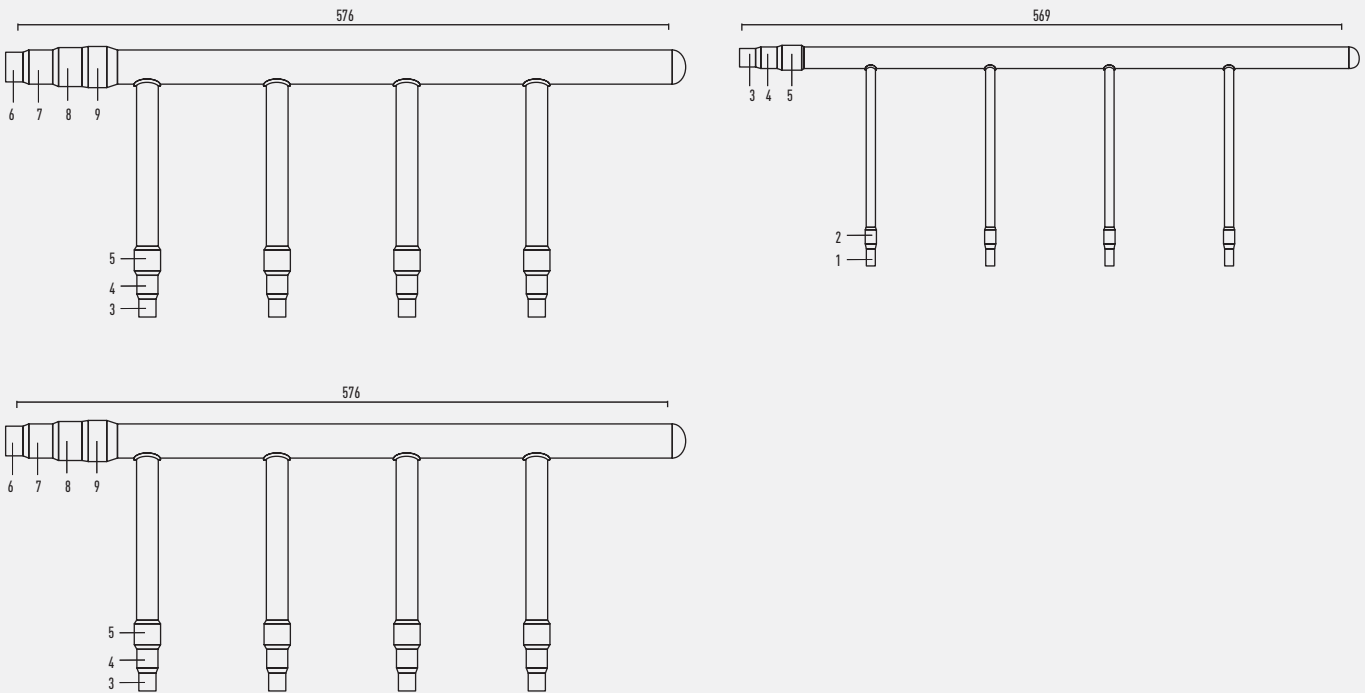

Diameters		Diameters		Diameters	
1	6.35 mm 1/4"	5	19.05 mm 3/4"	9	31.75 mm 1" 1/4
2	9.52 mm 3/8"	6	22.40 mm 7/8"	10	34.92 mm 1" 3/8
3	12.70 mm 1/2"	7	25.40 mm 1"	11	38.10 mm 1" 1/2
4	15.88 mm 5/8"	8	28.57 mm 1" 1/8		

Control equipment external dimensions

Control Systems

Timer remote controller
(CZ-RTC4)

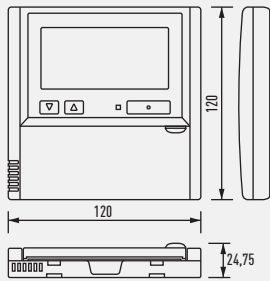

Wireless remote controller

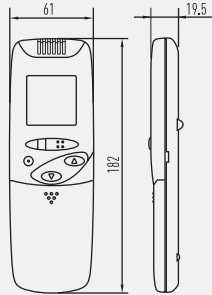

Separate receiver for wireless remote controller

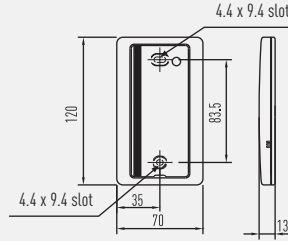

Simplified remote controller
(CZ-RE2C2)
Remote sensor
(CZ-CSRC2)

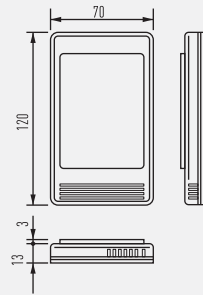

System controller
(CZ-64ESMC2)

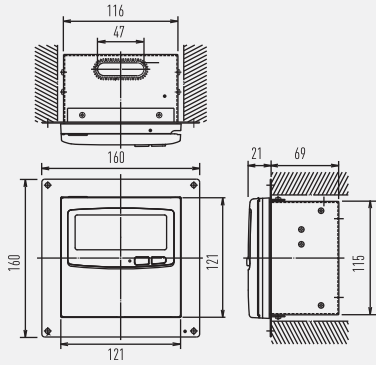

Intelligent controller
(CZ-256ESMC2)

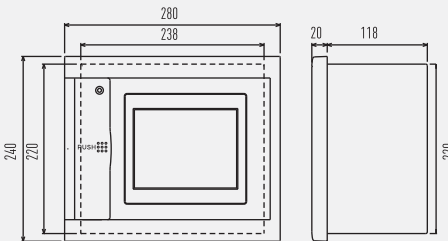

Communication adapter
(CZ-CFUNC2)

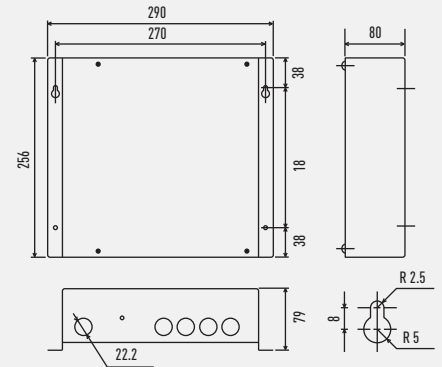

ON/OFF controller
(CZ-ANC2)

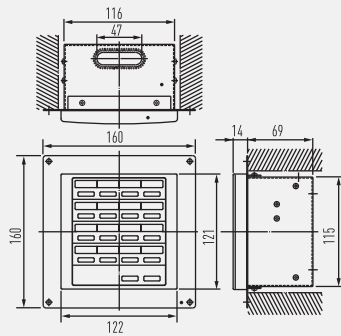

Seri-Para I/O unit for each indoor unit
(CZ-CAPBC2)

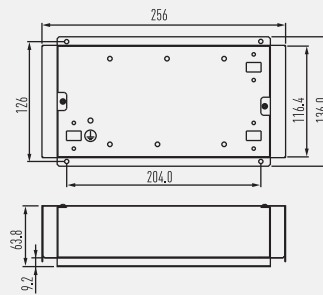

LonWorks interface
(CZ-CLNC2)

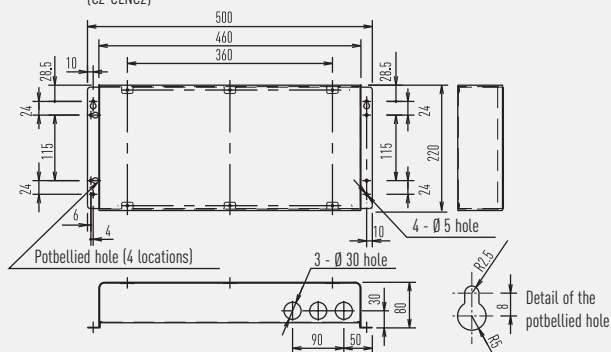

Seri-Para I/O unit for outdoor unit
(CZ-CAPDC2)

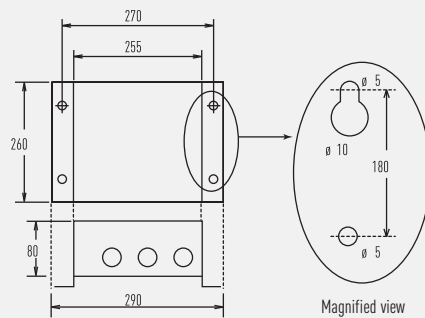

L1 Type // 2 Way Cassette

1	Refrigerant liquid line	Ø 9.52
2	Refrigerant gas line	Ø 15.88
3	Drain connection 25 A	Outer diameter 32mm
4	Power supply entry	

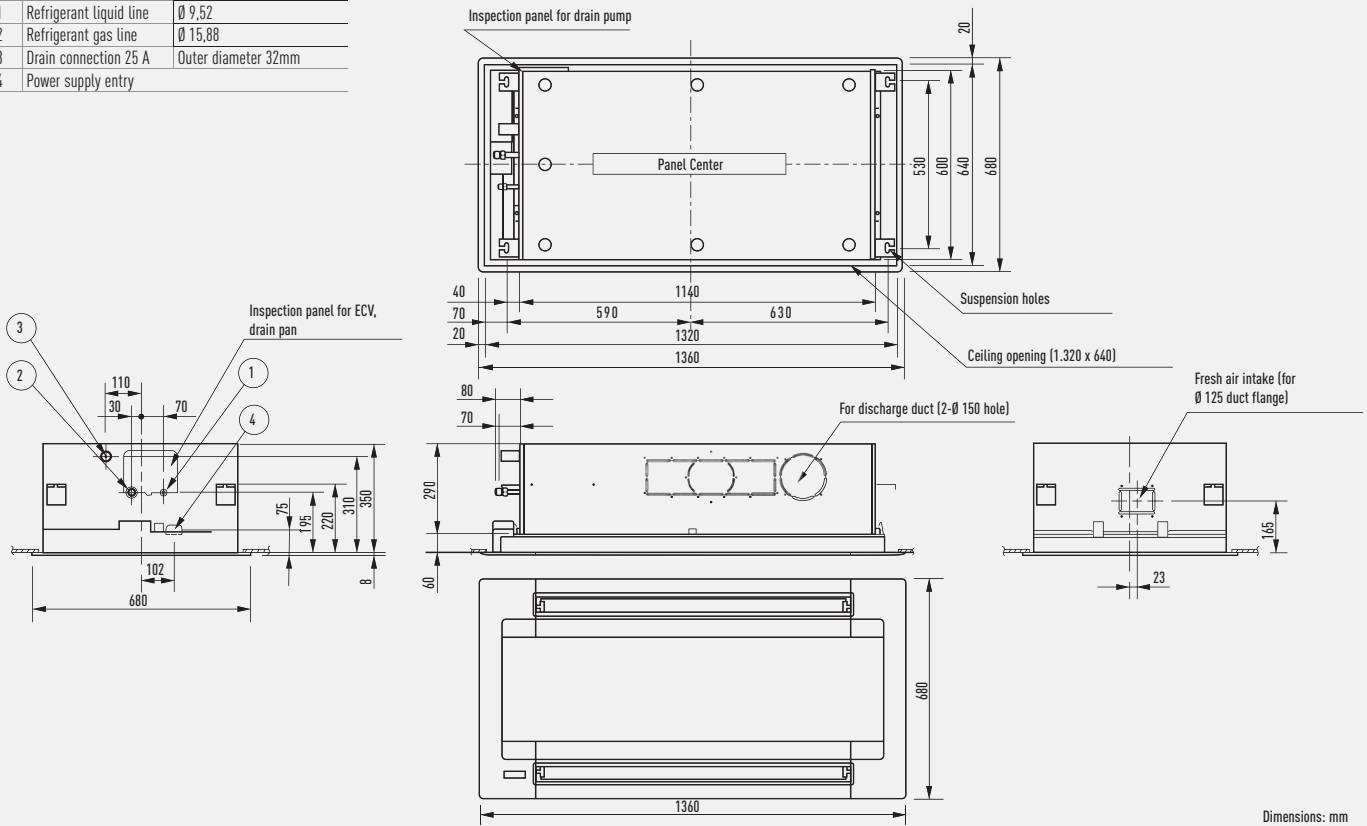

Dimensions: mm

D1 Type // 1 Way Cassette

	28-56	73
1	Air intake grille	
2	Discharge outlet	
3	Ø 6.35 (flared)	Ø 9.52 (flared)
4	Ø 12.7 (flared)	Ø 15.88 (flared)
5	Drain connection VP25 Outer diameter 32	
6	Power supply entry	
7	Discharge duct connection port (for descending ceiling)	
8	Fresh air intake duct connection port Ø 100	
9	Installation port for wireless remote controller receiver	
10	Suspension bolt hole 4-12.30 hole	

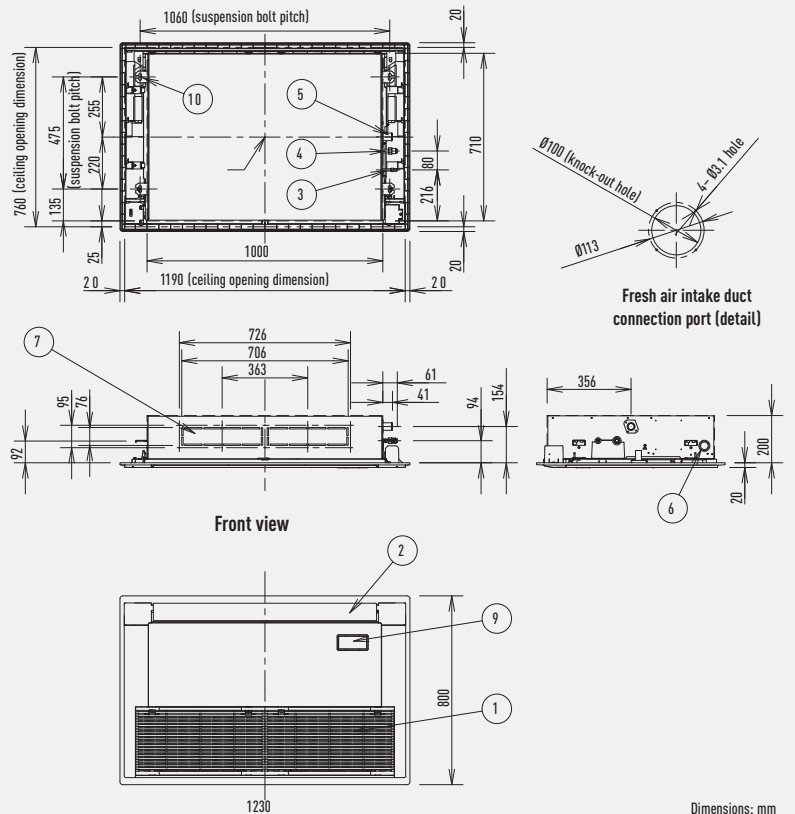

Dimensions: mm

Required space for installation

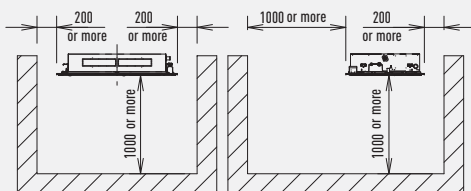

ECOi and ECO G indoor units dimensions

F2 Type // Variable Static Pressure Hide Away

S-15MF2E5A // S-22MF2E5A // S-28MF2E5A // S-36MF2E5A // S-45MF2E5A // S-56MF2E5A

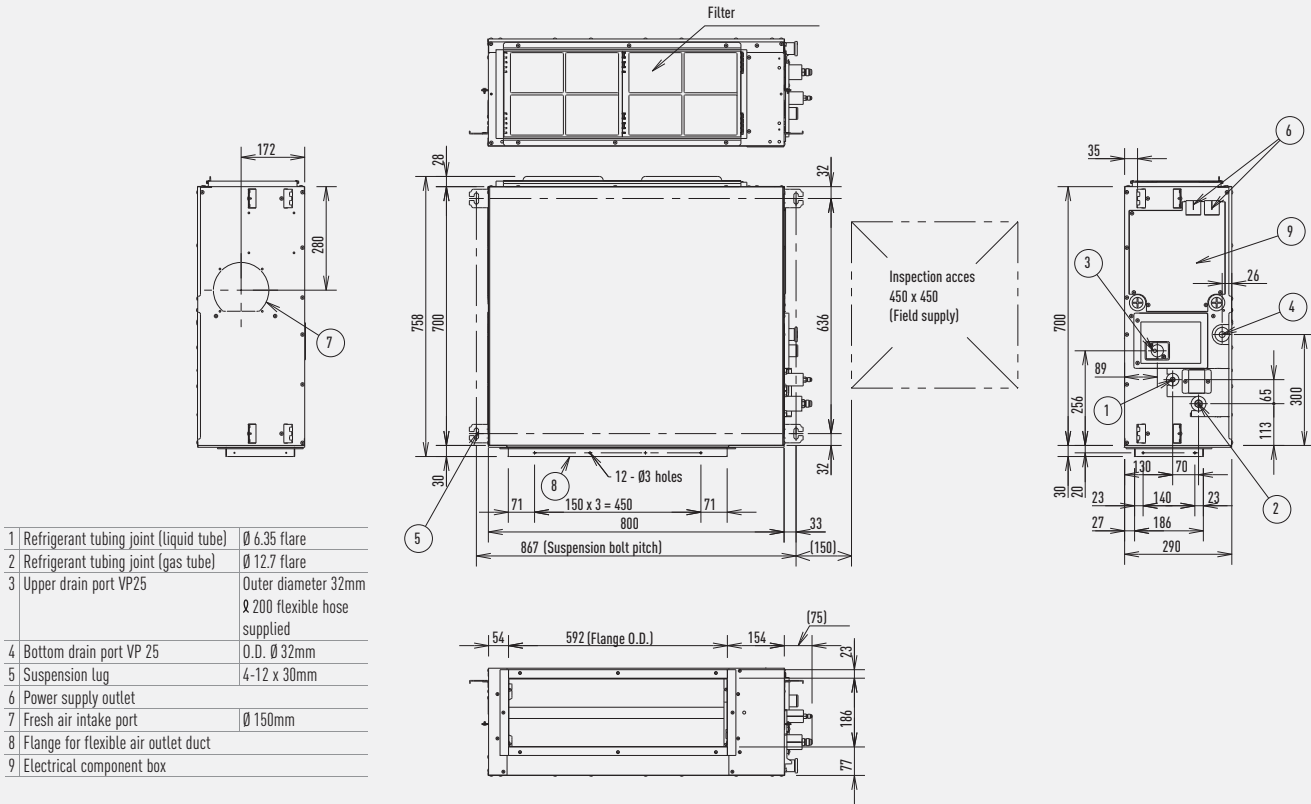

S-60MF2E5A // S-73MF2E5A // S-90MF2E5A

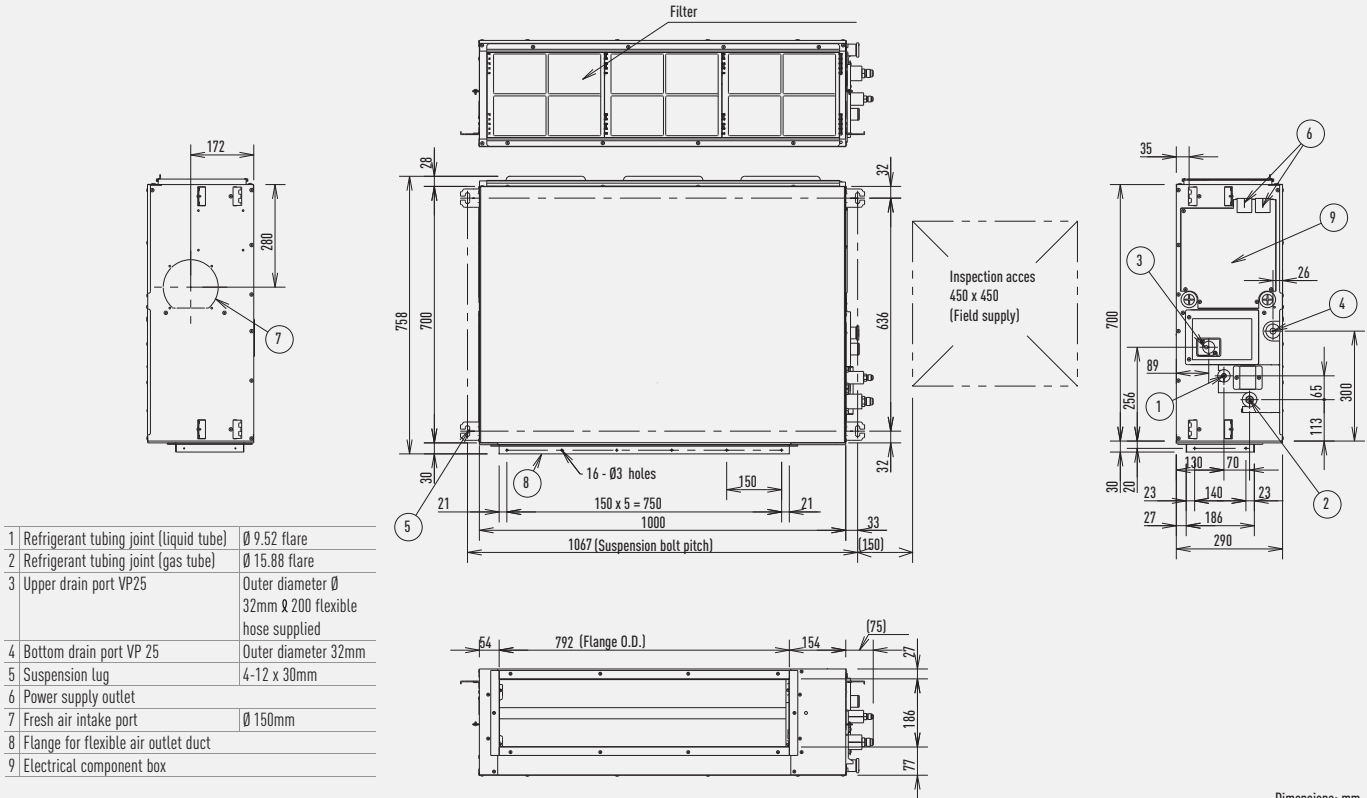

Dimensions: mm

S-106MF2E5A // S-140MF2E5A // S-160MF2E5A

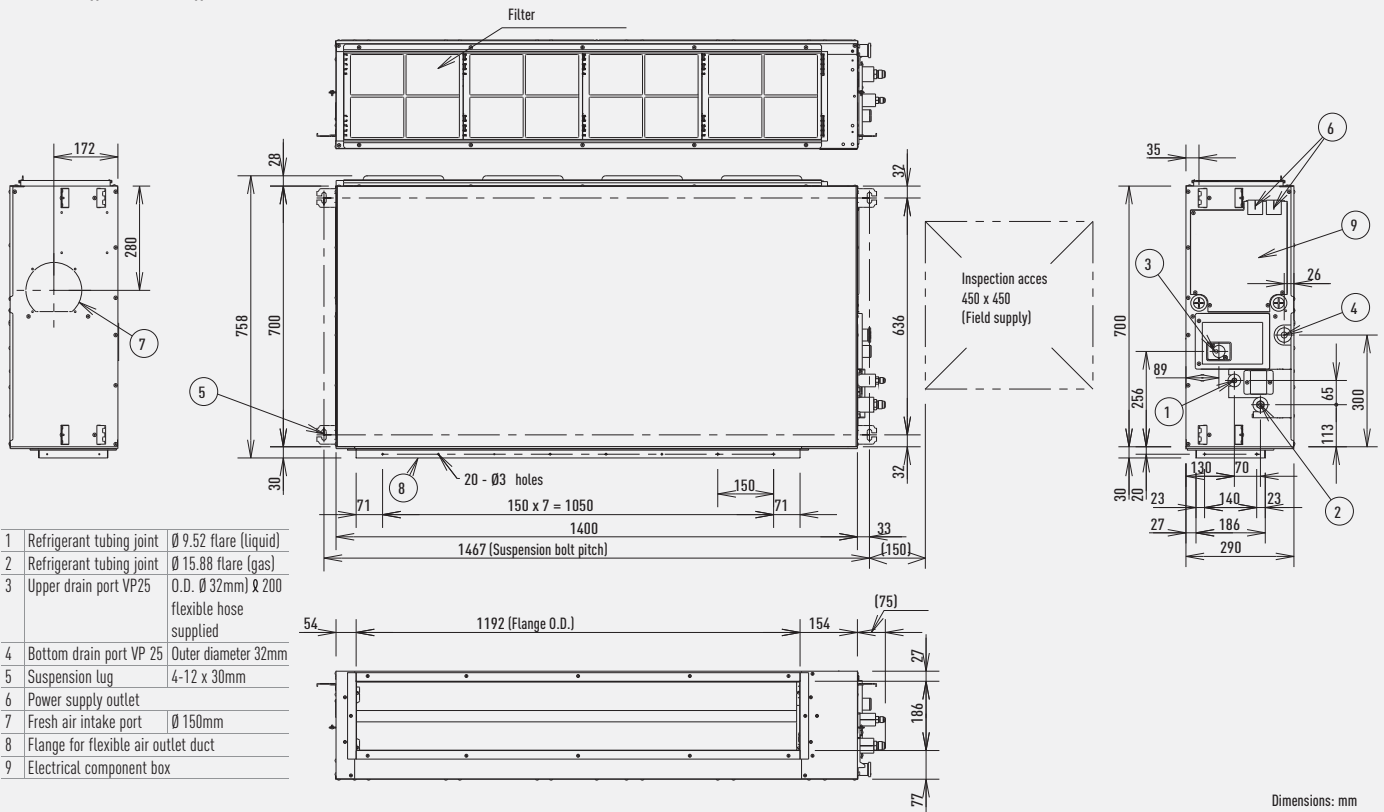

Dimensions: mm

M1 Type // Slim Variable Static Pressure Hide Away

1	Refrigerant tubing joint (narrow tube)	
2	Refrigerant tubing joint (wide tube)	
3	Upper and bottom drain port	Outer diameter 26mm
4	Suspension lug	
5	Power supply outlet	2- Ø 30
6	Flange for air intake duct	
7	PL cover	
8	Electrical component box	
9	Frame filter	
10	Signal output board	ACC-SG-AGB: optional

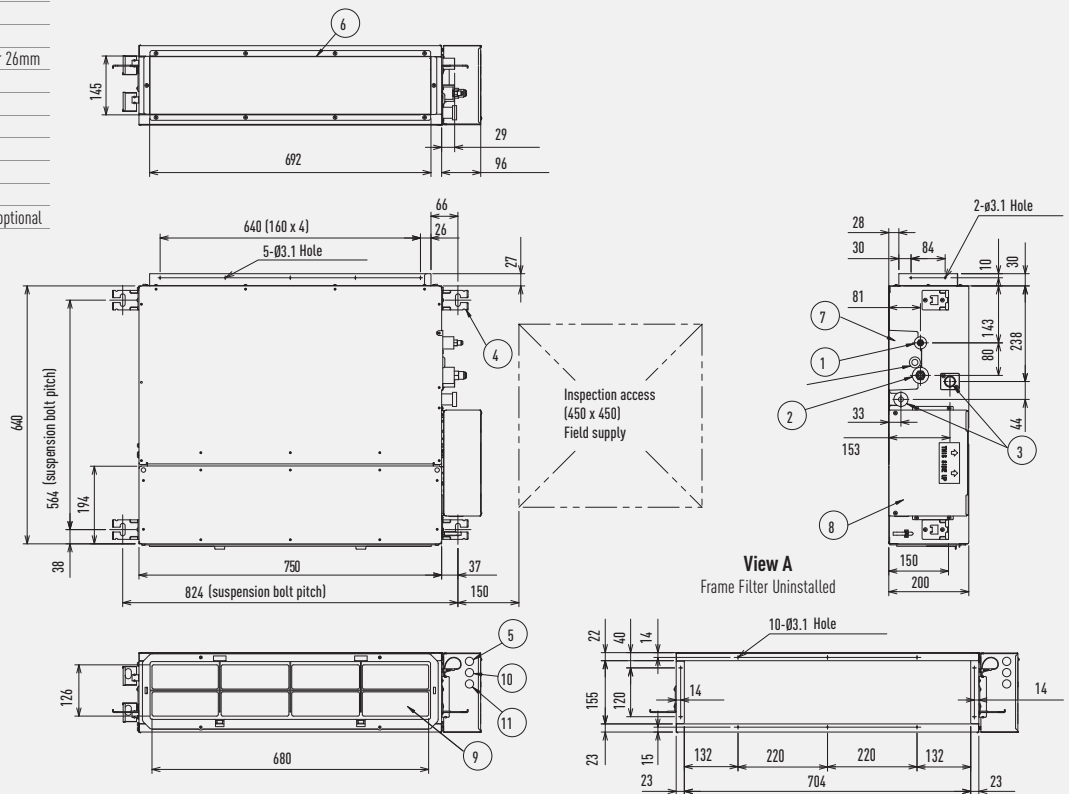

Dimensions: mm

ECOi and ECO G indoor units dimensions

E2 Type // High Static Pressure Hide Away

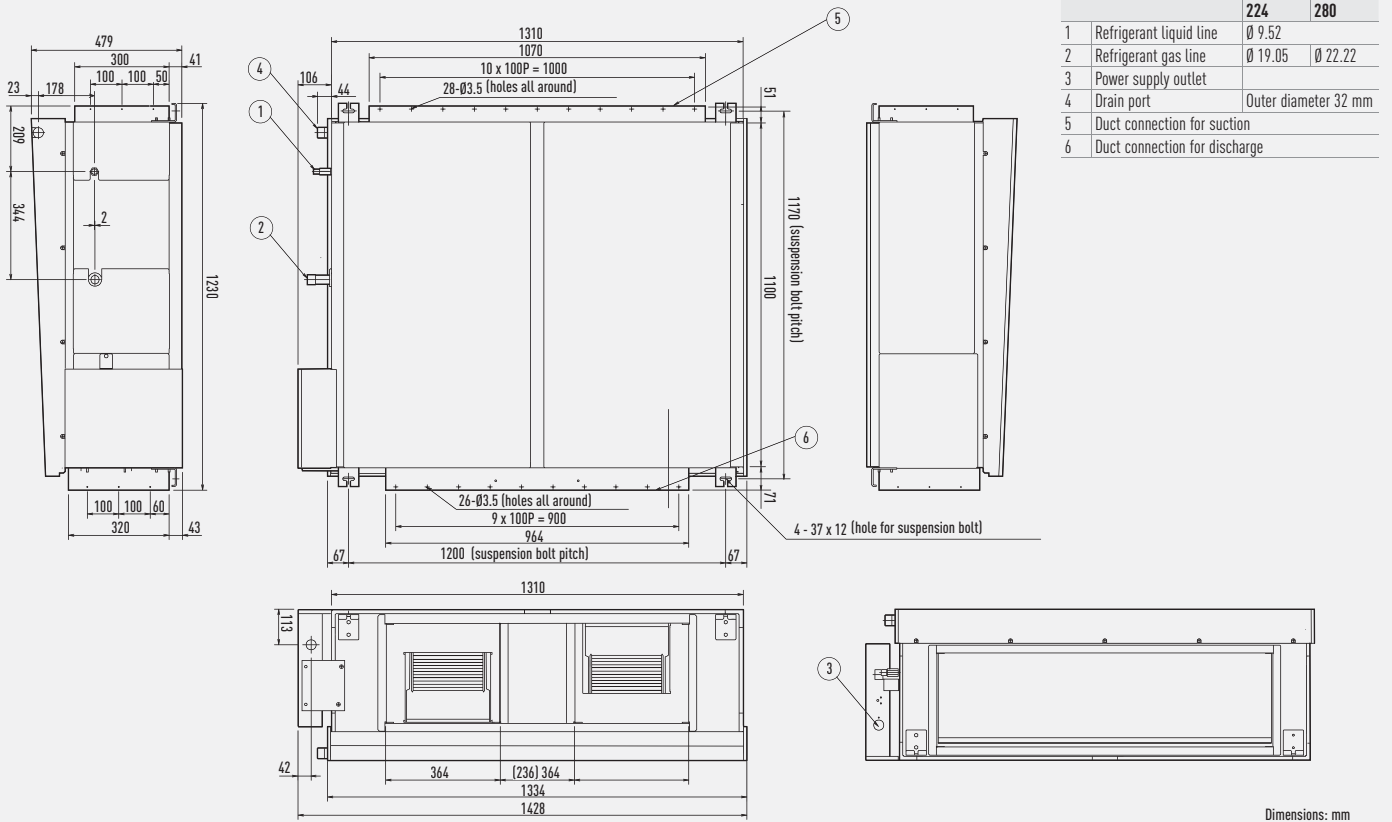

Dimensions: mm

Heat Recovery with DXCoil

	A	A1	A2	B	B1	B2	C	D	D1	Ø d	E
PAW-500ZDX2	1470	1410	1630	997	1053	1112	312	728	497	200	38
PAW-800ZDX2	1822	1752	1986	882	936	994	390	431	431	250	169
PAW-01KZDX2	1822	1752	1986	1132	1186	1244	390	681	532	250	169

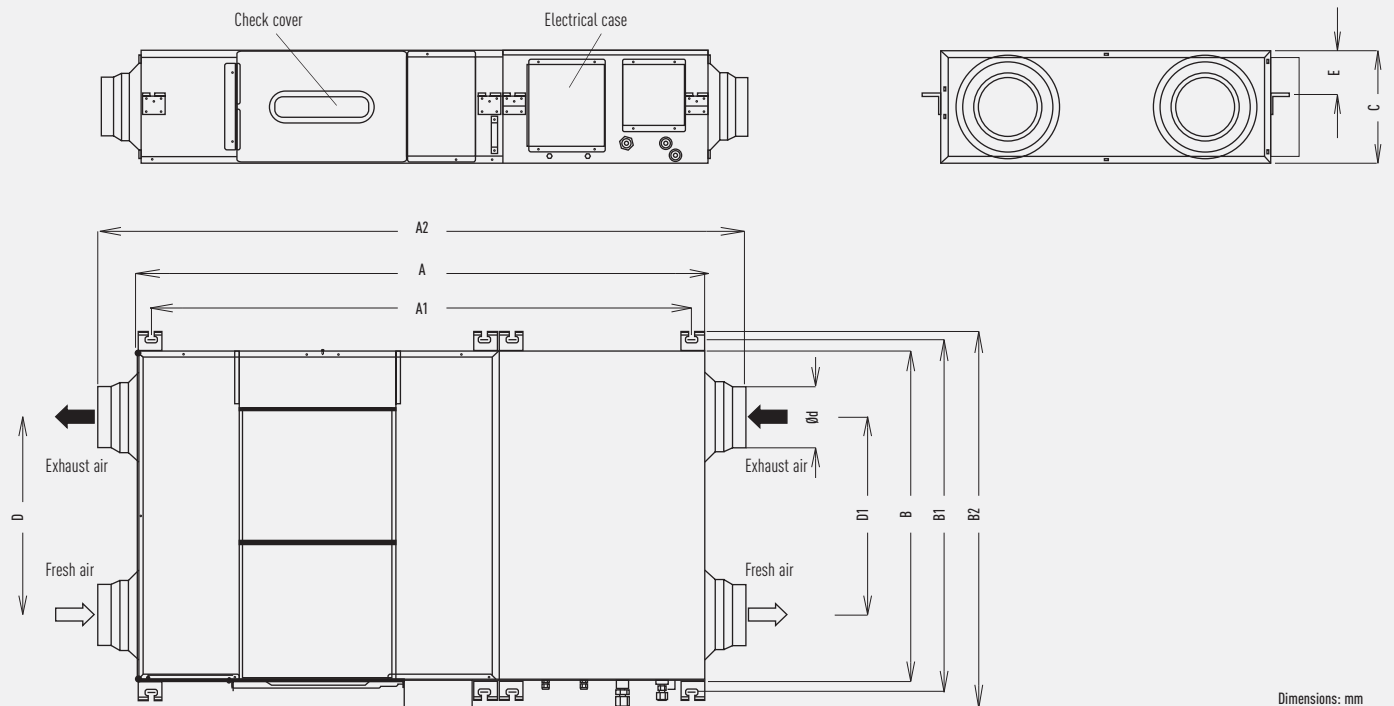

Dimensions: mm

T2 Type // Ceiling

S-36MT2E5A // S-45MT2E5A // S-56MT2E5A

1	Drain port VP20	Inside diameter ϕ 26mm, drain hose supplied
2	Left drain position	
3	Refrigerant liquid tubing	ϕ 9,52mm, flare connection
4	Refrigerant gas tubing	ϕ 15,88mm, flare connection
5	Left side drain hose outlet port (cutout)	
6	Tubing hole on wall surface	ϕ 100mm
7	Upper side tubing port	
8	Right side drain hose outlet port (cutout)	
9	Wireless remote controller receiver installation location	

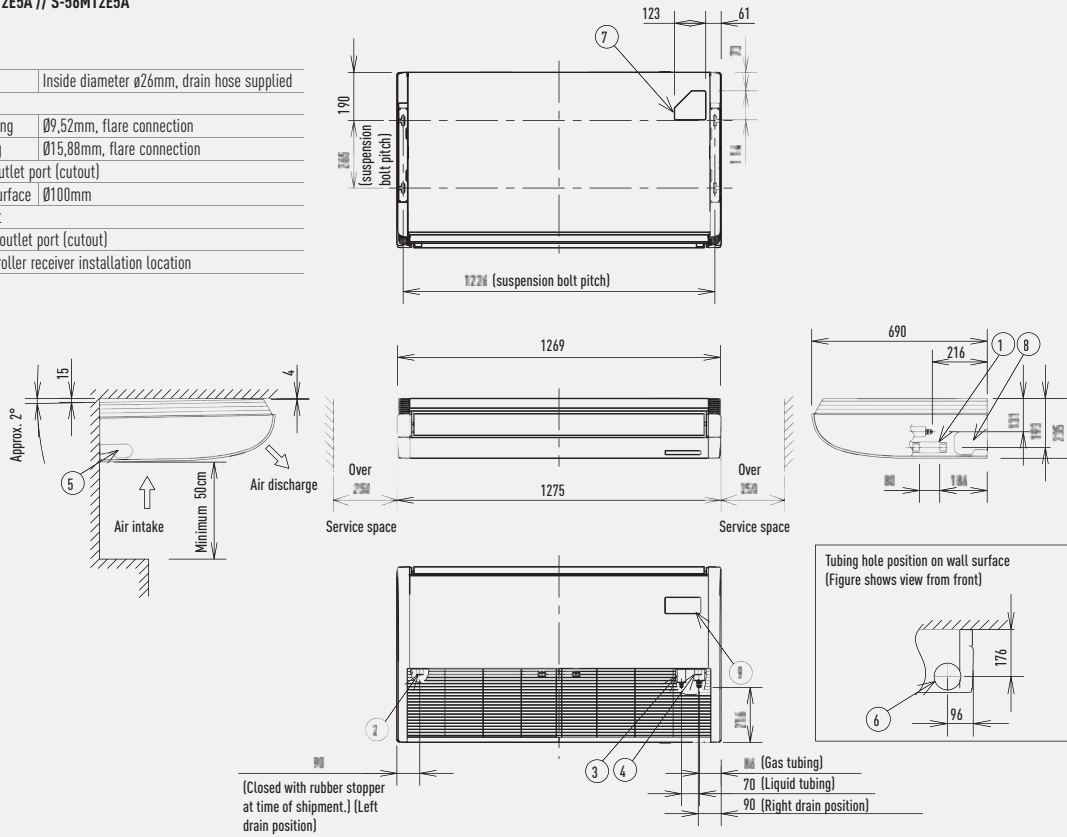

S-73MT2E5A // S-106MT2E5A // S-140MT2E5A

	A	B	C	D	E
106-140 type	1,590	235	690	1,584	1,541
140 type	1,275	235	690	1,269	1,226

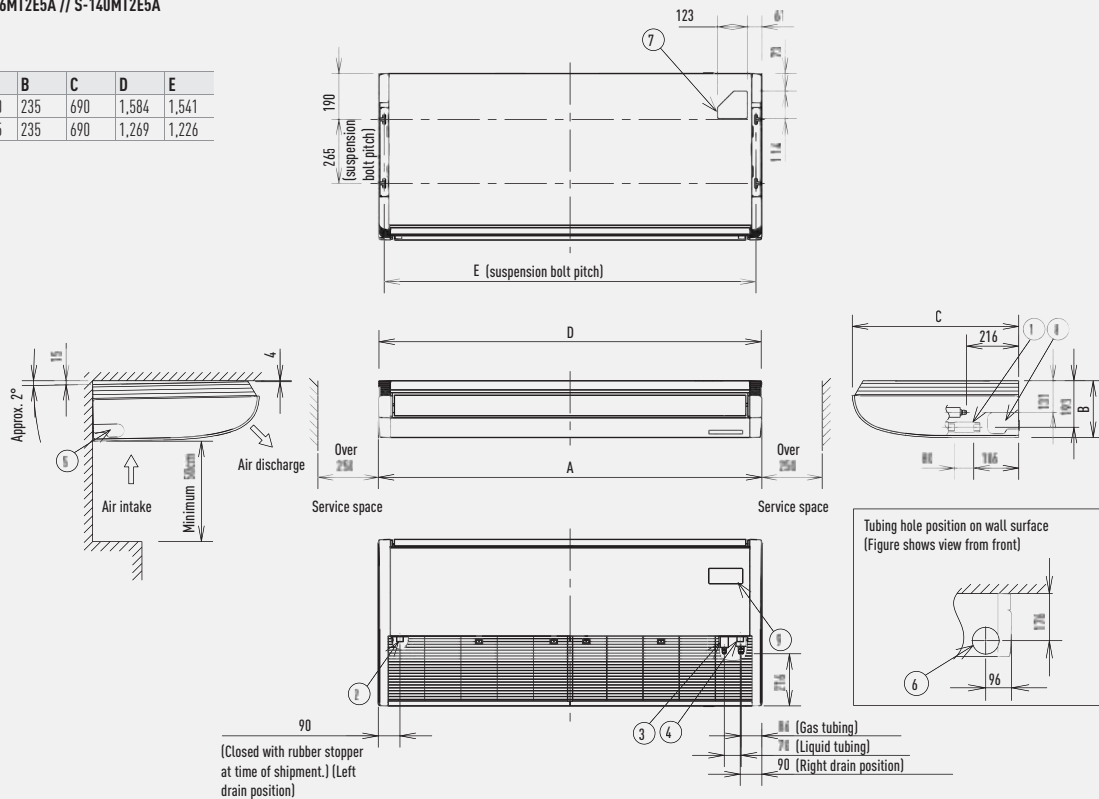

Dimensions: mm

ECOi and ECO G indoor units dimensions

K2/K1 Type // Wall Mounted

S-15MK2E5A / S-22MK2E5A / S-28MK2E5A / S-36MK2E5A

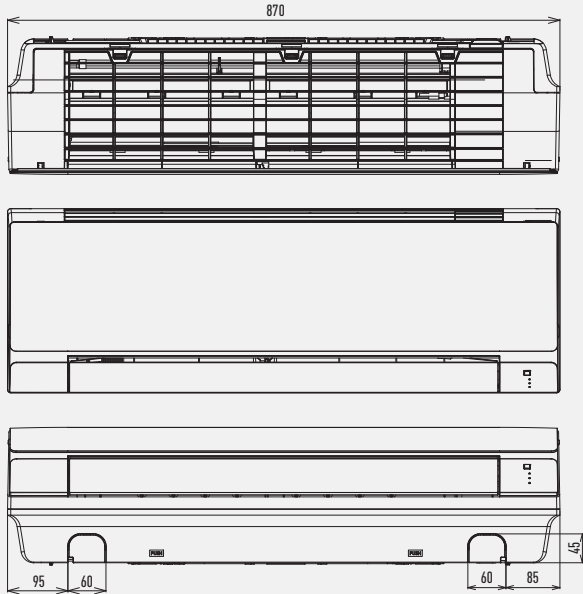

1	Refrigerant tubing (liquid tube)	Ø 6.35 (flared)
2	Drain hose	Outer diameter 16mm
3	Rear panel	PL Back
4	Refrigerant tubing (gas tube)	Ø 12.7 (flared)
5	Rear panel fixing holes	Ø 70
6	Tubing and wiring holes	Ø 70

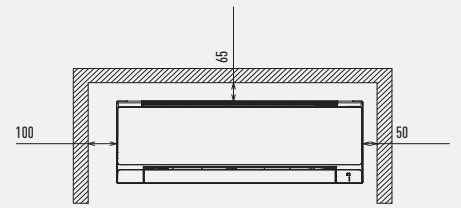
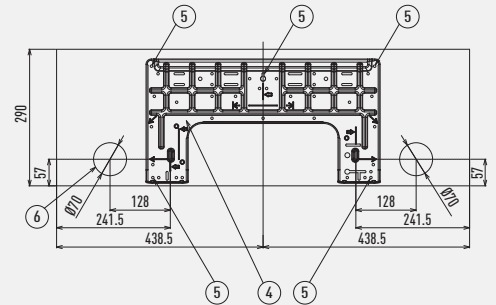
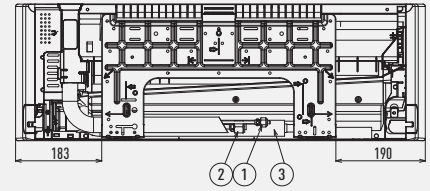

S-45MK1E5A / S-56MK1E5A / S-73MK1E5A / S-106MK1E5A

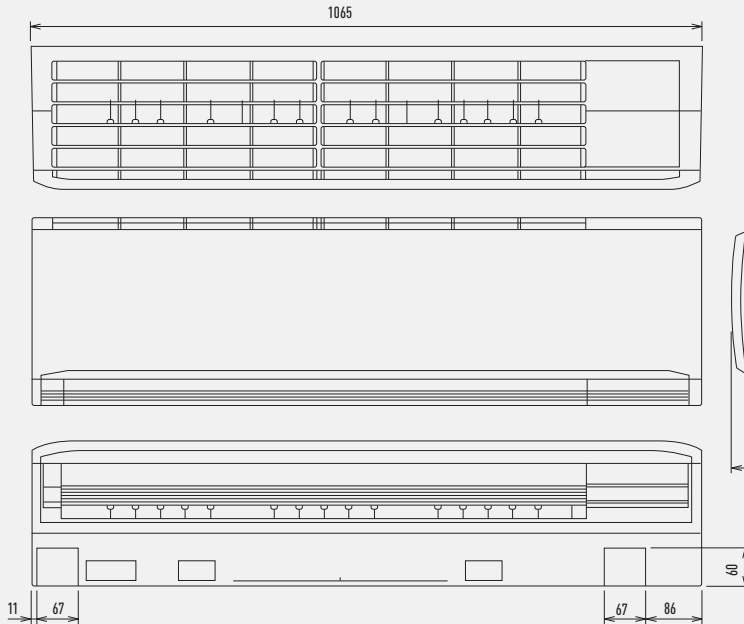

	45-56	73-106
1	Refrigerant tubing (liquid tube)	Ø 6.35 (flared) Ø 9.52 (flared)
2	Refrigerant tubing (gas tube)	Ø 12.7 (flared) Ø 15.88 (flared)
3	Drain hose VP13	Outer diameter 18mm
4	Rear panel	PL BACK
5	Tubing and wiring holes	Ø 80

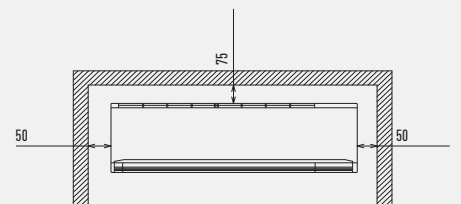
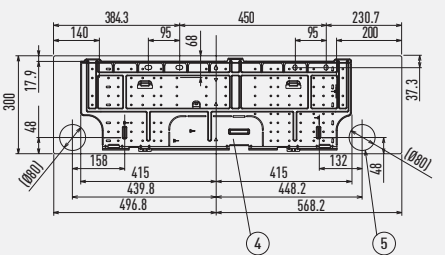
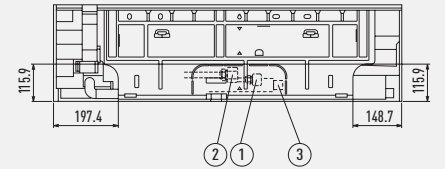

Dimensions: mm

P1 Type // Floor Standing

- 1 4- \emptyset 12 hole (For fastening the indoor unit to the floor with screws.)
- 2 Air filter
- 3 Refrigerant connection outlet (liquid tube)
- 4 Refrigerant connection outlet (gas tube)
- 5 Level adjusting bolt
- 6 Drain outlet (20 A)
- 7 Power cord outlet (downward, rear)
- 8 Refrigerant tubing outlet (downward, rear)
- 9 Location for mounting the remote controller (Remote controller can be attached within the room.)

	A	B	C	Liquid pipes	Gas pipes
22-36	1065	665	632		
45				\emptyset 6.35	\emptyset 12.7
56	1380	980	947		
71				\emptyset 9.52	\emptyset 15.88

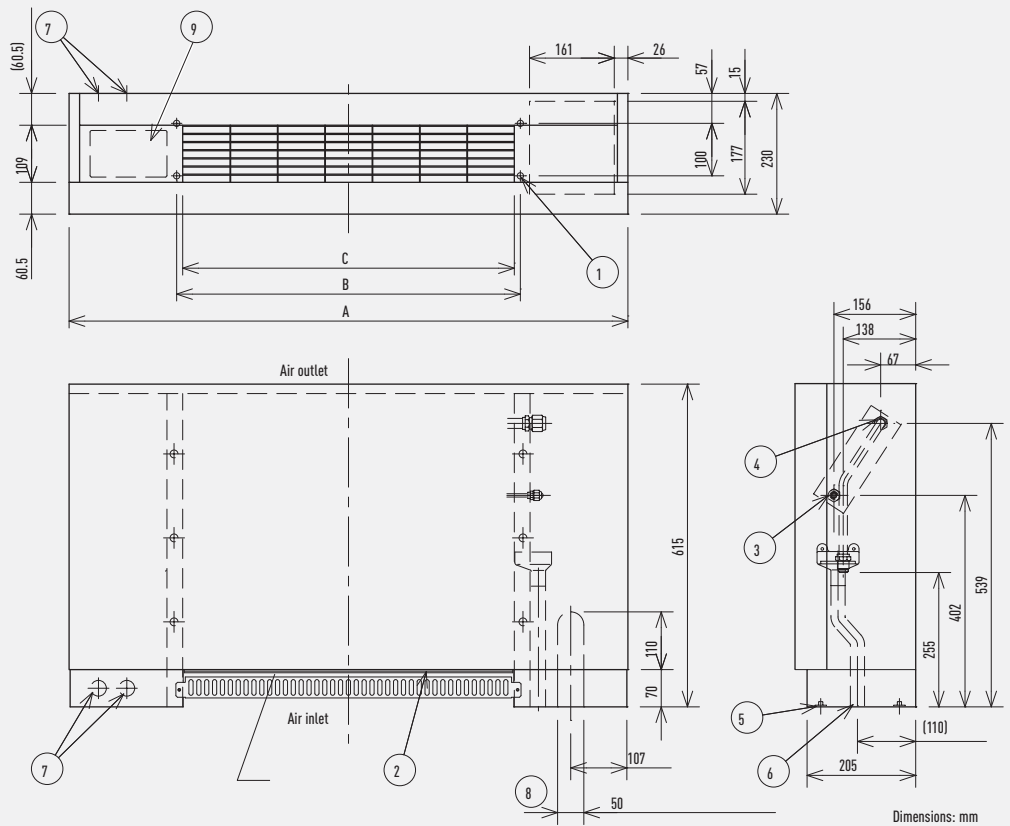

R1 Type // Concealed Floor Standing

- 1 4- \emptyset 12 hole (For fastening the indoor unit to the floor with screws.)
- 2 Air filter
- 3 Refrigerant connection outlet (liquid tube)
- 4 Refrigerant connection outlet (gas tube)
- 5 Level adjusting bolt
- 6 Drain outlet (20 A)
- 7 Flange for the air-outlet duct

	A	B	C	D	E	F	Liquid pipes	Gas pipes
22-36	904	692	672	665	500	86		
45							\emptyset 6.35	\emptyset 12.7
56	1,219	1,007	1,002	980	900	51		
71							\emptyset 9.52	\emptyset 15.88

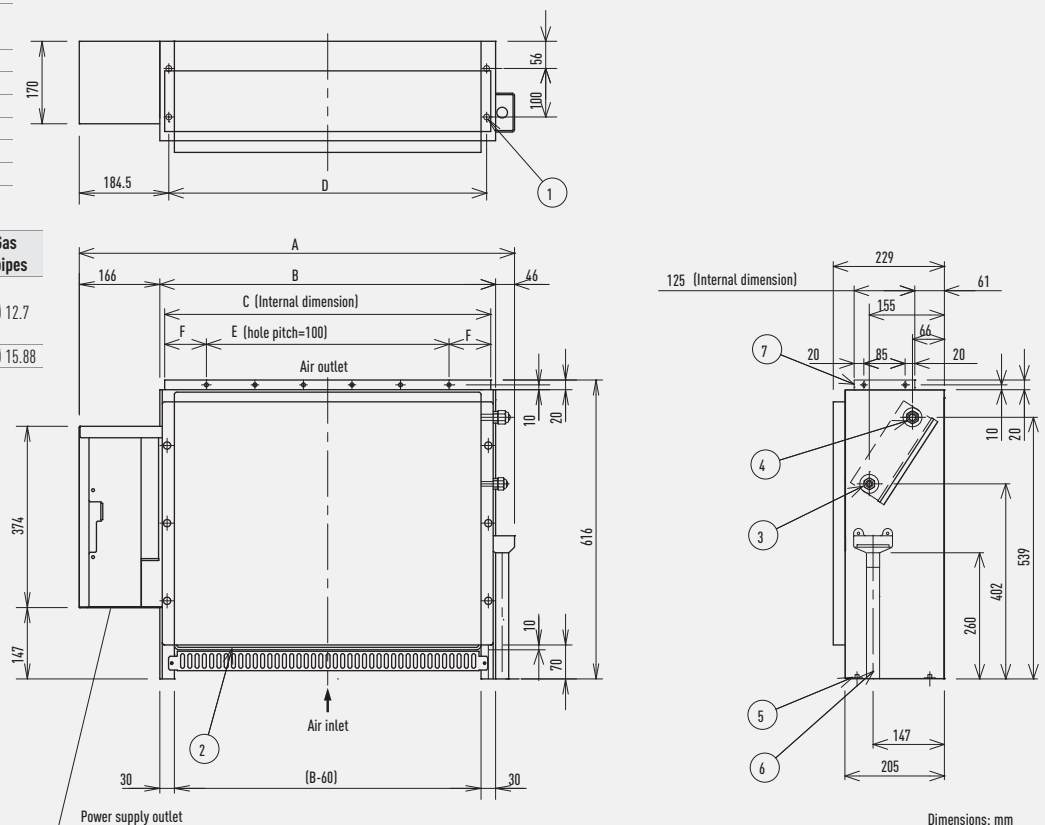





CONTROL AND CONNECTIVITY

Panasonic has developed the largest range of control systems to offer the best option to each need.

From the individual remote control for the residential single units up to the newest technology to control each your buildings around the world from an easy to use software in the cloud by your portable device.



Panasonic Smart Cloud

Take control of all your shops around the world from a single device.

Centralize control of your business premises, from wherever you are, 24/7

It doesn't matter how many sites you have, or where they are! The new Cloud system from Panasonic allows you to have complete control of all your installations, from your smartphone or from your computer. In a simple click, all your units from several locations, receive status updates in real-time of all your installations, preventing breakdowns and optimizing costs.



Main Advantages

- Control of all installations from a single internet connection, in the cloud
- All the parameters automatically updated from the GHP/ECDi/PACi in real time
- Remote maintenance advice
- Alarms



With Panasonic Smart Cloud, have your business under control, and start saving!

- Monitor temperature in your shops, optimize temperatures, reduce energy costs!
- Monitor running time, anticipate maintenance and optimise costs consumption
- Monitor breakdowns in order to take quick action to maintain the comfort in the shops
- Monitor energy consumption and running time of the units
- Compare the performance of your shops easily and develop best practices plan
- Alarms
- 2 connections possible:
 - by internet, using the shop internet connection
 - by 3G module. In this case, the system does not need internet connection, but a SIM Card and the 3G contract should be supply on the field.

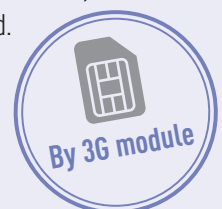



Security

Panasonic has developed both physical and software protection with a high level of encryption to secure your data on our servers which are located in Germany.

Scalable solution according to the needs

Panasonic Smart Cloud is fully scalable to the needs of your shops, franchises, facility companies.

Panasonic Smart Cloud is giving value not only for your business but also for your partners

3 steps to setup the Smart Cloud

Panasonic Smart Cloud is very easy to install on existing and new installations. The communication adaptor (CZ-CFUNC2 + PAW-CCA-1) is connected to the Panasonic bus and the Ethernet. Then in only 3 steps, the cloud system is running.

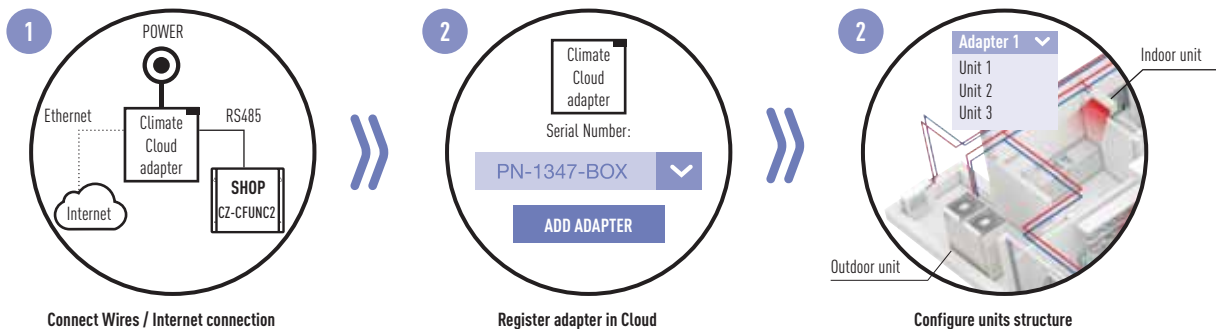
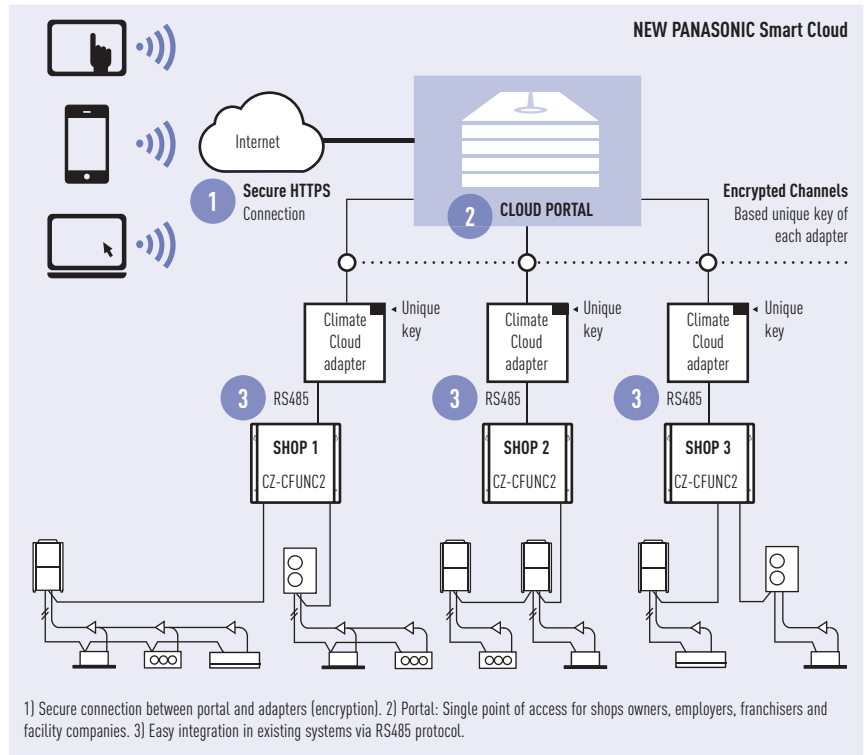

Availability of the solution		May 2014	September 2014	December 2014	2015
1	On/Off of units/groups/sites	✓			
1	Set mode per units/groups/sites	✓			
1	Set temperature per units/groups/sites	✓			
1	Running time per units	✓			
1	Schedule per units/groups/sites	✓			
1	Shops status display on Map	✓			
1	Initial configuration wizard	✓			
1	Alert notifications	✓			
1	Users management	✓			
2	Advanced statistics (working hours, performance etc.)		✓		
2	Energy consumption calculation		✓		
2	Systems ranking mode based on define parameters		✓		
2	Error logs		✓		
2	Status on map		✓		
2	Email notifications		✓		
2	3-G module			✓	
3	Maintenance module				✓
3	Energy Management module				✓

1) This service is available on a 2 year base contract, with automatic renewal every year. The parties can cancel the contract at the end of the year with 3 month notice. 2) This cost only covers the activation of the system on the cloud. The 3G card and the 36 monthly fee from the telecommunication company is not included and must be supply locally.



Remote controller with Econavi

Easy to use, attractive, clear design, with new demand control functions and energy consumption display! This useful feature makes this remote control unique!

Design

The new CZ-RTC5 wired remote control is ideal for integration into the most demanding interior architectures.

The touch panel features a very sleek and easy to use display, which with its compact display is only 120mm x 120mm x 16mm.

Display of information

The information is mainly based on pictograms to ensure easy understanding.

The minimal amount of text is available in 4 languages (English / German / French / Spanish / Italian). The screen is back lit to enable reading even during the night.

Easy Access to the menus

With the new pictograms, the navigation, the selection and the settings are simple and easy to follow.

Key Functions

- Easy setup of the timer and settings of the indoor unit
- Energy consumption display (only available with PACi units with the reference ending with A)
- Limitation of the energy consumption (Demand control) by timer.

Basic function (Operation display & indication)

All functions are easily available on the remote controll.

- OFF/ON timer • Weekly timer • Quiet operation • Remote control sensor • Operation prohibit • Filter sign • Energy saving • Centralized control indication • Mode change prohibit • Automatic temperature return • Temperature range limitation • OFF remind • Schedule demand control • Ventilation • Out Function

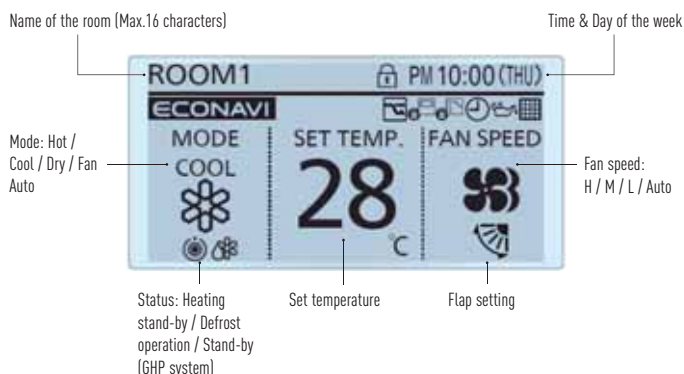

Example of easy access to the functions: Energy consumption monitoring display per day, week, month and year (only available with PACi units)

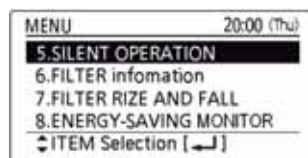

Menu selection: 3 types (Day/Week/Year)of display are available.

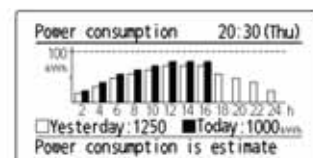

Daily Energy consumption: Data is shown with Yesterday's record.(Graph starts from 0 o'clock to 24 o'clock only)

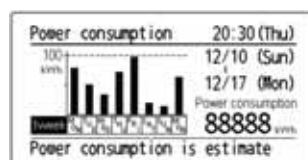

Weekly Energy consumption: Power consumption of each day of the week can be checked.

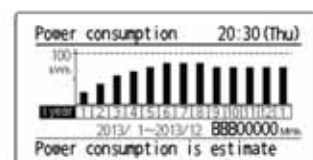

Annual Energy consumption: Power consumption of each month can be checked.

Easy operation and quick access to all menus

1. Set temperature will be selected, when any arrow button is touched.
2. Select the item (Mode or Fan speed) by left/right ◀▶ key.
3. Change the setting by up/down ▲▼ key.

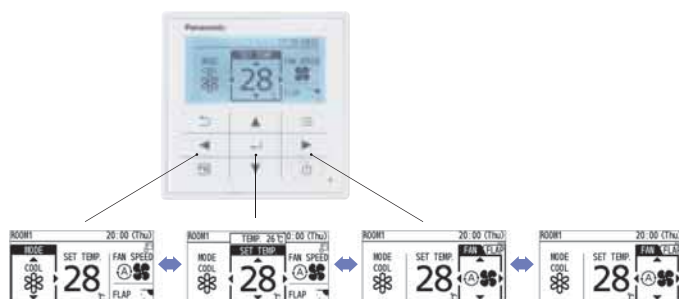

Example of easy access to the functions: Air direction setting

1. Select "Air direction" and press "determine" key.
2. Select the unit No. by up/down key.
3. Select the flap position by up/down key.
4. Press "Return" key to go back the Menu display.

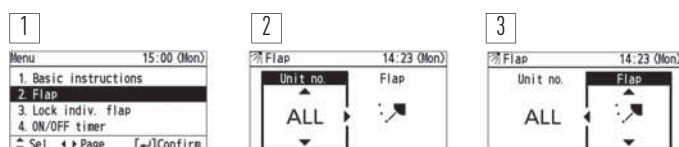

Example of easy access to the functions : Weekly timer setting

8 actions available per day. Total 56 actions per week can be set.

1. Weekly timer menu display
2. Setting for each day of the week
3. Timer program setting of the day

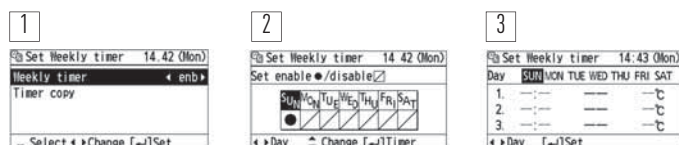

Functions available on the CZ-RTC5

Control item	Controllability	Indoor Units			
		All PACi	Only PACi ending on A	All VRF	
Basic Operation	Operation, Mode, Temperature setting, Airflow volume, Airflow direction	✓	✓	✓	
	Timer function	✓	✓	✓	
Energy saving	Time display	✓	✓	✓	
	Easy ON/OFF timer	✓	✓	✓	
	Weekly Program timer	✓	✓	✓	
	Outing function	✓	✓	—	
	Temperature auto return	✓	✓	—	
	Temperature setting range limitation	✓	✓	—	
	OFF remind	✓	✓	—	
	Energy saving mode	✓	✓	—	
	Schedule demand control	—	✓	—	
	Energy monitoring	—	✓	—	
Maintenance	System failure information	—	✓	—	
	Service contact registration	✓	✓	✓	
	Filter sign (rest time display) & Reset	✓	✓	✓	
	Auto-address, Test run	✓	✓	✓	
	Sensor value monitor	✓	✓	✓	
	Simple/Detail setting mode	✓	✓	✓	
	Others	Key lock	✓	✓	✓
	Ventilation fan control	✓	✓	✓	
Display contrast adjustment	✓	✓	✓		
Remote controller sensor	✓	✓	✓		
Quiet operation mode	—	✓	—		
Prohibit setting control from Central controller	✓	✓	✓		

All specifications subject to change without notice.



Wired remote controller CZ-RTCS with Econavi Sensor Control

Up to **28%**
energy savings
(cooling)
ECONAVI

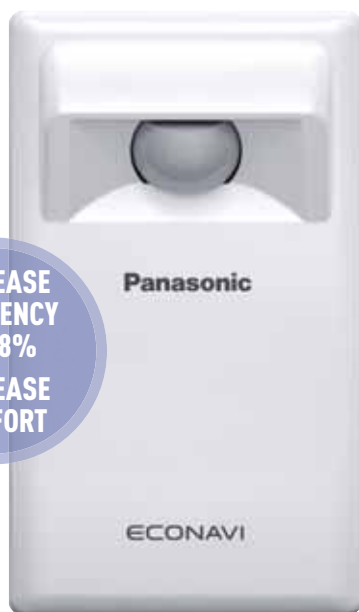

Econavi Sensor reference: CZ-CENSC1

Econavi Sensor

The all new Econavi Sensor detects presence in the room, and quietly adapts the PACi or VRF air conditioning system in order to improve comfort and maximise energy savings.

- Detects human activity and adjusts temperature by 2 degrees (up or down) to optimize comfort and efficiency
- If there is no activity detected for a set time, the Econavi will stop the unit or move to a new temperature previously set
- The Econavi device is installed independently of the indoor unit, and is located in the area best suited for detection

Applications

Saving Energy for Offices: if the air conditioning is left on after the last employee leaves the office, Econavi will automatically react, reducing or stopping the system.

Increased comfort in hotel rooms: when presence is detected in the room, the temperature is automatically adjusted to achieve best comfort.

Econavi function

- Analyses room activity: Human activities and human heat
- Modifies the capacity to adapt in real-time to the needs of the room

Key points

- Compatible with Cassette, Wall Mounted, Hide Away and Ceiling • Sensor • Improves efficiency • Better Comfort • Can be installed in the best place of the room for detection purposes.

Human activity and presence detection

Activity detection		Presence detection	
HIGHER ACTIVITY	LOWER ACTIVITY	After 20 mins absence	After 3 hours absence
Cooling Set Temp. +/-0°C	Cooling Set Temp. +1°C	Cooling Set Temp. +2°C	Cooling Thermo OFF
Heating Set Temp. -1°C	Heating Set Temp. +/-0 °C	Heating Set Temp. -2°C	Heating Thermo OFF
Each 2 min		After 3 hours set up can be change to stop or temp shift	



Sensor location image

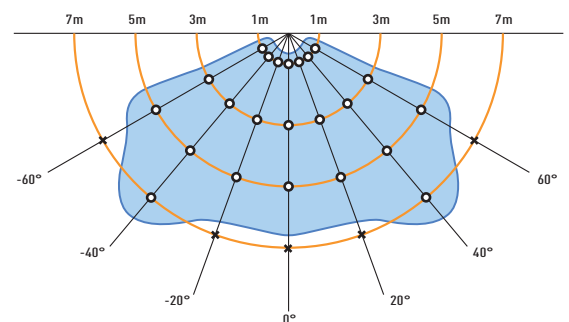
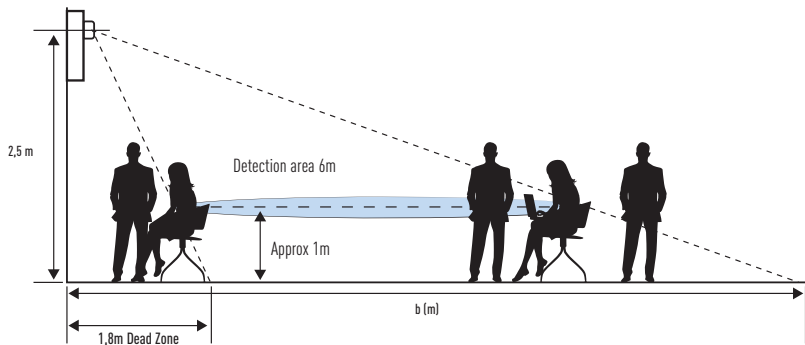

Human detection area (2,5m height angle 30°)

Model evaluation only for PACi (Laboratory Testing/Cooling Operation)

**28%
ENERGY
SAVING**

Test Method

To establish conditions for our field tests, because human movements and door open/close are random, we did not test on set conditions. To replicate typical conditions, we have fixed variable numbers (see below) and tested how Econavi's temperature control function contributes to energy efficiency level.

For each temperature setting, we have tested and compared power consumption at three-hourly intervals.

Integral Power Consumption Cooling Operation

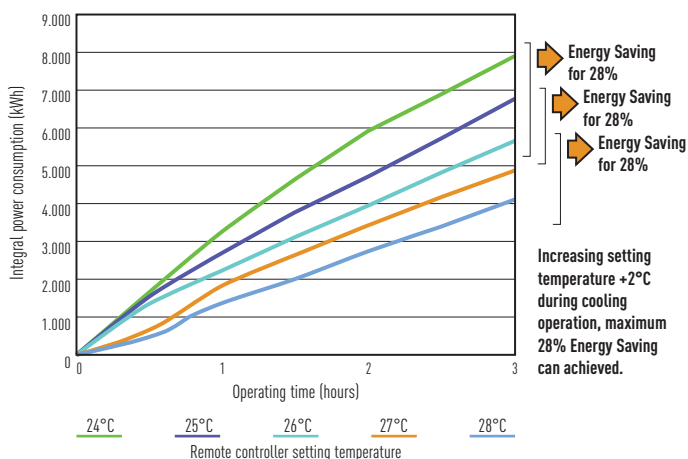

Test Condition



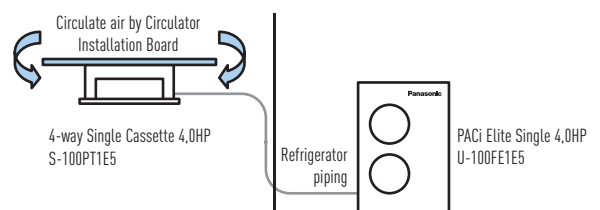

- Testing location: New 6,0HP testing room / 29m²
- Test sample remote controller setting: Setting temperature: Cooling 24 ~28°C / Fan Speed: Hi
- Measured integral power consumption every 30 minutes and compare (including thermo OFF period)
- Room temperatures / 19°C, outdoor temperature 35/24°C (cooling nominal capacity) cool down the room for 1 hour and keep the room temperature stable. After the room temperature become stable, turn OFF indoor unit refrigerator and heater and only operate circulator and continue cooling down the room by the unit (operating circulator to avoid temperature variation)

Test Sample Testing Location: Building 1.460 NEW 6,0HP TESTING ROOM



Indoor setting temperature 27/19°C. Turn OFF indoor unit refrigerator and heater and continue cooling operation (circulator operation ON).











Operation System	Individual Control Systems						
Requirements	Control for hotel application (for VRF)		Wired remote controller		Wireless remote controller	Quick and easy operation	
External appearance							
Type, model name	Intelligent Controller		Normal operation	Normal operation with Econavi	Design wired remote controller	Wireless remote controller	Simplified remote controller
	PAW-RE2C3-WH PAW-RE2C3-GR PAW-RE2C3-MOD-WH PAW-RE2C3-MOD-GR PAW-RE2C3-LON-WH PAW-RE2C3-LON-GR	Stand-Alone White Stand-Alone Grey Modbus White Modbus Grey LonWorks White LonWorks Grey	CZ-RTC2 (Will be replaced in June by CZ-RTC4)	CZ-RTC4 ECONAVI	CZ-RTC3 (Will be replaced in October by CZ-RTC5) ECONAVI	CZ-RWSU2 // CZ-RWSY2 // CZ-RWSL2 // CZ-RWSC3 // CZ-RWST2 // CZ-RWST3 // CZ-RWSK2	CZ-RE2C2
Econavi Control	—		—	✓	✓	—	—
Power consumption monitor	—		—	✓ ²	✓ ²	—	—
Built-in Thermostat	✓		✓	✓	✓	✓	✓
I_0 which can be controlled	1 indoor unit		1 group, 8 units	1 group, 8 units	1 group, 8 units	1 group, 8 units	1 group, 8 units
Use limitations	—		· Up to 2 controllers can be connected per group	· Up to 2 controllers can be connected per group	· Up to 2 controllers can be connected per group	· Up to 2 controllers can be connected per group	· CZ-RE2C2: up to 2 controllers can be connected per group
Function ON/OFF	✓		✓	✓	✓	✓	✓
Mode setting	AUTO		✓	✓	✓	✓	✓
Fan speed setting	✓		✓	✓	✓	✓	✓
Temperature setting	✓		✓	✓	✓	✓	✓
Air flow direction	—		✓	✓	✓	✓ ¹	✓ ¹
Permit/Prohibit switching	✓		—	—	—	—	—
Weekly program	—		✓	✓	✓	—	—

1. Setting is not possible when a remote control unit is present (use the remote control for setting). 2) Only for PACi Elite except 50 type. * All specifications subject to change without notice.

Control systems for PACi, ECOi and ECO G

A wide variety of control options to meet the requirements of different applications.

Timer Operation	Centralized Control Systems						
Daily and weekly program	Operation with various function from center station	NEW	Only ON/OFF operation from center station	Simplified load distribution ratio (LDR) for each tenant	BMS System. PC Base	Connection with 3rd Party Controller	
							
Schedule timer	System controller	New System Controller with Schedule timer	ON/OFF Controller	Intelligent Controller (Touch screen panel)	CZ-CSWKC2	Local adaptor for ON/OFF control CZ-CAPC2	
CZ-ESWC2	CZ-64ESMC2	CZ-64ESMC3 (Available in December 2015. Tentative data)	CZ-ANC2	CZ-256ESMC2 (CZ-CFUNC2)	Optional software 	MINI Seri-Para I/O Unit CZ-CAPBC2	
—	—	—	—	—	CZ-CSWAC2 for Load distribution. CZ-CSWWC2 for Web application. CZ-CSWGC2 for Object layout display. CZ-CSWBC2 for BAC net software interface. *PC required (field supply)	Communication Adaptor CZ-CFUNC2	
64 groups, max. 64 units	64 groups, max. 64 units	64 groups, max. 64 units	16 groups, max. 64 units	64 units x 4 systems, max. 256 units	Web Interface Systems 		
<ul style="list-style-type: none"> Required power supply from the system controller When there is no system controller, connection is possible to the T10 terminal of an indoor unit 	<ul style="list-style-type: none"> Up to 10 controllers, can be connected to one system Main unit/sub unit (1 main unit + 1 sub unit) connection is possible Use without remote controller is possible 	<ul style="list-style-type: none"> Up to 10 controllers, can be connected to one system Main unit/sub unit (1 main unit + 1 sub unit) connection is possible Use without remote controller is possible 	<ul style="list-style-type: none"> Up to 8 controllers (4 main units + 4 sub units) can be connected to one system Use without remote controller is impossible 	<ul style="list-style-type: none"> A communication adaptor (CZ-CFUNC2) must be installed for three or more systems 	CZ-CWEBC2 *PC required (field supply)		
—	✓	✓	✓	✓			
—	✓	✓	—	✓			
—	✓	✓	—	✓			
—	✓	✓	—	✓			
—	✓ ¹	✓ ¹	—	✓ ¹			
—	✓	✓	✓	✓			
✓	—	✓	—	✓			



Nº1
FOR HOTEL APPLICATIONS
ALL IN ONE!

More easier to install, cheaper to integrate one only control to integrate all devices

Control for hotel application

Nice, easy and cost effective!

Panasonic has developed an innovative line up of remote controls specially designed for applications:

- Easy to install
- Cost effective installation as all electrical cable are centralized on this remote
- Architect inspired attractive design
- Direct connection to the Indoor unit with most of the functions of the indoor unit
- 3 options available: Stand-Alone, Modbus or LonWorks communication
- 2 frame colours: White and aluminium

From this remote control: The lighting, card contact, motion detector, window contact and the air conditioning are controlled.

Energy saving functions included on the device: • Turns Off air conditioning and lighting when room is unoccupied • Disables air conditioning when window is open • Maximum/minimum setpoint temperature configurable

Easy remote control: The hotel customer will have access to limited functions to control the air conditioning:

ON/OFF, Temperature (under a certain limit fixed during the start up) and Fan speed

Easy set up: Stand-Alone model with easy configuration menu to access all parameters. The installation is simplified as all the cables should arrive to the remote control. A pre-define scenario can be uploaded on the remote control connected to a computer to make installation on site plug and play (only on the Modbus and LonWorks models).



Control to integrate all room hotel needs in one device:

Card switch. Heating and cooling control.
Light control. Window control. Possible to connect to Modbus

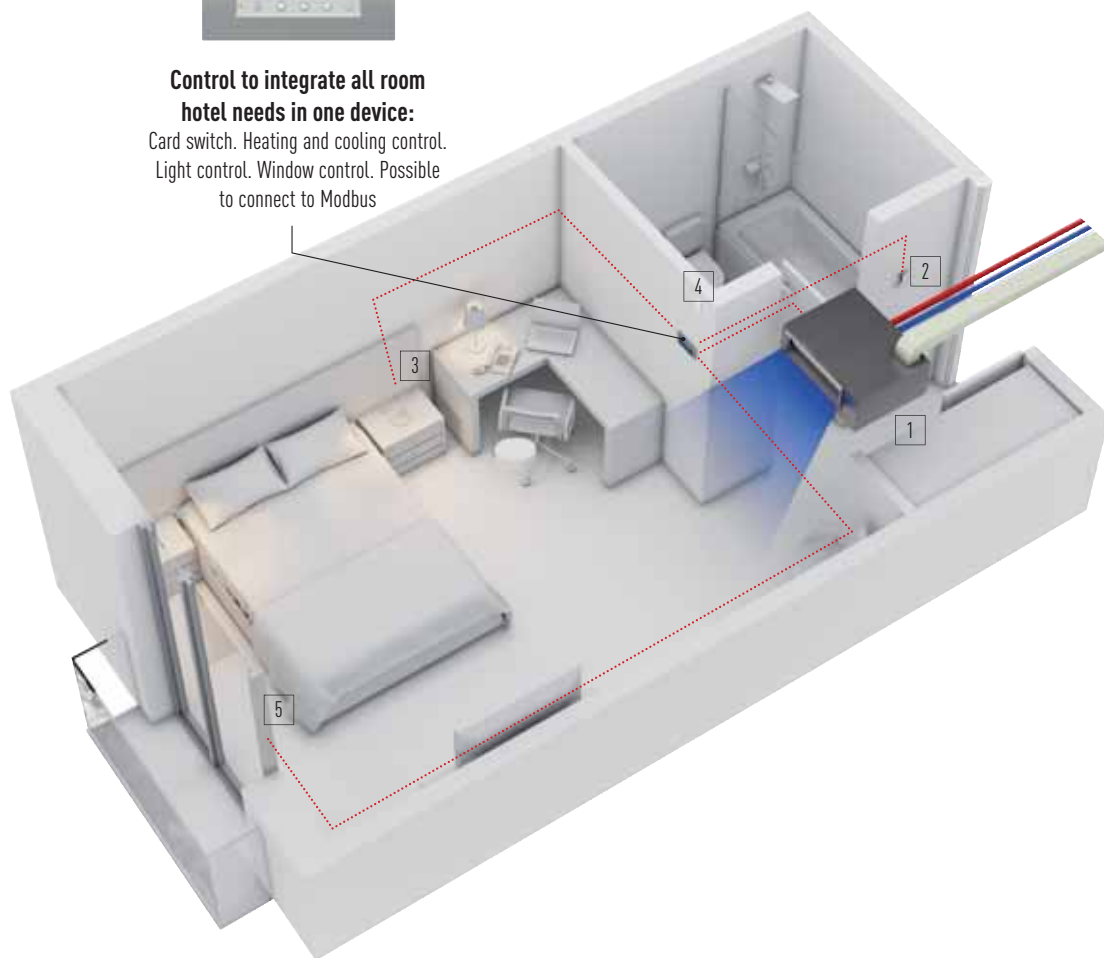

1. Indoor unit. Variable static pressure hide away

2. Room card switch*



3. Lighting control

4. Human sensor

5. Window contact*

* Field supply

Four preconfigured systems (option 1 to 4)

The remote control have a 4 preconfigured systems in order to easily integrate it.

4 options available I/O configurations: Inputs

Configurations	Digital 1-2	Digital 3-4	Digital 5-6	Analog 7-8
Option 1	Card	Window	Lighting	Temperature
Option 2	Card	Window	Blinds Up	Blinds Down
Option 3	Motion Sensor	Window	Door Contact	Temperature
Option 4	Lighting	Window	Blinds Up	Blinds Down

Available I/O Configurations: Outputs

Configurations	Relay 15-16	Relay 13-14	Relay 11-12	Relay 9-10
Option 1	Courtesy	Lighting	Not Used	Valve actuator
Option 2	Courtesy	Lighting	Blinds Up	Blinds Down
Option 3	Courtesy	Lighting	Not Used	Valve actuator
Option 4	Not used	Lighting	Blinds Up	Blinds Down

I/O Definitions: Inputs

Description	Functionality
Card	Occupancy room status. Enable HVAC Control and automatically switches ON Courtesy and Lighting outputs
Window	Temporary disables HVAC System
Lighting	Pushbutton to turn ON/OFF Lighting Output when room occup.
Temperature	Analog input for Valve Actuator output control on 2nd zone
Blinds Up	Pushbutton for Blind Up motor output control
Blinds Down	Pushbutton for Blind Down motor output control
Motion Sensor	In combination with Door Contact, enables HVAC Control and automatically switches ON Courtesy and Lighting outputs
Door Contact	In combination with Motion Sensor, enables HVAC Control and automatically switches ON Courtesy and Lighting outputs

I/O Definitions: Outputs

Description	Functionality
Courtesy	Automatically turns ON when room changes to occupied or unoccupied mode. It turns to OFF after a configurable time-out
Lighting	Automatically turns ON/OFF when room changes to occupied/unoccupied. Manual override with Lighting input
Valve Actuator	HVAC Control for a 2nd zone
Blinds Up	Output for Blind Up motor control
Blinds Down	Output for Blind Down motor control

Example I/O: Wiring configuration for Option 2

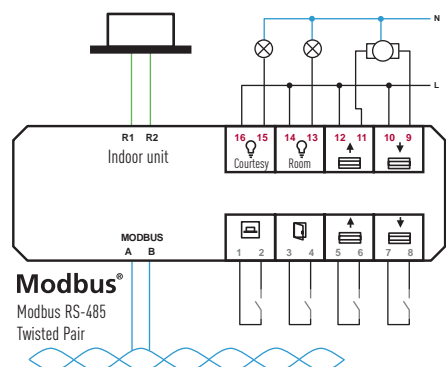

Example I/O: Option 2

Terminals	Description	Type
A, B	Modbus RS-485	Bi-directional
R1, R2	Indoor Unit	Bi-directional
1, 2	Card contact	Digital Input
3, 4	Window Contact	Digital Input
5, 6	Blinds Up	Digital Input
7, 8	Blinds Down	Analog Input
9, 10	Blinds Down	Relay Output
11, 12	Blinds Up	Relay Output
13, 14	Lighting Room	Relay Output
15, 16	Lighting Courtesy	Relay Output

Panasonic Reference

PAW-RE2C3-WH	Stand-Alone with I/O White frame
PAW-RE2C3-GR	Stand-Alone with I/O Grey Frame
PAW-RE2C3-MOD-WH	Modbus RS-485 with I/O White frame
PAW-RE2C3-MOD-GR	Modbus RS-485 with I/O Grey frame
PAW-RE2C3-LON-WH	LonWorks TP/FT-10 with I/O White frame
PAW-RE2C3-LON-GR	LonWorks TP/FT-10 with I/O Grey frame

Individual Control Systems

Wired remote controller. Normal operation with Econavi (CZ-RTC4) (Available in June 2015)



- Time Function 24 hours real time clock (week day indicator)
- Weekly programme function (a maximum of 6 actions can be programmed for each day)
- Sleeping function (this function controls the room temperature for comfortable sleeping)
- Maximum 8 indoor units can be controlled from one remote controller
- Remote control by main remote controller and sub controller is possible (maximum 2 remote controllers (main remote controller and sub controller) can be installed for one indoor unit)
- Possible to connect to the outdoor unit using PAW-MRC cable for servicing purposes
- Outing function (this function can prevent the room temperature from dropping or rising when the occupants are out for a long time)
- Dimensions (H x W x D:): 120 x 120 x 20 mm
- Weight: 160 g

Basic remote controller ON/OFF

- Econavi compatible
- Operation mode changeover (Cooling, Heating, Dry, Auto, Fan)
- Temperature setting (Cooling / Dry: 18-30 °C Heating: 16-30 °C)
- Fan speed setting High / Medium / Low and Auto
- Air flow direction adjustment

High-spec wired remote controller (CZ-RTC5) (Available in October 2015)



- Power consumption monitor (only for PACi)
- Flat face design & Touch sensor switch for stylish design and operating usability
- New functions such as for Energy saving & monitoring and for Service use are available on the Full dot LCD (3,5" display)
- Improved illumination
- White LED backlit
- Blink when alarm occurs

Basic Operation

- Operation
- Mode
- Temperature setting
- Airflow volume
- Airflow direction

Energy saving

- Outing function
- Temperature setting range limitation
- Temperature auto return
- OFF remind
- Schedule demand control
- Energy saving mode
- Energy monitoring

Others

- Key lock
- Ventilation fan control
- Display contrast adjustment
- Remote controller sensor
- Quiet operation mode
- Prohibit setting control from Central controller

Timer function

- Outing function
- Weekly Program timer
- Easy ON/OFF timer
- Time display

* Several functions can not use on some outdoor unit. Ex. Power consumption monitor is not available for PACi Standard, Big PACi and PACi Elite 5D type.

Timer remote controller (CZ-RTC2)



- Time Function 24 hours real time clock (week day indicator)
- Weekly programme function (a maximum of 6 actions can be programmed for each day)
- Sleeping function (this function controls the room temperature for comfortable sleeping)
- Maximum 8 indoor units can be controlled from one remote controller
- Remote control by main remote controller and sub controller is possible (maximum 2 remote controllers (main remote controller and sub controller) can be installed for one indoor unit)
- Possible to connect to the outdoor unit using PAW-MRC cable for servicing purposes
- Outing function (this function can prevent the room temperature from dropping or rising when the occupants are out for a long time)

Basic remote controller ON/OFF

- Operation mode changeover (Cooling, Heating, Dry, Auto, Fan)
- Temperature setting (Cooling / Dry: 18-30 °C Heating: 16-30 °C)
- Fan speed setting High / Medium / Low and Auto
- Air flow direction adjustment

Dimensions (H x W x D): 120 x 120 x 16mm

Control contents	Part name, model No.	Quantity
Standard Control	Timer remote controller: CZ-RTC4 Wired remote controller: CZ-RE2C2 // CZ-RELC2 Wireless remote controller: CZ-RWSU2 // CZ-RWSL2 // CZ-RWSG2 // CZ-RWSK2 // CZ-RE2C2	1 unit each
(1) Group control	Timer remote controller: CZ-RTC4 Wired remote controller: CZ-RE2C2 Wireless remote controller: CZ-RWSU2 // CZ-RWSL2 // CZ-RWSG2 // CZ-RWSK2 // CZ-RE2C2	1 unit
(2) Main/Sub remote control	Main or sub. Timer remote controller: CZ-RTC4 Wireless remote controller: CZ-RWSU2 // CZ-RWSL2 // CZ-RWSG2 // CZ-RWSK2 // CZ-RE2C2	As required

Wireless remote controller



CZ-RWSU2
For 4 Way 90x90 Cassette.



CZ-RWSL2
For 2 Way Cassette.



CZ-RWSK2
For Wall Mounted and 4 Way 60x60 Cassette (with panel CZ-KPY3A).



CZ-RWST2
For 1 Way Cassette.



CZ-RWST3
For Ceiling.



CZ-RWSK2 + CZ-RWSC3
Combination for all indoor units.



- Easy installation for the 4 Way cassette type simply by replacing the corner part
- 24 hour timer function
- Remote control by main remote controller and sub controller is possible (Max. 2 remote controllers (main remote controller and sub controller) can be installed for one indoor unit)
- When CZ-RWSC3 is used, wireless control becomes possible for all indoor units (1: when a separate receiver is set up in a different room, control from that room also becomes possible. 2: automatic operation by means of the emergency operation button is possible even when the remote controller has been lost or the batteries have been exhausted)
- Operation of separate energy recovery ventilators (When commercial ventilation fans or heat-exchange ventilation fans have been installed, they can be operated with this remote control (interlocked operation with the indoor unit or independent ventilation ON/OFF)

Simplified remote controller (CZ-RE2C2)



A remote controller with simple functions and basic operation

- Suitable for open rooms or hotels where detailed functions are not required
- ON/OFF, operation mode switching, temperature setting, air speed switching, air flow direction setting, alarm display, and remote controller self-diagnosis can be performed
- Batch group control for up to 8 indoor units

- Remote control by main remote controller and sub controller is possible with a simplified remote controller or a wired remote controller (up to two units)

Dimensions (H x W x D): 120 x 70 x 16mm

Remote sensor (CZ-CSRC2)



- This remote sensor can be connected to any indoor unit. Please use it to detect the room temperature when no remote controller sensor or body sensor is used (connection to a system without a remote controller is possible)
- For joint use with a remote control switch, use the remote control switch as main remote controller
- Batch group control for up to 8 indoor units

Remote sensor (CZ-CSRC3) (Available in July 2015)



- New appearance design based on simplified remote controller chassis

NEW

Centralised Control Systems

Schedule timer (CZ-ESWC2)



The power supply for the schedule timer is taken from one of the following.

1. Control circuit board (T10) of a nearby indoor unit (power supply wiring length: within 200 m from the indoor unit).
2. System controller (power supply wiring length: within 100 m from the indoor unit).

When the power supply for the schedule timer is taken from the control circuit board of the indoor unit, that indoor unit cannot be used with other control devices using the CZ-T10 terminal. As operation mode and temperature settings are not possible with the schedule timer, it must be used together with a remote controller, a system controller, an intelligent controller, etc. Also, as it does not have an address setting function, the control function of a system controller etc. must be used for address setting.

- Up to 64 groups (maximum 64 indoor units) can be controlled divided into 8 timer groups

- Six program operations (Operation/Stop/Local permission/Local prohibition) per day can be set in a program for one week
 - Only operation or stop, remote controller local permission or remote controller local prohibition, and their respective combinations are possible. (Operation + local permission, stop + local prohibition, only local permission, etc.)
 - Local prohibition and the combination of the three items of temperature setting, mode change, and operation/stop can be set at the time of installation.
- A function for pausing the timer in case of national holidays has been added, and timer operation also can be stopped for a long time
 - By setting holidays or operation stop within one week, the timer can be paused just for that week.
 - All timer settings can be stopped with the timer "ON/OFF effective" button. (Return to timer operation is made by pressing the button again.)

Dimensions (H x W x D): 120 x 120 x 16mm.

Connection example 1 (power supply from the indoor unit)

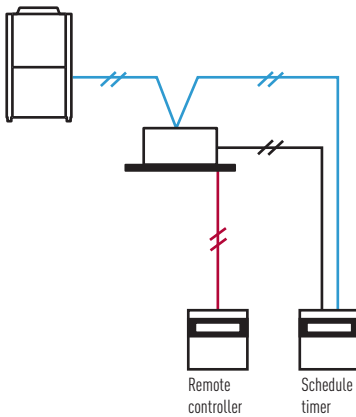

Connection example 2 (power supply from the central controller)

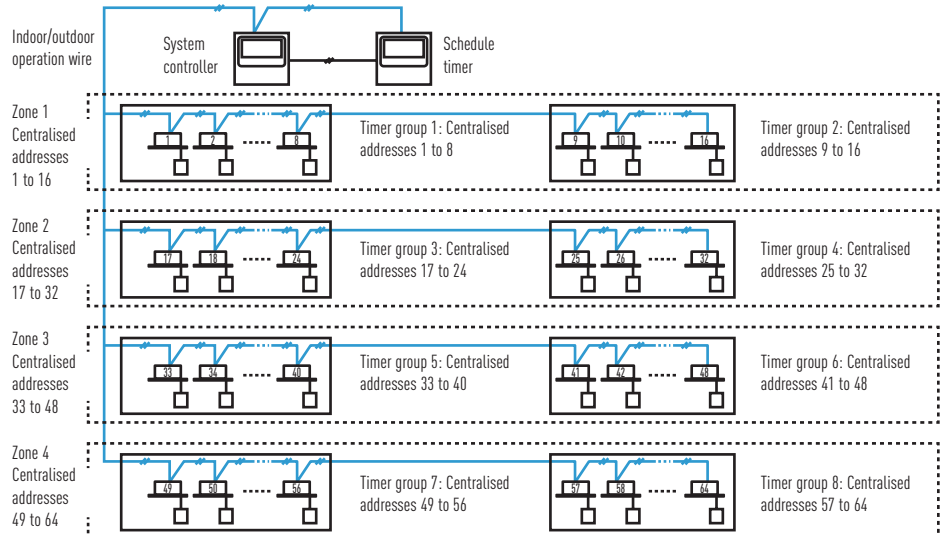

ON/OFF controller (CZ-ANC2)



- 16 groups of indoor units can be controlled.
- Collective control and individual group (unit) control can also be performed.
- Up to 8 ON/OFF controller (4 main, 4 sub) can be installed in one link system.
- The operation status can be determined immediately.

Note: As operation mode and temperature settings are not possible with the ON/OFF controller, it must be used together with a remote controller, a system controller etc.

Dimensions (H x W x D): 121 x 122 x 14 + 52mm (embedding dimension).

Power supply: AC 220 to 240 V.

I/O part: Remote input (effective voltage: within DC 24 V):

All ON/OFF.

Remote output (allowable voltage: within DC 30

V): All ON, All alarm.

New System Controller with scheduled timer (CZ-64ESMC3) (available in December 2015)



System controller (CZ-64ESMC2)



Dimensions (H x W x D): 120 x 120 x 21 + 69 mm (embedding dimension).

Power supply: AC 220 to 240 V.

I/O part: Remote input (effective voltage: DC 24 V): ALL ON/ALL OFF

Remote output (voltage-free contact): ALL ON/ALL OFF (external Power supply within DC 30 V, maximum 1 A).

Total wiring length: 1 km.

Individual control is possible for max. 64 groups, 64 indoor units.

Control of 64 indoor units divided into 4 zones. (One zone can have up to 16 groups, and one group can have up to 8 units.)

Control is possible for ON/OFF, operation mode, fan speed, air flow direction (only when used without a remote controller), operation monitoring, alarm monitoring, ventilation, remote controller local operation prohibition, etc.

- Individual All operations are possible from the remote controller. However, the contents will be changed to the last settings used on the controller.
- Central 1 The remote controller cannot be used for ON/OFF. (All other operations are possible from the remote controller.)
- Central 3 The remote controller cannot be used for mode change or temperature setting change. (All other operations are possible from the remote controller.)
- Central 4 The remote controller cannot be used for operation mode change. (All other operations are possible from the remote controller.)

Joint use with a remote controller, an intelligent controller, a schedule timer, etc. is possible

(The maximum number of connectable system controllers is 10, including other central controllers on the same circuit.)

(In case of joint use with a wireless remote controller, there are limitations for the control mode. Please use only with "Individual" and "Central 1".)

Control of systems without a remote controller and of main/sub systems (a total of up to 2 units) is possible

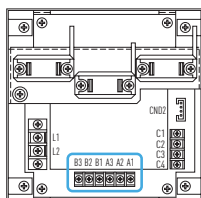

External Contacts On Central Controllers

Terminals for remote monitoring:

- A1) Input for turning ON air conditioners concurrently
- A2) Input for turning OFF air conditioners concurrently
- A3) Common input for turning air conditioners ON or OFF
- B1) On operation state indicator output
- B2) Alarm indicator output
- B3) Common indicator output

A control mode corresponding to the use condition can be selected from 10 patterns

- A. Operation mode: Central control mode or remote control mode can be selected
 - Central control mode: The system controller is used as centralised control device. (Setting from a remote controller can be prohibited by prohibiting local operation from the system controller.)
 - Remote control mode: The system controller is used as a remote controller. (Setting from the system controller can be prohibited by prohibiting local operation from another central control unit.)
- B. Controlled unit number mode: All mode or zone 1, 2, 3, 4 mode can be selected
 - All mode: All, zone, or group unit can be selected.
 - Zone 1, 2, 3, 4 mode: Setting is possible only for the indoor units of zone 1, 2, 3, or 4.

Connection example		A Operation mode	
		Central control mode	Remote control mode
B Controlled unit number mode	All mode	All central control. Example 1	All remote control
	Zone 1 mode	Zone 1 central control. Example 2	Zone 1 remote control
	Zone 2 mode	Zone 2 central control. Example 3	Zone 2 remote control. Example 3
	Zone 3 mode	Zone 3 central control. Example 4	Zone 3 remote control
	Zone 4 mode	Zone 4 central control	Zone 4 remote control. Example 5

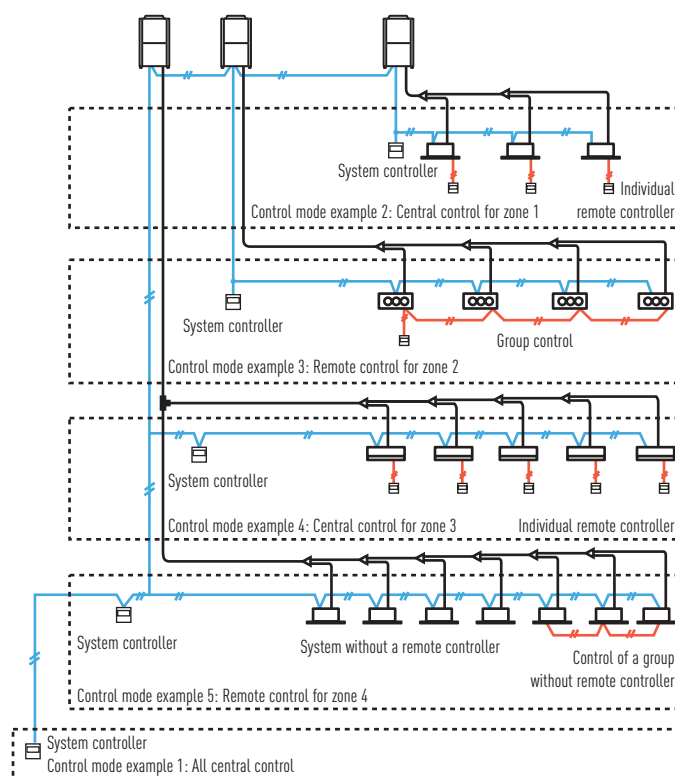

Centralised Control Systems

Intelligent controller (CZ-256ESMC2)



TOUCH PANEL

Web application



System Configuration Example

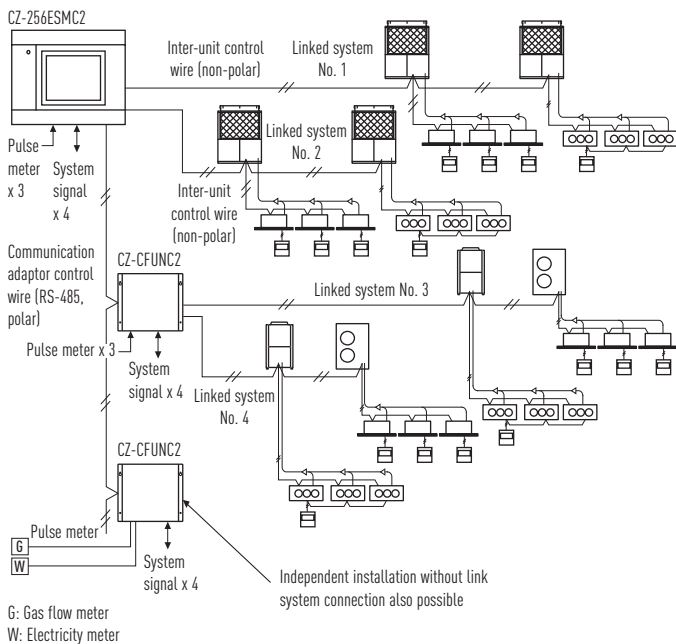

Maximum number of connections	Indoor units: 256 (64/link x 4)
	Outdoor units: 120 (30/link x 4)
	Communication adaptors: 7
	Link systems (Inter-unit control wires): 4

Limitation contents for prohibited operation

Prohibition means limiting the operations possible from the remote controller. It is also possible to change the prohibition items.

Limitation contents (Limitations can be user defined)

- Individual No limits are set for the remote controller operation. However, the contents will be changed to the controller's last settings. (Last-pressed priority.)
- Prohibition 1 The remote controller cannot be used for ON/OFF. (All other operations are possible from the remote controller.)
- Prohibition 2 The remote controller cannot be used for ON/OFF, operation mode change and temperature setting. (All other operations are possible from the remote controller.)
- Prohibition 3 The remote controller cannot be used for operation mode change and temperature setting. (All other operations are possible from the remote controller.)
- Prohibition 4 The remote controller cannot be used for operation mode change. (All other operations are possible from the remote controller.)

Note: Avoid joint use of the AMY system and the intelligent controller on the same indoor/ outdoor operation line.

- Max. 256 indoor units (4 systems x 64 units) can be controlled. In case of three or more systems, a communication adaptor CZ-CFUNC2 must be installed on the outside
- Operation is possible as batch, in zone units, in tenant and in group units
- ON/OFF, operation mode setting, temperature setting, fan speed setting, air flow direction setting (when used without a remote controller), and remote controller local operation prohibition (prohibition 1, 2, 3, 4)
- A system without a remote controller is possible. Joint use with a remote controller or a system controller is also possible
- Use of a schedule timer and holiday setting also can be done
- Proportional distribution of the air conditioning energy is possible. Including CSV-file export via CF-card (supplementary accessory)
- Pulse signal input from electric/gas consumption meter

In case of joint use with a wireless remote control system, there are limitations for the control mode. Please use only with "Permission" and "Prohibition 1".

Dimensions (H x W x D): 240 x 280 x 138mm.

Power supply: AC 100 to 240 V (50 Hz), 30 W (separate power supply).

I/O part: Remote in put (voltage-free contact): All ON/OFF.

Remote output (voltage-free contact): All ON, All alarm (external power supply within DC 30 V, 0.5 A).

Total wiring length: 1 km for each system.

Only for embedding in the panel.

CZ-CBPCC2: Additional back up memory for CZ-256ESMC2.

Web Interface (CZ-CWEBC2)

Functions

- Access and operation by Web browser.
- Icon display.
- Language codes available in English, French, German, Italian, Portuguese, Spanish.
- Individual control possible (max. 64 indoor units) ON/OFF operation mode, set temperature, fan speed, Flap set, timer ON/OFF alarm code monitoring, prohibit Remote Control.
- Zone control*.
- All Units control.
- Alarm Log.
- Mail Sent Log.
- Program Timer set 50 daily timers with 50 actions each day, 50 weekly timers 50 weekly timers, 1 holiday timer, 5 special day timers, for each tenant
- Prohibit Remote Control settings.
- IP ADDRESS could be changed via Internet.



(HxWxD): 248x185x80mm
AC 100 to 240 V (50/60Hz), 17 W
(Separate power supply)

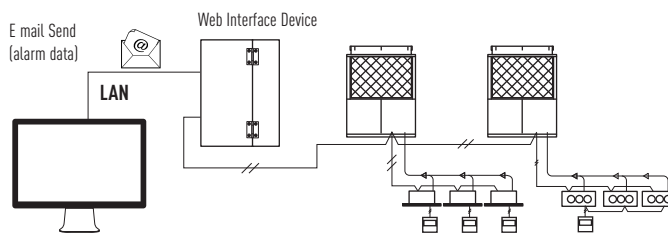

Note: It is recommended to install a remote controller or a system controller on site to enable local control if it network experience a problem.

Easy to set to every room by recognizable icon and user-friendly remote control window

- If any of the indoor units is selected, the remote control window shown will be displayed for detailed setting modifications.

Easy to manage and monitor each tenant use*

- Each floor or tenant, otherwise each zone can be displayed and controlled.
- All unit statuses can also be displayed on one screen.

Program Timer set

- 50 daily timers with 50 actions each day, 50 weekly timers, holiday timer, 5 special day timers, for each tenant.

* Web interface system not applicable for load distribution.

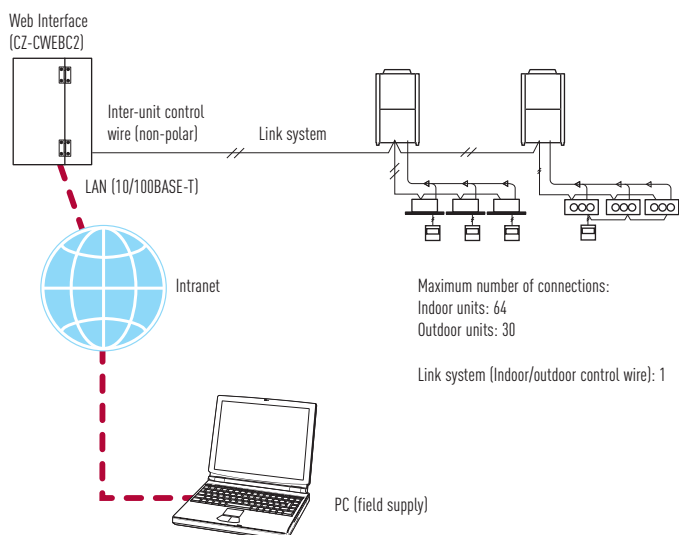

Functions

- Access and operation by Web browser.
- Icon display.
- Language codes available in English, French, German, Italian, Portuguese, Spanish.
- Individual control possible (max. 64 indoor units) ON/OFF operation mode, set temperature, fan speed, Flap set, timer ON/OFF alarm code monitoring, prohibit Remote Control.
- Each Tenant (Zone) control.
- All Units control.
- Alarm Log.
- Mail Sent Log.
- Program Timer set 50 daily timers with 50 actions each day, 50 weekly timers 50 weekly timers, 1 holiday timer, 5 special day timers, for each tenant.
- Prohibit Remote Control settings.
- IP Address could be changed via Internet.

Note: it is recommended to install a remote controller or a system controller on site to enable local control if IT network experience a problem.

Centralised Control Systems

Seri-Para I/O unit for outdoor unit (CZ-CAPDC2 for ECOi / CZ-CAPDC3 for Mini ECOi and PACi)



- This unit can control up to 4 outdoor units.
- From the central control device, mode changing and batch operation/batch stop are possible.
- Required for demand control.

Dimensions (H x W x D): 80 x 290 x 260mm.
 Power supply: Single Phase 100/200V (50/60Hz), 18W.
 Input: Batch operation/Batch stop (non-voltage contact/DC 24 V, pulse signal). Cooling/Heating (non-voltage contact/static signal). Demand 1/2 (non-voltage contact/static signal) (Local stop by switching)
 Output: Operation output (non-voltage contact).
 Alarm output (non-voltage contact)

Wiring length: Indoor/Outdoor operation lines: Total length 1 km. Digital signal: 100 m or shorter

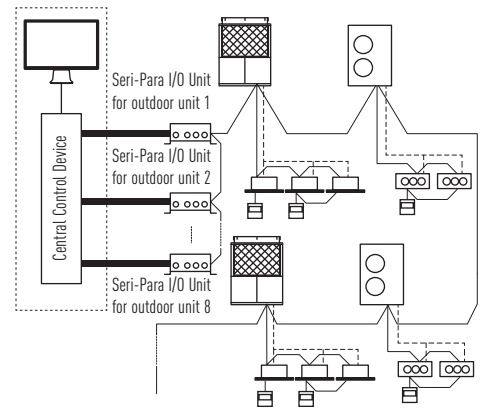

Local adaptor for ON/OFF control (CZ-CAPC2)



- Control and status monitoring is possible for individual indoor unit (or any external electrical device up to 250 V AC, 10 A) by contact signal.

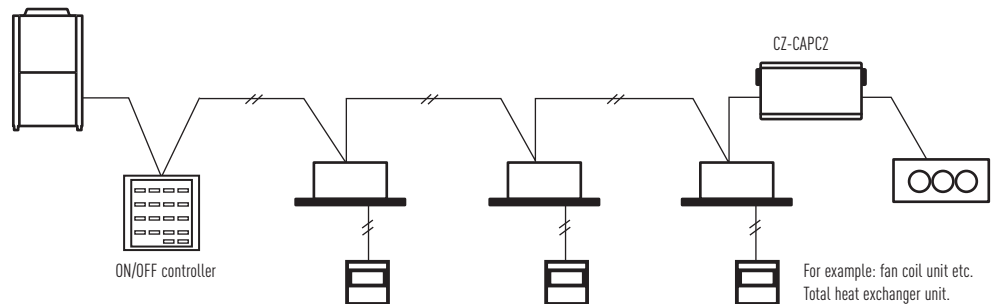

Demand Control 0 -10 V (CZ-CAPBC2)



- Control and status monitoring is possible for individual indoor unit (1 group).
- In addition to operation and stop, there is a digital input function for air speed and operation mode.
- Temperature setting and measuring of the indoor suction temperature can be performed from central monitoring.
- The analog input for demand of the outdoor capacity by 20 steps (from 40% to 120%) by 0-10V.
- The analog input for temperature setting is 0 to 10 V, or 0 to 140 Ohm.
- Power is supplied from the CZ-T10 terminal of the indoor units.
- Separate power supply also is possible (in case of suction temperature measuring).

* Ask to your distributor.

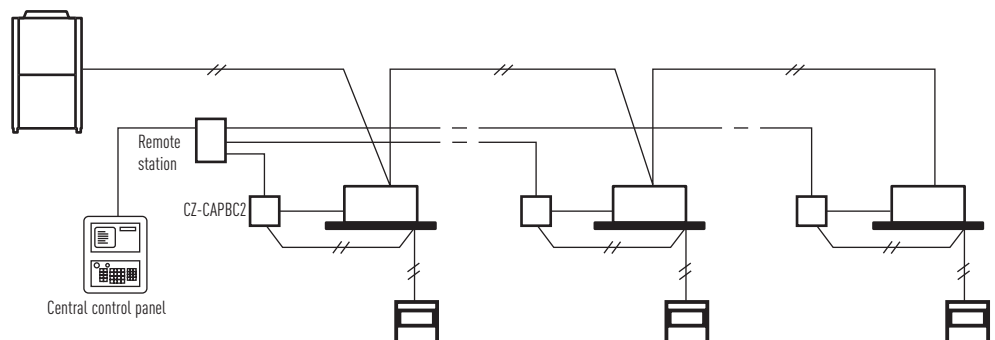

P-AIMS. Panasonic Total Air Conditioning Management System

P-AIMS Basic software / CZ-CSWKC2

Up to 1024 indoor units can be controlled by one PC.

Functions of basic software

- Standard remote control for all indoor units.
- Many timer schedule programs can be set on the calendar.
- Detailed information display for alarms.
- CSV file output with alarm history, operating status.
- Automatic data backup to HDD.



With 4 upgrade packages the basic software can be upgraded to suit individual requirements

P-AIMS is suitable for large shopping centers and universities with many areas/ buildings. 1 "P-AIMS" PC can have 4 independent systems at once. Each system can have max. 8 C/A units, and control max. 512 units. In total, 1024 indoor units can be controlled by 1 "P-AIMS" PC.

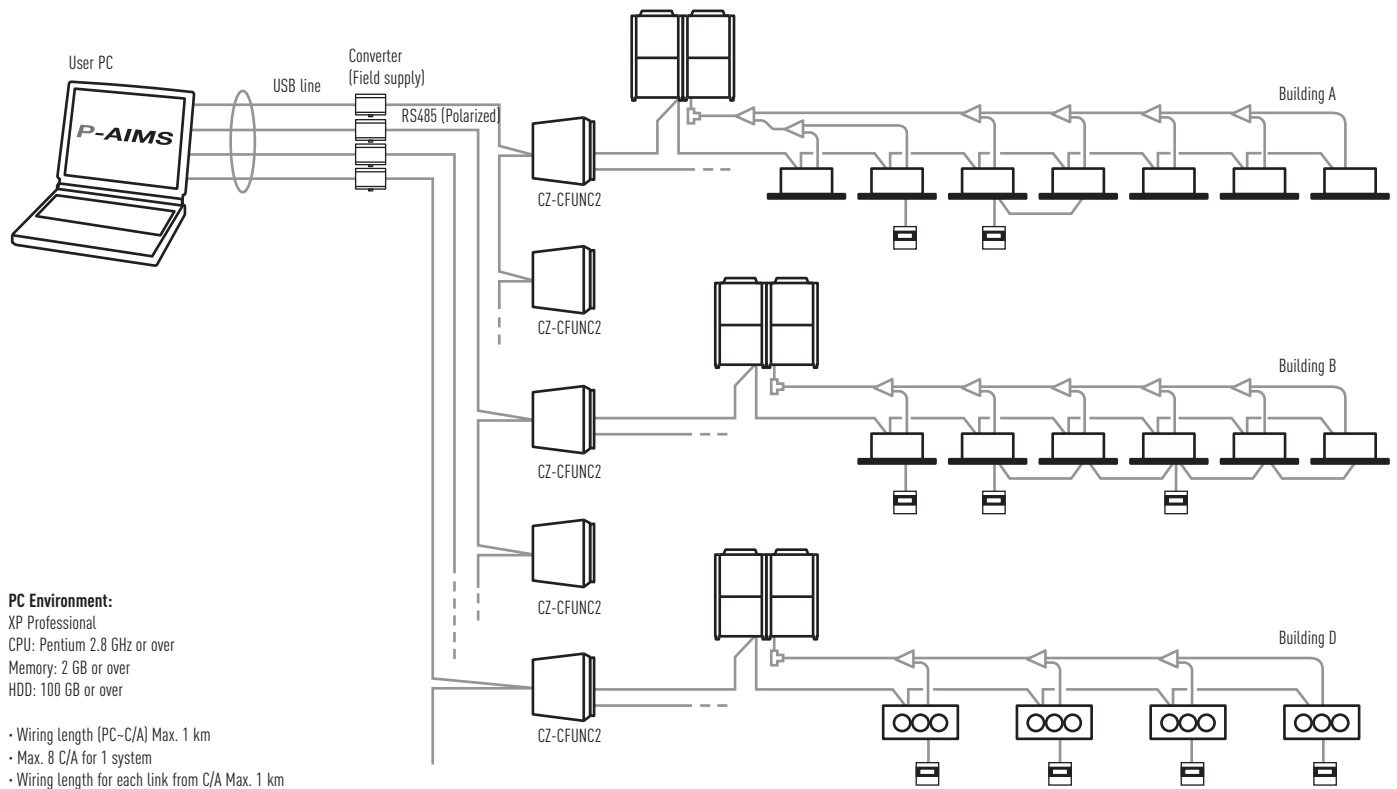

P-AIMS optional software CZ-CSWAC2 for Load distribution

Load distribution calculation for each tenant

- Air-conditioner load distribution ratio is calculated for each unit (tenant) with used energy consumption data (m³, kWh).
- Calculated data is stored as a CSV type file.
- Data from the last 365 days is stored.

P-AIMS optional software CZ-CSWWC2 for Web application

Web access & control from remote station

- Accessing P-AIMS software from remote PC.
- You can monitor/operate ECOi 6N system by using Web browser (Internet Explorer).

P-AIMS optional software CZ-CSWGC2 for Object layout display

Whole system can be controlled visually

- Operating status monitor is available on the layout display.
- Object's layout and indoor unit's location can be checked at once.
- Each unit can be controlled by virtual remote controller on the display.
- Max. 4 layout screens are shown at once.

P-AIMS optional software CZ-CSWBC2 for BACnet software interface

Connectable to BMS system

- Can communicate with other equipment by BACnet protocol.
- ECOi 6N system can be controlled by both BMS and P-AIMS.
- Max. 255 indoor units can be connected to 1 PC (that has P-AIMS basic & BACnet software).

Centralised Control Systems



Centralised Control Systems

A custom web application to manage the centralized operation of A2W and GHP systems.

Operation and monitoring of devices connected to the new Management System can be realized both remotely/locally from any device with connection to the internet (Laptop, Tablet, Mobile)

The new system will make the interaction with air conditioning systems easier, improving the operation set as well as the global control of installations.

The application will act with various units, regardless of whether they are available in the same intranet or in different locations, transparently to users at any time. In this way, our solution allows to overcome main restrictions like onsite maintenance or the lack of centralization.

In addition, the application offers significant improvements in terms of control:

- Aircon units can be grouped in a totally custom way
- Possibility to realize group commands and batch commands (in succession)
- Alarms and events can be controlled more efficiently and a lot more...

Features of current system

Operation Functions

- Start & Stop
- Temperature settings
- Operation mode selection
- Fan speed, Fan direction settings
- Prohibition of use of remote controller

Operation Monitoring

- Monitoring of operation status and alarms
- Monitoring of filter cleaning signs
- Display of alarm logs

Program Timers

- Up to 50 types of weekly timer
- Holiday and Special Days

Offer reliable solution to improve existing functionalities

- Running timer
- Remote control through Web Cloud Application or local. Accessible anytime, anywhere, via a device with internet connection
- Centralized Control: Manage several installations in one single interface. Ideal for multi-site organizations
- Easy monitoring and maintenance thanks to group commands, and batch commands. Easy supervision of complex installations
- Secure Remote Access. Powerful identity protection and convenient access control

Current installation

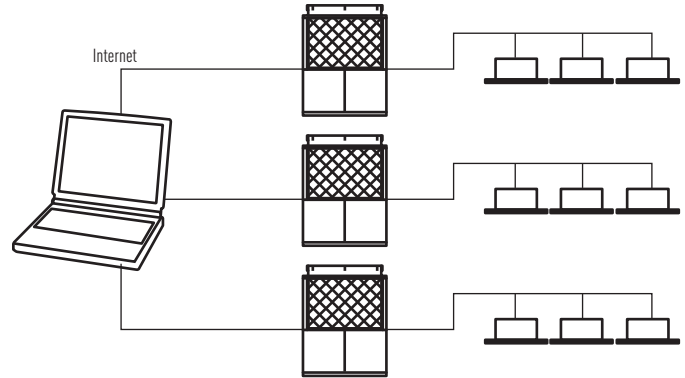

Main restrictions: Decentralization: need to connect to every CZ-WEB one by one to manage installation.
On-site maintenance: Access limited to local network.

Benefits

The new solution for the centralized control of air conditioning systems offers significant benefits for the different actors involved in its management:

For the building Ownership:

- Maximum equipment performance
- Energy saving
- Increased lifetime of equipment
- Savings in maintenance costs

For Maintenance companies:

- Instant knowledge of any incident
- Possibility of preventive alarms
- Reduction of systematic visits (warning and remote control)
- More effective maintenance support

PACi and VRF Control

Aware of the importance of both control and connectivity in offering the best comfort at the lowest price, Panasonic offers its customers cutting-edge technology, specially designed to ensure our air conditioning systems deliver maximum performance. You can properly manage the air conditioning and perform comprehensive monitoring and control, with all of the features the remote control provides, from anywhere in the world thanks to the internet applications Panasonic has created for you.



Internet Control

Control your air conditioning system with your smart device -smartphone & internet for PACi and VRF Systems



What's Internet Control?

Internet Control is a next generation system providing user-friendly remote control of air conditioning or heat pump units, using a simple Android or iOS smartphone, tablet or PC via internet.

Simple Installation

Just connect the Internet Control device to the air conditioner or heat pump with the supplied wire and then link it to your WIFI Access point.

Internet Control. Easy to install. Maximum benefit

Internet Control is underlined with the slogan "Your home in the cloud", meaning a simple and easy to handle solution has been considered for every user to manage the device, not requiring any communication or computer skills.

No servers. No adaptors. No wires. Just a small box is needed to be connected and placed close to the air conditioning indoor unit... and your smartphone, tablet or PC.

Your existing WiFi connection does the rest when you are at home. Start the App from your smartphone device, your tablet or your computer, and enjoy a new experience in comfort. And if you are out of home, just launch the App, and manage the air conditioning of your home from the cloud. An intuitive and user-friendly application on the screen of your smartphone or PC that lets you manage the air conditioning unit in the same way you do with the remote controller at home.

Internet Control can be downloaded in Apple's AppStore and Android's PlayStore.

Control your air conditioning with the smart internet control device via smartphones, tablet, PC and smart desktop phone via internet

Offering the same functions as if you were at home or office: start/stop, Mode Operation, Set Temperature, Room Temperature etc as well as the new, advanced functionality provided by Internet Control to achieve the best comfort and efficiency with the lowest energy consumption.



Case Study. Paul, Business Man

"My business is growing but I still want to feel like I'm in control. So I carry out all the arrangements, transactions and operations I can from my mobile. From bank transactions, processing orders, to controlling the temperature at the company's different plants; I do everything from my smartphone thanks to IntesisHome and Panasonic."



Case Study. Alice, Shop Owner

"I want maximum comfort and the best savings for my shop. And I manage to get these in the easiest and most natural way possible. From my smartphone, something I always carry with me, I can control the temperature of my shop and in this way, as well as maintaining an ideal temperature I also save a small fortune in electricity at the end of the year."



KX-UT670 Smart Desktop Phone from Panasonic.

PACi and VRF Connectivity

Panasonic Partners have designed solutions specifically for Panasonic air conditioners, and provide complete monitoring, control and full functionality of the entire Commercial line-up from KNX / Modbus / LonWorks / BACnet installations.



PACi Connectivity

Easy connection to KNX, Modbus, LonWorks and BACnet

Great flexibility for integration into your KNX / Modbus / LonWorks / BACnet projects allows fully bi-directional monitoring and control of all the functioning parameters.

For more information, contact Panasonic.

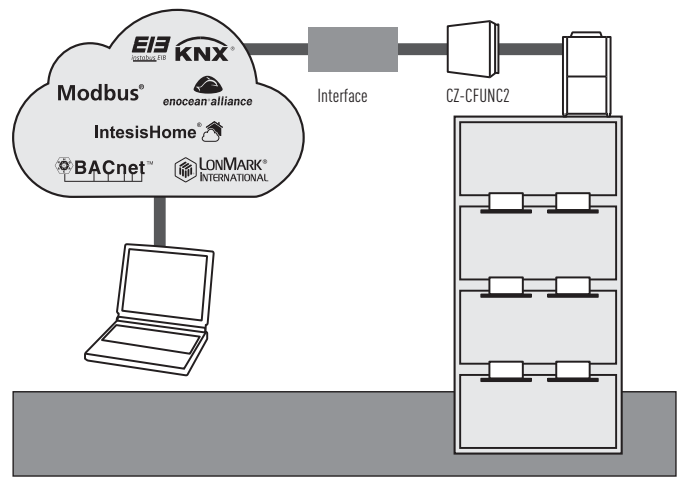

Communication adaptor for VRF Connectivity (CZ-CFUNC2)

This communication interface is required to connect a ECOi and GHP systems to a BMS. An additional interface is needed to convert the information into KNX/Modbus/Bacnet language. CZ-CFUNC2 is very easy to operate and to connect to the Panasonic P-link, which is the ECOi bus. From the CZ-CFUNC2, all the indoor and outdoor units of the installation can be easily control. Two linked wiring systems can be connected to one CZ-CFUNC2.

Dimensions: H 260 x W 200 x D 68mm

* As this is not a splash-proof design, it must be installed indoors or in the control panel, etc.

Airzone. Control of the PACi Hide Aways

Airzone has developed interfaces to easily connect to Panasonic PACi Hide Away units. Ensuring optimum performance, comfort and energy savings, the new system is efficient and easy to install.



Airzone full range of accessories for any duct project

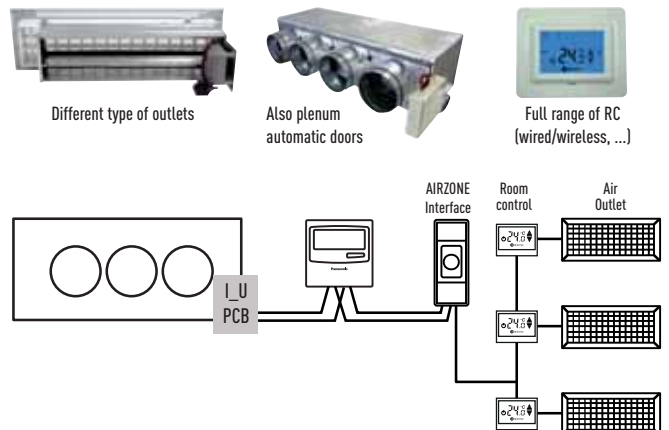

Easy control by BMS

CONNECTIVITY



ECOi and GHP Connectivity

New Plug and play interface connected directly to the P-Link

The interface has been designed specifically for Panasonic and provides complete monitoring, control and full functionality of the line-up from IntesisHome, KNX, EnOcean, Modbus, BacNet and Lonworks installations. This connectivity solution is made by a third party company, please contact Panasonic for more information.

	Panasonic model name	Interface	Connected on P-link or in the indoor unit	Maximum number of indoor units connected
ECOi / PACi	PAW-RC2-KNX-1i	KNX	Indoor unit	1 (1 Group of Indoor units)
Indoor Units	PAW-RC2-MBS-1	Modbus RTU*	Indoor unit	1 (1 Group of Indoor units)
	PAW-RC2-ENO-1i	EnOcean	Indoor unit	1 (1 Group of Indoor units)
	PA-RC2-WIFI-1	IntesisHome	Indoor unit	1 (1 Group of Indoor units)
ECOi P-Link	PAW-AC-KNX-64	KNX**	P-link	64
	PAW-AC-KNX-128	KNX**	P-link	128
	PAW-TM-MBS-RTU-64	Modbus RTU**	P-link	64
	PAW-TM-MBS-TCP-128	Modbus TCP**	P-link	128
	PAW-AC-BAC-64	Bacnet**	P-link	64
	PAW-AC-BAC-128	Bacnet**	P-link	128
	CZ-CLNC2	Lonworks	P-link	16 groupes of max. 8 indoor units, in total max. 64 indoor units

* Interface Modbus RTU/TCP is needed in case if Modbus TCP connection. PAW-MBS-TCP2RTU (Modbus RTU Slave devices).
 ** Interface CZ-CFUNC2 needed.

Example of BMS connection for air conditioner central control system

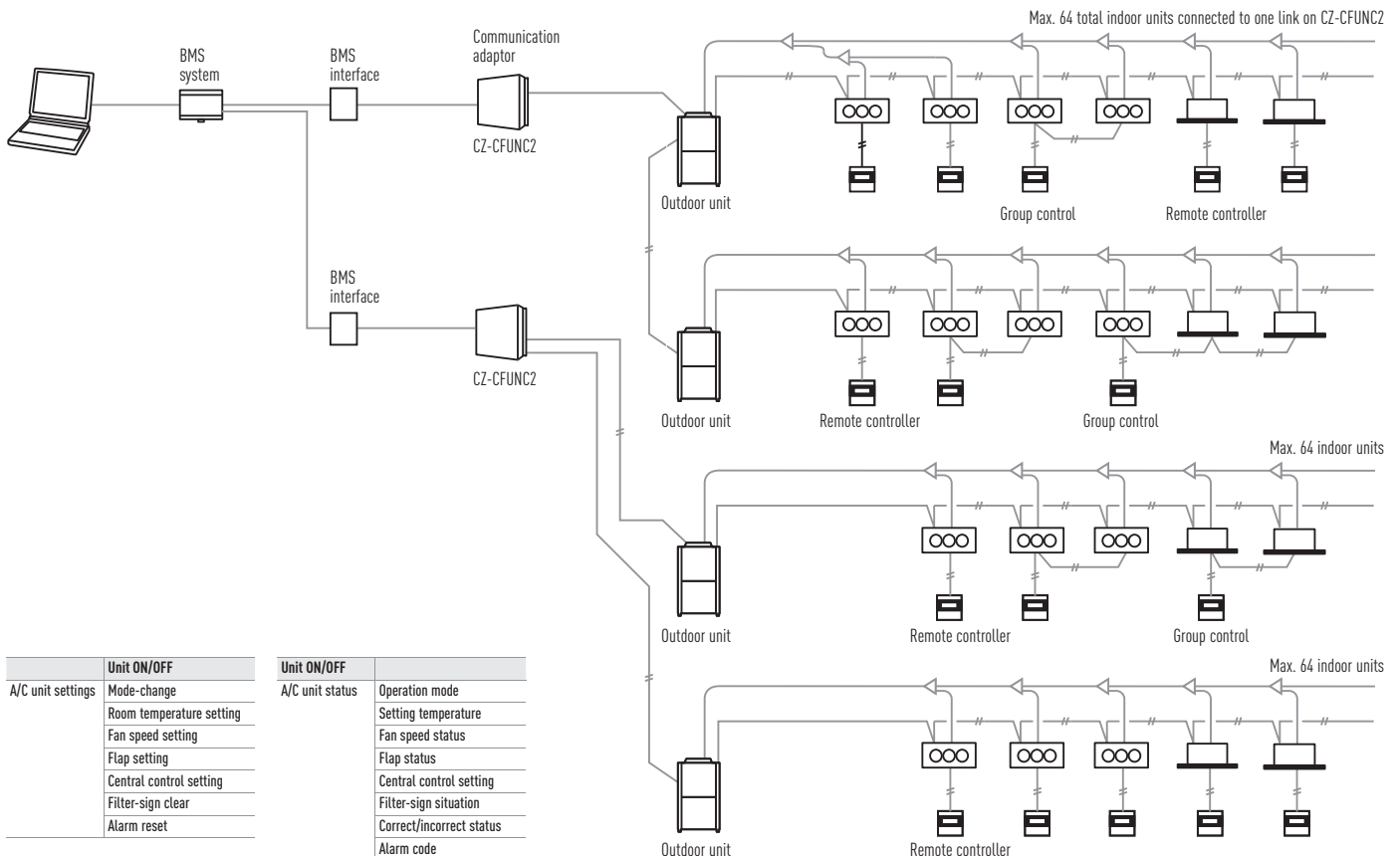

A/C unit settings	Unit ON/OFF	A/C unit status	Unit ON/OFF
	Mode-change		Operation mode
	Room temperature setting		Setting temperature
	Fan speed setting		Fan speed status
	Flap setting		Flap status
	Central control setting		Central control setting
	Filter-sign clear		Filter-sign situation
	Alarm reset		Correct/incorrect status
			Alarm code

ECOi, ECO G and PACi Connectivity indoor units

PCB's and cables for ECOi, ECO G and PACi indoor units		
Name of the cables	Function	Comment
CZ-T10	All T10 functions	Requires field supplied accessory
PAW-FDC	Operate external fan	Requires field supplied accessory
PAW-OCT	All option monitoring signals	Requires field supplied accessory
CZ-CAPE2	Option monitoring signals wo. fan	Requires additional wires from spare part supply
PAW-EXCT	Forced Thermo OFF/Leakage D.	Requires field supplied accessory
Name of the PBC	Function	Comment
PAW-T10	All T10 functions	Allows easy connection "Plug & Play"
PAW-T10V	All T10 functions + powermonitoring	Same like PAW-T10 + monitoring the power supply of indoor unit
PAW-T10H	ON/OFF; Prohibit 5VDC & 230VAC	Specials for single hotel card or window contact
PAW-T10HW	ON/OFF; Prohibit 5VDC	For hotel card + window contact at same time
PAW-PACR3	Redundancy of 2 or 3 systems; for ECOi and PACi	Redundancy of 2 or 3 ECOi or PACi systems including temperature monitoring, error indication, backup, alternative run
PAW-SERVER-PKEA	Redundancy of 2 units PKEA	Redundancy of 2 units PKEA including temperature monitoring, error indication, backup, alternative run

T10 connector (CN015)

CZ-T10: Panasonic has developed an optional accessory (consisting of plug + wires) called CZ-T10 to enable an easy connection to this T10 connector.



Connecting an ECOi indoor unit to an external device is easy. The T10 terminal featured in the electronic circuit board of all indoor units enables digital connection to external devices.

Example of applications



T10 terminal Specification (T10: CN015 at indoor unit PCB)

- Control items: 1. Start/stop input
- 2. Remote controller prohibit input
- 3. Start signal output
- 4. Alarm signal output

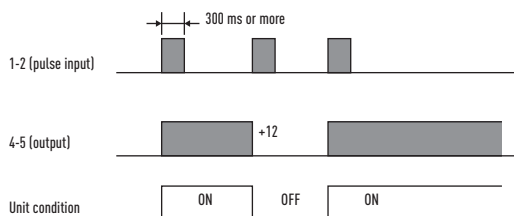

NOTE: The wire length from indoor unit to the Relay must be within 2.0 m. Pulse signal changeable to static with JP cutting. (Refer to JP001)

Condition

- 1-2 (Pulse input): Unit ON/OFF condition switching with a pulse signal. (1 pulse signal: shortage status more than 300 msec. or more)
- 2-3 (Static input): Open / Operation with Remote is permitted. (Normal condition) Close / Remote controller is prohibited.
- 4-5 (Static output): 12 V output during the unit ON. / No output at OFF.
- 4-5-6 (Static output): 12 V output when some errors occur / No output at normal.

Example of wiring

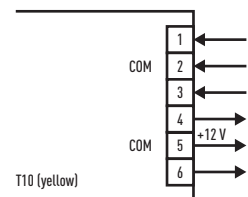

Usage Example

Forced OFF control

Term 1 & 2: Free contact for ON/OFF signal (cut *JP1* for static signal) when the hotel card is it connected the contact must be close (the unit can be used).

Term 2 & 3: Free contact to prohibit all function in the remote controller install in the room when the hotel card is it removed the contact must be closed (the unit can not work).

Terminal = T10

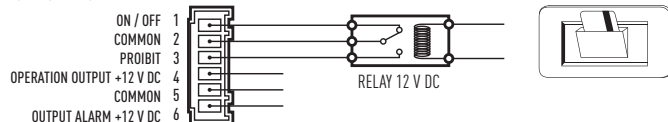

Operation ON/OFF signal output

Condition:

- 4-5 (Static output): 12 V output during the unit ON / No output at OFF

Example of wiring

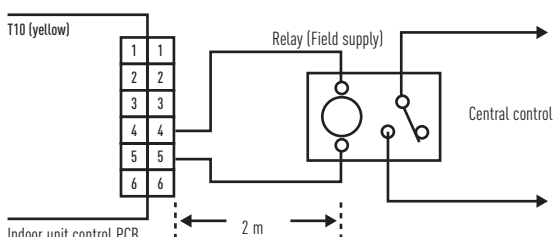

NOTE: The wire length from indoor unit to the Relay must be within 2.0 m. Pulse signal changeable to static with JP cutting. (Refer to JP001)

Fan Drive Connector (CN032)

PAW-FDC: Panasonic has developed an optional accessory (consisting of plug + wires) called PAW-FDC to enable an easy connection to this Fan Drive Connector (CN032).



Operating the ventilation fan from the remote controller

- Start / stop of external ventilation and total heat exchanger fans
- Works even if indoor unit is stopped
- In case of group control → all fans will operate; no individual control

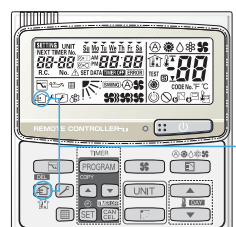

External fan On / Off

Ventilation button

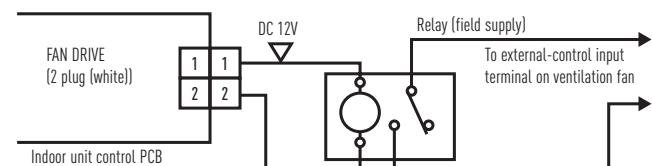

Option Connector (CN060) Output external signals



PAW-OCT: Panasonic has developed an optional accessory (consisting of plug + wires) called PAW-OCT to enable an easy connection to this Option Connector (CN060).

With the combination of the T10 and the option CN060 an external control of the I_U is possible!

6P (white): Outputs external signals as shown in the figure below.

Relay (DC 12V, field supply) (Note)

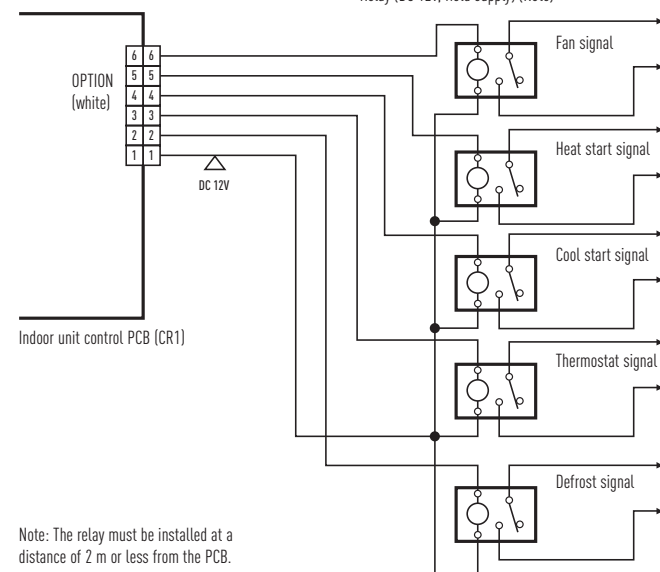

EXCT Connector (CN009)

PAW-EXCT: Panasonic has developed an optional accessory (consisting of plug + wires) called PAW-EXCT to enable an easy connection to this EXCT Connector (CN009).

A) With static input

→ STATIC INPUT → THERMO OFF → ENERGY SAVING

2P plug (red): Can be used for demand control. When input is present, forces the unit to operate with the thermostat OFF.

Note: The length of the wiring from the indoor unit control PCB to the relay must be 2m or less.
* Lead wire with 2P plug (special—order part: WIRE K/854 05280 75300)

• Examples of wiring:

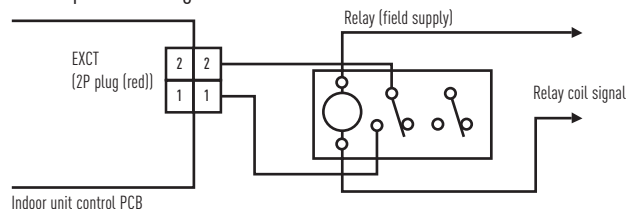

B) Example: In connection with a refrigerant sensor

- Signal from leakage detector: non voltage, static.
- Indoor unit setting: Code 0b → 1
- Connector for leak detector: EXCT
- Outdoor unit setting:
 - Code C1 → 1 power output if alarm from O2 connector 230 V
 - Code C1 → 2 power output if alarm from O2 connector 0 V
- Displayed alarm message P14

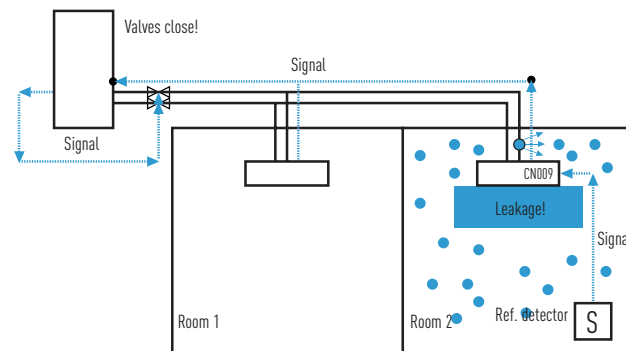





Panasonic

www.aircon.panasonic.co.uk

Due to the ongoing innovation of our products, the specifications of this catalogue are valid bearing typographic errors, and may be subject to minor modifications by the manufacturer without prior warning in order to improve the product. The total or partial reproduction of this catalogue is prohibited without the express authorisation of Panasonic Marketing Europe GmbH.

Panasonic®

To find out how Panasonic cares for you,
log on to: www.aircon.panasonic.co.uk

Contact Details:
Telephone: 01344 853182
uk-aircon@eu.panasonic.com

Address: Panasonic Air Conditioning
Panasonic House
Willoughby Road
Bracknell
Berkshire
RG12 8FP



Do not add or replace refrigerant other than the specified type. Manufacturer is not responsible for the damage and deterioration in safety due to usage of the other refrigerant.
The outdoor units in this catalogue contains fluorinated greenhouse gases with a GWP higher than 150.

