

NEW PRODUCTS 2019 – 2020

THE WORLD OF HEATING AND COOLING IS CHANGING WITH PANASONIC

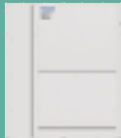

heating & cooling solutions

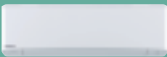

AQUAREA

Aquarea Air to Water Heat Pump Range.

Aquarea is a ground breaking low energy system for heating and domestic hot water production: delivering outstanding performance, even at extreme outdoor temperatures.

New Aquarea R32.

In the way of offering a more environmentally friendly choice for heating installations, Aquarea is available during 2019 in R32. This pure refrigerant has lower GWP than currently used R410A. Making Aquarea excellent choice for those who really care the environment. Aquarea J Series, this new generation is newly designed to work with R32.



New Aquarea J Generation.

This new generation designed for R32 refrigerant include many other improvements. Such as high piping range, chiller function cooling down to 10C, DHW COP up to 3,3, improved back up heater function for real bivalent function, SG Ready and PV function for cooling, heating curve can be set up down to -20C, water pump speed can be set up fixed of auto, magnet filter, efficient or comfort mode for DHW, and other improvements to bring more value and makes easier installation.

Aquarea Smart Cloud for professionals.

Aquarea Smart Cloud will activate remote maintenance service while end user is controlling and monitoring its heating and DHW remotely. This remote maintenance will save time, installation visits by connecting Aquarea to a powerful cloud infrastructure. Remote checker, remote error codes, remote set up functions... all this will be possible by installers with CZ-TAW1 and end user acceptance.



New advanced cascade control.

Advanced Cascade Control that manages up to 10 Aquarea Heat Pumps. Up to 3 M-BUS devices connectable for heat or current meter, demand PV functions, control 3 way valves, Modbus IP for BMS communication, DHW logic, easy to set up and control with touch display built in.

New accessories for Aquarea.

Aquarea Heat Pumps have available a wide list of high valuable accessories. Such as high class tanks, Combo Tanks, Fan Coils, interfaces, and other accessories that will ensure the high performance of the heating solution.

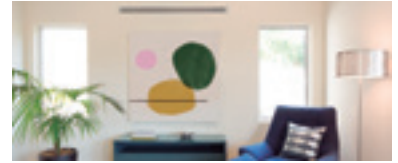

DOMESTIC

Domestic Range.

Panasonic has developed a range of domestic products designed for you and your clients.

R32 full domestic range.

All Domestic has transformed to R32 with excellent performance. Panasonic has not just fully adapted to new refrigerant, the new units has been design to maximize the advantages of new refrigerant from Wall, to Cassette, Hide Away, Floor Console and Multi Split Systems.



Etherea stylish and outstanding features.

Highest energy class A+++ in both heating and cooling, purifies the air with advance purifying nanoe™ X system with impermeable 19dB(A). New Etherea VKE is equipped with built-in WLAN for internet control and monitoring, by using Panasonic Comfort Cloud App.



Purifying air we breathe.

Panasonic systems are equipping different technologies to purify and clean the air. Anti allergy nanoe™ X and PM2,5 filters are some examples to take care of the air we breathe.



Stylish Floor Console.

The R32 Floor Console has been designed for European market from Scratch. Floor Consoles purifies the air with nanoe™ X, quiet operation, high efficiency, new design control remote and accurate design are its attributes.

Floor Console awarded with the prestigious IF Design Award 2019.

Panasonic Comfort Cloud control.

Panasonic Comfort Cloud control, with completely new user interface and controlling all domestic functions.



COMMERCIAL

Commercial Range.

The commercial range is constantly expanding so that you can always offer your clients the optimal solutions: high performance, silent machines and a complete range of ducts, cassettes and ceiling installations.

Panasonic PACi R32 up to 25,00kW.

R32 PACi range helps to find more environmental friendly solutions in commercial applications. This pure refrigerant also increase the efficiency of the system. Panasonic PACi R32 covers all ranges from 3,60 up to 25,00kW, the low GWP solution for retail.

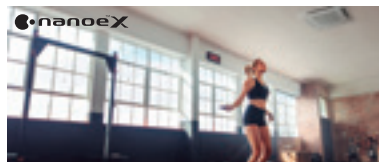

nanoe™ X purifies air with PACi 90x90 Cassette.

Thanks to advances in design and technology such as the new high performance turbo fan, which is more efficient and silent, the nanoe™ X air cleaner which provides healthy air, the floor temperature and humidity sensor that give more control, the new PU2 Panasonic 90 x 90 4 way Cassette provides a high-class solution for energy savings, healthy environment and comfort.

Wall design wall type PK2 Series.

Commercial air conditioning and aesthetics find a new ally in with PK2 series. Following same shape as design award Etherea, PK2 series will combine with any indoor design.



Server room solutions.

Choose the best solution to ensure any server room needs. Designed for high durability and adverse weather conditions its server room ad hoc control ensure permanent operation and failure alarms communications.

Control CZ-RTC5B with datanavi.

Ready to control 2 PACi systems with backup and alternate operation.

New PACi WLAN Interface.

New Panasonic interface CZ-CAPWFC1 allows to connect one indoor unit or a group of indoor units to be managed by Panasonic Comfort Cloud App, for control, monitor, schedule and error code alerts. This advanced smartphone control gives more possibility for your comfort life.



VRF

VRF Systems.

The VRF industrial range considerably improves efficiency so even large buildings can benefit from a high-level of comfort with less energy consumption.

VRF Systems ECOi EX.

A VRF System delivering energy-saving performance, powerful operation, reliability and comfort surpassing anything previously possible. It represents a true paradigm shift in air conditioning solutions.



Mini ECOi LE Series.

The Mini ECOi combines smartly compact body with high specifications. It delivers high levels of energy-saving, powerful operation, reliability and comfort.

2-Pipe ECO G GE3 Series.

"L" type heat exchanger and new inverter DC fan motor with a 3-blade propeller to improve energy efficiency through about 30% reduction in electrical power consumption.



VRF Smart Connectivity.

Panasonic's VRF Smart Connectivity is a completely new, state-of-the-art solution providing energy saving and comfort as well as simple installation, operation and running.

Panasonic AC Smart Cloud.

Centralised control of your business premises, from wherever 24/7. Smartly control, maintain, optimise and save.



INDEX



EDITORIAL

- 6 A DESIRE TO CREATE THINGS OF VALUE
- 8 A GLOBALLY TRUSTED AIR CONDITIONING BRAND
- 10 100% PANASONIC, THE DNA OF JAPANESE CRAFTSMANSHIP
- 12 PANASONIC: ECO & SMART IDEAS FOR A SUSTAINABLE LIFESTYLE
- 14 PROJECTS & CASE STUDIES OF PANASONIC HEATING AND COOLING SOLUTIONS
- 16 PRO CLUB. THE PROFESSIONAL WEBSITE OF PANASONIC
- 17 AQUAREA DESIGNER
- 18 WELCOME TO AQUAREA AIR TO WATER HEAT PUMP



Quality Management System Certificate



Certified to ISO 9001: 2008
Panasonic Appliances Air-Conditioning
Malaysia Sdn.Bhd.
Cert. No.: MY-AR 1010



Certified to ISO 9001: 2008
Panasonic Appliances Air-Conditioning
(GuangZhou) Co., Ltd.
Registration Number: 01209Q20645R5L

Environmental Management System Certificate



Certified to ISO 14001: 2004
Panasonic Appliances Air-Conditioning
Malaysia Sdn.Bhd.
Cert. No.: MY-ER0112



Certified to ISO 14001: 2004
Panasonic Appliances Air-Conditioning
(GuangZhou) Co., Ltd.
Registration Number: 02110E10562R4L



AQUAREA

- 20 HIGHLIGHTED FEATURES
- 22 HOW DO YOU GET HEATING AND DOMESTIC HOT WATER FROM AIR?
- 24 AQUAREA HEAT PUMP LINE-UP
- 26 AQUAREA J GENERATION A+++ FROM SEPTEMBER 2019
- 28 AQUAREA H GENERATION A+++
- 30 AQUAREA HIGH PERFORMANCE
- 32 AQUAREA T-CAP
- 34 AQUAREA HT
- 36 AQUAREA COMMERCIAL
- 38 AQUAREA SMART AND SERVICE CLOUD
- 40 CONTROL AND CONNECTIVITY
- 41 AQUAREA + PV PANELS
- 42 PANASONIC'S AQUAREA OFFERS THE BEST FOR YOU AND YOUR HOME
- 44 AQUAREA HEAT PUMPS LINE-UP
- 46 NEW AQUAREA HIGH PERFORMANCE ALL IN ONE J GENERATION SINGLE PHASE. HEATING AND COOLING 1 OR 2 ZONES • R32 GAS
- 47 NEW AQUAREA HIGH PERFORMANCE BI-BLOC J GENERATION SINGLE PHASE. HEATING AND COOLING - SDC • R32 GAS
- 48 AQUAREA HIGH PERFORMANCE ALL IN ONE H GENERATION SINGLE PHASE. HEATING AND COOLING 1 OR 2 ZONES • R410A GAS
- 49 AQUAREA HIGH PERFORMANCE ALL IN ONE H GENERATION SINGLE PHASE / THREE PHASE. HEATING AND COOLING • R410A GAS
- 50 AQUAREA T-CAP ALL IN ONE H GENERATION SINGLE PHASE / THREE PHASE. HEATING AND COOLING • R410A GAS
- 51 AQUAREA T-CAP ALL IN ONE H GENERATION THREE PHASE. SUPER QUIET OUTDOOR UNIT. HEATING AND COOLING • R410A GAS
- 52 AQUAREA HIGH PERFORMANCE BI-BLOC H GENERATION SINGLE PHASE. HEATING AND COOLING - SDC • R410A GAS
- 53 AQUAREA HIGH PERFORMANCE BI-BLOC H GENERATION SINGLE PHASE / THREE PHASE. HEATING AND COOLING - SDC • R410A GAS
- 54 AQUAREA T-CAP BI-BLOC H GENERATION SINGLE PHASE / THREE PHASE. HEATING AND COOLING - SXC • R410A GAS
- 55 AQUAREA T-CAP BI-BLOC H GENERATION THREE PHASE. SUPER QUIET OUTDOOR UNIT. HEATING AND COOLING - SDC • R410A GAS
- 56 AQUAREA HIGH PERFORMANCE MONO-BLOC H GENERATION SINGLE PHASE. HEATING AND COOLING - MDC • R410A GAS
- 57 AQUAREA T-CAP MONO-BLOC H GENERATION SINGLE PHASE / THREE PHASE. HEATING AND COOLING - MXC • R410A GAS
- 58 AQUAREA HT BI-BLOC F GENERATION SINGLE PHASE / THREE PHASE. HEATING ONLY - SHF • R407C GAS
- 59 AQUAREA HT MONO-BLOC G GENERATION SINGLE PHASE. HEATING ONLY - MHF • R407C GAS
- 60 AQUAREA AIR
- 61 FAN COILS
- 62 DHW STAND ALONE
- 64 SANITARY TANKS
- 66 ACCESSORIES AND CONTROL
- 68 HEATING & COOLING CAPACITY TABLES. BASED ON OUTLET TEMPERATURE AND OUTSIDE TEMPERATURE
- 77 EXAMPLES OF INSTALLATIONS



DOMESTIC

- 78 WELCOME TO DOMESTIC RANGE
- 80 HIGHLIGHTED FEATURES
- 82 R32 REFRIGERANT GAS
- 84 ETHEREA STYLISH AND OUTSTANDING FEATURES
- 86 HEATCHARGE. ENERGY CHARGE SYSTEM
- 88 WALL MOUNTED TZ COMPACT STYLE
- 90 FLOOR CONSOLE. EFFICIENT COMFORT AND CLEAN AIR ALL YEAR ROUND
- 92 NANO™ X. QUALITY AIR FOR LIFE
- 94 PANASONIC R2 ROTARY COMPRESSOR
- 96 R22 RENEWAL
- 98 NEW PANASONIC COMFORT CLOUD
- 99 CONTROL AND CONNECTIVITY
- 100 DOMESTIC AIR CONDITIONER RANGE R32
- 102 WALL MOUNTED HEATCHARGE VZ INVERTER+ • R32 GAS
- 103 NEW WALL MOUNTED ETHEREA INVERTER+ SILVER / PURE WHITE MATT • R32 GAS
- 104 WALL MOUNTED TZ COMPACT STYLE INVERTER • R32 GAS
- 105 WALL MOUNTED FZ TYPE STANDARD INVERTER • R32 GAS
- 106 WALL MOUNTED PROFESSIONAL INVERTER -20°C • R32 GAS
- 107 FLOOR CONSOLE TYPE INVERTER+ • R32 GAS
- 108 4 WAY 60X60 CASSETTE INVERTER • R32 GAS
- 109 LOW STATIC PRESSURE HIDE AWAY INVERTER • R32 GAS
- 110 MULTI SPLIT AND FREE MULTI SYSTEM
- 115 FEATURE COMPARISON
- 116 FEATURES EXPLAINED
- 117 ACCESSORIES AND CONTROL
- 118 FREE MULTI R32 COMBINATIONS TABLE



COMMERCIAL

- 136 PANASONIC COMMERCIAL AIR TO AIR
- 138 HIGHLIGHTED FEATURES
- 140 PACi OUTDOOR UNITS ENERGY SAVING CONCEPT
- 142 PACi ELITE: EXCELLENT SEER AND SCOP VALUES
- 144 SOLUTIONS FOR 24/7/365 APPLICATIONS
- 146 GENERATION PACi 90x90 CASSETTE
- 148 RANGE OF COMMERCIAL UNITS R32
- 150 WALL MOUNTED PROFESSIONAL INVERTER+ -20°C • R32 GAS
- 152 PACi ELITE WALL MOUNTED INVERTER+ • R32 GAS
- 154 PACi STANDARD WALL MOUNTED INVERTER+ • R32 GAS
- 156 PACi ELITE AND STANDARD 4 WAY 60x60 CASSETTE INVERTER+ • R32 GAS
- 158 PACi ELITE 4 WAY 90x90 CASSETTE INVERTER+ • R32 GAS
- 160 PACi STANDARD 4 WAY 90x90 CASSETTE INVERTER+ • R32 GAS
- 162 PACi ELITE CEILING INVERTER+ • R32 GAS
- 164 PACi STANDARD CEILING INVERTER+ • R32 GAS
- 166 PACi ELITE HIGH STATIC PRESSURE HIDE AWAY INVERTER+ • R32 GAS
- 168 PACi STANDARD HIGH STATIC PRESSURE HIDE AWAY INVERTER+ • R32 GAS
- 170 PACi ELITE LOW STATIC PRESSURE HIDE AWAY INVERTER+ • R32 GAS
- 172 PACi STANDARD LOW STATIC PRESSURE HIDE AWAY INVERTER+ • R32 GAS
- 174 NEW PANASONIC BIG PACi SERIES R32
- 175 NEW BIG PACi HIGH STATIC PRESSURE HIDE AWAY 20,00-25,00kW INVERTER+ • R32 GAS
- 176 PACi SINGLE, TWIN, TRIPLE AND DOUBLE-TWIN SYSTEM
- 182 NEW PRO-HT TANK SERIES FOR PACi AND ECOi
- 186 NEW WHE FOR PACi
- 188 PANASONIC VENTILATION SOLUTIONS
- 189 ELECTRIC AIR CURTAIN
- 190 AIR HANDLING UNIT KIT 10-25kW FOR PACi
- 191 AIR CURTAIN WITH DX COIL, CONNECTED TO THE VRF OR PACi SYSTEMS
- 192 COMPATIBLE WITH R32 OR R410A OUTDOOR UNITS
- 194 PANASONIC PACi ELITE CAN COOL ROOMS DOWN TO 8°C
- 196 R22 RENEWAL FAST, EASY TO INSTALL AND COST EFFECTIVE
- 200 ACCESSORIES & CONTROL



VRF SYSTEMS

- 202 INDUSTRIAL VRF SYSTEMS
- 204 VRF HIGHLIGHTED FEATURES
- 206 PANASONIC: DELIVERING TOP ENERGY EFFICIENCIES FOR MANY YEARS
- 208 PANASONIC VRF: TOP IN COMFORT
- 210 SOLUTIONS FOR RESTAURANTS
- 212 YOUR ENTIRE HOTEL WITH SUPERIOR COMFORT, CONTROL AND SAVINGS TOO
- 214 INNOVATIVE SOLUTIONS FOR RETAIL
- 216 RANGE OF VRF OUTDOOR UNITS
- 218 BEST EFFICIENCY ECOi SERIES FROM PANASONIC**
- 220 MINI ECOi LE SERIES FOR LIGHT COMMERCIAL & RESIDENTIAL USE
- 226 ECOi EX THE GAME CHANGER
- 232 2-PIPE ECOi EX ME2 SERIES
- 242 3-PIPE ECOi EX MF3 SERIES
- 248 ECO G, THE GAS DRIVEN VRF**
- 252 ECO G 3 SERIES
- 254 2-PIPE ECO G GE3 SERIES
- 256 3-PIPE ECO G GF3 SERIES
- 258 PANASONIC GHP/EHP HYBRID SYSTEM
- 262 WATER HEAT EXCHANGER FOR HYDRONIC APPLICATIONS
- 266 LEAK DETECTION AND AUTOMATIC REFRIGERANT PUMP DOWN
- 267 DESIGN SUPPORT SOFTWARE FOR VRF
- 268 NEW VRF SYSTEMS INDOOR UNITS
- 270 ECOi AND ECO G SYSTEMS INDOOR UNITS RANGE
- 272 4 WAY 90x90 CASSETTE WITH NANO™ X
- 273 U2 TYPE 4 WAY 90x90 CASSETTE
- 274 Y2 TYPE 4 WAY 60x60 CASSETTE
- 275 L1 TYPE 2 WAY CASSETTE
- 276 D1 TYPE 1 WAY CASSETTE
- 277 F2 TYPE VARIABLE STATIC PRESSURE HIDE AWAY
- 278 M1 TYPE SLIM VARIABLE STATIC PRESSURE HIDE AWAY CONCEALED DUCT
- 279 E2 TYPE HIGH STATIC PRESSURE HIDE AWAY
- 280 HEAT RECOVERY WITH DX COIL
- 281 T2 TYPE CEILING
- 282 NEW VRF FLOOR CONSOLE
- 283 NEW G1 TYPE FLOOR CONSOLE
- 284 K2 TYPE WALL MOUNTED
- 285 P1 TYPE FLOOR STANDING
- 286 R1 TYPE CONCEALED FLOOR STANDING
- 287 HYDROKIT FOR ECOi WATER AT 45°C
- 288 NEW PRO-HT TANK SERIES FOR PACi AND ECOi
- 290 AQUAREA AIR
- 291 FAN COILS
- 292 PANASONIC VENTILATION SOLUTIONS
- 294 AHU CONNECTION KIT 16, 28 AND 56kW FOR ECOi AND ECO G
- 296 AIR CURTAIN WITH DX COIL, CONNECTED TO THE VRF OR PACi SYSTEMS
- 298 ENERGY RECOVERY VENTILATION
- 300 HEAT RECOVERY WITH DX COIL
- 302 DIMENSIONS AND TUBE SIZES OF BRANCHES AND HEADERS
- 306 ACCESSORIES & CONTROL



CONTROL AND CONNECTIVITY

- 308 CONTROL AND CONNECTIVITY
- 310 VRF SMART CONNECTIVITY+
- 316 PANASONIC AC SMART CLOUD
- 318 NEW COMMERCIAL WLAN ADAPTER
- 320 NEW ECOi AND ECO G BMS INTERFACE WITH P-LINK
- 322 REMOTE CONTROLLER WITH ECONAVI
- 324 DATANAVI
- 326 ECONAVI SENSOR
- 328 INTELLIGENT CONTROLLER
- 330 CONTROL FOR HOTEL APPLICATION
- 332 CONTROL AND CONNECTIVITY
- 334 INDIVIDUAL CONTROLLERS
- 336 CENTRALISED CONTROLLERS
- 340 PACi AND VRF CONTROL AND CONNECTIVITY
- 342 ECOi, ECO G AND PACi CONNECTIVITY INDOOR UNITS

344 DIMENSIONS

A DESIRE TO CREATE THINGS OF VALUE

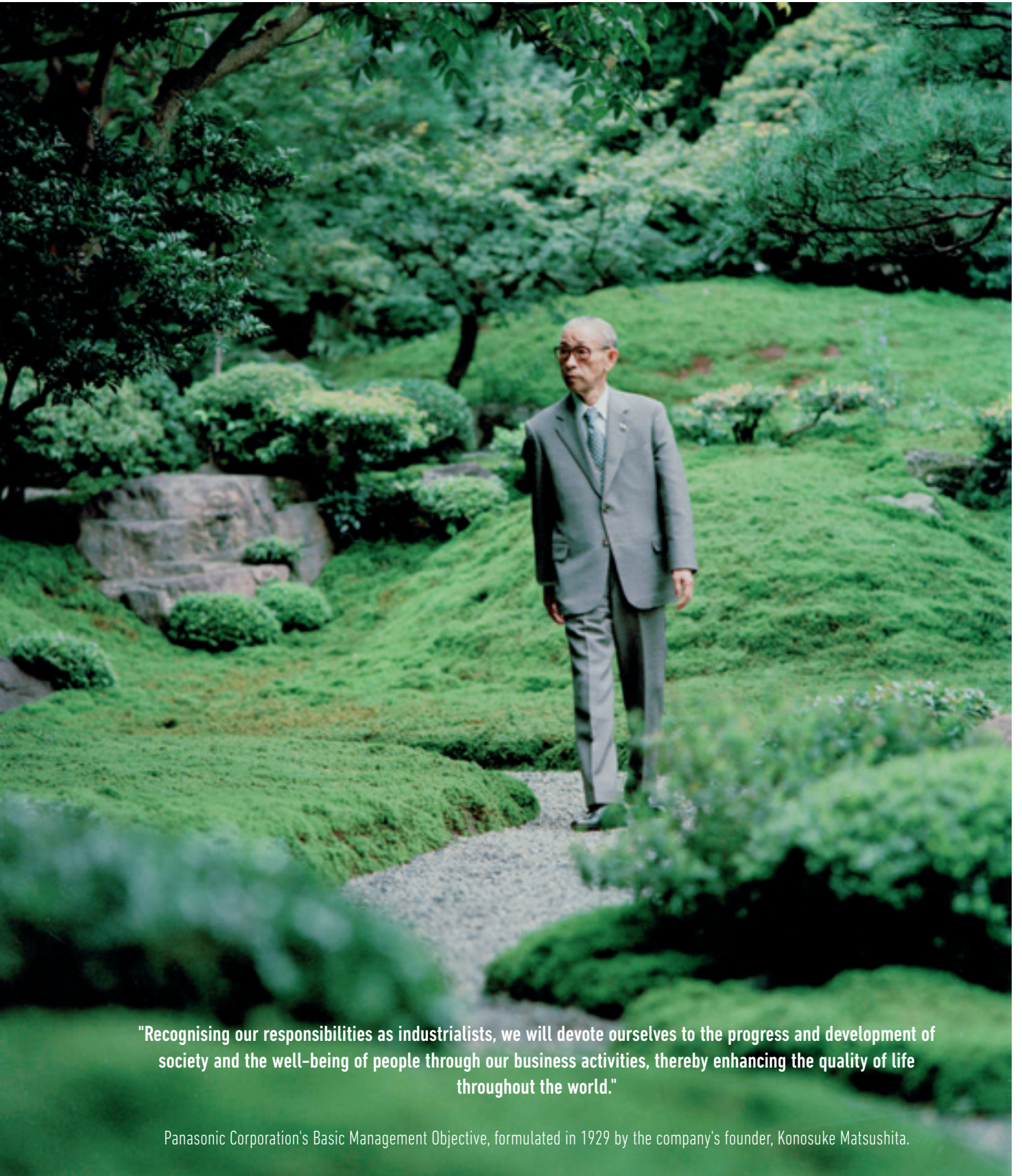

"Recognising our responsibilities as industrialists, we will devote ourselves to the progress and development of society and the well-being of people through our business activities, thereby enhancing the quality of life throughout the world."

Panasonic Corporation's Basic Management Objective, formulated in 1929 by the company's founder, Konosuke Matsushita.

Panasonic: celebrating two major milestones in 2018.



Panasonic Corporation, 100th anniversary

Look ahead to the “Future,” keep taking on challenges. Starting back in 1918, Panasonic has constantly added to its guarantee for innovation, taking tomorrow’s technologies and applying them to today’s needs.

Always making “people” central to our activities, and thereby focusing on “people’s lives,” we will continue to provide better living for our customers. This is the unchanging commitment we at Panasonic have had over many years.

Now, we are aiming to expand our contribution to “better living” everywhere. This means that in the variety of spaces where our customers go about their lives, ranging from inside the home, the office, the store, the automobile, and the airplane, as well as in the town, we will provide not only single pieces of hardware, but also total solutions including software and services. We will pursue the concept of “A Better Life, A Better World,” meeting the needs of each individual customer.

To that end, we will leverage the strengths that we at Panasonic have long developed in our consumer electronics business, together with the strengths of our business partners who have in-depth expertise in many areas, and we will work to combine these strengths by pursuing “Cross-Value Innovation.” In this way, we will create new value. This is the new and challenging task we are now addressing.



Panasonic Heating and Cooling, 60th anniversary

Panasonic starts with a desire to create things of value. Sixty years ago, as hard work and dedication results in one innovative product after another, the new company took its first steps towards becoming the electronics giant of today. Heating and Cooling Solutions designed and produced by Panasonic since 1958.



1971

Starts production of absorption chillers.

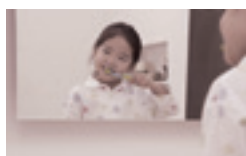

1973

Panasonic launches the first highly efficient air-to-water heat pump in Japan.



1975

Panasonic becomes the first Japanese air conditioner manufacturer in Europe.



1985

Introduces first GHP (gas heat pump) VRF air conditioner.



1989

Introduces world's first simultaneous 3-Pipe heating/cooling VRF System.



2008

Etherea new concept: high efficiency and high performances with a great design.



2010

New Aquarea. Panasonic introduces Aquarea, an innovative new, low-energy system in Europe.



2012

New GHP units. Panasonic's gas-driven VRF Systems are ideal for projects where power restrictions apply.



2016

New VRF Systems ECOi EX with extraordinary energy-saving performance.



Looking ahead

The first Hybrid System with VRF and GHP in Europe.

A GLOBALLY TRUSTED AIR CONDITIONING BRAND



Committed to ambitious expansion plans, Panasonic starts production of air conditioning units in Plzen in the Czech Republic.

Panasonic – leading the way in Heating and Cooling.
 With more than 50 years of experience, selling to more than 120 countries around the world, Panasonic is one of the leaders in the heating and cooling sector.

With a diverse network of production and R&D facilities, Panasonic delivers innovative products incorporating cutting-edge technologies that set the standard for air conditioners worldwide. Expanding globally, Panasonic provides superior international products transcending borders.



100% Panasonic: we control the process

The company is also a world leader in innovation as it has filed more than 91,539 patents to improve its customers' lives. Moreover, Panasonic is determined to remain at the forefront of its market. In all, the company has produced more than 200 million compressors and its products are manufactured in 294 plants which are located all over the world. You can be assured of the extremely high quality of Panasonic's heat pumps. This wish to excel has made Panasonic a leading company in heating and turn-key air conditioning solutions. These offer maximum effectiveness, comply with all environmental standards and meet the most avant-garde construction requirements of our time.

Constantly Improving

At Panasonic, we know that the best is always yet to come. This is why our air conditioning and heat pump solutions are constantly upgraded. Panasonic is committed to offering our customers innovative products in the heating and cooling market across Europe, and has the ambition to not only meet but also exceed their requirements. Our Technology & Design teams anticipate the needs of tomorrow. We look to produce smaller, quieter, efficient solutions - with better technological features - that can reduce energy consumption while providing suitable temperature conditions for the user.

40 years of experienced organization in Europe

The partner for all Europe.

- Full European coverage and integrated organization
- One voice for European Agreements
- Availability and delivery anywhere in Europe
- Specification team to support project design throughout Europe
- European Service Network

Trained professionals.

- 20 Training centres in 13 countries
- More than 5000 professionals trained every year. Innovation and manufacture in Europe

R&D Department designs solutions for different European needs.

- New factory set up in Czech Republic
- Design software made in Europe for Europe

More than Cooling, Heating and Refrigeration Solutions.

- Security, communication solutions, advanced digital signage technology, access control solutions, displays...



100% PANASONIC, THE DNA OF
JAPANESE CRAFTSMANSHIP

**JAPAN
QUALITY**



Applying advanced technologies that truly make life better, we live by an unparalleled commitment to product quality.

Panasonic is building on the Japanese tradition of uncompromising quality control worldwide, developing and manufacturing fine products and delivering them to customers everywhere.

At Panasonic, we believe that the best air conditioner is one that works quietly and effectively in the background whilst minimising its impact on the environment

People who use our products can look forward to long years of high-quality performance without the need for constant service. As part of our rigorous design and development process, Panasonic air conditioners undergo a variety of stringent tests to ensure their effectiveness and long-term reliability. Tests for durability, waterproofing, shock resistance, and noise are conducted on component parts or on the finished products themselves. As a result of all of these time consuming efforts, Panasonic air conditioners meet industrial standards and regulations in every country where they are sold.

International Standard Quality

To uphold the company's reputation around the world, Panasonic strives continuously to offer quality with minimized environmental impact.



Reliable parts that meet or exceed industrial standards.

In every country where they are sold, Panasonic air conditioners comply with all required industrial standards and regulations. In addition, Panasonic conducts stringent testing to ensure the reliability of parts and materials. The strength of the resin material used in a propeller fan is confirmed by a tension test.



Compliance with RoHS / REACH substance restrictions.

Panasonic products and used materials strictly comply with chemical substance restrictions as defined by RoHS or REACH. During the development and production of parts, stringent inspections are conducted on over 100 materials to ensure that no hazardous substances are included.



Sophisticated production process.

Panasonic's air conditioner production lines employ state-of-the-art factory automation technologies to ensure products are manufactured with high attention to quality to meet expectations of reliability and trustworthiness.

Durability

At Panasonic we know the importance of a long service life with minimal maintenance. That's why we subject our air conditioners to a wide range of stringent durability tests.



Long-term durability test.

To ensure durability and stable operation for many years, we conduct a long-term continuous operation test under conditions that are much more severe than actual operating conditions.



Compressor reliability test.

After the continuous operation test, we remove the compressor from a selected outdoor unit, disassemble it, and examine the internal mechanisms and parts for potential failure. This helps ensure reliable long-term performance under harsh conditions.

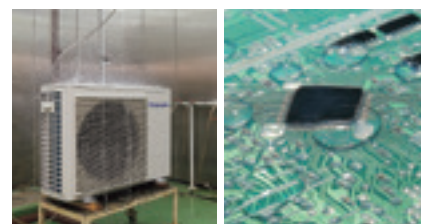

Waterproofing test.

The unit - which is subject to rain and wind - complies with IPX4 waterproof specifications. Contact sections on printed circuit boards are resin-potted to prevent adverse effects caused by exposure to water (an unlikely occurrence).

PANASONIC: ECO & SMART IDEAS FOR A SUSTAINABLE LIFESTYLE



A better life, a better world.
Panasonic is creating a safe and
secure society with clean energy.



www.future-living-berlin.com

**FUTURE LIVING®
BERLIN**



Smart City Quarter Berlin

A European Lighthouse Project for Smart Home & Connected Life. Future Living® Berlin.

The building project Future Living® Berlin is a future model for interconnected urban district. Seit 2013 GSW Sigmaringen and Unternehmensgruppe Krebs are developing a model for future living – based on their long term expertise in real estate business and in cooperation with leading international technology companies. In spring 2019 first residents will move into the new quarter.

Future Living® Berlin is making use of the increasing possibility to interconnect products and services. Based on this chance smart and intelligent solutions for future living as well for the single apartments as for the quarter are developed. These solutions are enabling residents to use online services in their intelligent housing environment. Based on these opportunities a concept of living for daily routine is developed offering residents comfort, security and time saving.

A special enhancement of Future Living® Berlin is the pre-configuration for different apartments by experts that enable residents to move into a "ready to go" apartment and be directly supported in their daily routines in an intelligent way. By using one central app or native language single apartments can be steered, adopted and individually expanded by future smart products.

Cross-linkage of products and technologies provides all residents with a simple access for an exclusive community care sharing in the residential

quarter which is, of course, based on e-mobility and part of an holistic energy concept containing photo-voltaic systems and battery storage. Cooperating with leading technology companies as project partners a continuous and technological progression is guaranteed in the future. Including residents and learning from their usage data participating partner a ready and enabled to improve the offered solutions pointedly further more.

Beside Future Living® Homes there is Future Living® Dialog offering extensive information and use cases for the general public. The project with it's innovative aims is also representing for sustainability and social solutions. Affordable rental and ancillary rental costs result in apartments available for many target groups.

Future Living® Berlin is aiming for conceptional and architectural answers for some of the big challenges of our society as demographical changes, energy turnaround and changing mobility manners. With it's comprehensive solution approach it is unique in Europe.

**Demographic change, energy revolution and mobility change.
We offer solutions for the challenges of our time.**

PROJECTS & CASE STUDIES OF PANASONIC HEATING AND COOLING SOLUTIONS



New Hotel Monument 5*GL is located in an 1896 palace.
Barcelona, Spain. ECOi and E-Control

Panasonic, a partner with the knowledge and experience to achieve your objectives and green needs.

Integrated technology that permits better work, easy installation, high efficiency performance, and energy savings

Our main targets are the distributed services and B2B-integrated solutions.

Panasonic provides a single point of contact for the design and maintenance of your system, making things easy for you.

Given our experience in processes, technologies and complex business models, we can offer you effective solutions that reduce costs, whilst also being efficient, user-friendly, reliable and innovative. Another advantage we offer to our clients is a support service for systems integration projects, which we provide through our wide range of services and solutions.

As a global company, we have at our disposal the financial, logistical and technical resources to develop complex and wide-ranging solutions, both at country and international level by implementing them both on-time and on-budget.



Passive house in Tychowo near Stargard Szczecinski, Poland. **Aquarea**



The new Hotel Vincci Gala with efficiency class A, up to 70% save energy. Barcelona, Spain. **ECOi - ECO G**



New IKEA "Click and Collect" store in city centre. Birmingham, UK. **ECOi - ECO G**



21 of the 5-6 bedroom luxury homes in Straffan Co.Kildare, Ireland. **Aquarea**



Andalucia Technology Park. Offices of high energetic efficiency. Spain. **ECOi**



The latest glamorous Burger & Lobster restaurant in Bath. UK. **Aquarea**



Madrid's new hotel Only You Atocha. The hotel has 206 rooms distributed over seven floors. **ECO G**



Lo + Fit Galapagar Gym. Madrid, Spain. **VRF, PACi, AHU**



Marina Village Greystones. 205 apartments and 153 houses. Ireland. **Aquarea**



The Hat, a modern hostel in Madrid. Spain. **ECO G**



Zalando's solution for its warehouse office conversion at Grand Canal Quay, Dublin. **ECOi**



Lock Building, offices for media giant Viacom. Camden, London, UK. **ECOi**

PRO CLUB. THE PROFESSIONAL WEBSITE OF PANASONIC



Panasonic PRO Club (www.panasonicproclub.com) is the online tool which makes your life easier! You just have to register and a lot of functionalities are freely available to you, where ever you are, from your computer or smart phone!

- Print catalogues with your logo and your address
- Download the latest Aquarea designer to define your system and select the good Aquarea Heat pump.
- Calculate the specs of the Aquarea Air fan coil based on the parameters of your system
- Get Documents of conformity and all other documents you may need
- Download all the service manuals, end user manuals and installation manuals
- Know what to do with error codes
- Find out about the latest news first
- Register for training

Highlighted Features.

- Extensive library of resources
- Tools & Apps for end users. Check availability in your country:
 - My Home: sizing wizard for domestic and Air to Water range
 - My Project: Contact form to Panasonic team
 - iFinder: Lists of installers displayed by postcode
- Special offers & promotions
- Training PRO Academy

- Catalogues (Commercial documentation)
- Marketing (Images in high resolution, advertisements, deco guidelines)
- Tools (Professional software, sizing tools...)
- Installers customize leaflets in PDF format with their logo & contact details
- Energy label generator. Download energy labels of any device in PDF format
- Heating calculator
- Noise calculator for outdoor unit
- Aquarea Radiator calculator
- Error Code Search by error code or unit ref. Compatible with smartphone and tablet computer
- Revit / CAD Images / Spec texts
- Access to Pananet, online library of technical documentation
- Download Documents of Conformity and other Certifications
- Commissioning online

Panasonic PRO Club is fully compatible with tablet computer and smartphone.

Panasonic has an impressive range of support services for designers, specifiers, engineers and distributors working in the heating and cooling markets.



Easy download Panasonic service documentation and brochures



Customise leaflets with your logo & contact details. Save and print the PDF



Energy label generator. Download Energy Labels of any device in PDF format



Error Code on your smartphone and your PC: Search by error code or model reference. Online version + downloadable version for offline use

AQUAREA DESIGNER



This program allows HVAC designers, installers and distributors to identify the correct heat pump for a particular application from Panasonic's Aquarea range, calculate the savings compared to other heat sources and very quickly calculate CO₂ emissions.

Using Panasonic's Aquarea Designer, projects can be developed simply and easily, by either using the Quick Design or Expert Design options. Each allows the user to build up the project data in a simple step-by-step process and choose to output reports (in either Quick or Large formats) as HTML files or as print-outs. To create these useful reports, project data is input, including:

- Heated area
- Heating requirement
- Heating flow and return temperatures
- Climate data (from a simple drop-down menu) including outdoor temperature
- Type of hot water tank, storage capacity and hot water target temperature

Panasonic provides bespoke software helping system designers, installers and dealers to very quickly design and size systems, create wiring diagrams and issue bills of quantities at the push of a button.



Aquarea Designer also means saving

Aquarea Designer will calculate the project's energy costs in terms of hot water, heating and pumping. It will show the equipment running times and calculate the COP (coefficient of performance). It then allows the designer to show clients a comparison with other equipment options such as heating by conventional gas-fired boilers, oil systems, wood, standard electric heating and electric night storage heaters. This compares running costs, initial investment costs and maintenance costs. The comparison can also be made for CO₂ emissions and savings.

The Panasonic PRO Academy

Panasonic takes its responsibility to its distributors, specifiers and installers seriously and has developed a comprehensive Training Programme. The Panasonic Pro-Academy encompasses the traditional hands-on approach to teaching.

New training courses cover three levels. Design, installation, and commissioning & trouble-shooting. Training courses include:

- Domestic applications Air to Air
- Aquarea air source heat pumps
- VRF ECOi

The courses are offered on site at Panasonic's premises across Europe. The Training Centres display Panasonic's latest product range and give delegates an opportunity to get a hands-on experience with the latest controllers, indoor and outdoor units from the VRF ECOi, Etherea, GHP and Aquarea ranges.



Download on
www.panasonicproclub.com
 or connect simply with your
 smartphone to the PRO Club
 using this QR



WELCOME TO AQUAREA AIR TO
WATER HEAT PUMP



Aquarea's Air to Water Heat Pump for residential and commercial applications. Offering capacities from 3kW all the way through to 16kW, the Aquarea Heat Pump Range is the widest on the market, ensuring a system is available, whatever your heating and cooling needs. Suitable for new build and refurbishment projects, the solutions are cost-effective with minimised environmental impact.

HIGHLIGHTED FEATURES



**GOOD
DESIGN
AWARD
2017**

The Good Design Award is among the most prestigious awards for product design excellence. Winning this award has underscored the outstanding performance and energy savings of the Panasonic indoor units All in One and Bi-bloc. In addition, these units' clean, tidy design and functionality make the Aquarea line the ideal system for household applications.









Panasonic's Aquarea range of Heat Pumps deliver major energy savings thanks to its incredible efficiency even at -20°C. The Panasonic Aquarea Heat Pumps are designed and produced by Panasonic and not by other companies.







The Aquarea Heat Pump is a system that generates the perfect temperature and produces hot water, in an easy, cheap and environmentally conscious way, by transferring heat instead of generating it. It is among the Technologies listed on the International Energy Agency (IEA) Blue Map, whose goal is to reduce CO₂ emissions to half the levels emitted in 2005, by the year 2050.

Aquarea is part of a new generation of heating solutions that use a renewable, free energy source (the air) to heat or cool the home and to produce hot water.

Energy saving





 <p>R32</p>	 <p>ErP 55°C</p>	 <p>ErP 35°C</p>	 <p>DHW</p>	 <p>INVERTER+</p>	 <p>A CLASS WATER PUMP</p>
<p>Refrigerant gas R32 Our Heat Pumps containing the refrigerant R32 show a drastic reduction in the value of Global Warming Potential (GWP).</p>	<p>Better efficiency & Value for medium temperature applications. Energy efficiency class up to A++ in a scale from A++ to G.</p>	<p>Better efficiency & Value for low temperature applications. Energy efficiency class up to A++ in a scale from A++ to G.</p>	<p>Better efficiency & Value for Domestic Hot Water. Energy efficiency class up to A in a scale from A to G.</p>	<p>Inverter Plus. Panasonic Inverter Plus compressors are designed to achieve outstanding level of performance.</p>	<p>A class water pump. Aquarea are built-in with A class energy efficiency water pump. High efficiency circulating the water in the heating installation.</p>

High Performance

 <p>5,33 COP HIGH PERFORMANCE</p>	 <p>-20°C CONSTANT HEATING T-CAP</p>	 <p>65°C OUTPUT WATER HIGH TEMPERATURE</p>	 <p>DHW</p>	 <p>-20°C HEATING MODE</p>	 <p>WATER FILTER WITH MAGNET</p>
<p>Aquarea High Performance for low consumption houses. From 3 to 16kW. For a house with low temperature radiators or under-floor heating, our high performance Aquarea HP is a good solution. *COP of 5,33 for 3kW All in One.</p>	<p>Aquarea T-CAP for extremely low temperatures. From 9 to 16kW. If the most important aspect is to maintain nominal heating capacities even at temperatures as low as -7°C or -20°C, select the Aquarea T-CAP.</p>	<p>Aquarea HT ideal for retrofit. From 9 to 12kW. For a house with traditional high-temperature radiators, the Aquarea HT solution is the most appropriate, can work in output water temperatures of 65°C even at outdoor temperatures as low as -20°C.</p>	<p>DHW. With Aquarea you can also heat your domestic hot water at a very low cost with the optional hot water cylinder.</p>	<p>Down to -20°C in heating mode. The Heat Pumps work in Heat Pump mode with an outdoor temperature is as low as -20°C.</p>	<p>Water filter with magnet. Easy access & fast clip technology for J Generation. Water filter only for H Generation.</p>

 <p>STOP VALVE</p>	 <p>FLOW SENSOR</p>	 <p>5 YEARS COMPRESSOR WARRANTY</p>	 <p>SG Ready Smart Heat Pumps</p>	 <p>NF HEAT PUMPS</p>	 <p>APPROVED PRODUCT</p>
<p>Water stop valve. Included on J and H Generation.</p>	<p>Water flow sensor. Included on J and H Generation.</p>	<p>5 years compressor warranty. We guarantee the outdoor unit compressors in the entire range for five years.</p>	<p>SG Ready: Thanks to Aquarea HPM, Aquarea range (Bi-bloc and Mono-bloc) is holding the SG Ready Label (Smart Grid Ready Label), given by Bundesverband Wärmepumpe (German Heat Pump Association). This Label shows the real capacity of Aquarea to be connected in an intelligent grid control. MCS Certificate number: MCS HP0086.*</p>		

High connectivity

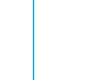
 <p>BOILER CONNECTION</p>	 <p>SOLAR KIT</p>	 <p>ADVANCED CONTROL</p>	 <p>OPTIONAL WLAN</p>	 <p>BMS CONNECTIVITY</p>
<p>Renovation. Our Aquarea Heat Pumps can be connected to an existing or new boiler for optimum comfort even at very low outdoor temperatures.</p>	<p>Solar kit. For even greater efficiency, our Aquarea Heat Pumps can be connected to photovoltaic solar panels with an optional kit.</p>	<p>Advanced control. Remote controller with full dotted 3,5" wide back light screen. Menu with 17 available languages easy to use for installer and user. Included on J and H Generation.</p>	<p>Internet control. A next generation system providing a user-friendly remote controller of air conditioning or Heat Pump units from everywhere, using a simple Android or iOS smartphone, tablet or PC via internet.</p>	<p>Connectivity. The communication port can be integrated into the indoor unit and provides easy connection to, and control of, your Panasonic Heat Pump to your home or building management system.</p>

Warning and Water Quality Directive and Groundwater:

This product is designed to comply with the European Water Quality Directive 98/83/EC amended by 2015/1787/EU. The lifespan of the product is not guaranteed in the case of the use of groundwater, such as spring water or well water, the use of tap water when salt or other impurities are contained, nor in areas of acidic water quality. Maintenance and warranty costs related to these cases are the customer's responsibility.

* Not all products certified. As the certification process is on-going and the list of certified products constantly changing, please check for latest details on the official websites.

HOW DO YOU GET HEATING AND DOMESTIC HOT WATER FROM AIR?



Aquarea Air to Water Heat Pump, outstanding seasonal efficiency.
 At the forefront of energy innovation, Aquarea is resolutely positioned as a “green” heating and air conditioning solution.

Introducing the Panasonic Aquarea – Air Source Heat Pump

An Aquarea air source Heat Pump circulates fresh air and passes it over refrigerant-filled coils (like a refrigerator). The captured heat is automatically transferred to water, which is then ready for use in your heating system and for supplying all of your domestic hot water needs. Panasonic’s latest technology offers you a sustainable alternative to oil, LPG and electric heating systems.

“Green” High-efficiency heating with Panasonic’s Air to Water Heat Pump Systems

Panasonic’s Aquarea Heat Pump provides savings of up to 80% on heating expenses compared to electrical heaters. For example, the Aquarea 3kW system has a COP of 5,33 (KIT-ADC03JE5). This is 5,33 more than a conventional electrical heating system which has a maximum COP of 1. This is equivalent to an 80%* saving. Consumption can be further reduced by connecting photovoltaic solar panels to the Aquarea system.

Why Air Source Heat Pumps?

- Heating, cooling and domestic hot water produced with a single system
- Best in terms of efficiency: even at extreme outdoor temperatures
- Environmentally advanced: can be connected to solar panels
- Technology that adapts to each home: extreme low temp, high temperature, whatever the climate
- Wide range of solutions: floor heating, radiators and fan coils
- Reduced heating bills and maintenance costs
- Reduce your carbon footprint
- Simple to integrate into existing heating systems

- Energy efficient alternative to oil, LPG and electric systems
- Ideal for properties without access to mains gas
- Externally positioned saving valuable internal living space

Aquarea Air to Water Heat Pump: An innovative low energy solution, designed to create great comfort at home even at extreme outdoor temperatures. Providing heat to radiators, underfloor heating, Fan Coils as well as producing domestic hot water.

Heat Pump: Up to 80% of required heat energy taken from ambient air

Based on Air to Water heat pump technology, Aquarea is highly efficient. It captures heat energy from the ambient air and transfers it to heat the water needed to warm your home and domestic hot water - it can even cool your home as required. Compared to other technologies, up to 80% of the heat energy required is taken from the ambient air - even in extremely low temperatures.



UP TO 80%* ENERGY SAVINGS WITH AQUAREA

Energy consumption comparison.

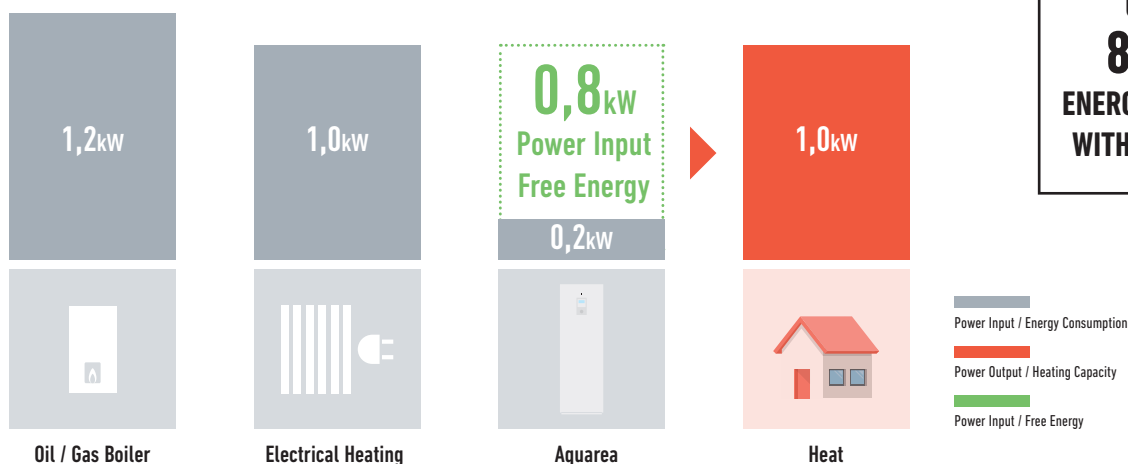

* Rating conditions: Heating: Inside air temperature: 20°C Dry Bulb / Outside air temperature: 7°C Dry Bulb / 6°C Wet Bulb. Conditions : Water input temperature: 30°C Water output temperature: 35°C.

AQUAREA HEAT PUMP LINE-UP

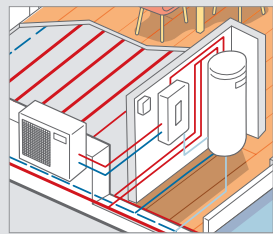
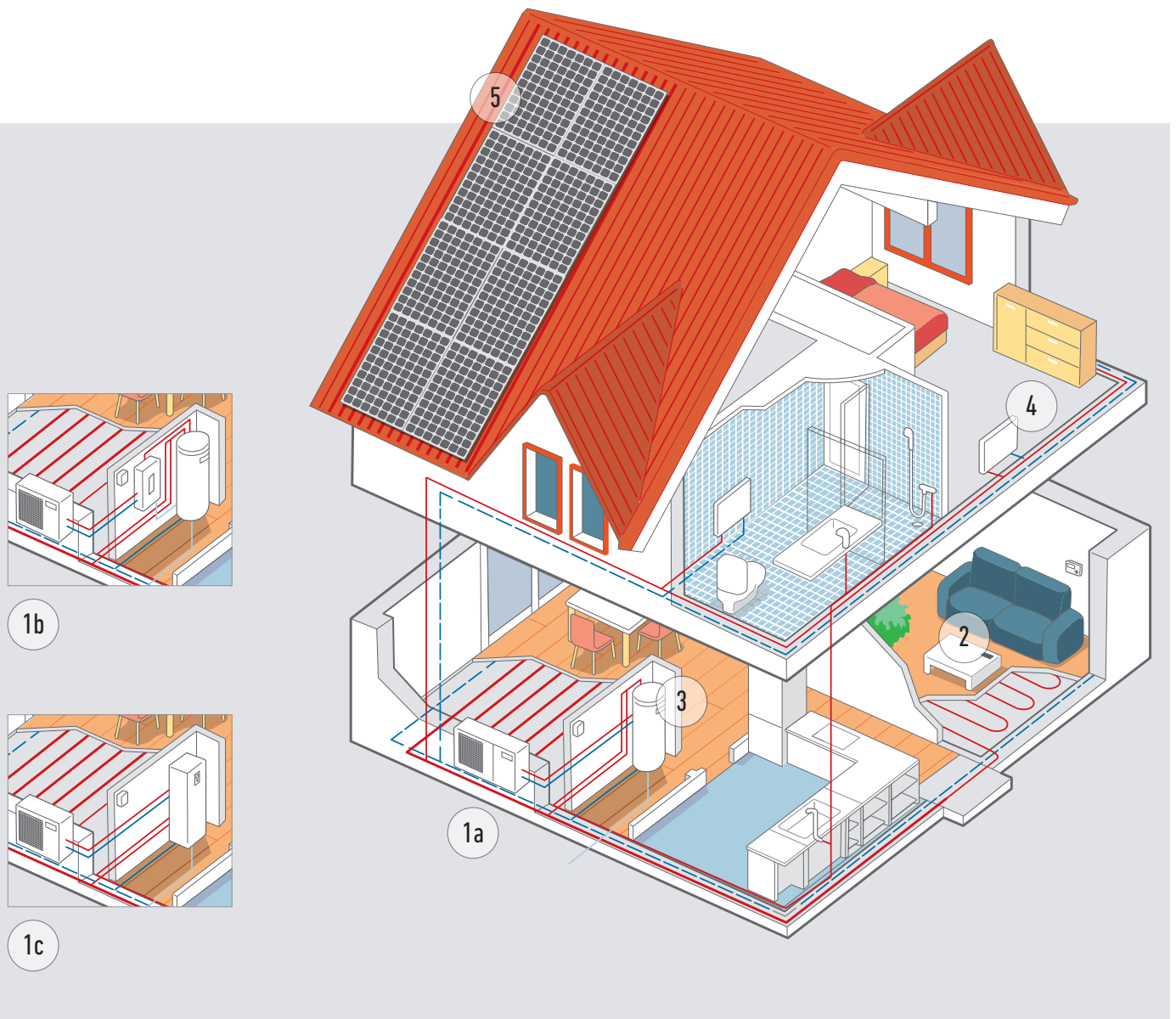

1b

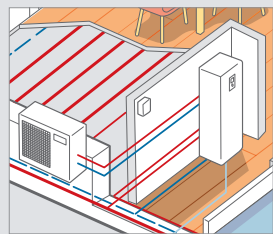

1c

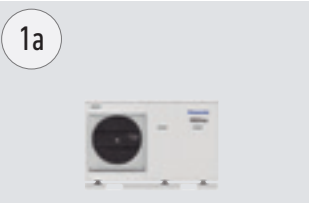

1a
Mono-bloc system.

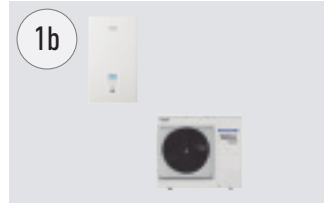

1b
Bi-bloc system.

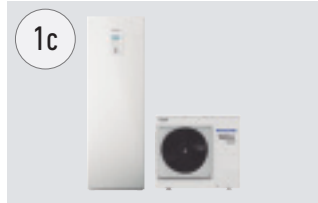

1c
All in One system.

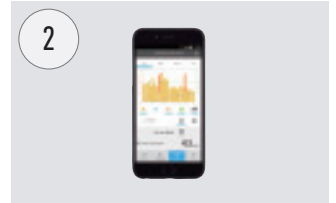

2
Control through smart phone, tablet or computer (optional).



3
Super High Efficiency cylinder (optional).

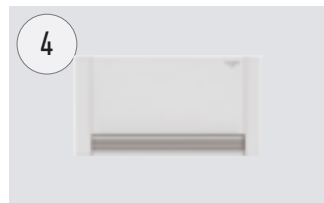

4
High efficient radiators for heating and cooling (optional).

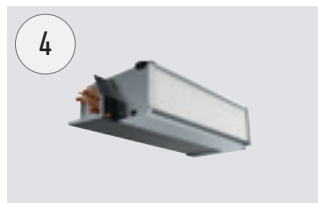

4
New versatile and efficient fan coil (optional).



5
Heat Pump + HIT Photovoltaic solar panel (optional).

Panasonic Aquarea offers you solutions, helping to make the home more efficient and the installation cheaper and easier.

Aquarea High Performance. For new installations and low consumption homes.

Outstanding efficiency and energy savings with minimised CO₂ emissions and minimum space. Improved performance with COP's up to 5,33.

Aquarea T-CAP. For extremely low temperatures, refurbishment and innovation.





















Ideal to ensure that the heating capacity is maintained even at very low temperatures. This line-up is able to maintain the Heat Pump output capacity until -20°C outdoor temperature without the help of an electrical booster heater.

Aquarea HT. For a house with old high-temperature radiators.

Ideal for retrofit: green energy source works with existing radiators. Aquarea HT Solution is the most appropriate, provides output water temperatures of 65°C even at outdoor temperatures as low as -15°C.

DHW Stand Alone.

- A+ Highly efficient wall mounted Domestic Hot Water Heat Pump
- Provides reduced power consumption by 75% compared with traditional electric water heater

Aquarea High Performance	Aquarea T-CAP	Aquarea HT	DHW Stand Alone
			
Mono-bloc Bi-bloc All in One	Mono-bloc Bi-bloc All in One	Mono-bloc Bi-bloc	
			
Heating - Cooling - DHW	Heating - Cooling - DHW	Heating - DHW	Only DHW
Single Phase from 3 to 16kW Three Phase from 9 to 16kW	Single Phase from 9 to 12kW Three Phase from 9 to 16kW	Single Phase from 9 to 12kW Three Phase from 9 to 12kW	100 and 150L
Connectable to			
			
Radiators - Fan Coil - Underfloor heating - DHW	Radiators - Fan Coil - Underfloor heating - DHW	Traditional high-temperature radiators - DHW	Domestic Hot Water
Application			
			
Normal installation	For extreme cold ambient	Retrofit for old radiators	Only DHW
Energy efficiency			
			
Heating 35°C / 55°C	Heating 35°C / 55°C	Heating 35°C / 55°C	DHW 50 - 62°C
Outdoor ambient temperature limit. Operation			
-20°C	-28°C	-20°C	-5°C
Outdoor ambient temperature limit. Constant capacity (35°C)			
-7°C (not for all units)	-20°C ¹⁾	-15°C	—
Supply temperature for heating. Max. / Heat pump only			
75°C ²⁾ / 55°C ³⁾ (or 60°C for Aquarea J Generation)	75°C ²⁾ / 60°C ³⁾	75°C ²⁾ / 65°C	—
Control and connectivity			
Smart Grid Ready ⁴⁾ Wireless LAN Ready	Smart Grid Ready ⁴⁾ Wireless LAN Ready	Smart Grid Ready ⁴⁾ Wireless LAN Ready	—
Range			
Bi-bloc from 3 to 16kW Mono-bloc from 5 to 16kW All in One from 3 to 16kW (185L)	Bi-bloc from 9 to 16kW Mono-bloc from 9 to 16kW All in One from 9 to 16kW (185L)	Bi-bloc from 9 to 12kW Mono-bloc from 9 to 12kW	100 and 150L

All data in this chart is applicable in most of models in each line up, check product specs to confirm. 1) 9 and 12kW. 2) DHW maximum temperature with heater. 3) In case of outdoor temperature over -10°C. 4) H Generation with CZ-NS4P, F and G Generation with Heat Pump Manager. * DHW Stand Alone is produced by S.A.T.E.

NEW R32 AQUAREA J GENERATION



Much more than just R32 Aquarea J Generation Available in 3/5/7/9kW All in One and Bi-bloc

Keeping Aquarea essence.

- Free space on the top of All in One
- A+++ Ready
- Service Cloud by accessory

What is new?

1. Higher efficiency.

- SCOP up to + 5% vs H Generation
- DHW COP up to 3,30 (for 3 and 5kW models)

2. More flexibility in design.

- 60°C water temperature
- Piping length improved: 7/9kW: 50/30m - 3/5kW: 25/20m
- Chiller function cooling down to 10°C outdoor temperature



3. New smart functions

- SG ready / PV function for cooling
- Utility remote bivalent control: By dry contacts*
- Stop external device when defrost by Dry contact (for Fan Coil fan stop)*

* Can not be used at same time.

4. More comfort

- Better comfort in extreme low temperature: Heating curve can be set up down to -20°C
- Efficient or comfort mode for DHW: Part load for better efficiency or full load to reduce the heat up time
- DHW two sensor position selectable for All in One: Efficient position (best DHW COP) or bigger volume of hot water

Other improvements: More silent outdoor units / Magnet filter for water cycle.



R32 Refrigerant Gas: A 'small' change that changes everything

Panasonic recommends R32 because it is comparably environmentally friendly. Compared to R22 and R410A, R32 has a very low potential impact on the depletion of ozone layer and global warming.

In line with the European Countries who are concerned in protecting and maintaining the environment by participating in the Montreal Protocol to protect the Ozone Layer and prevent Global Warming, Panasonic is leading the switch to R32.

1. Installation innovation.

- Extremely easy to install, practically the same as R410A. (Just remember to verify that the pressure gauge and vacuum pump are compatible with R32)

- This refrigerant is 100% pure, which makes it easier to recycle and reuse

2. Environmental innovation.

- Zero impact on the ozone layer
- 75% less impact on global warming

3. Economic and energy consumption innovation.

- Lower cost and greater savings
- Higher energy efficiency than R410A

AQUAREA H GENERATION A+++*

(Applicable from 26 September 2019).



The beauty of comfort. The H Generation is being introduced from 3 to 16kW. The small capacities are specially designed for low energy homes and achieve an impressive COP of 5 (on the 3kW).

Better Efficiency & Value A++/A++

- A++ for medium temperature applications (radiators. ErP 55°C)
- A++ for low temperature applications (floor heating. ErP 35°C)
- 3 & 5 kW models will meet the energy efficiency class A+++ as applicable from 26 September 2019

Aquarea, a generation of energy efficient heating and hot water

Thanks to the system's high degree of technology and advanced control, it is able to maintain a high output capacity and efficiency even at -7°C and -15°C. The Aquarea's software can be set for the requirements of low consumption homes in order to maximise energy efficiency. Whatever the weather, Aquarea can work even at -28°C (T-CAP only) lower limit. The compact design of the outdoor unit makes installation very easy.

All in One, compact and easy to install

Space-saving solution ideal for installations with restricted space. In addition, Panasonic has developed bivalent and cascade systems that give the user control of two heating zones.

The Aquarea All in One belongs to the new generation of Panasonic heat pumps for heating, cooling and providing domestic hot water in the home. Aquarea T-CAP is one of the newest heat pumps on the market, maintaining nominal heating capacities even at temperatures as low as -20°C*. This ensures the best possible seasonal energy efficiency ratio. The heat pumps are tested at an outdoor temperature of -28°C to ensure stable operation.

Improved square design with white goods finish. Modern remote controller can be installed up to 50m from the indoor unit.

Installer Friendly:

- Electrical connections is now located on front side
- Easy access to parts and easy to install by having all pipings in a row
- Remote controller with full dotted wide screen and new functions
- Can connect additional room temperature sensor, solar kit, 2 zones control, swimming pool and circulating pump (need optional PCB: CZ-NS4P)

All in One with Vacuum Insulation Panel (VIP)

Panasonic U-Vacua™ is a high performance vacuum insulation panel (VIP) with very low thermal conductivity that performs about 20 times better than standard urethane foam.

Features:

- Highly versatile (R-60 per inch)
- High insulation performance for energy savings
- High heat resistance core material
- High recyclability
- Environmentally friendly: made with 75% recycled glass
- Ideal for spacious yet compact appliances

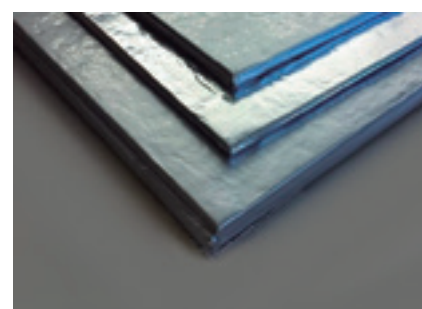

Compact and free space. More value in 1 compact space:

- Line strainer (easy access & fast clip technology)
- Isolation valves
- Electronic flow sensor
- 3 way valve ready (optional CZ-NV1 in internal space)

All in One with 2 zones control.

- 2 heating circuits, with 2 different water temperatures
- 2 water pumps and 2 water filters
- Floor heating water control with mixing valve

2 Zones kit included with control of 2 water temperatures (underfloor with water at 35°C and radiators with water at 45°C).

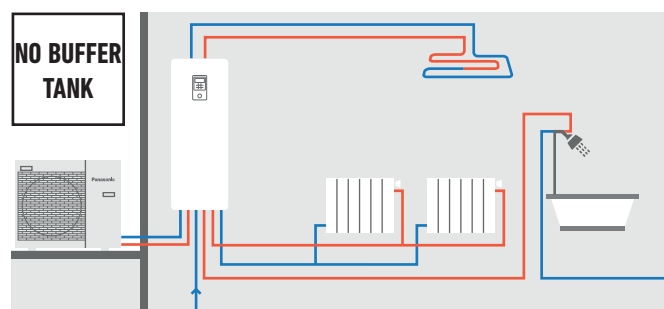

AQUAREA HIGH PERFORMANCE



For new installations and low consumption homes.
 Outstanding efficiency and energy savings with minimised
 CO₂ emissions and minimum space.

High Performance helps you to meet strict building requirements and reduce building costs

The heating and production of domestic hot water have a very important impact on the energy consumption of a house. Efficient Panasonic Heat Pumps can help to significantly reduce the energy consumption of the house.

Key points of the line-up

- Improved performance with COP's up to 5,33
- Reduced energy consumption through our circulating pump with energy efficiency class "A"
- Remote controller functions added: Auto mode, holiday mode, power consumption display

Panasonic has designed the Aquarea Bi-bloc and Mono-bloc Heat Pumps for homes which have high performance requirements. Whatever the weather, Aquarea can work even at -20°C! The Aquarea is easy to install on new or existing installations, in all types of properties.

High Performance Pumps are also Highly Efficient (take the KIT-ADC03JE5 for example)

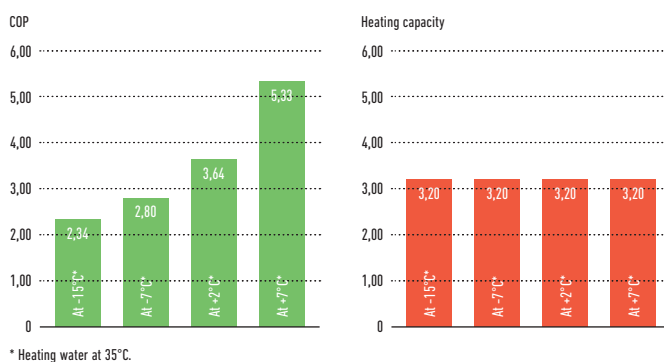

Standard circulating pumps vs our circulating pump with energy efficiency class "A"

Comparison of energy consumption of circulation pumps. Circulating pump with energy efficiency class "A" with Dynamic flow control for 5kW Mono-bloc.

* Based on German market: Assuming Standard pump may vary depending on consumption and energy cost.

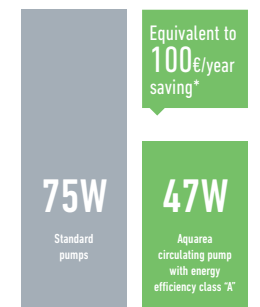

Panasonic created a night mode to reduce the noise when it's needed

Special attention has been given to noise levels

1. Sound pressure measured at 1m from the outdoor unit and at 1,5m height.
2. At standard condition working at heating capacity at +7°C (heating water at 35°C) for two fans outdoor units. For one fan outdoor units, night mode reduction is 3dB(A).

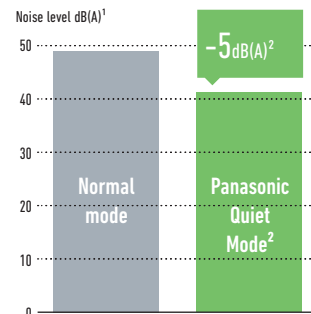

AQUAREA T-CAP



For retrofit and new builds, install the T-CAP heat pump where the kW output capacity is demanding.

Ensure the heating capacity is maintained even at low temperatures

The whole T-CAP line-up can replace old gas or oil boilers, and in a new application with underfloor heating, radiators or even fan-coil heaters, the whole T-CAP line-up is an ideal replacement for old gas/oil boilers. All Aquarea heat pumps can also be connected to a solar thermal or PV system in order to increase efficiency and minimise the impact on the ecosystem.

Higher efficiency compared to other heating systems

Panasonic Heat Pumps have a maximum COP of 4,85 at +7°C which makes them much more efficient than others heating systems.

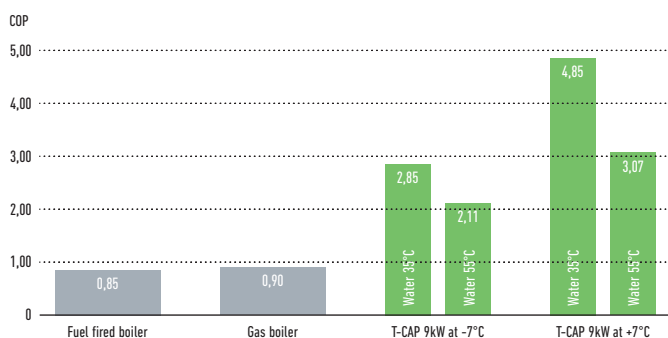

More Energy saving

T-CAP is also able to provide extremely high efficiencies, whatever the outside or the water temperature.

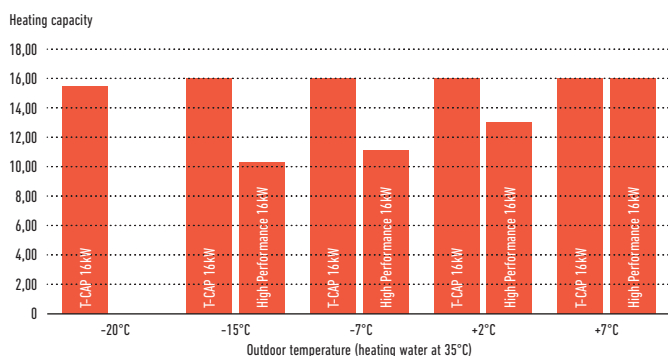

Key points of the line-up

- Ability to maintain the heat pump kW¹ output capacity until -20°C outdoor temperature without the help of an electrical booster heater
- High heating capacity even at low ambient temperatures
- Additional functions: Auto and holiday mode, boost, drying concrete and power consumption display
- Backup heater capacity can be selected depending on the model (3/6/9kW)
- Cooling mode activation possible via software²

1) At 35°C flow. 2) This activation can only be done by service partner or installer.

With a Panasonic heat pump, there is no need to oversize in order to reach the required capacity at low temperatures

- Panasonic's unique software and inverter technology for low consumption houses, allows the heat pump to produce heating water at 35°C. When only a little heating is required due to warmer outside air temperature
- All Aquarea heat pump's have a 10L expansion vessel fitted internally
- Aquarea heat pump's has an inverter compressor which can regulate the output capacity depending on demand
- Twin dice system included within the system (Twin fan outdoor unit)
- 3/6/9kW electrical heater is included in the heat pump (depending on unit)
- Panasonic heat pumps can work in outdoor temperatures as low as -28°C and guarantee the capacity without backup heating down to -20°C¹
- Panasonic heat pumps are very quiet and have a noise reduction setting for night mode. See noise calculator on www.panasonicproclub.com

1) 35°C flow temperature.

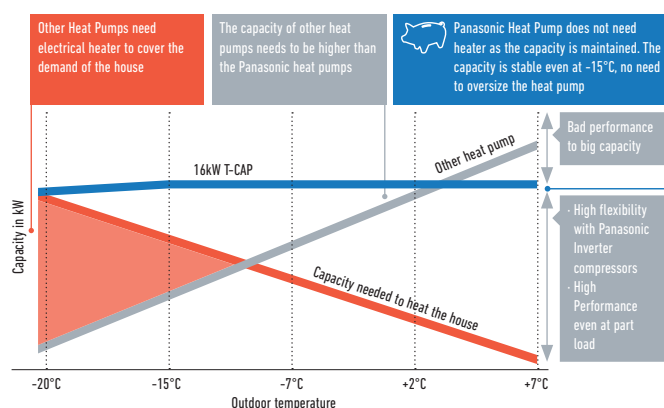

New Aquarea Super Quiet T-CAP Bi-bloc

The special outdoor chassis notably reduces operation sound by up to 11dB (when setting at quiet mode level 2* WH-UQ12HE8).

* Heating capacity may drop.



AQUAREA HT



Aquarea HT can produce a flow temperature of 65°C making it the ideal high efficiency replacement for oil/gas boilers connected to high temperature radiators.

Green energy source works with existing radiators

The Aquarea HT (9kW & 12kW) allows you to replace your traditional heating source (such as oil or gas) while keeping the existing old style radiators for minimum disruption to the home.

Aquarea HT: High savings and low CO₂

The benefit of replacing a traditional heating systems with Aquarea HT are clear: Reduced CO₂ emissions, future proofing running costs. Panasonic Heat Pumps are much more efficient than fossil fueled boilers and help you to reach your house energy targets.

Yearly savings with Aquarea HT

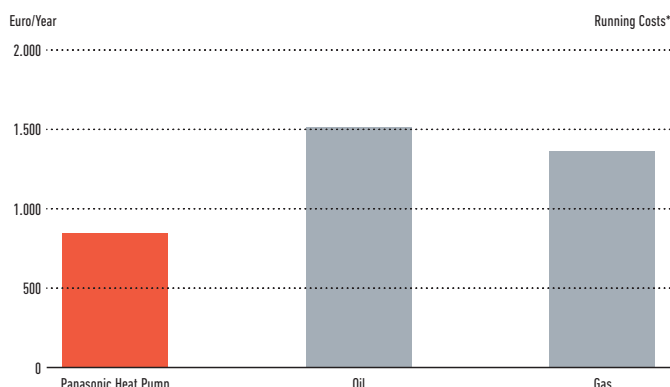

* For a 170m² house and 40 W/m² energy losses in central Europe Conditions, outside minimum conditions -10°C.

Panasonic Aquarea HT is highly efficient even at low outdoor temperatures

Heating Capacity of a 9kW HT (WH-SHF09F3E5).

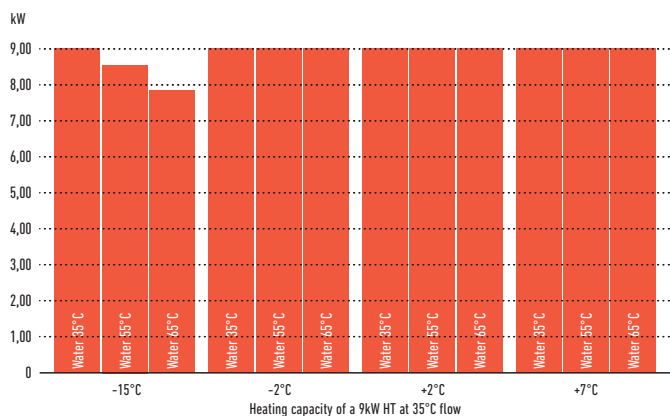

Smart Bivalent operation

Using the Aquarea bivalent controller, it is now possible to combine different heat sources (boiler with heat pump) allowing to set up the system to operate in the most efficient way.



Heat Pump + Boiler with DHW cylinder controlled by the smart bivalent controller.

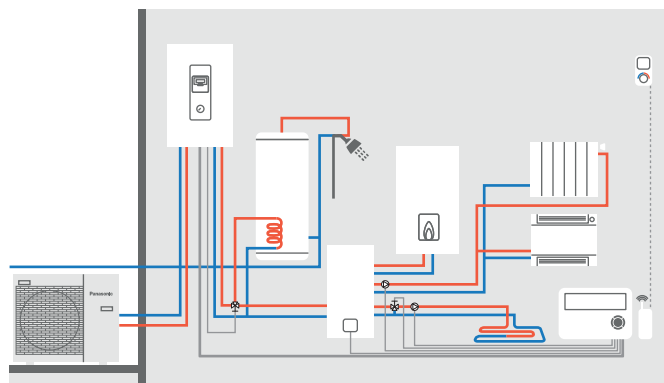

Easy installation

Air source Heat Pumps are simple to install. They do not require a chimney, gas connection or oil/lpg tank. All that is required is a power supply connection.

COP (Coefficient of Performance) of a 9kW HT (WH-MHF09G3E5).

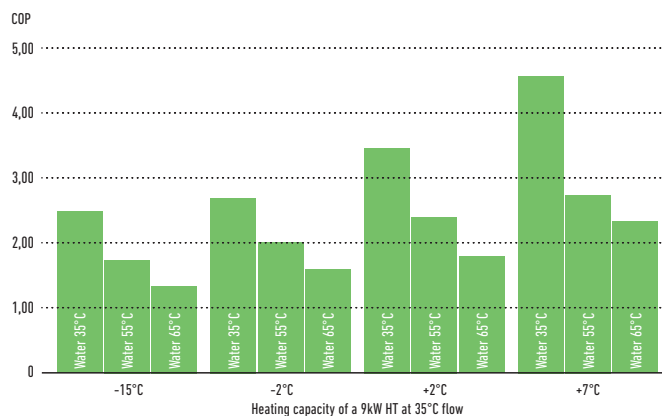

The Aquarea HT range is easy to install and is available with nominal heat outputs of 9kW or 12kW. These can be either single or three phase, in both Bi-bloc and Mono-bloc versions.

AQUAREA COMMERCIAL

Restaurant with Aquarea

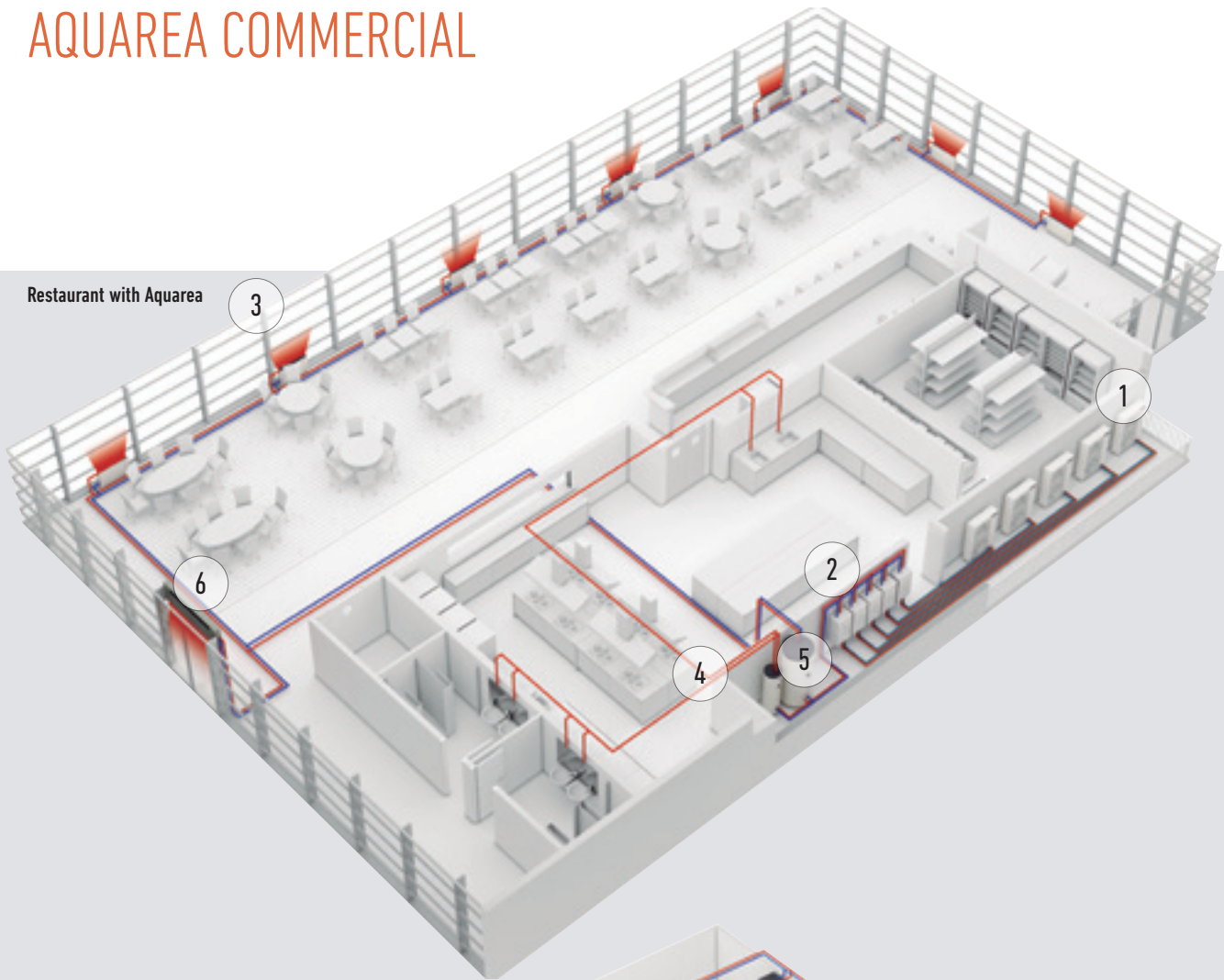

Supermarket with Aquarea

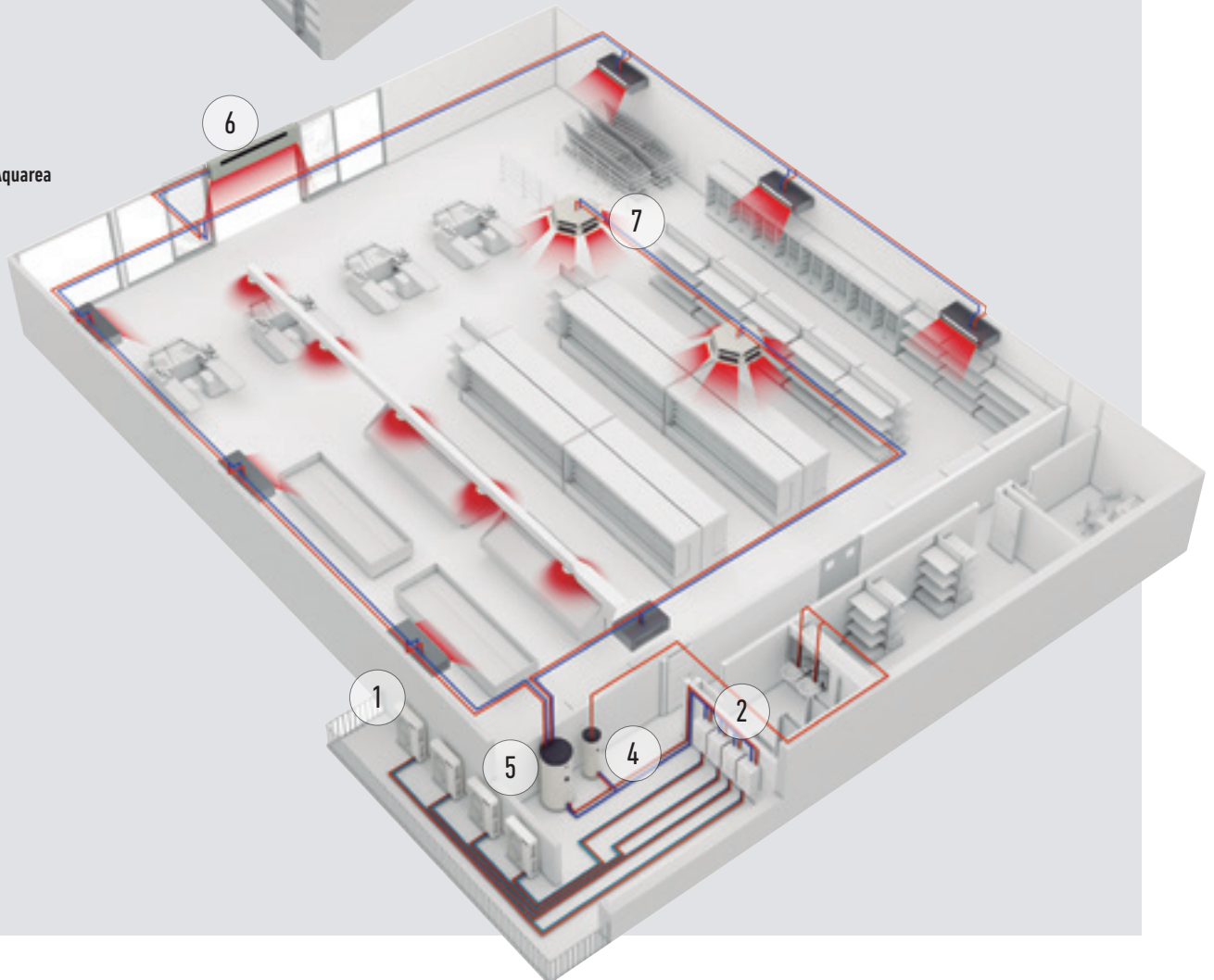

Solutions for best savings. Efficient Panasonic Heat Pumps can help to significantly reduce the energy consumption of your business. Recent improvements to air source Heat Pump technology, including compact single unit systems, can provide an ideal housing and commercial solution.

They offer space saving, energy-efficient heating and can be easily adapted for installation in flats, houses and commercial premises. Businesses producing heat, such as restaurants, installing an Aquarea Heat Pump system can also use this wasted heat to improve energy efficiency further.

Restaurant with Aquarea

If you are looking for savings for your business, Aquarea is the right choice! Ideal for heating, cooling and for production of big quantities of hot water at 65°C, Aquarea have a quick return on investment and a low carbon footprint.

Key points:

- Produce hot water efficiency
- Fast return of investment
- Easy control

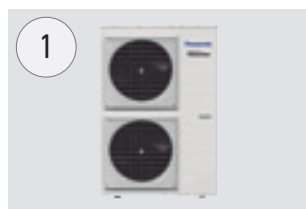

Aquarea T-CAP.
Heat Pump 16kW on cascade mode.

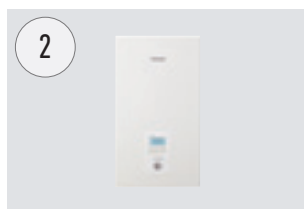

High Efficiency Aquarea Hydrokit.



High efficiency Aquarea Air radiators.
32% more efficient than standard radiators.



New versatile and efficient fan coils.
Innovation for an optimum comfort.



Super high efficiency Tanks.
From 200L to 500L for domestic hot water.

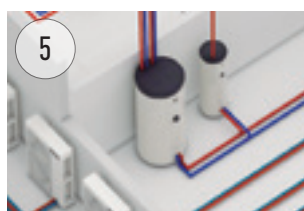

Buffer Tank of 1000L.



Air Curtain with DX Coil.
Designed for smooth operation and efficient performance.



Convectors.

Supermarket with Aquarea

Heat pump technology is scalable, meaning that it can be installed in buildings of varying sizes, offering both small- and large-scale heating solutions. The technology is also environmentally friendly when compared to traditional heating systems alternatives based on fossil fuel energy and in addition it is more energy efficient.

Can be integrated in the water system.

Easy connection to existing system

- Fan Coils
- Floor Heating
- 4 way and 2 way convectors
- Domestic hot water tanks
- High efficiency
- Very good part load management

Case study: Carluccio's restaurant

One of UK's leading Italian restaurants, Carluccio's, wanted to install a system which would provide the desired volume of hot water, at the correct temperature while at the same time reduced energy costs. Previous restaurants in the chain had been fitted with a more traditional 12kW boiler system. FWP installed a 12kW Aquarea T-CAP mono bloc unit which would allow for the free air from the kitchen roof space to be transferred through

condensing unit providing hot water at the optimum temperature. With a high coefficient of performance (COP), the system returns an impressive 4kW of energy, for every kW used. This makes the Aquarea far more cost effective than a conventional heating system. To heat the water for their Leeds restaurant cost £3782 whilst at the Meadowhall site the comparable cost was just £951. These sizeable savings mean the site will see a return on investment in approximately 2 years.

AQUAREA SMART AND SERVICE CLOUD

1 AQUAREA SMART CLOUD FOR END USERS



* User interface image may change without notification.

Easy and powerful energy management

The Aquarea Smart Cloud is much more than a simple thermostat for switching a heating device ON or OFF. It is a powerful and intuitive service for remotely controlling the full range of heating and hot water functions, including monitoring energy consumption.

How does it work?

Connect Aquarea J and H Generation system to the cloud using wireless LAN or a wired LAN Network. User connects to the Cloud portal to remotely operate all unit functions and can also permit partners to access customised functions for remote maintenance and monitoring. See demo: <https://aquarea.aircon.panasonic.eu>

Requirements

1. Aquarea J and H Generation
2. In-house internet connection with router wireless LAN or wired LAN
3. Get a Panasonic ID in <https://aquarea-smart.panasonic.com/>

Functions:

- Visualization and Control
- Scheduling
- Energy Statistics
- Malfunction notification

Advantages

Energy savings, comfort and control from anywhere. Increase efficiency and resources management, operating costs savings and owner satisfaction. The new Aquarea Smart Cloud services are focused on enabling full remote maintenance of the Aquarea system. This allow maintenance specialists to engage in predictive maintenance and system fine-tuning, as well as fixing malfunctions when they occur.

Aquarea compatibility	J and H Generation
Connection point	CN-CNT Aquarea port
Home router connection	Wireless or Wired LAN
Temperature sensor	Can use remote controller sensor
Tablet or PC browser compatibility*	Yes
Operation from remote – On/Off – House Temp setting mode selection – DHW setting – Error codes – Scheduling	Yes
Heating areas	Up to 2 zones
Power consumption estimation – Operation log history	Yes – Yes

* Check browsers and version compatibility.

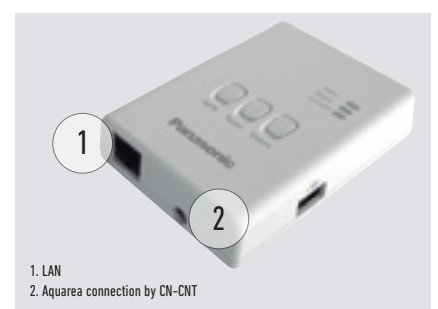

1. LAN
2. Aquarea connection by CN-CNT

The most advanced heating control for today and for the future.
 Aquarea connect to Cloud with CZ-TAW1, opening 2 different platforms.

2 AQUAREA SERVICE CLOUD FOR INSTALLERS / MAINTENANCE

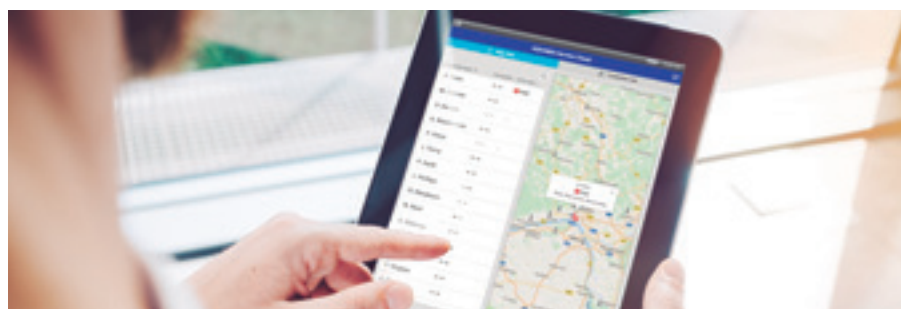

The real remote maintenance made simple

The Aquarea Service Cloud allows to installers to take care remotely of their customers heating systems. Saving time, money and shortening response time increasing customer satisfaction.

Advanced functions for remote maintenance with professional screens:

- Global view at a glance
- Error log history
- Full unit information
- Statistics always available
- Most settings available

Home page.

All users connected status at a glance. 2 view options: Map view or list view only.

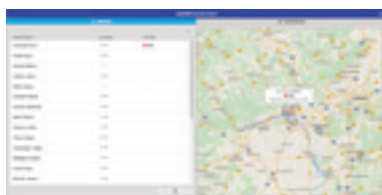

Status tag.

Current status of unit with a maximum 28 parameters.



Statistics tag.

Customisable statistics of a maximum 71 parameters. Available anytime with the information of last 7 days.

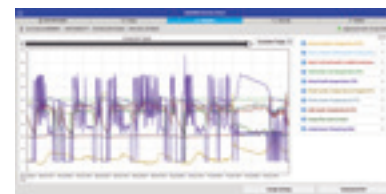

Settings tag.

Most settings of system remotely including user and installer settings.



Activation Aquarea Service Cloud

Requirements.

Hardware and connection	End user registration	Installer / maintenance registration
J and H Generation Aquarea connected to CZ-TAW1	Get Panasonic ID	Get Service ID
In house internet connection with Wireless LAN or Wired LAN	Aquarea Smart Cloud	Aquarea Service Cloud

Connecting unit to installer/maintenance.

Process can be initiated either both by end user or by installer. Whenever end user can select/change level of control is giving to installer (4 levels).

Installer registration: <https://aquarea-service.panasonic.com/>

End user registration: <https://aquarea-smart.panasonic.com/>

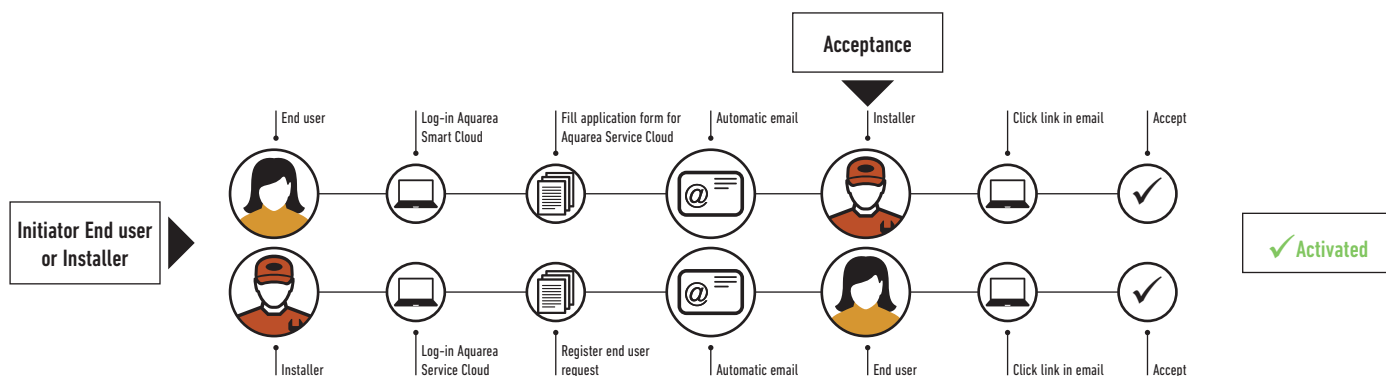



CONTROL AND CONNECTIVITY



Home connectivity and Home Managements Systems integration is becoming more and more popular. These integrations helps to control all house devices from centralised platform and helps to optimise the operation and running costs. Panasonic interfaces are made to work with both KNX and Modbus, the most populars protocols. Also for non integrated control, Panasonic developed a simple connection to Wireless LAN, with this End User can control remotely its own heat pump from wherever.

Connectivity. Control by BMS

Great flexibility for integration into your KNX / Modbus projects allows fully bi-directional monitoring and control of all the functioning parameters.

Reference					Model name	Interface
	PAW-AW-KNX-1i / PAW-AW-KNX-H	PAW-AW-MBS-1 / PAW-AW-MBS-H	PAW-AW-MBS-1 / PAW-AW-MBS-H	PAW-AW-MBS-1 / PAW-AW-MBS-H		
Small dimensions	✓	✓	✓	✓	PAW-AW-KNX-H	KNX interface for H Generation
Quick installation and possibility of hidden installation	✓	✓	✓	✓	PAW-AW-MBS-H	Modbus interface for H Generation
External power not required	✓	✓	✓	✓	PAW-AW-KNX-1i	KNX interface (not compatible with J and H Generation)
Direct connection to the unit	✓	✓	✓	✓	PAW-AW-MBS-1	Modbus interface (not compatible with J and H Generation)
Control and monitoring, from sensors or gateways, of the internal variables of the indoor unit and error codes and indication	✓ Fully interoperable				PA-AW-WIFI-1TE	Internet control WLAN connection (not compatible with J and H Generation)
Control and monitoring, from any BMS or PLC Modbus Master, of internal variables of the indoor unit and error codes and indication			✓ Fully interoperable		CZ-TAW1	Aquarea Smart Cloud, H Generation Internet control through wireless or wired LAN
Aquarea unit can be controlled simultaneously by its remote controller and by KNX / Modbus Master devices	✓			✓		

These interfaces allows full monitoring and control, bi-directional, of all the functioning parameters of Aquarea control from KNX / Modbus installations.

Advanced Controller for J and H Generation



Improved visibility & Easy operation with large full dot LCD display and large touch panel!

Remote controller can be removed from indoor unit and installed in living room.

Function for installer:

- Floor heating concrete dry mode: Allows for a slow increase in temperature of underfloor heating via software.
- Heating and Cooling Mode: Authorised PRO Partners can enable the cooling mode through a special operation via the remote controller on site
- Installer can select delta T. Water pump speed is selected automatically due to this setting

Key Points:

Full large dot LCD screen (3,5 inch): High resolution screen with backlight, easy set up, check conditions easily, flat, innovative design, temperature sensor included in controller.

Function for End User:

- Auto Mode: Automatically changes from heating to cooling depending on outdoor temperature.
- Energy Consumption Display: Displays the Heat Pump's energy consumption, split by heating, cooling and domestic hot water, showing the total consumption figure.
- Holiday Mode: Enables the system to resume at the preset temperature after your holiday

Cascade Controller PAW-A2W-CMH



Cascade up to 10 Aquarea H Generation*.

- Up to 10HP (working hour balancing)
- 3x M-BUS devices connectable (for heat meter and/or current meter)
- Demand PV functions (similar to HPM + 0-10 V demand signal control function)

- Can control 3 way valves for cooling (2 buffer tanks)
- MODBUS IP for BMS communication
- DHW control logic
- Touch display with information about the HP
- All components in one case

* Requires 1 PAW-AW-MBS-H per each Aquarea.

AQUAREA + PV PANELS



Aquarea J and H Generation can synchronize with PV panels with simple CZ-NS4P PCB. A part of converting Aquarea in Smart Grid Ready, there is a new advantage, this new PCB allows 0-10V control. With this Aquarea demand is adapting all moment with the PV panel production. Innovative algorithm balancing the heat pump's consumption and the in-house comfort, based on the outside temperature and the energy demand of the building.



Heat up Domestic Hot Water for free.

Comparison on new housing.

Increase usage of self production by: 120%

The Panasonic Aquarea PV Control could increase the energy usage of the heat pump coming from the Photovoltaic panels from 352kWh to 775kWh a year. Results of simulations:

New building Frankfurt (non-optimized).

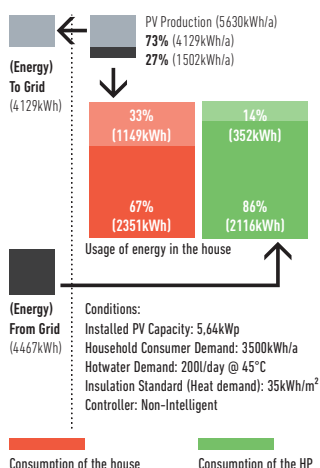

New building Frankfurt (optimized-eco).

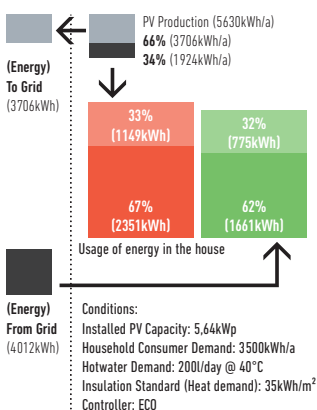

Comparison on old housing.

Increase usage of self production by: 71%

The Panasonic Aquarea PV Control could increase the energy consumption of the heat pump coming from the Photovoltaic Panels from 526kWh to 898kWh a year. Results of simulations:

Old building Frankfurt (non-optimized).

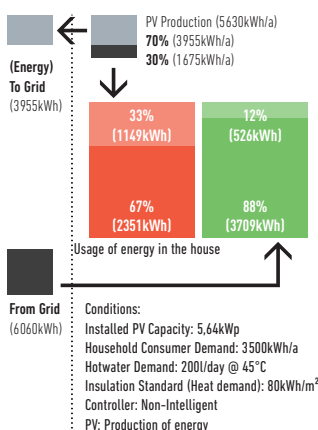

Old building Frankfurt (optimized-eco).

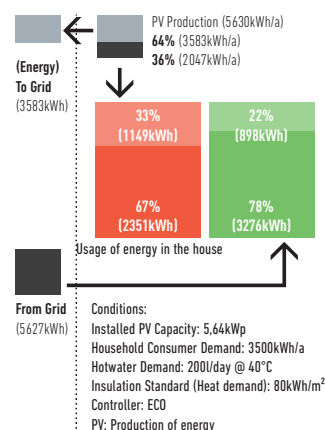

Consumption of the house Consumption of the HP

PANASONIC'S AQUAREA OFFERS THE BEST FOR YOU AND YOUR HOME

Panasonic will supply the energy label and a product fiche for all delivered products affected by these regulations, which sales partners, traders and contractors must use when labelling our products.



Energy Label

Fridges, dishwashers, washing machines, ovens – it all started with white goods in the 1990s. Today, other energy-consuming appliances also carry the European energy efficiency label, such as TV sets, lighting and – since September 2014 – even vacuum cleaners. Since 2013 the regulations already apply to air conditioners and heat pumps. Since September 2015, it has been applicable also to room heaters, water heaters and storage water heaters.

Minimum energy efficiency requirements are also specified for manufacturers of system and combi boilers, water heaters and DHW cylinders.

Energy Labels are to assist consumers in their purchasing decisions, and ecodesign requirements on products are to help reduce private energy demand, as well as to contribute minimising global warming.

Panasonic helps you to calculate the system label .

From 26th September 2015, installers can be assured that all products manufactured after this date will be sold with the required energy efficiency labels which will aid installers with their paperwork. While it is the manufacturer's responsibility to issue their products with the required labels, the installers will need to calculate and issue an energy efficiency label for the entire heating system. Whether installing a new heating system or installing new boilers, controls or renewables into an existing system, it is, and will continue to be, the installer's responsibility to calculate and issue energy efficiency labels. Calculators which assist installers with this process are available on www.panasonicproclub.com.

Information on the energy efficiency label.

The rating system for Heat Pumps classifies them into nine efficiency categories. The best energy efficiency category is A++. The best energy efficiency class is currently A++, the worst is G. The energy efficiency label for system boilers shows its efficiency category on a scale from A++ to G (from A to G for hot water cylinders). In September 2019, a more rigorous scale will be introduced from A+++ to D, and from A+ to F for hot water cylinders.

Panasonic helps you to calculate the system label

www.panasonicproclub.com

or connect simply with your smartphone to the PRO Club using this QR



PRO Club

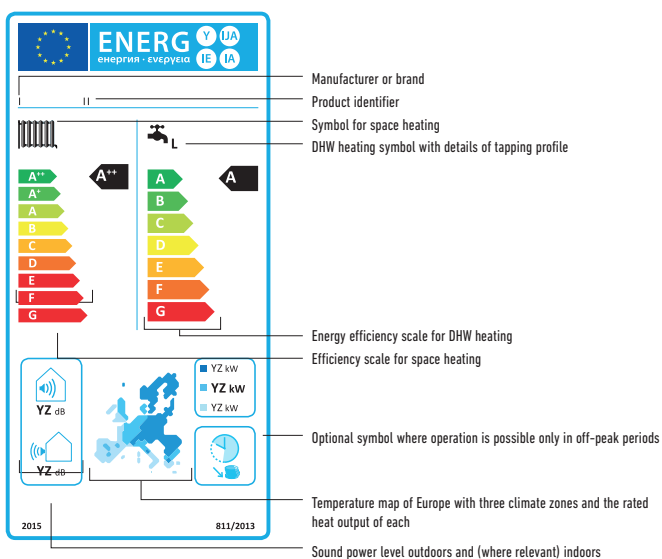

A typical example of savings and performances that Aquarea can offer to you.

A 125m² house in Reims

The example below shows a typical 3 bedroom French home and highlights the potential savings that can be achieved with Panasonic's Aquarea heat pump*.

* Calculations were carried using Panasonic's Aquarea Designer software, available from the PRO Club website (www.panasonicproclub.com).

Service hot water	
Type of service	Hot water with heat pump
Tank volume	300 Litre
Average daily need	200 Litre
Cold water inlet temperature	10°C
Target tank temperature	50°C
Exchange loss	5K
Electrical auxiliary heating necessary	No

Used Panasonic heat pump	
Description	T-CAP 12KW
Sanitary tank	Stainless steel 300L
Heat pump type	Air / Water
Capacity / consumption at 2°C (heating water at 35°C)	Heat: 11,7kW, Electric: 3,4kW
Recommended flow-through of air	80,0m ³ /min
Maximum flow temperature	55°C
Mode of operation	Monovalent
Design	-5,0°C
Number of heat pumps used	1
Wattage of fan (included in heat pump performance data: yes)	60W
Power consumption of heat circulation pump(s)	180W

Building data	
Address	Reims (French)
Building area	125m ²
Standard heating requirement	11,3kW
Internal gains	5625kWh/year
Solar gains (windows)	4500kWh/year
Indoor design temperature	20°C
Outdoor temperature limit for heating 'ON'	15°C
Heat distribution	Underfloor heating by 100 %
	Radiator heating by -- %
	Wall heating by -- %
Maximum flow water temperature	55°C
Maximum return water temperature	50°C
Solar collector area	-- m ²

Rate data	
Description	French (Panasonic)
Shut OFF times total	0,0 h/day
Weekends with shut OFF times	Yes
Daytime rate of heat pump	Time for daytime rate
	5-19 o'clock
Nighttime rate of heat pump	Time for nighttime rate
	19-5 o'clock
Heat circulation pump(s)	Like heat pump: yes -- pence/kWh
Heating element for monoenergetic operation	Like heat pump: yes -- pence/kWh
Heating element for post heating of hot water	Like heat pump: yes -- pence/kWh

Climatic data	
Climatic location	Reims (FR)
Monthly average temperatures in °C	Jan 3,4 Apr 8,0 Jul 16,0 Oct 10,4
	Feb 3,6 May 11,2 Aug 15,9 Nov 6,7
	Mar 5,7 Jun 14,1 Sep 13,7 Dec 4,6

Calculation results

Monthly heat consumption in kWh.

Annual energy costs		Caused by heat consumers	
Caused by heat producers		Space heating	1220 €
Heat pump	1600 €	Service hot water	225 €
Hot water heating rod	0 €	Heat circulation pump(s)	155 €
		Total	1600 €

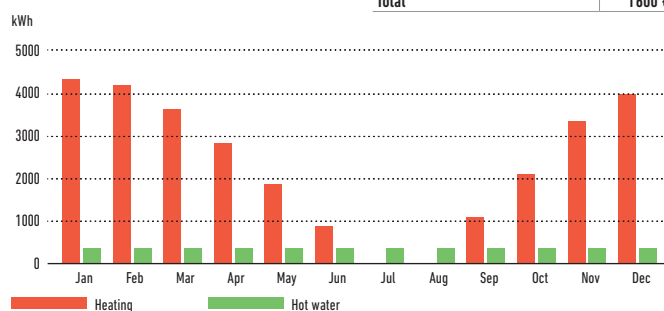

Aquarea energy coverage.

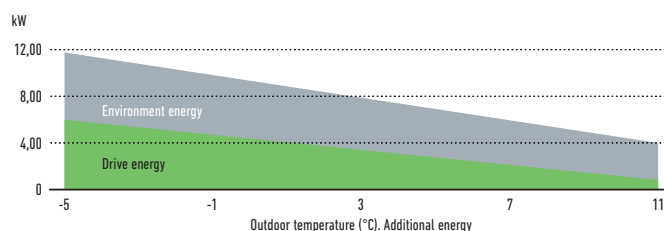

Comparison of running costs.

Operational costs				
Type of heating	Price in pence /kWh	Efficiency (%)	Additional costs in €/year	Total costs in €/year
Heat pump	-	-	0	1600
Oil	6,5	85	0	3050
Gas	4,0	90	0	1868
Wood heating	5,0	80	0	2539
Electric night storage heater	12,0	100	0	4455
Electric heating element	14,0	100	0	5197

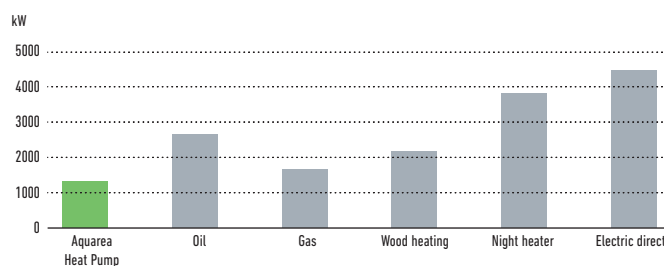



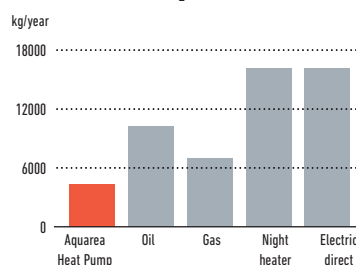



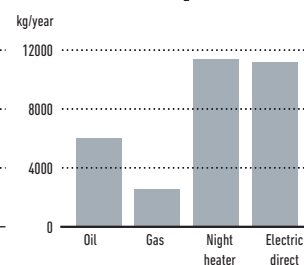













Comparison of CO₂ emissions.



Comparison of CO₂ savings.



AQUAREA HEAT PUMPS LINE-UP

		3kW	5kW	7kW
Aquarea High Performance P. 46, 48, 49	All in One 1 Phase 3 Phase 	 <ul style="list-style-type: none"> WH-ADC0309J3E5 WH-ADC0309J3E5B WH-UD03JE5 WH-ADC0309H3E5 WH-ADC0309H3E5B WH-UD03HE5-1 	 <ul style="list-style-type: none"> WH-ADC0309J3E5 WH-ADC0309J3E5B WH-UD05JE5 WH-ADC0309H3E5 WH-ADC0309H3E5B WH-UD05HE5-1 	 <ul style="list-style-type: none"> WH-ADC0309J3E5 WH-ADC0309J3E5B WH-UD07JE5 WH-ADC0309H3E5 WH-ADC0309H3E5B WH-UD07HE5-1
	P. 47, 52, 53 	Bi-bloc 1 Phase 3 Phase 	 <ul style="list-style-type: none"> WH-SDC0305J3E5 WH-UD03JE5 WH-SDC03H3E5-1 WH-UD03HE5-1 	 <ul style="list-style-type: none"> WH-SDC0305J3E5 WH-UD05JE5 WH-SDC05H3E5-1 WH-UD05HE5-1
P. 56 	Mono-bloc 1 Phase 	 WH-MDC05H3E5	 WH-MDC07H3E5	
Aquarea T-CAP P. 50-51	All in One 1 Phase 3 Phase 			
	P. 54-55 	Bi-bloc 1 Phase 3 Phase 		
P. 57 	Mono-bloc 1 Phase 3 Phase 			
Aquarea HT P. 58	Bi-bloc 1 Phase 3 Phase 			
	P. 59 	Mono-bloc 1 Phase 		

9kW



WH-ADC0309J3E5
WH-ADC0309J3E5B
WH-UD09JE5
WH-ADC0309H3E5
WH-ADC0309H3E5B
WH-UD09HE5-1
WH-ADC0916H9E8
WH-UD09HE8

12kW



WH-ADC1216H6E5
WH-UD12HE5-1
WH-ADC0916H9E8
WH-UD12HE8

16kW



WH-ADC1216H6E5
WH-UD16HE5-1
WH-ADC0916H9E8
WH-UD16HE8



WH-SDC0709J3E5
WH-UD09JE5
WH-SDC09H3E5-1
WH-UD09HE5-1
WH-SDC09H3E8
WH-UD09HE8



WH-SDC12H6E5
WH-UD12HE5-1
WH-SDC12H9E8
WH-UD12HE8



WH-SDC16H6E5
WH-UD16HE5-1
WH-SDC16H9E8
WH-UD16HE8



WH-MDC09H3E5



WH-MDC12H6E5



WH-MDC16H6E5



WH-ADC1216H6E5
WH-UX09HE5
WH-ADC0916H9E8
WH-UX09HE8
WH-ADC0916H9E8
WH-UQ09HE8



WH-ADC1216H6E5
WH-UX12HE5
WH-ADC0916H9E8
WH-UX12HE8
WH-ADC0916H9E8
WH-UQ12HE8



WH-ADC0916H9E8
WH-UX16HE8
WH-ADC0916H9E8
WH-UQ16HE8



WH-SXC09H3E5
WH-UX09HE5
WH-SXC09H3E8
WH-UX09HE8
WH-SQC09H3E8
WH-UQ09HE8



WH-SXC12H6E5
WH-UX12HE5
WH-SXC12H9E8
WH-UX12HE8
WH-SQC12H9E8
WH-UQ12HE8



WH-SXC16H9E8
WH-UX16HE8
WH-SQC16H9E8
WH-UQ16HE8



WH-MXC09H3E5
WH-MXC09H3E8



WH-MXC12H6E5
WH-MXC12H9E8



WH-MXC16H9E8



WH-SHF09F3E5
WH-UH09FE5
WH-SHF09F3E8
WH-UH09FE8



WH-SHF12F6E5
WH-UH12FE5
WH-SHF12F9E8
WH-UH12FE8



WH-MHF09G3E5



WH-MHF12G6E5

New Aquarea High Performance All in One J Generation Single Phase. Heating and Cooling 1 or 2 zones • R32 Gas



NEW
2019

Technical focus

- Top level COP 5,33 · Reduced installation costs · Piping at the bottom of the All in One (easy to install) · Reduced installation time and minimised installation errors · Easy remote controller to set up · Reduced installation spaces · Electrical connections at the front · Easier installation and maintenance · Remote controller functions (cooling mode activation possible by software. This activation can only be done by service partner)

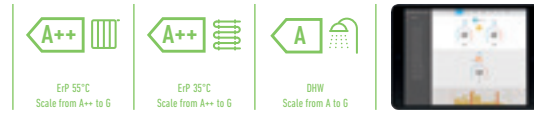

CZ-TAW1
Cloud connection. For user control and installer remote maintenance.

Tentative Data			Single Phase (Power to indoor)			
Kit* 1 zone (for 2 zone add B at the end)			KIT-ADC03JE5	KIT-ADC05JE5	KIT-ADC07JE5	KIT-ADC09JE5
Heating capacity / COP (A +7°C, W 35°C)	kW / COP		3,20 / 5,33	5,00 / 5,00	7,00 / 4,76	9,00 / 4,48
Heating capacity / COP (A +7°C, W 55°C)	kW / COP		3,20 / 2,81	5,00 / 2,72	7,00 / 2,82	8,95 / 2,78
Heating capacity / COP (A +2°C, W 35°C)	kW / COP		3,20 / 3,64	4,20 / 3,18	6,85 / 3,41	7,00 / 3,40
Heating capacity / COP (A +2°C, W 55°C)	kW / COP		3,20 / 2,19	4,10 / 1,99	6,20 / 2,21	6,30 / 2,16
Heating capacity / COP (A -7°C, W 35°C)	kW / COP		3,30 / 2,80	4,20 / 2,59	5,60 / 2,87	6,12 / 2,78
Heating capacity / COP (A -7°C, W 55°C)	kW / COP		3,20 / 1,79	3,55 / 1,71	5,25 / 1,94	5,90 / 1,93
Cooling capacity / EER (A 35°C, W 7°C)	kW / EER		3,20 / 3,52	4,50 / 3,00	6,70 / 3,03	7,60 / 2,90
Cooling capacity / EER (A 35°C, W 18°C)	kW / EER		3,20 / 4,85	4,80 / 4,29	6,70 / 4,72	7,60 / 4,37
Seasonal energy efficiency - Heating Average Climate (W35°C / W55°C)	ETA %		200 / 132	200 / 132	193 / 130	193 / 130
	SCOP		5,07 / 3,47	5,07 / 3,47	4,90 / 3,32	4,90 / 3,32
Energy Class Heating Average Climate (W35°C / W55°C) ¹⁾	A++ / A++		A++ / A++	A++ / A++	A++ / A++	A++ / A++
Energy Class Heating Average Climate (W35°C / W55°C) ¹⁾	A+++ / A++		A+++ / A++	A+++ / A++	A+++ / A++	A+++ / A++
Seasonal energy efficiency - Heating Warm Climate (W35°C / W55°C)	ETA %		245 / 155	245 / 155	227 / 160	227 / 160
	SCOP		6,20 / 4,20	6,20 / 4,20	5,75 / 4,07	5,75 / 4,07
Energy Class Heating Warm Climate (W35°C / W55°C)	A++ / A++		A++ / A++	A++ / A++	A++ / A++	A++ / A++
Energy Class Heating Warm Climate (W35°C / W55°C)	A+++ / A+++		A+++ / A+++	A+++ / A+++	A+++ / A+++	A+++ / A+++
Seasonal energy efficiency - Heating Cold Climate (W35°C / W55°C)	ETA %		157 / 99	157 / 99	164 / 116	164 / 116
	SCOP		4,00 / 2,83	4,00 / 2,83	4,18 / 2,98	4,18 / 2,98
Energy Class Heating Cold Climate (W35°C / W55°C)	A++ / A+		A++ / A+	A++ / A+	A++ / A+	A++ / A+
Energy Class Heating Cold Climate (W35°C / W55°C)	A+++ / A+		A+++ / A+	A+++ / A+	A+++ / A+	A+++ / A+
Indoor unit 1 zone hydrokit			WH-ADC0309J3E5	WH-ADC0309J3E5	WH-ADC0309J3E5	WH-ADC0309J3E5
Indoor unit 2 zones built-in hydrokit			WH-ADC0309J3E5B	WH-ADC0309J3E5B	WH-ADC0309J3E5B	WH-ADC0309J3E5B
Sound pressure	Heat / Cool	dB(A)	28 / 28	28 / 28	28 / 28	28 / 28
Dimension	HxWxD	mm	1800x598x717	1800x598x717	1800x598x717	1800x598x717
Net weight 1 zone / 2 zones		kg	122 / 130	122 / 130	122 / 130	122 / 130
Water pipe connector		Inch	R 1 1/4	R 1 1/4	R 1 1/4	R 1 1/4
A class pump	Number of speeds		Variable Speed	Variable Speed	Variable Speed	Variable Speed
	Input power (Min / Max)	W	30 / 120	30 / 120	30 / 120	30 / 120
Heating water flow (ΔT=5 K, 35°C)		L/min	9,20	14,30	20,10	25,80
Capacity of integrated electric heater		kW	3,00	3,00	3,00	3,00
Recommended fuse		A	16 / 16	16 / 16	25 / 16	25 / 16
Recommended cable size, supply 1 / 2		mm ²	3x1,5 / 3x1,5	3x1,5 / 3x1,5	3x2,5 / 3x1,5	3x2,5 / 3x1,5
Water volume		L	185	185	185	185
Maximum water temperature		°C	65	65	65	65
Material inside tank			Stainless steel	Stainless steel	Stainless steel	Stainless steel
Tapping profile according EN16147			L	L	L	L
DHW Tank ERP Average climate efficiency rating ²⁾	A to G / A+ to F		A / A+	A / A+	A / A+	A / A+
DHW Tank ERP Warm climate efficiency rating ²⁾	A to G / A+ to F		A / A+	A / A+	A / A+	A / A+
DHW Tank ERP Cold climate efficiency rating ²⁾	A to G / A+ to F		A / A	A / A	A / A	A / A
DHW Tank ERP Average climate ETA / SCOP	ETA % / SCOP		132 / 3,30	132 / 3,30	120 / 3,00	120 / 3,00
DHW Tank ERP Warm climate ETA / SCOP	ETA % / SCOP		155 / 3,88	155 / 3,88	140 / 3,50	140 / 3,50
DHW Tank ERP Cold climate ETA / SCOP	ETA % / SCOP		99 / 2,48	99 / 2,48	99 / 2,47	99 / 2,47
Outdoor unit			WH-UD03JE5	WH-UD05JE5	WH-UD07JE5	WH-UD09JE5
Sound power part load	Heat	dB	55	55	59	59
Sound power full load	Heat / Cool	dB	60 / 61	64 / 64	68 / 67	69 / 68
Dimension / Net weight	HxWxD	mm / kg	622x824x298 / 37	622x824x298 / 37	795x875x320 / 61	795x875x320 / 61
Refrigerant (R32) / CO ₂ Eq.		kg / T	0,9 / 0,608	0,9 / 0,608	1,27 / 0,857	1,27 / 0,857
Pipe diameter	Liquid / Gas	Inch (mm)	1/4 (6,35) / 1/2 (12,70)	1/4 (6,35) / 1/2 (12,70)	1/4 (6,35) / 5/8 (15,88)	1/4 (6,35) / 5/8 (15,88)
Pipe length range / Elevation difference (in/out)		m / m	3~25 / 20	3~25 / 20	3~50 / 30	3~50 / 30
Pipe length for additional gas / Additional gas amount		m / g/m	10 / 20	10 / 20	10 / 25	10 / 25
Operation range	Outdoor ambient	°C	-20 ~ +35	-20 ~ +35	-20 ~ +35	-20 ~ +35
Water outlet	Heat / Cool	°C	20 ~ 60 / 5 ~ 20	20 ~ 60 / 5 ~ 20	20 ~ 60 / 5 ~ 20	20 ~ 60 / 5 ~ 20

Accessories

PAW-ADC-PREKIT-1	Pre installation kit for piping
PAW-ADC-CV150	Decorative magnetic side cover
CZ-NS4P	Additional functions PCB

Accessories

CZ-TAW1	Aquarea Smart Cloud for remote control and maintenance through wireless or wired LAN
PAW-A2W-RTWIRED	Room thermostat

EER and COP calculation is based in accordance to EN14511. Sound pressure measured at 1m from the outdoor unit and at 1,5m height. Heating sound pressure measured at +7°C (heating water at 55°C). Insulated tested under EN12897.

¹⁾ Scale from A++ to G and from A+++ to D from 26th September 2019. ²⁾ Scale from A to G and from A+ to F from 26th September 2019.

This product is designed to comply with the European Water Quality Directive 98/83/EC amended by 2015/1787/EU. The lifespan of the product is not guaranteed in the case of the use of groundwater, such as spring water or well water, the use of tap water when salt or other impurities are contained, nor in areas of acidic water quality. Maintenance and warranty costs related to these cases are the customer's responsibility. * Available in Spring 2019.



INTERNET CONTROL: Optional. GOOD DESIGN AWARD 2017: Indoor units All in One and Bi-bloc H Generation awarded with the prestigious Good Design Award 2017.

New Aquarea High Performance Bi-bloc J Generation Single Phase. Heating and Cooling - SDC • R32 Gas



GOOD
DESIGN
AWARD
2017

NEW
2019



Technical focus

- Super efficient in the 3,2kW! • Very high energy savings A+++ (*) • Simple installation & maintenance • Special software for low consumption homes with minimum output temperature: 20°C • Works at temperatures as low as -20°C • Automatic Air purge valve • Display of the compressor frequency

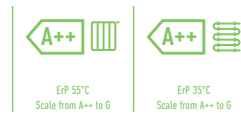

CZ-TAW1
Cloud connection. For user control and installer remote maintenance.

			Single Phase (Power to indoor)			
Kit			KIT-WC03J3E5	KIT-WC05J3E5	KIT-WC07J3E5	KIT-WC09J3E5
Heating capacity / COP (A +7°C, W 35°C)	kW / COP		3,20 / —	5,00 / —	7,00 / —	9,00 / —
Heating capacity / COP (A +7°C, W 55°C)	kW / COP		— / —	— / —	— / —	— / —
Heating capacity / COP (A +2°C, W 35°C)	kW / COP		— / —	— / —	— / —	— / —
Heating capacity / COP (A +2°C, W 55°C)	kW / COP		— / —	— / —	— / —	— / —
Heating capacity / COP (A -7°C, W 35°C)	kW / COP		— / —	— / —	— / —	— / —
Heating capacity / COP (A -7°C, W 55°C)	kW / COP		— / —	— / —	— / —	— / —
Cooling capacity / EER (A 35°C, W 7°C)	kW / EER		— / —	— / —	— / —	— / —
Cooling capacity / EER (A 35°C, W 18°C)	kW / EER		— / —	— / —	— / —	— / —
Seasonal energy efficiency - Heating Average Climate (W35°C / W55°C)	ETA %		— / —	— / —	— / —	— / —
	SCOP		— / —	— / —	— / —	— / —
Energy Class Heating Average Climate (W35°C / W55°C) ¹⁾	A++ to G		— / —	— / —	— / —	— / —
Energy Class Heating Average Climate (W35°C / W55°C) ¹⁾	A+++ to D		— / —	— / —	— / —	— / —
Seasonal energy efficiency - Heating Warm Climate (W35°C / W55°C)	ETA %		— / —	— / —	— / —	— / —
	SCOP		— / —	— / —	— / —	— / —
Energy Class Heating Warm Climate (W35°C / W55°C)	A++ to G		— / —	— / —	— / —	— / —
Energy Class Heating Warm Climate (W35°C / W55°C)	A+++ to D		— / —	— / —	— / —	— / —
Seasonal energy efficiency - Heating Cold Climate (W35°C / W55°C)	ETA %		— / —	— / —	— / —	— / —
	SCOP		— / —	— / —	— / —	— / —
Energy Class Heating Cold Climate (W35°C / W55°C)	A++ to G		— / —	— / —	— / —	— / —
Energy Class Heating Cold Climate (W35°C / W55°C)	A+++ to D		— / —	— / —	— / —	— / —
Indoor unit			WH-SDC0305J3E5	WH-SDC0305J3E5	WH-SDC0709J3E5	WH-SDC0709J3E5
Sound pressure	Heat / Cool	dB(A)	— / —	— / —	— / —	— / —
Dimension	HxWxD	mm	892 x 500 x 340	892 x 500 x 340	892 x 500 x 340	892 x 500 x 340
Net weight		kg	—	—	—	—
Water pipe connector		Inch	—	—	—	—
A class pump	Number of speeds		—	—	—	—
	Input power (Min / Max)	W	— / —	— / —	— / —	— / —
Heating water flow (ΔT=5 K, 35°C)		L/min	—	—	—	—
Capacity of integrated electric heater		kW	—	—	—	—
Recommended fuse		A	— / —	— / —	— / —	— / —
Recommended cable size, supply 1 / 2		mm ²	— / —	— / —	— / —	— / —
Outdoor unit			WH-UD03JE5	WH-UD05JE5	WH-UD07JE5	WH-UD09JE5
Sound power at Quiet Mode 3 (A +7°C, W 55°C)	dB		55	55	—	—
Sound power full load	Heat / Cool	dB	60 / 61	64 / 64	68 / 67	69 / 68
Dimension	HxWxD	mm	622 x 824 x 298	622 x 824 x 298	795 x 875 x 320	795 x 875 x 320
Net weight		kg	37	37	61	61
Refrigerant (R32) / CO ₂ Eq.		kg / T	0,9 / 0,608	0,9 / 0,608	1,27 / 0,857	1,27 / 0,857
Pipe diameter	Liquid / Gas	Inch (mm)	1/4 (6,35) / 1/2 (12,70)	1/4 (6,35) / 1/2 (12,70)	1/4 (6,35) / 5/8 (15,88)	1/4 (6,35) / 5/8 (15,88)
Pipe length range		m	3 ~ 25	3 ~ 25	3 ~ 50	3 ~ 50
Elevation difference (in/out)		m	20	20	30	30
Pipe length for additional gas		m	10	10	10	10
Additional gas amount		g/m	20	20	25	25
Operation range	Outdoor ambient	°C	-20 ~ +35	-20 ~ +35	-20 ~ +35	-20 ~ +35
Water outlet	Heat / Cool	°C	25 ~ 60 / 5 ~ 20	25 ~ 60 / 5 ~ 20	25 ~ 60 / 5 ~ 20	25 ~ 60 / 5 ~ 20

Accessories

PAW-TD20C1E5	Tank 200L - Stainless steel
PAW-TD30C1E5	Tank 300L - Stainless steel
PAW-TA20C1E5STD	Tank 200L - Enamelled
PAW-TA30C1E5STD	Tank 300L - Enamelled
PAW-3WYVLV-SI	External 3 way valve
CZ-NV1	3 way valve Kit for inside of hydrokit

Accessories

CZ-NS4P	Additional functions PCB
PAW-BTANK50L-1	Buffer tank 50L
CZ-TAW1	Aquarea Smart Cloud for remote control and maintenance through wireless or wired LAN
PAW-A2W-RTWIRED	Room thermostat

EER and COP calculation is based in accordance to EN14511. Sound pressure measured at 1m from the outdoor unit and at 1,5m height.

¹⁾ Scale from A++ to G and from A+++ to D from 26th September 2019.

* Available in Autumn 2019.



INTERNET CONTROL: Optional. GOOD DESIGN AWARD 2017: Indoor units All in One and Bi-bloc H Generation awarded with the prestigious Good Design Award 2017.

Aquarea High Performance All in One H Generation Single Phase. Heating and Cooling 1 or 2 zones • R410A Gas



**GOOD
DESIGN
AWARD
2017**

Technical focus

- Reduced installation costs · Piping at the bottom of the All in One (easy to install) · Reduced installation time and minimised installation errors · Easy remote controller to set up · Reduced installation spaces · Electrical connections at the front · Easier installation and maintenance · Remote controller functions (cooling mode activation possible by software. This activation can only be done by service partner)

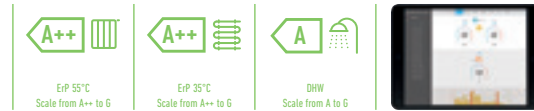

CZ-TAW1
Cloud connection. For user control and installer remote maintenance.

		Single Phase (Power to indoor)			
Kit 1 zone (for 2 zone add B at the end)		KIT-ADC03HE5	KIT-ADC05HE5	KIT-ADC07HE5	KIT-ADC09HE5
Heating capacity / COP (A +7°C, W 35°C)	kW / COP	3,20 / 5,00	5,00 / 4,63	7,00 / 4,46	9,00 / 4,13
Heating capacity / COP (A +7°C, W 55°C)	kW / COP	3,20 / 2,67	5,00 / 2,65	6,80 / 2,63	8,90 / 2,41
Heating capacity / COP (A +2°C, W 35°C)	kW / COP	3,20 / 3,56	4,20 / 3,11	6,55 / 3,34	6,70 / 3,13
Heating capacity / COP (A +2°C, W 55°C)	kW / COP	3,20 / 2,15	4,10 / 1,98	6,00 / 1,99	6,00 / 1,99
Heating capacity / COP (A -7°C, W 35°C)	kW / COP	3,20 / 2,69	4,20 / 2,59	5,15 / 2,68	5,90 / 2,52
Heating capacity / COP (A -7°C, W 55°C)	kW / COP	3,20 / 1,72	3,55 / 1,71	4,80 / 1,89	5,80 / 1,88
Cooling capacity / EER (A 35°C, W 7°C)	kW / EER	3,20 / 3,08	4,50 / 2,69	6,00 / 2,63	7,00 / 2,43
Cooling capacity / EER (A 35°C, W 18°C)	kW / EER	3,30 / 3,75	5,00 / 3,76	6,00 / 3,57	7,00 / 3,26
Seasonal energy efficiency - Heating Average Climate (W35°C / W55°C)	ETA %	195 / 130	195 / 130	190 / 130	190 / 130
	SCOP	4,95 / 3,33	4,95 / 3,33	4,83 / 3,33	4,83 / 3,33
Energy Class Heating Average Climate (W35°C / W55°C) ¹⁾	A++ to G	A++ / A++	A++ / A++	A++ / A++	A++ / A++
Energy Class Heating Average Climate (W35°C / W55°C) ¹⁾	A+++ to D	A+++ / A+++	A+++ / A+++	A+++ / A+++	A+++ / A+++
Seasonal energy efficiency - Heating Warm Climate (W35°C / W55°C)	ETA %	244 / 163	244 / 163	225 / 160	225 / 160
	SCOP	6,18 / 4,15	6,18 / 4,15	5,70 / 4,08	5,70 / 4,08
Energy Class Heating Warm Climate (W35°C / W55°C)	A++ to G	A++ / A++	A++ / A++	A++ / A++	A++ / A++
Energy Class Heating Warm Climate (W35°C / W55°C)	A+++ to D	A+++ / A+++	A+++ / A+++	A+++ / A+++	A+++ / A+++
Seasonal energy efficiency - Heating Cold Climate (W35°C / W55°C)	ETA %	150 / 103	150 / 103	160 / 115	160 / 115
	SCOP	3,83 / 2,65	3,83 / 2,65	4,08 / 2,95	4,08 / 2,95
Energy Class Heating Cold Climate (W35°C / W55°C)	A++ to G	A++ / A+	A++ / A+	A++ / A+	A++ / A+
Energy Class Heating Cold Climate (W35°C / W55°C)	A+++ to D	A+++ / A+	A+++ / A+	A+++ / A+	A+++ / A+
Indoor unit 1 zone hydrokit		WH-ADC0309H3E5	WH-ADC0309H3E5	WH-ADC0309H3E5	WH-ADC0309H3E5
Indoor unit 2 zones built-in hydrokit		WH-ADC0309H3E5B	WH-ADC0309H3E5B	WH-ADC0309H3E5B	WH-ADC0309H3E5B
Sound pressure	Heat / Cool	dB(A)	28 / 28	28 / 28	28 / 28
Dimension / Net weight	HxWxD	mm / kg	1800x598x717 / 124	1800x598x717 / 124	1800x598x717 / 124
Water pipe connector		Inch	R1	R1	R1
A class pump	Number of speeds		Variable Speed	Variable Speed	Variable Speed
	Input power (Min / Max)	W	30 / 120	30 / 120	30 / 120
Heating water flow (ΔT=5 K, 35°C)		L/min	9,2	14,3	20,1
Capacity of integrated electric heater		kW	3	3	3
Recommended fuse		A	15 / 15	15 / 15	30 / 15
Recommended cable size, supply 1 & 2		mm ²	3x1,5 / 3x1,5	3x1,5 / 3x1,5	3x2,5 / 3x1,5
Water volume		L	185	185	185
Maximum water temperature		°C	65	65	65
Material inside tank			Stainless steel	Stainless steel	Stainless steel
Tapping profile according EN16147		L	L	L	L
DHW Tank ERP Average climate efficiency rating ²⁾	A to G / A+ to F	A / A+	A / A+	A / A	A / A
DHW Tank ERP Warm climate efficiency rating ²⁾	A to G / A+ to F	A / A+	A / A+	A / A+	A / A+
DHW Tank ERP Cold climate efficiency rating ²⁾	A to G / A+ to F	A / A	A / A	A / A	A / A
DHW Tank ERP Average climate ETA / SCOP	ETA % / SCOP	120 / 3,00	120 / 3,00	113 / 2,83	113 / 2,83
DHW Tank ERP Warm climate ETA / SCOP	ETA % / SCOP	147 / 3,68	147 / 3,68	132 / 3,30	132 / 3,30
DHW Tank ERP Cold climate ETA / SCOP	ETA % / SCOP	94 / 2,35	94 / 2,15	86 / 2,15	86 / 1,88
Outdoor unit		WH-UD03HE5-1	WH-UD05HE5-1	WH-UD07HE5-1	WH-UD09HE5-1
Sound power full load	Heat / Cool	dB	64 / 65	65 / 66	68 / 66
Dimension / Net weight	HxWxD	mm / kg	622x824x298 / 39	622x824x298 / 39	795x900x320 / 66
Refrigerant (R410A) / CO ₂ Eq.		kg / T	1,20 / 2,506	1,20 / 2,506	1,45 / 3,028
Pipe diameter	Liquid / Gas	Inch (mm)	1/4 (6,35) / 1/2 (12,70)	1/4 (6,35) / 1/2 (12,70)	1/4 (6,35) / 5/8 (15,88)
Pipe length range / Elevation difference (in/out)		m / m	3 ~ 15 / 5	3 ~ 15 / 5	3 ~ 40 / 30
Pipe length for additional gas / Additional gas amount		m / g/m	10 / 20	10 / 20	10 / 30
Operation range	Outdoor ambient	°C	-20 ~ +35	-20 ~ +35	-20 ~ +35
Water outlet	Heat / Cool	°C	20 ~ 55 / 5 ~ 20	20 ~ 55 / 5 ~ 20	20 ~ 55 / 5 ~ 20
3rd Party tested Sound power at Quiet Mode 3 ³⁾		dB	52	58	57
Accessories					
PAW-ADC-PREKIT-1	Pre installation kit for piping				
PAW-ADC-CV150	Decorative magnetic side cover				
CZ-NS4P	Additional functions PCB				
Accessories					
CZ-TAW1	Aquarea Smart Cloud for remote control and maintenance through wireless or wired LAN				
PAW-A2W-RTWIRED	Room thermostat				

EER and COP calculation is based in accordance to EN14511. Sound pressure measured at 1m from the outdoor unit and at 1,5m height. Heating sound pressure measured at +7°C (heating water at 55°C). Insulated tested under EN12897.

¹⁾ Scale from A++ to G and from A+++ to D from 26th September 2019. ²⁾ Scale from A to G and from A+ to F from 26th September 2019. ³⁾ Third party tested sound power at Quiet mode 3 (A +7°C, W 55°C).

This product is designed to comply with the European Water Quality Directive 98/83/EC amended by 2015/1787/EU. The lifespan of the product is not guaranteed in the case of the use of groundwater, such as spring water or well water, the use of tap water when salt or other impurities are contained, nor in areas of acidic water quality. Maintenance and warranty costs related to these cases are the customer's responsibility.



INTERNET CONTROL: Optional. GOOD DESIGN AWARD 2017: Indoor units All in One and Bi-Bloc H Generation awarded with the prestigious Good Design Award 2017.

Aquarea High Performance All in One H Generation Single Phase / Three Phase. Heating and Cooling • R410A Gas



Technical focus

- Reduced installation costs · Piping at the bottom of the All in One (easy to install) · Reduced installation time and minimised installation errors · Easy remote controller to set up · Reduced installation spaces · Electrical connections at the front · Easier installation and maintenance · Remote controller functions (cooling mode activation possible by software. This activation can only be done by service partner)

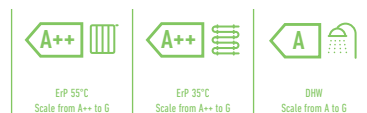

CZ-TAW1
Cloud connection. For user control and installer remote maintenance.

Kit	Single Phase (Power to indoor)					Three Phase (Power to indoor)					
	KIT-ADC12HE5	KIT-ADC16HE5	KIT-ADC09HE8	KIT-ADC12HE8	KIT-ADC16HE8	KIT-ADC12HE5	KIT-ADC16HE5	KIT-ADC09HE8	KIT-ADC12HE8	KIT-ADC16HE8	
Heating capacity / COP (A +7°C, W 35°C)	kW / COP	12,00 / 4,74	16,00 / 4,28	9,00 / 4,84	12,00 / 4,74	16,00 / 4,28	9,00 / 4,84	12,00 / 4,74	16,00 / 4,28	16,00 / 4,28	
Heating capacity / COP (A +7°C, W 55°C)	kW / COP	12,00 / 2,88	14,50 / 2,68	9,00 / 2,94	12,00 / 2,88	14,50 / 2,68	9,00 / 2,94	12,00 / 2,88	14,50 / 2,68	14,50 / 2,68	
Heating capacity / COP (A +2°C, W 35°C)	kW / COP	11,40 / 3,44	13,00 / 3,28	9,00 / 3,59	11,40 / 3,44	13,00 / 3,28	9,00 / 3,59	11,40 / 3,44	13,00 / 3,28	13,00 / 3,28	
Heating capacity / COP (A +2°C, W 55°C)	kW / COP	9,10 / 2,20	9,80 / 2,17	8,80 / 2,23	9,10 / 2,20	9,80 / 2,17	8,80 / 2,23	9,10 / 2,20	9,80 / 2,17	9,80 / 2,17	
Heating capacity / COP (A -7°C, W 35°C)	kW / COP	10,00 / 2,73	11,40 / 2,57	9,00 / 2,85	10,00 / 2,73	11,40 / 2,57	9,00 / 2,85	10,00 / 2,73	11,40 / 2,57	11,40 / 2,57	
Heating capacity / COP (A -7°C, W 55°C)	kW / COP	8,20 / 1,92	9,00 / 1,82	7,90 / 2,05	8,20 / 1,92	9,00 / 1,82	7,90 / 2,05	8,20 / 1,92	9,00 / 1,82	9,00 / 1,82	
Cooling capacity / EER (A 35°C, W 7°C)	kW / EER	10,00 / 2,81	12,20 / 2,56	7,00 / 3,17	10,00 / 2,85	12,20 / 2,56	7,00 / 3,17	10,00 / 2,85	12,20 / 2,56	12,20 / 2,56	
Cooling capacity / EER (A 35°C, W 18°C)	kW / EER	10,00 / 4,17	12,20 / 4,12	7,00 / 4,61	10,00 / 4,17	12,20 / 4,12	7,00 / 4,61	10,00 / 4,17	12,20 / 4,12	12,20 / 4,12	
Seasonal energy efficiency - Heating Average Climate (W35°C / W55°C)	ETA %	190 / 134	190 / 130	190 / 133	190 / 134	190 / 130	190 / 133	190 / 134	190 / 130	190 / 130	
	SCOP	4,83 / 3,43	4,83 / 3,33	4,83 / 3,40	4,83 / 3,43	4,83 / 3,33	4,83 / 3,40	4,83 / 3,43	4,83 / 3,33	4,83 / 3,33	
Energy Class Heating Average Climate (W35°C / W55°C) ¹⁾	A++ to G	A++ / A++	A++ / A++	A++ / A++	A++ / A++	A++ / A++	A++ / A++	A++ / A++	A++ / A++	A++ / A++	
Energy Class Heating Average Climate (W35°C / W55°C) ¹⁾	A+++ to D	A+++ / A++	A+++ / A++	A+++ / A++	A+++ / A++	A+++ / A++	A+++ / A++	A+++ / A++	A+++ / A++	A+++ / A++	
Seasonal energy efficiency - Heating Warm Climate (W35°C / W55°C)	ETA %	245 / 159	245 / 169	245 / 159	245 / 159	245 / 169	245 / 159	245 / 159	245 / 169	245 / 169	
	SCOP	6,20 / 4,05	6,20 / 4,30	6,20 / 4,05	6,20 / 4,05	6,20 / 4,30	6,20 / 4,05	6,20 / 4,05	6,20 / 4,30	6,20 / 4,30	
Energy Class Heating Warm Climate (W35°C / W55°C)	A++ to G	A++ / A++	A++ / A++	A++ / A++	A++ / A++	A++ / A++	A++ / A++	A++ / A++	A++ / A++	A++ / A++	
Energy Class Heating Warm Climate (W35°C / W55°C)	A+++ to D	A+++ / A+++	A+++ / A+++	A+++ / A+++	A+++ / A+++	A+++ / A+++	A+++ / A+++	A+++ / A+++	A+++ / A+++	A+++ / A+++	
Seasonal energy efficiency - Heating Cold Climate (W35°C / W55°C)	ETA %	168 / 121	168 / 121	168 / 121	168 / 121	168 / 121	168 / 121	168 / 121	168 / 121	168 / 121	
	SCOP	4,28 / 3,10	4,28 / 3,10	4,28 / 3,10	4,28 / 3,10	4,28 / 3,10	4,28 / 3,10	4,28 / 3,10	4,28 / 3,10	4,28 / 3,10	
Energy Class Heating Cold Climate (W35°C / W55°C)	A++ to G	A++ / A+	A++ / A+	A++ / A+	A++ / A+	A++ / A+	A++ / A+	A++ / A+	A++ / A+	A++ / A+	
Energy Class Heating Cold Climate (W35°C / W55°C)	A+++ to D	A+++ / A+	A+++ / A+	A+++ / A+	A+++ / A+	A+++ / A+	A+++ / A+	A+++ / A+	A+++ / A+	A+++ / A+	
Indoor unit		WH-ADC1216H6E5	WH-ADC1216H6E5	WH-ADC0916H9E8	WH-ADC0916H9E8	WH-ADC0916H9E8	WH-ADC0916H9E8	WH-ADC0916H9E8	WH-ADC0916H9E8	WH-ADC0916H9E8	
Sound pressure	Heat / Cool	dB(A)		33 / 33		33 / 33		33 / 33		33 / 33	
Dimension / Net weight	H x W x D	mm / kg		1800x598x717 / 124		1800x598x717 / 124		1800x598x717 / 126		1800x598x717 / 126	
Water pipe connector		Inch		R1		R1		R1		R1	
A class pump	Number of speeds	Variable Speed		Variable Speed		Variable Speed		Variable Speed		Variable Speed	
	Input power (Min / Max)	W		36 / 152		36 / 152		36 / 152		36 / 152	
Heating water flow (ΔT=5 K, 35°C)		L/min		34,4		45,9		25,8		34,4	
Capacity of integrated electric heater		kW		6		6		9		9	
Recommended fuse		A		30 / 30		30 / 30		16 / 16		16 / 16	
Recommended cable size, supply 1 & 2		mm ²		3x4,0 / 3x4,0		3x4,0 / 3x4,0		5x1,5 / 5x1,5		5x1,5 / 5x1,5	
Water volume		L		185		185		185		185	
Maximum water temperature		°C		65		65		65		65	
Material inside tank		Stainless steel		Stainless steel		Stainless steel		Stainless steel		Stainless steel	
Tapping profile according EN16147		L		L		L		L		L	
DHW Tank ERP Average climate efficiency rating ²⁾	A to G / A+ to F	A/A		A/A		A/A		A/A		A/A	
DHW Tank ERP Warm climate efficiency rating ²⁾	A to G / A+ to F	A/A		A/A		A/A		A/A		A/A	
DHW Tank ERP Cold climate efficiency rating ²⁾	A to G / A+ to F	A/A		B/B		A/A		A/A		B/B	
DHW Tank ERP Average climate ETA / SCOP	ETA % / SCOP	95 / 2,38		91 / 2,28		95 / 2,38		95 / 2,38		91 / 2,28	
DHW Tank ERP Warm climate ETA / SCOP	ETA % / SCOP	110 / 2,75		107 / 2,68		110 / 2,75		110 / 2,75		107 / 2,68	
DHW Tank ERP Cold climate ETA / SCOP	ETA % / SCOP	75 / 1,80		72 / 1,88		75 / 1,88		75 / 1,80		72 / 1,88	
Outdoor unit		WH-UD12HE5-1	WH-UD16HE5-1	WH-UD09HE8	WH-UD12HE8	WH-UD16HE8	WH-UD12HE8	WH-UD16HE8	WH-UD12HE8	WH-UD16HE8	
Sound power full load	Heat / Cool	dB		69 / 68		72 / 72		68 / 67		69 / 68	
Dimension / Net weight	H x W x D	mm / kg		1340x900x320 / 101		1340x900x320 / 101		1340x900x320 / 107		1340x900x320 / 107	
Refrigerant (R410A) / CO ₂ Eq.		kg / T		2,55 / 5,324		2,55 / 5,324		2,55 / 5,324		2,55 / 5,324	
Pipe diameter	Liquid / Gas	Inch (mm)		3/8(9,52) / 5/8(15,88)		3/8(9,52) / 5/8(15,88)		3/8(9,52) / 5/8(15,88)		3/8(9,52) / 5/8(15,88)	
Pipe length range / Elevation difference (in/out)		m / m		3 ~ 50 / 30		3 ~ 50 / 30		3 ~ 30 / 30		3 ~ 30 / 30	
Pipe length for additional gas / Additional gas amount		m / g/m		10 / 50		10 / 50		10 / 50		10 / 50	
Operation range	Outdoor ambient	°C		-20 ~ +35		-20 ~ +35		-20 ~ +35		-20 ~ +35	
Water outlet	Heat / Cool	°C		20 ~ 55 / 5 ~ 20		20 ~ 55 / 5 ~ 20		20 ~ 55 / 5 ~ 20		20 ~ 55 / 5 ~ 20	
3rd Party tested Sound power at Quiet Mode 3 ³⁾		dB		65		65		63		65	

Accessories	
PAW-ADC-PREKIT-1	Pre installation kit for piping
PAW-ADC-CV150	Decorative magnetic side cover
CZ-NS4P	Additional functions PCB

Accessories	
CZ-TAW1	Aquarea Smart Cloud for remote control and maintenance through wireless or wired LAN
PAW-A2W-RTWIRED	Room thermostat

EER and COP calculation is based in accordance to EN14511. Sound pressure measured at 1m from the outdoor unit and at 1,5m height. Heating sound pressure measured at +7°C (heating water at 55°C). Insulated tested under EN12897. ¹⁾ Scale from A++ to G and from A+++ to D from 26th September 2019. ²⁾ Scale from A to G and from A+ to F from 26th September 2019. ³⁾ Third party tested sound power at Quiet mode 3 (A +7°C, W 55°C). This product is designed to comply with the European Water Quality Directive 98/83/EC amended by 2015/1787/EU. The lifespan of the product is not guaranteed in the case of the use of groundwater, such as spring water or well water, the use of tap water when salt or other impurities are contained, nor in areas of acidic water quality. Maintenance and warranty costs related to these cases are the customer's responsibility.



INTERNET CONTROL: Optional. GOOD DESIGN AWARD 2017: Indoor units All in One and Bi-bloc H Generation awarded with the prestigious Good Design Award 2017.

Aquarea T-CAP All in One H Generation

Single Phase / Three Phase.

Heating and Cooling • R410A Gas



**GOOD
DESIGN
AWARD
2017**

Technical focus

- Works at temperatures as low as -28°C · Constant capacity up to -20°C · Reduced installation costs · Reduced installation time and minimised installation errors · Easy remote controller to set up · Electrical connections at the front · Easier installation and maintenance · Remote controller functions (cooling mode activation possible by software. This activation can only be done by service partner)



CZ-TAW1
Cloud connection. For user control and installer remote maintenance.

Kit	Single Phase (Power to indoor)			Three Phase (Power to indoor)		
	KIT-AXC9HE5	KIT-AXC12HE5	KIT-AXC9HE8	KIT-AXC12HE8	KIT-AXC16HE8	
Heating capacity / COP (A +7°C, W 35°C)	kW / COP	9,00 / 4,84	12,00 / 4,74	9,00 / 4,84	12,00 / 4,74	16,00 / 4,28
Heating capacity / COP (A +7°C, W 55°C)	kW / COP	9,00 / 2,94	12,00 / 2,88	9,00 / 2,94	12,00 / 2,88	16,00 / 2,71
Heating capacity / COP (A +2°C, W 35°C)	kW / COP	9,00 / 3,59	12,00 / 3,44	9,00 / 3,59	12,00 / 3,44	16,00 / 3,10
Heating capacity / COP (A +2°C, W 55°C)	kW / COP	9,00 / 2,21	12,00 / 2,19	9,00 / 2,21	12,00 / 2,19	16,00 / 2,13
Heating capacity / COP (A -7°C, W 35°C)	kW / COP	9,00 / 2,85	12,00 / 2,72	9,00 / 2,85	12,00 / 2,72	16,00 / 2,49
Heating capacity / COP (A -7°C, W 55°C)	kW / COP	9,00 / 2,02	12,00 / 1,92	9,00 / 2,02	12,00 / 1,92	16,00 / 1,86
Cooling capacity / EER (A 35°C, W 7°C)	kW / EER	7,00 / 3,17	10,00 / 2,81	7,00 / 3,17	10,00 / 2,81	12,20 / 2,57
Cooling capacity / EER (A 35°C, W 18°C)	kW / EER	7,00 / 5,19	10,00 / 5,13	7,00 / 5,19	10,00 / 5,13	12,20 / 3,49
Seasonal energy efficiency - Heating Average Climate (W35°C / W55°C)	ETA %	181 / 130	170 / 130	181 / 130	170 / 130	160 / 125
	SCOP	4,60 / 3,33	4,33 / 3,33	4,60 / 3,33	4,33 / 3,33	4,08 / 3,20
Energy Class Heating Average Climate (W35°C / W55°C) ¹⁾	A++ to G	A++ / A++	A++ / A++	A++ / A++	A++ / A++	A++ / A++
Energy Class Heating Average Climate (W35°C / W55°C) ¹⁾	A+++ to D	A+++ / A+++	A+++ / A+++	A+++ / A+++	A+++ / A+++	A+++ / A+++
Seasonal energy efficiency - Heating Warm Climate (W35°C / W55°C)	ETA %	235 / 158	231 / 158	235 / 158	231 / 158	231 / 159
	SCOP	5,95 / 4,03	5,85 / 4,03	5,95 / 4,03	5,85 / 4,03	5,85 / 4,05
Energy Class Heating Warm Climate (W35°C / W55°C)	A++ to G	A++ / A++	A++ / A++	A++ / A++	A++ / A++	A++ / A++
Energy Class Heating Warm Climate (W35°C / W55°C)	A+++ to D	A+++ / A+++	A+++ / A+++	A+++ / A+++	A+++ / A+++	A+++ / A+++
Seasonal energy efficiency - Heating Cold Climate (W35°C / W55°C)	ETA %	160 / 125	160 / 125	160 / 125	160 / 125	150 / 125
	SCOP	4,08 / 3,20	4,08 / 3,20	4,08 / 3,20	4,08 / 3,20	3,83 / 3,20
Energy Class Heating Cold Climate (W35°C / W55°C)	A++ to G	A++ / A++	A++ / A++	A++ / A++	A++ / A++	A++ / A++
Energy Class Heating Cold Climate (W35°C / W55°C)	A+++ to D	A+++ / A+++	A+++ / A+++	A+++ / A+++	A+++ / A+++	A+++ / A+++
Indoor unit		WH-ADC1216H6E5	WH-ADC1216H6E5	WH-ADC0916H9E8	WH-ADC0916H9E8	WH-ADC0916H9E8
Sound pressure	Heat / Cool	dB(A)	33 / 33	33 / 33	33 / 33	33 / 33
Dimension / Net weight	HxWxD	mm / kg	1800x598x717/124	1800x598x717/124	1800x598x717/126	1800x598x717/126
Water pipe connector		Inch	R1	R1	R1	R1
A class pump	Number of speeds		Variable Speed	Variable Speed	Variable Speed	Variable Speed
	Input power (Min / Max)	W	36 / 152	36 / 152	36 / 152	36 / 152
Heating water flow (ΔT=5 K, 35°C)		L/min	25,8	34,4	25,8	34,4
Capacity of integrated electric heater		kW	6	6	9	9
Recommended fuse		A	30 / 30	30 / 30	16 / 16	16 / 16
Recommended cable size, supply 1 & 2		mm ²	3x4,0/3x4,0	3x4,0/3x4,0	5x1,5/5x1,5	5x1,5/5x1,5
Water volume		L	185	185	185	185
Maximum water temperature		°C	65	65	65	65
Material inside tank			Stainless steel	Stainless steel	Stainless steel	Stainless steel
Tapping profile according EN16147		L	L	L	L	L
DHW Tank ERP Average climate efficiency rating ²⁾	A to G / A+ to F	A / A	A / A	A / A	A / A	A / A
DHW Tank ERP Warm climate efficiency rating ²⁾	A to G / A+ to F	A / A	A / A	A / A	A / A	A / A
DHW Tank ERP Cold climate efficiency rating ²⁾	A to G / A+ to F	A / A	A / A	A / A	A / A	B / B
DHW Tank ERP Average climate ETA / SCOP	ETA % / SCOP	95 / 2,38	95 / 2,38	95 / 2,38	95 / 2,38	91 / 2,28
DHW Tank ERP Warm climate ETA / SCOP	ETA % / SCOP	110 / 2,75	110 / 2,75	110 / 2,75	110 / 2,75	107 / 2,68
DHW Tank ERP Cold climate ETA / SCOP	ETA % / SCOP	75 / 1,88	75 / 1,88	75 / 1,88	75 / 1,80	72 / 1,88
Outdoor unit		WH-UX09HE5	WH-UX12HE5	WH-UX09HE8	WH-UX12HE8	WH-UX16HE8
Sound power full load	Heat / Cool	dB	68 / 67	69 / 68	68 / 67	72 / 71
Dimension / Net weight	HxWxD	mm / kg	1340x900x320/101	1340x900x320/101	1340x900x320/108	1340x900x320/118
Refrigerant (R410A) / CO ₂ Eq.		kg / T	2,85 / 5,951	2,85 / 5,951	2,85 / 5,951	2,90 / 6,055
Pipe diameter	Liquid / Gas	Inch (mm)	3/8(9,52) / 5/8(15,88)	3/8(9,52) / 5/8(15,88)	3/8(9,52) / 5/8(15,88)	3/8(9,52) / 5/8(15,88)
Pipe length range / Elevation difference (in/out)		m / m	3~30 / 20	3~30 / 20	3~30 / 20	3~30 / 20
Pipe length for additional gas / Additional gas amount		m / g/m	10 / 50	10 / 50	10 / 50	10 / 50
Operation range	Outdoor ambient	°C	-28 ~ +35	-28 ~ +35	-28 ~ +35	-28 ~ +35
Water outlet	Heat / Cool	°C	20~60 / 5~20	20~60 / 5~20	20~60 / 5~20	20~60 / 5~20
3rd Party tested Sound power at Quiet Mode 3 ³⁾		dB	62	64	62	64

Accessories

PAW-ADC-PREKIT-1	Pre installation kit for piping
PAW-ADC-CV150	Decorative magnetic side cover
CZ-NS4P	Additional functions PCB

Accessories

CZ-TAW1	Aquarea Smart Cloud for remote control and maintenance through wireless or wired LAN
PAW-A2W-RTWIRED	Room thermostat

EER and COP calculation is based in accordance to EN14511. Sound pressure measured at 1m from the outdoor unit and at 1,5m height. Heating sound pressure measured at +7°C (heating water at 55°C). Insulated tested under EN12897.

¹⁾ Scale from A++ to G and from A+++ to D from 26th September 2019. ²⁾ Scale from A to G and from A+ to F from 26th September 2019. ³⁾ Third party tested sound power at Quiet mode 3 (A +7°C, W 55°C).

This product is designed to comply with the European Water Quality Directive 98/83/EC amended by 2015/1787/EU. The lifespan of the product is not guaranteed in the case of the use of groundwater, such as spring water or well water, the use of tap water when salt or other impurities are contained, nor in areas of acidic water quality. Maintenance and warranty costs related to these cases are the customer's responsibility.



INTERNET CONTROL: Optional. GOOD DESIGN AWARD 2017: Indoor units All in One and Bi-Block H Generation awarded with the prestigious Good Design Award 2017.

Aquarea T-CAP All in One H Generation Three Phase. Super Quiet outdoor unit. Heating and Cooling • R410A Gas



**GOOD
DESIGN
AWARD
2017**

Technical focus

- Works at temperatures as low as -28°C · Constant capacity up to -20°C · Reduced installation costs · Reduced installation time and minimised installation errors · Easy remote controller to set up · Electrical connections at the front · Easier installation and maintenance · Remote controller functions (cooling mode activation possible by software. This activation can only be done by service partner)

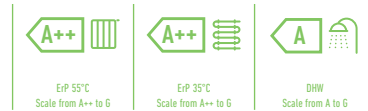

CZ-TAW1
Cloud connection. For user control and installer remote maintenance.

Three Phase (Power to indoor)

Kit			KIT-AQC9HE8	KIT-AQC12HE8	KIT-AQC16HE8
Heating capacity / COP (A +7°C, W 35°C)	kW / COP		9,00 / 4,84	12,00 / 4,74	16,00 / 4,28
Heating capacity / COP (A +7°C, W 55°C)	kW / COP		9,00 / 2,94	12,00 / 2,88	16,00 / 2,71
Heating capacity / COP (A +2°C, W 35°C)	kW / COP		9,00 / 3,59	12,00 / 3,44	16,00 / 3,10
Heating capacity / COP (A +2°C, W 55°C)	kW / COP		9,00 / 2,21	12,00 / 2,19	16,00 / 2,13
Heating capacity / COP (A -7°C, W 35°C)	kW / COP		9,00 / 2,85	12,00 / 2,72	16,00 / 2,49
Heating capacity / COP (A -7°C, W 55°C)	kW / COP		9,00 / 2,02	12,00 / 1,92	16,00 / 1,86
Cooling capacity / EER (A 35°C, W 7°C)	kW / EER		7,00 / 3,17	10,00 / 2,81	12,20 / 2,57
Cooling capacity / EER (A 35°C, W 18°C)	kW / EER		7,00 / 5,19	10,00 / 5,13	12,20 / 3,49
Seasonal energy efficiency - Heating Average Climate (W35°C / W55°C)	ETA %		181 / 130	170 / 130	160 / 125
	SCOP		4,60 / 3,33	4,33 / 3,33	4,08 / 3,20
Energy Class Heating Average Climate (W35°C / W55°C) ¹⁾	A++ to G		A++ / A++	A++ / A++	A++ / A++
Energy Class Heating Average Climate (W35°C / W55°C) ¹⁾	A+++ to D		A+++ / A+++	A+++ / A+++	A+++ / A+++
Seasonal energy efficiency - Heating Warm Climate (W35°C / W55°C)	ETA %		235 / 158	231 / 158	231 / 159
	SCOP		5,95 / 4,03	5,85 / 4,03	5,85 / 4,05
Energy Class Heating Warm Climate (W35°C / W55°C)	A++ to G		A++ / A++	A++ / A++	A++ / A++
Energy Class Heating Warm Climate (W35°C / W55°C)	A+++ to D		A+++ / A+++	A+++ / A+++	A+++ / A+++
Seasonal energy efficiency - Heating Cold Climate (W35°C / W55°C)	ETA %		160 / 125	160 / 125	150 / 125
	SCOP		4,08 / 3,20	4,08 / 3,20	3,83 / 3,20
Energy Class Heating Cold Climate (W35°C / W55°C)	A++ to G		A++ / A++	A++ / A++	A++ / A++
Energy Class Heating Cold Climate (W35°C / W55°C)	A+++ to D		A+++ / A+++	A+++ / A+++	A+++ / A+++
Indoor unit			WH-ADC0916H9E8	WH-ADC0916H9E8	WH-ADC0916H9E8
Sound pressure	Heat / Cool	dB(A)	33 / 33	33 / 33	33 / 33
Dimension / Net weight	H x W x D	mm / kg	1800 x 598 x 717 / 126	1800 x 598 x 717 / 126	1800 x 598 x 717 / 126
Water pipe connector		Inch	R1	R1	R1
A class pump	Number of speeds		Variable Speed	Variable Speed	Variable Speed
	Input power (Min / Max)	W	36 / 152	36 / 152	36 / 152
Heating water flow (ΔT=5 K, 35°C)		L/min	25,8	34,4	45,9
Capacity of integrated electric heater		kW	9	9	9
Recommended fuse		A	16 / 16	16 / 16	16 / 16
Recommended cable size, supply 1 & 2		mm ²	5 x 1,5 / 5 x 1,5	5 x 1,5 / 5 x 1,5	5 x 1,5 / 5 x 1,5
Water volume		L	185	185	185
Maximum water temperature		°C	65	65	65
Material inside tank			Stainless steel	Stainless steel	Stainless steel
Tapping profile according EN16147			L	L	L
DHW Tank ERP Average climate efficiency rating ²⁾	A to G / A+ to F		A / A	A / A	A / A
DHW Tank ERP Warm climate efficiency rating ²⁾	A to G / A+ to F		A / A	A / A	A / A
DHW Tank ERP Cold climate efficiency rating ²⁾	A to G / A+ to F		A / A	A / A	B / B
DHW Tank ERP Average climate ETA / SCOP	ETA % / SCOP		95 / 2,38	95 / 2,38	91 / 2,28
DHW Tank ERP Warm climate ETA / SCOP	ETA % / SCOP		110 / 2,75	110 / 2,75	107 / 2,68
DHW Tank ERP Cold climate ETA / SCOP	ETA % / SCOP		75 / 1,88	75 / 1,80	72 / 2,35
Outdoor unit			WH-UQ09HE8	WH-UQ12HE8	WH-UQ16HE8
Sound power full load	Heat / Cool	dB	61 / 63	62 / 64	65 / 68
Dimension / Net weight	H x W x D	mm / kg	1410 x 1283 x 320 / 151	1410 x 1283 x 320 / 151	1410 x 1283 x 320 / 161
Refrigerant (R410A) / CO ₂ Eq.		kg / T	2,85 / 5,951	2,85 / 5,951	2,99 / 6,243
Pipe diameter	Liquid / Gas	Inch (mm)	3/8 (9,52) / 5/8 (15,88)	3/8 (9,52) / 5/8 (15,88)	3/8 (9,52) / 5/8 (15,88)
Pipe length range / Elevation difference (in/out)		m / m	3 - 30 / 20	3 - 30 / 20	3 - 30 / 20
Pipe length for additional gas / Additional gas amount		m / g/m	10 / 50	10 / 50	10 / 50
Operation range	Outdoor ambient	°C	-28 ~ +35	-28 ~ +35	-28 ~ +35
Water outlet	Heat / Cool	°C	20 - 60 / 5 - 20	20 - 60 / 5 - 20	20 - 60 / 5 - 20
3rd Party tested Sound power at Quiet Mode 3 ³⁾		dB	55	54	58

Accessories

PAW-ADC-PREKIT-1	Pre installation kit for piping
PAW-ADC-CV150	Decorative magnetic side cover
CZ-NS4P	Additional functions PCB

Accessories

CZ-TAW1	Aquarea Smart Cloud for remote control and maintenance through wireless or wired LAN
PAW-A2W-RTWIRED	Room thermostat

EER and COP calculation is based in accordance to EN14511. Sound pressure measured at 1m from the outdoor unit and at 1,5m height. Heating sound pressure measured at +7°C (heating water at 55°C). Insulated tested under EN12897.

1) Scale from A++ to G and from A+++ to D from 26th September 2019. 2) Scale from A to G and from A+ to F from 26th September 2019. 3) Third party tested sound power at Quiet mode 3 (A +7°C, W 55°C).

This product is designed to comply with the European Water Quality Directive 98/83/EC amended by 2015/1787/EU. The lifespan of the product is not guaranteed in the case of the use of groundwater, such as spring water or well water, the use of tap water when salt or other impurities are contained, nor in areas of acidic water quality. Maintenance and warranty costs related to these cases are the customer's responsibility.



INTERNET CONTROL: Optional. GOOD DESIGN AWARD 2017: Indoor units All in One and Bi-bloc H Generation awarded with the prestigious Good Design Award 2017.

Aquarea High Performance Bi-bloc H Generation Single Phase. Heating and Cooling - SDC • R410A Gas



**GOOD
DESIGN
AWARD
2017**



Technical focus

- Very high energy savings A+++ (*) · Simple installation & maintenance · Special software for low consumption homes with minimum output temperature: 20°C · Works at temperatures as low as -20°C · Automatic Air purge valve · Display of the compressor frequency

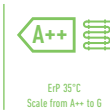
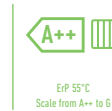

CZ-TAW1
Cloud connection. For user control and installer remote maintenance.

			Single Phase Heating and Cooling			
Kit			KIT-WC03H3E5	KIT-WC05H3E5	KIT-WC07H3E5	KIT-WC09H3E5
Heating capacity / COP (A +7°C, W 35°C)	kW / COP		3,20 / 5,00	5,00 / 4,63	7,00 / 4,46	9,00 / 4,13
Heating capacity / COP (A +7°C, W 55°C)	kW / COP		3,20 / 2,67	5,00 / 2,65	6,80 / 2,63	8,90 / 2,41
Heating capacity / COP (A +2°C, W 35°C)	kW / COP		3,20 / 3,56	4,20 / 3,11	6,55 / 3,34	6,70 / 3,13
Heating capacity / COP (A +2°C, W 55°C)	kW / COP		3,20 / 2,15	4,10 / 1,98	6,00 / 1,99	6,00 / 1,99
Heating capacity / COP (A -7°C, W 35°C)	kW / COP		3,20 / 2,69	4,20 / 2,59	5,15 / 2,68	5,90 / 2,52
Heating capacity / COP (A -7°C, W 55°C)	kW / COP		3,20 / 1,72	3,55 / 1,71	4,80 / 1,89	5,80 / 1,88
Cooling capacity / EER (A 35°C, W 7°C)	kW / EER		3,20 / 3,08	4,50 / 2,69	6,00 / 2,63	7,00 / 2,43
Cooling capacity / EER (A 35°C, W 18°C)	kW / EER		3,30 / 3,75	5,00 / 3,76	6,00 / 3,57	7,00 / 3,26
Seasonal energy efficiency - Heating Average Climate (W35°C / W55°C)	ETA %		195 / 130	195 / 130	190 / 130	190 / 130
	SCOP		4,95 / 3,33	4,95 / 3,33	4,83 / 3,33	4,83 / 3,33
Energy Class Heating Average Climate (W35°C / W55°C) ¹⁾	A++ to G		A++ / A++	A++ / A++	A++ / A++	A++ / A++
Energy Class Heating Average Climate (W35°C / W55°C) ¹⁾	A+++ to D		A+++ / A+++	A+++ / A+++	A+++ / A+++	A+++ / A+++
Seasonal energy efficiency - Heating Warm Climate (W35°C / W55°C)	ETA %		244 / 163	244 / 163	225 / 160	225 / 160
	SCOP		6,18 / 4,15	6,18 / 4,15	5,70 / 4,08	5,70 / 4,08
Energy Class Heating Warm Climate (W35°C / W55°C)	A++ to G		A++ / A++	A++ / A++	A++ / A++	A++ / A++
Energy Class Heating Warm Climate (W35°C / W55°C)	A+++ to D		A+++ / A+++	A+++ / A+++	A+++ / A+++	A+++ / A+++
Seasonal energy efficiency - Heating Cold Climate (W35°C / W55°C)	ETA %		150 / 103	150 / 103	160 / 115	160 / 115
	SCOP		3,83 / 2,65	3,83 / 2,65	4,08 / 2,95	4,08 / 2,95
Energy Class Heating Cold Climate (W35°C / W55°C)	A++ to G		A++ / A+	A++ / A+	A++ / A+	A++ / A+
Energy Class Heating Cold Climate (W35°C / W55°C)	A+++ to D		A+++ / A+	A+++ / A+	A+++ / A+	A+++ / A+
Indoor unit			WH-SDC03H3E5-1	WH-SDC05H3E5-1	WH-SDC07H3E5-1	WH-SDC09H3E5-1
Sound pressure	Heat / Cool	dB(A)	28 / 28	28 / 28	30 / 30	30 / 30
Dimension	HxWxD	mm	892x500x340	892x500x340	892x500x340	892x500x340
Net weight		kg	44	44	44	44
Water pipe connector		Inch	R1	R1	R1	R1
A class pump	Number of speeds		Variable Speed	Variable Speed	Variable Speed	Variable Speed
	Input power (Min / Max)	W	30 / 100	33 / 106	34 / 114	40 / 120
Heating water flow (ΔT=5 K, 35°C)		L/min	9,2	14,3	20,1	25,8
Capacity of integrated electric heater		kW	3	3	3	3
Recommended fuse		A	15 / 30	15 / 30	15 / 30	15 / 30
Recommended cable size, supply 1 / 2		mm	3x1,5 / 3x1,5	3x1,5 / 3x1,5	3x1,5 / 3x1,5	3x1,5 / 3x1,5
Outdoor unit			WH-UD03HE5-1	WH-UD05HE5-1	WH-UD07HE5-1	WH-UD09HE5-1
Sound power full load	Heat / Cool	dB	64 / 65	65 / 66	68 / 66	69 / 68
Dimension	HxWxD	mm	622x824x298	622x824x298	795x900x320	795x900x320
Net weight		kg	39	39	66	66
Refrigerant (R410A) / CO ₂ Eq.		kg / T	1,20 / 2,506	1,20 / 2,506	1,45 / 3,028	1,45 / 3,028
Pipe diameter	Liquid / Gas	Inch (mm)	1/4 (6,35) / 1/2 (12,70)	1/4 (6,35) / 1/2 (12,70)	1/4 (6,35) / 5/8 (15,88)	1/4 (6,35) / 5/8 (15,88)
Pipe length range		m	3~15	3~15	3~40	3~40
Elevation difference (in/out)		m	5	5	30	30
Pipe length for additional gas		m	10	10	10	10
Additional gas amount		g/m	20	20	30	30
Operation range	Outdoor ambient	°C	-20 ~ +35	-20 ~ +35	-20 ~ +35	-20 ~ +35
Water outlet	Heat / Cool	°C	20 ~ 55 / 5 ~ 20	20 ~ 55 / 5 ~ 20	20 ~ 55 / 5 ~ 20	20 ~ 55 / 5 ~ 20
3rd Party tested Sound power at Quiet Mode 3 ²⁾		dB	52	58	57	59

Accessories

PAW-TD20C1E5	Tank 200L - Stainless steel
PAW-TD30C1E5	Tank 300L - Stainless steel
PAW-TA20C1E5STD	Tank 200L - Enamelled
PAW-TA30C1E5STD	Tank 300L - Enamelled
PAW-3WYVLV-SI	External 3 way valve
CZ-NV1	3 way valve Kit for inside of hydrokit

Accessories

CZ-NS4P	Additional functions PCB
PAW-BTANK50L-1	Buffer tank 50L
CZ-TAW1	Aquarea Smart Cloud for remote control and maintenance through wireless or wired LAN
PAW-A2W-RTWIRED	Room thermostat

EER and COP calculation is based in accordance to EN14511. Sound pressure measured at 1m from the outdoor unit and at 1,5m height. Heating sound pressure measured at +7°C (heating water at 55°C).

1) Scale from A++ to G and from A+++ to D from 26th September 2019. 2) Third party tested sound power at Quiet mode 3 (A +7°C, W 55°C).



INTERNET CONTROL: Optional. GOOD DESIGN AWARD 2017: Indoor units All in One and Bi-bloc H Generation awarded with the prestigious Good Design Award 2017.

Aquarea High Performance Bi-bloc H Generation Single Phase / Three Phase. Heating and Cooling - SDC • R410A Gas



GOOD
DESIGN
AWARD
2017

Technical focus

· Very high energy savings A+++ (*) · Simple installation & maintenance ·
Special software for low consumption homes with minimum output
temperature: 20°C · Works at temperatures as low as -20°C · Automatic Air
purge valve · Display of the compressor frequency

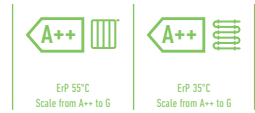

CZ-TAW1
Cloud connection. For
user control and
installer remote
maintenance.

Kit	Single Phase Heating and Cooling			Three Phase (Power to indoor)		
	KIT-WC12H6E5	KIT-WC16H6E5	KIT-WC09H3E8	KIT-WC12H9E8	KIT-WC16H9E8	
Heating capacity / COP (A +7°C, W 35°C)	kW / COP	12,00 / 4,74	16,00 / 4,28	9,00 / 4,84	12,00 / 4,74	16,00 / 4,28
Heating capacity / COP (A +7°C, W 55°C)	kW / COP	12,00 / 2,88	14,50 / 2,68	9,00 / 2,94	12,00 / 2,88	14,50 / 2,68
Heating capacity / COP (A +2°C, W 35°C)	kW / COP	11,40 / 3,44	13,00 / 3,28	9,00 / 3,59	11,40 / 3,44	13,00 / 3,28
Heating capacity / COP (A +2°C, W 55°C)	kW / COP	9,10 / 2,20	9,80 / 2,17	8,80 / 2,23	9,10 / 2,20	9,80 / 2,17
Heating capacity / COP (A -7°C, W 35°C)	kW / COP	10,00 / 2,73	11,40 / 2,57	9,00 / 2,85	10,00 / 2,73	11,40 / 2,57
Heating capacity / COP (A -7°C, W 55°C)	kW / COP	8,20 / 1,92	9,00 / 1,82	7,90 / 2,05	8,20 / 1,92	9,00 / 1,82
Cooling capacity / EER (A 35°C, W 7°C)	kW / EER	10,00 / 2,81	12,20 / 2,56	7,00 / 3,17	10,00 / 2,81	12,20 / 2,56
Cooling capacity / EER (A 35°C, W 18°C)	kW / EER	10,00 / 4,17	12,20 / 4,12	7,00 / 4,61	10,00 / 4,17	12,20 / 4,12
Seasonal energy efficiency - Heating Average Climate (W35°C / W55°C)	ETA %	190 / 134	190 / 130	190 / 133	190 / 134	190 / 130
	SCOP	4,83 / 3,43	4,83 / 3,33	4,83 / 3,40	4,83 / 3,43	4,83 / 3,33
Energy Class Heating Average Climate (W35°C / W55°C) ¹⁾	A++ to G	A++ / A++	A++ / A++	A++ / A++	A++ / A++	A++ / A++
Energy Class Heating Average Climate (W35°C / W55°C) ¹⁾	A+++ to D	A+++ / A++	A+++ / A++	A+++ / A++	A+++ / A++	A+++ / A++
Seasonal energy efficiency - Heating Warm Climate (W35°C / W55°C)	ETA %	245 / 159	245 / 169	245 / 159	245 / 159	245 / 169
	SCOP	6,20 / 4,05	6,20 / 4,30	6,20 / 4,05	6,20 / 4,05	6,20 / 4,30
Energy Class Heating Warm Climate (W35°C / W55°C)	A++ to G	A++ / A++	A++ / A++	A++ / A++	A++ / A++	A++ / A++
Energy Class Heating Warm Climate (W35°C / W55°C)	A+++ to D	A+++ / A+++	A+++ / A+++	A+++ / A+++	A+++ / A+++	A+++ / A+++
Seasonal energy efficiency - Heating Cold Climate (W35°C / W55°C)	ETA %	168 / 121	168 / 121	168 / 121	168 / 121	168 / 121
	SCOP	4,28 / 3,10	4,28 / 3,10	4,28 / 3,10	4,28 / 3,10	4,28 / 3,10
Energy Class Heating Cold Climate (W35°C / W55°C)	A++ to G	A++ / A+	A++ / A+	A++ / A+	A++ / A+	A++ / A+
Energy Class Heating Cold Climate (W35°C / W55°C)	A+++ to D	A+++ / A+	A+++ / A+	A+++ / A+	A+++ / A+	A+++ / A+
Indoor unit		WH-SDC12H6E5	WH-SDC16H6E5	WH-SDC09H3E8	WH-SDC12H9E8	WH-SDC16H9E8
Sound pressure	Heat / Cool	dB(A)	33 / 33	33 / 33	33 / 33	33 / 33
Dimension	H x W x D	mm	892 x 500 x 340	892 x 500 x 340	892 x 500 x 340	892 x 500 x 340
Net weight		kg	44	45	44	45
Water pipe connector		Inch	R1	R1	R1	R1
A class pump	Number of speeds		Variable Speed	Variable Speed	Variable Speed	Variable Speed
	Input power (Min / Max)	W	34 / 110	30 / 105	32 / 102	34 / 110
Heating water flow (ΔT=5 K, 35°C)		L/min	34,4	45,9	25,8	34,4
Capacity of integrated electric heater		kW	6	6	3	9
Recommended fuse		A	30 / 30	30 / 30	15 / 30	15 / 30
Recommended cable size, supply 1 / 2		mm	3x4,0 or 6,0 / 3x4,0	3x4,0 or 6,0 / 3x4,0	5x1,5 / 5x1,5	5x1,5 / 5x1,5
Outdoor unit		WH-UD12HE5-1	WH-UD16HE5-1	WH-UD09HE8	WH-UD12HE8	WH-UD16HE8
Sound power full load	Heat / Cool	dB	69 / 68	72 / 72	68 / 67	69 / 68
Dimension	H x W x D	mm	1340 x 900 x 320	1340 x 900 x 320	1340 x 900 x 320	1340 x 900 x 320
Net weight		kg	101	101	107	107
Refrigerant (R410A) / CO ₂ Eq.		kg / T	2,55 / 5,324	2,55 / 5,324	2,55 / 5,324	2,55 / 5,324
Pipe diameter	Liquid / Gas	Inch (mm)	3/8(9,52) / 5/8(15,88)	3/8(9,52) / 5/8(15,88)	3/8(9,52) / 5/8(15,88)	3/8(9,52) / 5/8(15,88)
Pipe length range		m	3~50	3~50	3~30	3~30
Elevation difference (in/out)		m	30	30	30	30
Pipe length for additional gas		m	10	10	10	10
Additional gas amount		g/m	50	50	50	50
Operation range	Outdoor ambient	°C	-20 ~ +35	-20 ~ +35	-20 ~ +35	-20 ~ +35
Water outlet	Heat / Cool	°C	20 ~ 55 / 5 ~ 20	20 ~ 55 / 5 ~ 20	20 ~ 55 / 5 ~ 20	20 ~ 55 / 5 ~ 20
3rd Party tested Sound power at Quiet Mode 3 ²⁾		dB	65	65	63	65

Accessories

PAW-TD20C1E5	Tank 200L - Stainless steel
PAW-TD30C1E5	Tank 300L - Stainless steel
PAW-TA20C1E5STD	Tank 200L - Enamelled
PAW-TA30C1E5STD	Tank 300L - Enamelled
PAW-3WYVLV-SI	External 3 way valve
CZ-NV1	3 way valve Kit for inside of hydrokit

Accessories

CZ-NS4P	Additional functions PCB
PAW-BTANK50L-1	Buffer tank 50L
CZ-TAW1	Aquarea Smart Cloud for remote control and maintenance through wireless or wired LAN
PAW-A2W-RTWIRED	Room thermostat

EER and COP calculation is based in accordance to EN14511. Sound pressure measured at 1m from the outdoor unit and at 1,5m height. Heating sound pressure measured at +7°C (heating water at 55°C).

1) Scale from A++ to G and from A+++ to D from 26th September 2019. 2) Third party tested sound power at Quiet mode 3 (A +7°C, W 55°C).



INTERNET CONTROL: Optional. GOOD DESIGN AWARD 2017: Indoor units All in One and Bi-bloc H Generation awarded with the prestigious Good Design Award 2017.

Aquarea T-CAP Bi-bloc H Generation

Single Phase / Three Phase.

Heating and Cooling - SXC • R410A Gas



**GOOD
DESIGN
AWARD
2017**

Technical focus

- Very high energy savings A++ · Simple installation & maintenance ·
- Constant capacity up to -20°C · Water temperature up to 60°C · Special software for low consumption homes with minimum output temperature: 20°C · Works at temperatures as low as -28°C · Automatic Air purge valve · Display of the compressor frequency

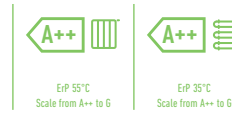

CZ-TAW1
Cloud connection. For user control and installer remote maintenance.

Kit	Single Phase (Power to indoor)			Three Phase (Power to indoor)		
	KIT-WXC09H3E5	KIT-WXC12H6E5	KIT-WXC09H3E8	KIT-WXC12H9E8	KIT-WXC16H9E8	
Heating capacity / COP (A +7°C, W 35°C)	kW / COP	9,00 / 4,84	12,00 / 4,74	9,00 / 4,84	12,00 / 4,74	16,00 / 4,28
Heating capacity / COP (A +7°C, W 55°C)	kW / COP	9,00 / 2,94	12,00 / 2,88	9,00 / 2,94	12,00 / 2,88	16,00 / 2,71
Heating capacity / COP (A +2°C, W 35°C)	kW / COP	9,00 / 3,59	12,00 / 3,44	9,00 / 3,59	12,00 / 3,44	16,00 / 3,10
Heating capacity / COP (A +2°C, W 55°C)	kW / COP	9,00 / 2,21	12,00 / 2,19	9,00 / 2,21	12,00 / 2,19	16,00 / 2,13
Heating capacity / COP (A -7°C, W 35°C)	kW / COP	9,00 / 2,85	12,00 / 2,72	9,00 / 2,85	12,00 / 2,72	16,00 / 2,49
Heating capacity / COP (A -7°C, W 55°C)	kW / COP	9,00 / 2,02	12,00 / 1,92	9,00 / 2,02	12,00 / 1,92	16,00 / 1,86
Cooling capacity / EER (A 35°C, W 7°C)	kW / EER	7,00 / 3,17	10,00 / 2,81	7,00 / 3,17	10,00 / 2,81	12,20 / 2,57
Cooling capacity / EER (A 35°C, W 18°C)	kW / EER	7,00 / 5,19	10,00 / 5,13	7,00 / 5,19	10,00 / 5,13	12,20 / 3,49
Seasonal energy efficiency - Heating Average Climate (W35°C / W55°C)	ETA %	181 / 130	170 / 130	181 / 130	170 / 130	160 / 125
	SCOP	4,60 / 3,33	4,33 / 3,33	4,60 / 3,33	4,33 / 3,33	4,08 / 3,20
Energy Class Heating Average Climate (W35°C / W55°C) ¹⁾	A++ to G	A++ / A++	A++ / A++	A++ / A++	A++ / A++	A++ / A++
Energy Class Heating Average Climate (W35°C / W55°C) ¹⁾	A+++ to D	A+++ / A++	A+++ / A++	A+++ / A++	A+++ / A++	A+++ / A++
Seasonal energy efficiency - Heating Warm Climate (W35°C / W55°C)	ETA %	235 / 158	231 / 158	235 / 158	231 / 158	231 / 159
	SCOP	5,95 / 4,03	5,85 / 4,03	5,95 / 4,03	5,85 / 4,03	5,85 / 4,05
Energy Class Heating Warm Climate (W35°C / W55°C)	A++ to G	A++ / A++	A++ / A++	A++ / A++	A++ / A++	A++ / A++
Energy Class Heating Warm Climate (W35°C / W55°C)	A+++ to D	A+++ / A+++	A+++ / A+++	A+++ / A+++	A+++ / A+++	A+++ / A+++
Seasonal energy efficiency - Heating Cold Climate (W35°C / W55°C)	ETA %	160 / 125	160 / 125	160 / 125	160 / 125	150 / 125
	SCOP	4,08 / 3,20	4,08 / 3,20	4,08 / 3,20	4,08 / 3,20	3,83 / 3,20
Energy Class Heating Cold Climate (W35°C / W55°C)	A++ to G	A++ / A++	A++ / A++	A++ / A++	A++ / A++	A++ / A++
Energy Class Heating Cold Climate (W35°C / W55°C)	A+++ to D	A+++ / A++	A+++ / A++	A+++ / A++	A+++ / A++	A+++ / A++
Indoor unit		WH-SXC09H3E5	WH-SXC12H6E5	WH-SXC09H3E8	WH-SXC12H9E8	WH-SXC16H9E8
Sound pressure	Heat / Cool	33 / 33	33 / 33	33 / 33	33 / 33	33 / 33
Dimension	HxWxD	892x500x340	892x500x340	892x500x340	892x500x340	892x500x340
Net weight		43	43	43	44	45
Water pipe connector		R1	R1	R1	R1	R1
A class pump	Number of speeds	Variable Speed	Variable Speed	Variable Speed	Variable Speed	Variable Speed
	Input power (Min / Max)	W	32 / 102	34 / 110	32 / 102	34 / 110
Heating water flow (ΔT=5 K, 35°C)		L/min	25,8	34,4	25,8	34,4
Capacity of integrated electric heater		kW	3	6	3	9
Recommended fuse		A	30 / 30	30 / 30	16 / 16	16 / 16
Recommended cable size, supply 1 / 2		mm	3x4,0 or 6,0 / 3x4,0	3x4,0 or 6,0 / 3x4,0	5x1,5 / 5x1,5	5x1,5 / 5x1,5
Outdoor unit		WH-UX09HE5	WH-UX12HE5	WH-UX09HE8	WH-UX12HE8	WH-UX16HE8
Sound power full load	Heat / Cool	68 / 67	69 / 68	68 / 67	69 / 68	72 / 71
Dimension	HxWxD	1340x900x320	1340x900x320	1340x900x320	1340x900x320	1340x900x320
Net weight		101	101	108	108	118
Refrigerant (R410A) / CO ₂ Eq.		kg / T	2,85 / 5,951	2,85 / 5,951	2,85 / 5,951	2,90 / 6,055
Pipe diameter	Liquid / Gas	Inch (mm)	3/8(9,52) / 5/8(15,88)	3/8(9,52) / 5/8(15,88)	3/8(9,52) / 5/8(15,88)	3/8(9,52) / 5/8(15,88)
Pipe length range		m	3~30	3~30	3~30	3~30
Elevation difference (in/out)		m	30	30	30	30
Pipe length for additional gas		m	10	10	10	10
Additional gas amount		g/m	50	50	50	50
Operation range	Outdoor ambient	°C	-28~-+35	-28~-+35	-28~-+35	-28~-+35
Water outlet	Heat / Cool	°C	20-60 / 5-20	20-60 / 5-20	20-60 / 5-20	20-60 / 5-20
3rd Party tested Sound power at Quiet Mode 3 ²⁾		dB	62	64	62	64

Accessories

PAW-TD20C1E5	Tank 200L - Stainless steel
PAW-TD30C1E5	Tank 300L - Stainless steel
PAW-TA20C1E5STD	Tank 200L - Enamelled
PAW-TA30C1E5STD	Tank 300L - Enamelled
PAW-3WYVLV-SI	External 3 way valve
CZ-NV1	3 way valve Kit for inside of hydrokit

Accessories

CZ-NS4P	Additional functions PCB
PAW-BTANK50L-1	Buffer tank 50L
CZ-TAW1	Aquarea Smart Cloud for remote control and maintenance through wireless or wired LAN
PAW-A2W-RTWIRED	Room thermostat

EER and COP calculation is based in accordance to EN14511. Sound pressure measured at 1m from the outdoor unit and at 1,5m height. Heating sound pressure measured at +7°C (heating water at 55°C).

1) Scale from A++ to G and from A+++ to D from 26th September 2019. 2) Third party tested sound power at Quiet mode 3 (A +7°C, W 55°C).



INTERNET CONTROL: Optional. GOOD DESIGN AWARD 2017: Indoor units All in One and Bi-bloc H Generation awarded with the prestigious Good Design Award 2017.

Aquarea T-CAP Bi-bloc H Generation

Three Phase. Super Quiet outdoor unit.

Heating and Cooling - SQC • R410A Gas



**GOOD
DESIGN
AWARD
2017**

Technical focus

- Very high energy savings A++ · Noise reduction of 7dB is based on power level when heating mode · With Quiet mode we can reach 10 ~ 12dB(A) · Constant capacity up to -20°C · Water temperature up to 60°C · Special software for low consumption homes with minimum output temperature: 20°C · Works at temperatures as low as -28°C · Display of the compressor frequency

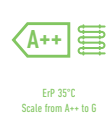

CZ-TAW1
Cloud connection. For user control and installer remote maintenance.

				Three Phase (Power to indoor)		
Kit				KIT-WQC09H3E8	KIT-WQC12H9E8	KIT-WQC16H9E8
Heating capacity / COP (A +7°C, W 35°C)		kW / COP		9,00 / 4,84	12,00 / 4,74	16,00 / 4,28
Heating capacity / COP (A +7°C, W 55°C)		kW / COP		9,00 / 2,94	12,00 / 2,88	16,00 / 2,71
Heating capacity / COP (A +2°C, W 35°C)		kW / COP		9,00 / 3,59	12,00 / 3,44	16,00 / 3,10
Heating capacity / COP (A +2°C, W 55°C)		kW / COP		9,00 / 2,21	12,00 / 2,19	16,00 / 2,13
Heating capacity / COP (A -7°C, W 35°C)		kW / COP		9,00 / 2,85	12,00 / 2,72	16,00 / 2,49
Heating capacity / COP (A -7°C, W 55°C)		kW / COP		9,00 / 2,02	12,00 / 1,92	16,00 / 1,86
Cooling capacity / EER (A 35°C, W 7°C)		kW / EER		7,00 / 3,17	10,00 / 2,81	12,20 / 2,57
Cooling capacity / EER (A 35°C, W 18°C)		kW / EER		7,00 / 5,19	10,00 / 5,13	12,20 / 3,49
Seasonal energy efficiency - Heating Average Climate (W35°C / W55°C)		ETA %		181 / 130	170 / 130	160 / 125
		SCOP		4,60 / 3,33	4,33 / 3,33	4,08 / 3,20
Energy Class Heating Average Climate (W35°C / W55°C) ¹⁾		A++ to G		A++ / A++	A++ / A++	A++ / A++
Energy Class Heating Average Climate (W35°C / W55°C) ¹⁾		A+++ to D		A+++ / A+++	A+++ / A+++	A+++ / A+++
Seasonal energy efficiency - Heating Warm Climate (W35°C / W55°C)		ETA %		235 / 158	231 / 158	231 / 159
		SCOP		5,95 / 4,03	5,85 / 4,03	5,85 / 4,05
Energy Class Heating Warm Climate (W35°C / W55°C)		A++ to G		A++ / A++	A++ / A++	A++ / A++
Energy Class Heating Warm Climate (W35°C / W55°C)		A+++ to D		A+++ / A+++	A+++ / A+++	A+++ / A+++
Seasonal energy efficiency - Heating Cold Climate (W35°C / W55°C)		ETA %		160 / 125	160 / 125	150 / 125
		SCOP		4,08 / 3,20	4,08 / 3,20	3,83 / 3,20
Energy Class Heating Cold Climate (W35°C / W55°C)		A++ to G		A++ / A++	A++ / A++	A++ / A++
Energy Class Heating Cold Climate (W35°C / W55°C)		A+++ to D		A++ / A++	A++ / A++	A++ / A++
Indoor unit				WH-SQC09H3E8	WH-SQC12H9E8	WH-SQC16H9E8
Sound pressure	Heat / Cool	dB(A)		33 / 33	33 / 33	33 / 33
Dimension	H x W x D	mm		892 x 500 x 340	892 x 500 x 340	892 x 500 x 340
Net weight		kg		43	44	45
Water pipe connector		Inch		R1	R1	R1
A class pump	Number of speeds			Variable Speed	Variable Speed	Variable Speed
	Input power (Min / Max)	W		32 / 102	34 / 110	30 / 105
Heating water flow (ΔT=5 K, 35°C)		L/min		25,8	34,4	45,9
Capacity of integrated electric heater		kW		3	9	9
Recommended fuse		A		15 / 30	15 / 30	15 / 30
Recommended cable size, supply 1 / 2		mm		5 x 1,5 / 5 x 1,5	5 x 1,5 / 5 x 1,5	5 x 1,5 / 5 x 1,5
Outdoor unit				WH-UQ09HE8	WH-UQ12HE8	WH-UQ16HE8
Sound power full load	Heat / Cool	dB		61 / 63	62 / 64	65 / 68
Dimension	H x W x D	mm		1410 x 1283 x 320	1410 x 1283 x 320	1410 x 1283 x 320
Net weight		kg		151	151	161
Refrigerant (R410A) / CO ₂ Eq.		kg / T		2,85 / 5,951	2,85 / 5,951	2,99 / 6,243
Pipe diameter	Liquid / Gas	Inch (mm)		3/8 (9,52) / 5/8 (15,88)	3/8 (9,52) / 5/8 (15,88)	3/8 (9,52) / 5/8 (15,88)
Pipe length range		m		3 ~ 30	3 ~ 30	3 ~ 30
Elevation difference (in/out)		m		20	20	20
Pipe length for additional gas		m		10	10	10
Additional gas amount		g/m		50	50	50
Operation range	Outdoor ambient	°C		-28 ~ +35	-28 ~ +35	-28 ~ +35
Water outlet	Heat / Cool	°C		20 - 60 / 5 - 20	20 - 60 / 5 - 20	20 - 60 / 5 - 20
3rd Party tested Sound power at Quiet Mode 3 ²⁾		dB		55	54	58

Accessories

PAW-TD20C1E5	Tank 200L - Stainless steel
PAW-TD30C1E5	Tank 300L - Stainless steel
PAW-TA20C1E5STD	Tank 200L - Enamelled
PAW-TA30C1E5STD	Tank 300L - Enamelled
PAW-3WYVLV-SI	External 3 way valve
CZ-NV1	3 way valve Kit for inside of hydrokit

Accessories

CZ-NS4P	Additional functions PCB
PAW-BTANK50L-1	Buffer tank 50L
CZ-TAW1	Aquarea Smart Cloud for remote control and maintenance through wireless or wired LAN
PAW-A2W-RTWIRED	Room thermostat

EER and COP calculation is based in accordance to EN14511. Sound pressure measured at 1m from the outdoor unit and at 1,5m height. Heating sound pressure measured at +7°C (heating water at 55°C).
1) Scale from A++ to G and from A+++ to D from 26th September 2019. 2) Third party tested sound power at Quiet mode 3 (A +7°C, W 55°C).



INTERNET CONTROL: Optional. GOOD DESIGN AWARD 2017: Indoor units All in One and Bi-bloc H Generation awarded with the prestigious Good Design Award 2017.

Aquarea High Performance Mono-bloc H Generation Single Phase. Heating and Cooling - MDC • R410A Gas



Technical focus

- Optional Smartphone control
- Maximum hydraulic module output temperature: 55°C
- Works at temperatures as low as -20°C
- Cooling temperature range 5 ~ 20°C

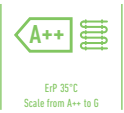
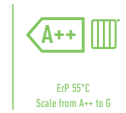

CZ-TAW1
Cloud connection. For user control and installer remote maintenance.

			Single Phase Heating and Cooling				
Outdoor unit			WH-MDC05H3E5	WH-MDC07H3E5	WH-MDC09H3E5	WH-MDC12H6E5	WH-MDC16H6E5
Heating capacity / COP (A +7°C, W 35°C)	kW / COP		5,00 / 5,08	7,00 / 4,52	9,00 / 4,29	12,00 / 4,74	16,00 / 4,28
Heating capacity / COP (A +7°C, W 55°C)	kW / COP		5,00 / 2,84	7,00 / 2,83	9,00 / 2,72	12,00 / 2,93	14,50 / 2,72
Heating capacity / COP (A +2°C, W 35°C)	kW / COP		4,80 / 3,36	6,60 / 3,30	6,80 / 3,18	11,40 / 3,44	13,00 / 3,28
Heating capacity / COP (A +2°C, W 55°C)	kW / COP		4,00 / 2,33	6,30 / 2,22	6,30 / 2,13	9,10 / 2,23	9,80 / 2,21
Heating capacity / COP (A -7°C, W 35°C)	kW / COP		4,70 / 2,85	5,50 / 2,70	6,40 / 2,60	10,00 / 2,73	11,40 / 2,57
Heating capacity / COP (A -7°C, W 55°C)	kW / COP		4,30 / 1,89	5,00 / 1,82	5,80 / 1,78	8,20 / 1,95	9,00 / 1,84
Cooling capacity / EER (A 35°C, W 7°C)	kW / EER		4,50 / 3,28	6,00 / 2,78	7,00 / 2,60	10,00 / 2,81	12,20 / 2,56
Cooling capacity / EER (A 35°C, W 18°C)	kW / EER		5,10 / 5,10	6,00 / 3,87	7,00 / 3,59	10,00 / 4,65	12,20 / 4,12
Seasonal energy efficiency - Heating Average Climate (W35°C / W55°C)	ETA %		199 / 139	190 / 130	190 / 130	190 / 134	190 / 130
	SCOP		5,05 / 3,55	4,83 / 3,33	4,83 / 3,33	4,83 / 3,43	4,83 / 3,33
Energy Class Heating Average Climate (W35°C / W55°C) ¹⁾	A++ to G		A++ / A++	A++ / A++	A++ / A++	A++ / A++	A++ / A++
Energy Class Heating Average Climate (W35°C / W55°C) ¹⁾	A+++ to D		A+++ / A++	A+++ / A++	A+++ / A++	A+++ / A++	A+++ / A++
Seasonal energy efficiency - Heating Warm Climate (W35°C / W55°C)	ETA %		237 / 161	225 / 160	225 / 160	245 / 159	245 / 169
	SCOP		6,00 / 4,10	5,70 / 4,08	5,70 / 4,08	6,20 / 4,05	6,20 / 4,30
Energy Class Heating Warm Climate (W35°C / W55°C)	A++ to G		A++ / A++	A++ / A++	A++ / A++	A++ / A++	A++ / A++
Energy Class Heating Warm Climate (W35°C / W55°C)	A+++ to D		A+++ / A+++	A+++ / A+++	A+++ / A+++	A+++ / A+++	A+++ / A+++
Seasonal energy efficiency - Heating Cold Climate (W35°C / W55°C)	ETA %		160 / 115	160 / 115	160 / 115	168 / 121	168 / 121
	SCOP		4,08 / 2,95	4,08 / 2,95	4,08 / 2,95	4,28 / 3,10	4,28 / 3,10
Energy Class Heating Cold Climate (W35°C / W55°C)	A++ to G		A++ / A+	A++ / A+	A++ / A+	A++ / A+	A++ / A+
Energy Class Heating Cold Climate (W35°C / W55°C)	A+++ to D		A+++ / A+	A+++ / A+	A+++ / A+	A+++ / A+	A+++ / A+
Sound power full load	Heat / Cool	dB	65 / 65	68 / 66	69 / 67	69 / 68	72 / 72
Dimension	HxWxD	mm	865 x 1283 x 320	865 x 1283 x 320	865 x 1283 x 320	1410 x 1283 x 320	1410 x 1283 x 320
Net weight		kg	94	104	104	140	140
Refrigerant (R410A) / CO ₂ Eq. ²⁾		kg / T	1,30 / 2714	1,35 / 2819	1,35 / 2819	2,10 / 4,385	2,10 / 4,385
Water pipe connector		Inch	R1	R1	R1	R1	R1
Pump	Number of speeds		Variable Speed	Variable Speed	Variable Speed	Variable Speed	Variable Speed
	Input power (Min / Max)	W	34 / 96	36 / 100	39 / 108	34 / 110	38 / 120
Heating water flow (ΔT=5 K, 35°C)		L/min	14,3	20,1	25,8	34,4	45,9
Capacity of integrated electric heater		kW	3	3	3	6	6
Input Power	Heat	kW	0,985	1,55	2,10	2,53	3,74
	Cool	kW	1,37	2,16	2,69	3,56	4,76
Running and Starting current	Heat	A	4,7	7,2	9,6	11,7	16,9
	Cool	A	6,3	9,9	12,2	16,2	21,5
Current 1		A	13,0	21,0	22,9	24,0	26,0
Current 2		A	13,0	13,0	13,0	26,0	26,0
Recommended fuse		A	30 / 15	30 / 15	30 / 16	30 / 30	30 / 30
Recommended cable size, supply 1 / 2		mm ²	3 x 4,0 or 6,0 / 3 x 4,0	3 x 4,0 or 6,0 / 3 x 4,0	3 x 4,0 or 6,0 / 3 x 4,0	3 x 4,0 or 6,0 / 3 x 4,0	3 x 4,0 or 6,0 / 3 x 4,0
Operation range	Outdoor ambient	°C	-20 ~ +35	-20 ~ +35	-20 ~ +35	-20 ~ +35	-20 ~ +35
	Heat	°C	20 ~ 55	20 ~ 55	20 ~ 55	25 ~ 55	25 ~ 55
Water outlet	Heat	°C	20 ~ 55	20 ~ 55	20 ~ 55	25 ~ 55	25 ~ 55
	Cool	°C	5 ~ 20	5 ~ 20	5 ~ 20	5 ~ 20	5 ~ 20
3rd Party tested Sound power at Quiet Mode 3 ³⁾		dB	57	57	61	65	66

Accessories

PAW-TD20C1E5	Tank 200L - Stainless steel
PAW-TD30C1E5	Tank 300L - Stainless steel
PAW-TA20C1E5STD	Tank 200L - Enamelled
PAW-TA30C1E5STD	Tank 300L - Enamelled
PAW-3WYVVL-SI	3 way valve

Accessories

PAW-BTANK50L-1	Buffer tank 50L
CZ-TAW1	Aquarea Smart Cloud for remote control and maintenance through wireless or wired LAN
PAW-A2W-RTWIRED	Room thermostat

EER and COP calculation is based in accordance to EN14511. Sound pressure measured at 1m from the outdoor unit and at 1,5m height. Heating sound pressure measured at +7°C (heating water at 55°C).

1) Scale from A++ to G and from A+++ to D from 26th September 2019. 2) WH-MDC models are hermetically sealed. 3) Third party tested sound power at Quiet mode 3 (A +7°C, W 55°C).



INTERNET CONTROL: Optional.

Aquarea T-CAP Mono-bloc H Generation Single Phase / Three Phase.

Heating and Cooling - MXC • R410A Gas



Technical focus

- Optional Smartphone control
- Maximum hydraulic module output temperature: 55°C
- Works at temperatures as low as -20°C
- Cooling temperature range 5 ~ 20°C

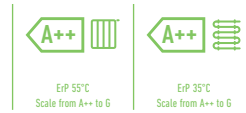

CZ-TAW1
Cloud connection. For user control and installer remote maintenance.

			Single Phase			Three Phase		
Outdoor unit			WH-MXC09H3E5	WH-MXC12H6E5	WH-MXC09H3E8	WH-MXC12H9E8	WH-MXC16H9E8	
Heating capacity / COP (A +7°C, W 35°C)	kW / COP		9,00 / 4,84	12,00 / 4,74	9,00 / 4,84	12,00 / 4,74	16,00 / 4,28	
Heating capacity / COP (A +7°C, W 55°C)	kW / COP		9,00 / 2,94	12,00 / 2,88	9,00 / 2,94	12,00 / 2,88	16,00 / 2,71	
Heating capacity / COP (A +2°C, W 35°C)	kW / COP		9,00 / 3,59	12,00 / 3,44	9,00 / 3,59	12,00 / 3,44	16,00 / 3,10	
Heating capacity / COP (A +2°C, W 55°C)	kW / COP		9,00 / 2,21	12,00 / 2,19	9,00 / 2,21	12,00 / 2,19	16,00 / 2,13	
Heating capacity / COP (A -7°C, W 35°C)	kW / COP		9,00 / 2,85	12,00 / 2,72	9,00 / 2,85	12,00 / 2,72	16,00 / 2,49	
Heating capacity / COP (A -7°C, W 55°C)	kW / COP		9,00 / 2,02	12,00 / 1,92	9,00 / 2,02	12,00 / 1,92	16,00 / 1,86	
Cooling capacity / EER (A 35°C, W 7°C)	kW / EER		7,00 / 3,17	10,00 / 2,81	7,00 / 3,17	10,00 / 2,81	12,20 / 2,56	
Cooling capacity / EER (A 35°C, W 18°C)	kW / EER		7,00 / 5,19	10,00 / 5,13	7,00 / 5,19	10,00 / 5,13	12,20 / 3,49	
Seasonal energy efficiency - Heating Average Climate (W35°C / W55°C)	ETA %		181 / 130	170 / 130	181 / 130	170 / 130	160 / 125	
	SCOP		4,60 / 3,33	4,33 / 3,33	4,60 / 3,33	4,33 / 3,33	4,08 / 3,20	
Energy Class Heating Average Climate (W35°C / W55°C) ¹⁾	A++ to G		A++ / A++	A++ / A++	A++ / A++	A++ / A++	A++ / A++	
Energy Class Heating Average Climate (W35°C / W55°C) ¹⁾	A+++ to D		A+++ / A+++	A+++ / A+++	A+++ / A+++	A+++ / A+++	A+++ / A+++	
Seasonal energy efficiency - Heating Warm Climate (W35°C / W55°C)	ETA %		235 / 158	231 / 158	235 / 158	231 / 158	231 / 159	
	SCOP		5,95 / 4,03	5,85 / 4,03	5,95 / 4,03	5,85 / 4,03	5,85 / 4,05	
Energy Class Heating Warm Climate (W35°C / W55°C)	A++ to G		A++ / A++	A++ / A++	A++ / A++	A++ / A++	A++ / A++	
Energy Class Heating Warm Climate (W35°C / W55°C)	A+++ to D		A+++ / A+++	A+++ / A+++	A+++ / A+++	A+++ / A+++	A+++ / A+++	
Seasonal energy efficiency - Heating Cold Climate (W35°C / W55°C)	ETA %		160 / 125	160 / 125	160 / 125	160 / 125	150 / 125	
	SCOP		4,08 / 3,20	4,08 / 3,20	4,08 / 3,20	4,08 / 3,20	3,83 / 3,20	
Energy Class Heating Cold Climate (W35°C / W55°C)	A++ to G		A++ / A++	A++ / A++	A++ / A++	A++ / A++	A++ / A++	
Energy Class Heating Cold Climate (W35°C / W55°C)	A+++ to D		A++ / A++	A++ / A++	A++ / A++	A++ / A++	A++ / A++	
Sound power full load	Heat / Cool	dB	68 / 67	69 / 68	68 / 67	69 / 68	72 / 71	
Dimension	HxWxD	mm	1410x1283x320	1410x1283x320	1410x1283x320	1410x1283x320	1410x1283x320	
Net weight		kg	142	142	151	151	164	
Refrigerant (R410A) / CO ₂ Eq. ²⁾		kg / T	2,30 / 4,802	2,30 / 4,802	2,30 / 4,802	2,30 / 4,802	2,35 / 4,907	
Water pipe connector		Inch	R1	R1	R1	R1	R1	
Pump	Number of speeds		Variable Speed	Variable Speed	Variable Speed	Variable Speed	Variable Speed	
	Input power (Min / Max)	W	32 / 102	34 / 110	32 / 102	34 / 110	38 / 120	
Heating water flow (ΔT=5 K, 35°C)		L/min	25,8	34,4	25,8	34,4	45,9	
Capacity of integrated electric heater		kW	3	6	3	9	9	
Input Power	Heat	kW	1,86	2,53	1,86	2,53	3,74	
	Cool	kW	2,21	3,56	2,21	3,56	4,76	
Running and Starting current	Heat	A	8,8	11,7	3,0	4,0	5,7	
	Cool	A	10,4	16,5	3,5	5,3	7,1	
Current 1		A	29,0	29,0	14,7	11,9	15,5	
Current 2		A	13,0	26,0	13,0	13,0	13,0	
Recommended fuse		A	30 / 30	30 / 30	16 / 16	16 / 16	16 / 16	
Recommended cable size, supply 1 / 2		mm ²	3x4,0 or 6,0 / 3x4,0	3x4,0 or 6,0 / 3x4,0	5x1,5 / 3x1,5	5x1,5 / 5x1,5	5x1,5 / 5x1,5	
Operation range	Outdoor ambient	°C	-20 ~ +35	-20 ~ +35	-20 ~ +35	-20 ~ +35	-20 ~ +35	
	Heat	°C	20 ~ 60	20 ~ 60	20 ~ 60	20 ~ 60	20 ~ 60	
Water outlet	Heat	°C	5 ~ 20	5 ~ 20	5 ~ 20	5 ~ 20	5 ~ 20	
	Cool	°C	5 ~ 20	5 ~ 20	5 ~ 20	5 ~ 20	5 ~ 20	
3rd Party tested Sound power at Quiet Mode 3 ³⁾		dB	62	64	62	64	65	

Accessories

PAW-TD20C1E5	Tank 200L - Stainless steel
PAW-TD30C1E5	Tank 300L - Stainless steel
PAW-TA20C1E5STD	Tank 200L - Enamelled
PAW-TA30C1E5STD	Tank 300L - Enamelled
PAW-3WYVLV-SI	3 way valve

Accessories

PAW-BTANK50L-1	Buffer tank 50L
CZ-TAW1	Aquarea Smart Cloud for remote control and maintenance through wireless or wired LAN
PAW-A2W-RTWIRED	Room thermostat

EER and COP calculation is based in accordance to EN14511. Sound pressure measured at 1m from the outdoor unit and at 1,5m height. Heating sound pressure measured at +7°C (heating water at 55°C).

1) Scale from A++ to G and from A+++ to D from 26th September 2019. 2) WH-MXC models are hermetically sealed. 3) Third party tested sound power at Quiet mode 3 (A +7°C, W 55°C).



INTERNET CONTROL: Optional.

Aquarea HT Bi-bloc F Generation

Single Phase / Three Phase.

Heating Only - SHF • R407C Gas



Technical focus

- Remote controller functions · Efficient control of room temperature based on the outdoor temperature, indoor temperature using the Aquarea Manager · Optional Smartphone control · Maximum hydraulic module output temperature: 65°C · Works at temperatures as low as -20°C · Maximum 20m rise between the outdoor unit and the hydraulic module

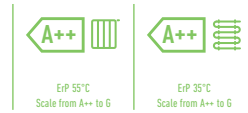

Kit	Single Phase (Power to indoor)		Three Phase (Power to indoor)	
	KIT-WHF09F3E5	KIT-WHF12F6E5	KIT-WHF09F3E8	KIT-WHF12F9E8
Heating capacity / COP (A +7°C, W 35°C)	kW / COP 9,00 / 4,64	12,00 / 4,46	9,00 / 4,64	12,00 / 4,46
Heating capacity / COP (A +7°C, W 65°C)	kW / COP 9,00 / 2,48	12,00 / 2,41	9,00 / 2,48	12,00 / 2,41
Heating capacity / COP (A +2°C, W 35°C)	kW / COP 9,00 / 3,45	12,00 / 3,26	9,00 / 3,45	12,00 / 3,26
Heating capacity / COP (A +2°C, W 65°C)	kW / COP 9,00 / 2,06	10,30 / 2,01	9,00 / 2,06	10,30 / 2,01
Heating capacity / COP (A -7°C, W 35°C)	kW / COP 9,00 / 2,74	12,00 / 2,52	9,00 / 2,74	12,00 / 2,52
Heating capacity / COP (A -7°C, W 65°C)	kW / COP 9,00 / 1,79	9,60 / 1,77	9,00 / 1,79	9,60 / 1,77
Seasonal energy efficiency - Heating Average Climate (W35°C / W55°C)	ETA % 153 / 125	150 / 125	153 / 125	150 / 125
	SCOP 3,90 / 3,20	3,83 / 3,20	3,90 / 3,20	3,83 / 3,20
Energy Class Heating Average Climate (W35°C / W55°C) ¹⁾	A++ to G	A++ / A++	A++ / A++	A++ / A++
Energy Class Heating Average Climate (W35°C / W55°C) ¹⁾	A+++ to D	A++ / A++	A++ / A++	A++ / A++
Seasonal energy efficiency - Heating Warm Climate (W35°C / W55°C)	ETA % 191 / 156	188 / 156	191 / 156	188 / 156
	SCOP 4,85 / 3,98	4,78 / 3,98	4,85 / 3,98	4,78 / 3,98
Energy Class Heating Warm Climate (W35°C / W55°C)	A++ to G	A++ / A++	A++ / A++	A++ / A++
Energy Class Heating Warm Climate (W35°C / W55°C)	A+++ to D	A+++ / A+++	A+++ / A+++	A+++ / A+++
Seasonal energy efficiency - Heating Cold Climate (W35°C / W55°C)	ETA % 137 / 116	134 / 113	137 / 116	134 / 113
	SCOP 3,50 / 2,98	3,43 / 2,90	3,50 / 2,98	3,43 / 2,90
Energy Class Heating Cold Climate (W35°C / W55°C)	A++ to G	A+ / A+	A+ / A+	A+ / A+
Energy Class Heating Cold Climate (W35°C / W55°C)	A+++ to D	A+ / A+	A+ / A+	A+ / A+
Indoor unit	WH-SHF09F3E5	WH-SHF12F6E5	WH-SHF09F3E8	WH-SHF12F9E8
Sound pressure	Heat / Cool	dB(A) 33	33	33
Dimension	HxWxD	mm 892x502x353	892x502x353	892x502x353
Net weight		kg 46	47	48
Water pipe connector		Inch R1	R1	R1
A class pump	Number of speeds	7	7	7
	Input power (Min / Max)	W 38 / 100	40 / 106	38 / 100
Heating water flow (ΔT=5 K, 35°C)		L/min 25,8	34,4	25,8
Capacity of integrated electric heater		kW 3	6	3
Recommended fuse		A 30 / 30	30 / 30	30 / 16
Recommended cable size, supply 1 / 2		mm 3x4,0 or 6,0 / 3x4,0	3x4,0 or 6,0 / 3x4,0	5x1,5 / 3x1,5
Outdoor unit	WH-UH09FE5	WH-UH12FE5	WH-UH09FE8	WH-UH12FE8
Sound power part load		dB —	—	—
Sound power full load	Heat / Cool	dB 66	67	66
Dimension	HxWxD	mm 1340x900x320	1340x900x320	1340x900x320
Net weight		kg 104	104	110
Refrigerant (R407C) / CO ₂ Eq.		kg / T 2,90 / 5,145	2,90 / 5,145	2,90 / 5,145
Pipe diameter	Liquid / Gas	Inch (mm) 3/8 (9,52) / 5/8 (15,88)	3/8 (9,52) / 5/8 (15,88)	3/8 (9,52) / 5/8 (15,88)
Pipe length range		m 3~30	3~30	3~30
Elevation difference (in/out)		m 20	20	20
Pipe length for additional gas		m 10	10	10
Additional gas amount		g/m 70	70	70
Operation range	Outdoor ambient	°C -20 ~ +35	-20 ~ +35	-20 ~ +35
Water outlet	Heat / Cool	°C 25~65	25~65	25~65

Accessories

PAW-TD20C1E5	Tank 200L - Stainless steel
PAW-TD30C1E5	Tank 300L - Stainless steel
PAW-TA20C1E5STD	Tank 200L - Enamelled
PAW-TA30C1E5STD	Tank 300L - Enamelled

Accessories

PAW-3WYVLV-SI	External 3 way valve
PAW-BTANK50L-1	Buffer tank 50L
PA-AW-WIFI-1TE	WLAN interface
PAW-A2W-RTWIRED	Room thermostat

EER and COP calculation is based in accordance to EN14511. Sound pressure measured at 1m from the outdoor unit and at 1,5m height. Heating sound pressure measured at +7°C (heating water at 55°C).
¹ Scale from A++ to G and from A+++ to D from 26th September 2019.



INTERNET CONTROL: Optional.

Aquarea HT Mono-bloc G Generation Single Phase. Heating Only - MHF • R407C Gas



Technical focus

- Efficient control of room temperature based on the outdoor temperature, indoor temperature using the Aquarea Manager.
- Optional Smartphone control
- Maximum hydraulic module output temperature: 65°C
- Works at temperatures as low as -20°C

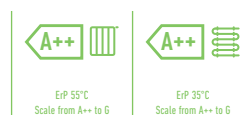

Single Phase

Outdoor unit		WH-MHF09G3E5	WH-MHF12G6E5
Heating capacity / COP (A +7°C, W 35°C)	kW / COP	9,00 / 4,64	12,00 / 4,46
Heating capacity / COP (A +7°C, W 65°C)	kW / COP	9,00 / 2,48	12,00 / 2,41
Heating capacity / COP (A +2°C, W 35°C)	kW / COP	9,00 / 3,45	12,00 / 3,26
Heating capacity / COP (A +2°C, W 65°C)	kW / COP	9,00 / 2,06	10,30 / 2,01
Heating capacity / COP (A -7°C, W 35°C)	kW / COP	9,00 / 2,74	12,00 / 2,52
Heating capacity / COP (A -7°C, W 65°C)		9,00 / 1,79	9,60 / 1,77
Seasonal energy efficiency - Heating Average Climate (W35°C / W55°C)	ETA %	153 / 125	150 / 125
	SCOP	3,90 / 3,20	3,83 / 3,20
Energy Class Heating Average Climate (W35°C / W55°C) ¹⁾	A++ to G	A++ / A++	A++ / A++
Energy Class Heating Average Climate (W35°C / W55°C) ¹⁾	A+++ to D	A+++ / A+++	A+++ / A+++
Seasonal energy efficiency - Heating Warm Climate (W35°C / W55°C)	ETA %	191 / 156	188 / 156
	SCOP	4,85 / 3,98	4,78 / 3,98
Energy Class Heating Warm Climate (W35°C / W55°C)	A++ to G	A+++ / A+++	A++ / A++
Energy Class Heating Warm Climate (W35°C / W55°C)	A+++ to D	A+++ / A+++	A+++ / A+++
Seasonal energy efficiency - Heating Cold Climate (W35°C / W55°C)	ETA %	137 / 116	134 / 113
	SCOP	3,50 / 2,98	3,43 / 2,90
Energy Class Heating Cold Climate (W35°C / W55°C)	A++ to G	A+ / A+	A+ / A+
Energy Class Heating Cold Climate (W35°C / W55°C)	A+++ to D	A+ / A+	A+ / A+
Sound power part load	dB	—	—
Sound power full load	Heat / Cool	dB	68
			69
Dimension	HxWxD	mm	1410 x 1283 x 320
Net weight		kg	151
Refrigerant (R407C) / CO ₂ Eq. ²⁾	kg / T		1,92 / 3,406
Water pipe connector		Inch	R 1
Pump	Number of speeds		7
	Input power (Min / Max)	W	—
Heating water flow (ΔT=5 K, 35°C)	L/min		25,8
Capacity of integrated electric heater	kW		3
Input Power	kW		1,94
Running and Starting current	A		9,3
Current 1	A		28,5
Current 2	A		13,0
Recommended fuse	A		30 / 30
Recommended cable size, supply 1 / 2	mm ²		3 x 4,0 or 6,0 / 3 x 4,0
Operation range	Outdoor ambient	°C	-20 ~ +35
Water outlet	Heat	°C	25 ~ 65

Accessories

PAW-TD20C1E5	Tank 200L - Stainless steel
PAW-TD30C1E5	Tank 300L - Stainless steel
PAW-TA20C1E5STD	Tank 200L - Enamelled
PAW-TA30C1E5STD	Tank 300L - Enamelled

Accessories

PAW-3WYVLV-SI	External 3 way valve
PAW-BTANK50L-1	Buffer tank 50L
PA-AW-WIFI-1TE	WLAN interface
PAW-A2W-RTWIRED	Room thermostat

EER and COP calculation is based in accordance to EN14511. Sound pressure measured at 1m from the outdoor unit and at 1,5m height. Heating sound pressure measured at +7°C (heating water at 55°C).
1 Scale from A++ to G and from A+++ to D from 26th September 2019. 2) WH-MHF models are hermetically sealed.



INTERNET CONTROL: Optional.

AQUAREA AIR

AQUAREA
AIR

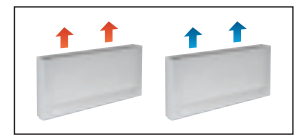

Air flow	Speed	PAW-AAIR-200-2			PAW-AAIR-700-2			PAW-AAIR-900-2		
		Min	Med	Max	Min	Med	Max	Min	Med	Max
Heating mode										
Total heating capacity	W	217,00	470,00	570,00	708,00	1032,00	1188,00	886,00	1420,00	1703,00
Water flow	kg/h	37,30	80,80	98,00	121,80	177,50	204,30	152,40	244,20	292,90
Water pressure drop	kPa	0,40	2,00	2,90	0,30	0,80	1,00	0,50	1,60	2,20
Inlet water temperature	°C	35	35	35	35	35	35	35	35	35
Outlet water temperature	°C	30	30	30	30	30	30	30	30	30
Inlet air temperature	°C	19,00	19,00	19,00	19,00	19,00	19,00	19,00	19,00	19,00
Outlet air temperature	°C	38,90	32,00	30,00	33,30	31,80	30,60	30,20	31,10	30,60
Cooling mode										
Total cooling capacity	W	237,00	345,00	555,00	756,00	1039,00	1204,00	1153,00	1518,00	1746,00
Sensible cooling capacity	W	230,00	314,00	504,00	646,00	903,00	1058,00	1061,00	1384,00	1598,00
Water flow	kg/h	40,00	59,00	95,00	129,00	178,00	207,00	198,00	261,00	300,00
Water pressure drop	kPa	0,40	2,00	2,90	1,00	2,00	2,00	6,00	9,00	12,00
Inlet water temperature	°C	10	10	10	10	10	10	10	10	10
Outlet water temperature	°C	15	15	15	15	15	15	15	15	15
Inlet air temperature	°C	27,00	27,00	27,00	27,00	27,00	27,00	27,00	27,00	27,00
Outlet air temperature	°C	15,00	17,00	18,00	14,00	16,00	17,00	16,00	17,00	18,00
Relative humidity of inlet air	%	47	47	47	47	47	47	47	47	47
Air flow	m ³ /min	0,90	1,90	2,70	2,60	4,20	5,30	4,10	6,10	7,70
Maximum input power	W	7,00	9,00	13,00	14,00	18,00	22,00	16,00	20,00	24,00
Sound pressure	dB(A)	23	33	40	24	36	42	25	36	44
Dimension (HxWxD)	mm	735 x 579 x 129			935 x 579 x 129			1135 x 579 x 129		
Net weight	kg	17			20			23		
3 ways valve included		Yes			Yes			Yes		
Touch screen thermostat		Yes			Yes			Yes		

Super low temperature radiators for heat pump application

The slimline Panasonic Aquarea Air radiators deliver high efficiency climate control.

With a depth of just under 13cm they are at the cutting edge of the market. Blending easily into the home, Aquarea Air's elegant design and product refinements are clear to see in every detail. Exceptional ventilation efficiency means the motor uses considerably less energy (low wattage). The fan speed is continuously modulated by the temperature controller with proportional integral logic, with undoubted advantages for regulating the temperature and humidity in summer mode.



With standard cast radiators.

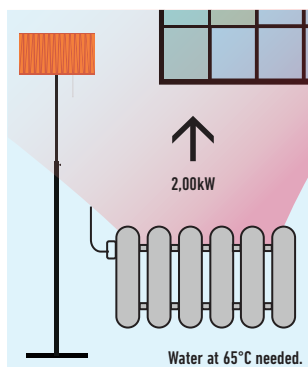

With Aquarea Air.

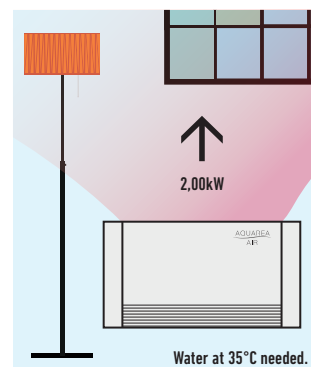

Technical focus:

- High heating capacity
- 3 fan speeds and capacities
- Exclusive design
- Extremely compact (only 12,9cm deep)
- Cooling and dehumidification functions possible (drain is needed)
- 3-way valve included (no overflow valve needed on the installation if more than 3 radiators installed)
- Touch screen thermostat

All temperature curves and capacity are available on www.panasonicproclub.com

FAN COILS

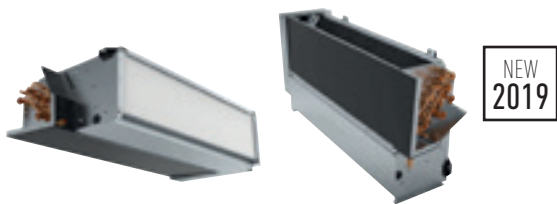

PAW-FC-303TC
Optional Controller.
Wired remote controller.



PAW-FC-RC1
Optional Controller.
Wired remote controller.

		Compact units									High Static Pressure
Left side connection		PAW-FC-D11-1	PAW-FC-D15-1	PAW-FC-D24-1	PAW-FC-D28-1	PAW-FC-D40-1	PAW-FC-D55-1	PAW-FC-D65-1	PAW-FC-D90-1	PAW-FC-H150	
Right side connection		PAW-FC-D11-1-R	PAW-FC-D15-1-R	PAW-FC-D24-1-R	PAW-FC-D28-1-R	PAW-FC-D40-1-R	PAW-FC-D55-1-R	PAW-FC-D65-1-R	PAW-FC-D90-1-R	PAW-FC-H150-R	
Total cooling capacity ¹⁾	Med / S-Hi	kW	1,0 / 1,5	1,2 / 1,7	2,0 / 2,5	2,4 / 3,2	3,2 / 4,6	4,6 / 5,8	6,1 / 7,3	6,1 / 8,1	11,9 / 14,8
Sensible cooling capacity ¹⁾	Med / S-Hi	kW	0,8 / 1,1	0,9 / 1,3	1,5 / 1,9	1,8 / 2,3	2,2 / 3,3	3,3 / 4,5	4,3 / 5,1	4,6 / 6,3	9,6 / 12,9
Heating capacity ¹⁾	Med / S-Hi	kW	1,4 / 2,0	1,5 / 2,2	2,4 / 3,1	2,9 / 4,0	4,1 / 5,7	5,3 / 7,1	7,9 / 9,3	8,1 / 11,6	14,9 / 19,9
Power consumption	S-Lo / Med / S-Hi	W	14 / 24 / 36	10 / 18 / 29	16 / 37 / 45	15 / 37 / 56	28 / 55 / 72	37 / 75 / 105	53 / 100 / 147	90 / 112 / 188	180 / 421 / 675
Fuse rating	A		2	2	2	2	2	2	2	2	6
Dimensions (including pan and electrical box)	HxWxD	mm	220x570x430	220x570x430	220x753x430	220x938x430	220x1122x430	220x1307x430	220x1121x530	220x1316x530	356x1600x798
Weight (without water content)	kg		13	13	15	20	22	26	27	38	63
Sound power global	S-Lo / Med / S-Hi	dB(A)	33 / 40 / 49	31 / 43 / 50	30 / 45 / 52	30 / 44 / 51	34 / 46 / 56	38 / 51 / 58	43 / 56 / 61	50 / 55 / 64	52 / 64 / 71
Sound pressure global	S-Lo / Med / S-Hi	dB(A)	24 / 31 / 40	22 / 34 / 41	21 / 36 / 43	21 / 35 / 42	25 / 37 / 47	29 / 42 / 49	34 / 47 / 52	41 / 46 / 55	31 / 45 / 51
Static pressure	Max	Pa	30	30	50	50	70	70	70	70	110
Airflow ¹⁾	Med / S-Hi	m ³ /h	190 / 283	179 / 265	274 / 390	357 / 499	486 / 716	640 / 933	893 / 1064	936 / 1397	2112 / 3176
Water pressure drop	Med / S-Hi	kPa	19,5 / 39,2	3,9 / 6,3	19,3 / 28,8	17,1 / 28	22,8 / 46,9	37,4 / 60,2	15,4 / 21,5	19,3 / 32,5	19,8 / 26,1
Fan speeds			3 speeds	3 speeds	3 speeds	3 speeds	3 speeds	3 speeds	3 speeds	3 speeds	3 speeds
Fan motor and total speeds			AC 5 speeds	AC 5 speeds	AC 5 speeds	AC 5 speeds	AC 5 speeds	AC 5 speeds	AC 5 speeds	AC 5 speeds	AC 5 speeds
Drain pan and Air filter			Included	Included	Included	Included	Included	Included	Included	Included	Included
Water connections	Inch		1/2	1/2	1/2	1/2	1/2	1/2	3/4	3/4	1

Accessories

PAW-FC-RC1	Advanced wired control for Fan Coil
PAW-FC-303TC	Wired remote controller
PAW-FC-2WY-11/55-1	2 way valve + drain pan (for PAW-FC-D11/15/24/28/40/55-1)
PAW-FC-2WY-65/90-1	2 way valve + drain pan (for PAW-FC-D65/90-1)

Accessories

PAW-FC-2WY-150	2 way valve (for PAW-FC-H150)
PAW-FC-3WY-11/55-1	3 way valve + drain pan (for PAW-FC-D11/15/24/28/40/55-1)
PAW-FC-3WY-65/90-1	3 way valve + drain pan (for PAW-FC-D65/90-1)
PAW-FC-3WY-150	3 way valve (for PAW-FC-H150)

1) Airflow and capacity at 0Pa of static pressure. * Performances based on: Cooling: Air: 27°C DB / 19°C WB, Chilled water: 7°C / 12°C - Heating: Air: 20°C DB, Hot water: 50°C / 45°C.



New range of Fan Coil units

Easy to install, improved sound level and performance. New Fan Coil range consist on one compact ducted range ideal for residential and commercial use and one model with high static pressure for commercial applications. The range certified by Eurovent includes drain pan and filter and are equipped with a low consumption fan motor. The new D type is even more flexible thanks to L Drain pan, same unit can be installed in both Horizontal or in Vertical position.

Fan Coil controller PAW-FC-RC1

This advance control can bring higher level of comfort in heating. The sensor can be used as water flow sensor, stopping the fan when low water temperature, avoiding cold drafts in winter. Also is ready to use J Generation new feature of defrost mode and stop the Fan Coil.

Features:

- Room thermostat
- 3 outputs, 230V relays for fan
- 2 outputs, 230V relays for heating / cooling control
- Modbus RTU slave
- 1 DI for presses detection (key card switch)
- 1 AI for sensor

1 Innovation for an optimum comfort

2 Low energy consumption fan

3 Quality and efficient Coil

4 Flexible vertical - horizontal installation

DHW STAND ALONE



The New DHW Stand Alone is a highly efficient wall-mounted heat pump water heater

This space-saving wall-mounted solution is one of the most efficient models available, designed as a perfect replacement for the electric water heater. The wall-mounted installation, fast heat-up time, and auto function for smart piloting all guarantee customer comfort.

Benefits:

- A+ Highly efficient wall mounted Domestic Hot Water Heat Pump
- Provides reduced power consumption by 75% compared with traditional electric water heater
- Multilingual and End-user friendly Remote Controller
- Digital control panel
- Energy consumption monitoring
- Different modes of operation based on end-user needs
- Mode AUTO: Intelligent Temperature Set Point, thanks to monitoring hot water usage
- Mode BOOST, Mode ECO and Mode ABSENCE
- Photovoltaic function
- Compatible with ducted fresh air intake installations



Model		Wall mounted	
Reference		PAW-DHW100W	PAW-DHW150W
Nominal capacity	L	100	150
Dimensions (H x W x D)	mm	1234 x 522 x 538	1557 x 522 x 538
Empty weight	kg	57	66
Hot and cold connection		3/4" M	3/4" M
Anticorrosion system		Magnesium	Magnesium
Rated water pressure	bar	8	8
Electrical connection	V/Hz	230 / 50	230 / 50
Total maximum power	W	1550	1950
Maximal power heat pump	W	350	350
Power electric heating element	W	1200	1600
Heat pump water temperature range	°C	50 ~ 62	50 ~ 62
Heat pump air temperature range	°C	-5 ~ +43	-5 ~ +43
Duct diameter	mm	125	125
Air flow (without duct)	m ³ /min	160	160
Load losses acceptable on ventilation circuit, without affecting performance	Pa	25	25
Sound power level ¹⁾	dB(A)	45	45
R134a refrigerant capacity	kg	0,6	0,7
Refrigerant volume in tons of CO ₂ equivalent	TCO ₂ Eq.	0,86	1
Refrigerant weight per liter	kg/L	0,006	0,0046
Hot water quantity at 40°C: V40td in 8h (Off-peak) / 14 (Off-peak+6h)	L	151 / 289	182 / 318
Coefficient of performance (at air 7°C ducted, water from 15°C to 53°C)		2,47	2,94
Coefficient of performance (at air 15°C ambient, water from 15°C to 53°C)		2,75	3,21
Acoustic power ErP in ducted configuration ²⁾	dB(A)	45	45
Acoustic power ErP in ambient configuration ²⁾	dB(A)	50	50
Energy Efficiency Class (from A+ to F)		A+	A+
Input PV		Yes	Yes
Performance at 7°C air temperature (EN 16147) ducted at 25 Pa			
Coefficient of performance (COP) according load profile		2,47 - M	2,94 - L
Standby power input (P _{es})	W	20	22
Heating up time (t _h)	h. Min	7h27	11h21
Reference hot water temperature (T _{ref})	°C	52,8	53
Flow rate (air)	m ³ /h	162,7	146,4
Performance at 7°C air temperature (EN 16147)			
Coefficient of performance (COP) according load profile		2,75 - M	3,21 - L
Standby power input (P _{es})	W	18	21
Heating up time (t _h)	h. Min	6h25	9h45
Reference hot water temperature (T _{ref})	°C	52,5	53,1

1) According to ISO3744. 2) Compliant with EN 16147 conditions. * DHW Stand Alone is produced by S.A.T.E.

Ideal for small surfaces

Suitable for all installations (adapted to small surfaces, low ceiling, corner).

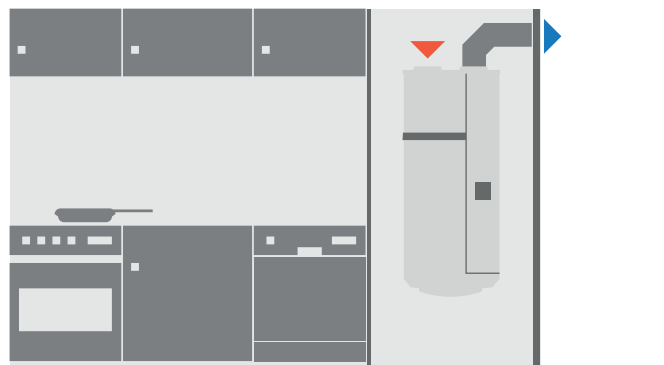

SANITARY TANKS

New Mono-bloc DHW+Ventilation.

Compact solution combining DHW tank and ventilation kit, in one compact surface of 60x60.

- e-heater included
- Tank sensor included
- 3 way valve included
- All electrical components are pre wired to a metal box
- Possible to attach Aquarea control in the front panel
- Safety valve for DHW
- This solution is great solution for low consumption houses (NZEB)

Ventilation unit produced by Komfovent.
Tank module produced by Austria Email AG.



This is a conceptual image, it may change without prior notice.

Combo Tank.

The best option to combine with Mono-bloc units. DHW tank with buffer tank. Designed for retrofit applications, the DHW 185l tank with a 80l buffer tank is particularly suitable for fast integration on an existing installation. Panasonic has developed a tank with 80l Buffer tank and 185l sanitary hot water cylinder. This tank includes a 3-way valve and an "A" Class pump. Easy to install, nice looking, high efficiency for DHW production and for heating.

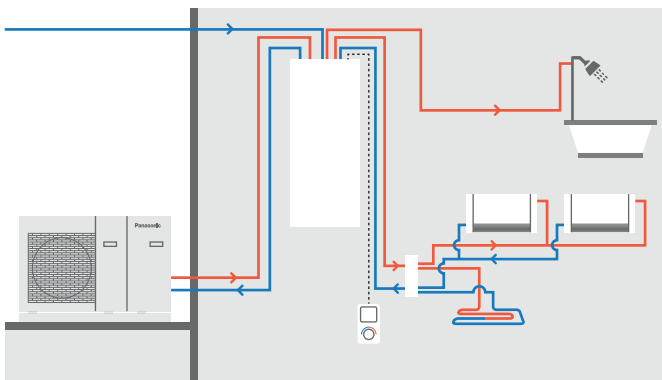

Combo Tank

		PAW-TD20B8E3-1	
Dimension H x W x D	mm	1770 x 640 x 690	
Weight (empty)	kg	150	
Volume	L	185	
Power supply	V, Phase, Hz	230, 1, 50	
		Hot water tank	Buffer tank
Volume	L	185	80
Max working pressure	MPa (bar)	0,8 (8)	0,6 (6)
Pressure test	MPa (bar)	1,2 (12)	0,9 (9)
Max working temp	°C	90	100
Connections	mm	Ø22	Ø22
Material		S 275 JR vitrified	S235 JR
Insulation	Material, t=mm	PUR, 50	PUR 40mm
Heating coil surface	m ²	2,1	
Electrical heater	W	3000	
Energy loss at 65°C	kWh/24h	1,3	
ErP data		Hot water tank	Buffer tank
Energy efficiency class (from A+ to F)		B	B
Standing loss	W	53	46
Storage volume	L	185	80

1) EU Regulation 812/2013. 2) Tested pursuant to EN 12897:2006.



NEW Enamelled Tanks

Model		Enamelled Tank				Enamelled 2 coils Tank (for bivalent Solar + HP)
		PAW-TA15C1E5STD*	PAW-TA20C1E5STD*	PAW-TA30C1E5STD*	PAW-TA40C1E5STD*	PAW-TA30C2E5STD*
Water volume	L	150	200	290	380	350
Maximum water temperature	°C	95	95	95	95	95
Dimensions (Height / Diameter)	mm	1210 / 520	1340 / 610	1800 / 610	1835 / 670	1835 / 670
Weight / filled with water	kg	109 / 254	90 / 280	120 / 389	191 / 572	169 / 519
Electric heater	kW	—	3,00	3,00	3,00	3,00
Power supply	V	—	230	230	230	230
Material inside tank		Enamelled	Enamelled	Enamelled	Enamelled	Enamelled
Exchange surface	m ²	1,2	1,8	2,6	3,8	3,5 / 1,2
Energy loss at 65°C ¹	kWh/24h	1,45	1,37	1,61	1,76	1,76
3 Way valve accessory PAW-3WYVLV-SI or CZ-NV1		Optional	Optional	Optional	Optional	Optional
20m temperature sensor cable included		Yes	Yes	Yes	Yes	Yes
Energy losses	W	60	57	67	73	73
Energy Efficiency Class (from A+ to F)		C	B	B	B	B
Warranty		2 Years	2 Years	2 Years	2 Years	2 Years
Maintenance required		Every 2 years	Every 2 years	Every 2 years	Every 2 years	Every 2 years

1) Insulated tested under EN12897.



Stainless Steel Tank

Model		PAW-TD20C1E5	PAW-TD30C1E5
Water volume	L	192	280
Maximum water temperature	°C	75	75
Dimensions (Height / Diameter)	mm	1270 / 595	1750 / 595
Weight / filled with water	kg	53 / —	65 / —
Electric heater	kW	1,50	1,50
Power supply	V	230	230
Material inside tank		Stainless steel	Stainless steel
Exchange surface	m ²	1,8	1,8
Energy loss at 65°C ¹	kWh/24h	0,99	1,13
3 Way valve accessory PAW-3WYVLV-SI or CZ-NV1		Optional	Optional
20m temperature sensor cable included		Yes	Yes
Energy losses	W	42	46
Energy Efficiency Class (from A+ to F)		A	A
Warranty		2 Years	2 Years
Maintenance required		No	No

1) Insulated tested under EN12897. * Includes proportional control thermostat.



NEW Buffer tank

		PAW-BTANK50L-1
Capacity	L	48
Energy losses	W	42
Energy Efficiency Class (from A+ to F)		B
Material		Stainless Steel
Dimensions (Height / Diameter)	mm	435 x 615
Net weight	kg	17

* Automatic air vent and drain cock are included.

Accessories

PAW-3WYVLV-SI	External 3 way valve
CZ-NV1	3 way valve ready for All in One J and H Generation (optional in internal space)

ACCESSORIES AND CONTROL

Optional PCB's for additional functions



CZ-NS4P
PCB for advanced functions in J and H Generation.

Deice accessories



CZ-NE1P
Base pan heater (for all old Bi-bloc and Mono-bloc, not for the 3 and 5kW).

CZ-NE2P
Base pan heater (for 3kW and 5kW).

CZ-NE3P
Base pan heater for J and H Generation.

Accessories for All in One

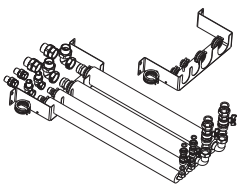

PAW-ADC-PREKIT-1
Flexible pipings and wall mounting plate for All in One J and H Generation.



PAW-ADC-CV150
Decorative magnetic side cover.

Accessories for Aquarea Air

PAW-AAIR-LEGS-1
Kits of 2 legs to support the Aquarea Air on the floor and to protect the water pipings.

Hydraulic accessories



CZ-NV1
3 way valve ready for All in One J and H Generation (optional in internal space).

PAW-3WYVLV-SI
External 3 way valve.

Sanitary tank accessories



PAW-TS1
Tank sensor with 6m cable length.



CZ-TK1
Temperature sensor kit for third party tank (with copper pocket and 6m length sensor cable).

PAW-TS2
Tank sensor with 20m cable length.

PAW-TS4
Tank sensor with 6m cable length and only 6mm diameter.

Special outdoor supports

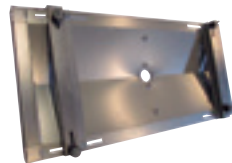

PAW-WTRAY
Tray for condenser water compatible with base ground support.



PAW-GRDSTD40
Outdoor elevation platform.



PAW-GRDBSE20
Outdoor base ground support for noise and vibration absorption (600 x 95 x 130mm, 500kg).

Connectivity solutions



CZ-TAW1
Aquarea Smart Cloud for remote control and maintenance through wireless or wired LAN.



PAW-AW-KNX-1i
KNX Interface compatible with G and F Generation.



PAW-AW-MBS-1
Modbus interface compatible with G and F Generation.

PAW-AW-KNX-H
KNX interface for H Generation.

PAW-AW-MBS-H
Modbus interface for H Generation.

PAW-AW-WIFI-1TE
WLAN accessory with temperature sensor compatible with G and F Generation.

Aquarea Manager accessories (not compatible with J and H Generation)



PAW-HPM1
Aquarea Manager with LCD.



PAW-HPM2
Aquarea Manager without LCD.



PAW-HPMED
Touch screen.

PAW-HPMLCD
LCD Display HPM Manager.



PAW-HPMB1
Buffer tank sensor.

PAW-HPMDHW
Buffer tank sensor with well.

PAW-HPMSOL1
Buffer tank sensor solar (with higher temperature range).



PAW-HPMAH1
Water flow pipe sensor for heating circuit.



PAW-HPMUH
Outdoor temperature sensor.

PAW-HPMINT-F
Interface to connect Aquarea Manager to Heat pump Aquarea Mono-bloc and Bi-bloc F type (HPM can control all parameters from HP).

PAW-HPMINT-U
Interface to connect Aquarea Manager to Heat pump Aquarea Bi-bloc (HPM can control all parameters from HP).

PAW-HPMINT-M
Interface to connect Aquarea Manager to Heat pump Aquarea Mono-bloc (HPM can control all parameters from HP).

PAW-HPMR4
Room sensor + set point adaptation.

PAW-DEWPOINTSSENSOR
Dew point sensor.

Cascade Controller



PAW-A2W-CMH
NEW Modbus IP for BMS communication.

Fan Coil Controller



PAW-FC-303TC
Fan Coil control.



PAW-FC-RC1
NEW Wired remote controller.

Room thermostats



PAW-A2W-RTWIRED
Wired LCD room thermostat with weekly timer.



PAW-A2W-RTWIRELESS
Wireless LCD room thermostat with weekly timer.

H Generation sensors



PAW-A2W-TSOD
Outdoor ambient sensor.



PAW-A2W-TSRT
Zone room sensor.



PAW-A2W-TSHC
Zone water sensor.



PAW-A2W-TSSO
Solar sensor.



PAW-A2W-TSBU
Buffer tank sensor.



PAW-A2W-HB3-**
PAW-A2W-HB4-**
Sound Insulation System for Aquarea Heat Pumps

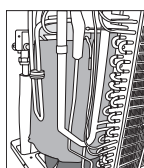

CZ-UG30
Soundproof Kit

Heating & Cooling capacity tables. Based on outlet temperature and outside temperature.

Aquarea High Performance Bi-bloc H Generation Single Phase. Heating and Cooling • R410A Gas

WH-UD03HE5-1

Tamb	HC	IP	COP	HC	IP	COP	HC	IP	COP	HC	IP	COP	HC	IP	COP	HC	IP	COP
LWC	30	30	30	35	35	35	40	40	40	45	45	45	50	50	50	55	55	55
-15	3,20	1,26	2,54	3,20	1,39	2,30	3,10	1,52	2,04	3,00	1,64	1,83	2,80	1,78	1,57	2,75	1,92	1,43
-7	3,20	1,08	2,96	3,20	1,19	2,69	3,20	1,34	2,39	3,20	1,48	2,16	3,20	1,67	1,92	3,20	1,86	1,72
2	3,20	0,82	3,90	3,20	0,90	3,56	3,20	1,03	3,11	3,20	1,16	2,76	3,20	1,33	2,41	3,20	1,49	2,15
7	3,20	0,58	5,52	3,20	0,64	5,00	3,20	0,77	4,16	3,20	0,89	3,60	3,20	1,05	3,05	3,20	1,20	2,67
16	3,20	0,50	6,40	3,20	0,55	5,82	3,20	0,64	5,00	3,20	0,72	4,44	3,20	0,86	3,72	3,20	0,99	3,23
25	3,20	0,42	7,62	3,20	0,46	6,96	3,20	0,55	5,82	3,20	0,63	5,08	3,20	0,73	4,38	3,20	0,82	3,90

WH-UD05HE5-1

Tamb	HC	IP	COP	HC	IP	COP	HC	IP	COP	HC	IP	COP	HC	IP	COP	HC	IP	COP
LWC	30	30	30	35	35	35	40	40	40	45	45	45	50	50	50	55	55	55
-15	4,20	1,75	2,40	4,20	1,94	2,16	3,80	1,96	1,94	3,40	1,98	1,72	3,20	2,05	1,56	3,00	2,12	1,42
-7	4,20	1,46	2,88	4,20	1,62	2,59	4,00	1,72	2,33	3,80	1,82	2,09	3,70	1,95	1,90	3,55	2,08	1,71
2	4,20	1,22	3,44	4,20	1,35	3,11	4,20	1,50	2,80	4,20	1,65	2,55	4,15	1,86	2,23	4,10	2,07	1,98
7	5,00	0,97	5,15	5,00	1,08	4,63	5,00	1,28	3,91	5,00	1,48	3,38	5,00	1,68	2,98	5,00	1,89	2,65
16	5,00	0,83	6,02	5,00	0,92	5,43	5,00	1,15	4,35	5,00	1,38	3,62	5,00	1,53	3,27	5,00	1,68	2,98
25	5,00	0,74	6,76	5,00	0,82	6,10	5,00	1,02	4,90	5,00	1,22	4,10	5,00	1,35	3,70	5,00	1,49	3,36

WH-UD07HE5-1

Tamb	HC	IP	COP	HC	IP	COP	HC	IP	COP	HC	IP	COP	HC	IP	COP	HC	IP	COP
LWC	30	30	30	35	35	35	40	40	40	45	45	45	50	50	50	55	55	55
-15	—	—	—	4,60	1,98	2,32	4,60	2,19	2,10	4,60	2,40	1,92	4,55	2,63	1,73	4,50	2,86	1,57
-7	—	—	—	5,15	1,92	2,68	5,08	2,14	2,37	5,00	2,36	2,12	4,90	2,45	2,00	4,80	2,54	1,89
2	—	—	—	6,55	1,96	3,34	6,58	2,29	2,87	6,60	2,62	2,52	6,30	2,82	2,23	6,00	3,01	1,99
7	—	—	—	7,00	1,57	4,46	7,00	1,84	3,80	7,00	2,10	3,33	6,90	2,35	2,94	6,80	2,59	2,63
25	—	—	—	7,00	0,97	7,22	6,74	1,14	5,91	6,48	1,31	4,95	6,24	1,43	4,36	6,00	1,55	3,87

WH-UD09HE5-1

Tamb	HC	IP	COP	HC	IP	COP	HC	IP	COP	HC	IP	COP	HC	IP	COP	HC	IP	COP
LWC	30	30	30	35	35	35	40	40	40	45	45	45	50	50	50	55	55	55
-15	—	—	—	5,90	2,66	2,22	5,65	2,82	2,00	5,40	2,98	1,81	5,20	3,08	1,69	5,00	3,18	1,57
-7	—	—	—	5,90	2,34	2,52	5,85	2,61	2,24	5,80	2,88	2,01	5,80	2,98	1,95	5,80	3,08	1,88
2	—	—	—	6,70	2,14	3,13	6,65	2,38	2,79	6,60	2,62	2,52	6,30	2,82	2,23	6,00	3,01	1,99
7	—	—	—	9,00	2,18	4,13	9,00	2,49	3,61	9,00	2,79	3,23	8,95	3,25	2,75	8,90	3,70	2,41
25	—	—	—	9,00	1,26	7,14	8,66	1,48	5,85	8,32	1,69	4,92	8,03	1,85	4,34	7,74	2,01	3,85

WH-UD12HE5-1

Tamb	HC	IP	COP	HC	IP	COP	HC	IP	COP	HC	IP	COP	HC	IP	COP	HC	IP	COP
LWC	30	30	30	35	35	35	40	40	40	45	45	45	50	50	50	55	55	55
-15	9,30	3,46	2,69	8,90	3,62	2,46	8,50	3,79	2,24	8,10	3,95	2,05	7,50	4,05	1,85	7,00	4,16	1,68
-7	10,40	3,37	3,09	10,00	3,66	2,73	9,60	3,95	2,43	9,20	4,24	2,17	8,70	4,26	2,04	8,20	4,27	1,92
2	11,80	3,10	3,81	11,40	3,31	3,44	11,00	3,53	3,12	10,60	3,74	2,83	9,80	3,94	2,49	9,10	4,14	2,20
7	12,00	2,10	5,71	12,00	2,53	4,74	12,00	2,96	4,05	12,00	3,39	3,54	12,00	3,78	3,17	12,00	4,16	2,88
25	12,00	1,38	8,70	12,00	1,66	7,23	11,80	1,94	6,08	11,70	2,23	5,25	11,50	2,49	4,62	11,40	2,74	4,16

WH-UD16HE5-1

Tamb	HC	IP	COP	HC	IP	COP	HC	IP	COP	HC	IP	COP	HC	IP	COP	HC	IP	COP
LWC	30	30	30	35	35	35	40	40	40	45	45	45	50	50	50	55	55	55
-15	10,60	4,09	2,59	10,30	4,38	2,35	10,00	4,67	2,14	9,70	4,96	1,96	8,80	4,94	1,78	7,90	4,91	1,61
-7	11,90	4,03	2,95	11,40	4,43	2,57	10,80	4,83	2,24	10,30	5,22	1,97	9,60	5,09	1,89	9,00	4,95	1,82
2	13,50	3,74	3,61	13,00	3,96	3,28	12,40	4,18	2,97	11,90	4,40	2,70	10,80	4,46	2,42	9,80	4,51	2,17
7	16,00	3,21	4,98	16,00	3,74	4,28	16,00	4,27	3,75	16,00	4,80	3,33	15,20	5,11	2,97	14,50	5,41	2,68
25	16,00	2,31	6,93	16,00	2,69	5,95	16,00	3,07	5,21	16,00	3,45	4,64	16,00	3,67	4,36	15,90	3,89	4,09

Tamb: Ambient Temperature (°C). LWC: Leaving Water Condenser Temperature (°C). HC: Heating Capacity (kW). CC: Cooling Capacity (kW). IP: Power Input (kW)
This data is measured by Panasonic in accordance with EN14511-2 standard. This data is for reference purpose only, and does not guarantee the performance.

Aquarea High Performance Bi-bloc H Generation Single Phase. Heating and Cooling • R410A Gas

WH-UD03HE5-1

Tamb	CC	IP	EER	CC	IP	EER	CC	IP	EER
LWC	7	7	7	14	14	14	18	18	18
18	2,40	0,42	5,71	4,40	0,73	6,03	3,70	0,49	7,55
25	3,20	0,73	4,38	4,10	0,86	4,77	3,50	0,59	5,93
35	3,20	1,04	3,08	3,90	1,07	3,64	3,30	0,74	4,46
43	2,90	1,20	2,42	3,50	1,20	2,92	3,00	0,88	3,41

WH-UD05HE5-1

Tamb	CC	IP	EER	CC	IP	EER	CC	IP	EER
LWC	7	7	7	14	14	14	18	18	18
18	4,50	0,89	5,06	5,00	0,90	5,56	5,70	0,90	6,33
25	5,00	1,43	3,50	6,30	1,50	4,20	5,40	1,06	5,09
35	4,50	1,67	2,69	5,50	1,68	3,27	5,00	1,33	3,76
43	3,30	1,53	2,16	4,10	1,52	2,70	4,40	1,53	2,88

WH-UD07HE5-1

Tamb	CC	IP	EER	CC	IP	EER	CC	IP	EER
LWC	7	7	7	14	14	14	18	18	18
18	4,80	0,80	6,00	7,20	1,16	6,21	6,00	1,13	5,31
25	7,00	1,90	3,68	8,47	1,78	4,76	6,00	1,27	4,72
35	6,00	2,28	2,63	6,60	2,48	2,66	6,00	1,68	3,57
43	4,85	2,65	1,83	6,00	2,82	2,13	4,80	1,98	2,42

WH-UD09HE5-1

Tamb	CC	IP	EER	CC	IP	EER	CC	IP	EER
LWC	7	7	7	14	14	14	18	18	18
18	5,40	1,00	5,40	8,40	1,62	5,19	7,00	1,61	4,35
25	7,85	2,40	3,27	10,20	2,46	4,15	7,00	1,77	3,95
35	7,00	2,88	2,43	7,60	3,20	2,38	7,00	2,15	3,26
43	5,20	2,85	1,82	6,99	3,84	1,82	5,60	2,55	2,20

WH-UD12HE5-1

Tamb	CC	IP	EER	CC	IP	EER	CC	IP	EER
LWC	7	7	7	14	14	14	18	18	18
16	7,86	1,18	6,66	13,15	1,40	9,39	10,00	1,73	5,78
25	12,08	2,90	4,17	15,70	2,05	7,66	10,00	1,97	5,08
35	10,00	3,56	2,81	12,00	2,67	4,49	10,00	2,40	4,17
43	7,80	3,80	2,05	11,10	3,19	3,48	8,00	2,85	2,81

WH-UD16HE5-1

Tamb	CC	IP	EER	CC	IP	EER	CC	IP	EER
LWC	7	7	7	14	14	14	18	18	18
16	9,20	1,62	5,68	16,40	2,58	6,36	12,20	2,45	4,98
25	14,40	3,92	3,67	19,20	3,83	5,01	12,20	2,79	4,37
35	12,20	4,76	2,56	15,00	4,98	3,01	12,20	2,96	4,12
43	7,75	3,40	2,28	13,80	5,95	2,32	9,70	4,00	2,43

Tamb: Ambient Temperature (°C). LWC: Leaving Water Condenser Temperature (°C). HC: Heating Capacity (kW). CC: Cooling Capacity (kW). IP: Power Input (kW)
 This data is measured by Panasonic in accordance with EN14511-2 standard. This data is for reference purpose only, and does not guarantee the performance.

Heating & Cooling capacity tables. Based on outlet temperature and outside temperature.

Aqueara High Performance Bi-bloc H Generation Three Phase. Heating and Cooling • R410A Gas

WH-UD09HE8																		
Tamb	HC	IP	COP	HC	IP	COP	HC	IP	COP	HC	IP	COP	HC	IP	COP	HC	IP	COP
LWC	30	30	30	35	35	35	40	40	40	45	45	45	50	50	50	55	55	55
-15	8,65	3,06	2,83	8,30	3,21	2,59	7,95	3,41	2,33	7,60	3,61	2,11	7,15	3,71	1,93	6,70	3,81	1,76
-7	9,35	2,91	3,21	9,00	3,16	2,85	8,85	3,54	2,50	8,70	3,92	2,22	8,30	3,89	2,13	7,90	3,86	2,05
2	9,31	2,35	3,96	9,00	2,51	3,59	9,00	2,78	3,24	9,00	3,05	2,95	8,90	3,49	2,55	8,80	3,94	2,23
7	9,00	1,54	5,84	9,00	1,86	4,84	9,00	2,16	4,17	9,00	2,46	3,66	9,00	2,76	3,26	9,00	3,06	2,94
25	9,00	1,05	8,57	9,00	1,24	7,26	8,73	1,44	6,06	8,46	1,64	5,16	8,28	1,82	4,55	8,10	2,00	4,05
WH-UD12HE8																		
Tamb	HC	IP	COP	HC	IP	COP	HC	IP	COP	HC	IP	COP	HC	IP	COP	HC	IP	COP
LWC	30	30	30	35	35	35	40	40	40	45	45	45	50	50	50	55	55	55
-15	9,30	3,46	2,69	8,90	3,62	2,46	8,50	3,79	2,24	8,10	3,95	2,05	7,50	4,05	1,85	7,00	4,16	1,68
-7	10,40	3,37	3,09	10,00	3,66	2,73	9,60	3,95	2,43	9,20	4,24	2,17	8,70	4,26	2,04	8,20	4,27	1,92
2	11,80	3,10	3,81	11,40	3,31	3,44	11,00	3,53	3,12	10,60	3,74	2,83	9,80	3,94	2,49	9,10	4,14	2,20
7	12,00	2,10	5,71	12,00	2,53	4,74	12,00	2,96	4,05	12,00	3,39	3,54	12,00	3,78	3,17	12,00	4,16	2,88
25	12,00	1,38	8,70	12,00	1,66	7,23	11,80	1,94	6,08	11,70	2,23	5,25	11,50	2,49	4,62	11,40	2,74	4,16
WH-UD16HE8																		
Tamb	HC	IP	COP	HC	IP	COP	HC	IP	COP	HC	IP	COP	HC	IP	COP	HC	IP	COP
LWC	30	30	30	35	35	35	40	40	40	45	45	45	50	50	50	55	55	55
-15	10,60	4,09	2,59	10,30	4,38	2,35	10,00	4,67	2,14	9,70	4,96	1,96	8,80	4,94	1,78	7,90	4,91	1,61
-7	11,90	4,03	2,95	11,40	4,43	2,57	10,80	4,83	2,24	10,30	5,22	1,97	9,60	5,09	1,89	9,00	4,95	1,82
2	13,50	3,74	3,61	13,00	3,96	3,28	12,40	4,18	2,97	11,90	4,40	2,70	10,80	4,46	2,42	9,80	4,51	2,17
7	16,00	3,21	4,98	16,00	3,74	4,28	16,00	4,27	3,75	16,00	4,80	3,33	15,20	5,11	2,97	14,50	5,41	2,68
25	16,00	2,31	6,93	16,00	2,69	5,95	16,00	3,07	5,21	16,00	3,45	4,64	16,00	3,67	4,36	15,90	3,89	4,09

Aqueara High Performance Bi-bloc H Generation Three Phase. Heating and Cooling • R410A Gas

WH-UD09HE8									
Tamb	CC	IP	EER	CC	IP	EER	CC	IP	EER
LWC	7	7	7	14	14	14	18	18	18
16	7,50	1,15	6,52	9,10	1,20	7,58	7,00	1,13	6,19
25	8,35	1,77	4,72	10,90	1,78	6,12	7,00	1,24	5,65
35	7,00	2,23	3,14	8,30	2,32	3,58	7,00	1,52	4,61
43	5,52	2,54	2,17	7,69	2,77	2,78	5,60	1,80	3,11
WH-UD12HE8									
Tamb	CC	IP	EER	CC	IP	EER	CC	IP	EER
LWC	7	7	7	14	14	14	18	18	18
16	7,86	1,18	6,66	13,15	1,40	9,39	10,00	1,73	5,78
25	12,08	2,90	4,17	15,70	2,05	7,66	10,00	1,97	5,08
35	10,00	3,56	2,81	12,00	2,67	4,49	10,00	2,40	4,17
43	7,80	3,80	2,05	11,10	3,19	3,48	8,00	2,85	2,81
WH-UD16HE8									
Tamb	CC	IP	EER	CC	IP	EER	CC	IP	EER
LWC	7	7	7	14	14	14	18	18	18
16	9,20	1,62	5,68	16,40	2,58	6,36	12,20	2,45	4,98
25	14,40	3,92	3,67	19,20	3,83	5,01	12,20	2,79	4,37
35	12,20	4,76	2,56	15,00	4,98	3,01	12,20	2,96	4,12
43	7,75	3,40	2,28	13,80	5,95	2,32	9,70	4,00	2,43

Tamb: Ambient Temperature (°C). LWC: Leaving Water Condenser Temperature (°C). HC: Heating Capacity (kW). CC: Cooling Capacity (kW). IP: Power Input (kW)
 This data is measured by Panasonic in accordance with EN14511-2 standard. This data is for reference purpose only, and does not guarantee the performance.

Aquarea T-CAP Bi-bloc H Generation Single Phase / Three Phase. Heating and Cooling • R410A Gas

WH-UX09HE5

Tamb	HC	IP	COP	HC	IP	COP	HC	IP	COP	HC	IP	COP	HC	IP	COP	HC	IP	COP
LWC	30	30	30	35	35	35	40	40	40	45	45	45	50	50	50	55	55	55
-15	9,00	3,24	2,78	9,00	3,51	2,56	9,00	3,91	2,30	9,00	4,30	2,09	9,00	4,73	1,90	9,00	5,16	1,74
-7	9,00	2,71	3,32	9,00	3,16	2,85	9,00	3,62	2,49	9,00	4,07	2,21	9,00	4,27	2,11	9,00	4,46	2,02
2	9,00	2,36	3,81	9,00	2,51	3,59	9,00	2,78	3,24	9,00	3,05	2,95	9,00	3,56	2,53	9,00	4,07	2,21
7	9,00	1,64	5,49	9,00	1,86	4,84	9,00	2,16	4,17	9,00	2,46	3,66	9,00	2,76	3,26	9,00	3,06	2,94
25	13,60	1,50	9,07	13,60	1,71	7,95	13,20	1,93	6,84	12,80	2,14	5,98	12,00	2,41	4,98	11,20	2,67	4,19

WH-UX12HE5

Tamb	HC	IP	COP	HC	IP	COP	HC	IP	COP	HC	IP	COP	HC	IP	COP	HC	IP	COP
LWC	30	30	30	35	35	35	40	40	40	45	45	45	50	50	50	55	55	55
-15	12,00	4,75	2,53	12,00	4,96	2,42	12,00	5,41	2,22	11,00	5,38	2,04	10,80	5,82	1,86	10,50	6,26	1,68
-7	12,00	3,85	3,12	12,00	4,41	2,72	12,00	4,98	2,41	12,00	5,54	2,17	12,00	5,90	2,03	12,00	6,26	1,92
2	12,00	3,19	3,76	12,00	3,49	3,44	12,00	3,87	3,10	12,00	4,25	2,82	12,00	4,86	2,47	12,00	5,47	2,19
7	12,00	2,18	5,50	12,00	2,53	4,74	12,00	2,96	4,05	12,00	3,39	3,54	12,00	3,78	3,17	12,00	4,16	2,88
25	13,60	1,55	8,77	13,60	1,76	7,73	13,40	2,10	6,38	13,20	2,43	5,43	12,60	2,66	4,74	12,00	2,89	4,15

WH-UX09HE8

Tamb	HC	IP	COP	HC	IP	COP	HC	IP	COP	HC	IP	COP	HC	IP	COP	HC	IP	COP
LWC	30	30	30	35	35	35	40	40	40	45	45	45	50	50	50	55	55	55
-15	9,00	3,24	2,78	9,00	3,51	2,56	9,00	3,91	2,30	9,00	4,30	2,09	9,00	4,73	1,90	9,00	5,16	1,74
-7	9,00	2,71	3,32	9,00	3,16	2,85	9,00	3,62	2,49	9,00	4,07	2,21	9,00	4,27	2,11	9,00	4,46	2,02
2	9,00	2,36	3,81	9,00	2,51	3,59	9,00	2,78	3,24	9,00	3,05	2,95	9,00	3,56	2,53	9,00	4,07	2,21
7	9,00	1,64	5,49	9,00	1,86	4,84	9,00	2,16	4,17	9,00	2,46	3,66	9,00	2,76	3,26	9,00	3,06	2,94
25	13,60	1,50	9,07	13,60	1,71	7,95	13,20	1,93	6,84	12,80	2,14	5,98	12,00	2,41	4,98	11,20	2,67	4,19

WH-UX12HE8

Tamb	HC	IP	COP	HC	IP	COP	HC	IP	COP	HC	IP	COP	HC	IP	COP	HC	IP	COP
LWC	30	30	30	35	35	35	40	40	40	45	45	45	50	50	50	55	55	55
-15	12,00	4,75	2,53	12,00	4,96	2,42	12,00	5,41	2,22	12,00	5,86	2,05	11,80	6,24	1,89	11,60	6,62	1,75
-7	12,00	3,85	3,12	12,00	4,41	2,72	12,00	4,98	2,41	12,00	5,54	2,17	12,00	5,90	2,03	12,00	6,26	1,92
2	12,00	3,19	3,76	12,00	3,49	3,44	12,00	3,87	3,10	12,00	4,25	2,82	12,00	4,86	2,47	12,00	5,47	2,19
7	12,00	2,18	5,50	12,00	2,53	4,74	12,00	2,96	4,05	12,00	3,39	3,54	12,00	3,78	3,17	12,00	4,16	2,88
25	13,60	1,55	8,77	13,60	1,76	7,73	13,40	2,10	6,38	13,20	2,43	5,43	12,60	2,66	4,74	12,00	2,89	4,15

WH-UX16HE8

Tamb	HC	IP	COP	HC	IP	COP	HC	IP	COP	HC	IP	COP	HC	IP	COP	HC	IP	COP
LWC	30	30	30	35	35	35	40	40	40	45	45	45	50	50	50	55	55	55
-15	16,00	6,30	2,54	16,00	6,89	2,32	16,00	7,45	2,15	16,00	8,10	1,98	16,00	8,48	1,89	15,20	8,96	1,70
-7	16,00	5,85	2,74	16,00	6,42	2,49	16,00	7,00	2,29	16,00	7,57	2,11	16,00	8,10	1,98	16,00	8,62	1,86
2	16,00	4,67	3,43	16,00	5,21	3,07	16,00	5,74	2,79	16,00	6,31	2,54	16,00	6,90	2,32	16,00	7,50	2,13
7	16,00	3,35	4,78	16,00	3,74	4,28	16,00	4,30	3,72	16,00	4,80	3,33	16,00	5,43	2,95	16,00	5,91	2,71
16	16,00	2,59	6,18	16,00	3,18	5,03	16,00	3,71	4,31	16,00	4,27	3,75	16,00	4,86	3,29	16,00	5,22	3,07
25	16,00	2,02	7,92	16,00	2,58	6,20	16,00	2,91	5,50	16,00	3,36	4,76	16,00	3,74	4,28	16,00	4,00	4,00

Aquarea T-CAP Bi-bloc H Generation Single Phase / Three Phase. Heating and Cooling • R410A Gas

Models	WH-UX09HE5									WH-UX12HE5								
	Tamb	CC	IP	EER	CC	IP	EER	CC	IP	EER	CC	IP	EER	CC	IP	EER	CC	IP
LWC	7	7	7	14	14	14	18	18	18	7	7	7	14	14	14	18	18	18
18	7,00	1,36	5,15	8,55	1,41	6,06	7,00	1,00	7,00	10,00	1,75	5,71	13,20	1,96	6,73	10,00	1,40	7,14
25	7,65	1,91	4,01	11,10	1,98	5,61	7,00	1,10	6,36	11,20	2,67	4,19	16,50	3,01	5,48	10,00	1,60	6,25
35	7,00	2,21	3,17	9,23	2,37	3,89	7,00	1,35	5,19	10,00	3,56	2,81	12,55	3,63	3,46	10,00	1,95	5,13
43	6,25	2,66	2,35	8,55	2,71	3,15	5,60	1,60	3,50	8,00	3,35	2,39	10,00	3,46	2,89	8,00	2,30	3,48
Models	WH-UX09HE8						WH-UX12HE8						WH-UX16HE8					
Tamb	CC	IP	EER	CC	IP	EER	CC	IP	EER	CC	IP	EER	CC	IP	EER	CC	IP	EER
LWC	7	7	7	18	18	18	7	7	7	18	18	18	7	7	7	18	18	18
18	7,00	1,36	5,15	—	—	—	7,50	1,41	5,32	—	—	—	8,50	1,70	5,00	10,00	1,70	5,88
25	7,65	1,91	4,01	—	—	—	8,90	2,16	4,12	—	—	—	14,00	4,00	3,50	14,00	2,94	4,76
35	7,00	2,21	3,17	—	—	—	10,00	3,56	2,81	—	—	—	12,20	4,76	2,56	12,20	3,50	3,49
43	6,25	2,66	2,35	—	—	—	8,00	3,01	2,66	—	—	—	7,10	3,31	2,15	9,80	3,31	2,96

Tamb: Ambient Temperature (°C). LWC: Leaving Water Condenser Temperature (°C). HC: Heating Capacity (kW). CC: Cooling Capacity (kW). IP: Power Input (kW)
 This data is measured by Panasonic in accordance with EN14511-2 standard. This data is for reference purpose only, and does not guarantee the performance.

Heating & Cooling capacity tables. Based on outlet temperature and outside temperature.

Aquarea T-CAP Bi-bloc H Generation Three Phase. Super Quiet outdoor unit. Heating and Cooling - SQC • R410A Gas

WH-UQ09HE8																		
Tamb	HC	IP	COP	HC	IP	COP	HC	IP	COP	HC	IP	COP	HC	IP	COP	HC	IP	COP
LWC	30	30	30	35	35	35	40	40	40	45	45	45	50	50	50	55	55	55
-15	9,00	3,24	2,78	9,00	3,51	2,56	9,00	3,91	2,30	9,00	4,30	2,09	9,00	4,73	1,90	9,00	5,16	1,74
-7	9,00	2,71	3,32	9,00	3,16	2,85	9,00	3,62	2,49	9,00	4,07	2,21	9,00	4,27	2,11	9,00	4,46	2,02
2	9,00	2,36	3,81	9,00	2,51	3,59	9,00	2,78	3,24	9,00	3,05	2,95	9,00	3,56	2,53	9,00	4,07	2,21
7	9,00	1,64	5,49	9,00	1,86	4,84	9,00	2,16	4,17	9,00	2,46	3,66	9,00	2,76	3,26	9,00	3,06	2,94
25	13,60	1,50	9,07	13,60	1,71	7,95	13,20	1,93	6,84	12,80	2,14	5,98	12,00	2,41	4,98	11,20	2,67	4,19
WH-UQ12HE8																		
Tamb	HC	IP	COP	HC	IP	COP	HC	IP	COP	HC	IP	COP	HC	IP	COP	HC	IP	COP
LWC	30	30	30	35	35	35	40	40	40	45	45	45	50	50	50	55	55	55
-15	12,00	4,75	2,53	12,00	4,96	2,42	12,00	5,41	2,22	12,00	5,86	2,05	11,80	6,24	1,89	11,60	6,62	1,75
-7	12,00	3,85	3,12	12,00	4,41	2,72	12,00	4,98	2,41	12,00	5,54	2,17	12,00	5,90	2,03	12,00	6,26	1,92
2	12,00	3,19	3,76	12,00	3,49	3,44	12,00	3,87	3,10	12,00	4,25	2,82	12,00	4,86	2,47	12,00	5,47	2,19
7	12,00	2,18	5,50	12,00	2,53	4,74	12,00	2,96	4,05	12,00	3,39	3,54	12,00	3,78	3,17	12,00	4,16	2,88
25	13,60	1,55	8,77	13,60	1,76	7,73	13,40	2,10	6,38	13,20	2,43	5,43	12,60	2,66	4,74	12,00	2,89	4,15
WH-UQ16HE8																		
Tamb	HC	IP	COP	HC	IP	COP	HC	IP	COP	HC	IP	COP	HC	IP	COP	HC	IP	COP
LWC	30	30	30	35	35	35	40	40	40	45	45	45	50	50	50	55	55	55
-15	16,00	6,30	2,54	16,00	6,89	2,32	16,00	7,45	2,15	16,00	8,10	1,98	16,00	8,48	1,89	15,20	8,96	1,70
-7	16,00	5,85	2,74	16,00	6,42	2,49	16,00	7,00	2,29	16,00	7,57	2,11	16,00	8,10	1,98	16,00	8,62	1,86
2	16,00	4,67	3,43	16,00	5,21	3,07	16,00	5,74	2,79	16,00	6,31	2,54	16,00	6,90	2,32	16,00	7,50	2,13
7	16,00	3,35	4,78	16,00	3,74	4,28	16,00	4,30	3,72	16,00	4,80	3,33	16,00	5,43	2,95	16,00	5,91	2,71
16	16,00	2,59	6,18	16,00	3,18	5,03	16,00	3,71	4,31	16,00	4,27	3,75	16,00	4,86	3,29	16,00	5,22	3,07
25	16,00	2,02	7,92	16,00	2,58	6,20	16,00	2,91	5,50	16,00	3,36	4,76	16,00	3,74	4,28	16,00	4,00	4,00

Aquarea T-CAP Bi-bloc H Generation Three Phase. Super Quiet outdoor unit. Heating and Cooling - SQC • R410A Gas

WH-UQ09HE8						
Tamb	CC	IP	EER	CC	IP	EER
LWC	7	7	7	18	18	18
18	7,00	1,36	5,15	—	—	—
25	7,65	1,91	4,01	—	—	—
35	7,00	2,21	3,17	—	—	—
43	6,25	2,66	2,35	—	—	—
WH-UQ12HE8						
Tamb	CC	IP	EER	CC	IP	EER
LWC	7	7	7	18	18	18
18	7,50	1,41	5,32	—	—	—
25	8,90	2,16	4,12	—	—	—
35	10,00	3,56	2,81	—	—	—
43	8,00	3,01	2,66	—	—	—
WH-UQ16HE8						
Tamb	CC	IP	EER	CC	IP	EER
LWC	7	7	7	18	18	18
18	8,50	1,70	5,00	10,00	1,70	5,88
25	14,00	4,00	3,50	14,00	2,94	4,76
35	12,20	4,76	2,56	12,20	3,50	3,49
43	7,10	3,31	2,15	9,80	3,31	2,96

Tamb: Ambient Temperature (°C). LWC: Leaving Water Condenser Temperature (°C). HC: Heating Capacity (kW). CC: Cooling Capacity (kW). IP: Power Input (kW)
 This data is measured by Panasonic in accordance with EN14511-2 standard. This data is for reference purpose only, and does not guarantee the performance.

Aquarea High Performance Mono-bloc H Generation Single Phase. Heating and Cooling - MDC • R410A Gas

WH-MDC05H3E5

Tamb	HC	IP	COP	HC	IP	COP	HC	IP	COP	HC	IP	COP	HC	IP	COP	HC	IP	COP
LWC	30	30	30	35	35	35	40	40	40	45	45	45	50	50	50	55	55	55
-15	5,13	2,02	2,54	5,00	2,20	2,27	4,88	2,39	2,04	4,75	2,57	1,85	4,08	2,29	1,78	3,40	2,00	1,70
-7	4,80	1,49	3,23	4,70	1,65	2,85	4,60	1,82	2,53	4,50	1,98	2,27	4,40	2,13	2,07	4,30	2,28	1,89
2	5,10	1,34	3,81	4,80	1,43	3,36	4,50	1,52	2,96	4,20	1,61	2,61	4,10	1,67	2,46	4,00	1,72	2,33
7	5,00	0,79	6,33	5,00	0,99	5,08	5,00	1,18	4,24	5,00	1,37	3,65	5,00	1,57	3,19	5,00	1,76	2,84
12	4,85	0,77	6,29	4,83	0,89	5,46	4,82	1,00	4,82	4,80	1,12	4,29	4,74	1,25	3,81	4,68	1,37	3,42

WH-MDC07H3E5

Tamb	HC	IP	COP	HC	IP	COP	HC	IP	COP	HC	IP	COP	HC	IP	COP	HC	IP	COP
LWC	30	30	30	35	35	35	40	40	40	45	45	45	50	50	50	55	55	55
-15	4,60	1,68	2,75	4,60	1,89	2,43	4,60	2,11	2,19	4,60	2,32	1,98	4,55	2,56	1,78	4,50	2,79	1,61
-7	5,60	1,88	2,99	5,50	2,04	2,70	5,40	2,21	2,45	5,30	2,37	2,24	5,15	2,56	2,01	5,00	2,75	1,82
2	6,65	1,79	3,73	6,60	2,00	3,30	6,55	2,22	2,96	6,50	2,43	2,67	6,40	2,64	2,43	6,30	2,84	2,22
7	7,00	1,33	5,28	7,00	1,55	4,52	7,00	1,78	3,94	7,00	2,00	3,50	7,00	2,24	3,13	7,00	2,47	2,83
12	7,00	1,30	5,38	7,00	1,45	4,83	7,05	1,65	4,27	7,10	1,90	3,74	7,15	2,10	3,40	7,20	2,30	3,13

WH-MDC09H3E5

Tamb	HC	IP	COP	HC	IP	COP	HC	IP	COP	HC	IP	COP	HC	IP	COP	HC	IP	COP
LWC	30	30	30	35	35	35	40	40	40	45	45	45	50	50	50	55	55	55
-15	6,10	2,34	2,61	5,90	2,50	2,36	5,70	2,67	2,14	5,50	2,83	1,94	5,25	2,99	1,76	5,00	3,14	1,59
-7	6,55	2,26	2,90	6,40	2,46	2,60	6,25	2,66	2,35	6,10	2,86	2,13	5,95	3,06	1,95	5,80	3,25	1,78
2	6,85	1,92	3,58	6,80	2,14	3,18	6,75	2,37	2,85	6,70	2,59	2,59	6,50	2,78	2,34	6,30	2,96	2,13
7	9,00	1,80	5,01	9,00	2,10	4,29	9,00	2,41	3,74	9,00	2,71	3,32	9,00	3,01	2,99	9,00	3,31	2,72
12	9,10	1,61	5,65	9,00	1,79	5,03	9,00	2,09	4,31	9,10	2,40	3,79	9,20	2,80	3,29	9,30	3,00	3,10

WH-MDC12H6E5

Tamb	HC	IP	COP	HC	IP	COP	HC	IP	COP	HC	IP	COP	HC	IP	COP	HC	IP	COP
LWC	30	30	30	35	35	35	40	40	40	45	45	45	50	50	50	55	55	55
-15	9,30	3,46	2,69	8,90	3,62	2,46	8,50	3,79	2,24	8,10	3,95	2,05	—	—	—	7,00	4,10	1,71
-7	10,40	3,37	3,09	10,00	3,66	2,73	9,60	3,95	2,43	9,20	4,24	2,17	—	—	—	8,20	4,21	1,95
2	11,80	3,10	3,81	11,40	3,31	3,44	11,00	3,53	3,12	10,60	3,74	2,83	—	—	—	9,10	4,08	2,23
7	12,00	2,10	5,71	12,00	2,53	4,74	12,00	2,96	4,05	12,00	3,39	3,54	—	—	—	12,00	4,10	2,93
12	12,00	1,38	8,70	12,00	1,66	7,23	11,80	1,94	6,08	11,70	2,23	5,25	—	—	—	11,40	2,74	4,16

WH-MDC16H6E5

Tamb	HC	IP	COP	HC	IP	COP	HC	IP	COP	HC	IP	COP	HC	IP	COP	HC	IP	COP
LWC	30	30	30	35	35	35	40	40	40	45	45	45	50	50	50	55	55	55
-15	10,60	4,09	2,59	10,30	4,38	2,35	10,00	4,67	2,14	9,70	4,96	1,96	7,90	4,84	1,63	—	—	—
-7	11,90	4,03	2,95	11,40	4,43	2,57	10,80	4,83	2,24	10,30	5,22	1,97	9,00	4,88	1,84	—	—	—
2	13,50	13,74	0,98	13,00	3,96	3,28	12,40	4,18	2,97	11,90	4,40	2,70	9,80	4,44	2,21	—	—	—
7	16,00	3,21	4,98	16,00	3,74	4,28	16,00	4,27	3,75	16,00	4,80	3,33	14,50	5,33	2,72	—	—	—
12	16,00	2,31	6,93	16,00	2,69	5,95	16,00	3,07	5,21	16,00	3,45	4,64	15,90	3,89	4,09	—	—	—

Tamb: Ambient Temperature (°C). LWC: Leaving Water Condenser Temperature (°C). HC: Heating Capacity (kW). CC: Cooling Capacity (kW). IP: Power Input (kW)
 This data is measured by Panasonic in accordance with EN14511-2 standard. This data is for reference purpose only, and does not guarantee the performance.

Heating & Cooling capacity tables. Based on outlet temperature and outside temperature.

Aquarea High Performance Mono-bloc H Generation Single Phase. Heating and Cooling - MDC • R410A Gas

WH-MDC05H3E5

Tamb	CC	IP	EER	CC	IP	EER	CC	IP	EER
LWC	7	7	7	14	14	14	18	18	18
24	5,15	1,06	4,86	6,45	1,05	6,14	5,90	0,73	8,08
35	4,50	1,37	3,28	5,52	1,36	4,06	5,10	1,00	5,10
43	3,74	1,55	2,41	4,65	1,60	2,91	4,25	1,20	3,54

WH-MDC07H3E5

Tamb	CC	IP	EER	CC	IP	EER	CC	IP	EER
LWC	7	7	7	14	14	14	18	18	18
24	6,85	1,78	3,85	8,15	1,80	4,53	7,10	1,20	5,92
35	6,00	2,16	2,78	5,35	1,53	3,51	6,00	1,55	3,87
43	4,90	2,48	1,98	4,45	1,80	2,47	5,10	1,85	2,76

WH-MDC09H3E5

Tamb	CC	IP	EER	CC	IP	EER	CC	IP	EER
LWC	7	7	7	14	14	14	18	18	18
24	7,30	1,92	3,80	8,60	1,98	4,34	8,20	1,55	5,29
35	7,00	2,69	2,60	6,40	1,93	3,32	7,00	1,95	3,59
43	5,25	2,84	1,85	5,40	2,25	2,40	6,00	2,30	2,61

WH-MDC12H6E5

Tamb	CC	IP	EER	CC	IP	EER	CC	IP	EER
LWC	7	7	7	14	14	14	18	18	18
16	7,86	1,18	6,66	13,15	2,05	6,41	10,00	1,73	5,78
25	12,08	2,90	4,17	15,70	3,05	5,15	10,00	1,97	5,08
35	10,00	3,56	2,81	12,00	3,67	3,27	10,00	2,15	4,65
43	7,80	3,80	2,05	11,10	3,19	3,48	8,00	2,85	2,81

WH-MDC16H6E5

Tamb	CC	IP	EER	CC	IP	EER	CC	IP	EER
LWC	7	7	7	14	14	14	18	18	18
16	9,20	1,62	5,68	16,40	2,58	6,36	12,20	2,45	4,98
25	14,40	3,92	3,67	19,20	3,83	5,01	12,20	2,79	4,37
35	12,20	4,76	2,56	15,00	4,98	3,01	12,20	2,96	4,12
43	7,75	3,40	2,28	13,80	5,95	2,32	9,70	4,00	2,43

Tamb: Ambient Temperature (°C). LWC: Leaving Water Condenser Temperature (°C). HC: Heating Capacity (kW). CC: Cooling Capacity (kW). IP: Power Input (kW)
This data is measured by Panasonic in accordance with EN14511-2 standard. This data is for reference purpose only, and does not guarantee the performance.

Aquarea T-CAP Mono-bloc H Generation Single Phase / Three Phase. Heating and Cooling - MXC • R410A Gas

WH-MXC09H3E5 / WH-MXC09H3E8

Tamb	HC	IP	COP	HC	IP	COP	HC	IP	COP	HC	IP	COP	HC	IP	COP	HC	IP	COP
LWC	30	30	30	35	35	35	40	40	40	45	45	45	50	50	50	55	55	55
-15	9,00	3,24	2,78	9,00	3,51	2,56	9,00	3,91	2,30	9,00	4,30	2,09	9,00	4,73	1,90	9,00	5,16	1,74
-7	9,00	2,71	3,32	9,00	3,16	2,85	9,00	3,62	2,49	9,00	4,07	2,21	9,00	4,27	2,11	9,00	4,46	2,02
2	9,00	2,36	3,81	9,00	2,51	3,59	9,00	2,78	3,24	9,00	3,05	2,95	9,00	3,56	2,53	9,00	4,07	2,21
7	9,00	1,64	5,49	9,00	1,86	4,84	9,00	2,16	4,17	9,00	2,46	3,66	9,00	2,76	3,26	9,00	3,06	2,94
25	13,60	1,50	9,07	13,60	1,71	7,95	13,20	1,93	6,84	12,80	2,14	5,98	12,00	2,41	4,98	11,20	2,67	4,19

WH-MXC12H6E5

Tamb	HC	IP	COP	HC	IP	COP	HC	IP	COP	HC	IP	COP	HC	IP	COP	HC	IP	COP
LWC	30	30	30	35	35	35	40	40	40	45	45	45	50	50	50	55	55	55
-15	12,00	4,75	2,53	12,00	4,96	2,42	12,00	5,41	2,22	11,00	5,38	2,04	10,80	5,82	1,86	10,50	6,26	1,68
-7	12,00	3,85	3,12	12,00	4,41	2,72	12,00	4,98	2,41	12,00	5,54	2,17	12,00	5,90	2,03	12,00	6,26	1,92
2	12,00	3,19	3,76	12,00	3,49	3,44	12,00	3,87	3,10	12,00	4,25	2,82	12,00	4,86	2,47	12,00	5,47	2,19
7	12,00	2,18	5,50	12,00	2,53	4,74	12,00	2,96	4,05	12,00	3,39	3,54	12,00	3,78	3,17	12,00	4,16	2,88
25	13,60	1,55	8,77	13,60	1,76	7,73	13,40	2,10	6,38	13,20	2,43	5,43	12,60	2,66	4,74	12,00	2,89	4,15

WH-MXC12H9E8

Tamb	HC	IP	COP	HC	IP	COP	HC	IP	COP	HC	IP	COP	HC	IP	COP	HC	IP	COP
LWC	30	30	30	35	35	35	40	40	40	45	45	45	50	50	50	55	55	55
-15	12,00	4,75	2,53	12,00	4,96	2,42	12,00	5,41	2,22	12,00	5,86	2,05	11,80	6,24	1,89	11,60	6,62	1,75
-7	12,00	3,85	3,12	12,00	4,41	2,72	12,00	4,98	2,41	12,00	5,54	2,17	12,00	5,90	2,03	12,00	6,26	1,92
2	12,00	3,19	3,76	12,00	3,49	3,44	12,00	3,87	3,10	12,00	4,25	2,82	12,00	4,86	2,47	12,00	5,47	2,19
7	12,00	2,18	5,50	12,00	2,53	4,74	12,00	2,96	4,05	12,00	3,39	3,54	12,00	3,78	3,17	12,00	4,16	2,88
25	13,60	1,55	8,77	13,60	1,76	7,73	13,40	2,10	6,38	13,20	2,43	5,43	12,60	2,66	4,74	12,00	2,89	4,15

WH-MXC16H9E8

Tamb	HC	IP	COP	HC	IP	COP	HC	IP	COP	HC	IP	COP	HC	IP	COP	HC	IP	COP
LWC	30	30	30	35	35	35	40	40	40	45	45	45	50	50	50	55	55	55
-15	16,00	6,30	2,54	16,00	6,89	2,32	16,00	7,45	2,15	16,00	8,10	1,98	16,00	8,48	1,89	15,20	8,96	1,70
-7	16,00	5,85	2,74	16,00	6,42	2,49	16,00	7,00	2,29	16,00	7,57	2,11	16,00	8,10	1,98	16,00	8,62	1,86
2	16,00	4,67	3,43	16,00	5,21	3,07	16,00	5,74	2,79	16,00	6,31	2,54	16,00	6,90	2,32	16,00	7,50	2,13
7	16,00	3,35	4,78	16,00	3,74	4,28	16,00	4,30	3,72	16,00	4,80	3,33	16,00	5,43	2,95	16,00	5,91	2,71
16	16,00	2,59	6,18	16,00	3,18	5,03	16,00	3,71	4,31	16,00	4,27	3,75	16,00	4,86	3,29	16,00	5,22	3,07
25	16,00	2,02	7,92	16,00	2,58	6,20	16,00	2,91	5,50	16,00	3,36	4,76	16,00	3,74	4,28	16,00	4,00	4,00

Aquarea T-CAP Mono-bloc H Generation Single Phase / Three Phase. Heating and Cooling - MXC • R410A Gas

Models	WH-MXC09H3E5									WH-MXC12H6E5								
	Tamb	CC	IP	EER	CC	IP	EER	CC	IP	EER	CC	IP	EER	CC	IP	EER	CC	IP
LWC	7	7	7	14	14	14	18	18	18	7	7	7	14	14	14	18	18	18
18	7,00	1,36	5,15	8,55	1,41	6,06	7,00	1,00	7,00	10,00	1,75	5,71	13,20	1,96	6,73	10,00	1,40	7,14
25	7,65	1,91	4,01	11,10	1,98	5,61	7,00	1,10	6,36	11,20	2,67	4,19	16,50	3,01	5,48	10,00	1,60	6,25
35	7,00	2,21	3,17	9,23	2,37	3,89	7,00	1,35	5,19	10,00	3,56	2,81	12,55	3,63	3,46	10,00	1,95	5,13
43	6,25	2,66	2,35	8,55	2,71	3,15	5,60	1,60	3,50	8,00	3,35	2,39	10,00	3,46	2,89	8,00	2,30	3,48
Models	WH-MXC09H3E8						WH-MXC12H9E8						WH-MXC16H9E8					
	Tamb	CC	IP	EER	CC	IP	EER	CC	IP	EER	CC	IP	EER	CC	IP	EER	CC	IP
LWC	7	7	7	18	18	18	7	7	7	18	18	18	7	7	7	18	18	18
18	7,00	1,36	5,15	—	—	—	7,50	1,41	5,32	—	—	—	8,50	1,70	5,00	10,00	1,70	5,88
25	7,65	1,91	4,01	—	—	—	8,90	2,16	4,12	—	—	—	14,00	4,00	3,50	14,00	2,94	4,76
35	7,00	2,21	3,17	—	—	—	10,00	3,56	2,81	—	—	—	12,20	4,76	2,56	12,20	3,50	3,49
43	6,25	2,66	2,35	—	—	—	8,00	3,01	2,66	—	—	—	7,10	3,31	2,15	9,80	3,31	2,96

Tamb: Ambient Temperature (°C). LWC: Leaving Water Condenser Temperature (°C). HC: Heating Capacity (kW). CC: Cooling Capacity (kW). IP: Power Input (kW)
 This data is measured by Panasonic in accordance with EN14511-2 standard. This data is for reference purpose only, and does not guarantee the performance.

Heating & Cooling capacity tables. Based on outlet temperature and outside temperature.

Aquarea HT Bi-bloc F Generation Single Phase / Three Phase. Heating Only • R407C Gas

WH-UH09FE5

Tamb	HC	IP	COP	HC	IP	COP	HC	IP	COP	HC	IP	COP	HC	IP	COP	HC	IP	COP	HC	IP	COP	HC	IP	COP
LWC	30	30	30	35	35	35	40	40	40	45	45	45	50	50	50	55	55	55	60	60	60	65	65	65
-15	9,00	3,46	2,60	9,00	3,71	2,43	9,00	4,01	2,24	8,80	4,26	2,07	8,60	4,61	1,87	8,50	4,91	1,73	8,00	5,06	1,58	7,80	5,86	1,33
-7	9,00	3,06	2,94	9,00	3,29	2,74	9,00	3,56	2,53	8,90	3,83	2,32	8,90	4,11	2,17	8,90	4,46	2,00	8,90	4,96	1,79	8,90	5,46	1,63
2	9,00	2,43	3,70	9,00	2,61	3,45	9,00	2,91	3,09	9,00	3,21	2,80	9,00	3,55	2,54	9,00	3,88	2,32	9,00	4,35	2,07	9,00	4,76	1,89
7	9,00	1,82	4,95	9,00	1,94	4,64	9,00	2,21	4,07	9,00	2,46	3,66	9,00	2,76	3,26	9,00	3,06	2,94	9,00	3,46	2,60	9,00	3,96	2,27
16	9,00	1,46	6,16	9,00	1,56	5,77	9,00	1,81	4,97	8,90	2,02	4,41	8,80	2,31	3,81	8,60	2,52	3,41	8,20	2,77	2,96	8,20	3,18	2,58
25	12,00	1,66	7,23	12,00	1,76	6,82	12,00	2,01	5,97	10,80	2,14	5,05	10,60	2,46	4,31	10,20	2,66	3,83	9,80	2,89	3,39	9,60	3,31	2,90

WH-UH12FE5

Tamb	HC	IP	COP	HC	IP	COP	HC	IP	COP	HC	IP	COP	HC	IP	COP	HC	IP	COP	HC	IP	COP	HC	IP	COP
LWC	30	30	30	35	35	35	40	40	40	45	45	45	50	50	50	55	55	55	60	60	60	65	65	65
-15	12,00	5,16	2,33	12,00	5,53	2,17	11,00	5,51	2,00	10,60	5,53	1,92	10,30	5,63	1,83	9,70	5,76	1,68	9,00	6,01	1,50	8,00	6,11	1,31
-7	12,00	4,43	2,71	12,00	4,76	2,52	11,50	4,91	2,34	11,20	5,06	2,21	10,80	5,16	2,09	10,10	5,28	1,91	10,00	5,66	1,77	9,60	5,91	1,62
2	12,00	3,42	3,51	12,00	3,68	3,26	11,50	3,86	2,98	11,30	4,14	2,73	11,00	4,51	2,44	10,80	4,86	2,22	10,65	5,31	2,01	10,30	5,59	1,84
7	12,00	2,52	4,76	12,00	2,69	4,46	12,00	3,06	3,92	12,00	3,44	3,49	12,00	3,81	3,15	12,00	4,28	2,80	12,00	4,76	2,52	12,00	5,41	2,22
16	12,00	2,03	5,91	12,00	2,17	5,53	12,00	2,52	4,76	12,00	2,86	4,20	11,50	3,19	3,61	11,50	3,48	3,30	11,00	3,82	2,88	11,00	4,37	2,52
25	12,00	1,66	7,23	12,00	1,76	6,82	12,00	2,01	5,97	11,80	2,41	4,90	11,20	2,64	4,24	10,80	2,86	3,78	10,50	3,11	3,38	10,30	3,62	2,85

WH-UH09FE8

Tamb	HC	IP	COP	HC	IP	COP	HC	IP	COP	HC	IP	COP	HC	IP	COP	HC	IP	COP	HC	IP	COP	HC	IP	COP
LWC	30	30	30	35	35	35	40	40	40	45	45	45	50	50	50	55	55	55	60	60	60	65	65	65
-15	9,00	3,46	2,60	9,00	3,71	2,43	9,00	4,01	2,24	8,80	4,26	2,07	8,60	4,61	1,87	8,50	4,91	1,73	8,00	5,06	1,58	7,80	5,86	1,33
-7	9,00	3,06	2,94	9,00	3,29	2,74	9,00	3,56	2,53	8,90	3,83	2,32	8,90	4,11	2,17	8,90	4,46	2,00	8,90	4,96	1,79	8,90	5,46	1,63
2	9,00	2,43	3,70	9,00	2,61	3,45	9,00	2,91	3,09	9,00	3,21	2,80	9,00	3,55	2,54	9,00	3,88	2,32	9,00	4,35	2,07	9,00	4,76	1,89
7	9,00	1,82	4,95	9,00	1,94	4,64	9,00	2,21	4,07	9,00	2,46	3,66	9,00	2,76	3,26	9,00	3,06	2,94	9,00	3,46	2,60	9,00	3,96	2,27
16	9,00	1,46	6,16	9,00	1,56	5,77	9,00	1,81	4,97	8,90	2,02	4,41	8,80	2,31	3,81	8,60	2,52	3,41	8,20	2,77	2,96	8,20	3,18	2,58
25	12,00	1,66	7,23	12,00	1,76	6,82	12,00	2,01	5,97	10,80	2,14	5,05	10,60	2,46	4,31	10,20	2,66	3,83	9,80	2,89	3,39	9,60	3,31	2,90

WH-UH12FE8

Tamb	HC	IP	COP	HC	IP	COP	HC	IP	COP	HC	IP	COP	HC	IP	COP	HC	IP	COP	HC	IP	COP	HC	IP	COP
LWC	30	30	30	35	35	35	40	40	40	45	45	45	50	50	50	55	55	55	60	60	60	65	65	65
-15	12,00	5,16	2,33	12,00	5,53	2,17	11,00	5,51	2,00	10,60	5,53	1,92	10,30	5,63	1,83	9,70	5,76	1,68	9,00	6,01	1,50	8,00	6,11	1,31
-7	12,00	4,43	2,71	12,00	4,76	2,52	11,50	4,91	2,34	11,20	5,06	2,21	10,80	5,16	2,09	10,10	5,28	1,91	10,00	5,66	1,77	9,60	5,91	1,62
2	12,00	3,42	3,51	12,00	3,68	3,26	11,50	3,86	2,98	11,30	4,14	2,73	11,00	4,51	2,44	10,80	4,86	2,22	10,65	5,31	2,01	10,30	5,59	1,84
7	12,00	2,52	4,76	12,00	2,69	4,46	12,00	3,06	3,92	12,00	3,44	3,49	12,00	3,81	3,15	12,00	4,28	2,80	12,00	4,76	2,52	12,00	5,41	2,22
16	12,00	2,03	5,91	12,00	2,17	5,53	12,00	2,52	4,76	12,00	2,86	4,20	11,50	3,19	3,61	11,50	3,48	3,30	11,00	3,82	2,88	11,00	4,37	2,52
25	12,00	1,66	7,23	12,00	1,76	6,82	12,00	2,01	5,97	11,80	2,41	4,90	11,20	2,64	4,24	10,80	2,86	3,78	10,50	3,11	3,38	10,30	3,62	2,85

Aquarea HT Mono-bloc G Generation Single Phase. Heating Only - MHF • R407C Gas

WH-MHF09G3E5

Tamb	HC	IP	COP	HC	IP	COP	HC	IP	COP	HC	IP	COP	HC	IP	COP	HC	IP	COP	HC	IP	COP
LWC	30	30	30	35	35	35	40	40	40	45	45	45	50	50	50	55	55	55	60	60	60
-15	9,00	3,46	2,60	9,00	3,71	2,43	9,00	4,01	2,24	8,80	4,26	2,07	8,50	4,71	1,80	7,80	5,38	1,45			
-7	9,00	3,06	2,94	9,00	3,29	2,74	9,00	3,56	2,53	8,90	3,83	2,32	8,90	4,28	2,08	9,00	5,02	1,79			
2	9,00	2,43	3,70	9,00	2,61	3,45	9,00	2,91	3,09	9,00	3,21	2,80	9,00	3,72	2,42	9,00	4,37	2,06			
7	9,00	1,82	4,95	9,00	1,94	4,64	9,00	2,21	4,07	9,00	2,46	3,66	9,00	2,99	3,01	9,00	3,64	2,47			
25	9,00	1,52	5,92	9,00	1,70	5,29	9,00	1,88	4,79	9,00	2,16	4,17	9,00	2,63	3,42	9,00	3,20	2,81			

WH-MHF12G6E5

Tamb	HC	IP	COP	HC	IP	COP	HC	IP	COP	HC	IP	COP	HC	IP	COP	HC	IP	COP	HC	IP	COP
LWC	30	30	30	35	35	35	40	40	40	45	45	45	50	50	50	55	55	55			
-15	12,00	5,16	2,33	12,00	5,53	2,17	11,00	5,51	2,00	10,80	5,49	1,97	9,70	5,52	1,76	8,00	5,61	1,43			
-7	12,00	4,43	2,71	12,00	4,76	2,52	11,50	4,91	2,34	11,20	5,06	2,21	10,10	5,06	2,00	9,60	5,43	1,77			
2	12,00	3,42	3,51	12,00	3,68	3,26	11,50	3,86	2,98	11,30	4,14	2,73	10,80	4,66	2,32	10,30	5,13	2,01			
7	12,00	2,52	4,76	12,00	2,69	4,46	12,00	3,06	3,92	12,00	3,44	3,49	12,00	4,10	2,93	12,00	4,97	2,41			
25	12,00	2,03	5,91	12,00	2,36	5,08	12,00	2,69	4,46	12,00	3,02	3,97	12,00	3,61	3,32	12,00	4,37	2,75			

Tamb: Ambient Temperature (°C). LWC: Leaving Water Condenser Temperature (°C). HC: Heating Capacity (kW). CC: Cooling Capacity (kW). IP: Power Input (kW)
This data is measured by Panasonic in accordance with EN14511-2 standard. This data is for reference purpose only, and does not guarantee the performance.

EXAMPLES OF INSTALLATIONS

Aquarea J and H Generation:
Bivalent with buffer tank and mixing valve

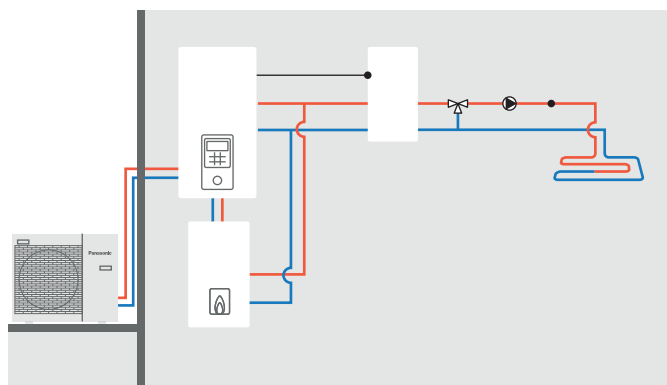

Aquarea J and H Generation:
Buffer tank with solar and mixing valve

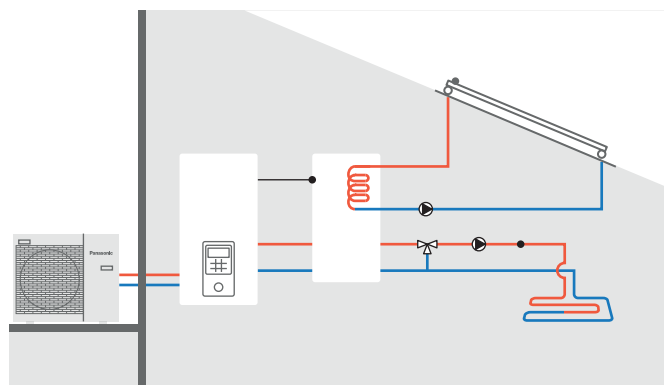

Aquarea J and H Generation:
2 zones with external kit without buffer tank

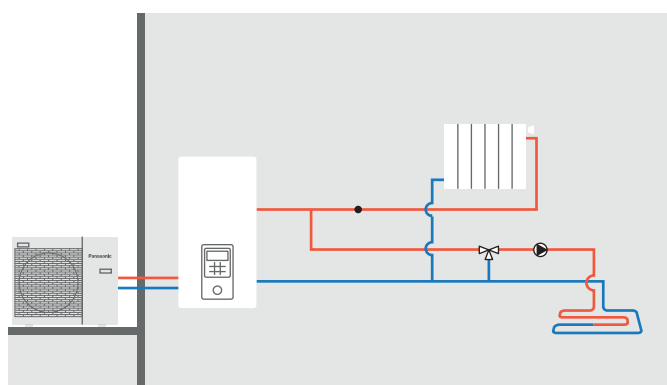

Aquarea J and H Generation:
2 zones with external kit, buffer tank and swimming pool

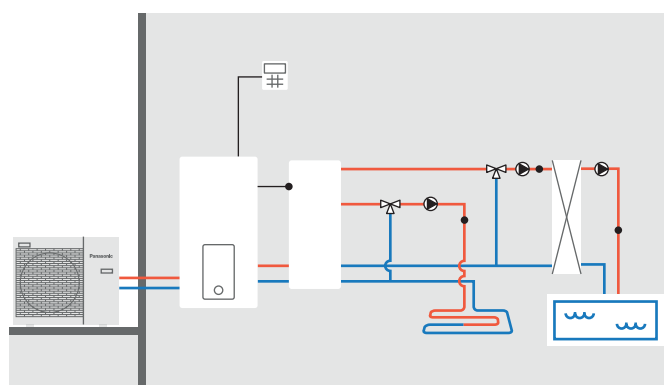

Aquarea All in One J and H Generation:
2 zones with external kit, without buffer tank

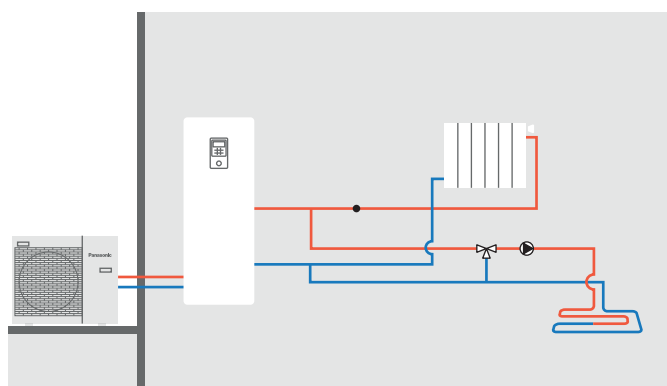

Aquarea All in One 2 zones J and H Generation:
2 zones built-in, without buffer tank

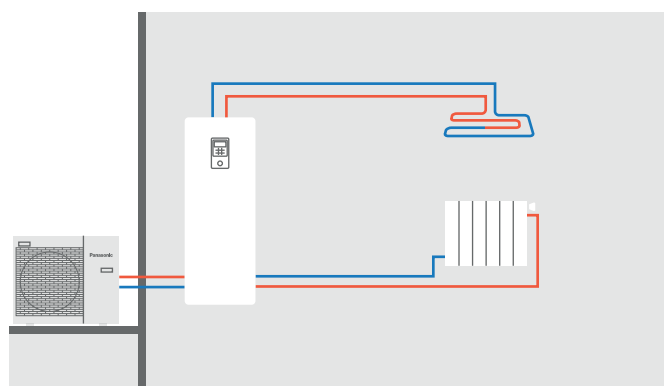



WELCOME TO DOMESTIC RANGE



Go green. Go clean. Go your way.

Panasonic Air Conditioners are designed to provide more than just comfort cooling to homes. They save energy. They purify your surroundings. They adjust cooling power to suit your living spaces and styles. Living an eco-lifestyle your way is now easier than ever.







HIGHLIGHTED FEATURES















Panasonic has developed a range of products designed for you, better than ever before. With its innovative design, high efficiency and advanced purification system, the Etherea range has been designed with your clients in mind.

Panasonic air conditioners provide more savings and more comfort. We believe that going green shouldn't compromise on comfort. Our super silent air conditioners guarantee the purified air to take care of you and your family. And, for a cleaner living environment, the nano™ X helps purify the air as well as your surroundings. Together, these breakthrough technologies define what Panasonic's Eco Clean Life Innovation is all about – innovations that improve our environment while making life as comfortable as possible.



Energy saving

 <p>10,50 SEER</p>	 <p>6,20 SCOP</p>	 <p>ECONAVI</p>	 <p>INVERTER+</p>	 <p>R2 ROTARY COMPRESSOR</p>	 <p>R32</p>
<p>Exceptional seasonal cooling efficiency based on the ErP regulation. Higher SEER ratings mean greater efficiency. Save all the year while cooling!</p>	<p>Exceptional seasonal heating efficiency based on the ErP regulation. Higher SCOP ratings mean greater efficiency. Save all the year while heating!</p>	<p>Econavi. Sunlight Sensor technology can detect and reduce the waste of energy by optimising air conditioner operation according to room conditions. With just one touch of a button, you can save energy.</p>	<p>Inverter Plus. Inverter Plus System classification highlight the Panasonic highest performing systems</p>	<p>Panasonic R2 rotary compressor. Designed to withstand extreme conditions, it delivers high performance and efficiency.</p>	<p>Refrigerant gas R32. Our heat pumps containing the refrigerant R32 show a drastic reduction in the value of Global Warming Potential (GWP). An important step to reduce greenhouse gases. R32 is also a component refrigerant, making it easy to recycle.</p>

High performance and healthy air

 <p>nanoeX</p>	 <p>PM2,5 FILTER</p>	 <p>DUST COLLECTION FILTER</p>	 <p>18dB(A)</p>	 <p>HUMIDITY CONTROL MILD DRY</p>	 <p>AEROWINGS</p>
<p>nanoe™ X. Quality air for life. Panasonic's latest innovation nanoe™ X helps you deodorise, inhibit certain growth of bacteria and viruses that are harmful to you and your family's general well-being.</p>	<p>PM2,5 filter. Particulate matter (PM2,5) can be found suspended in the air, including dust, dirt, smoke and liquid droplets. This filter can catch PM2,5 particles including hazardous pollutants as well as house dust and pollen.</p>	<p>Dust Collection Filter. This filter collects and retain particles suspended on the air, as result the air is cleaner in the room.</p>	<p>Super Quiet. With Super Quiet technology our devices are much more quiet than a library (30dB(A)).</p>	<p>Mild dry. The perfect humidity air controls the humidity level in the air to prevent over-dryness.</p>	<p>More comfort with Aerowings. Direct airflow to ceiling to create shower cooling effect by twin flap built in indoor.</p>
 <p>COOLING MODE</p>	 <p>HEATING MODE</p>	 <p>SUMMER HOUSE</p>	 <p>R22/R410A RENEWAL</p>	 <p>R22 RENEWAL</p>	 <p>5 YEARS COMPRESSOR WARRANTY</p>
<p>Down to -10°C in cooling mode. The air conditioner works in cooling only mode with an outdoor temperature of -10°C.</p>	<p>Down to -15°C in heating mode. The air conditioner works in heat pump mode with an outdoor temperature is as low as -15°C.</p>	<p>Summer House. This innovative function keeps the house at 8/10 or 8/15°C to avoid freezing pipes during the winter. This function is highly appreciated in summer house or week end houses.</p>	<p>R410A/R22 renewal. The Panasonic renewal system allows good quality existing R410A or R22 pipe work to be re-used whilst installing new high efficiency R32 systems.</p>	<p>R22 renewal. The Panasonic renewal system allows good quality existing R22 pipe work to be re-used whilst installing new high efficiency R410A systems.</p>	<p>5 Years compressor warranty. We guarantee the outdoor unit compressors in the entire range for five years.</p>

High connectivity

 <p>INTEGRATION TO P-LINK</p>	<p>Domestic integration to P-Link - CZ-CAPRA1. Can connect all ranges to P-Link. Full control is now possible.</p>	 <p>OPTIONAL WLAN</p>	<p>Internet Control. A next generation system providing a user-friendly remote controller of air conditioning or heat pump units from everywhere, using a simple Android or iOS smartphone, tablet or PC via internet.</p>	 <p>BMS CONNECTIVITY</p>	<p>BMS connectivity. The communication port can be integrated into the indoor unit and provides easy connection to, and control of, your Panasonic heat pump to your home or building management system.</p>
--	---	--	---	---	---

R32 REFRIGERANT GAS



A 'small' change that changes everything

Not everyone is ready for change. Indeed, there are some who resist the future.

But at Panasonic we will keep believing in technologies that improve people's lives.

Which is why we are now presenting a generation of air conditioners with R32, an innovative refrigerant in all ways imaginable: it is easy to install, and compared to most other refrigerants it has a much lower environmental impact and saves energy.

The result? Greater wellbeing for people and for the planet. Because there will always be people who resist change. But we say: Goodbye yesterday. Hello R32.

Today Panasonic. Tomorrow everyone.

European regulation EU 517/2014 makes the replacement of fluorinated gases (F-gases) compulsory, such as R410A, for environmental reasons,

although it also grants a transition period from 2017 to 2030.

Must we wait? No. Our commitment to innovation is not hampered by dates.

Which is why we are jumping the gun and are now presenting our generation of air conditioners that employ the R32 refrigerant.

HCFC phase-down schedule.

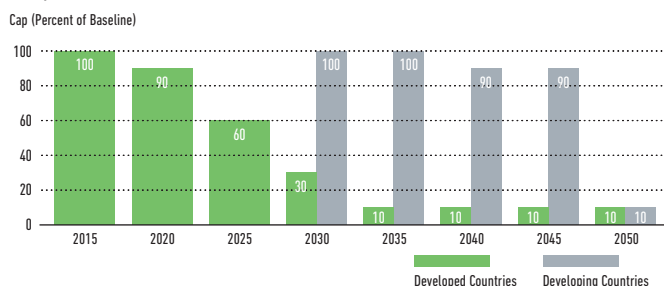

* By replacing R22 with R32 we are significantly reducing the ozone depletion potential of our air conditioners. The use of air conditioning is rapidly increasing in developing countries thus making it increasingly necessary to use refrigerants with low global warming potential.

Goodbye yesterday

The generation of air conditioners with R32 represents innovation in every way.

Shall we list them?

1. Installation innovation.

- Extremely easy to install, practically the same as R410A. (Just remember to verify that the pressure gauge and vacuum pump are compatible with the R32)
- This refrigerant is 100% pure, which makes it easier to recycle and reuse

2. Environmental innovation.

- Zero impact on the ozone layer
- 75% less impact on global warming vs R410A

	R410A	R32
Composition	Blend of 50% R32 + 50% R125	100% R32. (No blend)
GWP (Global Warming Potential)	2087,5	675
ODP (Ozone Depletion Potential)	0	0

R32 is a refrigerant with just one-third the global warming potential of R410A, meaning less risk of damage to the environment.

3. Economic and energy consumption innovation.

- Lower cost and greater savings:
 - 30% less refrigerant
- Higher energy efficiency than R410A

LCCP: Life Cycle Climate Performance (lower global warming impact). Safety: Low toxicity level.

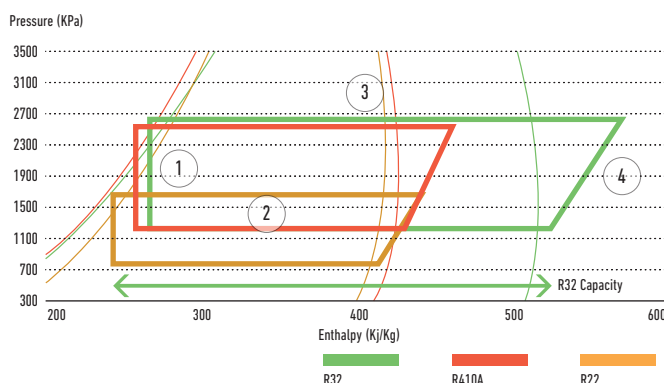

1. Expansion. 2. Evaporation. 3. Condensation. 4. Compression.

100 Year global warming potential of different refrigerants.

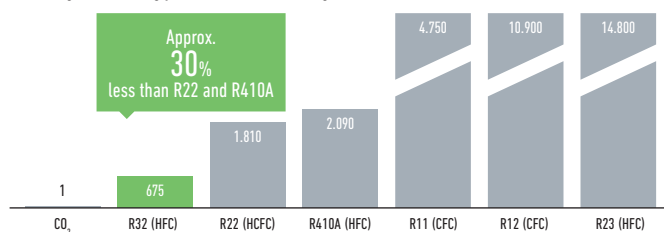

IPCC Fourth Assessment Report. Values for 100 years warming potential.

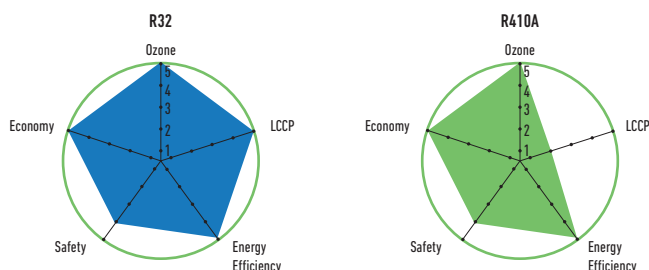

ETHEREA STYLISH AND OUTSTANDING FEATURES



Etherea with nanoe™ X air-purifying system: outstanding efficiency A+++, comfort (Super Quiet technology only 19dB(A)) and healthy air combined with a breakthrough design.

—ETHEREA—

1 Built-in WLAN

Ready to connect the unit to internet to be controlled by smartphone with Panasonic Comfort Cloud App. Control, monitor, easy schedule with easy interface.

2 Even cleaner air with nanoe™ X

New nanoe™ X is an outstanding air purifying bringing much higher performance for better indoor air quality.

3 Simple but elegant design

To suit European interior, we design the indoor to be simple and clean. Elegant finishing with white matt or silver color.

4 New infrared control

Enjoy innovative design at your fingertips with the new stylish and sleek Backlit Sky Controller. Bigger screen and easier to use.

Etherea. Perfect outside, perfect inside

The Etherea has an astonishingly slim design.

A breakthrough design that combines perfectly with the most modern environments. We have selected the best materials and processes for a refined design. And now they're available in an elegant metallic or matt silver and matt or gloss white.

Get the best for your health with Etherea and nanoe™ X.

Using nanoe™ X with nano-technology, nano-sized electrostatic atomised water particles purify the air in the room. It works effectively on airborne and adhesive micro-organisms such as certain types of bacteria, viruses and mould thus ensuring a cleaner living environment.

Etherea performance: highest energy class

Economical, environment-friendly operation high SCOP (Seasonal Coefficiency of Performance).

Original Panasonic Inverter technology and a high performance compressor provide top-class operating efficiency. This lets you enjoy lower electricity bills while contributing to environmental protection.

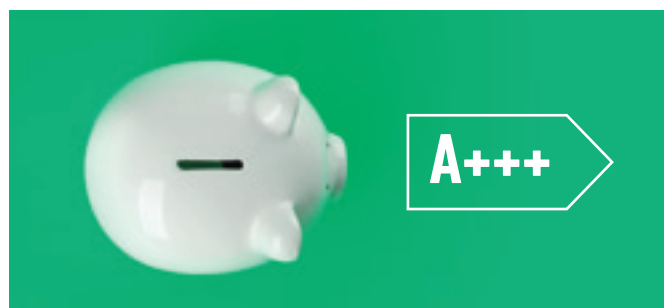

Enjoy innovative design at your fingertips with the new stylish and sleek Backlit Sky Controller.

With fast access to key operations and a smooth gliding cover revealing more options, controlling your settings has become simple and intuitive. With a width of 58,9mm and a length of 164,7mm, the Sky Controller fits comfortably into your hand.

Backlit led screen

The Sky Controller reveals its settings in a better light thanks to the new backlit screen. Now you can adjust your settings without having to switch on the lights.

Distinctive sliding cover

A smooth sliding cover does not only enhance the remote's clean lines, but keeps the buttons free from dirt and smudges.

Precise temperature control

With the Sky Controller's 0,5°C temperature control, enjoy more precise temperature regulation and experience greater comfort.



HEATCHARGE. ENERGY CHARGE SYSTEM



Energy class A+++ and offers maximum comfort and energy savings. This powerful air heat pump is designed for commercial and residential climate that places extremely high demands on the heating system.

Heating power and efficiency

- Energy Charge System. Heat storage unit which features Non-Stop heating and fast heating function
- Higher efficiency and comfort with Econavi sunlight detection and human activity detection
- nanoe™ X air purifying system
- More powerful airflow to quickly reach the desired temperature

Panasonic's full line-up of A+++ heat pumps.

In response to the Kyoto Protocol, the European Union set some challenging targets for the reduction in greenhouse-gas emissions. By the year 2020, across the member states, the EU wants to have achieved the following objectives:

- A 20% cut in greenhouse gas emissions (from 1990 base levels)
- The share of renewables in the energy mix to increase by 20%
- An overall reduction of 20% in energy consumption

Powerful, reliable heating even at low ambient winter temperatures

When the air conditioner is operating, the compressor, which is the power source of the unit, generates heat. Until now, this heat was released into the atmosphere. Panasonic focused on this waste heat! Heatcharge is a unique, innovative Panasonic technology that stores this waste heat in the compressor and effectively uses it as heating energy. This lets you enjoy a new level of air conditioner heating power and efficiency.

Constant heating.

Using stored heat provides stable heating with less drop in temperature. Even when heating operation stops during defrost operation, stored heat continues to constantly warm the room. This eliminates the previous discomfort due to the temperature dropping when heating temporarily stops to ensure stable air conditioner heating.

Conventional. The room gradually becomes cold.

Defrost operation: About 11 to 15 min. Fall in room temperature: About 5 to 6 °C

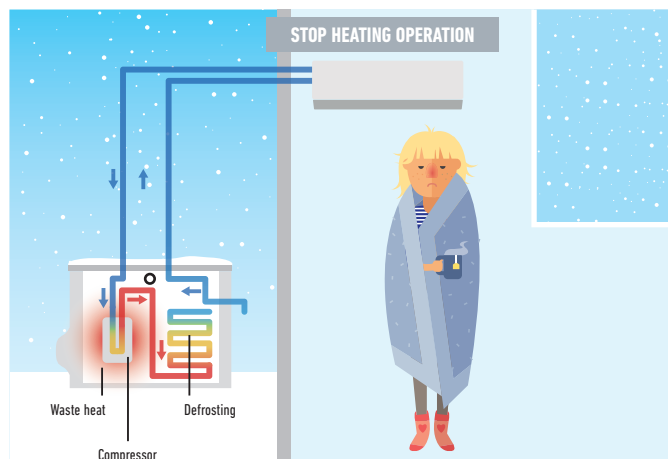

Heatcharge. The room is thoroughly warmed.

Defrost operation: About 5 to 6 min. Fall in room temperature: About 1 to 2 °C

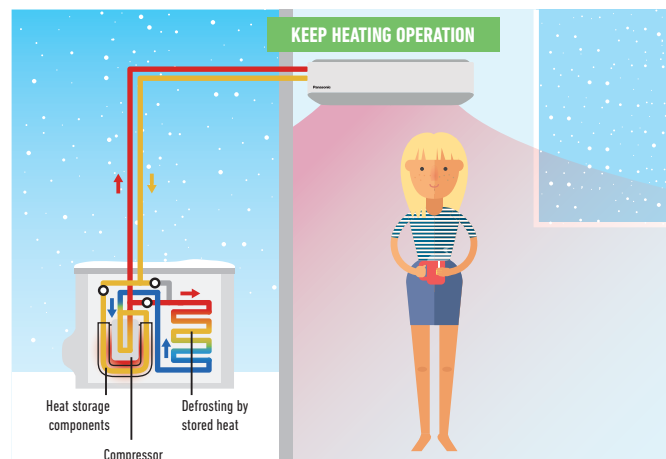

* Defrost operation time and how low room temperature falls differ depending on the environment in which the unit is being used (how insulated and airtight and room is), operation conditions, and temperature conditions.

* Output air temperature falls during defrost operation. How low room temperature falls differs depending on the environment in which the unit is being used (how insulated and airtight and room is), operation conditions, and temperature conditions.

* In environments where a lot of frost accumulates, heating may stop during defrost operation.

Conventional.
During operation, heat is generated inside the compressor.

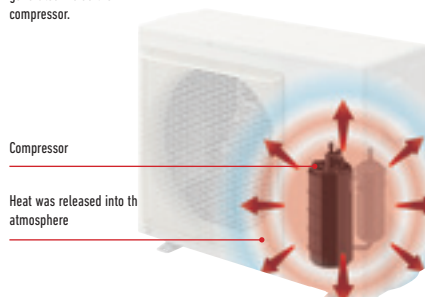

Heatcharge.
Heat generated by the compressor is stored inside and used to warm the refrigerant to efficiently increase heating power.

Waste heat is "charged" and used effectively



Heatcharge.
The compressor is wrapped and exhaust heat is used for charging.

Heatcharge tank
Waste heat from the compressor is stored.

Finless heat exchanger
Stored heat is converted to energy.

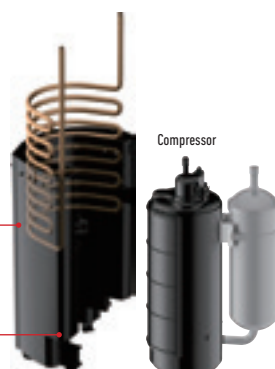

WALL MOUNTED TZ COMPACT STYLE



TZ compact indoor size.

The TZ indoor units have compact size. With 799mm of width, you can put the air conditioner on the top of the door.

TZ Inverter models powerful and efficient

Heating power and efficiency.

- R32 gas is more environmentally friendly than R410A
- Complete line-up of standard Inverter models
- Super Quiet! Only 20dB(A)
- High energy savings
- Long connection distance (from 15m up to 30m)
- Wired Controller (optional)



Catch hazardous pollutants and pollen

PM2,5 Filter

PM2,5 Filter. Particulate matter (PM2,5) can be found suspended in the air, including dust, dirt, smoke and liquid droplets. This filter can catch PM2,5 particles including hazardous pollutants as well as house dust and pollen. It is able maintain clean the air of the room by deodorization too.

Aerowings

Panasonic's Aerowings feature incorporates two independent blades that concentrate airflow to cool you down in the shortest time possible. This also helps distribute cool air evenly throughout the room.

Superior airflow control. Indirect airflow after reaching set temperature.

Aerowings features two independent blades that give you more control over the direction of the airflow.

Without Aerowings, with direct airflow, the target never changes, so you can easily begin to feel too cold as you are subjected to the continuous icy blast.

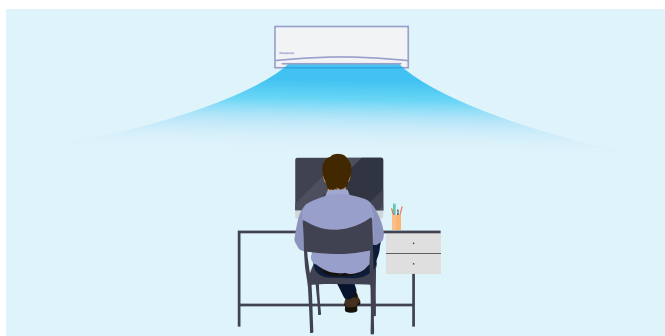

Comfort that goes on and on with Shower Cooling.

After reaching a set temperature, the Aerowings twin blades direct air towards the ceiling to create the Shower Cooling effect. Then, the Human Activity Sensor detects the level of activity and adjusts the temperature to keep you comfortable.

Panasonic Air Conditioners with Aerowings feature an indoor design with wider intake grille and super-high fan speed to produce bigger air volume.

For Shower Cooling.

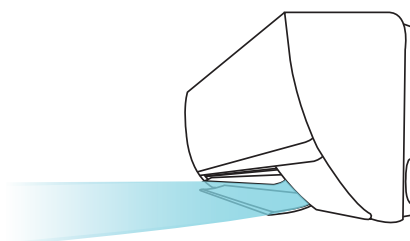

This ensures cool air is evenly distributed throughout the room and you can stay comfortable without experiencing continuous direct cooling.

FLOOR CONSOLE. EFFICIENT COMFORT AND CLEAN AIR ALL YEAR ROUND



The iF Product Design Awards are among the most prestigious awards for product design excellence. Winning the award thanks to its highly intelligent functionality, the Panasonic Floor Console is the ideal air-conditioning system for domestic and commercial applications.

Floor Console with new nanoe™ X air-purifying system: outstanding efficiency A++, comfort (Super Quiet technology only 20dB(A)) and healthy air combined with a breakthrough design.

1 Designed to follow the high European demands
Superquiet operation, high efficiency and purifying the air.

2 Superquiet operation
When the system reaches its set temperature, the unit will operate at only 20dB(A). Because creating a comfortable home is not only by temperature, but also a quiet atmosphere matters

Easy to integrate into your home

A breakthrough design that combines perfectly with any style. We have carefully selected materials and processes to create an elegant design. Compact in size and with a stylish design, the new Floor Console will easily integrate into your home's interior decoration. There are four options available:

3 Ready to meet future demands
Fully developed to work with R32 refrigerant. R32 gas is more environmentally friendly than R410A.

4 New infrared control
Enjoy innovative design at your fingertips with the new stylish and sleek Backlit Sky Controller. Bigger screen and easier to use.

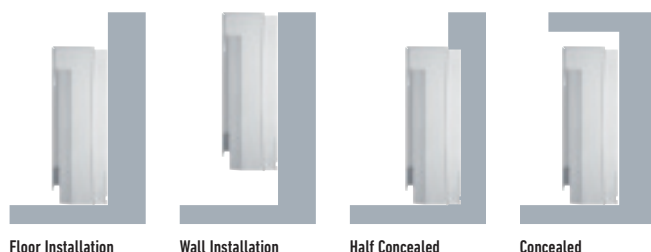

The perfect solution for the replacement of old boiler heating systems



Double airflow for improved comfort and temperature dispersion: through the top for an efficient operation.

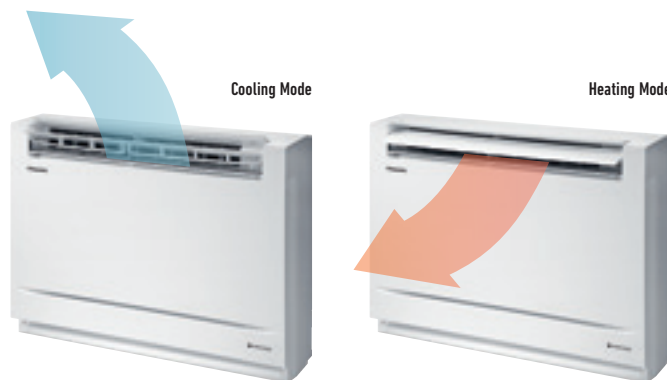

High Energy efficiency class A++

Heat pump brings the outdoor heat energy inside. The new floor console can provide heat inside even when it is -15°C outside.

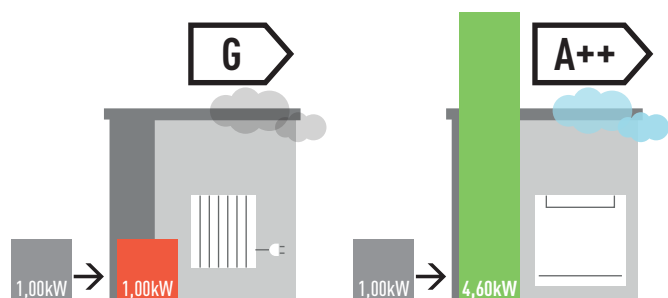

* SCOP on heating mode for Floor Console Type KIT-Z25-UFE and KIT-Z35-UFE compared with electrical heaters at +7°C.

New design and new infrared control



NANOE™ X. QUALITY AIR FOR LIFE



1 Deodorises
 nanoe™ X deodorises strong and unpleasant odours that cause uneasiness so you can enjoy a more pleasant living space for greater well-being.

2 Inhibits certain Bacteria & Viruses
 nanoe™ X inhibits the growth of certain allergens, bacteria and viruses in your home, maintaining a cleaner home for your children.

3 Moisturing Skin
 Helps retain the moisture of the skin.

nanoe™ X deodorises and inhibits certain bacteria and viruses

nanoe™ X contains 10X times¹ more OH radicals.

The newly developed nanoe™ X device produces 10x times more OH radicals (4800 billion)¹ than regular nanoe™ device. Greater amounts of OH radicals contained in nanoe™ X lead to outstanding effects in bacteria, viruses and allergens inhibition as well as deodorisation. A fresher and cleaner home awaits you.

1) Based on Panasonic Survey.

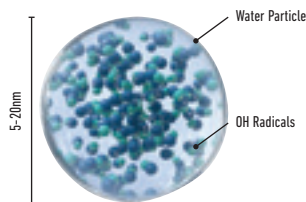

**4800 BILLION
 OH RADICALS /
 PER SECOND**

How nanoe™ X keeps air fresh and clean

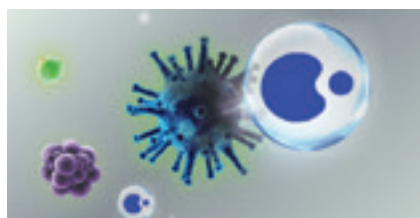

nanoe™ X reaches bacteria.

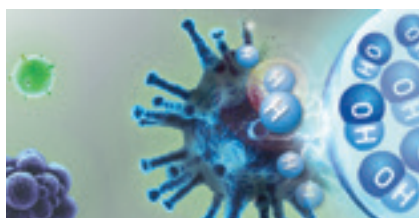

OH radicals take away hydrogen from bacteria.

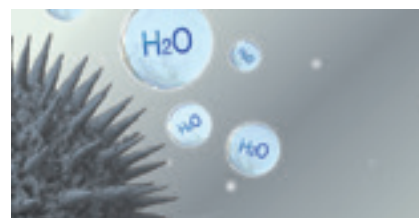

OH radicals transform hydrogen in bacteria to water and inhibit bacterial activity.

No matter where you are on planet earth, air is an essential part in your life. We're working to help every person enjoy better health and comfort by nanoe™ Xair purifier technologies.



Characteristics of nanoe™ X Technology

1. Long Life. 6 times longer lifespan than general negative ion. nanoe™ X contains moisture around 1000 times more than general negative ion. Being contained in water particles, it has a longer lifespan and is able to spread for a long distance.

Comparison of distribution in the room



nanoe™ X.
nanoe™ X spreads to every corner.

General negative ion.
Ions decay before spreading throughout the room.

2. Water-originated. nanoe™ X comes from condensed moisture in the air so that water replenishment for nanoe™ X generation is not required.

nanoe™ X is tiny enough to penetrate into clothes for inhibiting mould and deodorizing.

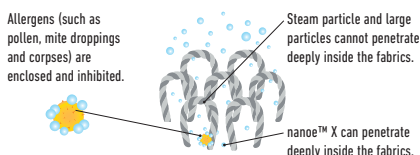

3. Microscopic Scale. With the size of one-billionth of a meter, nanoe™ X is much smaller than steam. It can deeply penetrate into cloth fabrics to deodorize.

* 1nm (nanometer) = one billionth of meter.

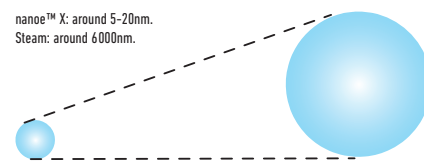

How does nanoe™ X technology help you?

1. Virus / Bacteria / Pollen inhibition. Inhibits certain virus. Influenza virus 99,9% inhibited.

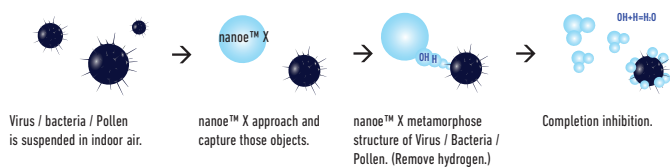

The effectiveness of nanoe™ X.

Tested contents	Result (deactivate)	Testing condition		Tested laboratory / company	Report doc No.
		Size	Time		
Airborne	Virus (Coliphage)	99%	10m ² / 6h	Kitasato research center for Environmental science	KRCES 24_0300_1
	Bacteria (Staphylococcus aureus)	99%	10m ³ / 4h	Kitasato research center for Environmental science	KRCES 21_0142
Adhesive	Virus (Coliphage)	99%	10m ² / 8h	Japan food research laboratories	13001265005-01
	Virus (Influenza)	99,9%	1m ³ / 2h	Kitasato research center for Environmental science	KRCES 21_0084_1
	Bacteria (Staphylococcus aureus)	99%	10m ² / 8h	Japan food research laboratories	13044083003-01
	Tobacco odour	Deodorized in 2h	10m ² / 2h	Panasonic analysis center	BAA33-130125-D01
Cedar pollen	99%	45L / 2h	Panasonic analysis center	ED2-080303IN-03	

2. Deodorization. Deodorization effect works with the smell adhered at objects like sofa and curtains. Reduce 90% Odour (tobacco smell) after 120 minutes.

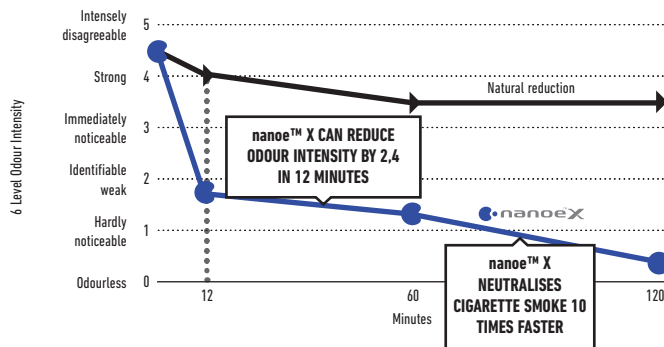

Deodorization effect for adhering odour (tobacco).

Odour is reduced by 2.4 in only 12 minutes, and almost disappear after 2 hours. The deodorization effect will vary subject to the surrounding environment (temperature / humidity), operation time, types of smell and clothes.

- Test Laboratory: Panasonic Corporation Analysis Center. - Test Methodology: Verifying with 6-level odour intensity indication in 10m² test room. - Deodorization Method: nanoe™ X emit. - Test Subject: Adhering Tobacco Smell. - Test Result: 1.2 level of odour intensity is decreased after 120 minutes. - Report No.: 4AA33-160615-N04.

3. Moisturing Skin. Helps retain the moisture of the skin.

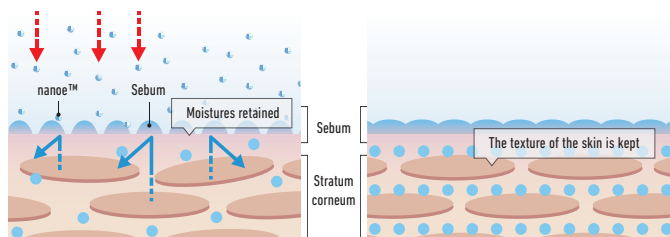

With nanoe™ X.
nanoe™ X hydrate the sebum on the skin to prevent the loss of moistures.

After 28 days
Skin is hydrated that nanoe™ X keeps the texture of the skin.

Test Laboratory: FCG Research Institute Inc. Report no. 19104.

Reliable technology chosen by the world.

The cutting edge technology of Panasonic's nanoe™ purifying technology has been chosen by Lexus to equip its vehicles for clean indoor air.



PANASONIC R2 ROTARY COMPRESSOR



R2 rotary compressors utilize rolling piston technology.

The R2 compressor has been tested in extreme conditions: higher efficiency, single and dual piston, R32 / R410A refrigerant, compact size.

Making the world a cooler place since 1978

Panasonic Rotary Compressors for Room Air Conditioners have been installed in the most demanding environments around the world. Designed to withstand extreme conditions, Panasonic Rotary delivers high performance, efficiency and reliable service, no matter where you are. Panasonic, the world's largest manufacturer of rotary compressors.

R2 Compressor Value

About R2 Compressor.

Built upon 36 years of compressor design and production experience, R2 is the next generation of Rotary Compressors for residential central air conditioning. The technology improvements, enhanced materials and simple design ensure R2 compressors are reliable, efficient and quiet. The R2 Compressor delivers quality, comfort and peace of mind in homes around the world.

Panasonic's Rotary Compressors have been life tested in some of the world's most demanding environments. Proven for years many of the most demanding areas of the world, the R2 design is the compressor of choice by contractors and homeowners in these challenging climates. For the high performance that homeowners demand, R2 Rotary Compressors are considered by the industry experts.

Why is the Panasonic R2 Rotary Compressor so efficient?

1. High efficiency motor. The premium silicon steel motor meets industry efficiency requirements.
2. Improved lubrication of high volume oil pump. The extended, high volume oil pump in conjunction with a larger capacity oil reservoir provides superior lubrication.
3. Accumulator has larger refrigerant capacity. The larger accumulator accommodates generous refrigerant amounts needed in longer line length installations.

Leading Technology.

Used in over 80% of cooling solutions globally, rotary is the world's dominant residential air conditioning compression technology. Panasonic is the leading rotary and residential AC compressor manufacturer in the world, with over 200 million compressors produced.

Benefits.

Central air conditioning delivered with a Panasonic R2 Rotary Compressor ensures a superior level of comfort at an economical cost.

The secret is flexibility. Panasonic Inverter air conditioners have the flexibility to vary the rotation speed of the compressor. This allows it to use less energy to maintain the set temperature while also being able to cool the room quicker at start up. So you can enjoy better savings on your electricity bills while maintaining cooling comfort.

Inverter technology

Great energy-saving performance. Reduces electricity consumption.

Panasonic Inverter air conditioners are designed to give you exceptional energy savings and performance. At the start up of an air conditioner's operation, a boost in power is required to reach the set temperature. After the set temperature is reached, less power is required to maintain it. The Panasonic Inverter air conditioner varies the rotation speed of the compressor. This provides a highly precise method of maintaining the set temperature.

Constant Comfort.

Precise temperature control with a wide power output range enables an inverter air conditioner to meet different room occupancy levels – thus ensuring constant comfort.

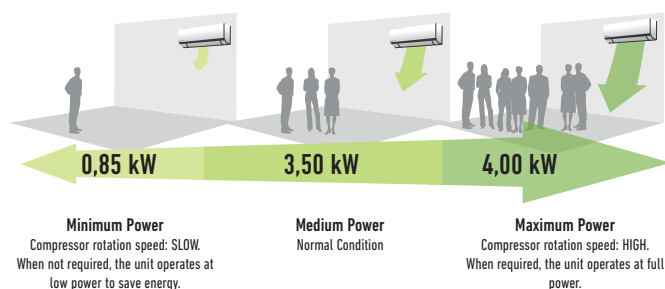

Graph shows the 1,5HP Inverter model's wide power output range during cooling./ Graph shows the 1,5HP Inverter model's wide power output range during cooling.

Quick Comfort.

Panasonic Inverter air conditioners can operate with higher power during the start up period to cool the room 1,5 times faster and heat the room 4 times faster than non-Inverter models.

Comparison of Cooling Speed

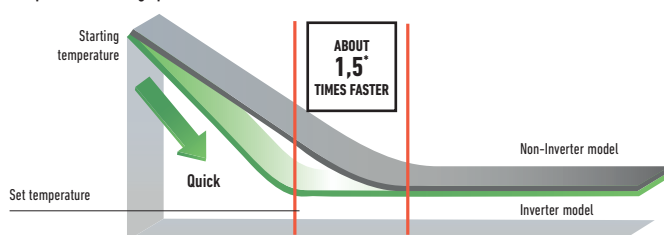

* 1,5HP Inverter vs. non-Inverter. Outside room temperature: 35° C; setting temperature: 25° C

Comparison of Heating Speed

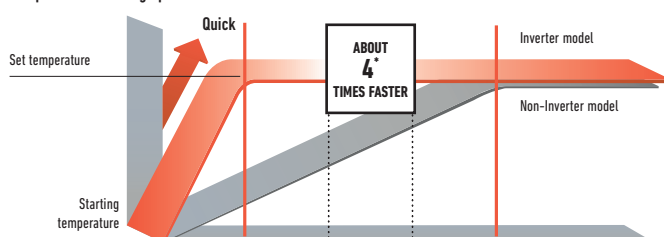

* Comparison of 1,0HP Inverter and Non-Inverter. Outside room temperature: 2° C; Setting temperature: 25° C

Silent ambient and relaxing atmosphere 18 dB(A)

We have succeeded in making one of the most silent air conditioners on the market. Panasonic Inverter air conditioner's indoor operating noise has been reduced as the Inverter constantly varies its output power to enable more precise temperature control.

Quiet Mode reduces operation noise to a quiet 18dB(A)* for a comfortable night's sleep.

Noise is 5dB(A) quieter than during regular operation.

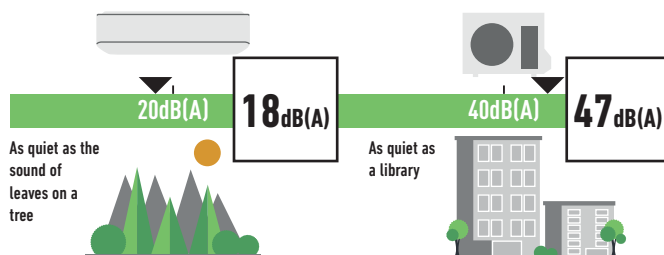

Heatcharge: In the Quiet Mode during cooling operation with low fan speed.

Mild Dry Cooling

Mild dry cooling maintains a higher level of relative humidity of up to 10% compared to regular cooling operation. This helps to reduce skin dryness - and a dry throat.

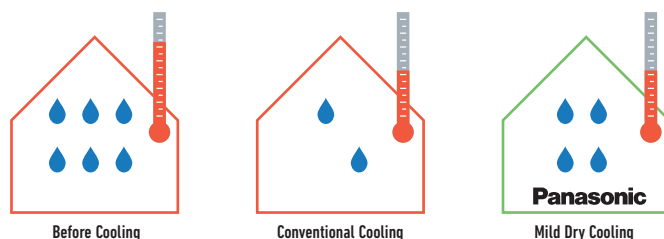

Lower room temperature while maintaining high humidity.

R22 RENEWAL. PANASONIC STANDARD UNITS CAN BE INSTALLED ON EXISTING R22 PIPINGS

CHANGE YOUR OLD AIR CONDITIONING SYSTEM TO A MORE EFFICIENT SYSTEM!



An important drive to further reduce the potential damage to our ozone

- All Panasonic standard SKE, TKE and UKE units can be install on existing R22 pipings
- No need of additional accessories (only pipe reduces)
- Approximately 30% energy saving compared to R22 units

Panasonic is doing its part

We at Panasonic are also doing our part – recognising that all finances are under pressure at the moment. Panasonic has developed a clean and cost effective solution to enable this latest legislation to be introduced with as minimum an effect on businesses and cash reserves as possible.

The Panasonic renewal system allows good quality existing R22 pipe work to be re-used whilst installing new high efficiency R410A / R32 systems.

By bringing a simple solution to the problem Panasonic can renew all Split Systems and PACi systems; and depending upon certain restrictions we don't even limit the manufacturer's equipment we are replacing.

By installing a new high efficiency Panasonic R410A / R32 system you can benefit from around 30% running cost saving compared to the R22 system.

Yes...

1. Check the capacity of the system you wish to replace
 2. Select from the Panasonic range the best system to replace it with
 3. Follow the procedure detailed in the brochure and technical data
- Simple...

R22 - The reduction of Chlorine critical for a cleaner future.



Guidance on re-using of existing R22 piping for a new R410A / R32 installation

1. Precaution.

The existing R22 piping can be re-used for a R410A / R32 system installation if the following conditions are met and the piping are finally verified to be:

- Dry (no moisture remained in the piping)
- Clean (no dust remained in the piping)
- Tight (no refrigerant leak at the joining and piping)

2. Conditions.

- Recover the refrigerant and oil.
- Operate "force cooling" according to the recommended operation time, regardless of the piping length.
 - Single split: 10min.
 - Multi Split: 30min.
- After that, carry out "pump down" to recover the refrigerant and oil from the existing R22 system

* Note: If pump down operation is not possible due to the malfunction of the system, flush and wash the existing piping to collect back the oil and dirt inside the system.

- Check the oil condition.
 - If the oil contains dirt, wash the existing pipes
- Check the oil colour.
 - After pump down, use a cotton bud to wipe the oil from the existing pipe.
 - If the oil colour is higher than ASTM3, use a new pipe as re-use of old piping is not allowed
- Check pipe thickness.
 - Make sure that the pipe thickness is more than 0,8mm.
 - If the thickness is less than 0,8mm, use a new pipe
- Rework the flare for R410A / R32 connection.
 - Do not reuse the old flare nuts.

Deterioration Criteria for Refrigerant Oil

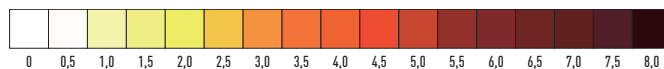

Make sure to use the new flare nuts attached to the R410A / R32 system

* Note: If the existing piping size is 1/4" (6,35mm) and 1/2" (12,7mm), and the new R410A / R32 system is 1/4" (6,35mm) and 3/8" (9,52mm), use a pipe reducer connected at indoor and outdoor unit.

3. Applicable Model.

Panasonic single split room air conditioner from CS/CU-RE/UE/YE/XE/CE/NE/E*NKE and PKE series onwards.

Panasonic multi split room air conditioner from CU-2E/3E/4E/5PBE series onwards.

		Liquid			
		Gas	3/8 (9,52)	1/2 (12,70) 5/8 (15,88)	
Split	16 / 20 / 25 / 35	1,6 - 3,50kW	✓	▲	✗
	42 / 50 / 60	4,2 - 6,00kW	✗	✓	▲
	71	6,8 - 7,50kW	✗	✗	✓

✓ Standard piping connection with current piping length and refrigerant charge rules.

▲ This combinations is allowed respecting maximum piping length and refrigerant charged declared in model installed as new.

✗ This combinations is not allowed as it is out of piping diameter.

NEW PANASONIC COMFORT CLOUD

More than a control in your phone.

NEW BOUNDARIES IN CONTROL

ENERGY MONITOR AND STATISTICS

SCALABILITY AND USERS MANAGEMENT



Advanced smartphone control for domestic range.

Control air to air heat pump operation with Panasonic Comfort Cloud plus additional functions only available thru the Cloud from wherever and whenever. One user can manage up to 200 units and also set up different user and rights. Also energy monitor is possible giving the chance to learn how to reduce even more the operating cost.



New possibilities, new applications

- 1. Families:** Different users can be set up, such as each child can manage their own room only. In the case of second houses, this can be remotely pre-cooled or pre-warmed. Or just turned OFF remotely if someone forget and left the system on.
- 2. Multi tenant owner:** Can manage different sites, up to 200 units with just one smartphone. Knowing the consumption of each place and remotely have error codes remotely for better and quick maintenance.
- 3. Small and medium sized offices:** Owner can control different rooms of the office easily and give unit by unit access to their staff. Also providing information to know where energy might be wasted for heating and cooling and promoting best comfort practices.

1 New boundaries in control

With Panasonic Comfort Cloud the user can manage all functions of the heat pump plus even more. All functions that your heat pump can include like nanoe™ X air purifier, air Flow direction, speed, temperature setting, mode... all these can be simply managed through Panasonic Comfort Cloud. Also some other additional functions can be easily managed through the App including:

- All ON/OFF at once. For sites with more than one unit in one site, user can turn them all ON or OFF with just one click
- Set weekly timer. Set up to 6 events per day, 42 in a week, easy, intuitive and fast
- Pre-heat or cool. Control your house or office comfort - before you arrive!
- Error code notification. If trouble occurs, error notification or maintenance code is shown



2 Energy monitor and statistics

Knowing the energy each unit uses when operating is key to see opportunities to reduce the energy bill. Panasonic Comfort Cloud stores the energy consumption* of each unit, which can then be shown in easy and powerful statistics graphs. This function is available from VKE, TKE and UKE generation.

With the weekly timer the operation can be adjusted to optimize the usage of the energy.

*Estimated energy consumption data accuracy is depending on power supply quality.



3 Scalability and users management

Easily to include additional units and locations as well as including several users with different access rights. This creates more possibilities to manage family house, a second house and also provides opportunities for small/medium sized offices or multi-tenant properties.

- Up to 200 units. Up to 10 Locations (20 units per site)
- User's control rights. Main user can set up other users with limited rights on units and set up



Compatibility: Most Panasonic Domestic range are compatible with CZ-TACG1 WLAN accessory: CS-VZ**SKE, CS-XZ**VKEW, CS-Z**VKEW, CS-FZ**TKEW, CS-RZ**VKEW, CS-FZ**UKE, CS-UZ**VKE, CS-PZ**VKE, CS-DZ**VKE, CS-Z**TKEA, CS-Z**UFEAW, CS-Z**UB4EAW, CS-Z**UD3EAW, CS-XE**SKEW, CS-E**SKEM-M, CS-TE**TKEW, CS-FE**UKE, CS-BE**TKE, CS-DE**TKE, CS-E**PKEA, CS-E**PB4EA, CS-E**PD3EA. VKE generation will be also compatible. For built-in WLAN such as CS-Z**VKEW, CS-MZ16VKE and CS-XZ**VKEW it is not required the accessory CZ-TACG1.

Remark: indoor temperature display and some special functions are not available through the App for all models. Languages: Available in 19 European languages: Bulgarian, Croatian, Czech, Danish, Deutsch, English, Estonian, Finnish, French, Greek, Hungarian, Italian, Norwegian, Polish, Portuguese, Slovenian, Spanish, Swedish and Turkish.

Panasonic Comfort Cloud for internet control – CZ-TACG1

Indoor Unit



Network Adaptor (CZ-TACG1)

Other hardware requirements (purchase and subscribe separately)



Download free App



Panasonic Comfort Cloud

Input Voltage	DC 12V
Power Consumption	Max. 660mW
Size (H x W x D)	66 x 36 x 12mm
Mass	Approx. 85g
Interface	1 x Wireless LAN
Wireless LAN Standard	IEEE 802.11 b/g/n
Frequency Range	2,4GHz band
Encryption	WPA2-PSK (TKIP/AES)

CONTROL AND CONNECTIVITY

Panasonic offers its customers cutting-edge technology, specially designed to ensure our air conditioning systems deliver even higher performance. You can properly manage the air conditioning and perform comprehensive monitoring and control, with all of the features the remote controller provides at home, from anywhere in the world thanks to the internet applications Panasonic has created for you.

Domestic integration to P-Link - CZ-CAPRA1

Can connect all ranges to P-Link. Full control is now possible.

Integrates any unit in big system control.

- TKEA / PKEA server room integration
- Small offices with domestic indoors
- Tender for refurbishment (old system Domestic and VRF in one installation)

Centralized Control Systems: 64 Indoor Units 	Intelligent Controller / Web Server: 256 Indoor Units 	P-AIMS: 1024 Indoor Units 
--	---	---

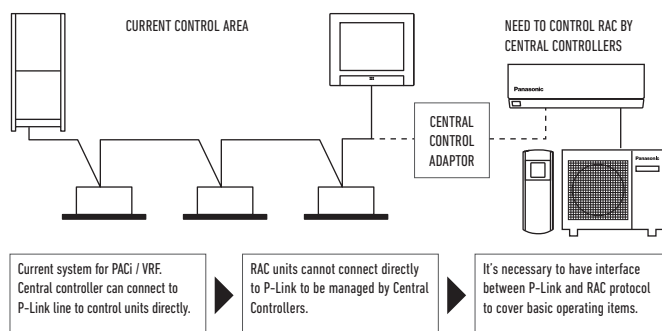

Basic operation items: ON/OFF, Mode select, Temperature setting, Fan speed, Flap setting, Remote control prohibit.

External input: ON/OFF control signal, Abnormal stop signal.

External output for Relay¹: Operation status (ON/OFF), Alarm status output.

¹) Because current CN-CNT connector can not provide the power for external output relay, additional Input power for external relay is necessary.

Connectivity. Control by BMS

Great flexibility for integration into your KNX, EnOcean, Modbus and BACnet projects allows fully bi-directional monitoring and control of all the functioning parameters.

Reference	KNX [®] PAW-AC-KNX-1i	Modbus [®] PAW-AC-MBS-1	enocean [®] PAW-AC-ENO-1i	BACnet [™] PAW-AC-BAC-1 ¹
Quick installation and possibility of hidden installation	✓	✓	✓	✓
External power not required	✓	✓	✓	✓
Direct connection to the AC indoor unit	✓ (Split or Multi Split)	✓ (Split or Multi Split)	✓ (Split)	✓
Control and monitoring of the internal variables of the indoor unit and error codes and indication	✓ Fully compatible	✓ Fully compatible	✓ Fully compatible	
Use the AC ambient temperature or the one measured by external sensor	✓	✓	✓	
AC unit can be controlled simultaneously by the remote controller of the AC unit and interface devices	✓	✓	✓	
Advanced control functions	✓	✓	✓	
4 binary inputs. They work as standard interface binary inputs as well as being used to control the AC directly	✓	✓	✓	
Total Control and Supervision. Real states of the AC unit's internal variables				✓

¹) This interface allows a complete and natural integration of Panasonic air conditioners into either BACnet IP or MS/TP networks. Is a BTL certified device.

PAW-AC-DIO

Dry contact ON/OFF Interface. Panasonic has developed for hotels applications a dry contact PCB which works with Etherea, RE, UE and YE indoor units in order to control simply the unit centrally.

- ON/OFF signal by 3rd party BMS
- PCB connected to CN-RMT port on indoor unit PCB















Easy connectivity

CN-CNT easy to access. Previous Etherea indoor unit had to be dismantle to reach connector. Can easier connect: Wireless accessory / KNX / Modbus / CZ-CAPRA1 to integrate to PACi control.







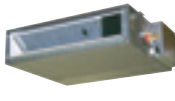
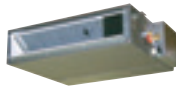



Model name	Interface
CZ-TACG1	Panasonic Comfort Cloud for internet control
CZ-CAPRA1	RAC interface adapter for integration into P-Link
PAW-IR-WIFI-1	Interface by Infra red sensor, only ON/OFF and temperature setting
PAW-AC-ENO-1i	This interface can be used with all models which have a CN-CNT connector
PAW-AC-KNX-1i	This interface can be used with all models which have a CN-CNT connector
PAW-AC-MBS-1	This interface can be used with all models which have a CN-CNT connector
PAW-AC-BAC-1	This interface can be used with all models which have a CN-CNT connector
PAW-AC-HEAT-1	Heating only PCB for Etherea, 4-Way 60x60 Cassette and Low static pressure hide away
PAW-AC-DIO	This interface can be used with all models which have a CN-RMT connector
PAW-SMSCONTROL	Control of the Etherea, Flagship and Heatcharge by SMS (need additional SIM card)

DOMESTIC AIR CONDITIONER RANGE R32

Page	Indoor units	1,60kW	2,00kW	2,50kW
P. 102	Wall Mounted Heatcharge VZ Inverter+ • R32 Gas			 CS-VZ9SKE
P. 103	NEW Wall Mounted Etherea Inverter+ Silver • R32 Gas		 CS-XZ20VKEW	 CS-XZ25VKEW
P. 103	NEW Wall Mounted Etherea Inverter+ Pure White Matt • R32 Gas ¹	 CS-MZ16VKE ²	 CS-Z20VKEW	 CS-Z25VKEW
P. 104	Wall Mounted TZ Compact Style • R32 Gas ¹	 CS-MTZ16TKE ²	 CS-TZ20TKEW-1	 CS-TZ25TKEW-1
P. 105	Wall Mounted FZ Type Standard Inverter • R32 Gas			 CS-FZ25UKE
P. 106	Wall Mounted Professional Inverter -20°C • R32 Gas			 CS-Z25TKEA
P. 107	Floor Console Type Inverter+ • R32 Gas ¹		 CS-MZ20UFEA ²	 CS-Z25UFEAW
P. 108	4 Way 60x60 Cassette Standard Inverter • R32 Gas ¹		 CS-MZ20UB4EA ²	 CS-Z25UB4EAW
P. 109	Low Static Pressure Hide Away Standard Inverter • R32 Gas ¹		 CS-MZ20UD3EA ²	 CS-Z25UD3EAW

1) Indoor units available for Free Multi Z and E combinations. 2) Indoor units only available only for Free Multi Z and E combinations.

Page	Free Multi Outdoors	3,20 ~ 6,00kW	3,20 ~ 6,00kW	3,20 ~ 7,70kW	4,50 ~ 9,50kW	4,50 ~ 11,20kW	4,50 ~ 11,50kW	4,50 ~ 14,70kW	4,50 ~ 18,30kW
P. 110	Outdoor unit Free Multi System Z • R32 Gas								
		CU-2Z35TBE	CU-2Z41TBE	CU-2Z50TBE	CU-3Z52TBE	CU-3Z68TBE	CU-4Z68TBE	CU-4Z80TBE	CU-5Z90TBE

3,50kW

4,20kW

5,00kW

6,00kW

7,10kW



CS-VZ12SKE



CS-XZ35VKEW



CS-XZ50VKEW



CS-Z35VKEW



CS-Z42VKEW



CS-Z50VKEW



CS-Z71VKEW



CS-TZ35TKEW-1



CS-TZ42TKEW-1



CS-TZ50TKEW



CS-TZ60TKEW



CS-TZ71TKEW



CS-FZ35UKE



CS-FZ50UKE



CS-FZ60UKE



CS-Z35TKEA



CS-Z42TKEA

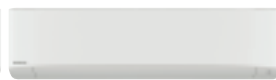

CS-Z50TKEA

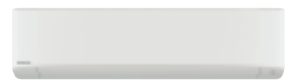

CS-Z71TKEA



CS-Z35UFEAW



CS-Z50UFEAW



CS-Z35UB4EAW



CS-Z50UB4EAW



CS-Z60UB4EAW



CS-Z35UD3EAW



CS-Z50UD3EAW



CS-Z60UD3EAW

Wall Mounted Heatcharge VZ Inverter+

• R32 GAS

heatcharge



The Heatcharge from Panasonic has the capacity to store heat on the outdoor unit which allows heating to start quickly just after turning on the heat pump

It also ensures maximum comfort and heat in the house even during defrost operation as Heat charge also stores heat to prevent cool air during defrost.

Technical focus

- R32 gas is more environmentally friendly than R410A
- Performance tested at -35°C Outdoor temperature
- Energy Charge System. Heat storage unit which realizes NON-STOP heating and fast heating function
- Econavi Sunlight Detection sensor: Even higher efficiency and great comfort
- nanoe™ air purifying system, 99% effective to certain airborne and adhesives mould, viruses, bacteria and pollen allergen
- Super Quiet! Only 18dB(A), equivalent to night-time in the country
- More powerful airflow to quickly reach the desired temperature

Kit			KIT-VZ9-SKE	KIT-VZ12-SKE
Cooling capacity	Nominal (Min-Max)	kW	2,50 (0,60 - 3,00)	3,50 (0,60 - 4,00)
SEER¹⁾			10,50 A+++	10,00 A+++
Pdesign (cooling)		kW	2,50	3,50
Input power cooling	Nominal (Min-Max)	kW	0,43 (0,14 - 0,61)	0,80 (0,14 - 0,98)
Annual energy consumption ³⁾		kWh/a	83	122
Heating capacity	Nominal (Min-Max)	kW	3,60 (0,60 - 7,80)	4,20 (0,60 - 9,20)
COP ²⁾		W/W	5,63	5,04
Heating capacity at -7°C		kW	5,00	5,60
COP at -7°C ²⁾		W/W	2,07	2,00
SCOP¹⁾			6,20 A+++	5,90 A+++
Pdesign at -10°C		kW	3,60	4,20
Input power heating	Nominal (Min-Max)	kW	0,64 (0,14 - 2,72)	0,83 (0,14 - 3,16)
Annual energy consumption ³⁾		kWh/a	812	995
Indoor unit			CS-VZ9SKE	CS-VZ12SKE
Power source		V	230	230
Recommended fuse		A	16	16
Connection indoor / outdoor		mm ²	4 x 1,5	4 x 1,5
Air volume	Cool / Heat (Hi)	m ³ /min	12,5 / 15,5	12,9 / 15,9
Sound pressure ⁴⁾	Cool (Hi / Lo / Q-Lo)	dB(A)	44 / 27 / 18	45 / 33 / 18
	Heat (Hi / Lo / Q-Lo)	dB(A)	44 / 26 / 18	45 / 29 / 18
Dimension	HxWxD	mm	295 x 798 x 375	295 x 798 x 375
Net weight		kg	14,5	14,5
Outdoor unit			CU-VZ9SKE	CU-VZ12SKE
Air volume	Cool / Heat (Hi)	m ³ /min	33,1 / 33,1	35,4 / 33,9
Sound pressure ⁴⁾	Cool / Heat (Hi)	dB(A)	49 / 49	50 / 50
Dimension ⁵⁾	HxWxD	mm	630 x 799 x 299	630 x 799 x 299
Net weight		kg	39,5	39,5
Piping connections	Liquid pipe	Inch (mm)	1/4 (6,35)	1/4 (6,35)
	Gas pipe	Inch (mm)	3/8 (9,52)	3/8 (9,52)
Pipe length range		m	3 - 15	3 - 15
Elevation difference (in/out) ⁶⁾		m	12	12
Pipe length for additional gas		m	7,5	7,5
Additional gas amount		g/m	20	20
Refrigerant (R32) / CO ₂ Eq.		kg / T	1,05 / 0,70875	1,10 / 0,7425
Operating range	Cool Min ~ Max	°C	-10 ~ +43	-10 ~ +43
	Heat Min ~ Max	°C	-30 ~ +24	-30 ~ +24
Lowest outdoor temperature tested by 3rd party laboratory ⁷⁾		°C	-35	-35

Accessories

CZ-TACG1	Panasonic Comfort Cloud for internet control
CZ-CAPRA1	RAC interface adapter for integration into P-Link

Accessories

PAW-SMSCONTROL	Control by SMS (need additional SIM card)
-----------------------	---

1) Energy Label Scale from A+++ to D. 2) EER and COP calculation is based in accordance to EN14511. 3) The annual energy consumption is calculated in accordance to EU/626/2011. 4) The sound pressure of the indoor unit shows the value measured of a position 1m in front of the main body and 0,8m below the unit. For outdoor unit 1m in front and 1m in rear side of main body. The sound pressure is measured in accordance with JIS C 9612. Q-Lo: Quiet mode. Lo: The lowest set fan speed. 5) Add 70mm for piping port. 6) When installing the outdoor unit at a higher position than the indoor unit. 7) Tested by 3rd party laboratory. SP, according to EN14511:2013 and SP Method 1721, this temperature is not guaranteed by Factory.



SEER and SCOP: For KIT-VZ9-SKE. -35°C HEATING MODE: Heating performance tested at -35°C by SP, European third party laboratory. INTERNET CONTROL: Optional.

New Wall Mounted Etherea Inverter+ Silver / Pure White Matt • R32 GAS

ETHEREA



Etherea with nanoe™ X air-purifying system

The nanoe™ X revolutionary air-purifying system utilises nano technology fine particles to remove and deactivate 99% of certain airborne and adhesive micro-organisms like bacteria, viruses and mould.

Technical focus

- **NEW!** Built-in WLAN Panasonic Comfort Cloud for internet control
- R32 gas is more environmentally friendly than R410A
- nanoe™ X air purifying system, 99% effective to certain airborne and adhesives mould, viruses, bacteria and pollen allergen
- Aerowings to control air draft direction
- Mild Dry Cooling: prevent a rapid decrease in room humidity
- Super Quiet! Only 19dB(A), equivalent to night-time in the countryside
- More powerful airflow to quickly reach the desired temperature
- Wired control (Optional)

Kit Silver			KIT-XZ20-VKE	KIT-XZ25-VKE	KIT-XZ35-VKE	—	KIT-XZ50-VKE	—
Kit Pure White Matt			KIT-Z20-VKE	KIT-Z25-VKE	KIT-Z35-VKE	KIT-Z42-VKE	KIT-Z50-VKE	KIT-Z71-VKE
Cooling capacity	Nominal (Min - Max)	kW	2,05 (0,75 - 2,40)	2,50 (0,85 - 3,20)	3,50 (0,85 - 4,00)	4,20 (0,85 - 5,00)	5,00 (0,98 - 6,00)	7,10 (0,98 - 8,50)
EER ¹⁾	Nominal (Min - Max)	W/W	4,56 (3,13 - 4,32)	4,81 (3,54 - 4,05)	4,07 (3,54 - 3,70)	3,39 (3,27 - 3,18)	3,55 (3,50 - 3,08)	3,27 (2,33 - 2,93)
SEER ²⁾			7,50 A+++	8,50 A+++	8,50 A+++	6,90 A+++	7,90 A+++	6,50 A+++
Pdesign (cooling)		kW	2,10	2,50	3,50	4,20	5,00	7,10
Input power cooling	Nominal (Min - Max)	kW	0,45 (0,24 - 0,56)	0,52 (0,24 - 0,79)	0,86 (0,24 - 1,08)	1,24 (0,26 - 1,57)	1,41 (0,28 - 1,95)	2,17 (0,42 - 2,90)
Annual energy consumption ³⁾		kWh/a	98	103	144	213	222	382
Heating capacity	Nominal (Min - Max)	kW	2,80 (0,70 - 4,00)	3,40 (0,80 - 5,00)	4,00 (0,80 - 5,50)	5,30 (0,80 - 6,80)	5,80 (0,98 - 8,00)	8,60 (0,98 - 10,20)
Heating capacity at -7°C		kW	2,38	2,95	3,20	4,11	4,80	6,31
COP ¹⁾	Nominal (Min - Max)	W/W	4,52 (3,89 - 4,04)	4,79 (4,44 - 3,97)	4,35 (4,44 - 3,72)	3,68 (4,21 - 3,51)	4,03 (2,88 - 3,16)	3,66 (2,45 - 3,46)
SCOP ²⁾			4,70 A+++	5,10 A+++	5,10 A+++	4,00 A++	4,70 A+++	4,20 A++
Pdesign at -10°C		kW	2,10	2,70	2,80	3,60	4,20	5,50
Input power heating	Nominal (Min - Max)	kW	0,62 (0,18 - 0,99)	0,71 (0,18 - 1,26)	0,92 (0,18 - 1,48)	1,44 (0,19 - 1,94)	1,44 (0,34 - 2,53)	2,35 (0,40 - 2,95)
Annual energy consumption ³⁾		kWh/a	626	741	769	1260	1251	1833
Indoor unit Silver			CS-XZ20VKEW	CS-XZ25VKEW	CS-XZ35VKEW	—	CS-XZ50VKEW	—
Indoor unit Pure White Matt			CS-Z20VKEW	CS-Z25VKEW	CS-Z35VKEW	CS-Z42VKEW	CS-Z50VKEW	CS-Z71VKEW
Power source		V	230	230	230	230	230	230
Recommended fuse		A	16	16	16	16	16	20
Connection indoor / outdoor		mm ²	4 x 1,5	4 x 1,5	4 x 1,5	4 x 1,5	4 x 2,5	4 x 2,5
Air volume	Cool / Heat	m ³ /min	9,9 / 10,7	10,2 / 11,2	11,0 / 12,0	11,2 / 12,0	19,1 / 20,5	19,8 / 21,5
Moisture removal volume		L/h	1,3	1,5	2,0	2,4	2,8	4,1
Sound pressure ⁴⁾	Cool (Hi / Lo / Q-Lo)	dB(A)	37 / 24 / 19	39 / 25 / 19	42 / 28 / 19	43 / 31 / 25	44 / 37 / 30	47 / 38 / 30
	Heat (Hi / Lo / Q-Lo)	dB(A)	38 / 25 / 19	41 / 27 / 19	43 / 33 / 19	43 / 35 / 29	44 / 37 / 30	47 / 38 / 30
Dimension	H x W x D	mm	295 x 919 x 194	295 x 919 x 194	295 x 919 x 194	295 x 919 x 194	302 x 1120 x 236	302 x 1120 x 236
Net weight		kg	9	10	10	10	12	13
Outdoor unit			CU-Z20VKE	CU-Z25VKE	CU-Z35VKE	CU-Z42VKE	CU-Z50VKE	CU-Z71VKE
Air volume	Cool / Heat	m ³ /min	26,9 / 24,1	28,7 / 27,2	30,6 / 30,6	31,3 / 30,9	39,8 / 36,9	44,7 / 45,8
Sound pressure ⁴⁾	Cool / Heat (Hi)	dB(A)	45 / 46	46 / 47	48 / 50	49 / 51	47 / 47	52 / 54
Dimension ⁵⁾	H x W x D	mm	542 x 780 x 289	542 x 780 x 289	542 x 780 x 289	619 x 824 x 299	695 x 875 x 320	695 x 875 x 320
Net weight		kg	27	31	31	31	42	50
Piping connections	Liquid pipe	Inch (mm)	1/4 (6,35)	1/4 (6,35)	1/4 (6,35)	1/4 (6,35)	1/4 (6,35)	1/4 (6,35)
	Gas pipe	Inch (mm)	3/8 (9,52)	3/8 (9,52)	3/8 (9,52)	1/2 (12,70)	1/2 (12,70)	5/8 (15,88)
Pipe length range		m	3 ~ 15	3 ~ 15	3 ~ 15	3 ~ 15	3 ~ 30	3 ~ 30
Elevation difference (in/out) ⁶⁾		m	15	15	15	15	15	20
Pipe length for additional gas		m	7,5	7,5	7,5	7,5	7,5	10
Additional gas amount		g/m	10	10	10	10	15	25
Refrigerant (R32) / CO ₂ Eq.		kg / T	0,70 / 0,473	0,85 / 0,574	0,85 / 0,574	0,89 / 0,601	1,15 / 0,776	1,37 / 0,925
Operating range	Cool Min ~ Max	°C	-10 ~ +43	-10 ~ +43	-10 ~ +43	-10 ~ +43	-10 ~ +43	-10 ~ +43
	Heat Min ~ Max	°C	-15 ~ +24	-15 ~ +24	-15 ~ +24	-15 ~ +24	-15 ~ +24	-15 ~ +24

Accessories

CZ-CAPRA1 RAC interface adapter for integration into P-Link

Accessories

CZ-RD514C Wired remote controller for Wall Mounted and Floor Console

1) EER and COP calculation is based in accordance to EN14511. 2) Energy Label Scale from A+++ to D. 3) The annual energy consumption is calculated in accordance to EU/626/2011. 4) The sound pressure of the indoor unit shows the value measured of a position 1m in front of the main body and 0,8m below the unit. For outdoor unit 1m in front and 1m in rear side of main body. The sound pressure is measured in accordance with JIS C 9612. 0-Lo: Quiet mode. Lo: The lowest set fan speed. 5) Add 70mm for piping port. 6) When installing the outdoor unit at a higher position than the indoor unit.



SEER and SCOP: For KIT-XZ25-VKE, KIT-XZ35-VKE, KIT-Z25-VKE and KIT-Z35-VKE. SUPER QUIET: For KIT-XZ20-VKE, KIT-XZ25-VKE, KIT-XZ35-VKE, KIT-Z20-VKE, KIT-Z25-VKE and KIT-Z35-VKE. INTERNET CONTROL: Built-in WLAN.

Wall Mounted TZ Compact Style Inverter

• R32 GAS



TZ compact indoor size

The TZ indoor units have compact size. With 799mm of width, you can put the air conditioner on the top of the door.

Technical focus

- Compact design with 799mm
- R32 gas is more environmentally friendly than R410A
- Aerowings to control air draft direction
- PM2,5 Filter to create clean and comfort indoor quality
- Complete line-up of standard Inverter models
- Super Quiet! Only 20dB(A)
- High energy savings
- This units can be installed on R410A and R22 pipings
- Long connection distance (from 15m up to 30m)
- Wired control (Optional)
- Smartphone control (Optional)

Kit			KIT-TZ20-TKE-1	KIT-TZ25-TKE-1	KIT-TZ35-TKE-1	KIT-TZ42-TKE-1	KIT-TZ50-TKE	KIT-TZ60-TKE	KIT-TZ71-TKE
Cooling capacity	Nominal (Min-Max)	kW	2,00 (0,75 - 2,40)	2,50 (0,85 - 3,00)	3,50 (0,85 - 3,90)	4,20 (0,85 - 4,60)	5,00 (0,98 - 5,60)	6,30 (0,98 - 7,10)	7,10 (0,98 - 8,10)
EER ¹⁾	Nominal (Min-Max)	W/W	4,08 (3,00 - 4,00)	3,85 (3,40 - 3,41)	3,57 (3,33 - 3,36)	3,36 (3,21 - 2,80)	3,40 (3,44 - 3,24)	3,26 (3,50 - 2,98)	3,17 (2,33 - 3,03)
SEER ²⁾			6,80 ◀A++	6,90 ◀A++	6,70 ◀A++	6,30 ◀A++	6,80 ◀A++	6,50 ◀A++	6,10 ◀A++
Pdesign (cooling)		kW	2,00	2,50	3,50	4,20	5,00	6,30	7,10
Input power cooling	Nominal (Min-Max)	kW	0,49 (0,25 - 0,60)	0,65 (0,25 - 0,88)	0,98 (0,26 - 1,16)	1,25 (0,27 - 1,64)	1,47 (0,29 - 1,73)	1,93 (0,28 - 2,38)	2,24 (0,42 - 2,67)
Annual energy consumption ³⁾		kWh/a	103	127	183	233	257	339	407
Heating capacity	Nominal (Min-Max)	kW	2,70 (0,70 - 3,60)	3,30 (0,80 - 4,10)	4,00 (0,80 - 5,10)	5,00 (0,80 - 6,80)	5,80 (0,98 - 7,80)	7,20 (0,98 - 8,50)	8,60 (0,98 - 9,90)
Heating capacity at -7°C		kW	2,14	2,70	3,30	3,90	4,79	5,24	6,13
COP ¹⁾	Nominal (Min-Max)	W/W	4,15 (3,78 - 3,53)	4,18 (4,10 - 3,66)	4,04 (4,00 - 3,70)	3,73 (4,00 - 3,33)	3,77 (2,88 - 3,39)	3,44 (2,88 - 3,15)	3,51 (2,45 - 3,47)
SCOP ²⁾			4,60 ◀A++	4,60 ◀A++	4,60 ◀A++	4,00 ◀A+	4,30 ◀A+	4,20 ◀A+	4,00 ◀A+
Pdesign at -10°C		kW	1,90	2,40	2,80	3,60	4,00	4,60	5,50
Input power heating	Nominal (Min-Max)	kW	0,65 (0,19 - 1,02)	0,79 (0,20 - 1,12)	0,99 (0,20 - 1,38)	1,34 (0,20 - 2,04)	1,54 (0,34 - 2,30)	2,09 (0,34 - 2,70)	2,45 (0,40 - 2,85)
Annual energy consumption ³⁾		kWh/a	578	730	852	1260	1302	1533	1925
Indoor unit			CS-TZ20TKEW-1	CS-TZ25TKEW-1	CS-TZ35TKEW-1	CS-TZ42TKEW-1	CS-TZ50TKEW	CS-TZ60TKEW	CS-TZ71TKEW
Air volume	Cool / Heat	m ³ /min	9,6 / 10,6	10,5 / 11,4	11,3 / 12,1	12,3 / 12,9	19,9 / 20,8	20,8 / 21,4	20,0 / 22,0
Moisture removal volume		L/h	1,3	1,5	2,0	2,4	2,8	3,5	4,1
Sound pressure ⁴⁾	Cool (Hi / Lo / Q-Lo)	dB(A)	37 / 25 / 20	40 / 26 / 20	42 / 30 / 20	44 / 31 / 29	44 / 37 / 34	45 / 37 / 34	47 / 38 / 35
	Heat (Hi / Lo / Q-Lo)	dB(A)	38 / 26 / 22	40 / 27 / 22	42 / 33 / 22	44 / 35 / 28	44 / 37 / 34	45 / 37 / 34	47 / 38 / 35
Dimension	HxWxD	mm	290x799x197	290x799x197	290x799x197	290x799x197	302x1102x244	302x1102x244	302x1102x244
Net weight		kg	8	8	8	8	12	12	13
Outdoor unit			CU-TZ20TKE-1	CU-TZ25TKE-1	CU-TZ35TKE-1	CU-TZ42TKE-1	CU-TZ50TKE	CU-TZ60TKE	CU-TZ71TKE
Power source		V	230	230	230	230	230	230	230
Recommended fuse		A	16	16	16	16	16	20	20
Connection indoor / outdoor		mm ²	4x1,5	4x1,5	4x1,5	4x1,5	4x2,5	4x2,5	4x2,5
Air volume	Cool / Heat	m ³ /min	28,9 / 27,4	29,0 / 27,6	29,1 / 30,2	33,6 / 34,0	33,0 / 32,2	42,6 / 41,5	44,7 / 48,1
Sound pressure ⁴⁾	Cool / Heat (Hi)	dB(A)	46 / 47	47 / 48	48 / 50	49 / 51	48 / 49	49 / 49	52 / 54
	HxWxD	mm	542x780x289	542x780x289	542x780x289	619x824x299	619x824x299	695x875x320	695x875x320
Net weight		kg	27	28	33	34	40	42	49
Piping connections	Liquid pipe	Inch (mm)	1/4 (6,35)	1/4 (6,35)	1/4 (6,35)	1/4 (6,35)	1/4 (6,35)	1/4 (6,35)	1/4 (6,35)
	Gas pipe	Inch (mm)	3/8 (9,52)	3/8 (9,52)	3/8 (9,52)	1/2 (12,70)	1/2 (12,70)	1/2 (12,70)	5/8 (15,88)
Pipe length range		m	3~15	3~15	3~15	3~15	3~20	3~30	3~30
Elevation difference (in/out) ⁶⁾		m	15	15	15	15	15	15	20
Pipe length for additional gas		m	7,5	7,5	7,5	7,5	7,5	7,5	10
Additional gas amount		g/m	10	10	10	10	15	15	25
Refrigerant (R32) / CO ₂ Eq.		kg / T	0,61 / 0,412	0,70 / 0,473	0,82 / 0,554	0,87 / 0,587	1,14 / 0,770	1,11 / 0,749	1,32 / 0,891
Operating range	Cool Min ~ Max	°C	-10 ~ +43	-10 ~ +43	-10 ~ +43	-10 ~ +43	-10 ~ +43	-10 ~ +43	-10 ~ +43
	Heat Min ~ Max	°C	-15 ~ +24	-15 ~ +24	-15 ~ +24	-15 ~ +24	-15 ~ +24	-15 ~ +24	-15 ~ +24

Accessories

CZ-TACG1	Panasonic Comfort Cloud for internet control
CZ-CAPRA1	RAC interface adapter for integration into P-Link

Accessories

CZ-RD514C	Wired remote controller for Wall Mounted and Floor Console
------------------	--

1) EER and COP calculation is based in accordance to EN14511. 2) Energy Label Scale from A+++ to D. 3) The annual energy consumption is calculated in accordance to EU/626/2011. 4) The sound pressure of the indoor unit shows the value measured of a position 1m in front of the main body and 0.8m below the unit. For outdoor unit 1m in front and 1m in rear side of main body. The sound pressure is measured in accordance with JIS C 9612. Q-Lo: Quiet mode. Lo: The lowest set fan speed. 5) Add 70mm for piping port. 6) When installing the outdoor unit at a higher position than the indoor unit.



SEER and SCOP: For KIT-TZ25-TKE-1. SUPER QUIET: For KIT-TZ20-TKE-1, KIT-TZ25-TKE-1 and KIT-TZ35-TKE-1. INTERNET CONTROL: Optional.

Wall Mounted FZ Type Standard Inverter

• R32 GAS



FZ series inverter powerful and efficient

Technical focus

- R32 gas is more environmentally friendly than R410A
- PM2,5 Filter to create clean and comfort indoor quality
- Super Quiet! Only 20dB(A)
- High energy savings
- Cooling even at -10°C
- These units can be installed on R22 pipings
- Long connection distance
- Wired control (Optional)
- Smartphone control (Optional)

Kit			KIT-FZ25-UKE	KIT-FZ35-UKE	KIT-FZ50-UKE	KIT-FZ60-UKE
Cooling capacity	Nominal (Min-Max)	kW	2,50 (0,85 - 3,00)	3,40 (0,85 - 3,90)	5,00 (0,98 - 5,40)	6,25 (0,98 - 7,10)
EER ¹⁾	Nominal (Min-Max)	W/W	3,68 (3,40 - 3,33)	3,18 (3,33 - 3,05)	3,03 (3,44 - 2,90)	3,24 (3,50 - 2,96)
SEER ²⁾			6,20 ◀A++	6,10 ◀A++	6,50 ◀A++	6,20 ◀A++
Pdesign (cooling)		kW	2,50	3,40	5,00	6,30
Input power cooling	Nominal (Min-Max)	kW	0,68 (0,25 - 0,90)	1,07 (0,26 - 1,28)	1,65 (0,29 - 1,86)	1,93 (0,28 - 2,40)
Annual energy consumption ³⁾		kWh/a	141	195	269	356
Heating capacity	Nominal (Min-Max)	kW	3,15 (0,80 - 3,60)	3,84 (0,80 - 4,40)	5,40 (0,98 - 7,50)	6,80 (0,98 - 8,50)
Heating capacity at -7°C		kW	2,14	2,60	4,58	5,24
COP ¹⁾	Nominal (Min-Max)	W/W	4,04 (4,10 - 3,46)	3,66 (4,10 - 3,41)	3,42 (2,80 - 3,06)	3,51 (2,88 - 3,11)
SCOP ²⁾			4,10 ◀A+	4,10 ◀A+	3,90 ◀A	3,90 ◀A
Pdesign at -10°C		kW	1,90	2,40	4,00	4,60
Input power heating	Nominal (Min-Max)	kW	0,78 (0,20 - 1,04)	1,05 (0,20 - 1,29)	1,58 (0,35 - 2,45)	1,94 (0,34 - 2,73)
Annual energy consumption ³⁾		kWh/a	649	820	1436	1651
Indoor unit			CS-FZ25UKE	CS-FZ35UKE	CS-FZ50UKE	CS-FZ60UKE
Power source		V	230	230	230	230
Recommended fuse		A	16	16	16	—
Connection indoor / outdoor		mm ²	4 x 1,5	4 x 1,5	4 x 2,5	—
Air volume	Cool / Heat	m ³ /min	10,3 / 11,0	10,7 / 11,2	11,6 / 12,5	17,2 / 18,7
Moisture removal volume		L/h	1,5	2,0	2,8	3,5
Sound pressure ⁴⁾	Cool (Hi / Lo / Q-Lo)	dB(A)	37 / 26 / 20	38 / 30 / 20	44 / 37 / 34	45 / 37 / 34
	Heat (Hi / Lo / Q-Lo)	dB(A)	37 / 27 / 24	38 / 33 / 25	44 / 37 / 34	45 / 37 / 34
Dimension	HxWxD	mm	290 x 850 x 199	290 x 850 x 199	290 x 870 x 214	290 x 1070 x 240
Net weight		kg	8	8	9	12
Outdoor unit			CU-FZ25UKE	CU-FZ35UKE	CU-FZ50UKE	CU-FZ60UKE
Air volume	Cool / Heat	m ³ /min	30,5 / 30,5	31,1 / 31,1	32,7 / 32,7	42,6 / 41,5
Sound pressure ⁴⁾	Cool / Heat (Hi)	dB(A)	48 / 49	48 / 50	48 / 49	49 / 49
Dimension ⁵⁾	HxWxD	mm	542 x 780 x 289	542 x 780 x 289	619 x 824 x 299	695 x 875 x 320
Net weight		kg	26	27	38	43
Piping connections	Liquid pipe	Inch (mm)	1/4 (6,35)	1/4 (6,35)	1/4 (6,35)	1/4 (6,35)
	Gas pipe	Inch (mm)	3/8 (9,52)	3/8 (9,52)	1/2 (12,70)	1/2 (12,70)
Pipe length range		m	3 ~ 15	3 ~ 15	3 ~ 15	3 ~ 30
Elevation difference (in/out) ⁶⁾		m	15	15	15	15
Pipe length for additional gas		m	7,5	7,5	7,5	7,5
Additional gas amount		g/m	10	10	15	15
Refrigerant (R32) / CO ₂ Eq.		kg / T	0,58 / 0,392	0,67 / 0,452	1,14 / 0,770	1,15 / 0,776
Operating range	Cool Min ~ Max	°C	-10 ~ +43	-10 ~ +43	-10 ~ +43	-10 ~ +43
	Heat Min ~ Max	°C	-15 ~ +24	-15 ~ +24	-15 ~ +24	-15 ~ +24

Accessories

CZ-TACG1	Panasonic Comfort Cloud for internet control
CZ-CAPRA1	RAC interface adapter for integration into P-Link

Accessories

CZ-RD514C	Wired remote controller for Wall Mounted and Floor Console
------------------	--

1) EER and COP calculation is based in accordance to EN14511. 2) Energy Label Scale from A+++ to D. 3) The annual energy consumption is calculated in accordance to EU/626/2011. 4) The sound pressure of the indoor unit shows the value measured of a position 1m in front of the main body and 0,8m below the unit. For outdoor unit 1m in front and 1m in rear side of main body. The sound pressure is measured in accordance with JIS C 9612. Q-Lo: Quiet mode. Lo: The lowest set fan speed. 5) Add 70mm for piping port. 6) When installing the outdoor unit at a higher position than the indoor unit.



SEER and SCOP: For KIT-FZ50-UKE. SUPER QUIET: For KIT-FZ25-UKE and KIT-FZ35-UKE. INTERNET CONTROL: Optional.

Wall Mounted Professional Inverter -20°C

• R32 GAS



Complete line-up with high efficiency even at -20°C

This Wall Mounted air conditioner is especially designed for professional applications such as computer rooms where cooling inside the room is necessary even when the outside temperature is low. Furthermore this air conditioner has an automatic changeover system, in order to maintain the inside temperature even when sharp outside temperature changes occur.

Technical focus

- R32 gas is more environmentally friendly than R410A
- Aerowings to control air draft direction
- Designed for 24h/7d a week operation
- Up to A+++ in cooling
- Highly efficient even at -20°C
- High durability rolling bearings
- Additional piping sensors to prevent freezing
- Automatic restart

KIT			KIT-Z25-TKEA	KIT-Z35-TKEA	KIT-Z42-TKEA	KIT-Z50-TKEA	KIT-Z71-TKEA
Cooling capacity	Nominal (Min - Max)	kW	2,50 (0,85 - 3,00)	3,50 (0,85 - 4,00)	4,20 (0,98 - 5,00)	5,00 (0,98 - 6,00)	7,10 (0,98 - 8,10)
EER ¹⁾	Nominal (Min - Max)	W/W	4,90 (5,00 - 4,29)	4,07 (5,00 - 3,64)	3,82 (4,90 - 3,25)	3,60 (3,50 - 3,09)	3,17 (2,33 - 3,03)
SEER ²⁾			8,50 A+++	8,50 A+++	8,50 A+++	8,50 A+++	6,10 A++
Pdesign		kW	2,50	3,50	4,20	5,00	7,10
Input power cooling	Nominal (Min - Max)	kW	0,51 (0,17 - 0,70)	0,86 (0,17 - 1,10)	1,10 (0,20 - 1,54)	1,39 (0,28 - 1,94)	2,24 (0,42 - 2,67)
Annual energy consumption ³⁾		kWh/a	103	144	173	206	407
Heating capacity	Nominal (Min - Max)	kW	3,40 (0,85 - 5,40)	4,00 (0,85 - 6,60)	5,40 (0,98 - 7,25)	5,80 (0,98 - 8,00)	8,60 (0,98 - 9,90)
Heating capacity at -7°C		kW	3,33	4,07	4,30	5,00	6,13
COP ¹⁾	Nominal (Min - Max)	W/W	4,86 (5,15 - 4,12)	4,35 (5,15 - 3,63)	4,00 (4,45 - 3,37)	4,03 (2,88 - 3,20)	3,51 (2,45 - 3,47)
SCOP ²⁾			4,50 A+	4,40 A+	4,30 A+	4,40 A+	4,00 A+
Pdesign at -10°C		kW	2,80	3,60	3,80	4,40	5,50
Input power heating	Nominal (Min - Max)	kW	0,70 (0,17 - 1,31)	0,92 (0,17 - 1,82)	1,35 (0,22 - 2,15)	1,44 (0,34 - 2,50)	2,45 (0,40 - 2,85)
Annual energy consumption ³⁾		kWh/a	871	1145	1237	1400	1925
Indoor unit			CS-Z25TKEA	CS-Z35TKEA	CS-Z42TKEA	CS-Z50TKEA	CS-Z71TKEA
Power source		V	230	230	230	230	230
Recommended fuse		A	16	16	16	16	20
Connection indoor / outdoor		mm ²	4 x 1,5	4 x 1,5	4 x 1,5	4 x 2,5	4 x 2,5
Air Volume	Cool / Heat	m ³ /min	10,4 / 11,7	10,7 / 12,4	18,2 / 20,2	19,2 / 21,3	20,2 / 21,0
Moisture removal volume		L/h	1,5	2,0	2,4	2,8	4,1
Sound pressure ⁴⁾	Cool (Hi / Lo / Q-Lo)	dB(A)	39 / 25 / 21	42 / 28 / 21	43 / 32 / 29	44 / 37 / 30	47 / 38 / 35
	Heat (Hi / Lo / Q-Lo)	dB(A)	41 / 27 / 22	43 / 30 / 22	44 / 35 / 29	44 / 37 / 30	47 / 38 / 35
Dimension	HxWxD	mm	295x919x194	295x919x194	302x1120x236	302x1120x236	302x1120x236
Net weight		kg	9	10	12	12	13
Outdoor unit			CU-Z25TKEA	CU-Z35TKEA	CU-Z42TKEA	CU-Z50TKEA	CU-Z71TKEA
Sound pressure ⁴⁾	Cool / Heat (Hi)	dB(A)	46 / 48	48 / 50	48 / 50	48 / 50	52 / 54
Dimension ⁵⁾	HxWxD	mm	619x824x299	619x824x299	619x824x299	695x875x320	695x875x320
Net weight		kg	37	38	38	43	49
Piping connections	Liquid pipe	Inch (mm)	1/4 (6,35)	1/4 (6,35)	1/4 (6,35)	1/4 (6,35)	1/4 (6,35)
	Gas pipe	Inch (mm)	3/8 (9,52)	3/8 (9,52)	1/2 (12,70)	1/2 (12,70)	5/8 (15,88)
Pipe length range		m	3~20	3~20	3~20	3~30	3~30
Elevation difference (in/out) ⁶⁾		m	15	15	15	15	20
Pipe length for additional gas		m	7,5	7,5	7,5	7,5	10
Additional gas amount		g/m	10	10	10	15	25
Refrigerant (R32) / CO ₂ Eq.		kg / T	0,96 / 0,648	1,00 / 0,675	1,08 / 0,729	1,15 / 0,776	1,32 / 0,891
Operating range	Cool Min ~ Max	°C	-20 ~ +43	-20 ~ +43	-20 ~ +43	-20 ~ +43	-20 ~ +43
	Heat Min ~ Max	°C	-15 ~ +24	-15 ~ +24	-15 ~ +24	-15 ~ +24	-15 ~ +24

Accessories

CZ-TACG1	Panasonic Comfort Cloud for internet control
CZ-CAPRA1	RAC interface adapter for integration into P-Link
PAW-WTRAY	Tray for condenser water compatible with base ground support

Accessories

PAW-GRDSTD40	Outdoor elevation platform
PAW-GRDBSE20	Outdoor base ground support for noise and vibration absorption
PAW-SERVER-PKEA	PCB for installation in server rooms with security

1) EER and COP calculation is based in accordance to EN14511. 2) Energy Label Scale from A+++ to D. 3) The annual energy consumption is calculated in accordance to EU/626/2011. 4) The sound pressure of the indoor unit shows the value measured of a position 1m in front of the main body and 0.8m below the unit. For outdoor unit 1m in front and 1m in rear side of main body. The sound pressure is measured in accordance with JIS C 9612. Q-Lo: Quiet mode. Lo: The lowest set fan speed. 5) Add 70mm for piping port. 6) When installing the outdoor unit at a higher position than the indoor unit.



SEER and SCOP: For KIT-Z25-TKEA. SUPER QUIET: For KIT-Z25-TKEA. INTERNET CONTROL: Optional.

Floor Console Type Inverter+ • R32 GAS



New Floor Console with new nanoe™ X air-purifying system: outstanding efficiency A++, comfort (Super Quiet technology only 20dB(A)) and healthy air combined with a breakthrough design

Double airflow for improved comfort and temperature dispersion: through the top for an efficient cooling mode.

Technical focus

- R32 gas is more environmentally friendly than R410A
- A breakthrough design that combines perfectly with the most modern environments. We have selected the best materials and processes for a refined design
- nanoe™ X with nano-technology, nano-sized electrostatic atomised water particles purify the air in the room
- High energy efficiency class A++ SEER and A++ SCOP
- Control your comfort and the power consumption with internet control

Kit			KIT-Z25-UFE	KIT-Z35-UFE	KIT-Z50-UFE
Cooling capacity	Nominal (Min-Max)	kW	2,50 (0,85 - 3,40)	3,50 (0,85 - 3,80)	5,00 (0,90 - 5,70)
EER ¹⁾	Nominal (Min-Max)	W/W	4,81 (3,54 - 3,78)	4,07 (3,54 - 3,73)	3,60 (3,53 - 3,15)
SEER ²⁾			7,90 A++	8,10 A++	6,70 A++
Pdesign (cooling)		kW	2,50	3,50	5,00
Input power cooling	Nominal (Min-Max)	kW	0,52 (0,24 - 0,90)	0,86 (0,24 - 1,02)	1,39 (0,26 - 1,81)
Annual energy consumption ³⁾		kWh/a	111	151	261
Heating capacity	Nominal (Min-Max)	kW	3,40 (0,85 - 5,00)	4,30 (0,85 - 6,00)	5,80 (0,90 - 8,10)
Heating capacity at -7°C		kW	2,88	3,37	5,03
COP ¹⁾	Nominal (Min-Max)	W/W	4,47 (3,54 - 3,70)	3,98 (3,54 - 3,43)	3,74 (3,46 - 3,12)
SCOP ²⁾			4,60 A++	4,60 A++	4,30 A+
Pdesign at -10°C		kW	2,70	3,20	4,40
Input power heating	Nominal (Min-Max)	kW	0,76 (0,24 - 1,35)	1,08 (0,24 - 1,75)	1,55 (0,26 - 2,60)
Annual energy consumption ³⁾		kWh/a	822	974	1433
Indoor unit			CS-Z25UFEAW	CS-Z35UFEAW	CS-Z50UFEAW
Air volume	Cool / Heat	m ³ /min	9,6 / 9,9	9,9 / 10,1	11,6 / 13,2
Moisture removal volume		L/h	1,5	2,0	2,8
Sound pressure ⁴⁾	Cool (Hi / Lo / Q-Lo)	dB(A)	38 / 25 / 20	39 / 26 / 20	44 / 31 / 27
	Heat (Hi / Lo / Q-Lo)	dB(A)	38 / 25 / 19	39 / 26 / 19	46 / 33 / 29
Dimension	HxWxD	mm	600 x 750 x 207	600 x 750 x 207	600 x 750 x 207
Net weight		kg	13	13	13
Outdoor unit			CU-Z25UBEA	CU-Z35UBEA	CU-Z50UBEA
Power source		V	230	230	230
Recommended fuse		A	16	16	16
Connection indoor / outdoor		mm ²	—	—	—
Air volume	Cool / Heat	m ³ /min	28,7 / 27,2	34,3 / 33,5	39,7 / 38,6
Sound pressure ⁴⁾	Cool / Heat (Hi)	dB(A)	46 / 47	48 / 48	48 / 48
Dimension ⁵⁾	HxWxD	mm	542 x 780 x 289	619 x 824 x 299	695 x 875 x 320
Net weight		kg	33	35	43
Piping connections	Liquid pipe	Inch (mm)	1/4 (6,35)	1/4 (6,35)	1/4 (6,35)
	Gas pipe	Inch (mm)	3/8 (9,52)	3/8 (9,52)	1/2 (12,70)
Pipe length range		m	3 ~ 20	3 ~ 20	3 ~ 30
Elevation difference (in/out) ⁶⁾		m	15	15	20
Pipe length for additional gas		m	7,5	7,5	7,5
Additional gas amount		g/m	10	10	15
Refrigerant (R32) / CO ₂ Eq.		kg / T	0,88 / 0,594	0,93 / 0,628	1,13 / 0,763
Operating range	Cool Min ~ Max	°C	-10 ~ +43	-10 ~ +43	-10 ~ +43
	Heat Min ~ Max	°C	-15 ~ +24	-15 ~ +24	-15 ~ +24

Accessories

CZ-TACG1	Panasonic Comfort Cloud for internet control
CZ-CAPRA1	RAC interface adapter for integration into P-Link

Accessories

CZ-RD514C	Wired remote controller for Wall Mounted and Floor Console
------------------	--

1) EER and COP calculation is based in accordance to EN14511. 2) Energy Label Scale from A+++ to D. 3) The annual energy consumption is calculated in accordance to EU/626/2011. 4) The sound pressure of the units shows the value measured of a position 1m in front of the main body and 1m above floor. The sound pressure is measured in accordance with JIS C 9612. Q-Lo: Quiet mode. Lo: The lowest set fan speed. 5) Add 70mm for piping port. 6) When installing the outdoor unit at a higher position than the indoor unit.



SEER and SCOP: For KIT-Z35-UFE. SUPER QUIET: For KIT-Z25-UFE and KIT-Z35-UFE. INTERNET CONTROL: Optional. IF DESIGN AWARD 2019: Floor Console awarded with the prestigious IF Design Award 2019.

4 Way 60x60 Cassette Inverter • R32 GAS



CZ-BT20EW
RAL9010 panel for 4 Way
60x60 Cassette.

Specially designed for offices, retail and restaurant applications, this Cassette fits perfectly into 60x60 or 70x70 ceiling grids

Compact Cassette with high efficiency even at low temperatures, this new Cassette can also be connected to KNX, Modbus, EnOcean interfaces for easy integration with your BMS systems. Interfaces have dry contacts (ON/OFF, error message) to enable easy integration. Fit Panasonic's Cassette Type, and start to save all year round!

Technical focus

- R32 gas is more environmentally friendly than R410A
- Cassettes can be controlled by KNX, EnOcean and Modbus
- Designed for easy installation in the standard European 60x60 ceiling grid
- Piping length up to 30m
- Maximum elevation difference up to 20m
- Ultra compact outdoor units for easy installation
- High pressure selector in case of high ceilings (higher than 2,7m)
- Drain pump included (maximum 750mm high)
- Air fresh entry available on the Cassette

KIT			KIT-Z25-UB4	KIT-Z35-UB4	KIT-Z50-UB4	KIT-Z60-UB4
Cooling capacity	Nominal (Min - Max)	kW	2,50 (0,85 - 3,20)	3,50 (0,85 - 4,00)	5,00 (0,90 - 5,80)	6,00 (0,90 - 6,35)
EER ¹⁾	Nominal (Min - Max)	W/W	4,55 (3,54 - 3,90)	3,89 (3,54 - 3,39)	3,25 (3,53 - 3,09)	2,93 (3,53 - 2,89)
SEER²⁾			6,30 A++	6,50 A++	6,40 A++	6,20 A++
Pdesign (cooling)		kW	2,50	3,50	5,00	6,00
Input power cooling	Nominal (Min - Max)	kW	0,55 (0,24 - 0,82)	0,90 (0,24 - 1,18)	1,54 (0,26 - 1,88)	2,05 (0,26 - 2,20)
Annual energy consumption ³⁾		kWh/a	139	188	273	339
Heating capacity	Nominal (Min - Max)	kW	3,20 (0,85 - 4,80)	4,50 (0,85 - 5,60)	5,60 (0,90 - 7,10)	7,00 (0,90 - 8,00)
Heating capacity at -7°C		kW	2,88	3,37	4,40	5,10
COP ¹⁾	Nominal (Min - Max)	W/W	4,05 (3,70 - 3,64)	3,31 (3,70 - 3,20)	3,03 (3,46 - 2,95)	2,92 (3,46 - 2,91)
SCOP²⁾			4,30 A+	4,20 A+	4,30 A+	4,20 A+
Pdesign at -10°C		kW	2,70	3,00	3,80	4,00
Input power heating	Nominal (Min - Max)	kW	0,79 (0,23 - 1,32)	1,36 (0,23 - 1,75)	1,85 (0,26 - 2,41)	2,40 (0,26 - 2,75)
Annual energy consumption ³⁾		kWh/a	879	1000	1237	1333
Indoor unit			CS-Z25UB4EAW	CS-Z35UB4EAW	CS-Z50UB4EAW	CS-Z60UB4EAW
Panel			CZ-BT20EW	CZ-BT20EW	CZ-BT20EW	CZ-BT20EW
Air volume	Cool / Heat	m ³ /min	10,5 / 10,8	10,5 / 10,8	11,5 / 11,8	12,4 / 13,5
Moisture removal volume		L/h	1,5	2,0	2,8	3,3
Sound pressure ⁴⁾	Cool (Hi / Lo / Q-Lo)	dB(A)	34 / 25 / 22	34 / 26 / 23	37 / 28 / 25	42 / 32 / 29
	Heat (Hi / Lo / Q-Lo)	dB(A)	35 / 28 / 25	35 / 28 / 25	38 / 29 / 26	43 / 32 / 29
Dimension (HxWxD)	Indoor	mm	260x575x575	260x575x575	260x575x575	260x575x575
	Panel	mm	51x700x700	51x700x700	51x700x700	51x700x700
Net weight	Indoor / Panel	kg	18 / 2,5	18 / 2,5	18 / 2,5	18 / 2,5
Outdoor unit			CU-Z25UBEA	CU-Z35UBEA	CU-Z50UBEA	CU-Z60UBEA
Power source		V	230	230	230	230
Recommended fuse		A	—	—	—	—
Connection indoor / outdoor		mm ²	—	—	—	—
Air volume	Cool / Heat	m ³ /min	28,7 / 27,2	34,3 / 33,5	39,7 / 38,6	42,6 / 41,5
Sound pressure ⁴⁾	Cool / Heat (Hi)	dB(A)	46 / 47	48 / 48	48 / 48	49 / 50
Dimension ⁵⁾	HxWxD	mm	542x780x289	619x824x299	695x875x320	695x875x320
Net weight		kg	33	35	43	43
Piping connections	Liquid pipe	Inch (mm)	1/4 (6,35)	1/4 (6,35)	1/4 (6,35)	1/4 (6,35)
	Gas pipe	Inch (mm)	3/8 (9,52)	3/8 (9,52)	1/2 (12,70)	1/2 (12,70)
Pipe length range		m	3 ~ 20	3 ~ 20	3 ~ 30	3 ~ 30
Elevation difference (in/out) ⁶⁾		m	15	15	20	20
Pipe length for additional gas		m	7,5	7,5	7,5	7,5
Additional gas amount		g/m	10	10	15	15
Refrigerant (R32) / CO ₂ Eq.		kg / T	0,88 / 0,594	0,93 / 0,628	1,13 / 0,763	1,13 / 0,763
Operating range	Cool Min ~ Max	°C	-10 ~ +43	-10 ~ +43	-10 ~ +43	-10 ~ +43
	Heat Min ~ Max	°C	-15 ~ +24	-15 ~ +24	-15 ~ +24	-15 ~ +24

Accessories

CZ-TACG1	Panasonic Comfort Cloud for internet control
CZ-CAPRA1	RAC interface adapter for integration into P-Link

Accessories

CZ-RD52CP	Wired remote controller for Cassette
------------------	--------------------------------------

1) EER and COP calculation is based in accordance to EN14511. 2) Energy Label Scale from A+++ to D. 3) The annual energy consumption is calculated in accordance to EU/626/2011. 4) The sound pressure of the indoor unit shows the value measured at a position 1,5m below the unit. For outdoor unit 1m in front and 1m in rear side of main body. The sound pressure is measured in accordance with JIS C 9612. Q-Lo: Quiet mode. Lo: The lowest set fan speed. 5) Add 70mm for piping port. 6) When installing the outdoor unit at a higher position than the indoor unit.



SEER and SCOP: For KIT-Z35-UB4EA. SUPER QUIET: For KIT-Z25-UB4EA. INTERNET CONTROL: Optional.

Low Static Pressure Hide Away Inverter

• R32 GAS

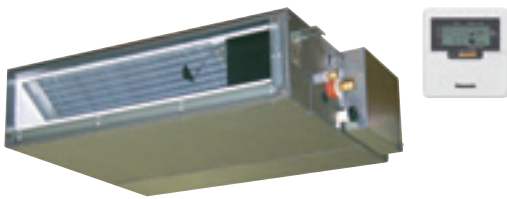

Designed for homes, offices, retail and restaurants, this duct is ideal for small rooms where the air conditioning and the heating should be nicely integrated and where high comfort and efficiency is needed

The duct can also be connected to KNX, Modbus, EnOcean interfaces for easy integration with your BMS systems. This interfaces have dry contacts (ON/OFF, error message) for easy integration.

Technical focus

- R32 gas is more environmentally friendly than R410A
- Duct type can be controlled by KNX, EnOcean and Modbus
- Eco mode for 20% energy saving
- Extremely compact indoor units without losing static pressure (only 200mm high)
- Weekly timer, 42 settings per week
- Easy check mode for failure detection
- Drain pump included

KIT			KIT-Z25-UD3	KIT-Z35-UD3	KIT-Z50-UD3	KIT-Z60-UD3
Cooling capacity	Nominal (Min-Max)	kW	2,50 (0,85 - 3,20)	3,50 (0,85 - 4,00)	5,10 (0,90 - 5,70)	6,00 (0,90 - 6,50)
	Nominal (Min-Max)	W/W	4,31 (3,54 - 3,76)	3,85 (3,54 - 3,36)	3,27 (3,53 - 3,20)	2,94 (3,53 - 2,83)
SEER²⁾			5,90	5,80	5,90	5,60
Pdesign (cooling)		kW	2,50	3,50	5,10	6,00
Input power cooling	Nominal (Min-Max)	kW	0,58 (0,24 - 0,85)	0,91 (0,24 - 1,19)	1,56 (0,26 - 1,78)	2,04 (0,26 - 2,30)
	Annual energy consumption ³⁾	kWh/a	148	211	303	375
Heating capacity	Nominal (Min-Max)	kW	3,20 (0,85 - 4,60)	4,20 (0,85 - 5,10)	6,10 (0,90 - 7,20)	7,00 (0,90 - 8,00)
	Heating capacity at -7°C	kW	2,60	3,00	4,50	5,10
COP ¹⁾	Nominal (Min-Max)	W/W	4,00 (3,70 - 3,68)	3,82 (3,70 - 3,59)	3,35 (3,46 - 3,27)	3,24 (3,46 - 3,08)
	SCOP²⁾			4,20	4,10	4,10
Pdesign at -10°C		kW	2,60	2,80	4,00	4,60
Input power heating	Nominal (Min-Max)	kW	0,80 (0,23 - 1,25)	1,10 (0,23 - 1,42)	1,82 (0,26 - 2,20)	2,16 (0,26 - 2,60)
	Annual energy consumption ³⁾	kWh/a	867	956	1366	1571
Indoor unit			CS-Z25UD3EAW	CS-Z35UD3EAW	CS-Z50UD3EAW	CS-Z60UD3EAW
External static pressure ⁴⁾	Min - Max	Pa	15 - 45	15 - 45	15 - 50	15 - 50
	Air volume	Cool / Heat	m ³ /min	10,5 / 10,5	11,2 / 11,2	15,3 / 15,3
Moisture removal volume		L/h	1,5	2,0	2,8	3,3
	Sound pressure ⁵⁾	Cool (Hi / Lo / Q-Lo)	dB(A)	33 / 27 / 24	33 / 27 / 24	39 / 29 / 26
Heat (Hi / Lo / Q-Lo)		dB(A)	35 / 27 / 24	35 / 27 / 24	39 / 30 / 27	41 / 32 / 29
Dimension	HxWxD	mm	200 x 750 x 640	200 x 750 x 640	200 x 750 x 640	200 x 750 x 640
Net weight		kg	19	19	19	19
Outdoor unit			CU-Z25UBEAE	CU-Z35UBEAE	CU-Z50UBEAE	CU-Z60UBEAE
Power source		V	230	230	230	230
Recommended fuse		A	16	16	16	—
Connection indoor / outdoor		mm ²	4 x 1,5 - 2,5	4 x 1,5 - 2,5	4 x 1,5 - 2,5	—
Air volume	Cool / Heat	m ³ /min	28,7 / 27,2	34,3 / 33,5	39,7 / 38,6	42,6 / 41,5
	Sound pressure ⁵⁾	Cool / Heat (Hi)	dB(A)	46 / 47	48 / 48	48 / 48
Dimension ⁴⁾	HxWxD	mm	542 x 780 x 289	619 x 824 x 299	695 x 875 x 320	695 x 875 x 320
Net weight		kg	33	35	43	43
Piping connections	Liquid pipe	Inch (mm)	1/4 (6,35)	1/4 (6,35)	1/4 (6,35)	1/4 (6,35)
	Gas pipe	Inch (mm)	3/8 (9,52)	3/8 (9,52)	1/2 (12,70)	1/2 (12,70)
Pipe length range		m	3 - 20	3 - 20	3 - 30	3 - 30
Elevation difference (in/out) ⁷⁾		m	15	15	20	20
Pipe length for additional gas		m	7,5	7,5	7,5	7,5
Additional gas amount		g/m	10	10	15	15
Refrigerant (R32) / CO ₂ Eq.		kg / T	0,88 / 0,594	0,93 / 0,628	1,13 / 0,763	1,13 / 0,763
	Operating range	Cool Min ~ Max	°C	-10 ~ +43	-10 ~ +43	-10 ~ +43
Heat Min ~ Max		°C	-15 ~ +24	-15 ~ +24	-15 ~ +24	-15 ~ +24

Accessories

CZ-TACG1	Panasonic Comfort Cloud for internet control
CZ-CAPRA1	RAC interface adapter for integration into P-Link

Accessories

CZ-RL511D	NEW Infrared remote controller Sky Remote. 2m cable length of infrared receiver (available in April 2019)
------------------	--

1) EER and COP calculation is based in accordance to EN14511. 2) Energy Label Scale from A+++ to D. 3) The annual energy consumption is calculated in accordance to EU/626/2011. 4) The specification listed on the table indicates values under the condition of 25Pa (2,5mmAq) which are applied for factory default setting. Change switch on PCB from Hi to S-Hi to have more than 6,0mmAq. 5) The sound pressure of the indoor unit shows the value measured of a position of 1,5m below the unit with 1m duct on the suction side and 2m duct on the discharge side. For outdoor unit 1m in front and 1m in rear side of main body. The sound pressure is measured in accordance with JIS C 9612. 6) Add 100mm for indoor unit or 70mm for outdoor unit for piping port. 7) When installing the outdoor unit at a higher position than the indoor unit.



SEER and SCOP: For KIT-Z25-UD3EA. INTERNET CONTROL: Optional.

MULTI SPLIT AND FREE MULTI SYSTEM

If air conditioning requirements exceed the ambit of a single room, Panasonic offers you a very extensive range of possibilities with up to 5 indoor units connected to a single outdoor unit.



Panasonic offers widest range in Multi Split systems

2 types of Multi Split range from 3,50 to 9,00kW for 5 indoor units with one outdoor unit.

Free Multi Z	New Multi TZ Wall with R32 refrigerant
Full flexibility up to 9,00kW and up to 5 ports with wide range of indoor units including high performance Etherea indoor units, reaching up to A+++ / A++	From 4,10 to 5,20kW for TZ Wall Compact Style unit, reaches A++ / A+

Line up	Refrigerant	Capacities	Indoor unit ports	Efficiency up to	Indoor units				
					Etherea	Compact Style	Floor Console	Cassette	Duct
Multi Z	R32	8 units (3,50 ~ 9,00kW)	2~5	A+++ / A++	Yes	Yes	Yes	Yes	Yes
Multi TZ	R32	3 units (4,10 ~ 5,20kW)	2~3	A++ / A+		Yes			

Multi Split systems

Day and Night	Simultaneous
Ideal for 2 day and night areas. Simultaneous use possible.	When indoor units are most time working at same time.



Why a Multi Split is better than several separate split units

Up to 5 indoor units with a single outdoor unit.

- Just one compact outdoor unit
- Increased comfort in the house since every room has its own indoor unit for heating

- Much more powerful than a single split
- More efficient since the units are always operating at full capacity
- You can connect all types of indoor units, such as wall types and consoles, depending on what suits your house best

Solution with single split.

One indoor unit is connected to one outdoor unit. The indoor unit is placed in the main hallway and heats the entire house. Certain rooms may not be perfectly heated, which causes inadequate comfort.

Solution with Multi Split.

With one outdoor unit, you can connect up to five indoor units. There is one indoor unit per room or area. It gives an extreme increase in comfort levels. On the roof, there is only one outdoor unit.

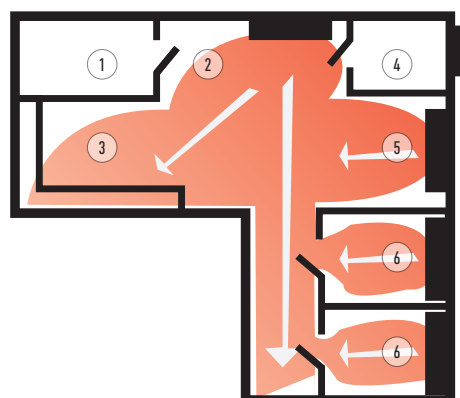
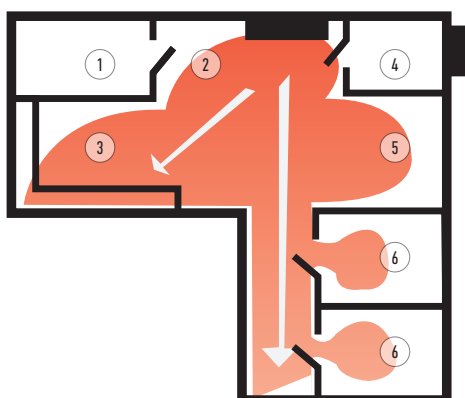

1. Laundry room
2. Entrance

3. Kitchen/dining area
4. Bathroom

5. Living room
6. Bedroom



Outdoor unit Free Multi System Z • R32 Gas

Indoor nominal capacity (Min - Max)			3,20 ~ 6,00kW	3,20 ~ 6,00kW	3,20 ~ 7,70kW	4,50 ~ 9,50kW	4,50 ~ 11,20kW	4,50 ~ 11,50kW	4,50 ~ 14,70kW	4,50 ~ 18,30kW
Unit			CU-2Z35TBE	CU-2Z41TBE	CU-2Z50TBE	CU-3Z52TBE	CU-3Z68TBE	CU-4Z68TBE	CU-4Z80TBE	CU-5Z90TBE
Cooling capacity	Nominal (Min-Max)	kW	3,50(1,50-4,50)	4,10(1,50-5,20)	5,00(1,50-5,40)	5,20(1,80-7,30)	6,80(1,90-8,00)	6,80(1,90-8,80)	8,00(3,00-9,20)	9,00(2,90-11,50)
EER ¹⁾	Nominal (Min-Max)	W/W	4,86(6,00-4,09)	4,56(6,00-3,80)	4,24(6,00-3,62)	4,77	3,66(7,04-3,38)	4,39(5,59-3,56)	4,04(5,66-3,21)	4,09(5,27-2,98)
SEER ²⁾			8,50 A+++	8,50 A+++	8,50 A+++	8,50 A+++	8,00 A++	8,00 A++	7,90 A++	8,50 A+++
Pdesign (cooling)		kW	3,50	4,10	5,00	5,20	6,80	6,80	8,00	9,00
Input power cooling	Nominal (Min-Max)	kW	0,72(0,25-1,10)	0,90(0,25-1,37)	1,18(0,25-1,49)	1,09(0,36-2,18)	1,86(0,27-2,37)	1,55(0,34-2,47)	1,98(0,53-2,87)	2,20(0,55-3,86)
Annual energy consumption ³⁾		kWh/a	144	169	206	214	298	298	990	1100
Heating capacity	Nominal (Min-Max)	kW	4,20(1,10-5,60)	4,60(1,10-7,00)	5,60(1,10-7,20)	6,80(1,60-8,30)	8,50(3,30-10,40)	8,50(3,00-10,60)	9,40(4,20-10,60)	10,40(3,40-14,50)
Heating capacity at -7°C		kW	—	—	—	3,95	4,45	4,45	—	—
COP ¹⁾	Nominal (Min-Max)	W/W	4,88(5,24-4,18)	4,79(5,24-3,91)	4,63(5,24-4,00)	4,63(5,00-3,82)	3,95(5,32-3,64)	4,47(5,17-3,96)	4,63(6,00-3,46)	4,84(6,42-3,42)
SCOP ²⁾			4,60 A++	4,60 A++	4,60 A++	4,20 A+	4,20 A+	4,20 A+	4,70 A++	4,68 A++
Pdesign at -10°C		kW	3,20	3,50	4,20	5,00	5,20	5,80	6,80	8,50
Input power heating	Nominal (Min-Max)	kW	0,86(0,21-1,34)	0,96(0,21-1,79)	1,21(0,21-1,80)	1,47(0,32-2,17)	2,15(0,62-2,86)	1,90(0,58-2,68)	2,03(0,70-3,06)	2,15(0,53-4,24)
Annual energy consumption ³⁾		kWh/a	974	1065	1278	1667	1733	1933	2026	2543
Current	Cool / Heat	A	3,35 / 4,00	4,15 / 4,45	5,35 / 5,50	5,00 / 6,70	8,40 / 9,70	7,00 / 8,60	9,50 / 9,50	10,50 / 10,10
Power source		V	230	230	230	230	230	230	230	230
Recommended fuse		A	16	16	16	16	16	20	20	25
Recommended power cable section		mm ²	2,5	2,5	2,5	2,5	2,5	2,5	2,5	3,5
Sound pressure ⁴⁾	Cool / Heat (Hi)	dB(A)	48 / 50	48 / 50	50 / 52	47 / 48	51 / 52	49 / 50	51 / 52	53 / 54
Dimension ⁵⁾	HxWxD	mm	619x824x299	619x824x299	619x824x299	795x875x320	795x875x320	795x875x320	999x940x340	999x940x340
Net weight		kg	39	39	39	71	71	72	80	81
Piping connections	Liquid pipe	Inch (mm)	1/4 (6,35)	1/4 (6,35)	1/4 (6,35)	1/4 (6,35)	1/4 (6,35)	1/4 (6,35)	1/4 (6,35)	1/4 (6,35)
	Gas pipe	Inch (mm)	3/8 (9,52)	3/8 (9,52)	3/8 (9,52)	3/8 (9,52)	3/8 (9,52)	3/8 (9,52)	3/8 (9,52)	3/8 (9,52)
Pipe length range total ⁶⁾		m	6 ~ 30	6 ~ 30	6 ~ 30	6 ~ 50	6 ~ 60	6 ~ 60	6 ~ 70	6 ~ 80
Pipe length range to one unit		m	3 ~ 20	3 ~ 20	3 ~ 20	3 ~ 25	3 ~ 25	3 ~ 25	3 ~ 25	3 ~ 25
Elevation difference (in/out)		m	10	10	10	15	15	15	15	15
Pipe length for additional gas		m	20	20	20	30	30	30	45	45
Additional gas amount		g/m	15	15	15	20	20	20	20	20
Refrigerant (R32) / CO ₂ Eq.		kg / T	1,12 / 0,756	1,12 / 0,756	1,12 / 0,756	2,10 / 1,418	2,10 / 1,418	2,10 / 1,418	2,72 / 1,836	2,72 / 1,836
Operating range	Cool Min ~ Max	°C	-10 ~ +46	-10 ~ +46	-10 ~ +46	-10 ~ +46	-10 ~ +46	-10 ~ +46	-10 ~ +46	-10 ~ +46
	Heat Min ~ Max	°C	-15 ~ +24	-15 ~ +24	-15 ~ +24	-15 ~ +24	-15 ~ +24	-15 ~ +24	-15 ~ +24	-15 ~ +24

1) EER and COP calculation is based in accordance to EN14511. 2) Energy Label Scale from A+++ to D. 3) The annual energy consumption is calculated in accordance to EU/626/2011. 4) The sound pressure of the units shows the value measured of a position 1m in front and 1m in rear side of the main body. The sound pressure is measured in accordance with JIS C 9612. 5) Add 70 or 95mm for piping port. 6) Minimum piping length is 3 meters per indoor unit.

Possible outdoor / indoor units combinations • R32 Gas

Rooms	Model	Indoor capacity connected (Min - Max)	NEW Etherea Silver								NEW Etherea Pure White Matt								Wall Mounted TZ Compact Style								Floor Console*								4 Way 60x60 Cassette								Low Static Pressure Hide Away							
			16	20	25	35	42	50	60	71	16	20	25	35	42	50	60	71	16	20	25	35	42	50	60	71	16	20	25	35	42	50	60	71	16	20	25	35	42	50	60	71	16	20	25	35	42	50	60	71
2	CU-2Z35TBE	3,20 ~ 6,00kW	✓	✓	✓					✓	✓	✓					✓	✓	✓					✓	✓	✓					✓	✓	✓					✓	✓	✓										
	CU-2Z41TBE	3,20 ~ 6,00kW	✓	✓	✓					✓	✓	✓					✓	✓	✓					✓	✓	✓					✓	✓	✓					✓	✓	✓										
	CU-2Z50TBE	3,20 ~ 7,70kW	✓	✓	✓	✓				✓	✓	✓	✓				✓	✓	✓	✓				✓	✓	✓	✓				✓	✓	✓	✓				✓	✓	✓	✓									
3	CU-3Z52TBE	4,50 ~ 9,50kW	✓	✓	✓	✓				✓	✓	✓	✓				✓	✓	✓	✓				✓	✓	✓	✓				✓	✓	✓	✓				✓	✓	✓	✓									
	CU-3Z68TBE	4,50 ~ 11,20kW	✓	✓	✓	✓				✓	✓	✓	✓				✓	✓	✓	✓				✓	✓	✓	✓				✓	✓	✓	✓				✓	✓	✓	✓									
4	CU-4Z68TBE	4,50 ~ 11,50kW	✓	✓	✓	✓				✓	✓	✓	✓				✓	✓	✓	✓				✓	✓	✓	✓				✓	✓	✓	✓				✓	✓	✓	✓									
	CU-4Z80TBE	4,50 ~ 14,70kW	✓	✓	✓	✓				✓	✓	✓	✓				✓	✓	✓	✓				✓	✓	✓	✓				✓	✓	✓	✓				✓	✓	✓	✓									
5	CU-5Z90TBE	4,50 ~ 18,30kW	✓	✓	✓	✓				✓	✓	✓	✓				✓	✓	✓	✓				✓	✓	✓	✓				✓	✓	✓	✓				✓	✓	✓	✓									

Outdoor Multi combination model

CS-MZ16VKE / CS-MTZ16TKE
 CS-XZ20VKEW / CS-Z20VKEW / CS-TZ20TKEW-1 / CS-MZ20UFEA / CS-MZ20UB4EA / CS-MZ20UD3EA
 CS-XZ25VKEW / CS-Z25VKEW / CS-TZ25TKEW-1 / CS-Z25UFEAW / CS-Z25UB4EAW / CS-Z25UD3EAW
 CS-XZ35VKEW / CS-Z35VKEW / CS-TZ35TKEW-1 / CS-Z35UFEAW / CS-Z35UB4EAW / CS-Z35UD3EAW

CU-2Z35TBE / CU-2Z41TBE / CU-2Z50TBE / CU-3Z52TBE
 CU-3Z68TBE / CU-4Z68TBE / CU-4Z80TBE / CU-5Z90TBE

CS-Z42TKEW / CS-TZ42TKEW-1
 CS-XZ50VKEW / CS-Z50VKEW / CS-TZ50TKEW / CS-Z50UFEAW / CS-Z50UB4EAW / CS-Z50UD3EAW

CU-2Z50TBE / CU-3Z52TBE / CU-3Z68TBE
 CU-4Z68TBE / CU-4Z80TBE / CU-5Z90TBE

CS-TZ60TKEW / CS-Z60UB4EAW / CS-Z60UD3EAW

CU-3Z68TBE / CU-4Z68TBE / CU-4Z80TBE / CU-5Z90TBE

CS-Z71VKEW / CS-TZ71TKEW

CU-4Z80TBE / CU-5Z90TBE

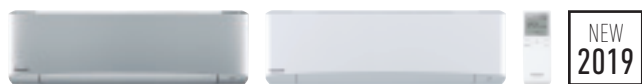
CZ-RD514C
Optional wired
remote controller.

INTERNET CONTROL: Built-in.



NEW Wall Mounted Therea	Indoor unit Silver	Indoor unit Pure White Matt	Cooling capacity	Heating capacity	Connection in. / out.	Sound pressure ¹⁾		Dimension / Net weight	Piping connections
						Cool — Heat (Hi / Lo / S-Lo)			
						kW	kW		
1,60kW	—	CS-MZ16VKE	1,60	2,60	4 x 1,5	38 / 26 / 21 — 39 / 27 / 21		295 x 919 x 194 / 9	1/4 (6,35) / 3/8 (9,52)
2,00kW	CS-XZ20VKEW	CS-Z20VKEW	2,00	3,20	4 x 1,5	39 / 26 / 21 — 40 / 27 / 21		295 x 919 x 194 / 9	1/4 (6,35) / 3/8 (9,52)
2,50kW	CS-XZ25VKEW	CS-Z25VKEW	2,50	3,60	4 x 1,5	41 / 27 / 21 — 43 / 29 / 21		295 x 919 x 194 / 10	1/4 (6,35) / 3/8 (9,52)
3,50kW	CS-XZ35VKEW	CS-Z35VKEW	3,20	4,50	4 x 1,5	44 / 30 / 21 — 45 / 35 / 21		295 x 919 x 194 / 10	1/4 (6,35) / 3/8 (9,52)
4,20kW	—	CS-Z42VKEW	4,00	5,60	4 x 1,5	44 / 33 / 27 — 45 / 37 / 31		295 x 919 x 194 / 10	1/4 (6,35) / 1/2 (12,70)
5,00kW	CS-XZ50VKEW	CS-Z50VKEW	5,00	6,80	4 x 1,5	44 / 39 / 32 — 46 / 39 / 32		302 x 1120 x 236 / 12	1/4 (6,35) / 1/2 (12,70)
7,10kW	—	CS-Z71VKEW	7,10	8,60	—	49 / 40 / 32 — 49 / 40 / 32		302 x 1120 x 236 / 13	1/4 (6,35) / 5/8 (15,88)

CZ-RD514C
Optional wired
remote controller.

INTERNET CONTROL: Optional.



Wall Mounted TZ Compact Style	Indoor unit	Cooling capacity	Heating capacity	Connection in. / out.	Sound pressure ¹⁾		Dimension / Net weight	Piping connections
					Cool — Heat (Hi / Lo / S-Lo)			
					kW	kW		
1,60kW	CS-MTZ16TKE	1,60	2,60	4 x 1,5	38 / 27 / 22 — 39 / 28 / 24		290 x 799 x 197 / 8	1/4 (6,35) / 3/8 (9,52)
2,00kW	CS-TZ20TKEW-1	2,00	3,20	4 x 1,5	39 / 27 / 22 — 40 / 28 / 24		290 x 799 x 197 / 8	1/4 (6,35) / 3/8 (9,52)
2,50kW	CS-TZ25TKEW-1	2,50	3,60	4 x 1,5	42 / 28 / 22 — 42 / 29 / 24		290 x 799 x 197 / 8	1/4 (6,35) / 3/8 (9,52)
3,50kW ²⁾	CS-TZ35TKEW-1	3,50	4,50	4 x 1,5	44 / 32 / 22 — 44 / 35 / 24		290 x 799 x 197 / 8	1/4 (6,35) / 3/8 (9,52)
4,20kW	CS-TZ42TKEW-1	4,20	5,00	4 x 1,5	44 / 33 / 31 — 46 / 37 / 30		290 x 799 x 197 / 8	1/4 (6,35) / 1/2 (12,70)
5,00kW	CS-TZ50TKEW	5,00	5,30	4 x 1,5	44 / 39 / 36 — 46 / 39 / 36		302 x 1102 x 244 / 12	1/4 (6,35) / 1/2 (12,70)
6,00kW	CS-TZ60TKEW	6,00	8,50	4 x 1,5	44 / 39 / 36 — 47 / 39 / 36		302 x 1102 x 244 / 13	1/4 (6,35) / 1/2 (12,70)
7,10kW	CS-TZ71TKEW	7,10	8,70	4 x 1,5	49 / 40 / 37 — 49 / 40 / 37		302 x 1102 x 244 / 13	1/4 (6,35) / 1/2 (12,70)

CZ-RD514C
Optional wired
remote controller.

INTERNET CONTROL: Optional.



Floor Console ³⁾	Indoor unit	Cooling capacity	Heating capacity	Connection in. / out.	Sound pressure ⁴⁾		Dimension / Net weight	Piping connections
					Cool — Heat (Hi / Lo / S-Lo)			
					kW	kW		
2,00kW	CS-MZ20UFEA	2,00	3,20	4 x 1,5	39 / 27 / 22 — 39 / 27 / 21		600 x 750 x 207 / 13	1/4 (6,35) / 3/8 (9,52)
2,50kW	CS-Z25UFEAW	2,50	3,60	4 x 1,5	40 / 27 / 22 — 40 / 27 / 21		600 x 750 x 207 / 13	1/4 (6,35) / 3/8 (9,52)
3,50kW ²⁾	CS-Z35UFEAW	3,50	4,50	4 x 1,5	41 / 28 / 22 — 41 / 28 / 21		600 x 750 x 207 / 13	1/4 (6,35) / 3/8 (9,52)
5,00kW	CS-Z50UFEAW	5,00	5,30	4 x 1,5	44 / 33 / 29 — 48 / 35 / 31		600 x 750 x 207 / 13	1/4 (6,35) / 3/8 (9,52)

CZ-BT20EW
RAL9010 panel for 4 Way
60x60 Cassette (sold
separately).

CZ-RD52CP
Optional wired
remote controller.

INTERNET CONTROL READY and EASY CONTROL BY BMS: Optional.



4 Way 60x60 Cassette	Indoor unit (Panel CZ-BT20EW)	Cooling capacity	Heating capacity	Connection in. / out.	Sound pressure ⁶⁾		Dimension / Net weight		Piping connections
					Cool — Heat (Hi / Lo / S-Lo)		Indoor HxWxD	Panel HxWxD	
					kW	kW	mm ²	dB(A)	
2,00kW	CS-MZ20UB4EA	2,00	3,20	4 x 1,5	35 / 27 / 24 — 36 / 30 / 27		260 x 575 x 575 / 18	51 x 700 x 700 / 2,5	1/4 (6,35) / 3/8 (9,52)
2,50kW	CS-Z25UB4EAW	2,50	3,60	4 x 1,5	36 / 27 / 24 — 37 / 30 / 27		260 x 575 x 575 / 18	51 x 700 x 700 / 2,5	1/4 (6,35) / 3/8 (9,52)
3,50kW ²⁾	CS-Z35UB4EAW	3,50	4,50	4 x 1,5	36 / 28 / 25 — 37 / 30 / 27		260 x 575 x 575 / 18	51 x 700 x 700 / 2,5	1/4 (6,35) / 3/8 (9,52)
5,00kW ⁵⁾	CS-Z50UB4EAW	5,00	6,80	4 x 1,5	39 / 30 / 27 — 40 / 31 / 28		260 x 575 x 575 / 18	51 x 700 x 700 / 2,5	1/4 (6,35) / 3/8 (9,52)
6,00kW	CS-Z60UB4EAW	6,00	8,50	4 x 1,5	44 / 34 / 31 — 45 / 34 / 31		260 x 575 x 575 / 18	51 x 700 x 700 / 2,5	1/4 (6,35) / 1/2 (12,70)

CZ-RL511D
NEW optional wireless kit.

INTERNET CONTROL READY and EASY CONTROL BY BMS: Optional.



Low Static Pressure Hide Away	Indoor unit	Cooling capacity	Heating capacity	Connection in. / out.	Sound pressure ⁷⁾		Dimension / Net weight	Piping connections
					Cool — Heat (Hi / Lo / S-Lo)			
					kW	kW		
2,00kW	CS-MZ20UD3EA	2,00	3,20	4 x 1,5	34 / 29 / 26 — 36 / 29 / 26		200 x 750 x 640 / 19	1/4 (6,35) / 3/8 (9,52)
2,50kW	CS-Z25UD3EAW	2,50	3,60	4 x 1,5	35 / 29 / 26 — 37 / 29 / 26		200 x 750 x 640 / 19	1/4 (6,35) / 3/8 (9,52)
3,50kW ²⁾	CS-Z35UD3EAW	3,50	4,50	4 x 1,5	35 / 29 / 26 — 37 / 29 / 26		200 x 750 x 640 / 19	1/4 (6,35) / 3/8 (9,52)
5,00kW ⁵⁾	CS-Z50UD3EAW	5,00	6,80	4 x 1,5	41 / 31 / 28 — 41 / 32 / 29		200 x 750 x 640 / 19	1/4 (6,35) / 3/8 (9,52)
6,00kW	CS-Z60UD3EAW	6,00	8,50	4 x 1,5	43 / 32 / 29 — 43 / 34 / 31		200 x 750 x 640 / 19	1/4 (6,35) / 1/2 (12,70)

1) The sound pressure of the indoor unit shows the value measured of a position 1m in front of the main body and 0,8m below the unit. The sound pressure is measured in accordance with JIS C 9612. Q-Lo: Quiet mode. Lo: The lowest set fan speed. 2) The heating capacity is 4,20kW connected to a CU-Z235TBE. 3) Compatible only with 2 ports Outdoor CU-Z235TBE / CU-2241TBE / CU-Z250TBE. 4) The sound pressure of the units shows the value measured of a position 1m in front of the main body and 1m above floor. The sound pressure is measured in accordance with JIS C 9612. Q-Lo: Quiet mode. Lo: The lowest set fan speed. 5) The heating capacity is 5,30kW connected to a CU-Z250TBE. 6) The sound pressure of the indoor unit shows the value measured of a position 1,5m below the unit. The sound pressure is measured in accordance with JIS C 9612. Q-Lo: Quiet mode. Lo: The lowest set fan speed. 7) The sound pressure of the indoor unit shows the value measured of a position 1,5m below the unit with 1m duct on the suction side and 2m duct on the discharge side. The sound pressure is measured in accordance with JIS C 9612.



NEW
2019



NEW Etherea Multi Split Inverter+ • R32 Gas

			Day and Night				
Rooms			2 Rooms		3 Rooms		
Kit Silver			KIT-2XZ2525-TBE	KIT-2XZ2035-TBE	KIT-2XZ2535-TBE	KIT-3XZ202035-TBE	KIT-3XZ252535-TBE
Indoor unit Silver			CS-XZ25VKEW	CS-XZ35VKEW	CS-XZ25VKEW	CS-XZ35VKEW	CS-XZ25VKEW
			CS-XZ25VKEW	CS-XZ20VKEW	CS-XZ25VKEW	CS-XZ20VKEW	CS-XZ25VKEW
Kit Pure White Matt			KIT-2Z2525-TBE	KIT-2Z2035-TBE	KIT-2Z2535-TBE	KIT-3Z202035-TBE	KIT-3Z252535-TBE
Indoor unit Pure White Matt			CS-Z25VKEW	CS-Z35VKEW	CS-Z35VKEW	CS-Z35VKEW	CS-Z35VKEW
			CS-Z25VKEW	CS-Z20VKEW	CS-Z25VKEW	CS-Z20VKEW	CS-Z25VKEW
Outdoor unit			CU-2Z41TBE	CU-2Z41TBE	CU-2Z41TBE	CU-3Z52TBE	CU-3Z52TBE
Cooling capacity	Nominal (Min-Max)	kW	2,50 (1,10 - 3,50)	4,10 (1,50 - 5,20)	4,10 (1,50 - 5,20)	5,20 (1,80 - 7,30)	5,20 (1,80 - 7,30)
EER		W/W	3,73	4,56	4,56	4,48	4,48
SEER							
Heating capacity	Nominal (Min-Max)	kW	3,60 (0,70 - 5,50)	4,60 (1,10 - 7,00)	4,60 (1,10 - 7,00)	6,80 (1,60 - 8,30)	6,80 (1,60 - 8,30)
COP		W/W	3,50	4,84	4,84	4,79	4,79
SCOP							
Indoor dimension	(HxWxD)	mm	295 x 919 x 194	295 x 919 x 194	295 x 919 x 194	295 x 919 x 194	295 x 919 x 194
Indoor net weight		kg	10	10 (9 for Z20)	10	10 (9 for Z20)	10

			Simultaneous				
Rooms			2 Rooms		3 Rooms		
Kit Silver			KIT-2XZ2525-VKE	KIT-2XZ2035-VKE	KIT-2XZ2535-VKE	KIT-3XZ202035-VKE	KIT-3XZ252535-VKE
Indoor unit Silver			CS-XZ25VKEW	CS-XZ35VKEW	CS-XZ35VKEW	CS-XZ35VKEW	CS-XZ35VKEW
			CS-XZ25VKEW	CS-XZ20VKEW	CS-XZ25VKEW	CS-XZ20VKEW	CS-XZ25VKEW
Kit Pure White Matt			KIT-2Z2525-VKE	KIT-2Z2035-VKE	KIT-2Z2535-VKE	KIT-3Z202035-VKE	KIT-3Z252535-VKE
Indoor unit Pure White Matt			CS-Z25VKEW	CS-Z35VKEW	CS-Z35VKEW	CS-Z35VKEW	CS-Z35VKEW
			CS-Z25VKEW	CS-Z20VKEW	CS-Z25VKEW	CS-Z20VKEW	CS-Z25VKEW
Outdoor unit			CU-2Z50TBE	CU-2Z50TBE	CU-2Z50TBE	CU-3Z68TBE	CU-3Z68TBE
Cooling capacity	Nominal (Min-Max)	kW	5,00 (1,50 - 5,40)	5,00 (1,50 - 5,40)	5,00 (1,50 - 5,40)	6,80 (1,90 - 8,00)	6,80 (1,90 - 8,00)
EER		W/W	4,24	4,24	4,24	3,56	3,56
SEER			8,50 A+++				
Heating capacity	Nominal (Min-Max)	kW	5,60 (1,10 - 7,20)	5,40 (1,10 - 7,20)	5,40 (1,10 - 7,20)	8,50 (3,30 - 10,40)	8,50 (3,30 - 10,40)
COP		W/W	4,63	4,63	4,63	4,09	4,09
SCOP			4,60 A+++				
Indoor dimension	(HxWxD)	mm	295 x 919 x 194	295 x 919 x 194	295 x 919 x 194	295 x 919 x 194	295 x 919 x 194
Indoor net weight		kg	10	10 (9 for Z20)	10	10 (9 for Z20)	10



FEATURE COMPARISON

MODELS	WALL MOUNTED HEATCHARGE VZ • R32 GAS	WALL MOUNTED ETHEREA • R32 GAS	WALL MOUNTED TZ COMPACT STYLE • R32 GAS	WALL MOUNTED FZ • R32 GAS	WALL MOUNTED PROFESSIONAL -20°C • R32 GAS	FLOOR CONSOLE • R32 GAS	4 WAY 60x60 CASSETTE • R32 GAS	LOW STATIC PRESSURE HIDE AWAY • R32 GAS
Refrigerant R32	✓	✓	✓	✓	✓	✓	✓	✓
Econavi, Sunlight Sensor	✓							
Inverter+ system	✓	✓				✓		
Inverter system			✓	✓	✓		✓	✓
R2 Rotary Compressor	✓	✓	✓	✓	✓	✓	✓	✓
nanoe™ X	✓ nanoe™	✓				✓		
PM2.5 Filter			✓	✓				
Dust collection filter								
Antiallergy properties	✓	✓				✓		
Super Quiet ¹⁾	✓	✓ 19dB(A) for XZ/TZ20, XZ/Z25 and XZ/Z35	✓ 20dB(A) for TZ20, TZ25 and TZ35	✓ 20dB(A) for FZ25 and FZ35	✓ 21dB(A) for Z25 and Z35	✓ 20dB(A) for Z25 and Z35	✓ 22dB(A) for Z25	
Mild Dry Cooling		✓						
Aerowings		✓	✓		✓			
Down to -10°C in cooling only	✓	✓	✓	✓	✓ -20°C	✓	✓	✓
Down to -15°C in heating mode	✓ -35°C ²⁾	✓	✓	✓	✓	✓	✓	✓
Summer House	✓							
R22 renewal								
R410A/R22 Renewal	✓	✓	✓	✓	✓	✓	✓	✓
Odour-removing function	✓	✓	✓	✓	✓	✓	✓	✓
Removable, washable panel	✓	✓	✓	✓	✓	✓	✓	✓
Powerful mode	✓	✓	✓	✓	✓	✓	✓	✓
Soft dry operation mode	✓	✓	✓	✓	✓	✓	✓	✓
Personal airflow creation	✓	✓	✓ For TZ50, TZ60 and TZ71					
Automatic vertical airflow control			✓ For TZ20, TZ25, TZ35 and TZ42	✓		✓	✓	
Manual horizontal airflow control			✓ For TZ20, TZ25, TZ35 and TZ42	✓		✓		
Auto mode	✓	✓	✓	✓	✓	✓	✓	✓
Hot start mode	✓	✓	✓	✓	✓	✓	✓	✓
Real time clock with dual ON&OFF timer	✓	✓	✓	✓		✓	✓	
Weekly timer					✓			✓
LCD infrared remote controller	✓	✓	✓	✓		✓	✓	
Automatic restart	✓	✓	✓	✓	✓	✓	✓	✓
Long piping	✓ 15m	✓ 15m, 30m (XZ/Z50, XZ/Z71)	✓ 15m, 20m (TZ50), 30m (TZ71 and TZ60)	✓ 15m, 20m (FZ60)	✓ 15m, 20m (Z50)	✓ 20m, 30m (Z50)	✓ 20m, 30m (Z50 and Z60)	✓ 20m, 30m (Z50 and Z60)
Top-Panel maintenance access	✓	✓	✓	✓	✓	✓	✓	✓
Self-diagnosis function	✓	✓	✓	✓	✓	✓	✓	✓
CZ-CAPRA1: RAC interface adapter for integration into P-Link	✓	✓	✓	✓	✓	✓	✓	✓
Internet Control	✓	✓ Built-in	✓	✓	✓	✓	✓	✓
Easy control by BMS	✓	✓	✓	✓	✓	✓	✓	✓
Warranty on the compressor	✓	✓	✓	✓	✓	✓	✓	✓

1) At the lowest fan speed. 2) Tested by 3rd party laboratory, SP, according to EN14511:2013 and SP Method 1721, this temperature is not guaranteed by Factory.

FEATURES EXPLAINED

Energy saving

38% ECONAVI Domestic Econavi. Sunlight Sensor technology can detect and reduce the waste of energy by optimising air conditioner operation according to room conditions. With just one touch of a button, you can save energy.

INVERTER+ Inverter Plus System. This classification highlights the Panasonic highest performing systems.

INVERTER Inverter system. The Inverter range provides greater efficiency and comfort. Provides more precise temperature control, without highs and lows, and keeps the ambient temperature constant with lower energy consumption and a significant reduction in noise and vibration levels.

R2 ROTARY COMPRESSOR R2 Rotary Compressor. Panasonic R2 Rotary Compressor. Designed to withstand extreme conditions, it delivers high performance and efficiency.

R32 Refrigerant R32. Our heat pumps containing the refrigerant R32 show a drastic reduction in the value of Global Warming Potential (GWP). An important step to reduce greenhouse gases. R32 is also a component refrigerant, making it easy to recycle.

High performance and healthy air

nanoe™ X nanoe™ X. Panasonic's latest innovation nanoe™ X helps you deodorise, inhibit certain growth of bacteria and viruses that are harmful to you and your family's general well-being.

PM2.5 FILTER PM2.5 Filter. Particulate matter (PM2.5) can be found suspended in the air, including dust, dirt, smoke and liquid droplets. Sized at 2.5µm, these particles are said to pose health problems as they can easily enter our lungs.

DUST COLLECTION FILTER Dust Collection Filter. This filter collects and retains particles suspended in the air, as a result the air is cleaner in the room.

ANTIALLERGY PROPERTIES Antiallergy Properties. System is equipped with antiallergy properties filter.

18dB(A) Super Quiet. Thanks to its latest generation compressor and its twin blade fan, our outdoor unit is one of the most silent on the market. The indoor unit emits an almost imperceptible 18 dB(A).

HUMIDITY CONTROL MILD DRY Mild Dry Cooling. Fine control helps prevent a rapid decrease in room humidity while maintaining the set temperature. Maintains an RH* up to 10% higher than cooling operation (*RH: Relative Humidity). Ideal when sleeping with the air conditioner on.

AEROWINGS Aerowings. More comfort with Aerowings. Direct airflow to ceiling to create shower cooling effect by twin flap built in indoor.

COOLING MODE **-10°C** Down to -10°C in cooling only mode. The air conditioner works in cooling only mode with an outdoor temperature of -10°C.

HEATING MODE **-15°C** Down to -15°C in heating mode. The air conditioner works in heat pump mode with an outdoor temperature as low as -15°C.

SUMMER HOUSE Summer House. This innovative function keeps the house at 7/8°C to avoid freezing pipes during the winter. This function is highly appreciated in summer house or week end houses.

R22 RENEWAL R22 Renewal. The Panasonic renewal system allows good quality existing R22 pipe work to be re-used whilst installing new high efficiency R410A systems.

R22/R410A RENEWAL R410A/R22 Renewal. The Panasonic renewal system allows good quality existing R410A or R22 pipe work to be re-used whilst installing new high efficiency R32 systems.

ODOUR-REMOVING FUNCTION Odour-removing function. Allows the exchanger to be cleaned, preventing possible odours. While this function is connected, the fan also remains OFF momentarily to avoid unpleasant odours while the exchanger is being cleaned.

REMOVABLE, WASHABLE PANEL Removable, washable panel. The front panel is easy to keep clean. It can be removed quickly in one single step and can be washed in water. A clean front panel ensures smoother, more efficient operation, which can save energy.

POWERFUL MODE Powerful Mode. The rapid and effective powerful mode is ideal for when you come home on the hottest or coldest days. It works at maximum power to reach the desired temperature in just 15 minutes.

SOFT DRY OPERATION MODE Soft Dry Operation Mode. The soft dry mode eliminates excess moisture with a soft breeze and provides a sense of wellbeing without much change in temperature.

PERSONAL AIRFLOW CREATION Personal Airflow Creation. Permits the air direction to be adjusted vertically and horizontally. This feature can be conveniently selected by remote controller.

Automatic Vertical Airflow Control Automatic Vertical Airflow Control. The flap swings up and down automatically. The flow can also be set at a fixed angle with the remote controller.

Manual Horizontal Airflow Control Manual Horizontal Airflow Control.

Auto Mode Auto Mode. Automatically switches the current operation mode to heating or cooling mode necessary to keep the temperature at a constantly comfortable level based on the temperature of the room. In case of Multi Split installation the function is limited to first unit working and logic of switching is different considering also the outdoor temperature.

Hot Start Mode Hot Start Mode. At the start of heating cycle and after defrost cycle, the indoor fan will start up once the indoor heat exchanger is warm.

24 DUAL Real time clock with dual ON&OFF timer. This feature enables you to preset two different sets of start/stop operation timer (hour and minute) within a 24-hour time frame.

7 Weekly timer. Allow to fix per each day of the week up to 6 operations per day.

LCD infrared remote controller LCD infrared remote controller.

Automatic Restart Automatic Restart. This function permits automatic restarting if safe mode operation has stopped for some unusual reason, such as after a power cut. As soon as the power is back, the unit restarts with the parameters selected before it stopped.

Long Piping Long Piping. Indicates the maximum length of pipe between the outdoor unit and the indoor unit(s). The distances permitted, demonstrate the installations possible.

Top-Panel Maintenance Access Top-Panel Maintenance Access. Maintenance of an outdoor unit used to be quite a tedious task. Now, with the possibility of removing the top cover, maintenance is quick and easy.

Self-Diagnosis Function Self-Diagnosis Function. With this function the unit carries out a process self-diagnosis when a particular function does not work correctly. This allows faster servicing.

High connectivity

INTEGRATION TO P-LINK CZ-CAPRA1: CZ-CNT port integration to PACi and ECOi. Domestic integration to P-Link. Can connect ranges to P-Link. Full control is now possible.

OPTIONAL WLAN Internet Control. Internet Control is a next generation system providing user-friendly remote controller of air conditioning or heat pump units from everywhere, using a simple Android or iOS smartphone, tablet or PC via internet.

BMS CONNECTIVITY Easy control by BMS. The communication port can be integrated into the indoor unit and provides easy connection to, and control of, your Panasonic heat pump to your home or building management system.

5 YEARS COMPRESSOR WARRANTY 5 Years Warranty. Panasonic guarantees the compressors in the entire range for five years.

ACCESSORIES AND CONTROL

Optional PCB's for additional functions



CZ-TACG1
Panasonic Comfort Cloud for internet control.



CZ-CAPRA1
RAC interface adapter for integration into P-Link.



PAW-AC-KNX-1i
This interface can be used with all models which have a CN-CNT connector.



PAW-AC-MBS-1
This interface can be used with all models which have a CN-CNT connector.



PAW-AC-ENO-1i
This interface can be used with all models which have a CN-CNT connector.



PAW-AC-BAC-1
This interface can be used with all models which have a CN-CNT connector.



PAW-AC-DIO
This interface can be used with all models which have a CN-RMT connector.



PAW-AC-HEAT-1
Heating only PCB for Etherea, 4 Way 60x60 Cassette and Hide Away.



PAW-SMSCONTROL
Control of the Etherea, Flagship and Heatcharge by SMS (need additional SIM card).

Individual Controls



CZ-RD514C
Wired remote controller for Wall Mounted and Floor Console.



CZ-RD52CP
Wired remote controller for Cassette.



CZ-RL511D
NEW Infrared remote controller Sky Remote. 2m cable length of infrared receiver for Hide Away (available in April 2019).

Panels



CZ-BT20EW
RAL9010 panel for 4 Way 60x60 Cassette.



Free Multi R32 combinations table

Free Multi 2x1 CU-ZZ35TBE. Minimum capacity connected: 3,20kW. Maximum capacity connected: 6,00kW • R32 GAS

Indoor unit capacity	Cooling capacity (kW). Rooms				EER	SEER ¹⁾	Input power rating			A.E.C.	Current	Heating capacity (kW). Rooms				COP	SCOP ¹⁾	Input power rating			A.E.C.	Current
	A	B	Total (Min-Max)				W/W	kW	kWh			230V	A	B	Total (Min-Max)			W/W	kW	kWh		
1 Room																						
16	1,60		1,60(1,10-2,30)		3,90		0,41(0,22-0,60)			205	1,95	2,60	2,60(0,70-3,80)		3,77		0,69(0,17-1,11)			345	3,20	
20	2,00		2,00(1,10-2,90)		3,85		0,52(0,22-0,77)			260	2,45	3,20	3,20(0,70-4,80)		3,76		0,85(0,17-1,41)			425	3,95	
25	2,50		2,50(1,10-3,50)		3,73		0,67(0,22-1,00)			335	3,15	3,60	3,60(0,70-5,50)		3,50		1,03(0,17-1,70)			515	4,75	
35	3,50		3,50(1,10-4,00)		3,47		1,01(0,22-1,22)			505	4,70	4,20	4,20(0,70-5,60)		3,44		1,22(0,17-1,68)			610	5,65	
2 Rooms																						
16+16	1,60	1,60	3,20(1,50-4,00)		4,92	8,50	0,65(0,25-1,00)			325	3,05	2,10	2,10	4,20(1,10-5,60)		4,88	4,60	0,86(0,21-1,34)			430	4,00
16+20	1,55	1,95	3,50(1,50-4,50)		4,86	8,50	0,72(0,25-1,10)			360	3,35	1,85	2,35	4,20(1,10-5,60)		4,88	4,60	0,86(0,21-1,34)			430	4,00
16+25	1,35	2,15	3,50(1,50-4,50)		4,86	8,50	0,72(0,25-1,10)			360	3,35	1,65	2,55	4,20(1,10-5,60)		4,88	4,60	0,86(0,21-1,34)			430	4,00
16+35	1,10	2,40	3,50(1,50-4,50)		4,86	8,50	0,72(0,25-1,10)			360	3,35	1,30	2,90	4,20(1,10-5,60)		4,88	4,60	0,86(0,21-1,34)			430	4,00
20+20	1,75	1,75	3,50(1,50-4,50)		4,86	8,50	0,72(0,25-1,10)			360	3,35	2,10	2,10	4,20(1,10-5,60)		4,88	4,60	0,86(0,21-1,34)			430	4,00
20+25	1,55	1,95	3,50(1,50-4,50)		4,86	8,50	0,72(0,25-1,10)			360	3,35	1,85	2,35	4,20(1,10-5,60)		4,88	4,60	0,86(0,21-1,34)			430	4,00
20+35	1,25	2,25	3,50(1,50-4,50)		5,07	8,50	0,69(0,25-1,05)			345	3,25	1,55	2,65	4,20(1,10-5,60)		5,00	4,60	0,84(0,21-1,29)			420	3,90
25+25	1,75	1,75	3,50(1,50-4,50)		5,07	8,50	0,69(0,25-1,05)			345	3,25	2,10	2,10	4,20(1,10-5,60)		5,00	4,60	0,84(0,21-1,29)			420	3,90
25+35	1,45	2,05	3,50(1,50-4,50)		5,07	8,50	0,69(0,25-1,05)			345	3,25	1,75	2,45	4,20(1,10-5,60)		5,00	4,60	0,84(0,21-1,29)			420	3,90

Free Multi 2x1 CU-ZZ41TBE. Minimum capacity connected: 3,20kW. Maximum capacity connected: 6,00kW • R32 GAS

Indoor unit capacity	Cooling capacity (kW). Rooms				EER	SEER ¹⁾	Input power rating			A.E.C.	Current	Heating capacity (kW). Rooms				COP	SCOP ¹⁾	Input power rating			A.E.C.	Current
	A	B	Total (Min-Max)				W/W	kW	kWh			230V	A	B	Total (Min-Max)			W/W	kW	kWh		
1 Room																						
16	1,60		1,60(1,10-2,30)		3,90		0,41(0,22-0,60)			205	1,95	2,60	2,60(0,70-3,80)		3,77		0,69(0,17-1,11)			345	3,20	
20	2,00		2,00(1,10-2,90)		3,85		0,52(0,22-0,77)			260	2,45	3,20	3,20(0,70-4,80)		3,76		0,85(0,17-1,41)			425	3,95	
25	2,50		2,50(1,10-3,50)		3,73		0,67(0,22-1,00)			335	3,15	3,60	3,60(0,70-5,50)		3,50		1,03(0,17-1,70)			515	4,75	
35	3,50		3,50(1,10-4,00)		3,47		1,01(0,22-1,22)			505	4,70	4,50	4,50(0,70-6,20)		3,60		1,25(0,17-1,81)			625	5,80	
2 Rooms																						
16+16	1,60	1,60	3,20(1,50-4,00)		4,71	8,50	0,68(0,25-0,99)			340	3,15	2,20	2,20	4,40(1,10-7,00)		4,68	4,60	0,94(0,21-1,81)			470	4,35
16+20	1,60	2,00	3,60(1,50-4,50)		4,62	8,50	0,78(0,25-1,15)			390	3,60	2,05	2,55	4,60(1,10-7,00)		4,79	4,60	0,96(0,21-1,79)			480	4,45
16+25	1,60	2,50	4,10(1,50-5,20)		4,56	8,50	0,90(0,25-1,37)			450	4,15	1,80	2,80	4,60(1,10-7,00)		4,79	4,60	0,96(0,21-1,79)			480	4,45
16+35	1,30	2,80	4,10(1,50-5,20)		4,56	8,50	0,90(0,25-1,37)			450	4,15	1,45	3,15	4,60(1,10-7,00)		4,79	4,60	0,96(0,21-1,79)			480	4,45
20+20	2,00	2,00	4,00(1,50-5,00)		4,49	8,50	0,89(0,25-1,31)			445	4,10	2,30	2,30	4,60(1,10-7,00)		4,84	4,60	0,95(0,21-1,77)			475	4,40
20+25	1,80	2,30	4,10(1,50-5,20)		4,56	8,50	0,90(0,25-1,37)			450	4,15	2,05	2,55	4,60(1,10-7,00)		4,84	4,60	0,95(0,21-1,77)			475	4,40
20+35	1,50	2,60	4,10(1,50-5,20)		4,56	8,50	0,90(0,25-1,37)			450	4,15	1,65	2,95	4,60(1,10-7,00)		4,84	4,60	0,95(0,21-1,77)			475	4,40
25+25	2,05	2,05	4,10(1,50-5,20)		4,56	8,50	0,90(0,25-1,37)			450	4,15	2,30	2,30	4,60(1,10-7,00)		4,84	4,60	0,95(0,21-1,77)			475	4,40
25+35	1,70	2,40	4,10(1,50-5,20)		4,56	8,50	0,90(0,25-1,37)			450	4,15	1,90	2,70	4,60(1,10-7,00)		4,84	4,60	0,95(0,21-1,77)			475	4,40

Free Multi 2x1 CU-ZZ50TBE. Minimum capacity connected: 3,20kW. Maximum capacity connected: 7,70kW • R32 GAS

Indoor unit capacity	Cooling capacity (kW). Rooms				EER	SEER ¹⁾	Input power rating			A.E.C.	Current	Heating capacity (kW). Rooms				COP	SCOP ¹⁾	Input power rating			A.E.C.	Current
	A	B	Total (Min-Max)				W/W	kW	kWh			230V	A	B	Total (Min-Max)			W/W	kW	kWh		
1 Room																						
16	1,60		1,60(1,10-2,30)		3,90		0,41(0,22-0,60)			205	1,95	2,60	2,60(0,70-3,80)		3,77		0,69(0,17-1,11)			345	3,20	
20	2,00		2,00(1,10-2,90)		3,85		0,52(0,22-0,77)			260	2,45	3,20	3,20(0,70-4,80)		3,76		0,85(0,17-1,41)			425	3,95	
25	2,50		2,50(1,10-3,50)		3,73		0,67(0,22-1,00)			335	3,15	3,60	3,60(0,70-5,50)		3,50		1,03(0,17-1,70)			515	4,75	
35	3,50		3,50(1,10-4,00)		3,47		1,01(0,22-1,22)			505	4,70	4,50	4,50(0,70-6,20)		3,60		1,25(0,17-1,81)			625	5,80	
42	4,20		4,20(1,10-4,50)		3,09		1,36(0,22-1,50)			680	6,35	5,00	5,00(1,10-6,40)		3,23		1,55(0,21-2,18)			775	7,15	
50	5,00		5,00(1,20-5,10)		2,96		1,69(0,23-1,79)			845	7,80	5,30	5,30(1,10-6,80)		3,23		1,64(0,21-2,29)			820	7,60	
2 Rooms																						
16+16	1,60	1,60	3,20(1,50-4,00)		4,71	8,50	0,68(0,25-0,99)			340	3,15	2,60	2,60	5,20(1,10-7,00)		4,60	4,60	1,13(0,21-1,81)			565	5,10
16+20	1,60	2,00	3,60(1,50-4,50)		4,62	8,50	0,78(0,25-1,15)			390	3,60	2,40	3,00	5,40(1,10-7,00)		4,58	4,60	1,18(0,21-1,79)			590	5,35
16+25	1,60	2,50	4,10(1,50-5,20)		4,56	8,50	0,90(0,25-1,37)			450	4,15	2,10	3,30	5,40(1,10-7,00)		4,58	4,60	1,18(0,21-1,79)			590	5,35
16+35	1,55	3,45	5,00(1,50-5,20)		4,24	8,50	1,18(0,25-1,37)			590	5,35	1,70	3,70	5,40(1,10-7,00)		4,58	4,60	1,18(0,21-1,79)			590	5,35
16+42	1,40	3,60	5,00(1,50-5,40)		4,24	8,50	1,18(0,25-1,49)			590	5,35	1,55	4,05	5,60(1,10-7,20)		4,63	4,60	1,21(0,21-1,80)			605	5,50
16+50	1,20	3,80	5,00(1,50-5,40)		4,24	8,50	1,18(0,25-1,49)			590	5,35	1,35	4,25	5,60(1,10-7,20)		4,63	4,60	1,21(0,21-1,80)			605	5,50
20+20	2,00	2,00	4,00(1,50-5,00)		4,49	8,50	0,89(0,25-1,31)			445	4,10	2,70	2,70	5,40(1,10-7,00)		4,62	4,60	1,17(0,21-1,77)			585	5,30
20+25	2,00	2,50	4,50(1,50-5,20)		4,37	8,50	1,03(0,25-1,37)			515	4,65	2,40	3,00	5,40(1,10-7,00)		4,62	4,60	1,17(0,21-1,77)			585	5,30
20+35	1,80	3,20	5,00(1,50-5,40)		4,24	8,50	1,18(0,25-1,49)			590	5,35	2,05	3,55	5,60(1,10-7,20)		4,63	4,60	1,21(0,21-1,80)			605	5,50
20+42	1,60	3,40	5,00(1,50-5,40)		4,24	8,50	1,18(0,25-1,49)			590	5,35	1,80	3,80	5,60(1,10-7,20)		4,63	4,60	1,21(0,21-1,80)			605	5,50
20+50	1,45	3,55	5,00(1,50-5,40)		4,24	8,50	1,18(0,25-1,49)			590	5,35	1,60	4,00	5,60(1,10-7,20)		4,63	4,60	1,21(0,21-1,80)			605	5,50
25+25	2,50	2,50	5,00(1,50-5,40)		4,24	8,50	1,18(0,25-1,49)			590	5,35	2,80	2,80	5,60(1,10-7,20)		4,63	4,60	1,21(0,21-1,80)			605	5,50
25+35	2,10	2,90	5,00(1,50-5,40)		4,24	8,50	1,18(0,25-1,49)			590	5,35	2,35	3,25	5,60(1,10-7,20)		4,63	4,60	1,21(0,21-1,80)			605	5,50
25+42	1,85	3,15	5,00(1,50-5,40)		4,24	8,50	1,18(0,25-1,49)			590	5,35	2,10	3,50	5,60(1,10-7,20)		4,63	4,60	1,21(0,21-1,80)			605	5,50
25+50	1,65	3,35	5,00(1,50-5,40)		4,24	8,50	1,18(0,25-1,49)			590	5,35	1,85	3,75	5,60(1,10-7,20)		4,63	4,60	1,21(0,21-1,80)			605	5,50
35+35	2,50	2,50	5,00(1,50-5,40)		4,24	8,50	1,18(0,25-1,49)			590	5,35	2,80	2,80	5,60(1,10-7,20)		4,63	4,60	1,21(0,21-1,80)			605	5,50
35+42	2,25	2,75	5,00(1,50-5,40)		4,24	8,50	1,18(0,25-1,49)			590	5,35	2,55	3,05	5,60(1,10-7,20)		4,63	4,60	1,21(0,21-1,80)			605	5,50

1) Energy Label Scale from A+++ to D.

Free Multi 3x1 CU-3Z52TBE. Minimum capacity connected: 4,50kW. Maximum capacity connected: 9,50kW • R32 GAS

Indoor unit capacity	Cooling capacity (kW). Rooms				EER	SEER ¹	Input power rating			A.E.C.	Current	Heating capacity (kW). Rooms				COP	SCOP ¹	Input power rating			A.E.C.	Current
	A	B	C	Total (Min-Max)			W/W	kW	kWh			230V	A	B	C			Total (Min-Max)	W/W	kW		
1 Room																						
16	1,60			1,60 (1,30 - 2,30)	4,00		0,40 (0,25 - 0,64)	200	2,00			2,60			2,60 (1,20 - 3,20)	4,33		0,60 (0,30 - 0,96)	300	3,00		
20	2,00			2,00 (1,80 - 2,90)	4,00		0,50 (0,34 - 0,81)	250	2,50			3,20			3,20 (1,20 - 4,10)	4,32		0,74 (0,30 - 1,23)	370	3,70		
25	2,50			2,50 (1,80 - 2,90)	3,97		0,63 (0,34 - 0,81)	315	3,00			3,60			3,60 (1,20 - 4,30)	3,83		0,94 (0,30 - 1,23)	470	4,50		
35	3,50			3,50 (1,80 - 3,80)	3,72		0,94 (0,34 - 1,36)	470	4,30			4,50			4,50 (1,20 - 5,80)	3,66		1,23 (0,30 - 2,10)	615	5,80		
42	4,20			4,20 (1,80 - 4,30)	3,07		1,37 (0,34 - 1,99)	685	6,10			5,60			5,60 (1,20 - 6,80)	3,26		1,72 (0,30 - 2,93)	860	7,70		
50	5,00			5,00 (1,90 - 5,70)	3,23		1,55 (0,34 - 2,13)	775	6,80			6,80			6,80 (1,20 - 6,90)	3,24		2,10 (0,30 - 2,52)	1050	9,20		
2 Rooms																						
16+16	1,60	1,60		3,20 (1,80 - 6,20)	5,42	7,00	0,59 (0,33 - 2,09)	295	2,90	2,60	2,60			5,20 (1,40 - 7,00)	4,13	3,80	1,26 (0,34 - 1,99)	630	5,80			
16+20	1,60	2,00		3,60 (1,80 - 6,20)	4,93	7,00	0,73 (0,33 - 2,05)	365	3,50	2,58	3,22			5,80 (1,40 - 7,00)	4,03	3,80	1,44 (0,33 - 1,95)	720	6,60			
16+25	1,60	2,50		4,10 (1,80 - 6,20)	4,66	7,00	0,88 (0,33 - 2,05)	440	4,10	2,42	3,78			6,20 (1,40 - 7,00)	3,95	3,80	1,57 (0,33 - 1,95)	785	7,20			
16+35	1,60	3,50		5,10 (1,80 - 6,30)	3,89	7,00	1,31 (0,33 - 2,06)	655	6,00	2,13	4,67			6,80 (1,40 - 7,30)	3,89	3,80	1,75 (0,29 - 2,05)	875	7,90			
16+42	1,43	3,77		5,20 (1,90 - 6,40)	3,85	7,00	1,35 (0,35 - 2,10)	675	6,20	1,88	4,92			6,80 (1,40 - 7,30)	3,98	3,80	1,71 (0,31 - 2,04)	855	7,80			
16+50	1,26	3,94		5,20 (1,90 - 6,80)	4,44	7,20	1,17 (0,34 - 2,04)	585	5,40	1,65	5,15			6,80 (1,40 - 8,00)	4,36	4,00	1,56 (0,27 - 2,15)	780	7,10			
20+20	2,00	2,00		4,00 (1,80 - 6,20)	4,71	7,00	0,85 (0,33 - 2,01)	425	4,00	3,20	3,20			6,40 (1,40 - 7,00)	3,93	3,80	1,63 (0,32 - 1,95)	815	7,40			
20+25	2,00	2,50		4,50 (1,80 - 6,20)	4,33	7,00	1,04 (0,33 - 2,01)	520	4,80	3,02	3,78			6,80 (1,40 - 7,00)	3,86	3,80	1,76 (0,29 - 1,95)	880	8,00			
20+35	1,89	3,31		5,20 (1,80 - 6,30)	3,85	7,00	1,35 (0,33 - 2,02)	675	6,20	2,47	4,33			6,80 (1,40 - 7,30)	3,98	3,80	1,71 (0,28 - 2,04)	855	7,80			
20+42	1,68	3,52		5,20 (1,90 - 6,40)	3,94	7,00	1,32 (0,35 - 2,06)	660	6,00	2,19	4,61			6,80 (1,40 - 7,30)	4,00	3,80	1,70 (0,30 - 2,00)	850	7,80			
20+50	1,49	3,71		5,20 (1,90 - 6,80)	4,44	7,20	1,17 (0,34 - 2,04)	585	5,40	1,94	4,86			6,80 (1,40 - 8,00)	4,36	4,00	1,56 (0,27 - 2,15)	780	7,10			
25+25	2,50	2,50		5,00 (1,80 - 6,20)	3,91	7,00	1,28 (0,33 - 2,01)	640	5,80	3,40	3,40			6,80 (1,40 - 7,00)	3,86	3,80	1,76 (0,29 - 1,95)	880	8,00			
25+35	2,17	3,03		5,20 (1,90 - 6,30)	3,85	7,00	1,35 (0,35 - 2,02)	675	6,20	2,83	3,97			6,80 (1,40 - 7,30)	3,98	3,80	1,71 (0,28 - 2,04)	855	7,80			
25+42	1,94	3,26		5,20 (1,90 - 6,40)	3,94	7,00	1,32 (0,35 - 2,06)	660	6,00	2,54	4,26			6,80 (1,40 - 7,30)	4,00	3,80	1,70 (0,28 - 2,00)	850	7,80			
25+50	1,73	3,47		5,20 (1,90 - 6,80)	4,44	7,20	1,17 (0,34 - 2,04)	585	5,40	2,27	4,53			6,80 (1,40 - 8,00)	4,36	4,00	1,56 (0,24 - 2,15)	780	7,10			
35+35	2,60	2,60		5,20 (1,90 - 6,40)	4,06	7,00	1,28 (0,35 - 2,02)	640	5,80	3,40	3,40			6,80 (1,40 - 7,50)	4,02	3,80	1,69 (0,27 - 2,06)	845	7,70			
35+42	2,36	2,84		5,20 (1,90 - 6,50)	4,06	7,00	1,28 (0,35 - 2,07)	640	5,80	3,09	3,71			6,80 (1,40 - 7,50)	4,02	3,80	1,69 (0,26 - 2,06)	845	7,70			
35+50	2,14	3,06		5,20 (1,90 - 6,90)	4,60	7,20	1,13 (0,36 - 2,04)	565	5,20	2,80	4,00			6,80 (1,40 - 8,00)	4,42	4,00	1,54 (0,24 - 2,08)	770	7,00			
42+42	2,60	2,60		5,20 (1,90 - 6,50)	4,06	7,00	1,28 (0,35 - 2,07)	640	5,80	3,40	3,40			6,80 (1,40 - 7,60)	4,12	3,80	1,65 (0,26 - 2,09)	825	7,50			
42+50	2,37	2,83		5,20 (1,90 - 6,90)	4,60	7,20	1,13 (0,36 - 2,04)	565	5,20	3,10	3,70			6,80 (1,40 - 8,00)	4,44	4,00	1,53 (0,24 - 2,08)	765	7,00			
3 Rooms																						
16+16+16	1,60	1,60	1,60	4,80 (1,80 - 7,20)	5,05	8,50	0,95 (0,36 - 2,13)	475	4,40	2,26	2,26	2,26		6,78 (1,50 - 8,10)	4,58	4,20	1,48 (0,29 - 2,10)	740	6,80			
16+16+20	1,60	1,60	2,00	5,20 (1,80 - 7,30)	4,77	8,50	1,09 (0,36 - 2,18)	545	5,00	2,09	2,09	2,62		6,80 (1,60 - 8,30)	4,63	4,20	1,47 (0,32 - 2,17)	735	6,70			
16+16+25	1,46	1,46	2,28	5,20 (1,90 - 7,20)	4,77	8,50	1,09 (0,39 - 2,09)	545	5,00	1,91	1,91	2,98		6,80 (1,60 - 8,30)	4,63	4,20	1,47 (0,32 - 2,17)	735	6,70			
16+16+35	1,24	1,24	2,72	5,20 (1,90 - 7,20)	4,77	8,50	1,09 (0,39 - 2,04)	545	5,00	1,62	1,62	3,56		6,80 (1,60 - 8,30)	4,69	4,20	1,45 (0,34 - 2,10)	725	6,60			
16+16+42	1,12	1,12	2,96	5,20 (1,80 - 7,30)	4,77	8,50	1,09 (0,39 - 2,09)	545	5,00	1,47	1,47	3,86		6,80 (1,60 - 8,30)	4,69	4,20	1,45 (0,31 - 2,10)	725	6,60			
16+16+50	1,01	1,01	3,18	5,20 (1,80 - 7,30)	5,15	8,50	1,01 (0,42 - 1,91)	505	4,70	1,33	1,33	4,14		6,80 (1,60 - 8,30)	5,07	4,20	1,34 (0,33 - 1,96)	670	6,10			
16+20+20	1,48	1,86	1,86	5,20 (1,90 - 7,20)	4,77	8,50	1,09 (0,39 - 2,09)	545	5,00	1,94	2,43	2,43		6,80 (1,60 - 8,30)	4,66	4,20	1,46 (0,31 - 2,12)	730	6,70			
16+20+25	1,36	1,70	2,14	5,20 (1,90 - 7,20)	4,77	8,50	1,09 (0,39 - 2,09)	545	5,00	1,78	2,23	2,79		6,80 (1,60 - 8,30)	4,66	4,20	1,46 (0,31 - 2,12)	730	6,70			
16+20+35	1,17	1,46	2,57	5,20 (1,90 - 7,20)	4,77	8,50	1,09 (0,39 - 2,00)	545	5,00	1,53	1,92	3,35		6,80 (1,60 - 8,30)	4,69	4,20	1,45 (0,34 - 2,10)	725	6,60			
16+20+42	1,07	1,33	2,80	5,20 (1,80 - 7,30)	4,77	8,50	1,09 (0,39 - 2,09)	545	5,00	1,39	1,74	3,67		6,80 (1,60 - 8,30)	4,72	4,20	1,44 (0,31 - 2,09)	720	6,60			
16+20+50	0,97	1,21	3,02	5,20 (1,80 - 7,30)	5,15	8,50	1,01 (0,42 - 1,86)	505	4,70	1,27	1,58	3,95		6,80 (1,60 - 8,30)	5,11	4,20	1,33 (0,34 - 1,95)	665	6,10			
16+25+25	1,26	1,97	1,97	5,20 (1,90 - 7,20)	4,77	8,50	1,09 (0,39 - 2,09)	545	5,00	1,64	2,58	2,58		6,80 (1,60 - 8,30)	4,66	4,20	1,46 (0,31 - 2,12)	730	6,70			
16+25+35	1,09	1,71	2,40	5,20 (1,80 - 7,30)	4,77	8,50	1,09 (0,39 - 2,09)	545	5,00	1,43	2,24	3,13		6,80 (1,60 - 8,30)	4,69	4,20	1,45 (0,34 - 2,10)	725	6,60			
16+25+42	1,00	1,57	2,63	5,20 (1,80 - 7,30)	4,77	8,50	1,09 (0,39 - 2,09)	545	5,00	1,31	2,05	3,44		6,80 (1,60 - 8,30)	4,72	4,20	1,44 (0,31 - 2,09)	720	6,60			
16+25+50	0,91	1,43	2,86	5,20 (1,80 - 7,30)	5,15	8,50	1,01 (0,42 - 1,86)	505	4,70	1,19	1,87	3,74		6,80 (1,60 - 8,30)	5,11	4,20	1,33 (0,34 - 1,95)	665	6,10			
16+35+35	0,96	2,12	2,12	5,20 (1,80 - 7,30)	4,95	8,50	1,05 (0,39 - 2,04)	525	4,80	1,26	2,77	2,77		6,80 (1,60 - 8,30)	4,76	4,20	1,43 (0,32 - 2,07)	715	6,50			
16+35+42	0,89	1,96	2,35	5,20 (1,80 - 7,30)	4,95	8,50	1,05 (0,39 - 2,04)	525	4,80	1,17	2,56	3,07		6,80 (1,60 - 8,30)	4,79	4,20	1,42 (0,32 - 2,06)	710	6,50			
20+20+20	1,73	1,73	1,73	5,19 (1,90 - 7,20)	4,76	8,50	1,09 (0,39 - 2,04)	545	5,00	2,26	2,26	2										

Free Multi R32 combinations table

Free Multi 3x1 CU-3Z68TBE. Minimum capacity connected: 4,50kW. Maximum capacity connected: 11,20kW • R32 GAS

Indoor unit capacity	Cooling capacity (kW). Rooms				EER	SEER ¹	Input power rating			A.E.C.	Current	Heating capacity (kW). Rooms				COP	SCOP ¹	Input power rating			A.E.C.	Current
	A	B	C	Total (Min-Max)			W/W	kW	kWh			230V	A	B	C			Total (Min-Max)	W/W	kW		
1 Room																						
16	1,60			1,60(1,30-2,30)	4,00		0,40(0,25-0,64)	200	2,00	2,60			2,60(1,20-3,20)	4,33			0,60(0,30-0,96)	300	3,00			
20	2,00			2,00(1,80-2,90)	4,00		0,50(0,34-0,81)	250	2,50	3,20			3,20(1,20-4,10)	4,32			0,74(0,30-1,23)	370	3,70			
25	2,50			2,50(1,80-2,90)	3,97		0,63(0,34-0,81)	315	3,20	3,60			3,60(1,20-4,30)	3,83			0,94(0,30-1,23)	470	4,70			
35	3,50			3,50(1,80-3,80)	3,72		0,94(0,34-1,36)	470	4,50	4,50			4,50(1,20-5,80)	3,66			1,23(0,30-2,10)	615	6,00			
42	4,20			4,20(1,80-4,30)	3,07		1,37(0,34-1,99)	685	6,40	5,60			5,60(1,20-6,80)	3,26			1,72(0,30-2,93)	860	8,00			
50	5,00			5,00(1,90-5,70)	3,23		1,55(0,34-2,13)	775	7,20	6,80			6,80(1,20-6,90)	3,24			2,10(0,30-2,52)	1050	9,70			
60	6,00			6,00(1,90-6,20)	2,96		2,03(0,34-2,33)	1015	9,20	8,50			8,50(1,30-9,00)	3,54			2,40(0,62-2,55)	1200	11,10			
2 Rooms																						
16+16	1,60	1,60		3,20(1,90-6,40)	5,71	6,10	0,56(0,27-2,12)	280	2,80	2,60	2,60		5,20(2,70-9,80)	4,00	3,80	1,30(0,66-3,01)	650	5,90				
16+20	1,60	2,00		3,60(1,90-6,40)	5,22	6,10	0,69(0,27-2,08)	345	3,40	2,58	3,22		5,80(2,70-9,80)	3,92	3,80	1,48(0,65-3,02)	740	6,80				
16+25	1,60	2,50		4,10(1,90-6,40)	4,94	6,10	0,83(0,27-2,08)	415	3,90	2,42	3,78		6,20(2,70-9,80)	3,85	3,80	1,61(0,65-3,02)	805	7,40				
16+35	1,60	3,50		5,10(1,90-6,90)	4,08	6,10	1,25(0,27-2,48)	625	5,70	2,23	4,87		7,10(2,70-9,90)	3,74	3,80	1,90(0,63-3,02)	950	8,60				
16+42	1,60	4,20		5,80(1,90-6,90)	3,60	6,10	1,61(0,27-2,44)	805	7,40	2,26	5,94		8,20(2,70-9,90)	3,52	3,80	2,33(0,63-3,02)	1165	10,50				
16+50	1,60	5,00		6,60(2,00-7,50)	3,63	6,50	1,82(0,28-2,52)	910	8,20	2,06	6,44		8,50(2,80-10,20)	3,76	3,80	2,26(0,56-2,99)	1130	10,20				
16+60	1,43	5,37		6,80(2,00-7,50)	3,49	6,50	1,95(0,28-2,52)	975	8,80	1,79	6,71		8,50(2,80-10,20)	3,76	3,80	2,26(0,56-2,99)	1130	10,20				
20+20	2,00	2,00		4,00(1,90-6,40)	5,00	6,10	0,80(0,27-2,04)	400	3,80	3,20	3,20		6,40(2,70-9,80)	3,83	3,80	1,67(0,64-3,02)	835	7,60				
20+25	2,00	2,50		4,50(1,90-6,40)	4,59	6,10	0,98(0,27-2,04)	490	4,60	3,02	3,78		6,80(2,70-9,80)	3,78	3,80	1,80(0,64-3,02)	900	8,10				
20+35	2,00	3,50		5,50(1,90-6,90)	3,85	6,10	1,43(0,27-2,44)	715	6,50	2,80	4,90		7,70(2,70-9,90)	3,65	3,80	2,11(0,63-3,02)	1055	9,50				
20+42	2,00	4,20		6,20(1,90-6,90)	3,35	6,10	1,85(0,27-2,40)	925	8,40	2,74	5,76		8,50(2,70-9,90)	3,48	3,80	2,44(0,62-3,03)	1220	11,00				
20+50	1,94	4,86		6,80(2,00-7,50)	3,49	6,50	1,95(0,28-2,48)	975	8,80	2,43	6,07		8,50(2,80-10,20)	3,76	3,80	2,26(0,56-2,99)	1130	10,20				
20+60	1,70	5,10		6,80(2,00-7,50)	3,49	6,50	1,95(0,28-2,48)	975	8,80	2,12	6,38		8,50(2,80-10,20)	3,76	3,80	2,26(0,56-2,99)	1130	10,20				
25+25	2,50	2,50		5,00(1,90-6,80)	4,13	6,10	1,21(0,27-2,43)	605	5,60	3,60	3,60		7,20(2,70-9,80)	3,71	3,80	1,94(0,64-3,02)	970	8,80				
25+35	2,50	3,50		6,00(1,90-6,90)	3,47	6,10	1,73(0,27-2,44)	865	7,90	3,37	4,73		8,10(2,70-9,90)	3,60	3,80	2,25(0,63-3,02)	1125	10,20				
25+42	2,50	4,20		6,70(1,90-6,90)	2,94	6,10	2,28(0,27-2,40)	1140	10,30	3,17	5,33		8,50(2,70-9,90)	3,48	3,80	2,44(0,62-3,03)	1220	11,00				
25+50	2,27	4,53		6,80(2,00-7,50)	3,49	6,50	1,95(0,26-2,48)	975	8,80	2,83	5,67		8,50(2,80-10,20)	3,76	3,80	2,26(0,56-2,99)	1130	10,20				
25+60	2,00	4,80		6,80(1,90-7,50)	3,49	6,50	1,95(0,26-2,48)	975	8,80	2,50	6,00		8,50(2,80-10,20)	3,76	3,80	2,26(0,56-2,99)	1130	10,20				
35+35	3,40	3,40		6,80(1,90-7,00)	2,97	6,10	2,29(0,27-2,40)	1145	10,40	4,25	4,25		8,50(2,80-10,00)	3,56	3,80	2,39(0,64-3,02)	1195	10,80				
35+42	3,09	3,71		6,80(1,90-7,10)	3,04	6,10	2,24(0,27-2,50)	1120	10,10	3,86	4,64		8,50(2,80-10,00)	3,56	3,80	2,39(0,60-3,02)	1195	10,80				
35+50	2,80	4,00		6,80(2,00-7,60)	3,64	6,50	1,87(0,28-2,48)	935	8,50	3,50	5,00		8,50(2,80-10,30)	3,86	3,80	2,26(0,54-2,97)	1100	10,00				
35+60	2,51	4,29		6,80(2,00-7,60)	3,64	6,50	1,87(0,28-2,48)	935	8,50	3,13	5,37		8,50(2,80-10,30)	3,86	3,80	2,20(0,54-2,97)	1100	10,00				
42+42	3,40	3,40		6,80(1,90-7,10)	3,02	6,10	2,25(0,26-2,45)	1125	10,20	4,25	4,25		8,50(2,80-10,00)	3,57	3,80	2,38(0,60-2,98)	1190	10,80				
42+50	3,10	3,70		6,80(2,00-7,60)	3,64	6,50	1,87(0,28-2,44)	935	8,50	3,88	4,62		8,50(2,80-10,30)	3,88	3,80	2,19(0,54-2,96)	1095	9,90				
42+60	2,80	4,00		6,80(2,00-7,60)	3,64	6,50	1,87(0,28-2,44)	935	8,50	3,50	5,00		8,50(2,80-10,30)	3,88	3,80	2,19(0,54-2,96)	1095	9,90				
50+50	3,40	3,40		6,80(2,10-8,10)	4,10	6,50	1,66(0,32-2,50)	830	7,60	4,25	4,25		8,50(2,80-10,50)	4,15	3,80	2,05(0,51-2,87)	1025	9,30				
50+60	3,09	3,71		6,80(2,10-8,10)	4,10	6,50	1,66(0,32-2,50)	830	7,60	3,86	4,64		8,50(2,80-10,50)	4,15	3,80	2,05(0,51-2,87)	1025	9,30				
3 Rooms																						
16+16+16	1,60	1,60	1,60	4,80(1,90-8,00)	4,85	8,00	0,99(0,27-2,56)	495	4,60	2,60	2,60	2,60	7,80(3,30-10,40)	3,98	4,20	1,96(0,64-2,95)	980	8,90				
16+16+20	1,60	1,60	2,00	5,20(1,90-8,00)	4,60	8,00	1,13(0,27-2,46)	565	5,20	2,58	2,58	3,24	8,40(3,30-10,40)	3,84	4,20	2,19(0,64-2,94)	1095	9,90				
16+16+25	1,60	1,60	2,50	5,70(1,90-8,00)	4,19	8,00	1,36(0,27-2,46)	680	6,20	2,39	2,39	3,72	8,50(3,30-10,40)	3,81	4,20	2,23(0,64-2,94)	1115	10,10				
16+16+35	1,60	1,60	3,50	6,70(1,90-8,00)	3,68	8,00	1,82(0,27-2,37)	910	8,20	2,03	2,03	4,44	8,50(3,30-10,40)	3,94	4,20	2,16(0,63-2,92)	1080	9,80				
16+16+42	1,47	1,47	3,86	6,80(1,90-8,10)	3,66	8,00	1,86(0,27-2,46)	930	8,40	1,84	1,84	4,82	8,50(3,30-10,50)	3,95	4,20	2,15(0,62-2,95)	1075	9,70				
16+16+50	1,33	1,33	4,14	6,80(2,00-8,50)	3,93	8,00	1,73(0,32-2,42)	865	7,90	1,66	1,66	5,18	8,50(3,20-10,60)	4,21	4,20	2,02(0,60-2,80)	1010	9,10				
16+16+60	1,18	1,18	4,44	6,80(2,00-8,50)	3,93	8,00	1,73(0,32-2,42)	865	7,90	1,48	1,48	5,54	8,50(3,20-10,60)	4,21	4,20	2,02(0,60-2,80)	1010	9,10				
16+20+20	1,60	2,00	2,00	5,60(1,90-8,00)	4,38	8,00	1,28(0,27-2,46)	640	5,80	2,42	3,04	3,04	8,50(3,30-10,40)	3,83	4,20	2,22(0,63-2,93)	1110	10,00				
16+20+25	1,60	2,00	2,50	6,10(1,90-8,00)	4,01	8,00	1,52(0,27-2,46)	760	6,90	2,23	2,79	3,48	8,50(3,30-10,40)	3,83	4,20	2,22(0,63-2,93)	1110	10,00				
16+20+35	1,53	1,92	3,35	6,80(1,90-8,00)	3,66	8,00	1,86(0,27-2,37)	930	8,40	1,92	2,39	4,19	8,50(3,30-10,40)	3,95	4,20	2,15(0,62-2,86)	1075	9,70				
16+20+42	1,39	1,74	3,67	6,80(1,90-8,10)	3,66	8,00	1,86(0,27-2,42)	930	8,40	1,74	2,18	4,58	8,50(3,30-10,50)	3,95	4,20	2,15(0,62-2,90)	1075	9,70				
16+20+50	1,27	1,58	3,95	6,80(2,00-8,50)	4,05	8,00	1,68(0,32-2,42)	840	7,70	1,58	1,98	4,94	8,50(3,20-10,60)	4,23	4,20	2,01(0,60-2,79)	1005	9,10				
16+20+60	1,13	1,42	4,25	6,80(2,00-8,50)	4,05	8,00	1,68(0,32-2,42)	840	7,70	1,42	1,77	5,31	8,50(3,20-10,60)	4,23	4,20	2,01(0,60-2,79)	1005	9,10				
16+25+25	1,60	2,50	2,50	6,60(1,90-8,00)	3,73	8,00	1,77(0,27-2															

Free Multi 3x1 CU-3Z68TBE. Minimum capacity connected: 4,50kW. Maximum capacity connected: 11,20kW • R32 GAS

Indoor unit capacity	Cooling capacity (kW). Rooms				EER	SEER ¹	Input power rating			A.E.C.	Current	Heating capacity (kW). Rooms				COP	SCOP ¹	Input power rating			A.E.C.	Current
	A	B	C	Total (Min - Max)			W/W	kW	kWh			230V	A	B	C			Total (Min - Max)	W/W	kW		
25+25+35	2,00	2,00	2,80	6,80 (1,90-8,00)	3,66	8,00	1,86	(0,27-2,32)	930	8,40	2,50	2,50	3,50	8,50 (3,30-10,40)	3,95	4,20	2,15	(0,62-2,85)	1075	9,70		
25+25+42	1,85	1,85	3,10	6,80 (1,90-8,10)	3,74	8,00	1,82	(0,29-2,42)	910	8,20	2,31	2,31	3,88	8,50 (3,30-10,50)	3,97	4,20	2,14	(0,62-2,89)	1070	9,70		
25+25+50	1,70	1,70	3,40	6,80 (2,00-8,50)	4,05	8,00	1,68	(0,34-2,38)	840	7,70	2,13	2,13	4,24	8,50 (3,20-10,60)	4,25	4,20	2,00	(0,60-2,78)	1000	9,00		
25+25+60	1,55	1,55	3,70	6,80 (2,00-8,50)	4,05	8,00	1,68	(0,34-2,38)	840	7,70	1,93	1,93	4,64	8,50 (3,20-10,60)	4,25	4,20	2,00	(0,60-2,78)	1000	9,00		
25+35+35	1,78	2,51	2,51	6,80 (1,90-8,10)	3,74	8,00	1,82	(0,29-2,33)	910	8,20	2,24	3,13	3,13	8,50 (3,30-10,50)	4,01	4,20	2,12	(0,64-2,87)	1060	9,60		
25+35+42	1,67	2,33	2,80	6,80 (1,90-8,20)	3,74	8,00	1,82	(0,29-2,42)	910	8,20	2,08	2,92	3,50	8,50 (3,30-10,50)	4,03	4,20	2,11	(0,64-2,86)	1055	9,50		
25+35+50	1,55	2,16	3,09	6,80 (2,00-8,50)	4,05	8,00	1,68	(0,34-2,33)	840	7,70	1,93	2,70	3,87	8,50 (3,20-10,60)	4,29	4,20	1,98	(0,60-2,76)	990	9,00		
25+42+42	1,56	2,62	2,62	6,80 (1,90-8,20)	3,84	8,00	1,77	(0,29-2,37)	885	8,00	1,94	3,28	3,28	8,50 (3,30-10,50)	4,05	4,20	2,10	(0,63-2,86)	1050	9,50		
35+35+35	2,26	2,26	2,26	6,78 (1,90-8,20)	3,83	8,00	1,77	(0,29-2,33)	885	8,00	2,83	2,83	2,83	8,49 (3,30-10,50)	4,12	4,20	2,06	(0,63-2,85)	1030	9,30		
35+35+42	2,13	2,13	2,54	6,80 (1,90-8,20)	3,84	8,00	1,77	(0,29-2,33)	885	8,00	2,66	2,66	3,18	8,50 (3,30-10,50)	4,15	4,20	2,05	(0,63-2,80)	1025	9,30		

1) Energy Label Scale from A+++ to D.

Free Multi 4x1 CU-4Z68TBE. Minimum capacity connected: 4,50kW. Maximum capacity connected: 11,50kW • R32 GAS

Indoor unit capacity	Cooling capacity (kW). Rooms					EER	SEER ¹	Input power rating			A.E.C.	Current	Heating capacity (kW). Rooms					COP	SCOP ¹	Input power rating			A.E.C.	Current	
	A	B	C	D	Total (Min - Max)			W/W	kW	kWh			230V	A	B	C	D			Total (Min - Max)	W/W	kW			kWh
1 Room																									
16	1,60				1,60 (1,30-2,30)	4,00	6,10	0,40	(0,25-0,64)	200	2,00	2,60			2,60 (1,20-3,20)	4,33	3,80	0,60	(0,30-0,96)	300	3,00				
20		2,00			2,00 (1,80-2,90)	4,00	6,10	0,50	(0,34-0,81)	250	2,50	3,20			3,20 (1,20-4,10)	4,32	3,80	0,74	(0,30-1,23)	370	3,70				
25			2,50		2,50 (1,80-2,90)	3,97	6,10	0,63	(0,34-0,81)	315	3,20	3,60			3,60 (1,20-4,30)	3,83	3,80	0,94	(0,30-1,23)	470	4,70				
35				3,50	3,50 (1,80-3,80)	3,72	6,10	0,94	(0,34-1,36)	470	4,50	4,50			4,50 (1,20-5,80)	3,66	3,80	1,23	(0,30-2,10)	615	6,00				
42				4,20	4,20 (1,80-4,30)	3,07	6,10	1,37	(0,34-1,99)	685	6,40	5,60			5,60 (1,20-6,80)	3,26	3,80	1,72	(0,30-2,93)	860	8,00				
50				5,00	5,00 (1,90-5,70)	3,23	6,10	1,55	(0,34-2,13)	775	7,20	6,80			6,80 (1,20-6,90)	3,24	3,80	2,10	(0,30-2,52)	1050	9,70				
60				6,00	6,00 (1,90-6,20)	2,96	6,10	2,03	(0,34-2,33)	1015	9,20	8,50			8,50 (1,30-9,00)	3,54	3,80	2,40	(0,62-2,55)	1200	11,10				
2 Rooms																									
16+16	1,60	1,60			3,20 (1,90-6,40)	5,71	6,10	0,56	(0,27-2,12)	280	2,80	2,60	2,60		2,60 (2,70-9,80)	4,00	3,80	1,30	(0,66-3,01)	650	5,90				
16+20	1,60	2,00			3,60 (1,90-6,40)	5,22	6,10	0,69	(0,27-2,08)	345	3,40	2,58	3,22		3,20 (2,70-9,80)	3,92	3,80	1,48	(0,65-3,02)	740	6,80				
16+25	1,60	2,50			4,10 (1,90-6,40)	4,94	6,10	0,83	(0,27-2,08)	415	3,90	2,42	3,78		3,20 (2,70-9,80)	3,85	3,80	1,61	(0,65-3,02)	805	7,40				
16+35	1,60	3,50			5,10 (1,90-6,90)	4,08	6,10	1,25	(0,27-2,48)	625	5,70	2,23	4,87		3,20 (2,70-9,80)	3,74	3,80	1,90	(0,63-3,02)	950	8,60				
16+42	1,60	4,20			5,80 (1,90-6,90)	3,60	6,10	1,61	(0,27-2,44)	805	7,40	2,26	5,94		3,20 (2,70-9,80)	3,52	3,80	2,33	(0,63-3,02)	1165	10,50				
16+50	1,60	5,00			6,60 (2,00-7,50)	3,63	6,50	1,82	(0,28-2,52)	910	8,20	2,06	6,44		3,20 (2,70-9,80)	3,76	3,80	2,26	(0,56-2,99)	1130	10,20				
16+60	1,43	5,37			6,80 (2,00-7,50)	3,49	6,50	1,95	(0,28-2,52)	975	8,80	1,79	6,71		3,20 (2,70-9,80)	3,76	3,80	2,26	(0,56-2,99)	1130	10,20				
20+20	2,00	2,00			4,00 (1,90-6,40)	5,00	6,10	0,80	(0,27-2,04)	400	3,80	3,20	3,20		3,20 (2,70-9,80)	3,83	3,80	1,67	(0,64-3,02)	835	7,60				
20+25	2,00	2,50			4,50 (1,90-6,40)	4,59	6,10	0,98	(0,27-2,04)	490	4,60	3,02	3,78		3,20 (2,70-9,80)	3,78	3,80	1,80	(0,64-3,02)	900	8,10				
20+35	2,00	3,50			5,50 (1,90-6,90)	3,85	6,10	1,43	(0,27-2,44)	715	6,50	2,80	4,90		3,20 (2,70-9,80)	3,65	3,80	2,11	(0,63-3,02)	1055	9,50				
20+42	2,00	4,20			6,20 (1,90-6,90)	3,35	6,10	1,85	(0,27-2,40)	925	8,40	2,74	5,76		3,20 (2,70-9,80)	3,48	3,80	2,44	(0,62-3,03)	1220	11,00				
20+50	1,94	4,86			6,80 (2,00-7,50)	3,49	6,50	1,95	(0,28-2,48)	975	8,80	2,43	6,07		3,20 (2,70-9,80)	3,76	3,80	2,26	(0,56-2,99)	1130	10,20				
20+60	1,70	5,10			6,80 (2,00-7,50)	3,49	6,50	1,95	(0,28-2,48)	975	8,80	2,12	6,38		3,20 (2,70-9,80)	3,76	3,80	2,26	(0,56-2,99)	1130	10,20				
25+25	2,50	2,50			5,00 (1,90-6,80)	4,13	6,10	1,21	(0,27-2,43)	605	5,60	3,60	3,60		3,20 (2,70-9,80)	3,71	3,80	1,94	(0,64-3,02)	970	8,80				
25+35	2,50	3,50			6,00 (1,90-6,90)	3,47	6,10	1,73	(0,27-2,44)	865	7,90	3,37	4,73		3,20 (2,70-9,80)	3,60	3,80	2,25	(0,63-3,02)	1125	10,20				
25+42	2,50	4,20			6,70 (1,90-6,90)	2,94	6,10	2,28	(0,27-2,40)	1140	10,30	3,17	5,33		3,20 (2,70-9,80)	3,48	3,80	2,44	(0,62-3,03)	1220	11,00				
25+50	2,27	4,53			6,80 (1,90-7,50)	3,49	6,50	1,95	(0,26-2,48)	975	8,80	2,83	5,67		3,20 (2,70-9,80)	3,76	3,80	2,26	(0,56-2,99)	1130	10,20				
25+60	2,00	4,80			6,80 (1,90-7,50)	3,49	6,50	1,95	(0,26-2,48)	975	8,80	2,50	6,00		3,20 (2,70-9,80)	3,76	3,80	2,26	(0,56-2,99)	1130	10,20				
35+35	3,40	3,40			6,80 (1,90-7,00)	2,97	6,10	2,29	(0,27-2,40)	1145	10,40	4,25	4,25		3,20 (2,70-9,80)	3,56	3,80	2,39	(0,64-3,02)	1195	10,80				
35+42	3,09	3,71			6,80 (1,90-7,10)	3,04	6,10	2,24	(0,27-2,50)	1120	10,10	3,86	4,64		3,20 (2,70-9,80)	3,56	3,80	2,39	(0,60-3,02)	1195	10,80				
35+50	2,80	4,00			6,80 (2,00-7,60)	3,64	6,50	1,87	(0,28-2,48)	935	8,50	3,50	5,00		3,20 (2,70-9,80)	3,86	3,80	2,20	(0,54-2,97)	1100	10,00				
35+60	2,51	4,29			6,80 (2,00-7,60)	3,64	6,50	1,87	(0,28-2,48)	935	8,50	3,13	5,37		3,20 (2,70-9,80)	3,86	3,80	2,20	(0,54-2,97)	1100	10,00				
42+42	3,40	3,40			6,80 (1,90-7,10)	3,02	6,10	2,25	(0,26-2,45)	1125	10,20	4,25	4,25		3,20 (2,70-9,80)	3,57	3,80	2,38	(0,60-2,98)	1190	10,80				
42+50	3,10	3,70			6,80 (2,00-7,60)	3,64	6,50	1,87	(0,28-2,44)	935	8,50	3,88	4,62		3,20 (2,70-9,80)	3,88	3,80	2,19	(0,54-2,96)	1095	9,90				
42+60	2,80	4,00			6,80 (2,00-7,60)	3,64	6,50	1,87	(0,28-2,44)	935	8,50	3,50	5,00		3,20 (2,70-9,80)	3,88	3,80	2,19	(0,54-2,96)	1095	9,90				
50+50	3,40	3,40			6,80 (2,10-8,10)	4,10	6,50	1,66	(0,32-2,50)	830	7,60	4,25	4,25		3,20 (2,70-9,80)	4,15	3,80	2,05	(0,51-2,87)	1025	9,30				
50+60	3,09	3,71			6,80 (2,10-8,10)	4,10	6,50	1,66	(0,32-2,50)	830	7,60	3,86	4,64		3,20 (2,70-9,80)	4,15	3,80	2,05	(0,51-2,87)	1025	9,30				
3 Rooms																									
16+16+16	1,60	1,60	1,60		4,80 (1,90-8,00)	4,85	8,00	0,99	(0,27-2,50)	495	4,60	2,60	2,60	2,60	2,60 (3,30-10,40)	3,98	4,00	1,96	(0,64-2,95)	980	8,90				
16+16+20	1,60	1,60	2,00		5,20 (1,90-8,00)	4,60	8,00	1,13	(0,27-2,46)	565	5,20	2,58	2,58	3,24	3,20 (3,30-10,40)	3,84	4,00	2,19	(0,64-2,94)	1095	9,90				
16+16+25	1,60	1,60	2,50		5,70 (1,90-8,00)	4,19	8,00	1,36	(0,27-2,46)	680	6,20	2,39</													

Free Multi R32 combinations table

Free Multi 4x1 CU-4Z68TBE. Minimum capacity connected: 4,50kW. Maximum capacity connected: 11,50kW • R32 GAS

Indoor unit capacity	Cooling capacity (kW). Rooms					EER	SEER ¹	Input power rating			A.E.C.	Current	Heating capacity (kW). Rooms					COP	SCOP ¹	Input power rating			A.E.C.	Current	
	A	B	C	D	Total (Min - Max)			W/W	kW	kWh			230V	A	B	C	D			Total (Min - Max)	W/W	kW			kWh
20+20+20	2,00	2,00	2,00		6,00(1,90-8,00)	4,05	8,00	1,48	(0,27-2,41)	740	6,80	2,83	2,83	2,83	8,49(3,30-10,40)	3,91	4,00	2,17	(0,63-2,92)	1085	9,80				
20+20+25	2,00	2,00	2,50		6,50(1,90-8,00)	3,76	8,00	1,73	(0,27-2,41)	865	7,90	2,62	2,62	3,26	8,50(3,30-10,40)	3,92	4,00	2,17	(0,63-2,92)	1085	9,80				
20+20+35	1,81	1,81	3,18		6,80(1,90-8,00)	3,66	8,00	1,86	(0,27-2,32)	930	8,40	2,27	2,27	3,96	8,50(3,30-10,40)	3,95	4,00	2,15	(0,62-2,85)	1075	9,70				
20+20+42	1,66	1,66	3,48		6,80(1,90-8,10)	3,74	8,00	1,82	(0,29-2,42)	910	8,20	2,07	2,07	4,36	8,50(3,30-10,50)	3,97	4,00	2,14	(0,62-2,89)	1070	9,70				
20+20+50	1,51	1,51	3,78		6,80(2,00-8,50)	4,05	8,00	1,68	(0,34-2,38)	840	7,70	1,89	1,89	4,72	8,50(3,20-10,60)	4,25	4,00	2,00	(0,60-2,78)	1000	9,00				
20+20+60	1,36	1,36	4,08		6,80(2,00-8,50)	4,05	8,00	1,68	(0,34-2,38)	840	7,70	1,70	1,70	5,10	8,50(3,20-10,60)	4,25	4,00	2,00	(0,60-2,78)	1000	9,00				
20+25+25	1,94	2,43	2,43		6,80(1,90-8,00)	3,66	8,00	1,86	(0,27-2,41)	930	8,40	2,42	3,04	3,04	8,50(3,30-10,40)	3,92	4,00	2,17	(0,63-2,92)	1085	9,80				
20+25+35	1,69	2,13	2,98		6,80(1,90-8,00)	3,66	8,00	1,86	(0,27-2,32)	930	8,40	2,12	2,66	3,72	8,50(3,30-10,40)	3,95	4,00	2,15	(0,62-2,85)	1075	9,70				
20+25+42	1,56	1,95	3,29		6,80(1,90-8,10)	3,74	8,00	1,82	(0,29-2,42)	910	8,20	1,95	2,44	4,11	8,50(3,30-10,50)	3,97	4,00	2,14	(0,62-2,89)	1070	9,70				
20+25+50	1,43	1,79	3,58		6,80(2,00-8,50)	4,05	8,00	1,68	(0,34-2,38)	840	7,70	1,79	2,24	4,47	8,50(3,20-10,60)	4,25	4,00	2,00	(0,60-2,78)	1000	9,00				
20+25+60	1,29	1,62	3,89		6,80(2,00-8,50)	4,05	8,00	1,68	(0,34-2,38)	840	7,70	1,62	2,02	4,86	8,50(3,20-10,60)	4,25	4,00	2,00	(0,60-2,78)	1000	9,00				
20+35+35	1,52	2,64	2,64		6,80(1,90-8,10)	3,74	8,00	1,82	(0,29-2,33)	910	8,20	1,88	3,31	3,31	8,50(3,30-10,50)	4,01	4,00	2,12	(0,64-2,87)	1060	9,60				
20+35+42	1,40	2,45	2,95		6,80(1,90-8,20)	3,74	8,00	1,82	(0,29-2,42)	910	8,20	1,75	3,07	3,68	8,50(3,30-10,50)	4,03	4,00	2,11	(0,64-2,86)	1055	9,50				
20+35+50	1,29	2,27	3,24		6,80(2,00-8,50)	4,05	8,00	1,68	(0,34-2,33)	840	7,70	1,62	2,83	4,05	8,50(3,20-10,60)	4,29	4,00	1,98	(0,60-2,76)	990	9,00				
20+35+60	1,18	2,07	3,55		6,80(2,00-8,50)	4,05	8,00	1,68	(0,34-2,33)	840	7,70	1,48	2,59	4,43	8,50(3,20-10,60)	4,29	4,00	1,98	(0,60-2,76)	990	9,00				
20+42+42	1,30	2,75	2,75		6,80(1,90-8,20)	3,84	8,00	1,77	(0,29-2,37)	885	8,00	1,64	3,43	3,43	8,50(3,30-10,50)	4,05	4,00	2,10	(0,63-2,86)	1050	9,50				
20+42+50	1,21	2,55	3,04		6,80(2,00-8,50)	4,05	8,00	1,68	(0,34-2,33)	840	7,70	1,52	3,19	3,79	8,50(3,20-10,60)	4,31	4,00	1,97	(0,62-2,75)	985	8,90				
25+25+25	2,26	2,26	2,26		6,78(1,90-8,00)	3,65	8,00	1,86	(0,27-2,41)	930	8,40	2,83	2,83	2,83	8,49(3,30-10,40)	3,91	4,00	2,17	(0,63-2,92)	1085	9,80				
25+25+35	2,00	2,00	2,80		6,80(1,90-8,00)	3,66	8,00	1,86	(0,27-2,32)	930	8,40	2,50	2,50	3,50	8,50(3,30-10,40)	3,95	4,00	2,15	(0,62-2,85)	1075	9,70				
25+25+42	1,85	1,85	3,10		6,80(1,90-8,10)	3,74	8,00	1,82	(0,29-2,42)	910	8,20	2,31	2,31	3,88	8,50(3,30-10,50)	3,97	4,00	2,14	(0,62-2,89)	1070	9,70				
25+25+50	1,70	1,70	3,40		6,80(2,00-8,50)	4,05	8,00	1,68	(0,34-2,38)	840	7,70	2,13	2,13	4,24	8,50(3,20-10,60)	4,25	4,00	2,00	(0,60-2,78)	1000	9,00				
25+25+60	1,55	1,55	3,70		6,80(2,00-8,50)	4,05	8,00	1,68	(0,34-2,38)	840	7,70	1,93	1,93	4,64	8,50(3,20-10,60)	4,25	4,00	2,00	(0,60-2,78)	1000	9,00				
25+35+35	1,78	2,51	2,51		6,80(1,90-8,10)	3,74	8,00	1,82	(0,29-2,33)	910	8,20	2,24	3,13	3,13	8,50(3,30-10,50)	4,01	4,00	2,12	(0,64-2,87)	1060	9,60				
25+35+42	1,67	2,33	2,80		6,80(1,90-8,20)	3,74	8,00	1,82	(0,29-2,42)	910	8,20	2,08	2,92	3,50	8,50(3,30-10,50)	4,03	4,00	2,11	(0,64-2,86)	1055	9,50				
25+35+50	1,55	2,16	3,09		6,80(2,00-8,50)	4,05	8,00	1,68	(0,34-2,33)	840	7,70	1,93	2,70	3,87	8,50(3,20-10,60)	4,29	4,00	1,98	(0,60-2,76)	990	9,00				
25+42+42	1,56	2,62	2,62		6,80(1,90-8,20)	3,84	8,00	1,77	(0,29-2,37)	885	8,00	1,94	3,28	3,28	8,50(3,30-10,50)	4,05	4,00	2,10	(0,63-2,86)	1050	9,50				
35+35+35	2,26	2,26	2,26		6,78(1,90-8,20)	3,83	8,00	1,77	(0,29-2,33)	885	8,00	2,83	2,83	2,83	8,49(3,30-10,50)	4,12	4,00	2,06	(0,63-2,85)	1030	9,30				
35+35+42	2,13	2,13	2,54		6,80(1,90-8,20)	3,84	8,00	1,77	(0,29-2,33)	885	8,00	2,66	2,66	3,18	8,50(3,30-10,50)	4,15	4,00	2,05	(0,63-2,80)	1025	9,30				
4 Rooms																									
16+16+16+16	1,65	1,65	1,65	1,65	6,60(1,90-8,70)	4,49	8,50	1,47	(0,34-2,38)	735	6,70	2,12	2,12	2,12	2,12	8,48(3,00-10,60)	4,44	4,20	1,91	(0,58-2,69)	955	8,60			
16+16+16+20	1,60	1,60	1,60	2,00	6,80(1,90-8,80)	4,39	8,00	1,55	(0,34-2,47)	775	7,00	2,00	2,00	2,50	8,50(3,00-10,60)	4,47	4,20	1,90	(0,58-2,68)	950	8,60				
16+16+16+25	1,49	1,49	1,49	2,33	6,80(1,90-8,80)	4,39	8,00	1,55	(0,34-2,47)	775	7,00	1,86	1,86	1,86	2,92	8,50(3,00-10,60)	4,47	4,20	1,90	(0,58-2,68)	950	8,60			
16+16+16+35	1,31	1,31	1,31	2,87	6,80(1,90-8,80)	4,39	8,00	1,55	(0,34-2,38)	775	7,00	1,64	1,64	1,64	3,58	8,50(3,00-10,60)	4,52	4,20	1,88	(0,58-2,66)	940	8,50			
16+16+16+42	1,21	1,21	1,21	3,17	6,80(1,90-8,80)	4,50	8,00	1,51	(0,34-2,38)	755	6,80	1,51	1,51	1,51	3,97	8,50(3,00-10,60)	4,55	4,20	1,87	(0,58-2,65)	935	8,50			
16+16+16+50	1,11	1,11	1,11	3,47	6,80(1,90-8,80)	4,50	8,00	1,51	(0,40-2,24)	755	6,80	1,39	1,39	1,39	4,33	8,50(3,00-10,60)	4,64	4,20	1,83	(0,65-2,55)	915	8,30			
16+16+16+60	1,01	1,01	1,01	3,77	6,80(1,90-8,80)	4,50	8,00	1,51	(0,40-2,24)	755	6,80	1,26	1,26	1,26	4,72	8,50(3,00-10,60)	4,64	4,20	1,83	(0,65-2,55)	915	8,30			
16+16+20+20	1,51	1,51	1,89	1,89	6,80(1,90-8,80)	4,39	8,00	1,55	(0,34-2,43)	775	7,00	1,89	1,89	2,36	2,36	8,50(3,10-10,60)	4,50	4,20	1,89	(0,60-2,67)	945	8,50			
16+16+20+25	1,41	1,41	1,77	2,21	6,80(1,90-8,80)	4,39	8,00	1,55	(0,34-2,43)	775	7,00	1,77	1,77	2,26	2,26	8,50(3,10-10,60)	4,50	4,20	1,89	(0,60-2,67)	945	8,50			
16+16+20+35	1,25	1,25	1,56	2,74	6,80(1,90-8,80)	4,50	8,00	1,51	(0,34-2,38)	755	6,80	1,56	1,56	1,95	3,43	8,50(3,00-10,60)	4,55	4,20	1,87	(0,58-2,65)	935	8,50			
16+16+20+42	1,16	1,16	1,44	3,04	6,80(1,90-8,80)	4,50	8,00	1,51	(0,37-2,38)	755	6,80	1,45	1,45	1,80	3,80	8,50(3,00-10,60)	4,57	4,20	1,86	(0,60-2,64)	930	8,40			
16+16+20+50	1,07	1,07	1,33	3,33	6,80(1,90-8,80)	4,50	8,00	1,51	(0,40-2,20)	755	6,80	1,33	1,33	1,67	4,17	8,50(3,00-10,60)	4,64	4,20	1,83	(0,66-2,54)	915	8,30			
16+16+20+60	0,97	0,97	1,21	3,65	6,80(1,90-8,80)	4,50	8,00	1,51	(0,40-2,20)	755	6,80	1,21	1,21	1,52	4,56	8,50(3,00-10,60)	4,64	4,20	1,83	(0,66-2,54)	915	8,30			
16+16+25+25	1,33	1,33	2,07	2,07	6,80(1,90-8,80)	4,39	8,00	1,55	(0,34-2,43)	775	7,00	1,66	1,66	2,59	2,59	8,50(3,10-10,60)	4,50	4,20	1,89	(0,60-2,67)	945	8,50			
16+16+25+35	1,18	1,18	1,85	2,59	6,80(1,90-8,80)	4,50	8,00	1,51	(0,34-2,38)	755	6,80	1,48	1,48	2,31	3,23	8,50(3,00-10,60)	4,55	4,20	1,87	(0,58-2,65)	935	8,50			
16+16+25+42	1,10	1,10	1,72	2,88	6,80(1,90-8,80)	4,50	8,00	1,51	(0,37-2,38)	755	6,80	1,37	1,37	2,15	3,61	8,50(3,00-10,60)	4,57	4,20	1,86	(0,60-2,64)	930	8,40			
16+16+25+50	1,02	1,02	1,58	3,18	6,80(1,90-8,80)	4,50	8,00	1,51	(0,40-2,20)	755	6,80	1,27	1,27	1,99	3,97	8,50(3,00-10,60)	4,64	4,20	1,83	(0,66-2,54)	915	8,30			
16+16+35+35	1,07	1,07	2,33	2,33	6,80(1,90-8,80)	4,50	8,00	1,51	(0,37-2,33)	755	6,80	1,33	1,33	2,92	2,92	8,50(3,00-10,60)	4,59	4,20	1,85	(0,61-2,62)	925	8,40			
16+16+35+42	1,00	1,00	2,18	2,62	6,80(1,90-8,80)	4,50	8,00	1,51	(0,37-2,33)	755	6,80	1,25	1,25	2,72	3,28	8,50(3,00-10,60)	4,62	4,60	1,84	(0,61-2,61)	920	8,30			
16+20+20+20	1,43	1,79	1,79	1,79	6,80(1,90-8,80)	4,39	8,00	1,55	(0,34-2,43)	775	7,00	1,78	2,24	2,24	2,24	8,50(3,10-10,60)	4,52	4,20	1,88	(0,60-2,67)	940	8,50			
16+20+20+25	1,34	1,68	1,68	2,10	6,80(1,90-8,80)	4,39	8,00	1,55	(0,34-2,43)	775	7,00	1,68	2,10	2,10	2,62	8,50(3,10-10,60)	4,52	4,20	1,88	(0,60-2,67)	940	8,50			
16+20+20+35	1,20	1,49	1,49	2,62	6,80(1,90-8,																				

Free Multi 4x1 CU-4Z80TBE. Minimum capacity connected: 4,50kW. Maximum capacity connected: 14,70kW • R32 GAS

Indoor unit capacity	Cooling capacity (kW). Rooms					EER	SEER ¹	Input power rating			A.E.C.	Current	Heating capacity (kW). Rooms					COP	SCOP ¹	Input power rating			A.E.C.	Current					
	A	B	C	D	Total (Min - Max)			W/W	kW	kWh			230V	A	B	C	D			Total (Min - Max)	W/W	kW			kWh	230V			
1 Room																													
16	1,60				1,60 (1,30 - 2,30)	4,00		0,40 (0,25 - 0,64)	200	2,00	2,60				2,60 (1,20 - 3,20)	4,33		0,60 (0,30 - 0,96)	300	3,00									
20	2,00				2,00 (1,80 - 2,90)	4,00		0,50 (0,34 - 0,81)	250	2,50	3,20				3,20 (1,20 - 4,10)	4,32		0,74 (0,30 - 1,23)	370	3,70									
25	2,50				2,50 (1,80 - 2,90)	3,97		0,63 (0,34 - 0,81)	315	3,20	3,60				3,60 (1,20 - 4,30)	3,83		0,94 (0,30 - 1,23)	470	4,70									
35	3,50				3,50 (1,80 - 4,10)	3,72		0,94 (0,34 - 1,36)	470	4,50	4,50				4,50 (1,20 - 5,80)	3,66		1,23 (0,30 - 2,10)	615	6,00									
42	4,20				4,20 (1,80 - 4,50)	3,07		1,37 (0,34 - 1,99)	685	6,40	5,60				5,60 (1,20 - 6,80)	3,26		1,72 (0,30 - 2,93)	860	8,00									
50	5,00				5,00 (1,90 - 5,70)	3,23		1,55 (0,34 - 2,13)	775	7,20	6,80				6,80 (1,20 - 6,90)	3,24		2,10 (0,30 - 2,52)	1050	9,70									
60	6,00				6,00 (1,90 - 6,20)	2,96		2,03 (0,34 - 2,33)	1015	9,20	8,50				8,50 (1,30 - 9,00)	3,54		2,40 (0,62 - 2,55)	1200	11,10									
71	7,10				7,10 (2,00 - 7,20)	2,81		2,53 (0,37 - 2,77)	1265	11,40	8,70				8,70 (1,40 - 9,20)	3,41		2,55 (0,68 - 2,72)	1275	11,80									
2 Rooms																													
16+16	1,60	1,60			3,20 (2,40 - 5,80)	4,38	5,60	0,73 (0,38 - 1,99)	365	3,70	2,60	2,60			5,20 (2,20 - 8,20)	3,33	3,90	1,56 (0,43 - 2,84)	780	7,40									
16+20	1,60	2,00			3,60 (2,40 - 5,80)	4,14	5,60	0,87 (0,38 - 1,99)	435	4,30	2,58	3,22			5,80 (2,20 - 8,20)	3,45	3,90	1,68 (0,43 - 2,83)	840	8,00									
16+25	1,60	2,50			4,10 (2,40 - 5,80)	3,83	5,60	1,07 (0,38 - 1,99)	535	5,20	2,42	3,78			6,20 (2,20 - 8,20)	3,41	3,90	1,82 (0,43 - 2,83)	910	8,60									
16+35	1,60	3,50			5,10 (2,40 - 5,80)	3,45	5,60	1,48 (0,37 - 1,92)	740	7,20	2,23	4,87			7,10 (2,20 - 8,60)	3,57	3,90	1,99 (0,38 - 2,91)	995	9,40									
16+42	1,60	4,20			5,80 (2,40 - 6,70)	3,19	5,60	1,82 (0,37 - 2,48)	910	8,70	2,26	5,94			8,20 (2,20 - 9,80)	3,46	3,90	2,37 (0,37 - 3,44)	1185	11,10									
16+50	1,60	5,00			6,60 (2,40 - 7,20)	3,20	6,10	2,06 (0,35 - 2,48)	1030	9,90	2,28	7,12			9,40 (2,20 - 10,00)	3,82	4,10	2,46 (0,32 - 3,25)	1230	11,60									
16+60	1,60	6,00			7,60 (2,40 - 8,50)	2,83	6,10	2,69 (0,35 - 3,49)	1345	12,90	1,98	7,42			9,40 (2,20 - 10,00)	3,82	4,10	2,46 (0,33 - 3,25)	1230	11,60									
16+71	1,47	6,53			8,00 (2,50 - 8,50)	2,82	6,10	2,84 (0,38 - 3,34)	1420	13,60	1,73	7,67			9,40 (2,20 - 10,30)	3,92	4,10	2,40 (0,32 - 3,42)	1200	11,30									
20+20	2,00	2,00			4,00 (2,40 - 5,80)	3,96	5,60	1,01 (0,38 - 1,93)	505	5,00	3,20	3,20			6,40 (2,20 - 8,20)	3,44	3,90	1,86 (0,39 - 2,82)	930	8,70									
20+25	2,00	2,50			4,50 (2,40 - 5,80)	3,63	5,60	1,24 (0,38 - 1,93)	620	6,00	3,02	3,78			6,80 (2,20 - 8,20)	3,54	3,90	1,92 (0,39 - 2,82)	960	9,00									
20+35	2,00	3,50			5,50 (2,40 - 5,80)	3,33	5,60	1,65 (0,37 - 1,86)	825	8,00	2,80	4,90			7,70 (2,20 - 8,60)	3,55	3,90	2,17 (0,37 - 2,85)	1085	10,20									
20+42	2,00	4,20			6,20 (2,40 - 7,20)	3,00	5,60	2,07 (0,37 - 2,90)	1035	9,90	2,84	5,96			8,80 (2,20 - 10,00)	3,64	3,90	2,42 (0,37 - 3,55)	1210	11,40									
20+50	2,00	5,00			7,00 (2,40 - 8,10)	3,17	6,10	2,21 (0,35 - 3,10)	1105	10,60	2,69	6,71			9,40 (2,20 - 10,00)	3,84	4,10	2,45 (0,32 - 3,23)	1225	11,50									
20+60	2,00	6,00			8,00 (2,40 - 8,50)	2,75	6,10	2,91 (0,35 - 3,49)	1455	13,90	2,35	7,05			9,40 (2,20 - 10,00)	3,84	4,10	2,45 (0,32 - 3,23)	1225	11,50									
20+71	1,76	6,24			8,00 (2,50 - 8,50)	2,89	6,10	2,77 (0,38 - 3,34)	1385	13,30	2,07	7,33			9,40 (2,20 - 10,30)	3,93	4,10	2,39 (0,32 - 3,40)	1195	11,20									
25+25	2,50	2,50			5,00 (2,40 - 5,80)	3,50	5,60	1,43 (0,38 - 1,93)	715	6,90	3,60	3,60			7,20 (2,20 - 8,60)	3,51	3,90	2,05 (0,39 - 2,93)	1025	9,60									
25+35	2,50	3,50			6,00 (2,40 - 6,70)	3,09	5,60	1,94 (0,37 - 2,48)	970	9,30	3,37	4,73			8,10 (2,20 - 9,80)	3,49	3,90	2,32 (0,37 - 3,44)	1160	10,90									
25+42	2,50	4,20			6,70 (2,40 - 7,20)	2,78	5,60	2,41 (0,37 - 2,90)	1205	11,50	3,43	5,77			9,20 (2,20 - 10,00)	3,58	3,90	2,57 (0,37 - 3,55)	1285	12,10									
25+50	2,50	5,00			7,50 (2,40 - 8,50)	2,94	6,10	2,55 (0,35 - 3,49)	1275	12,20	3,13	6,27			9,40 (2,20 - 10,00)	3,84	4,10	2,45 (0,32 - 3,23)	1225	11,50									
25+60	2,35	5,65			8,00 (2,50 - 8,50)	2,75	6,10	2,91 (0,39 - 3,49)	1455	13,90	2,76	6,64			9,40 (2,20 - 10,00)	3,84	4,10	2,45 (0,32 - 3,23)	1225	11,50									
25+71	2,08	5,92			8,00 (2,50 - 8,50)	2,89	6,10	2,77 (0,38 - 3,34)	1385	13,30	2,45	6,95			9,40 (2,20 - 10,30)	3,93	4,10	2,39 (0,32 - 3,40)	1195	11,20									
35+35	3,50	3,50			7,00 (2,40 - 8,10)	2,75	5,60	2,55 (0,37 - 3,63)	1275	12,20	4,50	4,50			9,00 (2,20 - 10,00)	3,67	3,90	2,45 (0,36 - 3,47)	1225	11,50									
35+42	3,50	4,20			7,70 (2,40 - 8,50)	2,53	5,60	3,04 (0,37 - 4,12)	1520	14,60	4,27	5,13			9,40 (2,20 - 10,00)	3,63	3,90	2,59 (0,35 - 3,46)	1295	12,20									
35+50	3,29	4,71			8,00 (2,50 - 8,50)	2,89	6,10	2,77 (0,38 - 3,34)	1385	13,30	3,87	5,53			9,40 (2,20 - 10,00)	3,95	4,10	2,38 (0,32 - 3,20)	1190	11,20									
35+60	2,95	5,05			8,00 (2,50 - 8,50)	2,89	6,10	2,77 (0,38 - 3,34)	1385	13,30	3,46	5,94			9,40 (2,20 - 10,30)	3,95	4,10	2,38 (0,32 - 3,32)	1190	11,20									
35+71	2,64	5,36			8,00 (2,50 - 8,60)	2,96	6,10	2,70 (0,38 - 3,34)	1350	12,90	3,10	6,30			9,40 (2,20 - 10,50)	3,98	4,10	2,36 (0,31 - 3,43)	1180	11,10									
42+42	4,00	4,00			8,00 (2,50 - 8,50)	2,40	5,60	3,34 (0,40 - 4,04)	1670	16,00	4,70	4,70			9,40 (2,20 - 10,00)	3,64	3,90	2,56 (0,35 - 3,45)	1290	12,10									
42+50	3,65	4,35			8,00 (2,50 - 8,50)	2,89	6,10	2,77 (0,38 - 3,34)	1385	13,30	4,29	5,11			9,40 (2,20 - 10,30)	3,98	4,10	2,36 (0,32 - 3,31)	1180	11,10									
42+60	3,29	4,71			8,00 (2,50 - 8,60)	2,89	6,10	2,77 (0,38 - 3,42)	1385	13,30	3,87	5,53			9,40 (2,20 - 10,30)	3,98	4,10	2,36 (0,32 - 3,31)	1180	11,10									
42+71	2,97	5,03			8,00 (2,50 - 8,60)	2,96	6,10	2,70 (0,38 - 3,26)	1350	12,90	3,49	5,91			9,40 (2,20 - 10,50)	4,00	4,10	2,35 (0,31 - 3,42)	1175	11,00									
50+50	4,00	4,00			8,00 (2,50 - 8,60)	3,31	6,10	2,42 (0,38 - 2,95)	1210	11,60	4,70	4,70			9,40 (2,20 - 10,30)	4,27	4,10	2,20 (0,31 - 3,09)	1100	10,30									
50+60	3,64	4,36			8,00 (2,50 - 8,60)	3,31	6,10	2,42 (0,38 - 2,95)	1210	11,60	4,27	5,13			9,40 (2,20 - 10,50)	4,27	4,10	2,20 (0,31 - 3,15)	1100	10,30									
50+71	3,31	4,69			8,00 (2,50 - 8,60)	3,40	6,10	2,35 (0,38 - 2,88)	1175	11,20	3,88	5,52			9,40 (2,20 - 10,50)	4,31	4,10	2,18 (0,31 - 3,13)	1090	10,20									
60+60	4,00	4,00			8,00 (2,50 - 8,60)	3,31	6,10	2,42 (0,38 - 2,95)	1210	11,60	4,70	4,70			9,40 (2,20 - 10,50)</														

Free Multi R32 combinations table

Free Multi 4x1 CU-4Z80TBE. Minimum capacity connected: 4,50kW. Maximum capacity connected: 14,70kW • R32 GAS

Indoor unit capacity	Cooling capacity (kW). Rooms					EER	SEER ¹	Input power rating			A.E.C.	Current	Heating capacity (kW). Rooms					COP	SCOP ¹	Input power rating			A.E.C.	Current
	A	B	C	D	Total (Min-Max)			W/W	kW	kWh			230V	A	B	C	D			Total (Min-Max)	W/W	kW		
16+50+60	1.02	3.17	3.81		8,00(3,00-9,00)	4,17	7,40	1,92(0,57-2,65)	960	9,20	1,19	3,73	4,48	9,40(3,20-10,60)	4,70	4,40	2,00(0,57-2,93)	1000	9,40					
16+50+71	0,93	2,92	4,15		8,00(3,00-9,00)	4,17	7,40	1,92(0,57-2,65)	960	9,20	1,10	3,43	4,87	9,40(3,20-10,60)	4,72	4,40	1,99(0,59-2,92)	995	9,40					
16+60+60	0,94	3,53	3,53		8,00(3,00-9,00)	4,17	7,40	1,92(0,57-2,65)	960	9,20	1,10	4,15	4,15	9,40(3,20-10,60)	4,70	4,40	2,00(0,57-2,93)	1000	9,40					
16+60+71	0,87	3,27	3,86		8,00(3,00-9,00)	4,17	7,40	1,92(0,57-2,65)	960	9,20	1,02	3,84	4,54	9,40(3,20-10,60)	4,72	4,40	1,99(0,59-2,92)	995	9,40					
20+20+20	2,00	2,00	2,00		6,00(3,00-8,50)	4,00	7,40	1,50(0,48-3,03)	750	7,30	3,13	3,13	3,13	9,39(3,20-10,40)	4,15	4,30	2,26(0,49-3,24)	1130	10,60					
20+20+25	2,00	2,00	2,50		6,50(3,00-8,50)	3,76	7,40	1,73(0,48-3,03)	865	8,40	2,89	2,89	3,62	9,40(3,20-10,40)	4,16	4,30	2,26(0,49-3,24)	1130	10,60					
20+20+35	2,00	2,00	3,50		7,50(3,00-8,50)	3,64	7,40	2,06(0,48-2,95)	1030	9,90	2,51	2,51	4,38	9,40(3,20-10,40)	4,22	4,30	2,23(0,49-3,20)	1115	10,50					
20+20+42	1,95	1,95	4,10		8,00(3,00-8,60)	3,49	7,40	2,29(0,48-3,03)	1145	11,00	2,29	2,29	4,82	9,40(3,20-10,40)	4,23	4,40	2,22(0,48-3,19)	1110	10,40					
20+20+50	1,78	1,78	4,44		8,00(3,00-8,60)	3,92	7,40	2,04(0,52-2,65)	1020	9,80	2,09	2,09	5,22	9,40(3,20-10,50)	4,45	4,40	2,11(0,51-3,03)	1055	9,90					
20+20+60	1,60	1,60	4,80		8,00(3,00-8,80)	3,92	7,40	2,04(0,52-2,80)	1020	9,80	1,88	1,88	5,64	9,40(3,20-10,50)	4,45	4,40	2,11(0,51-3,03)	1055	9,90					
20+20+71	1,44	1,44	5,12		8,00(3,00-8,80)	3,92	7,40	2,04(0,52-2,72)	1020	9,80	1,69	1,69	6,02	9,40(3,20-10,60)	4,48	4,40	2,10(0,51-3,08)	1050	9,90					
20+25+25	2,00	2,50	2,50		7,00(3,00-8,50)	3,70	7,40	1,89(0,48-3,03)	945	9,00	2,68	3,36	3,36	9,40(3,20-10,40)	4,16	4,30	2,26(0,49-3,24)	1130	10,60					
20+25+35	2,00	2,50	3,50		8,00(3,00-8,60)	3,49	7,40	2,29(0,48-3,03)	1145	11,00	2,35	2,94	4,11	9,40(3,20-10,40)	4,22	4,40	2,23(0,49-3,20)	1115	10,50					
20+25+42	1,84	2,30	3,86		8,00(3,00-8,60)	3,49	7,40	2,29(0,48-3,03)	1145	11,00	2,16	2,70	4,54	9,40(3,20-10,50)	4,23	4,40	2,22(0,48-3,25)	1110	10,40					
20+25+50	1,68	2,11	4,21		8,00(3,00-8,60)	3,92	7,40	2,04(0,52-2,65)	1020	9,80	1,98	2,47	4,95	9,40(3,20-10,50)	4,45	4,40	2,11(0,51-3,03)	1055	9,90					
20+25+60	1,52	1,90	4,58		8,00(3,00-8,80)	3,92	7,40	2,04(0,52-2,80)	1020	9,80	1,79	2,24	5,37	9,40(3,20-10,50)	4,45	4,40	2,11(0,51-3,03)	1055	9,90					
20+25+71	1,38	1,72	4,90		8,00(3,00-8,80)	3,92	7,40	2,04(0,52-2,72)	1020	9,80	1,62	2,03	5,75	9,40(3,20-10,60)	4,48	4,40	2,10(0,51-3,08)	1050	9,90					
20+35+35	1,78	3,11	3,11		8,00(3,00-8,60)	3,59	7,40	2,23(0,48-2,95)	1115	10,70	2,08	3,66	3,66	9,40(3,20-10,50)	4,27	4,40	2,20(0,48-3,16)	1100	10,30					
20+35+42	1,65	2,89	3,46		8,00(3,00-8,60)	3,59	7,40	2,23(0,48-2,95)	1115	10,70	1,94	3,39	4,07	9,40(3,20-10,50)	4,29	4,40	2,19(0,48-3,15)	1095	10,30					
20+35+50	1,52	2,67	3,81		8,00(3,00-8,80)	3,92	7,40	2,04(0,52-2,80)	1020	9,80	1,79	3,13	4,48	9,40(3,20-10,50)	4,50	4,40	2,09(0,51-3,00)	1045	9,80					
20+35+60	1,39	2,43	4,18		8,00(3,00-8,80)	3,92	7,40	2,04(0,52-2,80)	1020	9,80	1,63	2,86	4,91	9,40(3,20-10,60)	4,50	4,40	2,09(0,51-3,06)	1045	9,80					
20+35+71	1,27	2,22	4,51		8,00(3,00-9,00)	4,04	7,40	1,98(0,52-2,80)	990	9,50	1,49	2,61	5,30	9,40(3,20-10,60)	4,54	4,40	2,07(0,51-3,04)	1035	9,70					
20+42+42	1,54	3,23	3,23		8,00(3,00-8,80)	3,59	7,40	2,23(0,48-3,03)	1115	10,70	1,80	3,80	3,80	9,40(3,20-10,50)	4,31	4,40	2,18(0,48-3,14)	1090	10,20					
20+42+50	1,43	3,00	3,57		8,00(3,00-8,80)	3,92	7,40	2,04(0,52-2,72)	1020	9,80	1,68	3,53	4,19	9,40(3,20-10,60)	4,52	4,40	2,08(0,51-3,05)	1040	9,80					
20+42+60	1,31	2,75	3,94		8,00(3,00-9,00)	3,92	7,40	2,04(0,52-2,87)	1020	9,80	1,54	3,24	4,62	9,40(3,20-10,60)	4,52	4,40	2,08(0,51-3,05)	1040	9,80					
20+42+71	1,20	2,53	4,27		8,00(3,00-9,00)	4,04	7,40	1,98(0,52-2,80)	990	9,50	1,41	2,97	5,02	9,40(3,20-10,60)	4,54	4,40	2,07(0,52-3,03)	1035	9,70					
20+50+50	1,33	3,33	3,33		7,99(3,00-9,00)	4,16	7,40	1,92(0,57-2,65)	960	9,20	1,56	3,92	3,92	9,40(3,20-10,60)	4,72	4,40	1,99(0,59-2,92)	995	9,40					
20+50+60	1,23	3,08	3,69		8,00(3,00-9,00)	4,17	7,40	1,92(0,57-2,65)	960	9,20	1,45	3,62	4,33	9,40(3,20-10,60)	4,72	4,40	1,99(0,59-2,92)	995	9,40					
20+50+71	1,13	2,84	4,03		8,00(3,00-9,00)	4,17	7,40	1,92(0,57-2,65)	960	9,20	1,33	3,33	4,74	9,40(3,20-10,60)	4,75	4,40	1,98(0,60-2,91)	990	9,30					
20+60+60	1,14	3,43	3,43		8,00(3,00-9,00)	4,17	7,40	1,92(0,57-2,65)	960	9,20	1,34	4,03	4,03	9,40(3,20-10,60)	4,72	4,40	1,99(0,59-2,92)	995	9,40					
25+25+25	2,50	2,50	2,50		7,50(3,00-8,50)	3,52	7,40	2,13(0,48-3,03)	1065	10,20	3,13	3,13	3,13	9,39(3,20-10,40)	4,15	4,30	2,26(0,49-3,24)	1130	10,60					
25+25+35	2,35	2,35	3,30		8,00(3,00-8,60)	3,49	7,40	2,29(0,48-3,03)	1145	11,00	2,76	2,76	3,88	9,40(3,20-10,40)	4,22	4,40	2,23(0,49-3,20)	1115	10,50					
25+25+42	2,17	2,17	3,66		8,00(3,00-8,60)	3,49	7,40	2,29(0,48-3,03)	1145	11,00	2,55	2,55	4,30	9,40(3,20-10,50)	4,40	4,40	2,22(0,48-3,25)	1110	10,40					
25+25+50	2,00	2,00	4,00		8,00(3,00-8,80)	3,92	7,40	2,04(0,52-2,80)	1020	9,80	2,35	2,35	4,70	9,40(3,20-10,50)	4,45	4,40	2,11(0,51-3,03)	1055	9,90					
25+25+60	1,82	1,82	4,36		8,00(3,00-8,80)	3,92	7,40	2,04(0,52-2,80)	1020	9,80	2,14	2,14	5,12	9,40(3,20-10,50)	4,45	4,40	2,11(0,51-3,03)	1055	9,90					
25+25+71	1,65	1,65	4,70		8,00(3,00-9,00)	3,92	7,40	2,04(0,52-2,87)	1020	9,80	1,94	1,94	5,52	9,40(3,20-10,60)	4,48	4,40	2,10(0,51-3,08)	1050	9,90					
25+35+35	2,10	2,95	2,95		8,00(3,00-8,60)	3,59	7,40	2,23(0,48-2,95)	1115	10,70	2,48	3,46	3,46	9,40(3,20-10,50)	4,27	4,40	2,20(0,48-3,16)	1100	10,30					
25+35+42	1,96	2,75	3,29		8,00(3,00-8,80)	3,59	7,40	2,23(0,48-3,10)	1115	10,70	2,30	3,23	3,87	9,40(3,20-10,50)	4,29	4,40	2,19(0,48-3,15)	1095	10,30					
25+35+50	1,82	2,55	3,63		8,00(3,00-8,80)	3,92	7,40	2,04(0,52-2,80)	1020	9,80	2,14	2,99	4,27	9,40(3,20-10,50)	4,50	4,40	2,09(0,51-3,00)	1045	9,80					
25+35+60	1,67	2,33	4,00		8,00(3,00-9,00)	3,92	7,40	2,04(0,52-2,87)	1020	9,80	1,96	2,74	4,70	9,40(3,20-10,60)	4,50	4,40	2,09(0,51-3,06)	1045	9,80					
25+35+71	1,53	2,14	4,33		8,00(3,00-9,00)	4,04	7,40	1,98(0,52-2,80)	990	9,50	1,79	2,51	5,10	9,40(3,20-10,60)	4,54	4,40	2,07(0,51-3,04)	1035	9,70					
25+42+42	1,84	3,08	3,08		8,00(3,00-8,80)	3,59	7,40	2,23(0,48-3,03)	1115	10,70	2,16	3,62	3,62	9,40(3,20-10,50)	4,31	4,40	2,18(0,48-3,14)	1090	10,20					
25+42+50	1,71	2,87	3,42		8,00(3,00-8,80)	3,92	7,40	2,04(0,52-2,72)	1020	9,80	2,01	3,37	4,02	9,40(3,20-10,60)	4,52	4,40	2,08(0,51-3,05)	1040	9,80					
25+42+60	1,57	2,65	3,78		8,00(3,00-9,00)	3,92	7,40	2,04(0,52-2,87)	1020	9,80	1,85	3,11	4,44	9,40(3,20-10,60)	4,52	4,40	2,08(0,51-3,05)	1040	9,80					
25+42+71	1,45	2,43	4,12		8,00(3,00-9,00)	4,04	7,40	1,98(0,52-2,80)	990	9,50	1,70	2,86	4,84	9,40(3,20-10,60)	4,54	4,40	2,07(0,52-3,03)	1035	9,70					
25+50+50	1,60	3,20	3,20		8,00(3,00-9,00)	4,17	7,40	1,92(0,57-2,65)	960	9,20	1,88	3,76	3,76	9,40(3,20-10,60)	4,72	4,40	1,99(0,59-2,92)	995	9,40					
25+50+60	1,48	2,96	3,56		8,00(3,00-9,00)	4,17	7,40	1,92(0,57-2,65)	960	9,20	1,74	3,48	4,18	9,40(3,20-10,60)	4,72	4,40	1,99(0,59-2,92)	995	9,40					
25+50+71	1,37	2,74	3,89		8,00(3,00-9,00)	4,17	7,40	1,92(0,57-2,65)	960	9,20	1,61	3,22	4,57	9,40(3,20-10,60)	4,75	4,40	1,98(0,60-2,91)	990	9,30					
25+60+60	1,38	3,31	3,31		8,00(3,00-9,00)	4,17	7,40	1,92(0,57-2,65)	960	9,20	1,62	3,89	3,89	9,40(3,20-10,60)	4,72	4,40	1,99(0,59-2,92)	995	9,40					
35+35+35	2,66	2,66	2,66		7,98(3,00-8,80)	3,68	7,40	2,17(0,48-3,03)	1085	10,40	3,13	3,13	3,13	9,39(3,20-10,50)	4,31	4,40	2,18(0,48-3,13)	1090	10,20					
35+35+42	2,50	2,50	3,00		8,00(3,00-8,80)	3,69	7,40	2,17(0,48-3,03)	1085	10,40	2,94	2,94	3,52	9,40(3,20-10,60)	4,33	4,40	2,17(0,48-3,17)	1085	10,20					
35+35+50	2,33	2,33	3,33		7,99(3,00-9,00)	4,04	7,40	1,98(0,52-2,87)	990	9,50	2,74	2,74	3,92	9,40(3,20-10,60)	4,56	4,40	2,06(0,52-3,03)	1030	9,70					
35+35+60	2,15	2,15	3,70		8,00(3,00-9,00)	4,04	7,40	1,98(0,52-2,87)	990	9,5														

Free Multi 4x1 CU-4Z80TBE. Minimum capacity connected: 4.50kW. Maximum capacity connected: 14.70kW • R32 GAS

Indoor unit capacity	Cooling capacity (kW). Rooms					EER	SEER ¹	Input power rating			A.E.C.	Current	Heating capacity (kW). Rooms					COP	SCOP ¹	Input power rating			A.E.C.	Current
	A	B	C	D	Total (Min - Max)			W/W	kW				230V	A	B	C	D			Total (Min - Max)	W/W	kW		
16+16+20+71	1.04	1.04	1.30	4.62	8.00(3.00-9.20)	4.28	7.90	1.87	(0.62-2.66)	935	9.00	1.22	1.22	1.53	5.43	9.40(4.20-10.60)	4.75	4.70	1.98	(0.79-2.90)	990	9.30		
16+16+25+25	1.56	1.56	2.44	2.44	8.00(3.00-9.20)	4.04	7.90	1.98	(0.53-2.87)	990	9.50	1.83	1.83	2.87	2.87	9.40(4.20-10.60)	4.59	4.70	2.05	(0.68-3.01)	1025	9.60		
16+16+25+35	1.39	1.39	2.17	3.05	8.00(3.00-9.20)	4.17	7.90	1.92	(0.53-2.87)	960	9.20	1.63	1.63	2.55	3.59	9.40(4.20-10.60)	4.63	4.70	2.03	(0.69-2.98)	1015	9.50		
16+16+25+42	1.29	1.29	2.02	3.40	8.00(3.00-9.20)	4.17	7.90	1.92	(0.56-2.87)	960	9.20	1.52	1.52	2.37	3.99	9.40(4.20-10.60)	4.65	4.70	2.02	(0.71-2.97)	1010	9.50		
16+16+25+50	1.20	1.20	1.87	3.73	8.00(3.00-9.20)	4.28	7.90	1.87	(0.62-2.65)	935	9.00	1.41	1.41	2.20	4.38	9.40(4.20-10.60)	4.72	4.70	1.99	(0.77-2.85)	995	9.40		
16+16+25+60	1.09	1.09	1.71	4.11	8.00(3.00-9.20)	4.28	7.90	1.87	(0.62-2.65)	935	9.00	1.29	1.29	2.01	4.81	9.40(4.20-10.60)	4.72	4.70	1.99	(0.77-2.85)	995	9.40		
16+16+25+71	1.00	1.00	1.56	4.44	8.00(3.00-9.20)	4.28	7.90	1.87	(0.62-2.66)	935	9.00	1.18	1.18	1.84	5.20	9.40(4.20-10.60)	4.75	4.70	1.98	(0.79-2.90)	990	9.30		
16+16+35+35	1.25	1.25	2.75	2.75	8.00(3.00-9.20)	4.17	7.90	1.92	(0.57-2.80)	960	9.20	1.47	1.47	3.23	3.23	9.40(4.20-10.60)	4.68	4.70	2.01	(0.72-2.95)	1005	9.40		
16+16+35+42	1.17	1.17	2.57	3.09	8.00(3.00-9.20)	4.17	7.90	1.92	(0.57-2.80)	960	9.20	1.38	1.38	3.02	3.62	9.40(4.20-10.60)	4.70	4.70	2.00	(0.72-2.94)	1000	9.40		
16+16+35+50	1.09	1.09	2.39	3.43	8.00(3.00-9.20)	4.28	7.90	1.87	(0.62-2.66)	935	9.00	1.29	1.29	2.81	4.01	9.40(4.20-10.60)	4.75	4.70	1.98	(0.80-2.89)	990	9.30		
16+16+35+60	1.01	1.01	2.20	3.78	8.00(3.00-9.20)	4.28	7.90	1.87	(0.62-2.66)	935	9.00	1.18	1.18	2.59	4.45	9.40(4.20-10.60)	4.75	4.70	1.98	(0.80-2.89)	990	9.30		
16+16+35+71	0.93	0.93	2.03	4.11	8.00(3.00-9.20)	4.28	7.90	1.87	(0.63-2.66)	935	9.00	1.09	1.09	2.38	4.84	9.40(4.20-10.60)	4.77	4.70	1.97	(0.80-2.87)	985	9.30		
16+16+42+42	1.10	1.10	2.90	2.90	8.00(3.00-9.20)	4.17	7.90	1.92	(0.57-2.80)	960	9.20	1.30	1.30	3.40	3.40	9.40(4.20-10.60)	4.70	4.70	2.00	(0.72-2.93)	1000	9.40		
16+16+42+50	1.03	1.03	2.71	3.23	8.00(3.00-9.20)	4.28	7.90	1.87	(0.62-2.66)	935	9.00	1.21	1.21	3.18	3.80	9.40(4.20-10.60)	4.77	4.70	1.97	(0.80-2.88)	985	9.30		
16+16+42+60	0.96	0.96	2.51	3.57	8.00(3.00-9.20)	4.28	7.90	1.87	(0.62-2.66)	935	9.00	1.12	1.12	2.95	4.21	9.40(4.20-10.60)	4.77	4.70	1.97	(0.80-2.88)	985	9.30		
16+16+42+71	0.88	0.88	2.32	3.92	8.00(3.00-9.20)	4.28	7.90	1.87	(0.63-2.66)	935	9.00	1.04	1.04	2.72	4.60	9.40(4.20-10.60)	4.77	4.70	1.97	(0.81-2.87)	985	9.30		
16+16+50+50	0.97	0.97	3.03	3.03	8.00(3.00-9.20)	4.26	7.90	1.88	(0.69-2.60)	940	9.00	1.14	1.14	3.56	3.56	9.40(4.20-10.60)	4.68	4.70	2.01	(0.92-2.85)	1005	9.40		
16+16+50+60	0.90	0.90	2.82	3.38	8.00(3.00-9.20)	4.26	7.90	1.88	(0.69-2.60)	940	9.00	1.06	1.06	3.31	3.97	9.40(4.20-10.60)	4.68	4.70	2.01	(0.92-2.85)	1005	9.40		
16+20+20+20	1.60	2.00	2.00	2.00	7.60(3.00-9.20)	4.06	7.90	1.87	(0.53-2.87)	935	9.00	1.99	2.47	2.47	2.47	9.40(4.20-10.60)	4.61	4.70	2.04	(0.69-3.00)	1020	9.60		
16+20+20+25	1.58	1.98	1.98	2.46	8.00(3.00-9.20)	4.04	7.90	1.98	(0.53-2.87)	990	9.50	1.86	2.32	2.32	2.90	9.40(4.20-10.60)	4.61	4.70	2.04	(0.69-3.00)	1020	9.60		
16+20+20+35	1.41	1.76	1.76	3.07	8.00(3.00-9.20)	4.17	7.90	1.92	(0.57-2.80)	960	9.20	1.65	2.07	2.07	3.61	9.40(4.20-10.60)	4.65	4.70	2.02	(0.71-2.97)	1010	9.50		
16+20+20+42	1.31	1.63	1.63	3.43	8.00(3.00-9.20)	4.17	7.90	1.92	(0.57-2.80)	960	9.20	1.53	1.92	1.92	4.03	9.40(4.20-10.60)	4.68	4.70	2.01	(0.71-2.96)	1005	9.40		
16+20+20+50	1.21	1.51	1.51	3.77	8.00(3.00-9.20)	4.28	7.90	1.87	(0.62-2.65)	935	9.00	1.42	1.77	1.77	4.44	9.40(4.20-10.60)	4.72	4.70	1.99	(0.79-2.90)	995	9.40		
16+20+20+60	1.10	1.38	1.38	4.14	8.00(3.00-9.20)	4.28	7.90	1.87	(0.62-2.65)	935	9.00	1.30	1.62	1.62	4.86	9.40(4.20-10.60)	4.72	4.70	1.99	(0.79-2.90)	995	9.40		
16+20+20+71	1.01	1.26	1.26	4.47	8.00(3.00-9.20)	4.28	7.90	1.87	(0.63-2.66)	935	9.00	1.18	1.48	1.48	5.26	9.40(4.20-10.60)	4.75	4.70	1.98	(0.80-2.89)	990	9.30		
16+20+25+25	1.48	1.86	2.33	2.33	8.00(3.00-9.20)	4.04	7.90	1.98	(0.53-2.87)	990	9.50	1.75	2.19	2.73	2.73	9.40(4.20-10.60)	4.61	4.70	2.04	(0.69-3.00)	1020	9.60		
16+20+25+35	1.33	1.67	2.08	2.92	8.00(3.00-9.20)	4.17	7.90	1.92	(0.57-2.80)	960	9.20	1.57	1.96	2.45	3.42	9.40(4.20-10.60)	4.65	4.70	2.02	(0.71-2.97)	1010	9.50		
16+20+25+42	1.24	1.55	1.94	3.27	8.00(3.00-9.20)	4.17	7.90	1.92	(0.57-2.80)	960	9.20	1.46	1.83	2.28	3.83	9.40(4.20-10.60)	4.68	4.70	2.01	(0.71-2.96)	1005	9.40		
16+20+25+50	1.15	1.44	1.80	3.61	8.00(3.00-9.20)	4.28	7.90	1.87	(0.62-2.65)	935	9.00	1.35	1.69	2.12	4.24	9.40(4.20-10.60)	4.72	4.70	1.99	(0.79-2.90)	995	9.40		
16+20+25+60	1.06	1.32	1.65	3.97	8.00(3.00-9.20)	4.28	7.90	1.87	(0.62-2.65)	935	9.00	1.24	1.55	1.94	4.67	9.40(4.20-10.60)	4.72	4.70	1.99	(0.79-2.90)	995	9.40		
16+20+25+71	0.97	1.21	1.52	4.30	8.00(3.00-9.20)	4.28	7.90	1.87	(0.63-2.66)	935	9.00	1.14	1.42	1.78	5.06	9.40(4.20-10.60)	4.75	4.70	1.98	(0.80-2.89)	990	9.30		
16+20+35+35	1.21	1.51	2.64	2.64	8.00(3.00-9.20)	4.17	7.90	1.92	(0.57-2.80)	960	9.20	1.42	1.78	3.10	3.10	9.40(4.20-10.60)	4.70	4.70	2.00	(0.72-2.94)	1000	9.40		
16+20+35+42	1.13	1.42	2.48	2.97	8.00(3.00-9.20)	4.17	7.90	1.92	(0.57-2.80)	960	9.20	1.33	1.66	2.91	3.50	9.40(4.20-10.60)	4.70	4.70	2.00	(0.72-2.93)	1000	9.40		
16+20+35+50	1.06	1.32	2.31	3.31	8.00(3.00-9.20)	4.28	7.90	1.87	(0.63-2.66)	935	9.00	1.24	1.55	2.72	3.89	9.40(4.20-10.60)	4.77	4.70	1.97	(0.80-2.88)	985	9.30		
16+20+35+60	0.98	1.22	2.14	3.66	8.00(3.00-9.20)	4.28	7.90	1.87	(0.63-2.66)	935	9.00	1.15	1.44	2.51	4.30	9.40(4.20-10.60)	4.77	4.70	1.97	(0.80-2.88)	985	9.30		
16+20+35+71	0.90	1.13	1.97	4.00	8.00(3.00-9.20)	4.28	7.90	1.87	(0.63-2.66)	935	9.00	1.06	1.32	2.32	4.70	9.40(4.20-10.60)	4.77	4.70	1.97	(0.81-2.87)	985	9.30		
16+20+42+42	1.07	1.33	2.80	2.80	8.00(3.00-9.20)	4.17	7.90	1.92	(0.57-2.80)	960	9.20	1.25	1.57	3.29	3.29	9.40(4.20-10.60)	4.72	4.70	1.99	(0.72-2.92)	995	9.40		
16+20+42+50	1.00	1.25	2.63	3.12	8.00(3.00-9.20)	4.28	7.90	1.87	(0.63-2.66)	935	9.00	1.18	1.47	3.08	3.67	9.40(4.20-10.60)	4.77	4.70	1.97	(0.81-2.87)	985	9.30		
16+20+42+60	0.93	1.16	2.43	3.48	8.00(3.00-9.20)	4.28	7.90	1.87	(0.63-2.66)	935	9.00	1.09	1.36	2.86	4.09	9.40(4.20-10.60)	4.77	4.70	1.97	(0.81-2.87)	985	9.30		
16+20+50+50	0.94	1.18	2.94	2.94	8.00(3.00-9.20)	4.23	7.90	1.89	(0.69-2.60)	945	9.00	1.10	1.38	3.46	3.46	9.40(4.20-10.60)	4.68	4.70	2.01	(0.93-2.90)	1005	9.40		
16+20+50+60	0.88	1.10	2.74	3.28	8.00(3.00-9.20)	4.23	7.90	1.89	(0.69-2.60)	945	9.00	1.03	1.29	3.22	3.86	9.40(4.20-10.60)	4.68	4.70	2.01	(0.93-2.90)	1005	9.40		
16+25+25+25	1.40	2.20	2.20	2.20	8.00(3.00-9.20)	4.04	7.90	1.98	(0.53-2.87)	990	9.50	1.66	2.58	2.58	2.58	9.40(4.20-10.60)	4.61	4.70	2.04	(0.69-3.00)	1020	9.60		
16+25+25+35	1.27	1.98	1.98	2.77	8.00(3.00-9.20)	4.17	7.90	1.92	(0.57-2.80)	960	9.20	1.49	2.33	2.33	3.25	9.40(4.20-10.60)	4.65	4.70	2.02	(0.71-2.97)	1010	9.50		
16+25+25+42	1.19	1.85	1.85	3.11	8.00(3.00-9.20)	4.17	7.90	1.92	(0.57-2.80)	960	9.20	1.39	2.18	2.18	3.65	9.40(4.20-10.60)	4.68	4.70	2.01	(0.71-2.96)	1005	9.40		
16+25+25+50	1.10	1.72	1.72	3.46	8.00(3.00-9.20)	4.28	7.90	1.87	(0.62-2.65)	935	9.00	1.30	2.03	2.03	4.04	9.40(4.20-10.60)	4.72	4.70	1.99	(0.79-2.90)	995	9.40		
16+25+25+60	1.02	1.59	1.59	3.80	8.00(3.00-9.20)	4.28	7.90	1.87	(0.62-2.65)	935	9.00	1.19	1.87	1.87	4.47	9.40(4.20-10.60)	4.72	4.70	1.99	(0.79-2.90)	995	9.40		
16+25+25+71	0.93	1.46	1.46	4.15	8.00(3.00-9.20)	4.28	7.90	1.87	(0.63-2.66)	935	9.00	1.10	1.72	1.72	4.86	9.40(4.20-10.60)	4.75	4.70	1.98	(0.80-2.89)	990	9.30		
16+25+35+35	1.15	1.81	2.52	2.52	8.00(3.00-9.20)	4.17	7.90	1.92	(0.57-2.80)	960	9.20	1.35	2.13	2.96	2.96	9.40(4.20-10								

Free Multi R32 combinations table

Free Multi 4x1 CU-4Z80TBE. Minimum capacity connected: 4,50kW. Maximum capacity connected: 14,70kW • R32 GAS

Indoor unit capacity	Cooling capacity (kW). Rooms					EER	SEER ¹⁾	Input power rating			Heating capacity (kW). Rooms					COP	SCOP ¹⁾	Input power rating			A.E.C.	Current
	A	B	C	D	Total (Min - Max)			W/W	kW	kWh	230V	A	B	C	D			Total (Min - Max)	W/W	kW		
20+20+35+50	1,28	1,28	2,24	3,20	8,00(3,00-9,20)	4,28	7,90	1,87(0,63-2,66)	935	9,00	1,50	1,50	2,63	3,77	9,40(4,20-10,60)	4,77	4,70	1,97(0,81-2,87)	985	9,30		
20+20+35+60	1,19	1,19	2,07	3,55	8,00(3,00-9,20)	4,28	7,90	1,87(0,63-2,66)	935	9,00	1,39	1,39	2,44	4,18	9,40(4,20-10,60)	4,77	4,70	1,97(0,81-2,87)	985	9,30		
20+20+35+71	1,10	1,10	1,92	3,88	8,00(3,00-9,20)	4,28	7,90	1,87(0,63-2,66)	935	9,00	1,29	1,29	2,25	4,57	9,40(4,20-10,60)	4,70	4,70	2,00(0,83-2,86)	1000	9,40		
20+20+42+42	1,29	1,29	2,71	2,71	8,00(3,00-9,20)	4,17	7,90	1,92(0,57-2,80)	960	9,20	1,52	1,52	3,18	3,18	9,40(4,20-10,60)	4,75	4,70	1,98(0,72-2,91)	990	9,30		
20+20+42+50	1,21	1,21	2,55	3,03	8,00(3,00-9,20)	4,28	7,90	1,87(0,63-2,66)	935	9,00	1,42	1,42	2,99	3,57	9,40(4,20-10,60)	4,70	4,70	2,00(0,81-2,86)	1000	9,40		
20+20+42+60	1,13	1,13	2,37	3,37	8,00(3,00-9,20)	4,28	7,90	1,87(0,63-2,66)	935	9,00	1,32	1,32	2,78	3,98	9,40(4,20-10,60)	4,70	4,70	2,00(0,81-2,86)	1000	9,40		
20+20+50+50	1,14	1,14	2,86	2,86	8,00(3,00-9,20)	4,23	7,90	1,89(0,70-2,60)	945	9,00	1,34	1,34	3,36	3,36	9,40(4,20-10,60)	4,68	4,70	2,01(0,94-2,89)	1005	9,40		
20+25+25+25	1,67	2,11	2,11	2,11	8,00(3,00-9,20)	4,04	7,90	1,98(0,53-2,87)	990	9,50	1,99	2,47	2,47	2,47	9,40(4,20-10,60)	4,63	4,70	2,03(0,69-2,99)	1015	9,50		
20+25+25+35	1,52	1,90	1,90	2,68	8,00(3,00-9,20)	4,17	7,90	1,92(0,57-2,80)	960	9,20	1,79	2,24	2,24	3,13	9,40(4,20-10,60)	4,68	4,70	2,01(0,71-2,96)	1005	9,40		
20+25+25+42	1,43	1,79	1,79	2,99	8,00(3,00-9,20)	4,17	7,90	1,92(0,57-2,80)	960	9,20	1,68	2,10	2,10	3,52	9,40(4,20-10,60)	4,68	4,70	2,01(0,72-2,95)	1005	9,40		
20+25+25+50	1,33	1,67	1,67	3,33	8,00(3,00-9,20)	4,28	7,90	1,87(0,62-2,65)	935	9,00	1,57	1,96	1,96	3,91	9,40(4,20-10,60)	4,75	4,70	1,98(0,80-2,89)	990	9,30		
20+25+25+60	1,23	1,54	1,54	3,69	8,00(3,00-9,20)	4,28	7,90	1,87(0,62-2,65)	935	9,00	1,45	1,81	1,81	4,33	9,40(4,20-10,60)	4,75	4,70	1,98(0,80-2,89)	990	9,30		
20+25+25+71	1,13	1,42	1,42	4,03	8,00(3,00-9,20)	4,28	7,90	1,87(0,63-2,66)	935	9,00	1,33	1,67	1,67	4,73	9,40(4,20-10,60)	4,77	4,70	1,97(0,80-2,88)	985	9,30		
20+25+35+35	1,39	1,75	2,43	2,43	8,00(3,00-9,20)	4,17	7,90	1,92(0,57-2,80)	960	9,20	1,63	2,05	2,86	2,86	9,40(4,20-10,60)	4,70	4,70	2,00(0,72-2,93)	1000	9,40		
20+25+35+42	1,31	1,64	2,30	2,75	8,00(3,00-9,20)	4,17	7,90	1,92(0,57-2,80)	960	9,20	1,54	1,93	2,70	3,23	9,40(4,20-10,60)	4,72	4,70	1,99(0,72-2,92)	995	9,40		
20+25+35+50	1,23	1,54	2,15	3,08	8,00(3,00-9,20)	4,28	7,90	1,87(0,63-2,66)	935	9,00	1,45	1,81	2,53	3,61	9,40(4,20-10,60)	4,77	4,70	1,97(0,81-2,87)	985	9,30		
20+25+35+60	1,14	1,43	2,00	3,43	8,00(3,00-9,20)	4,28	7,90	1,87(0,63-2,66)	935	9,00	1,34	1,68	2,35	4,03	9,40(4,20-10,60)	4,77	4,70	1,97(0,81-2,87)	985	9,30		
20+25+42+42	1,24	1,56	2,60	2,60	8,00(3,00-9,20)	4,17	7,90	1,92(0,57-2,80)	960	9,20	1,46	1,82	3,06	3,06	9,40(4,20-10,60)	4,75	4,70	1,98(0,72-2,91)	990	9,30		
20+25+42+50	1,17	1,46	2,45	2,92	8,00(3,00-9,20)	4,28	7,90	1,87(0,63-2,66)	935	9,00	1,37	1,72	2,88	3,43	9,40(4,20-10,60)	4,70	4,70	2,00(0,81-2,86)	1000	9,40		
20+25+42+60	1,09	1,36	2,29	3,26	8,00(3,00-9,20)	4,28	7,90	1,87(0,63-2,66)	935	9,00	1,28	1,60	2,69	3,83	9,40(4,20-10,60)	4,70	4,70	2,00(0,81-2,86)	1000	9,40		
20+25+50+50	1,10	1,38	2,76	2,76	8,00(3,00-9,20)	4,23	7,90	1,89(0,70-2,60)	945	9,00	1,30	1,62	3,24	3,24	9,40(4,20-10,60)	4,68	4,70	2,01(0,94-2,89)	1005	9,40		
20+35+35+35	1,28	2,24	2,24	2,24	8,00(3,00-9,20)	4,17	7,90	1,92(0,57-2,72)	960	9,20	1,51	2,63	2,63	2,63	9,40(4,20-10,60)	4,75	4,70	1,98(0,75-2,90)	990	9,30		
20+35+35+42	1,21	2,12	2,12	2,55	8,00(3,00-9,20)	4,17	7,90	1,92(0,57-2,72)	960	9,20	1,42	2,49	2,49	3,00	9,40(4,20-10,60)	4,77	4,70	1,97(0,75-2,89)	985	9,30		
20+35+35+50	1,14	2,00	2,00	2,86	8,00(3,00-9,20)	4,28	7,90	1,87(0,63-2,66)	935	9,00	1,34	2,35	2,35	3,36	9,40(4,20-10,60)	4,70	4,70	2,00(0,84-2,85)	1000	9,40		
20+35+42+42	1,15	2,01	2,42	2,42	8,00(3,00-9,20)	4,17	7,90	1,92(0,57-2,72)	960	9,20	1,35	2,37	2,84	2,84	9,40(4,20-10,60)	4,77	4,70	1,97(0,76-2,88)	985	9,30		
20+35+42+50	1,09	1,90	2,29	2,72	8,00(3,00-9,20)	4,28	7,90	1,87(0,63-2,66)	935	9,00	1,28	2,24	2,69	3,19	9,40(4,20-10,60)	4,72	4,70	1,99(0,85-2,84)	995	9,40		
20+42+42+42	1,10	2,30	2,30	2,30	8,00(3,00-9,20)	4,28	7,90	1,87(0,58-2,72)	935	9,00	1,30	2,70	2,70	2,70	9,40(4,20-10,60)	4,70	4,70	2,00(0,76-2,87)	1000	9,40		
25+25+25+25	2,00	2,00	2,00	2,00	8,00(3,00-9,20)	4,04	7,90	1,98(0,53-2,87)	990	9,50	2,35	2,35	2,35	2,35	9,40(4,20-10,60)	4,63	4,70	2,03(0,69-2,99)	1015	9,50		
25+25+25+35	1,82	1,82	1,82	2,54	8,00(3,00-9,20)	4,17	7,90	1,92(0,57-2,80)	960	9,20	2,14	2,14	2,14	2,98	9,40(4,20-10,60)	4,68	4,70	2,01(0,71-2,96)	1005	9,40		
25+25+25+42	1,71	1,71	1,71	2,87	8,00(3,00-9,20)	4,17	7,90	1,92(0,57-2,80)	960	9,20	2,01	2,01	2,01	3,37	9,40(4,20-10,60)	4,68	4,70	2,01(0,72-2,95)	1005	9,40		
25+25+25+50	1,60	1,60	1,60	3,20	8,00(3,00-9,20)	4,28	7,90	1,87(0,62-2,65)	935	9,00	1,88	1,88	1,88	3,76	9,40(4,20-10,60)	4,75	4,70	1,98(0,80-2,89)	990	9,30		
25+25+25+60	1,48	1,48	1,48	3,56	8,00(3,00-9,20)	4,28	7,90	1,87(0,62-2,65)	935	9,00	1,74	1,74	1,74	4,18	9,40(4,20-10,60)	4,75	4,70	1,98(0,80-2,89)	990	9,30		
25+25+25+71	1,37	1,37	1,37	3,89	8,00(3,00-9,20)	4,28	7,90	1,87(0,63-2,66)	935	9,00	1,61	1,61	1,61	4,57	9,40(4,20-10,60)	4,77	4,70	1,97(0,80-2,88)	985	9,30		
25+25+35+35	1,67	1,67	2,33	2,33	8,00(3,00-9,20)	4,17	7,90	1,92(0,57-2,80)	960	9,20	1,96	1,96	2,74	2,74	9,40(4,20-10,60)	4,70	4,70	2,00(0,72-2,93)	1000	9,40		
25+25+35+42	1,57	1,57	2,20	2,66	8,00(3,00-9,20)	4,17	7,90	1,92(0,57-2,80)	960	9,20	1,85	1,85	2,59	3,11	9,40(4,20-10,60)	4,72	4,70	1,99(0,72-2,92)	995	9,40		
25+25+35+50	1,48	1,48	2,07	2,97	8,00(3,00-9,20)	4,28	7,90	1,87(0,63-2,66)	935	9,00	1,74	1,74	2,44	3,48	9,40(4,20-10,60)	4,77	4,70	1,97(0,81-2,87)	985	9,30		
25+25+35+60	1,38	1,38	1,93	3,31	8,00(3,00-9,20)	4,28	7,90	1,87(0,63-2,66)	935	9,00	1,62	1,62	2,27	3,89	9,40(4,20-10,60)	4,77	4,70	1,97(0,81-2,87)	985	9,30		
25+25+42+42	1,49	1,49	2,51	2,51	8,00(3,00-9,20)	4,17	7,90	1,92(0,57-2,80)	960	9,20	1,75	1,75	2,95	2,95	9,40(4,20-10,60)	4,75	4,70	1,98(0,72-2,91)	990	9,30		
25+25+42+50	1,41	1,41	2,37	2,81	8,00(3,00-9,20)	4,28	7,90	1,87(0,63-2,66)	935	9,00	1,65	1,65	2,78	3,32	9,40(4,20-10,60)	4,70	4,70	2,00(0,81-2,86)	1000	9,40		
25+35+35+35	1,55	2,15	2,15	2,15	8,00(3,00-9,20)	4,17	7,90	1,92(0,57-2,72)	960	9,20	1,81	2,53	2,53	2,53	9,40(4,20-10,60)	4,75	4,70	1,98(0,75-2,90)	990	9,30		
25+35+35+42	1,46	2,04	2,04	2,46	8,00(3,00-9,20)	4,17	7,90	1,92(0,57-2,72)	960	9,20	1,72	2,40	2,40	2,88	9,40(4,20-10,60)	4,77	4,70	1,97(0,75-2,89)	985	9,30		
25+35+35+50	1,38	1,93	1,93	2,76	8,00(3,00-9,20)	4,28	7,90	1,87(0,63-2,66)	935	9,00	1,62	2,27	2,27	3,24	9,40(4,20-10,60)	4,70	4,70	2,00(0,84-2,85)	1000	9,40		
25+35+42+42	1,39	1,95	2,33	2,33	8,00(3,00-9,20)	4,17	7,90	1,92(0,57-2,72)	960	9,20	1,63	2,29	2,74	2,74	9,40(4,20-10,60)	4,77	4,70	1,97(0,76-2,88)	985	9,30		
35+35+35+35	2,00	2,00	2,00	2,00	8,00(3,00-9,20)	4,28	7,90	1,87(0,58-2,72)	935	9,00	2,35	2,35	2,35	2,35	9,40(4,20-10,60)	4,70	4,70	2,00(0,76-2,87)	1000	9,40		
35+35+35+42	1,90	1,90	1,90	2,30	8,00(3,00-9,20)	4,28	7,90	1,87(0,58-2,72)	935	9,00	2,24	2,24	2,24	2,68	9,40(4,20-10,60)	4,70	4,70	2,00(0,76-2,86)	1000			

Free Multi 5x1 CU-5Z90TBE. Minimum capacity connected: 4,50kW. Maximum capacity connected: 18,30kW • R32 GAS

Indoor unit capacity	Cooling capacity (kW). Rooms					EER	SEER ¹	Input power rating			A.E.C.	Current	Heating capacity (kW). Rooms					COP	SCOP ¹	Input power rating			A.E.C.	Current				
	A	B	C	D	E			Total (Min-Max)	W/W	kW			kWh	230V	A	B	C			D	E	Total (Min-Max)			W/W	kW	kWh	230V
	1 Room																											
16	1,60					1,60(1,30-2,30)	4,00		0,40(0,25-0,64)	200	2,00	2,60				2,60(1,20-3,20)	4,33						0,60(0,30-0,96)	300	3,00			
20	2,00					2,00(1,80-2,90)	4,00		0,50(0,34-0,81)	250	2,50	3,20				3,20(1,20-4,10)	4,32						0,74(0,30-1,23)	370	3,70			
25	2,50					2,50(1,80-2,90)	3,97		0,63(0,34-0,81)	315	3,20	3,60				3,60(1,20-4,30)	3,83						0,94(0,30-1,23)	470	4,70			
35	3,50					3,50(1,80-4,10)	3,72		0,94(0,34-1,36)	470	4,50	4,50				4,50(1,20-5,80)	3,66						1,23(0,30-2,10)	615	6,00			
42	4,20					4,20(1,80-4,50)	3,07		1,37(0,34-1,99)	685	6,40	5,60				5,60(1,20-6,80)	3,26						1,72(0,30-2,93)	860	8,00			
50	5,00					5,00(1,90-5,70)	3,23		1,55(0,34-2,13)	775	7,20	6,80				6,80(1,20-6,90)	3,24						2,10(0,30-2,52)	1050	9,70			
60	6,00					6,00(1,90-6,20)	2,96		2,03(0,34-2,33)	1015	9,20	8,50				8,50(1,30-9,00)	3,54						2,40(0,62-2,55)	1200	11,10			
71	7,10					7,10(2,00-7,20)	2,81		2,53(0,37-2,77)	1265	11,40	8,70				8,70(1,40-9,20)	3,41						2,55(0,68-2,72)	1275	11,80			
2 Rooms																												
16+16	1,60	1,60				3,20(2,40-5,80)	4,85	5,60	0,66(0,27-1,74)	330	3,40	2,35	2,35			4,70(2,00-8,20)	3,88	3,80	1,21(0,22-2,41)				1,21(0,22-2,41)	605	5,80			
16+20	1,60	2,00				3,60(2,40-5,80)	4,56	5,60	0,79(0,27-1,74)	395	4,00	2,31	2,89			5,20(2,00-8,20)	3,80	3,80	1,37(0,22-2,40)				1,37(0,22-2,40)	685	6,50			
16+25	1,60	2,50				4,10(2,40-5,80)	4,27	5,60	0,96(0,27-1,74)	480	4,70	2,19	3,41			5,60(2,00-8,20)	3,73	3,80	1,50(0,22-2,40)				1,50(0,22-2,40)	750	7,10			
16+35	1,60	3,50				5,10(2,40-5,80)	3,86	5,60	1,32(0,26-1,68)	660	6,40	2,01	4,39			6,40(2,00-8,60)	3,79	3,80	1,69(0,21-2,48)				1,69(0,21-2,48)	845	8,00			
16+42	1,60	4,20				5,80(2,40-6,70)	3,56	5,60	1,63(0,26-2,13)	815	7,90	2,04	5,36			7,40(2,00-10,10)	3,72	3,80	1,99(0,21-3,03)				1,99(0,21-3,03)	995	9,40			
16+50	1,60	5,00				6,60(2,40-7,20)	3,59	6,10	1,84(0,25-2,13)	920	8,80	2,06	6,44			8,50(2,00-11,00)	3,86	4,00	2,20(0,16-3,04)				2,20(0,16-3,04)	1100	10,30			
16+60	1,60	6,00				7,60(2,40-8,60)	3,21	6,10	2,37(0,25-3,08)	1185	11,30	2,11	7,89			10,00(2,00-11,00)	3,75	4,00	2,67(0,16-3,04)				2,67(0,16-3,04)	1335	12,50			
16+71	1,60	7,10				8,70(2,50-9,10)	2,98	6,10	2,92(0,27-3,16)	1460	14,00	1,88	8,32			10,20(2,00-13,00)	3,82	4,00	2,67(0,16-3,81)				2,67(0,16-3,81)	1335	12,50			
20+20	2,00	2,00				4,00(2,40-5,80)	4,35	5,60	0,92(0,26-1,68)	460	4,50	2,90	2,90			5,80(2,00-8,20)	3,79	3,80	1,53(0,22-2,39)				1,53(0,22-2,39)	765	7,30			
20+25	2,00	2,50				4,50(2,40-5,80)	4,02	5,60	1,12(0,26-1,68)	560	5,50	2,71	3,39			6,10(2,00-8,20)	3,77	3,80	1,62(0,22-2,39)				1,62(0,22-2,39)	810	7,70			
20+35	2,00	3,50				5,50(2,40-5,80)	3,74	5,60	1,47(0,26-1,63)	735	7,10	2,51	4,39			6,90(2,00-8,60)	3,81	3,80	1,81(0,21-2,42)				1,81(0,21-2,42)	905	8,50			
20+42	2,00	4,20				6,20(2,40-7,20)	3,37	5,60	1,84(0,26-2,49)	920	8,80	2,55	5,35			7,90(2,00-11,00)	3,66	3,80	2,16(0,20-3,23)				2,16(0,20-3,23)	1080	10,20			
20+50	2,00	5,00				7,00(2,40-8,10)	3,59	6,10	1,95(0,25-2,61)	975	9,30	2,57	6,43			9,00(2,00-11,00)	3,98	4,00	2,26(0,16-2,98)				2,26(0,16-2,98)	1130	10,60			
20+60	2,00	6,00				8,00(2,40-8,60)	3,14	6,10	2,55(0,25-3,01)	1275	12,20	2,60	7,80			10,40(2,00-11,90)	3,88	4,00	2,68(0,16-3,33)				2,68(0,16-3,33)	1340	12,60			
20+71	1,98	7,02				9,00(2,50-10,00)	2,88	6,10	3,12(0,27-4,03)	1560	14,90	2,29	8,11			10,40(2,00-13,00)	3,97	4,00	2,62(0,16-3,82)				2,62(0,16-3,82)	1310	12,30			
25+25	2,50	2,50				5,00(2,40-5,80)	3,94	5,60	1,27(0,26-1,68)	635	6,10	3,25	3,25			6,50(2,00-8,60)	3,82	3,80	1,70(0,22-2,50)				1,70(0,22-2,50)	850	8,10			
25+35	2,50	3,50				6,00(2,40-6,70)	3,47	5,60	1,73(0,26-2,13)	865	8,40	3,04	4,26			7,30(2,00-10,10)	3,76	3,80	1,94(0,21-3,03)				1,94(0,21-3,03)	970	9,10			
25+42	2,50	4,20				6,70(2,40-7,20)	3,15	5,60	2,13(0,26-2,49)	1065	10,20	3,10	5,20			8,30(2,00-11,00)	3,61	3,80	2,30(0,20-3,23)				2,30(0,20-3,23)	1150	10,80			
25+50	2,50	5,00				7,50(2,40-8,60)	3,33	6,10	2,25(0,25-3,01)	1125	10,80	3,13	6,27			9,40(2,00-11,00)	3,84	4,00	2,45(0,16-2,98)				2,45(0,16-2,98)	1225	11,50			
25+60	2,50	6,00				8,50(2,50-9,10)	2,89	6,10	2,94(0,27-3,29)	1470	14,10	3,06	7,34			10,40(2,00-13,00)	3,88	4,00	2,68(0,16-3,81)				2,68(0,16-3,81)	1340	12,60			
25+71	2,34	6,66				9,00(2,50-10,10)	2,88	6,10	3,12(0,27-4,18)	1560	14,90	2,71	7,69			10,40(2,00-13,00)	3,97	4,00	2,62(0,16-3,82)				2,62(0,16-3,82)	1310	12,30			
35+35	3,50	3,50				7,00(2,40-8,10)	3,11	5,60	2,25(0,26-3,06)	1125	10,80	4,05	4,05			8,10(2,00-11,00)	3,70	3,80	2,19(0,20-3,22)				2,19(0,20-3,22)	1095	10,30			
35+42	3,50	4,20				7,70(2,40-8,60)	2,88	5,60	2,67(0,26-3,55)	1335	12,80	4,14	4,96			9,10(2,00-11,00)	3,65	3,80	2,49(0,20-3,16)				2,49(0,20-3,16)	1245	11,70			
35+50	3,50	5,00				8,50(2,50-9,10)	3,02	6,10	2,81(0,27-3,16)	1405	13,50	4,20	6,00			10,20(2,00-13,00)	3,94	4,00	2,59(0,16-3,81)				2,59(0,16-3,81)	1295	12,20			
35+60	3,32	5,68				9,00(2,50-10,10)	2,82	6,10	3,19(0,27-4,18)	1595	15,30	3,83	6,57			10,40(2,00-13,00)	3,98	4,00	2,61(0,16-3,81)				2,61(0,16-3,81)	1305	12,30			
35+71	2,97	6,03				9,00(2,50-10,40)	3,01	6,10	2,99(0,27-4,34)	1495	14,30	3,43	6,97			10,40(2,00-13,80)	4,02	4,00	2,59(0,16-4,14)				2,59(0,16-4,14)	1295	12,20			
42+42	4,20	4,20				8,40(2,50-9,10)	2,51	5,60	3,34(0,28-3,96)	1670	16,00	5,05	5,05			10,10(2,00-13,00)	3,62	3,80	2,79(0,19-3,99)				2,79(0,19-3,99)	1395	13,10			
42+50	4,11	4,89				9,00(2,50-10,00)	2,88	6,10	3,12(0,27-4,03)	1560	14,90	4,75	5,65			10,40(2,00-13,00)	4,00	4,00	2,60(0,16-3,74)				2,60(0,16-3,74)	1300	12,20			
42+60	3,71	5,29				9,00(2,50-10,40)	2,88	6,10	3,12(0,27-4,33)	1560	14,90	4,28	6,12			10,40(2,00-13,80)	4,00	4,00	2,60(0,16-4,15)				2,60(0,16-4,15)	1300	12,20			
42+71	3,35	5,65				9,00(2,50-10,40)	3,01	6,10	2,99(0,27-4,34)	1495	14,30	3,87	6,53			10,40(2,00-13,80)	4,03	4,00	2,58(0,16-4,13)				2,58(0,16-4,13)	1290	12,10			
50+50	4,50	4,50				9,00(2,50-10,40)	3,38	6,10	2,66(0,26-3,61)	1330	12,70	5,20	5,20			10,40(2,00-13,80)	4,28	4,00	2,43(0,17-3,90)				2,43(0,17-3,90)	1215	11,40			
50+60	4,09	4,91				9,00(2,50-10,40)	3,38	6,10	2,66(0,26-3,61)	1330	12,70	4,73	5,67			10,40(2,00-13,80)	4,28	4,00	2,43(0,17-3,90)				2,43(0,17-3,90)	1215	11,40			
50+71	3,72	5,28				9,00(2,50-10,40)	3,46	6,10	2,60(0,26-3,48)	1300	12,40	4,30	6,10			10,40(2,00-13,80)	4,32	4,00	2,41(0,17-3,89)				2,41(0,17-3,89)	1205	11,30			
60+60	4,50	4,50				9,00(2,50-10,40)	3,38	6,10	2,66(0,26-3,61)	1330	12,70	5,20	5,20			10,40(2,00-13,80)	4,28	4,00	2,43(0,17-3,90)				2,43(0,17-3,90)	1215	11,40			
60+71	4,12	4,88				9,00(2,50-10,40)	3,46	6,10	2,60(0,26-3,48)	1300	12,40	4,76	5,64			10,40(2,00-13,80)	4,32	4,00	2,41(0,17-3,89)				2,41(0,17-3,89)	1205	11,30			
71+71	4,50	4,50				9,00(2,50-10,40)</																						

Free Multi R32 combinations table

Free Multi 5x1 CU-5Z90TBE. Minimum capacity connected: 4,50kW. Maximum capacity connected: 18,30kW • R32 GAS

Indoor unit capacity	Cooling capacity (kW). Rooms					EER	SEER ¹	Input power rating			A.E.C.	Current	Heating capacity (kW). Rooms					COP	SCOP ¹	Input power rating			A.E.C.	Current
	A	B	C	D	E			Total (Min - Max)	W/W	kW			kWh	230V	A	B	C			D	E	Total (Min - Max)		
20+20+71	1.62	1.62	5.76			9.00(2.90-10.70)	3.83	7.20	2.35(0.34-3.27)	1175	11.20	1.87	1.87	6.66	10.40(2.70-13.80)	4.56	4.20	2.28(0.25-3.71)	1140	10.70				
20+25+25	2.00	2.50	2.50			7.00(2.90-8.50)	3.93	7.20	1.78(0.31-2.55)	890	8.50	2.68	3.36	3.36	9.40(2.70-12.30)	4.16	4.10	2.26(0.23-3.35)	1130	10.60				
20+25+35	2.00	2.50	3.50			8.00(2.90-8.50)	3.67	7.20	2.18(0.34-2.49)	1090	10.40	2.55	3.19	4.46	10.20(2.70-12.90)	4.16	4.10	2.45(0.23-3.54)	1225	11.50				
20+25+42	2.00	2.50	4.20			8.70(2.90-9.60)	3.43	7.20	2.54(0.34-3.00)	1270	12.20	2.39	2.99	5.02	10.40(2.70-13.60)	4.24	4.20	2.45(0.23-3.87)	1225	11.50				
20+25+50	1.89	2.37	4.74			9.00(2.90-10.10)	3.73	7.20	2.41(0.34-2.94)	1205	11.50	2.19	2.74	5.47	10.40(2.70-13.60)	4.54	4.20	2.29(0.25-3.62)	1145	10.80				
20+25+60	1.71	2.14	5.15			9.00(2.90-10.70)	3.73	7.20	2.41(0.34-3.41)	1205	11.50	1.98	2.48	5.94	10.40(2.70-13.80)	4.54	4.20	2.29(0.25-3.73)	1145	10.80				
20+25+71	1.55	1.94	5.51			9.00(2.90-10.70)	3.83	7.20	2.35(0.34-3.27)	1175	11.20	1.79	2.24	6.37	10.40(2.70-13.80)	4.56	4.20	2.28(0.25-3.71)	1140	10.70				
20+35+35	2.00	3.50	3.50			9.00(2.90-9.60)	3.38	7.20	2.66(0.34-2.93)	1330	12.70	2.32	4.04	4.04	10.40(2.70-13.60)	4.28	4.20	2.43(0.24-3.85)	1215	11.40				
20+35+42	1.85	3.25	3.90			9.00(2.90-10.70)	3.38	7.20	2.66(0.34-3.91)	1330	12.70	2.14	3.75	4.51	10.40(2.70-13.60)	4.30	4.20	2.42(0.24-3.78)	1210	11.40				
20+35+50	1.71	3.00	4.29			9.00(2.90-10.70)	3.83	7.20	2.35(0.34-3.34)	1175	11.20	1.98	3.47	4.95	10.40(2.70-13.80)	4.60	4.20	2.26(0.27-3.70)	1130	10.60				
20+35+60	1.56	2.74	4.70			9.00(2.90-10.70)	3.83	7.20	2.35(0.34-3.34)	1175	11.20	1.81	3.17	5.42	10.40(2.70-13.80)	4.60	4.20	2.26(0.27-3.70)	1130	10.60				
20+35+71	1.43	2.50	5.07			9.00(2.90-10.70)	3.95	7.20	2.28(0.37-3.20)	1140	10.90	1.65	2.89	5.86	10.40(2.70-13.80)	4.62	4.20	2.25(0.27-3.68)	1125	10.60				
20+42+42	1.74	3.63	3.63			9.00(2.90-10.70)	3.46	7.20	2.60(0.34-3.91)	1300	12.40	2.00	4.20	4.20	10.40(2.70-13.60)	4.32	4.20	2.41(0.24-3.77)	1205	11.30				
20+42+50	1.60	3.38	4.02			9.00(2.90-10.70)	3.83	7.20	2.35(0.34-3.27)	1175	11.20	1.86	3.90	4.64	10.40(2.70-13.80)	4.60	4.20	2.26(0.27-3.68)	1130	10.60				
20+42+60	1.47	3.10	4.43			9.00(2.90-10.70)	3.83	7.20	2.35(0.34-3.27)	1175	11.20	1.70	3.58	5.12	10.40(2.70-13.80)	4.60	4.20	2.26(0.27-3.68)	1130	10.60				
20+42+71	1.35	2.84	4.81			9.00(2.90-10.70)	3.95	7.20	2.28(0.37-3.20)	1140	10.90	1.56	3.28	5.56	10.40(2.70-14.10)	4.64	4.20	2.24(0.27-3.78)	1120	10.50				
20+50+50	1.50	3.75	3.75			9.00(2.90-10.70)	4.17	7.20	2.16(0.37-2.94)	1080	10.30	1.74	4.33	4.33	10.40(2.70-13.80)	4.81	4.20	2.16(0.31-3.48)	1080	10.20				
20+50+60	1.38	3.46	4.16			9.00(2.90-10.70)	4.17	7.20	2.16(0.37-2.94)	1080	10.30	1.60	4.00	4.80	10.40(2.70-14.10)	4.81	4.20	2.16(0.31-3.65)	1080	10.20				
20+50+71	1.28	3.19	4.53			9.00(3.00-10.70)	4.15	7.20	2.17(0.40-2.87)	1085	10.40	1.48	3.69	5.23	10.40(2.70-14.10)	4.75	4.20	2.19(0.32-3.64)	1095	10.30				
20+60+60	1.28	3.86	3.86			9.00(3.00-10.70)	4.17	7.20	2.16(0.40-2.94)	1080	10.30	1.48	4.46	4.46	10.40(2.70-14.10)	4.81	4.20	2.16(0.31-3.65)	1080	10.20				
20+60+71	1.19	3.58	4.23			9.00(3.00-10.70)	4.15	7.20	2.17(0.40-2.87)	1085	10.40	1.38	4.13	4.89	10.40(2.70-14.40)	4.75	4.20	2.19(0.32-3.75)	1095	10.30				
20+71+71	1.12	3.94	3.94			9.00(3.00-10.70)	4.27	7.20	2.11(0.41-2.81)	1055	10.10	1.28	4.56	4.56	10.40(2.70-14.40)	4.77	4.20	2.18(0.33-3.74)	1090	10.20				
25+25+25	2.50	2.50	2.50			7.50(2.90-8.50)	3.73	7.20	2.01(0.31-2.55)	1005	9.60	3.23	3.23	3.23	9.69(2.70-12.30)	4.02	4.10	2.41(0.23-3.35)	1205	11.30				
25+25+35	2.50	2.50	3.50			8.50(2.90-9.60)	3.41	7.20	2.49(0.34-3.00)	1245	11.90	3.06	3.06	4.28	10.40(2.70-13.60)	4.23	4.20	2.46(0.23-3.89)	1230	11.60				
25+25+42	2.45	2.45	4.10			9.00(2.90-10.10)	3.30	7.20	2.73(0.34-3.40)	1365	13.10	2.83	2.83	4.74	10.40(2.70-13.60)	4.24	4.20	2.45(0.23-3.87)	1225	11.50				
25+25+50	2.25	2.25	4.50			9.00(2.90-10.70)	3.73	7.20	2.41(0.34-3.41)	1205	11.50	2.60	2.60	5.20	10.40(2.70-13.60)	4.54	4.20	2.29(0.25-3.62)	1145	10.80				
25+25+60	2.05	2.05	4.90			9.00(2.90-10.70)	3.73	7.20	2.41(0.34-3.41)	1205	11.50	2.36	2.36	5.68	10.40(2.70-13.80)	4.54	4.20	2.29(0.25-3.73)	1145	10.80				
25+25+71	1.86	1.86	5.28			9.00(2.90-10.70)	3.83	7.20	2.35(0.34-3.27)	1175	11.20	2.15	2.15	6.10	10.40(2.70-13.80)	4.56	4.20	2.28(0.25-3.71)	1140	10.70				
25+35+35	2.36	3.32	3.32			9.00(2.90-10.10)	3.38	7.20	2.66(0.34-3.33)	1330	12.70	2.74	3.83	3.83	10.40(2.70-13.60)	4.28	4.20	2.43(0.24-3.85)	1215	11.40				
25+35+42	2.20	3.09	3.71			9.00(2.90-10.70)	3.38	7.20	2.66(0.34-3.91)	1330	12.70	2.55	3.57	4.28	10.40(2.70-13.60)	4.30	4.20	2.42(0.24-3.78)	1210	11.40				
25+35+50	2.05	2.86	4.09			9.00(2.90-10.70)	3.83	7.20	2.35(0.34-3.34)	1175	11.20	2.36	3.31	4.73	10.40(2.70-13.80)	4.60	4.20	2.26(0.27-3.70)	1130	10.60				
25+35+60	1.87	2.63	4.50			9.00(2.90-10.70)	3.83	7.20	2.35(0.34-3.34)	1175	11.20	2.17	3.03	5.20	10.40(2.70-13.80)	4.60	4.20	2.26(0.27-3.70)	1130	10.60				
25+35+71	1.72	2.40	4.88			9.00(2.90-10.70)	3.95	7.20	2.28(0.37-3.20)	1140	10.90	1.98	2.78	5.64	10.40(2.70-14.10)	4.62	4.20	2.25(0.27-3.80)	1125	10.60				
25+42+42	2.06	3.47	3.47			9.00(2.90-10.70)	3.46	7.20	2.60(0.34-3.91)	1300	12.40	2.38	4.01	4.01	10.40(2.70-13.80)	4.32	4.20	2.41(0.24-3.89)	1205	11.30				
25+42+50	1.92	3.23	3.85			9.00(2.90-10.70)	3.83	7.20	2.35(0.34-3.27)	1175	11.20	2.22	3.73	4.45	10.40(2.70-13.80)	4.60	4.20	2.26(0.27-3.68)	1130	10.60				
25+42+60	1.77	2.98	4.25			9.00(2.90-10.70)	3.83	7.20	2.35(0.34-3.27)	1175	11.20	2.05	3.44	4.91	10.40(2.70-14.10)	4.60	4.20	2.26(0.27-3.80)	1130	10.60				
25+42+71	1.63	2.74	4.63			9.00(3.00-10.70)	3.95	7.20	2.28(0.37-3.20)	1140	10.90	1.88	3.17	5.35	10.40(2.70-14.10)	4.64	4.20	2.24(0.27-3.78)	1120	10.50				
25+50+50	1.80	3.60	3.60			9.00(2.90-10.70)	4.17	7.20	2.16(0.37-2.94)	1080	10.30	2.08	4.16	4.16	10.40(2.70-13.80)	4.81	4.20	2.16(0.31-3.48)	1080	10.20				
25+50+60	1.67	3.33	4.00			9.00(3.00-10.70)	4.17	7.20	2.16(0.40-2.94)	1080	10.30	1.93	3.85	4.62	10.40(2.70-14.10)	4.81	4.20	2.16(0.31-3.65)	1080	10.20				
25+50+71	1.54	3.08	4.38			9.00(3.00-10.70)	4.15	7.20	2.17(0.40-2.87)	1085	10.40	1.78	3.56	5.06	10.40(2.70-14.10)	4.75	4.20	2.19(0.32-3.64)	1095	10.30				
25+60+60	1.56	3.72	3.72			9.00(3.00-10.70)	4.17	7.20	2.16(0.40-2.94)	1080	10.30	1.80	4.30	4.30	10.40(2.70-14.10)	4.81	4.20	2.16(0.31-3.65)	1080	10.20				
25+60+71	1.44	3.46	4.10			9.00(3.00-10.70)	4.15	7.20	2.17(0.40-2.87)	1085	10.40	1.67	4.00	4.73	10.40(2.70-14.40)	4.75	4.20	2.19(0.32-3.75)	1095	10.30				
25+71+71	1.34	3.83	3.83			9.00(3.00-10.70)	4.27	7.20	2.11(0.41-2.81)	1055	10.10	1.56	4.42	4.42	10.40(2.70-14.40)	4.77	4.20	2.18(0.33-3.74)	1090	10.20				
35+35+35	3.00	3.00	3.00			9.00(2.90-10.70)	3.46	7.20	2.60(0.34-3.83)	1300	12.40	3.46	3.46	3.46	10.38(2.70-13.80)	4.40	4.20	2.36(0.24-3.88)	1180	11.10				
35+35+42	2.81	2.81	3.38			9.00(2.90-10.70)	3.46	7.20	2.60(0.34-3.76)	1300	12.40	3.25	3.25	3.90	10.40(2.70-13.80)	4.43	4.20	2.35(0.24-3.87)	1175	11.10				
35+35+50	2.63	2.63	3.74			9.00(2.90-10.70)	3.83	7.20	2.35(0.34-3.20)	1175	11.20	3.03	3.03	4.34	10.40(2.70-13.80)	4.64	4.20	2.24(0.27-3.66)	1120	10.50				
35+35+60	2.42	2.42	4.16			9.00(2.90-10.70)	3.83	7.20	2.35(0.34-3.20)	1175	11.20	2.80	2.80	4.80	10.40(2.70-14.10)	4.64	4.20	2.24(0.27-3.78)	1120	10.50				
35+35+71	2.23	2.23	4.54			9.00(3.00-10.70)	3.95	7.20	2.28(0.37-3.14)	1140	10.90	2.58	2.58	5.24	10.40(2.70-14.10)	4.66	4.20	2.23(0.27-3.76)	1115	10.50				
35+42+42	2.64	3.18	3.18			9.00(2.90-10.70)	3.56	7.20	2.53(0.34-3.76)	1265	12.10	3.06	3.67	3.67	10.40(2.70-13.80)	4.44	4.20	2.34(0.25-3.85)	1170	11.00				
35+42+50	2.48	2.98	3.54			9.00(2.90-10.70)	3.95	7.20	2.28(0.37-3.20)	1140	10.90	2.87	3.44	4.09	10.40(2.70-14.10)	4.66	4.20	2.23(0.27-3.77)	1115	10.50				
35+42+60	2.30	2.76	3.94			9.00(3.00-10.70)	3.95	7.20	2.28(0.37-3.20)	1140	10.90	2.66												

Free Multi 5x1 CU-5Z90TBE. Minimum capacity connected: 4,50kW. Maximum capacity connected: 18,30kW • R32 GAS

Indoor unit capacity	Cooling capacity (kW). Rooms					EER	SEER ¹	Input power rating			A.E.C.	Current	Heating capacity (kW). Rooms					COP	SCOP ¹	Input power rating			A.E.C.	Current				
	A	B	C	D	E			Total (Min-Max)	W/W	kW			kWh	230V	A	B	C			D	E	Total (Min-Max)			W/W	kW	kWh	230V
16+16+25+25	1,60	1,60	2,50	2,50	8,20	(2,90-10,60)	4,04	8,00	▲	2,03	(0,37-3,40)	1015	9,70	2,03	2,03	3,17	3,17	10,40	(3,40-14,20)	4,66	4,20	▲	2,23	(0,34-3,82)	1115	10,50		
16+16+25+35	1,57	1,57	2,44	3,42	9,00	(2,90-10,60)	3,78	8,00	▲	2,38	(0,37-3,33)	1190	11,40	1,81	1,81	2,83	3,95	10,40	(3,40-14,20)	4,73	4,40	▲	2,20	(0,34-3,78)	1100	10,30		
16+16+25+42	1,45	1,45	2,27	3,83	9,00	(2,90-10,60)	3,78	8,00	▲	2,38	(0,37-3,33)	1190	11,40	1,68	1,68	2,63	4,41	10,40	(3,40-14,20)	4,73	4,40	▲	2,20	(0,34-3,77)	1100	10,30		
16+16+25+50	1,35	1,35	2,09	4,21	9,00	(2,90-10,60)	4,00	8,00	▲	2,25	(0,41-3,11)	1125	10,80	1,56	1,56	2,43	4,85	10,40	(3,40-14,20)	4,84	4,40	▲	2,15	(0,40-3,63)	1075	10,10		
16+16+25+60	1,23	1,23	1,92	4,62	9,00	(2,90-10,60)	4,00	8,00	▲	2,25	(0,41-3,11)	1125	10,80	1,42	1,42	2,22	5,34	10,40	(3,40-14,20)	4,84	4,40	▲	2,15	(0,40-3,63)	1075	10,10		
16+16+25+71	1,13	1,13	1,75	4,99	9,00	(2,90-10,80)	3,98	8,00	▲	2,26	(0,41-3,18)	1130	10,80	1,30	1,30	2,03	5,77	10,40	(3,40-14,40)	4,84	4,40	▲	2,15	(0,40-3,67)	1075	10,10		
16+16+35+35	1,41	1,41	3,09	3,09	9,00	(2,90-10,60)	3,78	8,00	▲	2,38	(0,37-3,33)	1190	11,40	1,63	1,63	3,57	3,57	10,40	(3,40-14,20)	4,77	4,40	▲	2,18	(0,36-3,75)	1090	10,20		
16+16+35+42	1,32	1,32	2,89	3,47	9,00	(2,90-10,60)	3,90	8,00	▲	2,31	(0,37-3,25)	1155	11,10	1,53	1,53	3,34	4,00	10,40	(3,40-14,20)	4,79	4,40	▲	2,17	(0,36-3,68)	1085	10,20		
16+16+35+50	1,23	1,23	2,69	3,85	9,00	(2,90-10,60)	3,98	8,00	▲	2,26	(0,41-3,04)	1130	10,80	1,42	1,42	3,11	4,45	10,40	(3,40-14,20)	4,86	4,40	▲	2,14	(0,42-3,59)	1070	10,10		
16+16+35+60	1,13	1,13	2,48	4,26	9,00	(2,90-10,80)	3,98	8,00	▲	2,26	(0,41-3,18)	1130	10,80	1,31	1,31	2,87	4,91	10,40	(3,40-14,20)	4,86	4,40	▲	2,14	(0,42-3,59)	1070	10,10		
16+16+35+71	1,04	1,04	2,28	4,64	9,00	(2,90-10,80)	4,09	8,00	▲	2,20	(0,44-3,11)	1100	10,50	1,21	1,21	2,64	5,34	10,40	(3,40-14,40)	4,88	4,40	▲	2,13	(0,42-3,64)	1065	10,00		
16+16+42+42	1,24	1,24	3,26	3,26	9,00	(2,90-10,60)	3,90	8,00	▲	2,31	(0,37-3,25)	1155	11,10	1,43	1,43	3,77	3,77	10,40	(3,40-14,20)	4,79	4,40	▲	2,17	(0,37-3,66)	1085	10,20		
16+16+42+50	1,16	1,16	3,05	3,63	9,00	(2,90-10,80)	3,98	8,00	▲	2,26	(0,41-3,18)	1130	10,80	1,34	1,34	3,52	4,20	10,40	(3,40-14,20)	4,88	4,40	▲	2,13	(0,42-3,58)	1065	10,00		
16+16+42+60	1,07	1,07	2,82	4,04	9,00	(2,90-10,80)	3,98	8,00	▲	2,26	(0,41-3,18)	1130	10,80	1,24	1,24	3,26	4,66	10,40	(3,40-14,40)	4,88	4,40	▲	2,13	(0,42-3,64)	1065	10,00		
16+16+42+71	0,99	0,99	2,61	4,41	9,00	(3,00-11,00)	4,09	8,00	▲	2,20	(0,44-3,26)	1100	10,50	1,15	1,15	3,01	5,09	10,40	(3,40-14,40)	4,81	4,40	▲	2,16	(0,43-3,62)	1080	10,20		
16+16+50+50	1,09	1,09	3,41	3,41	9,00	(2,90-10,80)	4,07	8,00	▲	2,21	(0,48-2,98)	1105	10,60	1,26	1,26	3,94	3,94	10,40	(3,40-14,40)	4,81	4,40	▲	2,16	(0,49-3,57)	1080	10,20		
16+16+50+60	1,01	1,01	3,17	3,81	9,00	(3,00-11,00)	4,07	8,00	▲	2,21	(0,48-3,12)	1105	10,60	1,17	1,17	3,66	4,40	10,40	(3,40-14,40)	4,81	4,40	▲	2,16	(0,49-3,57)	1080	10,20		
16+16+50+71	0,94	0,94	2,94	4,18	9,00	(3,00-11,00)	4,07	8,00	▲	2,21	(0,52-3,12)	1105	10,60	1,09	1,09	3,40	4,82	10,40	(3,40-14,40)	4,84	4,40	▲	2,15	(0,51-3,55)	1075	10,10		
16+16+60+60	0,95	0,95	3,55	3,55	9,00	(3,00-11,00)	4,07	8,00	▲	2,21	(0,48-3,12)	1105	10,60	1,09	1,09	4,11	4,11	10,40	(3,40-14,40)	4,81	4,40	▲	2,16	(0,49-3,57)	1080	10,20		
16+16+60+71	0,88	0,88	3,31	3,93	9,00	(3,00-11,20)	4,07	8,00	▲	2,21	(0,52-3,20)	1105	10,60	1,02	1,02	3,83	4,53	10,40	(3,40-14,40)	4,84	4,40	▲	2,15	(0,51-3,55)	1075	10,10		
16+16+71+71	0,83	0,83	3,67	3,67	9,00	(3,00-11,20)	4,19	8,00	▲	2,15	(0,52-3,20)	1075	10,30	0,96	0,96	4,24	4,24	10,40	(3,40-14,40)	4,86	4,40	▲	2,14	(0,51-3,60)	1070	10,10		
16+20+20+20	1,60	2,00	2,00	2,00	7,60	(2,90-10,60)	4,18	8,00	▲	1,82	(0,37-3,40)	910	8,70	2,18	2,74	2,74	2,74	10,40	(3,40-14,20)	4,68	4,20	▲	2,22	(0,34-3,81)	1110	10,40		
16+20+20+25	1,60	2,00	2,00	2,50	8,10	(2,90-10,60)	4,11	8,00	▲	1,97	(0,37-3,40)	985	9,40	2,05	2,57	2,57	3,21	10,40	(3,40-14,20)	4,68	4,20	▲	2,22	(0,34-3,81)	1110	10,40		
16+20+20+35	1,58	1,98	1,98	3,46	9,00	(2,90-10,60)	3,78	8,00	▲	2,38	(0,37-3,33)	1190	11,40	1,83	2,29	2,29	3,99	10,40	(3,40-14,20)	4,73	4,40	▲	2,20	(0,34-3,77)	1100	10,30		
16+20+20+42	1,46	1,84	1,84	3,86	9,00	(2,90-10,60)	3,78	8,00	▲	2,38	(0,37-3,33)	1190	11,40	1,70	2,12	2,12	4,46	10,40	(3,40-14,20)	4,75	4,40	▲	2,19	(0,35-3,76)	1095	10,30		
16+20+20+50	1,35	1,70	1,70	4,25	9,00	(2,90-10,60)	4,00	8,00	▲	2,25	(0,41-3,04)	1125	10,80	1,57	1,96	1,96	4,91	10,40	(3,40-14,20)	4,84	4,40	▲	2,15	(0,40-3,62)	1075	10,10		
16+20+20+60	1,24	1,55	1,55	4,66	9,00	(2,90-10,60)	4,00	8,00	▲	2,25	(0,41-3,04)	1125	10,80	1,43	1,79	1,79	5,39	10,40	(3,40-14,20)	4,84	4,40	▲	2,15	(0,40-3,62)	1075	10,10		
16+20+20+71	1,13	1,42	1,42	5,03	9,00	(2,90-10,80)	3,98	8,00	▲	2,26	(0,44-3,11)	1130	10,80	1,31	1,64	1,64	5,81	10,40	(3,40-14,20)	4,86	4,40	▲	2,14	(0,42-3,60)	1070	10,10		
16+20+25+25	1,60	2,00	2,50	2,50	8,60	(2,90-10,60)	3,89	8,00	▲	2,21	(0,37-3,40)	1105	10,60	1,93	2,43	3,02	3,02	10,40	(3,40-14,20)	4,68	4,20	▲	2,22	(0,34-3,81)	1110	10,40		
16+20+25+35	1,50	1,88	2,34	3,28	9,00	(2,90-10,60)	3,78	8,00	▲	2,38	(0,37-3,33)	1190	11,40	1,73	2,17	2,17	3,79	10,40	(3,40-14,20)	4,73	4,40	▲	2,20	(0,34-3,77)	1100	10,30		
16+20+25+42	1,40	1,75	2,18	3,67	9,00	(2,90-10,60)	3,78	8,00	▲	2,38	(0,37-3,33)	1190	11,40	1,62	2,02	2,52	4,24	10,40	(3,40-14,20)	4,75	4,40	▲	2,19	(0,35-3,76)	1095	10,30		
16+20+25+50	1,30	1,62	2,03	4,05	9,00	(2,90-10,60)	4,00	8,00	▲	2,25	(0,41-3,04)	1125	10,80	1,50	1,87	2,34	4,69	10,40	(3,40-14,20)	4,84	4,40	▲	2,15	(0,40-3,62)	1075	10,10		
16+20+25+60	1,19	1,49	1,86	4,46	9,00	(2,90-10,80)	4,00	8,00	▲	2,25	(0,41-3,18)	1125	10,80	1,38	1,72	1,72	5,15	10,40	(3,40-14,20)	4,84	4,40	▲	2,15	(0,40-3,62)	1075	10,10		
16+20+25+71	1,09	1,36	1,70	4,85	9,00	(2,90-10,80)	3,98	8,00	▲	2,26	(0,44-3,11)	1130	10,80	1,26	1,58	1,97	5,59	10,40	(3,40-14,40)	4,86	4,40	▲	2,15	(0,40-3,62)	1070	10,10		
16+20+35+35	1,36	1,70	2,97	2,97	9,00	(2,90-10,60)	3,90	8,00	▲	2,31	(0,37-3,25)	1155	11,10	1,57	1,97	3,43	3,43	10,40	(3,40-14,20)	4,79	4,40	▲	2,17	(0,36-3,68)	1085	10,20		
16+20+35+42	1,27	1,59	2,79	3,35	9,00	(2,90-10,60)	3,90	8,00	▲	2,31	(0,37-3,25)	1155	11,10	1,47	1,84	3,22	3,87	10,40	(3,40-14,20)	4,79	4,40	▲	2,17	(0,37-3,66)	1085	10,20		
16+20+35+50	1,19	1,49	2,60	3,72	9,00	(2,90-10,80)	3,98	8,00	▲	2,26	(0,41-3,18)	1130	10,80	1,38	1,72	3,01	4,29	10,40	(3,40-14,20)	4,88	4,40	▲	2,13	(0,42-3,58)	1065	10,00		
16+20+35+60	1,10	1,37	2,40	4,13	9,00	(2,90-10,80)	3,98	8,00	▲	2,26	(0,41-3,18)	1130	10,80	1,27	1,59	2,78	4,76	10,40	(3,40-14,40)	4,88	4,40	▲	2,13	(0,42-3,64)	1065	10,00		
16+20+35+71	1,01	1,27	2,22	4,50	9,00	(3,00-11,00)	4,09	8,00	▲	2,20	(0,44-3,26)	1100	10,50	1,17	1,46	2,56	5,21	10,40	(3,40-14,40)	4,81	4,40	▲	2,16	(0,43-3,62)	1080	10,20		
16+20+42+42	1,20	1,50	3,15	3,15	9,00	(2,90-10,60)	3,90	8,00	▲	2,31	(0,37-3,25)	1155	11,10	1,39	1,73	3,64	3,64	10,40	(3,40-14,20)	4,81	4,40	▲	2,16	(0,37-3,65)	1080	10,20		
16+20+42+50	1,12	1,41	2,95	3,52	9,00	(2,90-10,80)	3,98	8,00	▲	2,26	(0,44-3,11)	1130	10,80	1,30	1,63	3,41	4,06	10,40	(3,40-14,40)	4,91	4,40	▲	2,12	(0,42-3,63)	1060	10,00		
16+20+42+60	1,04	1,30	2,74	3,92	9,00	(2,90-10,80)	3,98	8,00	▲	2,26	(0,44-3,11)	1130	10,80	1,21	1,51	3,17	4,51	10,40	(3,40-14,40)	4,91	4,40	▲	2,12	(0,42-3,63)	1060	10,00		
16+20+42+71	0,96	1,21	2,54	4,29	9,00	(3,00-11,00)	4,09	8,00	▲	2,20	(0,44-3,19)	1100	10,50	1,12	1,40	2,93	4,95	10,40	(3,40-14,40)	4,81	4,40	▲	2,16	(0,43-3,61)	1080	10,20		
16+20+50+50																												

Free Multi R32 combinations table

Free Multi 5x1 CU-5Z90TBE. Minimum capacity connected: 4,50kW. Maximum capacity connected: 18,30kW • R32 GAS

Indoor unit capacity	Cooling capacity (kW). Rooms					EER	SEER ¹	Input power rating			A.E.C.	Current	Heating capacity (kW). Rooms					COP	SCOP ¹	Input power rating			A.E.C.	Current
	A	B	C	D	E			Total (Min - Max)	W/W	kW			kWh	230V	A	B	C			D	E	Total (Min - Max)		
16+42+50+60	0,86	2,25	2,68	3,21		9,00(3,00-11,20)	4,07	8,00	2,21(0,52-3,20)	1105	10,60	0,99	2,60	3,10	3,71	10,40(3,40-14,40)	4,77	4,40	2,18(0,53-3,58)	1090	10,20			
16+42+50+71	0,80	2,11	2,51	3,58		9,00(3,00-11,20)	4,17	8,00	2,16(0,53-3,20)	1080	10,30	0,93	2,44	2,91	4,12	10,40(3,40-14,40)	4,79	4,40	2,17(0,54-3,56)	1085	10,20			
16+42+60+60	0,81	2,13	3,03	3,03		9,00(3,00-11,20)	4,07	8,00	2,21(0,52-3,20)	1105	10,60	0,93	2,45	3,51	3,51	10,40(3,40-14,40)	4,77	4,40	2,18(0,53-3,58)	1090	10,20			
16+50+50+50	0,87	2,71	2,71	2,71		9,00(3,00-11,20)	4,15	8,00	2,17(0,57-3,14)	1085	10,40	1,01	3,13	3,13	3,13	10,40(3,40-14,40)	4,66	4,40	2,23(0,63-3,58)	1115	10,50			
16+50+50+60	0,81	2,56	2,56	3,07		9,00(3,00-11,20)	4,15	8,00	2,17(0,57-3,14)	1085	10,40	0,95	2,95	2,95	3,55	10,40(3,40-14,40)	4,66	4,40	2,23(0,63-3,58)	1115	10,50			
20+20+20+20	2,00	2,00	2,00	2,00		8,00(2,90-10,60)	4,06	8,00	1,97(0,37-3,40)	985	9,40	2,60	2,60	2,60	2,60	10,40(3,40-14,20)	4,71	4,20	2,21(0,34-3,79)	1105	10,40			
20+20+20+25	2,00	2,00	2,00	2,50		8,50(2,90-10,60)	3,95	8,00	2,15(0,37-3,40)	1075	10,30	2,45	2,45	2,45	3,05	10,40(3,40-14,20)	4,71	4,20	2,21(0,34-3,79)	1105	10,40			
20+20+20+35	1,89	1,89	1,89	3,33		9,00(2,90-10,60)	3,78	8,00	2,38(0,37-3,33)	1190	11,40	2,19	2,19	2,19	3,83	10,40(3,40-14,20)	4,75	4,40	2,19(0,35-3,76)	1095	10,30			
20+20+20+42	1,76	1,76	1,76	3,72		9,00(2,90-10,60)	3,78	8,00	2,38(0,37-3,33)	1190	11,40	2,04	2,04	2,04	4,28	10,40(3,40-14,20)	4,77	4,40	2,18(0,36-3,74)	1090	10,20			
20+20+20+50	1,64	1,64	1,64	4,08		9,00(2,90-10,60)	4,00	8,00	2,25(0,41-3,04)	1125	10,80	1,89	1,89	1,89	4,73	10,40(3,40-14,20)	4,86	4,40	2,14(0,42-3,60)	1070	10,10			
20+20+20+60	1,50	1,50	1,50	4,50		9,00(2,90-10,60)	4,00	8,00	2,25(0,41-3,04)	1125	10,80	1,73	1,73	1,73	5,21	10,40(3,40-14,20)	4,86	4,40	2,14(0,42-3,60)	1070	10,10			
20+20+20+71	1,37	1,37	1,37	4,89		9,00(2,90-10,80)	4,09	8,00	2,20(0,44-3,11)	1100	10,50	1,59	1,59	1,59	5,63	10,40(3,40-14,40)	4,88	4,40	2,13(0,42-3,64)	1065	10,00			
20+20+25+25	2,00	2,00	2,50	2,50		9,00(2,90-10,60)	3,78	8,00	2,38(0,37-3,33)	1190	11,40	2,31	2,31	2,89	2,89	10,40(3,40-14,20)	4,71	4,40	2,21(0,34-3,79)	1105	10,40			
20+20+25+35	1,80	1,80	2,25	3,15		9,00(2,90-10,60)	3,78	8,00	2,38(0,37-3,33)	1190	11,40	2,08	2,08	2,60	3,64	10,40(3,40-14,20)	4,75	4,40	2,19(0,35-3,76)	1095	10,30			
20+20+25+42	1,68	1,68	2,10	3,54		9,00(2,90-10,60)	3,78	8,00	2,38(0,37-3,33)	1190	11,40	1,94	1,94	2,43	4,09	10,40(3,40-14,20)	4,77	4,40	2,18(0,36-3,74)	1090	10,20			
20+20+25+50	1,57	1,57	1,95	3,91		9,00(2,90-10,60)	4,00	8,00	2,25(0,41-3,04)	1125	10,80	1,81	1,81	2,26	4,52	10,40(3,40-14,20)	4,86	4,40	2,14(0,42-3,60)	1070	10,10			
20+20+25+60	1,44	1,44	1,80	4,32		9,00(2,90-10,80)	4,00	8,00	2,25(0,41-3,18)	1125	10,80	1,66	1,66	2,08	5,00	10,40(3,40-14,20)	4,86	4,40	2,14(0,42-3,60)	1070	10,10			
20+20+25+71	1,32	1,32	1,65	4,71		9,00(2,90-10,80)	4,09	8,00	2,20(0,44-3,11)	1100	10,50	1,54	1,54	1,91	5,43	10,40(3,40-14,40)	4,88	4,40	2,12(0,42-3,64)	1065	10,00			
20+20+35+35	1,64	1,64	2,86	2,86		9,00(2,90-10,60)	3,90	8,00	2,31(0,37-3,25)	1155	11,10	1,89	1,89	3,31	3,31	10,40(3,40-14,20)	4,79	4,40	2,17(0,37-3,66)	1085	10,20			
20+20+35+42	1,54	1,54	2,69	3,23		9,00(2,90-10,60)	3,90	8,00	2,31(0,37-3,25)	1155	11,10	1,78	1,78	3,11	3,73	10,40(3,40-14,20)	4,81	4,40	2,16(0,37-3,65)	1080	10,20			
20+20+35+50	1,44	1,44	2,52	3,60		9,00(2,90-10,80)	3,98	8,00	2,26(0,44-3,11)	1130	10,80	1,66	1,66	2,91	4,17	10,40(3,40-14,20)	4,91	4,40	2,12(0,42-3,57)	1060	10,00			
20+20+35+60	1,33	1,33	2,33	4,01		9,00(2,90-10,80)	3,98	8,00	2,26(0,44-3,11)	1130	10,80	1,54	1,54	2,70	4,62	10,40(3,40-14,40)	4,91	4,40	2,12(0,42-3,63)	1060	10,00			
20+20+35+71	1,23	1,23	1,61	4,38		9,00(3,00-11,00)	4,09	8,00	2,20(0,44-3,19)	1100	10,50	1,42	1,42	2,49	5,07	10,40(3,40-14,40)	4,81	4,40	2,16(0,43-3,61)	1080	10,20			
20+20+42+42	1,45	1,45	3,05	3,05		9,00(2,90-10,80)	3,90	8,00	2,31(0,37-3,40)	1155	11,10	1,68	1,68	3,52	3,52	10,40(3,40-14,20)	4,75	4,40	2,19(0,37-3,64)	1095	10,30			
20+20+42+50	1,36	1,36	2,86	3,42		9,00(2,90-10,80)	4,09	8,00	2,20(0,44-3,11)	1100	10,50	1,58	1,58	3,31	3,93	10,40(3,40-14,40)	4,81	4,40	2,16(0,43-3,62)	1080	10,20			
20+20+42+60	1,27	1,27	2,66	3,80		9,00(3,00-11,00)	4,09	8,00	2,20(0,44-3,26)	1100	10,50	1,46	1,46	3,08	4,40	10,40(3,40-14,40)	4,81	4,40	2,16(0,43-3,62)	1080	10,20			
20+20+42+71	1,18	1,18	2,46	4,18		9,00(3,00-11,00)	4,09	8,00	2,20(0,45-3,19)	1100	10,50	1,36	1,36	2,85	4,83	10,40(3,40-14,40)	4,84	4,40	2,15(0,44-3,66)	1075	10,10			
20+20+50+50	1,29	1,29	3,21	3,21		9,00(2,90-10,80)	4,07	8,00	2,21(0,49-2,98)	1105	10,60	1,49	1,49	3,71	3,71	10,40(3,40-14,40)	4,84	4,40	2,15(0,51-3,60)	1075	10,10			
20+20+50+60	1,20	1,20	3,00	3,60		9,00(3,00-11,00)	4,07	8,00	2,21(0,49-3,12)	1105	10,60	1,39	1,39	3,47	4,15	10,40(3,40-14,40)	4,84	4,40	2,15(0,51-3,60)	1075	10,10			
20+20+50+71	1,12	1,12	2,79	3,97		9,00(3,00-11,20)	4,19	8,00	2,15(0,52-3,20)	1075	10,30	1,29	1,29	3,23	4,59	10,40(3,40-14,40)	4,77	4,40	2,18(0,52-3,59)	1090	10,20			
20+20+60+60	1,12	1,12	3,38	3,38		9,00(3,00-11,20)	4,07	8,00	2,21(0,49-3,19)	1105	10,60	1,30	1,30	3,90	3,90	10,40(3,40-14,40)	4,84	4,40	2,15(0,51-3,60)	1075	10,10			
20+20+60+71	1,05	1,05	3,16	3,74		9,00(3,00-11,20)	4,19	8,00	2,15(0,52-3,20)	1075	10,30	1,22	1,22	3,65	4,31	10,40(3,40-14,40)	4,77	4,40	2,18(0,52-3,59)	1090	10,20			
20+20+71+71	0,99	0,99	3,51	3,51		9,00(3,00-11,20)	4,17	8,00	2,16(0,53-3,13)	1080	10,30	1,14	1,14	4,06	4,06	10,40(3,40-14,40)	4,77	4,40	2,18(0,53-3,58)	1090	10,20			
20+25+25+25	1,89	2,37	2,37	2,37		9,00(2,90-10,60)	3,78	8,00	2,38(0,37-3,40)	1190	11,40	2,18	2,18	2,74	2,74	10,40(3,40-14,20)	4,71	4,40	2,21(0,34-3,79)	1105	10,40			
20+25+25+35	1,71	2,14	2,14	3,01		9,00(2,90-10,60)	3,78	8,00	2,38(0,37-3,33)	1190	11,40	1,98	2,48	2,48	3,46	10,40(3,40-14,20)	4,75	4,40	2,19(0,35-3,76)	1095	10,30			
20+25+25+42	1,60	2,01	2,01	3,38		9,00(2,90-10,60)	3,78	8,00	2,38(0,37-3,33)	1190	11,40	1,86	2,32	2,32	3,90	10,40(3,40-14,20)	4,77	4,40	2,18(0,36-3,74)	1090	10,20			
20+25+25+50	1,49	1,88	1,88	3,75		9,00(2,90-10,60)	4,00	8,00	2,25(0,41-3,04)	1125	10,80	1,73	2,17	2,17	4,33	10,40(3,40-14,20)	4,86	4,40	2,14(0,42-3,60)	1070	10,10			
20+25+25+60	1,38	1,73	1,73	4,16		9,00(2,90-10,80)	4,00	8,00	2,25(0,41-3,18)	1125	10,80	1,60	2,00	2,00	4,80	10,40(3,40-14,40)	4,86	4,40	2,14(0,42-3,66)	1070	10,10			
20+25+25+71	1,27	1,60	1,60	4,53		9,00(2,90-10,80)	4,09	8,00	2,20(0,44-3,11)	1100	10,50	1,48	1,84	1,84	5,24	10,40(3,40-14,40)	4,88	4,40	2,13(0,42-3,64)	1065	10,00			
20+25+35+35	1,56	1,96	2,74	2,74		9,00(2,90-10,60)	3,90	8,00	2,31(0,37-3,25)	1155	11,10	1,80	2,26	3,17	3,17	10,40(3,40-14,20)	4,79	4,40	2,17(0,37-3,66)	1085	10,20			
20+25+35+42	1,48	1,84	2,58	3,10		9,00(2,90-10,80)	3,90	8,00	2,31(0,37-3,40)	1155	11,10	1,70	2,13	2,98	3,59	10,40(3,40-14,20)	4,81	4,40	2,16(0,37-3,65)	1080	10,20			
20+25+35+50	1,38	1,73	2,42	3,47		9,00(2,90-10,80)	3,98	8,00	2,26(0,44-3,11)	1130	10,80	1,60	2,00	2,80	4,00	10,40(3,40-14,40)	4,91	4,40	2,12(0,42-3,63)	1060	10,00			
20+25+35+60	1,28	1,61	2,25	3,86		9,00(2,90-10,80)	3,98	8,00	2,26(0,44-3,11)	1130	10,80	1,49	1,86	2,60	4,45	10,40(3,40-14,40)	4,91	4,40	2,12(0,42-3,63)	1060	10,00			
20+25+35+71	1,19	1,49	2,09	4,23		9,00(3,00-11,00)	4,09	8,00	2,20(0,44-3,19)	1100	10,50	1,38	1,72	2,41	4,89	10,40(3,40-14,40)	4,81	4,40	2,16(0,43-3,61)	1080	10,20			
20+25+42+42	1,40	1,74	2,93	2,93		9,00(2,90-10,80)	3,90	8,00	2,31(0,37-3,40)	1155	11,10	1,60	2,02	3,39	3,39	10,40(3,40-14,40)	4,75	4,40	2,19(0,37-3,76)	1095	10,30			
20+25+42+50	1,31	1,64	2,76	3,29		9,00(2,90-10,80)	4,09	8,00	2,20(0,44-3,11)	1100	10,50	1,52	1,90	3,19	3,79	10,40(3,40-14,40)	4,81	4,40	2,16(0,43-3,62)	1080	10,20			
20+25+42+60	1,22	1,53	2,57	3,68		9,00(3,00-11,00)	4,09	8,00	2,20(0,44-3,26)	1100	10,50	1,41	1,77	2,97	4,25	10,40(3,40-14,40)	4,81	4,40	2,16(0,43-3,62)	1080	10,20			
20+25+42+71																								

Free Multi 5x1 CU-5Z90TBE. Minimum capacity connected: 4,50kW. Maximum capacity connected: 18,30kW • R32 GAS

Indoor unit capacity	Cooling capacity (kW). Rooms					EER	SEER ¹	Input power rating			A.E.C.	Current	Heating capacity (kW). Rooms					COP	SCOP ¹	Input power rating			A.E.C.	Current	
	A	B	C	D	E			Total (Min-Max)	W/W	kW			kWh	230V	A	B	C			D	E	Total (Min-Max)			W/W
25+25+42+60	1,48	1,48	2,49	3,55	9,00(3,00-11,00)	4,09	8,00	2,20(0,44-3,26)	1100	10,50	1,71	1,71	2,87	4,11	10,40(3,40-14,40)	4,81	4,40	2,16(0,43-3,62)	1080	10,20					
25+25+42+71	1,38	1,38	2,32	3,92	9,00(3,00-11,20)	4,09	8,00	2,20(0,45-3,33)	1100	10,50	1,60	1,60	2,68	4,52	10,40(3,40-14,40)	4,84	4,40	2,15(0,44-3,66)	1075	10,10					
25+25+50+50	1,50	1,50	3,00	3,00	9,00(3,00-11,00)	4,07	8,00	2,21(0,49-3,12)	1105	10,60	1,73	1,73	3,47	3,47	10,40(3,40-14,40)	4,84	4,40	2,15(0,51-3,60)	1075	10,10					
25+25+50+60	1,41	1,41	2,80	3,38	9,00(3,00-11,20)	4,07	8,00	2,21(0,49-3,19)	1105	10,60	1,63	1,63	3,25	3,89	10,40(3,40-14,40)	4,84	4,40	2,15(0,51-3,60)	1075	10,10					
25+25+50+71	1,32	1,32	2,62	3,74	9,00(3,00-11,20)	4,19	8,00	2,15(0,52-3,20)	1075	10,30	1,52	1,52	3,04	4,32	10,40(3,40-14,40)	4,77	4,40	2,18(0,52-3,59)	1090	10,20					
25+25+60+60	1,32	1,32	3,18	3,18	9,00(3,00-11,20)	4,07	8,00	2,21(0,49-3,19)	1105	10,60	1,53	1,53	3,67	3,67	10,40(3,40-14,40)	4,84	4,40	2,15(0,51-3,60)	1075	10,10					
25+25+60+71	1,24	1,24	2,98	3,54	9,00(3,00-11,20)	4,19	8,00	2,15(0,52-3,20)	1075	10,30	1,44	1,44	3,45	4,07	10,40(3,40-14,40)	4,77	4,40	2,18(0,52-3,59)	1090	10,20					
25+35+35+35	1,74	2,42	2,42	2,42	9,00(2,90-10,80)	3,90	8,00	2,31(0,40-3,33)	1155	11,10	2,00	2,00	2,80	2,80	10,40(3,40-14,40)	4,75	4,40	2,19(0,37-3,75)	1095	10,30					
25+35+35+42	1,64	2,30	2,30	2,76	9,00(2,90-10,80)	3,90	8,00	2,31(0,40-3,33)	1155	11,10	1,90	2,66	2,66	3,18	10,40(3,40-14,40)	4,77	4,40	2,18(0,37-3,73)	1090	10,20					
25+35+35+50	1,55	2,17	2,17	3,11	9,00(3,00-11,00)	4,09	8,00	2,20(0,44-3,26)	1100	10,50	1,79	2,51	2,51	3,59	10,40(3,40-14,40)	4,84	4,40	2,15(0,45-3,65)	1075	10,10					
25+35+35+60	1,45	2,03	2,03	3,49	9,00(3,00-11,00)	4,09	8,00	2,20(0,44-3,26)	1100	10,50	1,68	2,35	2,35	4,02	10,40(3,40-14,40)	4,84	4,40	2,15(0,45-3,65)	1075	10,10					
25+35+35+71	1,35	1,90	1,90	3,85	9,00(3,00-11,20)	4,09	8,00	2,20(0,47-3,33)	1100	10,50	1,57	2,19	2,19	4,45	10,40(3,40-14,40)	4,86	4,40	2,14(0,45-3,64)	1070	10,10					
25+35+42+42	1,55	2,19	2,63	2,63	9,00(3,00-11,00)	3,90	8,00	2,31(0,40-3,48)	1155	11,10	1,81	2,53	3,03	3,03	10,40(3,40-14,40)	4,79	4,40	2,17(0,39-3,72)	1085	10,20					
25+35+42+50	1,48	2,07	2,49	2,96	9,00(3,00-11,00)	4,09	8,00	2,20(0,44-3,19)	1100	10,50	1,71	2,39	2,87	3,43	10,40(3,40-14,40)	4,84	4,40	2,15(0,45-3,64)	1075	10,10					
25+35+42+60	1,39	1,95	2,33	3,33	9,00(3,00-11,20)	4,09	8,00	2,20(0,44-3,33)	1100	10,50	1,60	2,25	2,70	3,85	10,40(3,40-14,40)	4,84	4,40	2,15(0,45-3,64)	1075	10,10					
25+35+42+71	1,30	1,82	2,18	3,70	9,00(3,00-11,20)	4,09	8,00	2,20(0,48-3,34)	1100	10,50	1,50	2,10	2,52	4,28	10,40(3,40-14,40)	4,86	4,40	2,14(0,46-3,63)	1070	10,10					
25+35+50+50	1,41	1,97	2,81	2,81	9,00(3,00-11,20)	4,07	8,00	2,21(0,52-3,20)	1105	10,60	1,62	2,28	2,35	3,25	10,40(3,40-14,40)	4,77	4,40	2,18(0,53-3,58)	1090	10,20					
25+35+50+60	1,32	1,85	2,65	3,18	9,00(3,00-11,20)	4,07	8,00	2,21(0,52-3,20)	1105	10,60	1,53	2,14	3,06	3,67	10,40(3,40-14,40)	4,77	4,40	2,18(0,53-3,58)	1090	10,20					
25+35+50+71	1,24	1,74	2,49	3,53	9,00(3,00-11,20)	4,17	8,00	2,16(0,53-3,20)	1080	10,30	1,44	2,01	2,87	4,08	10,40(3,40-14,40)	4,79	4,40	2,17(0,54-3,56)	1085	10,20					
25+35+60+60	1,25	1,75	3,00	3,00	9,00(3,00-11,20)	4,07	8,00	2,21(0,52-3,20)	1105	10,60	1,44	2,02	3,47	3,47	10,40(3,40-14,40)	4,77	4,40	2,18(0,53-3,58)	1090	10,20					
25+42+42+42	1,50	2,50	2,50	2,50	9,00(3,00-11,00)	3,90	8,00	2,31(0,40-3,40)	1155	11,10	1,73	2,89	2,89	2,89	10,40(3,40-14,40)	4,79	4,40	2,17(0,39-3,71)	1085	10,20					
25+42+42+50	1,41	2,38	2,38	2,83	9,00(3,00-11,20)	4,09	8,00	2,20(0,45-3,33)	1100	10,50	1,64	2,75	2,75	3,26	10,40(3,40-14,40)	4,86	4,40	2,14(0,45-3,63)	1070	10,10					
25+42+42+60	1,32	2,24	2,24	3,20	9,00(3,00-11,20)	4,09	8,00	2,20(0,45-3,33)	1100	10,50	1,54	2,58	2,58	3,70	10,40(3,40-14,40)	4,86	4,40	2,14(0,45-3,63)	1070	10,10					
25+42+42+71	1,25	2,10	2,10	3,55	9,00(3,00-11,20)	4,09	8,00	2,20(0,48-3,26)	1100	10,50	1,44	2,43	2,43	4,10	10,40(3,40-14,40)	4,88	4,40	2,13(0,46-3,61)	1065	10,00					
25+42+50+50	1,35	2,27	2,69	2,69	9,00(3,00-11,20)	4,19	8,00	2,15(0,52-3,20)	1075	10,30	1,56	2,62	3,11	3,11	10,40(3,40-14,40)	4,79	4,40	2,17(0,54-3,57)	1085	10,20					
25+42+50+60	1,27	2,14	2,54	3,05	9,00(3,00-11,20)	4,19	8,00	2,15(0,52-3,20)	1075	10,30	1,47	2,47	2,94	3,52	10,40(3,40-14,40)	4,79	4,40	2,17(0,54-3,57)	1085	10,20					
25+50+50+50	1,29	2,57	2,57	2,57	9,00(3,00-11,20)	4,15	8,00	2,17(0,58-3,14)	1085	10,40	1,49	2,97	2,97	2,97	10,40(3,40-14,40)	4,60	4,40	2,26(0,63-3,57)	1130	10,60					
35+35+35+35	2,25	2,25	2,25	2,25	9,00(2,90-10,80)	4,00	8,00	2,25(0,40-3,25)	1125	10,80	2,60	2,60	2,60	2,60	10,40(3,40-14,40)	4,79	4,40	2,17(0,39-3,71)	1085	10,20					
35+35+35+42	2,14	2,14	2,14	2,58	9,00(3,00-11,00)	4,00	8,00	2,25(0,41-3,40)	1125	10,80	2,48	2,48	2,48	2,96	10,40(3,40-14,40)	4,81	4,40	2,16(0,39-3,70)	1080	10,20					
35+35+35+50	2,03	2,03	2,03	2,91	9,00(3,00-11,00)	4,09	8,00	2,20(0,47-3,19)	1100	10,50	2,35	2,35	2,35	3,33	10,40(3,40-14,40)	4,86	4,40	2,14(0,46-3,62)	1070	10,10					
35+35+35+60	1,91	1,91	1,91	3,27	9,00(3,00-11,20)	4,09	8,00	2,20(0,47-3,33)	1100	10,50	2,21	2,21	2,21	3,77	10,40(3,40-14,40)	4,86	4,40	2,14(0,46-3,62)	1070	10,10					
35+35+35+71	1,79	1,79	1,79	3,63	9,00(3,00-11,20)	4,09	8,00	2,20(0,48-3,26)	1100	10,50	2,07	2,07	2,07	4,19	10,40(3,40-14,40)	4,88	4,40	2,13(0,47-3,61)	1065	10,00					
35+35+42+42	2,05	2,05	2,45	2,45	9,00(3,00-11,00)	4,00	8,00	2,25(0,41-3,40)	1125	10,80	2,36	2,36	2,84	2,84	10,40(3,40-14,40)	4,81	4,40	2,16(0,40-3,69)	1080	10,20					
35+35+42+50	1,94	1,94	2,33	2,79	9,00(3,00-11,20)	4,09	8,00	2,20(0,47-3,33)	1100	10,50	2,25	2,25	2,70	3,20	10,40(3,40-14,40)	4,88	4,40	2,13(0,47-3,61)	1065	10,10					
35+35+42+60	1,83	1,83	2,20	3,14	9,00(3,00-11,20)	4,09	8,00	2,20(0,47-3,33)	1100	10,50	2,12	2,12	2,54	3,62	10,40(3,40-14,40)	4,88	4,40	2,13(0,47-3,61)	1065	10,10					
35+35+42+71	1,72	1,72	2,07	3,49	9,00(3,00-11,20)	4,09	8,00	2,20(0,48-3,26)	1100	10,50	1,99	1,99	2,39	4,03	10,40(3,40-14,40)	4,79	4,40	2,17(0,48-3,60)	1085	10,20					
35+35+50+50	1,85	1,85	2,65	2,65	9,00(3,00-11,20)	4,17	8,00	2,16(0,52-3,20)	1080	10,30	2,14	2,14	3,06	3,06	10,40(3,40-14,40)	4,79	4,40	2,17(0,55-3,55)	1085	10,20					
35+35+50+60	1,75	1,75	2,50	3,00	9,00(3,00-11,20)	4,17	8,00	2,16(0,52-3,20)	1080	10,30	2,02	2,02	2,89	3,47	10,40(3,40-14,40)	4,79	4,40	2,17(0,55-3,55)	1085	10,20					
35+42+42+42	1,95	2,35	2,35	2,35	9,00(3,00-11,20)	4,00	8,00	2,25(0,41-3,56)	1125	10,80	2,27	2,71	2,71	2,71	10,40(3,40-14,40)	4,84	4,40	2,15(0,40-3,67)	1075	10,10					
35+42+42+50	1,86	2,24	2,24	2,66	9,00(3,00-11,20)	4,09	8,00	2,20(0,48-3,34)	1100	10,50	2,15	2,58	2,58	3,09	10,40(3,40-14,40)	4,79	4,40	2,17(0,48-3,60)	1085	10,20					
35+42+42+60	1,76	2,11	2,11	3,02	9,00(3,00-11,20)	4,09	8,00	2,20(0,48-3,34)	1100	10,50	2,03	2,44	2,44	3,49	10,40(3,40-14,40)	4,79	4,40	2,17(0,48-3,60)	1085	10,20					
35+42+50+50	1,78	2,14	2,54	2,54	9,00(3,00-11,20)	4,17	8,00	2,16(0,53-3,20)	1080	10,30	2,05	2,47	2,94	3,94	10,40(3,40-14,40)	4,73	4,40	2,20(0,56-3,54)	1100	10,30					
42+42+42+42	2,25	2,25	2,25	2,25	9,00(3,00-11,20)	4,00	8,00	2,25(0,43-3,48)	1125	10,80	2,60	2,60	2,60	2,60	10,40(3,40-14,40)	4,86	4,40	2,14(0,40-3,66)	1070	10,10					
42+42+42+50	2,15	2,15	2,15	2,55	9,00(3,00-11,20)	4,09	8,00	2,20(0,48-3,26)	1100	10,50	2,48	2,48	2,48	2,96	10,40(3,40-14,40)	4,81	4,40	2,16(0,48-3,59)	1080	10,20					
5 Rooms																									
16+16+16+16+16	1,60	1,60	1,60	1,60	8,40(2,90-11,50)	4,28	8,50	2,27(0,45-3,56)	935	9,00	2,08	2,08	2,08	2,08	10,40(3,40-14,50)	4,81	4,40	2,16(0,43-3,67)	1080	10,20					
16+16+16+16+20	1,60	1,60	1,60	2,00	8,40(2,90-11,50)	4,24	8,50	1,98(0,45-3,56)	990	9,50	1,98	1,98	1,98	2,48	10,40(3,40-14,50)	4,84	4,50	2,15(0,44-3,66)	1075	10,10					
16+16+16+16+25	1,62	1,62	1,62	2,52	9,00(2,90-11,50)	4,09	8,50	2,20(0,45-3,56)	1100	10,50	1,87	1,87	1,87	2,92	10,40(3,40-14,50)	4,84	4,68	2,15(0,44-3,66)	1075	10,10					
16+16+16+16+35	1,45	1,45	1,45	3,20	9,00(2,90-11,50)	4,09	8,50	2,20(0,45-3,49)	1100	10,50	1,68	1,68	1,68	3,68	10,40(3,40-14,50)	4,86	4,68	2,14(0,45-3,63)	1070	10,10					

Free Multi R32 combinations table

Free Multi 5x1 CU-5Z90TBE. Minimum capacity connected: 4,50kW. Maximum capacity connected: 18,30kW • R32 GAS

Indoor unit capacity	Cooling capacity (kW). Rooms					EER	SEER ¹	Input power rating			A.E.C.	Current	Heating capacity (kW). Rooms					COP	SCOP ¹	Input power rating			A.E.C.	Current
	A	B	C	D	E			Total (Min - Max)	W/W	kW			kWh	230V	A	B	C			D	E	Total (Min - Max)		
16+16+20+25+42	1.21	1.21	1.51	1.89	3.18	9,00(2,90-11,50)	4,09	8,50	2,20(0,48-3,41)	1100	10,50	1,40	1,40	1,75	2,18	3,67	10,40(3,40-14,50)	4,79	4,68	2,17(0,48-3,65)	1085	10,20		
16+16+20+25+50	1.13	1.13	1.42	1.77	3.55	9,00(2,90-11,50)	4,17	8,50	2,16(0,53-3,28)	1080	10,30	1,31	1,31	1,64	2,05	4,09	10,40(3,40-14,50)	4,73	4,68	2,20(0,56-3,59)	1100	10,30		
16+16+20+25+60	1.05	1.05	1.31	1.64	3.95	9,00(2,90-11,50)	4,17	8,50	2,16(0,53-3,28)	1080	10,30	1,21	1,21	1,52	1,90	4,56	10,40(3,40-14,50)	4,73	4,68	2,20(0,56-3,59)	1100	10,30		
16+16+20+25+71	0.97	0.97	1.22	1.52	4.32	9,00(2,90-11,50)	4,15	8,50	2,17(0,57-3,28)	1085	10,40	1,12	1,12	1,41	1,76	4,99	10,40(3,40-14,50)	4,73	4,68	2,20(0,57-3,58)	1100	10,30		
16+16+20+35+35	1.18	1.18	1.48	2.58	2.58	9,00(2,90-11,50)	4,07	8,50	2,21(0,49-3,41)	1105	10,60	1,36	1,36	1,72	2,98	2,98	10,40(3,40-14,50)	4,81	4,68	2,16(0,49-3,63)	1080	10,20		
16+16+20+35+42	1.12	1.12	1.40	2.44	2.92	9,00(2,90-11,50)	4,07	8,50	2,21(0,49-3,41)	1105	10,60	1,29	1,29	1,61	2,82	3,39	10,40(3,40-14,50)	4,84	4,68	2,15(0,50-3,62)	1075	10,10		
16+16+20+35+50	1.05	1.05	1.31	2.30	3.29	9,00(2,90-11,50)	4,15	8,50	2,17(0,54-3,28)	1085	10,40	1,21	1,21	1,52	2,66	3,80	10,40(3,40-14,50)	4,73	4,68	2,20(0,59-3,62)	1100	10,30		
16+16+20+35+60	0.98	0.98	1.22	2.14	3.68	9,00(2,90-11,50)	4,15	8,50	2,17(0,54-3,28)	1085	10,40	1,13	1,13	1,41	2,48	4,25	10,40(3,40-14,50)	4,73	4,68	2,20(0,59-3,62)	1100	10,30		
16+16+20+35+71	0.91	0.91	1.14	1.99	4.05	9,00(2,90-11,50)	4,15	8,50	2,17(0,57-3,29)	1085	10,40	1,05	1,05	1,32	2,30	4,68	10,40(3,40-14,50)	4,66	4,68	2,23(0,60-3,61)	1115	10,50		
16+16+20+42+42	1.06	1.06	1.32	2.78	2.78	9,00(2,90-11,50)	4,07	8,50	2,21(0,49-3,42)	1105	10,60	1,22	1,22	1,54	3,21	3,21	10,40(3,40-14,50)	4,84	4,68	2,15(0,51-3,61)	1075	10,10		
16+16+20+42+50	1.00	1.00	1.25	2.63	3.12	9,00(2,90-11,50)	4,15	8,50	2,17(0,57-3,28)	1085	10,40	1,16	1,16	1,44	3,03	3,61	10,40(3,40-14,50)	4,75	4,68	2,19(0,60-3,61)	1095	10,30		
16+16+20+42+60	0.94	0.94	1.17	2.45	3.50	9,00(2,90-11,50)	4,15	8,50	2,17(0,57-3,28)	1085	10,40	1,08	1,08	1,35	2,84	4,05	10,40(3,40-14,50)	4,75	4,68	2,19(0,60-3,61)	1095	10,30		
16+16+20+42+71	0.87	0.87	1.09	2.29	3.88	9,00(2,90-11,50)	4,15	8,50	2,17(0,58-3,29)	1085	10,40	1,01	1,01	1,26	2,65	4,47	10,40(3,40-14,50)	4,66	4,68	2,17(0,48-3,60)	1115	10,50		
16+16+20+50+50	0.95	0.95	1.18	2.96	2.96	9,00(2,90-11,50)	3,98	8,50	2,26(0,63-3,23)	1130	10,80	1,09	1,09	1,38	3,42	3,42	10,40(3,40-14,50)	4,54	4,68	2,29(0,70-3,62)	1145	10,80		
16+16+20+50+60	0.89	0.89	1.11	2.78	3.33	9,00(2,90-11,50)	3,98	8,50	2,26(0,63-3,23)	1130	10,80	1,03	1,03	1,28	3,21	3,85	10,40(3,40-14,50)	4,54	4,68	2,29(0,70-3,62)	1145	10,80		
16+16+20+50+71	0.83	0.83	1.04	2.60	3.70	9,00(2,90-11,50)	3,96	8,50	2,27(0,66-3,24)	1135	10,90	0,96	0,96	1,20	3,01	4,27	10,40(3,40-14,50)	4,46	4,68	2,33(0,71-3,66)	1165	10,90		
16+16+20+60+60	0.84	0.84	1.04	3.14	3.14	9,00(2,90-11,50)	3,98	8,50	2,26(0,63-3,23)	1130	10,80	0,97	0,97	1,20	3,63	3,63	10,40(3,40-14,50)	4,54	4,68	2,29(0,70-3,62)	1145	10,80		
16+16+20+60+71	0.79	0.79	0.98	2.95	3.49	9,00(2,90-11,50)	3,96	8,50	2,21(0,49-3,41)	1105	10,60	0,91	0,91	1,14	3,41	4,03	10,40(3,40-14,50)	4,46	4,68	2,33(0,71-3,66)	1165	10,90		
16+16+25+25+25	1.35	1.35	2.10	2.10	2.10	9,00(2,90-11,50)	4,09	8,50	2,20(0,45-3,49)	1100	10,50	1,55	1,55	2,43	2,43	2,43	10,39(3,40-14,50)	4,86	4,68	2,14(0,45-3,64)	1070	10,10		
16+16+25+25+35	1.23	1.23	1.92	1.92	2.70	9,00(2,90-11,50)	4,09	8,50	2,20(0,48-3,49)	1100	10,50	1,42	1,42	2,22	2,22	3,12	10,40(3,40-14,50)	4,88	4,68	2,13(0,47-3,66)	1065	10,00		
16+16+25+25+42	1.16	1.16	1.81	1.81	3.06	9,00(2,90-11,50)	4,09	8,50	2,20(0,48-3,41)	1100	10,50	1,34	1,34	2,10	2,10	3,52	10,40(3,40-14,50)	4,79	4,68	2,17(0,48-3,65)	1085	10,20		
16+16+25+25+50	1.09	1.09	1.70	1.70	3.42	9,00(2,90-11,50)	4,17	8,50	2,16(0,53-3,28)	1080	10,30	1,26	1,26	1,97	1,97	3,94	10,40(3,40-14,50)	4,73	4,68	2,20(0,56-3,59)	1100	10,30		
16+16+25+25+60	1.01	1.01	1.58	1.58	3.82	9,00(2,90-11,50)	4,17	8,50	2,16(0,53-3,28)	1080	10,30	1,17	1,17	1,83	1,83	4,40	10,40(3,40-14,50)	4,73	4,68	2,20(0,56-3,59)	1100	10,30		
16+16+25+25+71	0.94	0.94	1.47	1.47	4.18	9,00(2,90-11,50)	4,15	8,50	2,17(0,57-3,28)	1085	10,40	1,09	1,09	1,70	1,70	4,82	10,40(3,40-14,50)	4,73	4,68	2,20(0,57-3,58)	1100	10,30		
16+16+25+35+35	1.13	1.13	1.78	2.48	2.48	9,00(2,90-11,50)	4,07	8,50	2,21(0,49-3,41)	1105	10,60	1,31	1,31	2,04	2,87	2,87	10,40(3,40-14,50)	4,81	4,68	2,16(0,49-3,63)	1080	10,20		
16+16+25+35+42	1.07	1.07	1.68	2.35	2.83	9,00(2,90-11,50)	4,07	8,50	2,21(0,49-3,41)	1105	10,60	1,24	1,24	1,94	2,72	3,26	10,40(3,40-14,50)	4,84	4,68	2,15(0,50-3,62)	1075	10,10		
16+16+25+35+50	1.01	1.01	1.58	2.22	3.18	9,00(2,90-11,50)	4,15	8,50	2,17(0,54-3,28)	1085	10,40	1,17	1,17	1,83	2,56	3,67	10,40(3,40-14,50)	4,73	4,68	2,20(0,59-3,62)	1100	10,30		
16+16+25+35+60	0.95	0.95	1.48	2.07	3.55	9,00(2,90-11,50)	4,15	8,50	2,17(0,54-3,28)	1085	10,40	1,09	1,09	1,71	2,39	4,12	10,40(3,40-14,50)	4,73	4,68	2,20(0,59-3,62)	1100	10,30		
16+16+25+35+71	0.88	0.88	1.38	1.93	3.93	9,00(2,90-11,50)	4,15	8,50	2,17(0,57-3,29)	1085	10,40	1,02	1,02	1,60	2,23	4,53	10,40(3,40-14,50)	4,66	4,68	2,23(0,60-3,61)	1115	10,50		
16+16+25+42+42	1.02	1.02	1.60	2.68	2.68	9,00(2,90-11,50)	4,07	8,50	2,21(0,49-3,42)	1105	10,60	1,18	1,18	1,84	3,10	3,10	10,40(3,40-14,50)	4,84	4,68	2,15(0,51-3,61)	1075	10,10		
16+16+25+42+50	0.97	0.97	1.51	2.54	3.01	9,00(2,90-11,50)	4,15	8,50	2,17(0,57-3,28)	1085	10,40	1,12	1,12	1,74	2,93	3,49	10,40(3,40-14,50)	4,75	4,68	2,19(0,60-3,61)	1095	10,30		
16+16+25+42+60	0.91	0.91	1.42	2.38	3.38	9,00(2,90-11,50)	4,15	8,50	2,17(0,57-3,28)	1085	10,40	1,05	1,05	1,64	2,75	3,91	10,40(3,40-14,50)	4,75	4,68	2,19(0,60-3,61)	1095	10,30		
16+16+25+42+71	0.85	0.85	1.32	2.22	3.76	9,00(2,90-11,50)	4,15	8,50	2,17(0,58-3,29)	1085	10,40	0,98	0,98	1,53	2,57	4,34	10,40(3,40-14,50)	4,66	4,68	2,23(0,60-3,60)	1115	10,50		
16+16+25+50+50	0.92	0.92	1.42	2.87	2.87	9,00(2,90-11,50)	3,98	8,50	2,26(0,63-3,23)	1130	10,80	1,06	1,06	1,66	3,31	3,31	10,40(3,40-14,50)	4,54	4,68	2,29(0,70-3,62)	1145	10,80		
16+16+25+50+60	0.86	0.86	1.35	2.69	3.24	9,00(2,90-11,50)	3,98	8,50	2,26(0,63-3,23)	1130	10,80	1,00	1,00	1,56	3,11	3,73	10,40(3,40-14,50)	4,54	4,68	2,29(0,70-3,62)	1145	10,80		
16+16+25+50+71	0.81	0.81	1.26	2.53	3.59	9,00(2,90-11,50)	3,96	8,50	2,27(0,66-3,24)	1135	10,90	0,93	0,93	1,46	2,92	4,16	10,40(3,40-14,50)	4,46	4,68	2,33(0,71-3,66)	1165	10,90		
16+16+25+60+60	0.81	0.81	1.28	3.05	3.05	9,00(2,90-11,50)	3,98	8,50	2,26(0,63-3,23)	1130	10,80	0,94	0,94	1,46	3,53	3,53	10,40(3,40-14,50)	4,54	4,68	2,29(0,70-3,62)	1145	10,80		
16+16+35+35+35	1.05	1.05	2.30	2.30	2.30	9,00(2,90-11,50)	4,07	8,50	2,21(0,49-3,42)	1105	10,60	1,21	1,21	2,66	2,66	2,66	10,40(3,40-14,50)	4,84	4,68	2,15(0,51-3,60)	1075	10,10		
16+16+35+35+42	1.00	1.00	2.19	2.19	2.62	9,00(2,90-11,50)	4,07	8,50	2,21(0,49-3,42)	1105	10,60	1,16	1,16	2,63	2,63	3,02	10,40(3,40-14,50)	4,77	4,68	2,18(0,51-3,59)	1090	10,20		
16+16+35+35+50	0.95	0.95	2.07	2.07	2.96	9,00(2,90-11,50)	4,15	8,50	2,17(0,57-3,28)	1085	10,40	1,09	1,09	2,39	2,39	3,44	10,40(3,40-14,50)	4,66	4,68	2,23(0,61-3,59)	1115	10,50		
16+16+35+35+60	0.89	0.89	1.94	1.94	3.34	9,00(2,90-11,50)	4,15	8,50	2,17(0,57-3,28)	1085	10,40	1,03	1,03	2,25	2,25	3,84	10,40(3,40-14,50)	4,66	4,68	2,23(0,61-3,59)	1115	10,50		
16+16+35+35+71	0.83	0.83	1.82	1.82	3.70	9,00(2,90-11,50)	4,13	8,50	2,18(0,58-3,29)	1090	10,40	0,96	0,96	2,10	2,10	4,28	10,40(3,40-14,50)	4,66	4,68	2,23(0,62-3,58)	1115	10,50		
16+16+35+42+42	0.95	0.95	2.10	2.50	2.50	9,00(2,90-11,50)	4,07	8,50	2,21(0,49-3,41)	1105	10,60	1,10	1,10	2,42	2,89	2,89	10,40(3,40-14,50)	4,77	4,68	2,18(0,52-3,64)	1090	10,20		
16+16+35+42+50	0.91	0.91	1.98	2.38	2.82	9,00(2,90-11,50)	4,15	8,50	2,17(0,57-3,29)	1085	10,40	1,10	1,10	2,29	2,75	3,26	10,40(3,40-14,50)	4,66	4,68	2,23(0,62-3,59)	1115	10,50		
16+16+35+42+60	0.85	0.85	1.86	2.24																				

Free Multi 5x1 CU-5Z90TBE. Minimum capacity connected: 4,50kW. Maximum capacity connected: 18,30kW • R32 GAS

Indoor unit capacity	Cooling capacity (kW). Rooms					EER	SEER ¹	Input power rating			A.E.C.	Current	Heating capacity (kW). Rooms					COP	SCOP ¹	Input power rating			A.E.C.	Current
	A	B	C	D	E			Total (Min-Max)	W/W	kW			kWh	230V	A	B	C			D	E	Total (Min-Max)		
16+20+25+35+71	0.86	1.08	1.35	1.89	3.82	9.00(2.90-11.50)	4.13	8.50	2.18(0.58-3.29)	1090	10.40	1.00	1.25	1.56	2.18	4.41	10.40(3.40-14.50)	4.66	4.68	2.23(0.60-3.60)	1115	10.50		
16+20+25+42+42	0.99	1.24	1.55	2.61	2.61	9.00(2.90-11.50)	4.07	8.50	2.21(0.49-3.42)	1105	10.60	1.15	1.43	1.80	3.01	3.01	10.40(3.40-14.50)	4.84	4.68	2.15(0.51-3.60)	1075	10.10		
16+20+25+42+50	0.94	1.18	1.47	2.47	2.94	9.00(2.90-11.50)	4.15	8.50	2.17(0.57-3.28)	1085	10.40	1.09	1.36	1.70	2.85	3.40	10.40(3.40-14.50)	4.66	4.68	2.23(0.60-3.60)	1115	10.50		
16+20+25+42+60	0.88	1.10	1.38	2.32	3.32	9.00(2.90-11.50)	4.15	8.50	2.17(0.57-3.28)	1085	10.40	1.02	1.28	1.60	2.68	3.82	10.40(3.40-14.50)	4.66	4.68	2.23(0.60-3.60)	1115	10.50		
16+20+25+42+71	0.83	1.03	1.29	2.17	3.68	9.00(2.90-11.50)	4.13	8.50	2.18(0.58-3.29)	1090	10.40	0.96	1.20	1.49	2.51	4.24	10.40(3.40-14.50)	4.66	4.68	2.23(0.62-3.59)	1115	10.50		
16+20+25+50+50	0.89	1.12	1.39	2.80	2.80	9.00(2.90-11.50)	3.98	8.50	2.26(0.63-3.23)	1130	10.80	1.03	1.29	1.62	3.23	3.23	10.40(3.40-14.50)	4.46	4.68	2.33(0.71-3.61)	1165	10.90		
16+20+25+50+60	0.84	1.05	1.32	2.63	3.16	9.00(2.90-11.50)	3.98	8.50	2.26(0.63-3.23)	1130	10.80	0.97	1.22	1.52	3.04	3.65	10.40(3.40-14.50)	4.46	4.68	2.33(0.71-3.61)	1165	10.90		
16+20+25+50+71	0.79	0.99	1.24	2.47	3.51	9.00(2.90-11.50)	3.96	8.50	2.27(0.67-3.24)	1135	10.90	0.91	1.14	1.43	2.86	4.06	10.40(3.40-14.50)	4.46	4.68	2.33(0.72-3.66)	1165	10.90		
16+20+25+60+60	0.80	0.99	1.25	2.98	2.98	9.00(2.90-11.50)	3.98	8.50	2.26(0.63-3.23)	1130	10.80	0.91	1.15	1.44	3.45	3.45	10.40(3.40-14.50)	4.46	4.68	2.33(0.71-3.61)	1165	10.90		
16+20+25+60+71	1.02	1.29	2.23	2.23	2.23	9.00(2.90-11.50)	4.07	8.50	2.21(0.49-3.34)	1105	10.60	1.18	1.48	2.58	2.58	2.58	10.40(3.40-14.50)	4.77	4.68	2.18(0.51-3.59)	1090	10.20		
16+20+35+35+42	0.97	1.22	2.13	2.13	2.55	9.00(2.90-11.50)	4.19	8.50	2.15(0.49-3.34)	1075	10.30	1.12	1.41	2.46	2.46	2.95	10.40(3.40-14.50)	4.77	4.68	2.18(0.52-3.64)	1090	10.20		
16+20+35+35+50	0.92	1.15	2.02	2.02	2.89	9.00(2.90-11.50)	4.15	8.50	2.17(0.57-3.29)	1085	10.40	1.07	1.33	2.33	2.33	3.34	10.40(3.40-14.50)	4.66	4.68	2.23(0.62-3.59)	1115	10.50		
16+20+35+35+60	0.87	1.08	1.90	1.90	3.25	9.00(2.90-11.50)	4.15	8.50	2.17(0.57-3.29)	1085	10.40	1.00	1.25	2.19	2.19	3.77	10.40(3.40-14.50)	4.66	4.68	2.23(0.62-3.59)	1115	10.50		
16+20+35+35+71	0.81	1.02	1.78	1.78	3.61	9.00(2.90-11.50)	4.13	8.50	2.18(0.58-3.29)	1090	10.40	0.94	1.18	2.06	2.06	4.16	10.40(3.40-14.50)	4.68	4.68	2.22(0.63-3.63)	1110	10.40		
16+20+35+42+42	0.93	1.16	2.03	2.44	2.44	9.00(2.90-11.50)	4.19	8.50	2.15(0.49-3.34)	1075	10.30	1.07	1.34	2.35	2.82	2.82	10.40(3.40-14.50)	4.77	4.68	2.18(0.53-3.63)	1090	10.20		
16+20+35+42+50	0.88	1.10	1.93	2.32	2.77	9.00(2.90-11.50)	4.13	8.50	2.18(0.58-3.29)	1090	10.40	1.02	1.28	2.23	2.68	3.19	10.40(3.40-14.50)	4.66	4.68	2.23(0.63-3.63)	1115	10.50		
16+20+35+42+60	0.83	1.04	1.82	2.18	3.13	9.00(2.90-11.50)	4.13	8.50	2.18(0.58-3.29)	1090	10.40	0.96	1.20	2.10	2.52	3.62	10.40(3.40-14.50)	4.66	4.68	2.23(0.63-3.63)	1115	10.50		
16+20+35+42+71	0.84	1.05	1.85	2.63	2.63	9.00(2.90-11.50)	3.96	8.50	2.27(0.66-3.24)	1135	10.90	0.97	1.22	1.53	3.04	3.04	10.40(3.40-14.50)	4.46	4.68	2.33(0.74-3.65)	1165	10.90		
16+20+35+50+60	0.80	0.99	1.74	2.49	2.98	9.00(2.90-11.50)	3.96	8.50	2.27(0.66-3.24)	1135	10.90	0.92	1.15	2.01	2.87	3.45	10.40(3.40-14.50)	4.46	4.68	2.33(0.74-3.65)	1165	10.90		
16+20+42+42+42	0.89	1.12	2.33	2.33	2.33	9.00(2.90-11.50)	4.19	8.50	2.15(0.52-3.34)	1075	10.30	1.02	1.28	2.70	2.70	2.70	10.40(3.40-14.50)	4.79	4.68	2.17(0.54-3.62)	1085	10.20		
16+20+42+42+50	0.85	1.06	2.22	2.22	2.65	9.00(2.90-11.50)	4.13	8.50	2.18(0.58-3.29)	1090	10.40	0.98	1.22	2.57	2.57	3.06	10.40(3.40-14.50)	4.60	4.68	2.26(0.63-3.62)	1130	10.60		
16+20+42+42+60	0.80	1.00	2.10	2.10	3.00	9.00(2.90-11.50)	4.13	8.50	2.18(0.58-3.29)	1090	10.40	0.92	1.16	2.43	2.43	3.46	10.40(3.40-14.50)	4.60	4.68	2.26(0.63-3.62)	1130	10.60		
16+20+42+50+50	0.81	1.01	2.12	2.53	2.53	9.00(2.90-11.50)	3.96	8.50	2.27(0.67-3.24)	1135	10.90	0.93	1.17	2.46	2.92	2.92	10.40(3.40-14.50)	4.41	4.68	2.36(0.75-3.64)	1180	11.10		
16+25+25+25+25	1.24	1.94	1.94	1.94	1.94	9.00(2.90-11.50)	4.09	8.50	2.20(0.45-3.49)	1100	10.50	1.44	2.24	2.24	2.24	2.24	10.40(3.40-14.50)	4.86	4.68	2.14(0.46-3.68)	1070	10.10		
16+25+25+25+35	1.14	1.79	1.79	1.79	2.49	9.00(2.90-11.50)	4.09	8.50	2.20(0.48-3.41)	1100	10.50	1.32	2.06	2.06	2.06	2.90	10.40(3.40-14.50)	4.79	4.68	2.17(0.48-3.65)	1085	10.20		
16+25+25+25+42	1.08	1.69	1.69	1.69	2.85	9.00(2.90-11.50)	4.07	8.50	2.21(0.48-3.41)	1105	10.60	1.25	1.95	1.95	1.95	3.30	10.40(3.40-14.50)	4.81	4.68	2.16(0.48-3.64)	1080	10.20		
16+25+25+25+50	1.02	1.60	1.60	1.60	3.18	9.00(2.90-11.50)	4.17	8.50	2.16(0.54-3.28)	1080	10.30	1.18	1.84	1.84	1.84	3.70	10.40(3.40-14.50)	4.73	4.68	2.20(0.57-3.58)	1100	10.30		
16+25+25+25+60	0.95	1.49	1.49	1.49	3.58	9.00(2.90-11.50)	4.17	8.50	2.16(0.54-3.28)	1080	10.30	1.10	1.72	1.72	1.72	4.14	10.40(3.40-14.50)	4.73	4.68	2.20(0.57-3.58)	1100	10.30		
16+25+25+25+71	0.89	1.39	1.39	1.39	3.94	9.00(2.90-11.50)	4.15	8.50	2.17(0.57-3.28)	1085	10.40	1.03	1.60	1.60	1.60	4.57	10.40(3.40-14.50)	4.73	4.68	2.20(0.58-3.62)	1100	10.30		
16+25+25+35+35	1.06	1.65	1.65	2.32	2.32	9.00(2.90-11.50)	4.07	8.50	2.21(0.49-3.41)	1105	10.60	1.22	1.91	1.91	2.68	2.68	10.40(3.40-14.50)	4.84	4.68	2.15(0.50-3.62)	1075	10.10		
16+25+25+35+42	1.01	1.57	1.57	2.20	2.65	9.00(2.90-11.50)	4.07	8.50	2.21(0.49-3.42)	1105	10.60	1.16	1.82	1.82	2.55	3.05	10.40(3.40-14.50)	4.84	4.68	2.15(0.51-3.61)	1075	10.10		
16+25+25+35+50	0.95	1.49	1.49	2.09	2.98	9.00(2.90-11.50)	4.15	8.50	2.17(0.57-3.28)	1085	10.40	1.10	1.72	1.72	2.41	3.45	10.40(3.40-14.50)	4.75	4.68	2.19(0.60-3.61)	1095	10.30		
16+25+25+35+60	0.89	1.40	1.40	1.96	3.35	9.00(2.90-11.50)	4.15	8.50	2.17(0.57-3.28)	1085	10.40	1.03	1.61	1.61	2.26	3.89	10.40(3.40-14.50)	4.75	4.68	2.19(0.60-3.61)	1095	10.30		
16+25+25+35+71	0.84	1.31	1.31	1.83	3.71	9.00(2.90-11.50)	4.13	8.50	2.18(0.58-3.29)	1090	10.40	0.97	1.51	1.51	2.12	4.29	10.40(3.40-14.50)	4.66	4.68	2.23(0.60-3.60)	1115	10.50		
16+25+25+42+42	0.96	1.50	1.50	2.52	2.52	9.00(2.90-11.50)	4.07	8.50	2.21(0.49-3.42)	1105	10.60	1.12	1.73	1.73	2.91	2.91	10.40(3.40-14.50)	4.84	4.68	2.15(0.51-3.60)	1075	10.10		
16+25+25+42+50	0.91	1.42	1.42	2.33	2.86	9.00(2.90-11.50)	4.15	8.50	2.17(0.57-3.28)	1085	10.40	1.05	1.65	1.65	2.76	3.29	10.40(3.40-14.50)	4.66	4.68	2.23(0.60-3.60)	1115	10.50		
16+25+25+42+60	0.86	1.34	1.34	2.25	3.21	9.00(2.90-11.50)	4.15	8.50	2.17(0.57-3.28)	1085	10.40	0.99	1.55	1.55	2.60	3.71	10.40(3.40-14.50)	4.66	4.68	2.23(0.60-3.60)	1115	10.50		
16+25+25+42+71	0.80	1.26	1.26	2.11	3.57	9.00(2.90-11.50)	4.13	8.50	2.18(0.58-3.29)	1090	10.40	0.93	1.45	1.45	2.44	4.13	10.40(3.40-14.50)	4.66	4.68	2.23(0.62-3.59)	1115	10.50		
16+25+25+50+50	0.86	1.36	1.36	2.71	2.71	9.00(2.90-11.50)	3.98	8.50	2.26(0.63-3.23)	1130	10.80	1.00	1.57	1.57	3.13	3.13	10.40(3.40-14.50)	4.46	4.68	2.33(0.71-3.61)	1165	10.90		
16+25+25+50+60	0.82	1.28	1.28	2.56	3.06	9.00(2.90-11.50)	3.98	8.50	2.26(0.63-3.23)	1130	10.80	0.95	1.48	1.48	2.95	3.54	10.40(3.40-14.50)	4.46	4.68	2.33(0.71-3.61)	1165	10.90		
16+25+35+35+35	0.99	1.53	2.16	2.16	2.16	9.00(2.90-11.50)	4.07	8.50	2.21(0.49-3.34)	1105	10.60	1.14	1.79	2.49	2.49	2.49	10.40(3.40-14.50)	4.77	4.68	2.18(0.51-3.59)	1090	10.20		
16+25+35+35+42	0.94	1.47	2.06	2.06	2.47	9.00(2.90-11.50)	4.19	8.50	2.15(0.49-3.34)	1075	10.30	1.09	1.70	2.38	2.38	2.85	10.40(3.40-14.50)	4.77	4.68	2.18(0.52-3.64)	1090	10.20		
16+25+35+35+50	0.89	1.40	1.96	1.96	2.79	9.00(2.90-11.50)	4.15	8.50	2.17(0.57-3.29)	1085	10.40	1.03	1.61	2.26	2.26	3.24	10.40(3.40-14.50)	4.66	4.68	2.23(0.62-3.59)	1115	10.50		
16+25+35+35+60	0.84	1.32	1.84	1.84	3.16	9.00(2.90-11.50)	4.15	8.50	2.17(0.57-3.29)	1085	10.40	0.97	1.52	2.13	3.65	3.65	10.40(3.40-14.50)	4.66	4.68	2.23(0.62-3.59)	1115	10.50		
16+25+35+35+71	0.79	1.24	1.73	1.73	3.51	9.00(2.90-11.50)																		

Free Multi R32 combinations table

Free Multi 5x1 CU-5Z90TBE. Minimum capacity connected: 4,50kW. Maximum capacity connected: 18,30kW • R32 GAS

Indoor unit capacity	Cooling capacity (kW). Rooms					EER	SEER ¹	Input power rating			A.E.C.	Current	Heating capacity (kW). Rooms					COP	SCOP ¹	Input power rating			A.E.C.	Current
	A	B	C	D	E			Total (Min - Max)	W/W	kW			kWh	230V	A	B	C			D	E	Total (Min - Max)		
20+20+25+25+60	1,20	1,20	1,50	1,50	3,60	9,00(2,90-11,50)	4,15	8,50	2,17(0,54-3,28)	1085	10,40	1,39	1,39	1,73	1,73	4,16	10,40(3,40-14,50)	4,73	4,68	2,20(0,58-3,63)	1100	10,30		
20+20+25+25+71	1,12	1,12	1,40	1,40	3,96	9,00(2,90-11,50)	4,15	8,50	2,17(0,57-3,28)	1085	10,40	1,29	1,29	1,61	1,61	4,60	10,40(3,40-14,50)	4,75	4,68	2,19(0,59-3,61)	1095	10,30		
20+20+25+35+35	1,33	1,33	1,68	2,33	2,33	9,00(2,90-11,50)	4,07	8,50	2,21(0,49-3,42)	1105	10,60	1,54	1,54	1,92	2,70	2,70	10,40(3,40-14,50)	4,84	4,68	2,15(0,51-3,61)	1075	10,10		
20+20+25+35+42	1,27	1,27	1,58	2,22	2,66	9,00(2,90-11,50)	4,07	8,50	2,21(0,49-3,42)	1105	10,60	1,46	1,46	1,83	2,56	3,09	10,40(3,40-14,50)	4,84	4,68	2,15(0,51-3,60)	1075	10,10		
20+20+25+35+50	1,20	1,20	1,50	2,10	3,00	9,00(2,90-11,50)	4,15	8,50	2,17(0,57-3,28)	1085	10,40	1,39	1,39	1,73	2,43	3,46	10,40(3,40-14,50)	4,66	4,68	2,23(0,60-3,60)	1115	10,50		
20+20+25+35+60	1,13	1,13	1,41	1,97	3,36	9,00(2,90-11,50)	4,15	8,50	2,17(0,57-3,28)	1085	10,40	1,30	1,30	1,63	2,28	3,89	10,40(3,40-14,50)	4,66	4,68	2,23(0,60-3,60)	1115	10,50		
20+20+25+35+71	1,05	1,05	1,32	1,84	3,74	9,00(2,90-11,50)	4,13	8,50	2,18(0,58-3,29)	1090	10,40	1,22	1,22	1,52	2,13	4,31	10,40(3,40-14,50)	4,66	4,68	2,23(0,62-3,59)	1115	10,50		
20+20+25+42+42	1,21	1,21	1,50	2,54	2,54	9,00(2,90-11,50)	4,07	8,50	2,21(0,49-3,42)	1105	10,60	1,40	1,40	1,74	2,93	2,93	10,40(3,40-14,50)	4,77	4,68	2,18(0,52-3,59)	1090	10,20		
20+20+25+42+50	1,15	1,15	1,43	2,41	2,86	9,00(2,90-11,50)	4,15	8,50	2,17(0,57-3,28)	1085	10,40	1,32	1,32	1,66	2,78	3,32	10,40(3,40-14,50)	4,66	4,68	2,23(0,61-3,59)	1115	10,50		
20+20+25+42+60	1,08	1,08	1,35	2,26	3,23	9,00(2,90-11,50)	4,15	8,50	2,17(0,57-3,28)	1085	10,40	1,25	1,25	1,56	2,62	3,72	10,40(3,40-14,50)	4,66	4,68	2,23(0,61-3,59)	1115	10,50		
20+20+25+42+71	1,01	1,01	1,26	2,12	3,60	9,00(2,90-11,50)	4,13	8,50	2,18(0,58-3,29)	1090	10,40	1,17	1,17	1,46	2,45	4,15	10,40(3,40-14,50)	4,66	4,68	2,23(0,63-3,63)	1115	10,50		
20+20+25+50+50	1,09	1,09	1,36	2,73	2,73	9,00(2,90-11,50)	3,98	8,50	2,26(0,66-3,23)	1130	10,80	1,26	1,26	1,58	3,15	3,15	10,40(3,40-14,50)	4,46	4,68	2,33(0,72-3,66)	1165	10,90		
20+20+25+50+60	1,03	1,03	1,29	2,57	3,08	9,00(2,90-11,50)	3,98	8,50	2,26(0,66-3,23)	1130	10,80	1,19	1,19	1,49	2,97	3,56	10,40(3,40-14,50)	4,46	4,68	2,33(0,72-3,66)	1165	10,90		
20+20+35+35+35	1,24	1,24	2,17	2,17	2,17	8,99(2,90-11,50)	4,18	8,50	2,15(0,49-3,34)	1075	10,30	1,43	1,43	2,51	2,51	2,51	10,39(3,40-14,50)	4,77	4,68	2,18(0,52-3,64)	1090	10,20		
20+20+35+35+42	1,18	1,18	2,07	2,07	2,50	9,00(2,90-11,50)	4,19	8,50	2,15(0,50-3,34)	1075	10,30	1,37	1,37	2,39	2,39	2,88	10,40(3,40-14,50)	4,77	4,68	2,18(0,53-3,63)	1090	10,20		
20+20+35+35+50	1,13	1,13	1,97	1,97	2,80	9,00(2,90-11,50)	4,13	8,50	2,18(0,58-3,29)	1090	10,40	1,30	1,30	2,28	2,28	3,24	10,40(3,40-14,50)	4,66	4,68	2,23(0,63-3,63)	1115	10,50		
20+20+35+35+60	1,06	1,06	1,85	1,85	3,18	9,00(2,90-11,50)	4,13	8,50	2,18(0,58-3,29)	1090	10,40	1,22	1,22	2,14	2,14	3,68	10,40(3,40-14,50)	4,66	4,68	2,23(0,63-3,63)	1115	10,50		
20+20+35+35+71	0,99	0,99	1,74	1,74	3,54	9,00(2,90-11,50)	4,13	8,50	2,18(0,61-3,29)	1090	10,40	1,15	1,15	2,01	2,01	4,08	10,40(3,40-14,50)	4,60	4,68	2,23(0,64-3,62)	1130	10,60		
20+20+35+42+42	1,13	1,13	1,98	2,38	2,38	9,00(2,90-11,50)	4,19	8,50	2,15(0,52-3,35)	1075	10,30	1,31	1,31	2,28	2,75	2,75	10,40(3,40-14,50)	4,79	4,68	2,17(0,54-3,62)	1085	10,20		
20+20+35+42+50	1,08	1,08	1,89	2,26	2,69	9,00(2,90-11,50)	4,13	8,50	2,18(0,58-3,29)	1090	10,40	1,25	1,25	2,18	2,62	3,10	10,40(3,40-14,50)	4,60	4,68	2,26(0,63-3,62)	1130	10,60		
20+20+35+42+60	1,02	1,02	1,78	2,14	3,04	9,00(2,90-11,50)	4,13	8,50	2,18(0,58-3,29)	1090	10,40	1,18	1,18	2,06	2,47	3,51	10,40(3,40-14,50)	4,60	4,68	2,26(0,63-3,62)	1130	10,60		
20+20+35+50+50	1,03	1,03	1,80	2,57	2,57	9,00(2,90-11,50)	3,96	8,50	2,27(0,67-3,24)	1135	10,90	1,19	1,19	2,08	2,97	2,97	10,40(3,40-14,50)	4,41	4,68	2,36(0,75-3,64)	1180	11,10		
20+20+42+42+42	1,08	1,08	2,28	2,28	2,28	9,00(2,90-11,50)	4,19	8,50	2,15(0,52-3,35)	1075	10,30	1,25	1,25	2,63	2,63	2,63	10,39(3,40-14,50)	4,79	4,68	2,17(0,54-3,61)	1085	10,20		
20+20+42+42+50	1,03	1,03	2,17	2,17	2,60	9,00(2,90-11,50)	4,13	8,50	2,18(0,58-3,29)	1090	10,40	1,20	1,20	2,51	2,51	2,98	10,40(3,40-14,50)	4,60	4,68	2,26(0,65-3,61)	1130	10,60		
20+20+42+50+50	0,99	0,99	2,08	2,47	2,47	9,00(2,90-11,50)	3,96	8,50	2,27(0,67-3,24)	1135	10,90	1,14	1,14	2,40	2,86	2,86	10,40(3,40-14,50)	4,39	4,68	2,37(0,75-3,69)	1185	11,10		
20+25+25+25+25	1,48	1,88	1,88	1,88	1,88	9,00(2,90-11,50)	4,09	8,50	2,20(0,48-3,49)	1100	10,50	1,72	1,72	2,17	2,17	2,17	10,40(3,40-14,50)	4,88	4,68	2,23(0,64-3,67)	1065	10,00		
20+25+25+25+35	1,38	1,73	1,73	1,73	4,43	9,00(2,90-11,50)	4,07	8,50	2,21(0,48-3,41)	1105	10,60	1,60	2,00	2,00	2,00	2,80	10,40(3,40-14,50)	4,81	4,68	2,16(0,48-3,64)	1080	10,20		
20+25+25+25+42	1,31	1,64	1,64	1,64	2,77	9,00(2,90-11,50)	4,07	8,50	2,21(0,49-3,41)	1105	10,60	1,52	1,90	1,90	1,90	3,18	10,40(3,40-14,50)	4,81	4,68	2,16(0,49-3,63)	1080	10,20		
20+25+25+25+50	1,24	1,55	1,55	1,55	3,11	9,00(2,90-11,50)	4,15	8,50	2,17(0,54-3,28)	1085	10,40	1,43	1,79	1,79	1,79	3,60	10,40(3,40-14,50)	4,73	4,68	2,23(0,58-3,63)	1100	10,30		
20+25+25+25+60	1,16	1,45	1,45	2,03	2,98	9,00(2,90-11,50)	4,15	8,50	2,17(0,54-3,28)	1085	10,40	1,34	1,68	1,68	1,68	4,02	10,40(3,40-14,50)	4,73	4,68	2,20(0,58-3,63)	1100	10,30		
20+25+25+25+71	1,08	1,36	1,36	1,36	3,84	9,00(2,90-11,50)	4,15	8,50	2,17(0,57-3,28)	1085	10,40	1,25	1,57	1,57	1,57	4,44	10,40(3,40-14,50)	4,75	4,68	2,19(0,59-3,61)	1095	10,30		
20+25+25+35+35	1,28	1,61	1,61	2,25	2,25	9,00(2,90-11,50)	4,07	8,50	2,21(0,49-3,42)	1105	10,60	1,48	1,86	1,86	2,60	2,60	10,40(3,40-14,50)	4,84	4,68	2,15(0,51-3,61)	1075	10,10		
20+25+25+35+42	1,22	1,53	1,53	2,14	2,58	9,00(2,90-11,50)	4,07	8,50	2,21(0,49-3,42)	1105	10,60	1,41	1,77	1,77	2,48	2,97	10,40(3,40-14,50)	4,84	4,68	2,15(0,51-3,60)	1075	10,10		
20+25+25+35+50	1,16	1,45	1,45	2,03	2,91	9,00(2,90-11,50)	4,15	8,50	2,17(0,57-3,28)	1085	10,40	1,34	1,68	1,68	2,35	3,35	10,40(3,40-14,50)	4,66	4,68	2,23(0,60-3,60)	1115	10,50		
20+25+25+35+60	1,09	1,36	1,36	1,91	3,28	9,00(2,90-11,50)	4,15	8,50	2,17(0,57-3,28)	1085	10,40	1,26	1,58	1,58	2,21	3,77	10,40(3,40-14,50)	4,66	4,68	2,23(0,60-3,60)	1115	10,50		
20+25+25+35+71	1,02	1,28	1,28	1,79	3,63	9,00(2,90-11,50)	4,13	8,50	2,18(0,58-3,29)	1090	10,40	1,18	1,48	1,48	2,07	4,19	10,40(3,40-14,50)	4,66	4,68	2,23(0,62-3,59)	1115	10,50		
20+25+25+42+42	1,18	1,46	1,46	2,45	2,45	9,00(2,90-11,50)	4,07	8,50	2,21(0,49-3,42)	1105	10,60	1,34	1,69	1,69	2,84	2,84	10,40(3,40-14,50)	4,77	4,68	2,18(0,52-3,59)	1090	10,20		
20+25+25+42+50	1,11	1,39	1,39	2,33	2,78	9,00(2,90-11,50)	4,15	8,50	2,17(0,57-3,28)	1085	10,40	1,28	1,60	1,60	2,70	3,22	10,40(3,40-14,50)	4,66	4,68	2,23(0,61-3,59)	1115	10,50		
20+25+25+42+60	1,05	1,31	1,31	2,20	3,13	9,00(2,90-11,50)	4,15	8,50	2,17(0,57-3,28)	1085	10,40	1,21	1,51	1,51	2,54	3,63	10,40(3,40-14,50)	4,66	4,68	2,23(0,61-3,59)	1115	10,50		
20+25+25+42+71	0,98	1,23	1,23	2,07	3,49	9,00(2,90-11,50)	4,13	8,50	2,18(0,58-3,29)	1090	10,40	1,14	1,42	1,42	2,39	4,03	10,40(3,40-14,50)	4,66	4,68	2,23(0,63-3,63)	1115	10,50		
20+25+25+50+50	1,06	1,32	1,32	2,65	2,65	9,00(2,90-11,50)	3,98	8,50	2,26(0,66-3,23)	1130	10,80	1,22	1,53	1,53	3,06	3,06	10,40(3,40-14,50)	4,46	4,68	2,33(0,72-3,66)	1165	10,90		
20+25+25+50+60	1,00	1,25	1,25	2,50	3,00	9,00(2,90-11,50)	3,98	8,50	2,26(0,66-3,23)	1130	10,80	1,16	1,44	1,44	2,89	3,47	10,40(3,40-14,50)	4,46	4,68	2,33(0,72-3,66)	1165	10,90		
20+25+35+35+35	1,20	1,50	2,10	2,10	2,10	9,00(2,90-11,50)	4,19	8,50	2,15(0,49-3,34)	1075	10,30	1,38	1,73	2,43	2,43	2,43	10,40(3,40-14,50)	4,77	4,68	2,18(0,52-3,64)	1090	10,20		
20+25+35+35+42	1,15	1,43	2,01	2,01	2,40	9,00(2,90-11,50)	4,19	8,50	2,15(0,50-3,34)	1075	10,30	1,32	1,66	2,32	2,32	2,78	10,40(3,40-14,50)	4,77	4,68	2,18(0,53-3,63)	1090	10,20		
20+25+35+35+50																								





PANASONIC COMMERCIAL AIR
TO AIR



Here are some of your new air conditioner's major features. Panasonic has developed an impressive range of highly efficient Commercial Air Conditioners. This range confirms our commitment to the environment. Our Inverter compressors optimise performance.

HIGHLIGHTED FEATURES



PACi: Commercial air to air. The compact and high efficiency solution for shops, restaurants, offices or residential applications.

Commercial benefits

Great savings and improved comfort.

Panasonic has developed an impressive range of highly efficient Commercial Air Conditioners. Our Inverter compressors optimise performance.

A wide range for the industry, office or residence.

From the smaller 1x1 to the more complete 4x1 solutions, Panasonic can

offer the most comfortable climate with solutions designed for every environment.

High connectivity.

The control systems allow you to manage all of your units for several locations. Receive real time status updates and maintenance alerts, while optimizing costs and energy usage.

Energy saving



Refrigerant gas R32.

Our heat pumps containing the refrigerant R32 show a drastic reduction in the value of Global Warming Potential (GWP). An important step to reduce greenhouse gases. R32 is also a component refrigerant, making it easy to recycle.



Econavi.

Intelligent Human Activity Sensor and Sunlight Sensor technologies that can detect and reduce waste of energy by optimising air conditioner operation according to room conditions. With just one touch of a button, you can save energy.



Exceptional seasonal cooling efficiency based on the ErP regulation.

Higher SEER ratings mean greater efficiency. Save all the year while cooling!

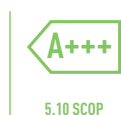

Exceptional seasonal heating efficiency based on the ErP regulation.

Higher SCOP ratings mean greater efficiency. Save all the year while heating!



Inverter Plus System.

Inverter Plus System classification highlights the highest performing Panasonic systems.



High efficiency compressor.

Compressors that operate with a wider Hz range realize a more efficient operation throughout the year. For Big PACi Series PE2.

High performance



Bluefin.

Panasonic has extended the life of its condensers with an original anti-rust coating. For Big PACi Series PE2.



Large Fan.

Large fan provides larger airflow rate and very quiet operation at low speed. For Big PACi Series PE2.



DC Fan.

Safe and precise.



Down to -15°C in cooling mode.

The air conditioner works in cooling only mode with an outdoor temperature of -15°C.



Down to -20°C or -15°C in heating mode.

The air conditioner works in heat pump mode even when outdoor temperatures are as low as -20°C or -15°C.

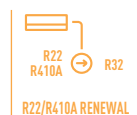

R410A/R22 renewal.

The Panasonic renewal system allows good quality existing R410A or R22 pipe work to be re-used whilst installing new high efficiency R32 systems.



R22 renewal.

The Panasonic renewal system allows good quality existing R22 pipe work to be re-used whilst installing new high efficiency R410A systems.



5 Years compressor warranty.

We guarantee the outdoor unit compressors in the entire range for five years.

High connectivity



Panasonic AC Smart Cloud.

The AC Smart Cloud from Panasonic allows you to have complete control of all your installations. In a simple click, receive status updates from all your units in real-time, preventing breakdowns and optimizing costs.



Internet Control.

A next generation system providing a user-friendly remote controller of air conditioning or heat pump units from everywhere, using a simple Android or iOS smartphone, tablet or PC via internet.



BMS connectivity.

The communication port can be integrated into the indoor unit and provides easy connection to, and control of, your Panasonic heat pump to your home or building management system.

PACi OUTDOOR UNITS ENERGY SAVING CONCEPT



Product quality and safety. All Panasonic air conditioners undergo strict quality and safety tests before sale. This rigorous process includes obtaining all necessary safety approvals, to ensure that all air conditioners we sell are not only built to the highest market standards, but are also completely safe.



New PACi R32 Refrigerant Gas

Panasonic recommends R32 because it is comparably environmentally friendly. Compared to R22 and R410A, R32 has a very low potential impact on global warming.

In line with the European Countries who are concerned in protecting and maintaining the environment by participating in the Montreal Protocol to protect the Ozone Layer and prevent Global Warming, Panasonic is leading the switch to R32.

1. Installation innovation.

- Extremely easy to install, practically the same as R410A. (Just remember to verify that the pressure gauge and vacuum pump are compatible with R32)
- This refrigerant is 100% pure, which makes it easier to recycle and reuse

2. Environmental innovation.

- Zero impact on the ozone layer
- 75% less impact on global warming

3. Economic and energy consumption innovation.

- Lower cost and greater savings
- Higher energy efficiency than R410A

PACi Elite: Next generation of commercial air conditioning

Outstanding performance at low temperatures, high energy efficiency, power consumption in remote control display. The energy saving design structure of fans, fan motors, compressors and heat exchangers resulted in high COP value which ranked as one of the top class in the industry. Additional benefits include reduced CO₂ emissions, energy consumption and operating costs.

PACi Elite. From 3,60 to 25,00kW.

- Meeting all necessary safety approvals to ensure quality and safety
- Top class SEER: A+++ / SCOP: A+++ at 3,60kW (in 90x90 Cassette)
- Cooling operation is possible when outdoor temperature as high as 46°C
- DC inverter technology combined with R32 and R410A
- Cooling operation is possible when outdoor temperature is as low as -15°C
- Heating operation is possible when outdoor temperature is as low as -20°C
- Compact outdoor units
- Auto restart from outdoor unit
- Twin, Triple and Double-Twin connection possible

PACi Standard: For economy and value

With high quality design and engineering, the PACi Standard is the perfect solution for projects which demand quality on a limited budget. In addition, its compact and lightweight design makes it ideal for installations with limited space including small commercial and residential applications.

The outdoor unit is much more compact than the previous model. The slim and lightweight design means the PACi outdoor unit can be installed in a number of situations.

PACi Standard. From 6,00 to 14,00kW.

- Good balance, system cost vs energy efficiency
- Top class SEER/SCOP as a Standard Inverter category
SEER: A++ / SCOP: A++ at 6,00 and 7,10kW (in 90x90 Cassette)
- Interchangeable controller with ECOi
- Compact outdoor units
- Twin connection possible
- Cooling operation up to -10°C and Heating operation up to -15°C



* These models will be available in May 2019.

New Big PACi Elite R32

20,00 – 25,00 kW is ideally suited for small, mid retail applications. In addition to its light net weight and compact body, split-able Hide Away design newly developed enables easy piping work in narrow installation space.

Panasonic Big PACi, not only environmental friendly but also groundbreaking products.

- High efficiency with Panasonic compressor as the driving force
- Compact and light indoor body
- Easy piping work with split-able Hide Away indoor design
- Separable indoor unit allows flexible installation to fit in narrow space
- Water Heat Exchanger compatibility
- Bluefin anti-rust coating
- Cloud Control compatible

PACi ELITE: EXCELLENT SEER AND SCOP VALUES



High operating efficiency using DC inverter compressor, DC motor and a heat exchanger design.

New PACi R32 seasonal efficiency for daily energy saving

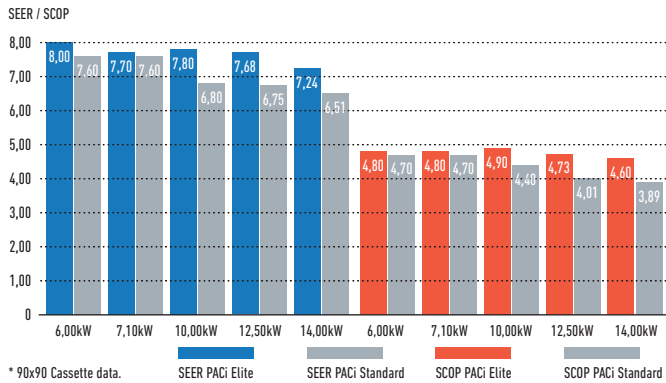

PACi Elite design operation conditions

Cooling operation is possible when outdoor temperature is as low as -15°C or as high as 46°C. Heating operation is possible when outdoor temperature is as low as -20°C. The remote control temperature setting offers a range from 18°C to 30°C.

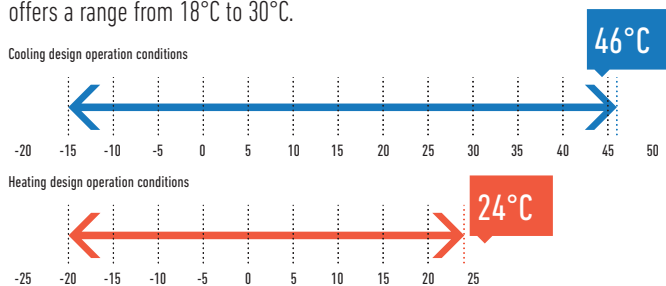

Energy consumption monitoring display with the CZ-RTC5B

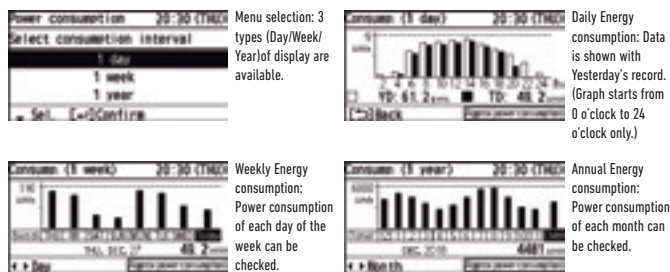

Increased piping length for greater design flexibility

Adaptable to various building types and sizes. Maximum piping length: 75m (10,00, 12,50, 14,00kW). 50m (6,00, 7,10kW).

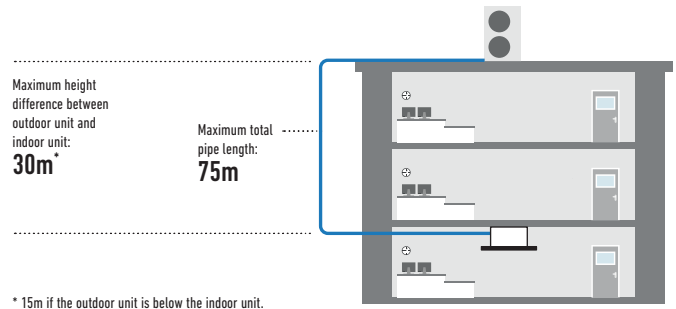

Compact & Flexible-design

The slim and lightweight design means the PACi outdoor unit can be installed in a number of compact situations. As the unit only weighs 98kg (R410A), it is easy to carry and easy to install.

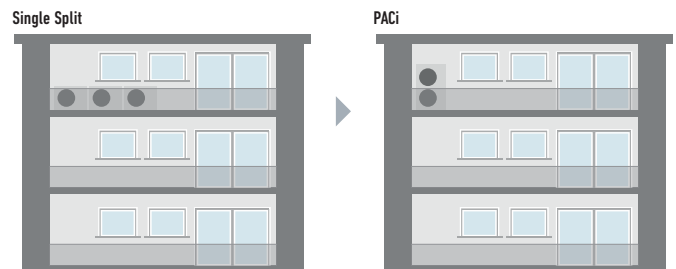

Datanavi, a new way to connect.

Simple and easy support tool with your smartphone.



- Scan & Save AC system info
- Easy access to manual database
- Commissioning, F gas check data history

Demand response compliant (CZ-CAPDC3) as a standard function

This terminal allows demand control of the outdoor unit. Several setting levels are available:

- Level-1, 2, 3: 75 / 50 / 0 %
 - Level-1, 2 can be set in 40 - 100% (40, 45, 50...95, 100: each 5%)
- CZ-CAPDC3 also allows for forced stop which can be used for Fire-alarm connection on LV3.

CZ-CAPDC3 is an optional for R410A models.

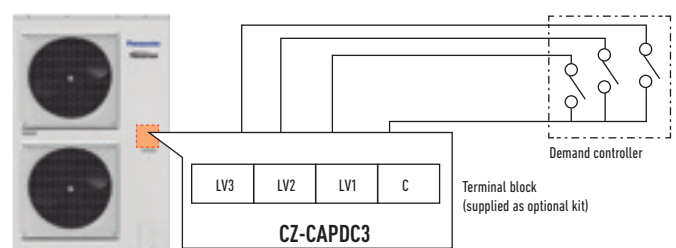

SOLUTIONS FOR 24/7/365 APPLICATIONS



High efficiency products for 24/7 applications. Panasonic has developed a complete range of solutions for server rooms which efficiently protect your servers, keeping them at an appropriate temperature even when the outdoor temperature is below -20°C.



High efficiency all the year

Key points:

- From 2,5 to 7,10kW with new TKEA R32 gas units A+++ in cooling
- PACi units from 3,6 to 14kW
- Backup function
- Redundancy function
- Alternative run function
- Error information by Dry Contact
- Operation even at -20°C outdoor temperature
- High seasonal performance
- Product design for 24/7 operation

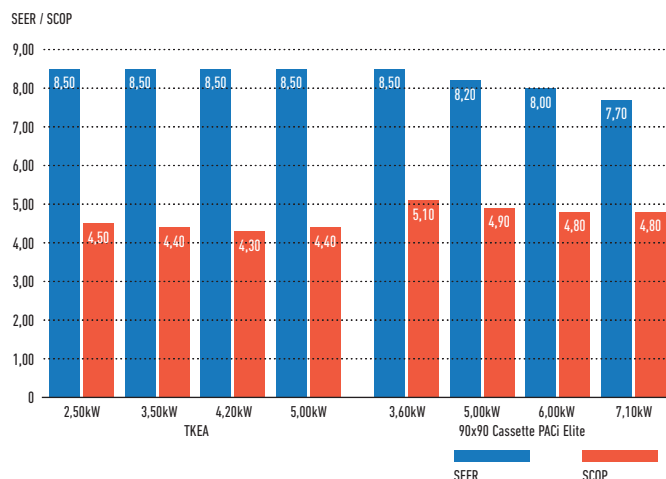

Interface to run 2 TKEA / PKEA. PAW-SERVER-PKEA

The PAW-SERVER-PKEA server room interface manages redundancy and backup of two TKEA / PKEA units with two different selectable modes:

- Plug and play by embedded redundancy and backup algorithm (no external signal needed. Further details please refer to operation manual)
- External (third party PLC) redundancy and backup management by Dry Contact

All settings are possible without the need for a computer connection. A special Energy Saving Mode is selectable by deep switch (available only in plug and play mode). The level of remote control input prohibition can be set when external management is by Dry Contact.

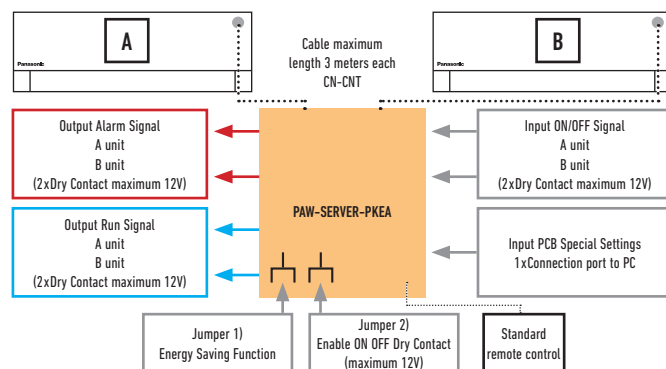

Interfaces to run 2 or 3 PACi and VRF indoor units

PAW-PACR3.

In combination with one PAW-T10 on each indoor unit, allows the redundant operation of 2 (or 3) PACi or VRF indoor units. All units will be operated sequentially in order to achieve the same operating time (example turn every 8 hours within a 24 hour period). If the room temperature exceeds a freely set value, the 2nd (or 3rd) unit will be switched ON and an alarm will be activated.

Backup control by using CZ-RTC5B.

Group wiring of 2 systems of PACi can do auto individual control.

- Rotation operation
- Backup operation
- Support operation

CZ-CAPRA1.

RAC interface adapter for integration into P-Link.

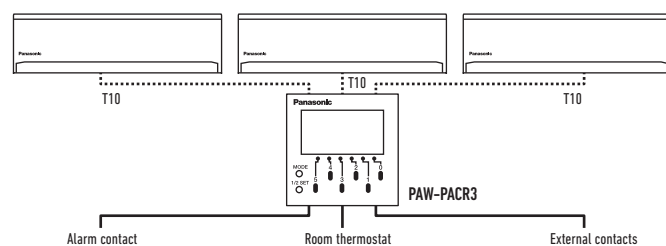

- Display and Settings:**
- Possible to select next unit manually
 - Possible to reset operation
 - LED display shows operation status
 - of the 2 or 3 units
 - Operation status output
 - Alarm LED and alarm output
 - Temperature limit can be set
 - Temperature hysteresis can be set
 - Room temperature is displayed
 - Time counter displayed

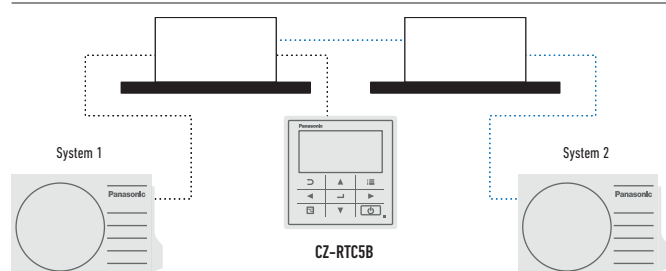

GENERATION PACi 90x90 CASSETTE



Panasonic introduces a new modern flat panel design to blend into any space. These Cassettes have been developed to satisfy today's customer needs such as high energy saving, comfort and healthier air.

PACi Cassette Panasonic

- Better SCOP & SEER (up to 15%) than conventional R410 models
- Advanced comfort and energy saving by Econavi sensor
- Air purification nanoe™ X system
- Super quiet operation from 27dB(A)

These Cassettes offer upgraded Econavi and nanoe™ X purification systems as accessories for making application space more comfortable, healthy and efficient.



Always fresh and clean air with nanoe™ X

- nanoe™ X is available with the advanced technology of room air conditioning.
- Purifying operation can work simultaneously or independently from heating/cooling operation.
 - Inhibiting certain viruses, bacteria & deodorisation (bacteria, fungus, pollen, virus and cigarette smoke). OH radicals in nanoe™ X pull bacteria's hydrogen out to effectively deodorise and sterilise
 - Clean inside by nanoe™ X + Dry control: inside of indoor unit can be cleaned by short operation circuit with nanoe™ X and drying

CZ-RTC5B and optional accessory CZ-CNEXU1 are required to use nanoe™ X function.

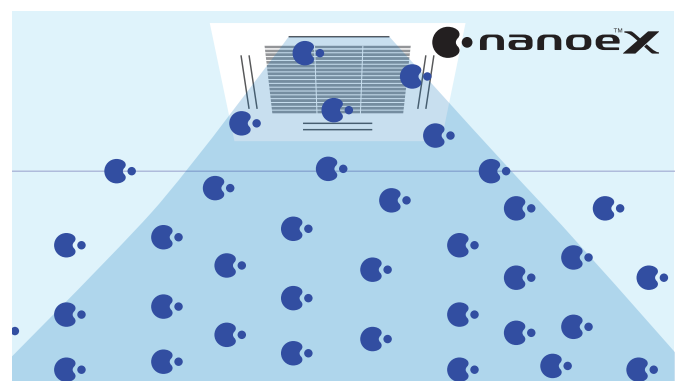

Econavi intelligent sensor

Human activity sensor and floor temperature sensor can reduce waste of energy by optimising air conditioner operation.



Advanced Econavi functions.

2 sensors (movement and floor temperature) can find waste of energy and control effectively. Floor temperature can detect up to 5m ceiling height.

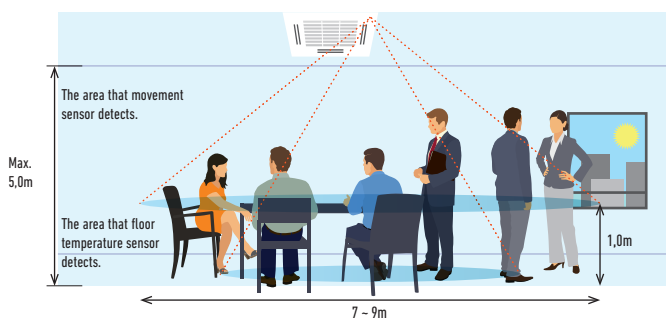

Econavi exclusive panel. Optional (CZ-KPU3A)



Floor temperature sensor.
This sensor detects average floor temperature and operates circulation if floor temperature is low.



Movement sensor.
This sensor detects the amount of human activity, and operates effectively.

Wired remote controller CZ-RTC5B is required.

Humidity sensor.

Humidity sensor has air suction function, and realises comfort and energy saving based on temperature and humidity.

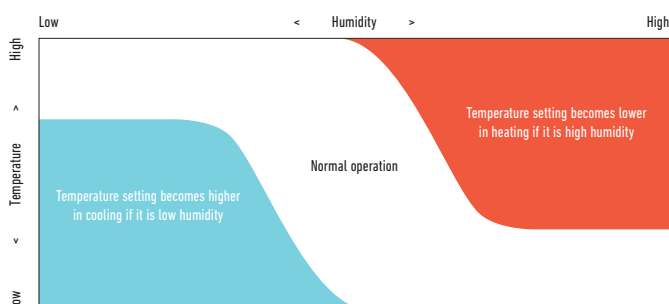





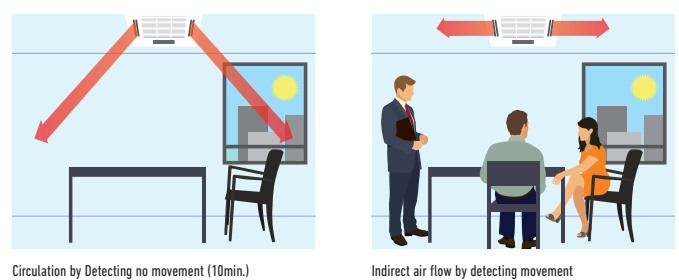



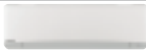
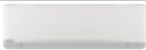
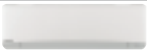
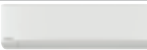
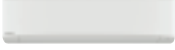
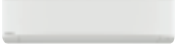
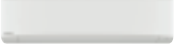
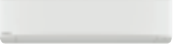

























Group control, circulation function.

Circulating operation is activated when a room is unoccupied to evenly distribute air and minimize temperature gaps in both heating and cooling operation.



RANGE OF COMMERCIAL UNITS R32

Page	Indoor units	2,50kW	3,50 ~ 3,60kW	4,50kW	5,00kW	6,00kW
P. 150	Wall Mounted Professional Inverter -20°C • R32 Gas	 CS-Z25TKEA	 CS-Z35TKEA	 CS-Z42TKEA	 CS-Z50TKEA	
P. 152	Wall Inverter+ • R32 Gas		 S-36PK2E5B	 S-45PK2E5B	 S-50PK2E5B	 S-60PK2E5B
P. 108	4 Way 60x60 Cassette Inverter • R32 Gas	 CS-Z25UB4EAW	 CS-Z35UB4EAW		 CS-Z50UB4EAW	 CS-Z60UB4EAW
P. 156	4 Way 60x60 Cassette Inverter+ • R32 Gas		 S-36PY2E5B	 S-45PY2E5B ¹	 S-50PY2E5B	
P. 158	4 Way 90x90 Cassette Inverter+ • R32 Gas		 S-36PU2E5B	 S-45PU2E5B	 S-50PU2E5B	 S-60PU2E5B
P. 162	Ceiling Inverter+ • R32 Gas		 S-36PT2E5B	 S-45PT2E5B	 S-50PT2E5B	 S-60PT2E5B
P. 109	Low Static Pressure Hide Away Inverter • R32 Gas	 CS-Z25UD3EAW	 CS-Z35UD3EAW		 CS-Z50UD3EAW	 CS-Z60UD3EAW
P. 166	High Static Pressure Hide Away Inverter+ • R32 Gas		 S-36PF1E5B	 S-45PF1E5B	 S-50PF1E5B	 S-60PF1E5B
P. 170	Low Static Pressure Hide Away Inverter+ • R32 Gas		 S-36PN1E5B	 S-45PN1E5B	 S-50PN1E5B	 S-60PN1E5B
P. 174	NEW High Static Pressure Hide Away 20-25kW Inverter+ • R32 Gas					
P. 190	Air Handling Unit Kit 5,00-25,00kW				 PAW-280PAH2(M/L)	 PAW-280PAH2(M/L)

Outdoor units	3,60kW	5,00kW	6,00kW
PACi Elite • R32 Gas	 U-36PZH2E5	 U-50PZH2E5	 U-60PZH2E5
PACi Standard • R32 Gas			 U-60PZ2E5

1) The 4,50kW indoor unit are only available only for Twin, Triple and Double-Twin combinations. 2) These models will be available in May 2019. * U-__E5 Single Phase / U-__E8 Three Phase.

7,10kW

10,00kW

12,50kW

14,00kW

20,00kW

25,00kW



CS-Z71TKEA



S-71PK2E5B



S-100PK2E5B (9,00kW)



S-71PU2E5B



S-100PU2E5B



S-125PU2E5B



S-140PU2E5B



S-71PT2E5B



S-100PT2E5B



S-125PT2E5B



S-140PT2E5B



S-71PF1E5B



S-100PF1E5B



S-125PF1E5B



S-140PF1E5B



S-71PN1E5B



S-100PN1E5B



S-125PN1E5B



S-140PN1E5B

S-200PE3E5B²S-250PE3E5B²

PAW-280PAH2(M/L)



PAW-280PAH2(M/L)



PAW-280PAH2(M/L)



PAW-280PAH2(M/L)



PAW-280PAH2(M/L)



PAW-280PAH2(M/L)

7,10kW

10,00kW

12,50kW

14,00kW

20,00kW

25,00kW



U-71PZH2E5 / U-71PZH2E8



U-100PZH2E5 / U-100PZH2E8



U-125PZH2E5 / U-125PZH2E8



U-140PZH2E5 / U-140PZH2E8

U-200PZH2E8²U-250PZH2E8²

U-71PZ2E5



U-100PZ2E5 / U-100PZ2E8



U-125PZ2E5 / U-125PZ2E8



U-140PZ2E5 / U-140PZ2E8

SOLUTIONS FOR SERVER ROOMS

High efficiency products for 24/7 applications. Panasonic has developed a complete range of solutions for server rooms which efficiently protect your servers, keeping them at an appropriate temperature even when the outdoor temperature is below -20°C .



High efficiency all the year

Key points:

- From 2,50 to 7,10kW with new TKEA R32 gas units A+++ in cooling
- Backup function
- Redundancy function
- Alternative run function
- Error information by Dry Contact
- Operation even at -20°C outdoor temperature
- High seasonal performance
- Product design for 24/7 operation

Exceptional efficiency means exceptional savings

TKEA provides high capacity at -20°C !

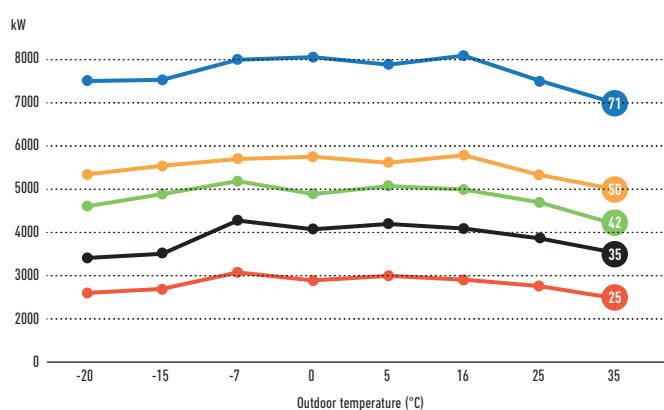

Wall Mounted Professional Inverter -20°C

• R32 GAS



Complete line-up with high efficiency even at -20°C

This Wall Mounted air conditioner is especially designed for professional applications such as computer rooms where cooling inside the room is necessary even when the outside temperature is low. Furthermore this air conditioner has an automatic changeover system, in order to maintain the inside temperature even when sharp outside temperature changes occur.

Technical focus

- R32 gas is more environmentally friendly than R410A
- Aerowings to control air draft direction
- Designed for 24h/7d a week operation
- Up to A+++ in cooling
- Highly efficient even at -20°C
- High durability rolling bearings
- Additional piping sensors to prevent freezing
- Automatic restart

KIT			KIT-Z25-TKEA	KIT-Z35-TKEA	KIT-Z42-TKEA	KIT-Z50-TKEA	KIT-Z71-TKEA
Cooling capacity	Nominal (Min - Max)	kW	2,50 (0,85 - 3,00)	3,50 (0,85 - 4,00)	4,20 (0,98 - 5,00)	5,00 (0,98 - 6,00)	7,10 (0,98 - 8,10)
SEER ¹⁾	Nominal (Min - Max)	W/W	4,90 (5,00 - 4,29)	4,07 (5,00 - 3,64)	3,82 (4,90 - 3,25)	3,60 (3,50 - 3,09)	3,17 (2,33 - 3,03)
SEER ²⁾			8,50 A+++	8,50 A+++	8,50 A+++	8,50 A+++	6,10 A++
Pdesign		kW	2,50	3,50	4,20	5,00	7,10
Input power cooling	Nominal (Min - Max)	kW	0,51 (0,17 - 0,70)	0,86 (0,17 - 1,10)	1,10 (0,20 - 1,54)	1,39 (0,28 - 1,94)	2,24 (0,42 - 2,67)
Annual energy consumption ³⁾		kWh/a	103	144	173	206	407
Heating capacity	Nominal (Min - Max)	kW	3,40 (0,85 - 5,40)	4,00 (0,85 - 6,60)	5,40 (0,98 - 7,25)	5,80 (0,98 - 8,00)	8,60 (0,98 - 9,90)
Heating capacity at -7°C		kW	3,33	4,07	4,30	5,00	6,13
COP ¹⁾	Nominal (Min - Max)	W/W	4,86 (5,15 - 4,12)	4,35 (5,15 - 3,63)	4,00 (4,45 - 3,37)	4,03 (2,88 - 3,20)	3,51 (2,45 - 3,47)
SCOP ²⁾			4,50 A+	4,40 A+	4,30 A+	4,40 A+	4,00 A+
Pdesign at -10°C		kW	2,80	3,60	3,80	4,40	5,50
Input power heating	Nominal (Min - Max)	kW	0,70 (0,17 - 1,31)	0,92 (0,17 - 1,82)	1,35 (0,22 - 2,15)	1,44 (0,34 - 2,50)	2,45 (0,40 - 2,85)
Annual energy consumption ³⁾		kWh/a	871	1145	1237	1400	1925
Indoor unit			CS-Z25TKEA	CS-Z35TKEA	CS-Z42TKEA	CS-Z50TKEA	CS-Z71TKEA
Power source		V	230	230	230	230	230
Recommended fuse		A	16	16	16	16	20
Connection indoor / outdoor		mm ²	4 x 1,5	4 x 1,5	4 x 1,5	4 x 2,5	4 x 2,5
Air Volume	Cool / Heat	m ³ /min	10,4 / 11,7	10,7 / 12,4	18,2 / 20,2	19,2 / 21,3	20,2 / 21,0
Moisture removal volume		L/h	1,5	2,0	2,4	2,8	4,1
Sound pressure ⁴⁾	Cool (Hi / Lo / Q-Lo)	dB(A)	39 / 25 / 21	42 / 28 / 21	43 / 32 / 29	44 / 37 / 30	47 / 38 / 35
	Heat (Hi / Lo / Q-Lo)	dB(A)	41 / 27 / 22	43 / 30 / 22	44 / 35 / 29	44 / 37 / 30	47 / 38 / 35
Dimension	HxWxD	mm	295 x 919 x 194	295 x 919 x 194	302 x 1120 x 236	302 x 1120 x 236	302 x 1120 x 236
Net weight		kg	9	10	12	12	13
Outdoor unit			CU-Z25TKEA	CU-Z35TKEA	CU-Z42TKEA	CU-Z50TKEA	CU-Z71TKEA
Sound pressure ⁴⁾	Cool / Heat (Hi)	dB(A)	46 / 48	48 / 50	48 / 50	48 / 50	52 / 54
Dimension ⁵⁾	HxWxD	mm	619 x 824 x 299	619 x 824 x 299	619 x 824 x 299	695 x 875 x 320	695 x 875 x 320
Net weight		kg	37	38	38	43	49
Piping connections	Liquid pipe	Inch (mm)	1/4 (6,35)	1/4 (6,35)	1/4 (6,35)	1/4 (6,35)	1/4 (6,35)
	Gas pipe	Inch (mm)	3/8 (9,52)	3/8 (9,52)	1/2 (12,70)	1/2 (12,70)	5/8 (15,88)
Pipe length range		m	3 ~ 20	3 ~ 20	3 ~ 20	3 ~ 30	3 ~ 30
Elevation difference (in/out) ⁶⁾		m	15	15	15	15	20
Pipe length for additional gas		m	7,5	7,5	7,5	7,5	10
Additional gas amount		g/m	10	10	10	15	25
Refrigerant (R32) / CO ₂ Eq.		kg / T	0,96 / 0,648	1,00 / 0,675	1,08 / 0,729	1,15 / 0,776	1,32 / 0,891
Operating range	Cool Min ~ Max	°C	-20 ~ +43	-20 ~ +43	-20 ~ +43	-20 ~ +43	-20 ~ +43
	Heat Min ~ Max	°C	-15 ~ +24	-15 ~ +24	-15 ~ +24	-15 ~ +24	-15 ~ +24

Accessories

CZ-TACG1	Panasonic Comfort Cloud for internet control
CZ-CAPRA1	RAC interface adapter for integration into P-Link
PAW-WTRAY	Tray for condenser water compatible with base ground support

Accessories

PAW-GRDSTD40	Outdoor elevation platform
PAW-GRDBSE20	Outdoor base ground support for noise and vibration absorption
PAW-SERVER-PKEA	PCB for installation in server rooms with security

1) EER and COP calculation is based in accordance to EN14511. 2) Energy Label Scale from A+++ to D. 3) The annual energy consumption is calculated in accordance to EU/626/2011. 4) The sound pressure of the indoor unit shows the value measured of a position 1m in front of the main body and 0.8m below the unit. For outdoor unit 1m in front and 1m in rear side of main body. The sound pressure is measured in accordance with JIS C 9612. Q-Lo: Quiet mode. Lo: The lowest set fan speed. 5) Add 70mm for piping port. 6) When installing the outdoor unit at a higher position than the indoor unit.



SEER and SCOP: For KIT-Z25-TKEA. SUPER QUIET: For KIT-Z25-TKEA. INTERNET CONTROL: Optional.

PACi Elite Wall Mounted Inverter+ • R32 GAS

The wall mounted units with stylish matt color can be offered for many applications such as studios, gyms, high ceiling areas and even computer server rooms.

The compact design and flat face ensure discreet installation, even in a small space.



CZ-RWS3
Optional Controller.
Infrared remote controller.



CZ-RE2C2
Optional Controller.
Simplified remote controller.



CZ-CENS1
Optional Econavi Sensor.

			Single Phase				
			3,60kW	5,00kW	6,00kW	7,10kW	9,00kW
KIT			KIT-36PK2ZH5	KIT-50PK2ZH5	KIT-60PK2ZH5	KIT-71PK2ZH5	KIT-100PK2ZH5
Remote controller			CZ-RTC5B	CZ-RTC5B	CZ-RTC5B	CZ-RTC5B	CZ-RTC5B
Cooling capacity	Nominal (Min-Max)	kW	3,60 (1,50 ~ 4,00)	5,00 (1,50 ~ 5,60)	6,10 (2,00 ~ 7,10)	7,10 (2,20 ~ 9,00)	9,50 (3,10 ~ 10,50)
EER ¹⁾		W/W	4,90	4,10	3,86	3,50	3,26
SEER ²⁾			8,00 A++	7,60 A++	7,20 A++	6,80 A++	6,40 A++
P _{design}		kW	3,60	5,00	6,10	7,10	9,50
Input power cooling		kW	0,74	1,22	1,58	2,03	2,91
Annual energy consumption ³⁾		kWh/a	157	230	297	365	520
Heating capacity	Nominal (Min-Max)	kW	4,00 (1,50 ~ 5,00)	5,60 (1,50 ~ 6,50)	7,00 (1,80 ~ 8,00)	8,00 (2,00 ~ 9,00)	9,50 (3,10 ~ 11,50)
COP ¹⁾		W/W	4,94	4,21	4,46	4,00	3,97
SCOP ²⁾			4,90 A++	4,70 A++	4,80 A++	4,70 A++	4,10 A+
P _{design} at -10°C		kW	3,60	4,50	6,00	5,20	8,00
Input power heating		kW	0,81	1,33	1,57	2,00	2,39
Annual energy consumption ³⁾		kWh/a	1029	1340	1750	1549	2732
Indoor unit			S-36PK2E5B	S-50PK2E5B	S-60PK2E5B	S-71PK2E5B	S-100PK2E5B
Air volume	Hi / Med / Lo	m ³ /min	13,0/11,0/9,0	16,0/14,0/11,0	20,0/18,0/15,0	20,0/17,5/14,5	22,0/18,5/15,0
Sound pressure ⁴⁾	Hi / Med / Lo	dB(A)	35/31/27	40/36/32	47/44/40	47/44/40	49/45/41
Dimension	HxWxD	mm	302x1120x236	302x1120x236	302x1120x236	302x1120x236	302x1120x236
Net weight		kg	13	13	14	14	14
Outdoor unit			U-36PZH2E5	U-50PZH2E5	U-60PZH2E5	U-71PZH2E5	U-100PZH2E5
Power source		V	220/230/240	220/230/240	220/230/240	220/230/240	220/230/240
Current	Cool (Hi / Med / Lo)	A	3,55/3,40/3,25	5,70/5,50/5,25	7,70/7,35/7,05	9,55/9,10/8,75	13,50/12,90/12,40
	Heat (Hi / Med / Lo)	A	3,95/3,75/3,60	6,35/6,05/5,80	7,65/7,30/7,00	9,20/8,80/8,50	11,10/10,60/10,10
Air volume	Cool / Heat	m ³ /min	40/40	40/45	40/45	61/60	118/108
Sound pressure	Cool / Heat (Hi)	dB(A)	43/44	45/48	46/49	48/50	52/52
Sound power	Cool / Heat (Hi)	dB	62/64	64/68	65/69	65/67	69/69
Dimension	HxWxD	mm	695x875x320	695x875x320	695x875x320	996x940x340	1416x940x340
Net weight		kg	43	43	44	68	99
Piping connections	Liquid pipe	Inch (mm)	1/4(6,35)	1/4(6,35)	3/8(9,52)	3/8(9,52)	3/8(9,52)
	Gas pipe	Inch (mm)	1/2(12,70)	1/2(12,70)	5/8(15,88)	5/8(15,88)	5/8(15,88)
Pipe length range		m	3~40	3~40	3~40	5~50	5~85
Elevation difference (in/out) ⁵⁾		m	30	30	30	30	30
Pipe length for additional gas		m	30	30	30	30	30
Additional gas amount		g/m	20	20	35	45	45
Refrigerant (R32) / CO ₂ Eq.		kg / T	1,15/0,776	1,15/0,776	1,45/0,979	1,95/1,316	3,05/2,059
Operating range	Cool Min ~ Max	°C	-15 ~ +46	-15 ~ +46	-15 ~ +46	-15 ~ +46	-15 ~ +46
	Heat Min ~ Max	°C	-20 ~ +24	-20 ~ +24	-20 ~ +24	-20 ~ +24	-20 ~ +24

Accessories

CZ-RTC5B	Wired remote controller with Econavi function and datanavi
CZ-RWS3	Infrared remote controller
CZ-RE2C2	Simplified remote controller
PAW-GRDSTD40	Outdoor elevation platform 400x900x400mm
PAW-WTRAY	Tray for condenser water compatible with base ground support

Accessories

PAW-GRDBSE20	Outdoor base ground support for noise and vibration absorption
PAW-PACR3	Interfaces to run 3 units on Backup and alternative run
CZ-CAPWFC1	NEW Commercial WLAN Adaptor

Technical focus

- Modern design with flat face and compact size
- Stylish matt white color
- DC FAN for better efficiency and control
- Six directional piping outlet
- Datanavi simple support tool App with remote controller (CZ-RTC5B)
- Easy connection and control of external fan or ERV using the connector PAW-FDC on the indoor unit PCB. The external device can be controlled by the remote control of the Panasonic indoor unit

Closed discharge port

When the unit is turned OFF, the flap closes completely to prevent dust getting into the unit and to keep the equipment clean.

Quiet operation

These units are among the quietest in the industry, making them ideal for hotels and hospitals.

Smooth and durable design

Stylish matt color matches with modern interiors. The sleek, compact design ensures a discreet installation - even where space is limited.

Piping outlet in six directions

Piping outlet is possible in the six directions of right, right rear, right bottom, left, left rear and left bottom, making the installation work easier.

Air distribution is altered depending on the operational mode



			Three Phase	
			7,10kW	9,00kW
KIT			KIT-71PK2ZH8	KIT-100PK2ZH8
Remote controller			CZ-RTC5B	CZ-RTC5B
Cooling capacity	Nominal (Min - Max)	kW	7,10 (2,20 ~ 9,00)	9,50 (3,10 ~ 10,50)
EER ¹⁾		W/W	3,50	3,26
SEER ²⁾			6,70 A++	6,30 A++
Pdesign		kW	7,10	9,50
Input power cooling		kW	2,03	2,91
Annual energy consumption ³⁾		kWh/a	370	526
Heating capacity	Nominal (Min - Max)	kW	8,00 (2,00 ~ 9,00)	9,50 (3,10 ~ 11,50)
COP ¹⁾		W/W	4,00	3,97
SCOP ²⁾			4,70 A++	4,10 A+
Pdesign at -10°C		kW	5,20	8,00
Input power heating		kW	2,00	2,39
Annual energy consumption ³⁾		kWh/a	1549	2732
Indoor unit			S-71PK2E5B	S-100PK2E5B
Air volume	Hi / Med / Lo	m ³ /min	20,0 / 17,5 / 14,5	22,0 / 18,5 / 15,0
Sound pressure ⁴⁾	Hi / Med / Lo	dB(A)	47 / 44 / 40	49 / 45 / 41
Dimension	H x W x D	mm	302 x 1120 x 236	302 x 1120 x 236
Net weight		kg	14	14
Outdoor unit			U-71PZH2E8	U-100PZH2E8
Power source		V	380 / 400 / 415	380 / 400 / 415
Current	Cool (Hi / Med / Lo)	A	3,20 / 3,05 / 2,95	4,60 / 4,35 / 4,20
	Heat (Hi / Med / Lo)	A	3,10 / 3,00 / 2,85	3,75 / 3,55 / 3,45
Air volume	Cool / Heat	m ³ /min	61 / 60	118 / 108
Sound pressure	Cool / Heat (Hi)	dB(A)	48 / 50	52 / 52
Sound power	Cool / Heat (Hi)	dB	65 / 67	69 / 69
Dimension	H x W x D	mm	996 x 940 x 340	1416 x 940 x 340
Net weight		kg	68	99
Piping connections	Liquid pipe	Inch (mm)	3/8 (9,52)	3/8 (9,52)
	Gas pipe	Inch (mm)	5/8 (15,88)	5/8 (15,88)
Pipe length range		m	5 ~ 50	5 ~ 85
Elevation difference (in/out) ⁵⁾		m	30	30
Pipe length for additional gas		m	30	30
Additional gas amount		g/m	45	45
Refrigerant (R32) / CO ₂ Eq.		kg / T	1,95 / 1,316	3,05 / 2,059
Operating range	Cool Min ~ Max	°C	-15 ~ +46	-15 ~ +46
	Heat Min ~ Max	°C	-20 ~ +24	-20 ~ +24

1) EER and COP calculation is based in accordance to EN14511. 2) For models below 12kW, the SEER and SCOP is calculated based on values of EU/626/2011. For models above 12kW, the SEER and SCOP is calculated based on values of EU/2281/2016. 3) The annual energy consumption is calculated in accordance to EU/626/2011. 4) The sound pressure of the units shows the value measured at the position 1m in front of the main body and 1m below the unit. The sound pressure is measured in accordance with Eurovent 6/C/006-97 specification. 5) When installing the outdoor unit at a higher position than the indoor unit. * Recommended fuse for the indoor 3A.



SEER and SCOP: For KIT-36PK2ZH5. INTERNET CONTROL: Optional.

Compatible with all Panasonic connectivity solutions. For detailed information go to the Control Systems section.

PACi Standard Wall Mounted Inverter+

• R32 GAS



The wall mounted units with stylish matt color can be offered for many applications such as studios, gyms, high ceiling areas and even computer server rooms.

The compact design and flat face ensure discreet installation, even in a small space.



CZ-RWS3
Optional Controller.
Infrared remote controller.



CZ-RE2C2
Optional Controller.
Simplified remote controller.



CZ-CENSC1
Optional Econavi Sensor.

			Single Phase		
			6,00kW	7,10kW	9,00kW
KIT			KIT-60PK2Z5	KIT-71PK2Z5	KIT-100PK2Z5
Remote controller			CZ-RTC5B	CZ-RTC5B	CZ-RTC5B
Cooling capacity	Nominal (Min-Max)	kW	6,10(2,00 - 7,10)	7,10(2,00 - 7,70)	9,00(3,00 - 9,70)
EER ¹⁾	Nominal (Min-Max)	W/W	3,79	3,21	3,47(5,36 - 3,13)
SEER ²⁾			6,80A++	6,40A++	6,50A++
P _{design}		kW	6,10	7,10	9,00
Input power cooling	Nominal (Min-Max)	kW	1,61	2,21	2,59(0,56 - 3,10)
Annual energy consumption ³⁾		kWh/a	314	388	485
Heating capacity	Nominal (Min-Max)	kW	6,10(1,80 - 7,00)	7,10(1,80 - 8,10)	9,00(3,00 - 10,50)
COP ¹⁾	Nominal (Min-Max)	W/W	4,80	4,41	3,93(5,36 - 3,56)
SCOP ²⁾			4,70A++	4,60A++	3,90A
P _{design} at -10°C		kW	6,00	6,00	9,00
Input power heating	Nominal (Min-Max)	kW	1,27	1,61	2,29(0,56 - 2,95)
Annual energy consumption ³⁾		kWh/a	1787	1826	3231
Indoor unit			S-60PK2E5B	S-71PK2E5B	S-100PK2E5B
Air volume	Hi / Med / Lo	m ³ /min	20,0 / 18,0 / 15,0	20,0 / 18,0 / 15,0	22,0 / 18,5 / 15,0
Moisture removal volume		L/h	2,0	3,0	4,3
Sound pressure ⁴⁾	Hi / Med / Lo	dB(A)	47 / 44 / 40	47 / 44 / 40	49 / 45 / 41
Sound power	Hi / Med / Lo	dB	63 / 60 / 56	63 / 60 / 56	65 / 61 / 57
Dimension	H x W x D	mm	302 x 1120 x 236	302 x 1120 x 236	302 x 1120 x 236
Net weight		kg	14	14	14
Outdoor unit			U-60PZ2E5	U-71PZ2E5	U-100PZ2E5
Power source		V	220 / 230 / 240	220 / 230 / 240	220 / 230 / 240
Current	Cool (Hi / Med / Lo)	A	7,85 / 7,50 / 7,20	10,70 / 10,20 / 9,85	12,10 / 11,50 / 11,10
	Heat (Hi / Med / Lo)	A	6,10 / 5,85 / 5,60	7,85 / 7,50 / 7,20	10,60 / 10,20 / 9,70
Air volume	Cool / Heat	m ³ /min	40 / 45	50 / 45	76 / 70
Sound pressure	Cool / Heat (Hi)	dB(A)	46 / 48	49 / 49	52 / 52
Sound power	Cool / Heat (Hi)	dB	65 / 68	69 / 69	70 / 70
Dimension	H x W x D	mm	695 x 875 x 320	695 x 875 x 320	996 x 980 x 370
Net weight		kg	44	44	90
Piping connections	Liquid pipe	Inch (mm)	3/8(9,52)	3/8(9,52)	3/8(9,52)
	Gas pipe	Inch (mm)	5/8(15,88)	5/8(15,88)	5/8(15,88)
Pipe length range		m	3 ~ 40	3 ~ 40	5 ~ 50
Elevation difference (in/out) ⁵⁾		m	30	30	30
Pipe length for additional gas		m	30	30	30
Additional gas amount		g/m	35	35	45
Refrigerant (R32) / CO ₂ Eq.		kg / T	1,45 / 0,979	1,45 / 0,979	2,60 / 1,755
Operating range	Cool Min ~ Max	°C	-10 ~ +43	-10 ~ +43	-10 ~ +43
	Heat Min ~ Max	°C	-15 ~ +24	-15 ~ +24	-15 ~ +24

Accessories

CZ-RTC5B	Wired remote controller with Econavi function and datanavi
CZ-RWS3	Infrared remote controller
CZ-RE2C2	Simplified remote controller
PAW-GRDSTD40	Outdoor elevation platform 400x900x400mm
PAW-WTRAY	Tray for condenser water compatible with base ground support

Accessories

PAW-GRDBSE20	Outdoor base ground support for noise and vibration absorption
PAW-PACR3	Interfaces to run 3 units on Backup and alternative run
CZ-CAPWFC1	NEW Commercial WLAN Adaptor

Technical focus

- Modern design with flat face and compact size
- Stylish matt white color
- DC FAN for better efficiency and control
- Six directional piping outlet
- Datanavi simple support tool App with remote controller (CZ-RTC5B)
- Easy connection and control of external fan or ERV using the connector PAW-FDC on the indoor unit PCB. The external device can be controlled by the remote control of the Panasonic indoor unit

Closed discharge port

When the unit is turned OFF, the flap closes completely to prevent dust getting into the unit and to keep the equipment clean.

Quiet operation

These units are among the quietest in the industry, making them ideal for hotels and hospitals.

Smooth and durable design

Stylish matt color matches with modern interiors. The sleek, compact design ensures a discreet installation - even where space is limited.

Piping outlet in six directions

Piping outlet is possible in the six directions of right, right rear, right bottom, left, left rear and left bottom, making the installation work easier.

Air distribution is altered depending on the operational mode



			Three Phase
			9,00kW
KIT			KIT-100PK2Z8
Remote controller			CZ-RTC5B
Cooling capacity	Nominal (Min-Max)	kW	9,00 (3,00 - 9,70)
EER ¹⁾	Nominal (Min-Max)	W/W	3,47 (5,36 - 3,13)
SEER ²⁾			6,50 A++
Pdesign		kW	9,00
Input power cooling	Nominal (Min-Max)	kW	2,59 (0,56 - 3,10)
Annual energy consumption ³⁾		kWh/a	485
Heating capacity	Nominal (Min-Max)	kW	9,00 (3,00 - 10,50)
COP ¹⁾	Nominal (Min-Max)	W/W	3,93 (5,36 - 3,56)
SCOP ²⁾			3,90 A
Pdesign at -10°C		kW	9,00
Input power heating	Nominal (Min-Max)	kW	2,29 (0,56 - 2,95)
Annual energy consumption ³⁾		kWh/a	3231
Indoor unit			S-100PK2E5B
Air volume	Hi / Med / Lo	m ³ /min	22,0 / 18,5 / 15,0
Moisture removal volume		L/h	4,3
Sound pressure ⁴⁾	Hi / Med / Lo	dB(A)	49 / 45 / 41
Sound power	Hi / Med / Lo	dB	65 / 61 / 57
Dimension	HxWxD	mm	302 x 1120 x 236
Net weight		kg	14
Outdoor unit			U-100PZ2E8
Power source		V	380 / 400 / 415
Current	Cool (Hi / Med / Lo)	A	4,10 / 3,90 / 3,75
	Heat (Hi / Med / Lo)	A	3,60 / 3,45 / 3,30
Air volume	Cool / Heat	m ³ /min	76 / 70
Sound pressure	Cool / Heat (Hi)	dB(A)	52 / 52
Sound power	Cool / Heat (Hi)	dB	70 / 70
Dimension	HxWxD	mm	996 x 980 x 370
Net weight		kg	90
Piping connections	Liquid pipe	Inch (mm)	3/8 (9,52)
	Gas pipe	Inch (mm)	5/8 (15,88)
Pipe length range		m	5 - 50
Elevation difference (in/out) ⁵⁾		m	30
Pipe length for additional gas		m	30
Additional gas amount		g/m	45
Refrigerant (R32) / CO ₂ Eq.		kg / T	2,60 / 1,755
Operating range	Cool Min ~ Max	°C	-10 ~ +43
	Heat Min ~ Max	°C	-15 ~ +24

1) EER and COP calculation is based in accordance to EN14511. 2) For models below 12kW, the SEER and SCOP is calculated based on values of EU/626/2011. For models above 12kW, the SEER and SCOP is calculated based on values of EU/2281/2016. 3) The annual energy consumption is calculated in accordance to EU/626/2011. 4) The sound pressure of the units shows the value measured of the position 1m in front of the main body and 1m below the unit. The sound pressure is measured in accordance with Eurovent 6/C/006-97 specification. 5) When installing the outdoor unit at a higher position than the indoor unit. * Recommended fuse for the indoor 3A.



SEER and SCOP: For KIT-60PK2Z5. INTERNET CONTROL: Optional.

Compatible with all Panasonic connectivity solutions. For detailed information go to the Control Systems section.

PACi Elite and Standard 4 Way 60x60 Cassette Inverter+ • R32 GAS

Small and powerful, ideal for offices and restaurants

Standard units only for Twin, Triple and Double-twin combinations.

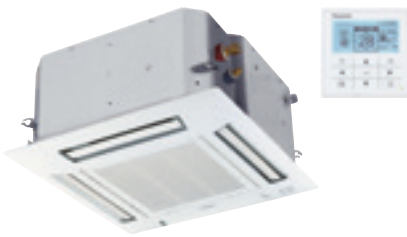

CZ-KPY3AW
Panel 700 x 700mm.



CZ-KPY3BW
Panel 625 x 625mm.



CZ-RWS3
Optional Controller.
Infrared remote controller.



CZ-RE2C2
Optional Controller.
Simplified remote controller.

			Single Phase	
			3,60kW	5,00kW
KIT			KIT-36PY2ZH5	KIT-50PY2ZH5
Remote controller			CZ-RTCS5B	CZ-RTCS5B
Cooling capacity	Nominal (Min - Max)	kW	3,60 (1,50 - 4,00)	5,00 (1,50 - 5,60)
EER ¹⁾		W/W	4,68	3,68
SEER ²⁾			6,60 A++	6,40 A++
P _{design}		kW	3,60	5,00
Input power cooling		kW	0,77	1,36
Annual energy consumption ³⁾		kWh/a	191	273
Heating capacity	Nominal (Min - Max)	kW	4,00 (1,50 - 5,00)	5,60 (1,50 - 6,50)
COP ¹⁾		W/W	4,26	3,46
SCOP ²⁾			4,60 A++	4,30 A+
P _{design} at -10°C		kW	3,60	4,50
Input power heating		kW	0,94	1,62
Annual energy consumption ³⁾		kWh/a	1096	1465
Indoor unit			S-36PY2E5B	S-50PY2E5B
Air volume	Hi / Med / Lo	m ³ /min	9,7 / 8,0 / 6,0	11,1 / 9,8 / 8,5
Moisture removal volume		L/h	1,5	2,4
Sound pressure ⁴⁾	Hi / Med / Lo	dB(A)	36 / 32 / 26	40 / 37 / 33
Sound power	Hi / Med / Lo	dB	51 / 47 / 41	55 / 52 / 48
Dimension (HxWxD) / Net weight	Indoor	mm / kg	288 x 583 x 583 / 18	288 x 583 x 583 / 18
	CZ-KPY3AW Panel	mm / kg	31 x 700 x 700 / 2,4	31 x 700 x 700 / 2,4
	CZ-KPY3BW Panel	mm / kg	31 x 625 x 625 / 2,4	31 x 625 x 625 / 2,4
Outdoor unit			U-36PZH2E5	U-50PZH2E5
Power source		V	220 / 230 / 240	220 / 230 / 240
Current	Cool (Hi / Med / Lo)	A	3,65 / 3,50 / 3,35	6,35 / 6,10 / 5,85
	Heat (Hi / Med / Lo)	A	4,50 / 4,30 / 4,15	7,70 / 8,40 / 8,10
Air volume	Cool / Heat	m ³ /min	40 / 40	40 / 45
Sound pressure	Cool / Heat (Hi)	dB(A)	43 / 44	45 / 48
Sound power	Cool / Heat (Hi)	dB	62 / 64	64 / 68
Dimension / Net weight	HxWxD	mm / kg	695 x 875 x 320 / 43	695 x 875 x 320 / 43
Piping connections	Liquid pipe	Inch (mm)	1/4 (6,35)	1/4 (6,35)
	Gas pipe	Inch (mm)	1/2 (12,70)	1/2 (12,70)
Pipe length range		m	3 - 40	3 - 40
Elevation difference (in/out) ⁵⁾		m	30	30
Pipe length for additional gas		m	30	30
Additional gas amount		g/m	20	20
Refrigerant (R32) / CO ₂ Eq.		kg / T	1,15 / 0,776	1,15 / 0,776
Operating range	Cool Min ~ Max	°C	-15 ~ +46	-15 ~ +46
	Heat Min ~ Max	°C	-20 ~ +24	-20 ~ +24



SEER and SCOP: For KIT-36PY2ZH5. INTERNET CONTROL: Optional.

Compatible with all Panasonic connectivity solutions. For detailed information go to the Control Systems section.

Technical focus

- Fresh air distribution
- Multidirectional air flow
- Integrated drain pump gives 850mm lift
- 3 speed centrifugal fan
- DC FAN for better efficiency and control
- Easy connection and control of external fan or ERV using the connector PAW-FDC on the indoor unit PCB. The external device can be controlled by the remote control of the Panasonic indoor unit

Lighter and slimmer, easier installation

Lightweight and very slim which makes installation possible even in narrow ceilings.

Designed to fit exactly into a 600x600mm ceiling grid without the need to alter the bar configuration.

A drain height of approximately 850mm from the ceiling surface

The drain height can be increased by approx. 350mm over the conventional value by using a high-lift drain pump, and long horizontal piping is possible.

Lightweight at 18kg, the unit is also very slim with a height of only 288mm, making installation possible even in narrow ceilings.

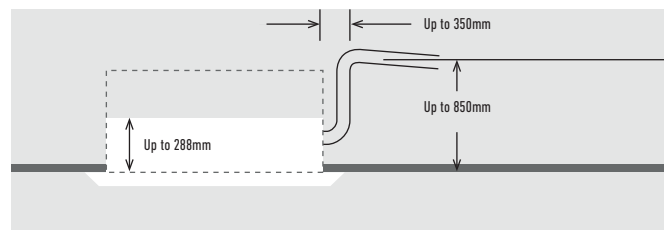

Significant reduction of power consumption by using highly developed DC fan motors with variable speed, special heat exchangers, etc.

			3,60kW	4,50kW	5,00kW
Indoor unit			S-36PY2E5B	S-45PY2E5B ¹⁾	S-50PY2E5B
Cooling capacity		kW	3,60	4,50	5,00
Heating capacity		kW	4,00	5,20	5,60
Current	Cool	A	0,30	0,32	0,35
	Heat	A	0,30	0,30	0,35
Input power	Cool	kW	0,04	0,04	0,05
	Heat	kW	0,04	0,04	0,04
Air volume	Cool (Hi / Med / Lo)	m ³ /min	9,7 / 8,0 / 6,0	10,0 / 8,8 / 7,0	11,1 / 9,8 / 8,5
	Heat (Hi / Med / Lo)	m ³ /min	9,9 / 8,2 / 6,0	10,3 / 9,2 / 7,0	11,1 / 9,8 / 8,7
Moisture removal volume		L/h	1,5	2,2	2,4
Sound pressure	Cool (Hi / Med / Lo)	dB(A)	36 / 32 / 26	38 / 34 / 28	40 / 37 / 33
	Heat (Hi / Med / Lo)	dB(A)	36 / 32 / 26	38 / 34 / 28	40 / 37 / 33
Sound power	Cool (Hi)	dB	51 / 47 / 41	53 / 49 / 43	55 / 52 / 48
	Heat (Hi)	dB	51 / 47 / 41	53 / 49 / 43	55 / 52 / 48
Dimension (H x W x D)	Indoor	mm	288 x 583 x 583	288 x 583 x 583	288 x 583 x 583
	Panel CZ-KPY3AW	mm	31 x 700 x 700	31 x 700 x 700	31 x 700 x 700
	Panel CZ-KPY3BW	mm	31 x 625 x 625	31 x 625 x 625	31 x 625 x 625
Net weight	Indoor	kg	18	18	18
	Panel	kg	2,4	2,4	2,4
Piping connections	Liquid pipe	Inch (mm)	1/4 (6,35)	1/4 (6,35)	1/4 (6,35)
	Gas pipe	Inch (mm)	1/2 (12,70)	1/2 (12,70)	1/2 (12,70)
Operating range	Cool Min ~ Max	°C	+18 ~ +32	+18 ~ +32	+18 ~ +32
	Heat Min ~ Max	°C	+16 ~ +30	+16 ~ +30	+16 ~ +30

1) Only for multi combinations.
Recommended fuse for the indoor 3A.

Accessories

CZ-RTC5B	Wired remote controller with datanavi
CZ-RWS3	Infrared remote controller
CZ-RE2C2	Simplified remote controller
PAW-WTRAY	Tray for condenser water compatible with base ground support

Accessories

PAW-GRDBSE20	Outdoor base ground support for noise and vibration absorption
PAW-GRDSTD40	Outdoor elevation platform 400 x 900 x 400mm
CZ-CAPWFC1	NEW Commercial WLAN Adaptor

1) EER and COP calculation is based in accordance to EN14511. 2) For models below 12kW, the SEER and SCOP is calculated based on values of EU/626/2011. For models above 12kW, the SEER and SCOP is calculated based on values of EU/2281/2016. 3) The annual energy consumption is calculated in accordance to EU/626/2011. 4) The sound pressure of the units shows the value measured of the position 1,5 below the unit. The sound pressure is measured in accordance with Eurovent 6/C/006-97 specification. 5) When installing the outdoor unit at a higher position than the indoor unit. * Recommended fuse for the indoor 3A.

PACi Elite 4 Way 90x90 Cassette Inverter+

• R32 GAS



CZ-KPU3W
Standard panel.

Large capacity PACi. Trusted comfort and high efficiency

Thanks to advances in design and technology such as the high performance turbo fan which is more efficient and silent, and nano™ X air purification, the U2 Panasonic 4 way 90x90 Cassette offers high energy saving, fresh air and comfort.

CZ-KPU3AW
Optional Econavi panel
(CZ-RTC5B is required).



CZ-CNEXU1
Optional nano™ X kit
(CZ-RTC5B is required).

CZ-RWS3 + CZ-RWRU3
Optional Controller.
Infrared remote controller.

CZ-RE2C2
Optional Controller.
Simplified remote controller.

			Single Phase							
			3,60kW	5,00kW	6,00kW	7,10kW	10,00kW	12,50kW	14,00kW	
KIT			KIT-36PU2ZH5	KIT-50PU2ZH5	KIT-60PU2ZH5	KIT-71PU2ZH5	KIT-100PU2ZH5	KIT-125PU2ZH5	KIT-140PU2ZH5	
Remote controller			CZ-RTC5B	CZ-RTC5B	CZ-RTC5B	CZ-RTC5B	CZ-RTC5B	CZ-RTC5B	CZ-RTC5B	
Cooling capacity	Nominal (Min-Max)	kW	3,60 (1,50 - 4,00)	5,00 (1,50 - 5,60)	6,00 (2,00 - 7,10)	7,10 (2,20 - 9,00)	10,00 (3,10 - 12,50)	12,50 (3,20 - 14,00)	14,00 (3,30 - 16,00)	
EER ¹⁾		W/W	5,22	4,31	4,05	4,06	4,41	3,80	3,41	
SEER ²⁾			8,50 A+++	8,20 A++	8,00 A++	7,70 A++	7,80 A++	7,68	7,24	
Pdesign		kW	3,60	5,00	6,00	7,10	10,00	12,50	14,00	
Input power cooling		kW	0,69	1,16	1,48	1,75	2,27	3,29	4,11	
Annual energy consumption ³⁾		kWh/a	148	213	262	323	449	—	—	
Heating capacity	Nominal (Min-Max)	kW	4,00 (1,50 - 5,00)	5,60 (1,50 - 6,50)	7,00 (1,80 - 8,00)	8,00 (2,00 - 9,00)	11,20 (3,10 - 14,00)	14,00 (3,20 - 16,00)	16,00 (3,30 - 18,00)	
COP ¹⁾		W/W	5,48	4,71	4,29	4,30	5,00	4,61	4,30	
SCOP ²⁾			5,10 A+++	4,90 A++	4,80 A++	4,80 A++	4,90 A++	4,73	4,60	
Pdesign at -10°C		kW	3,60	4,50	6,00	5,20	8,00	9,50	10,60	
Input power heating		kW	0,73	1,19	1,63	1,86	2,24	3,04	3,72	
Annual energy consumption ³⁾		kWh/a	988	1286	1750	1517	2286	—	—	
Indoor unit			S-36PU2E5B	S-50PU2E5B	S-60PU2E5B	S-71PU2E5B	S-100PU2E5B	S-125PU2E5B	S-140PU2E5B	
Air volume	Hi / Med / Lo	m ³ /min	14,5 / 13,0 / 11,5	16,5 / 13,5 / 11,5	21,0 / 16,0 / 13,0	22,0 / 16,0 / 13,0	36,0 / 26,0 / 18,0	37,0 / 27,0 / 19,0	38,0 / 29,0 / 20,0	
Sound pressure ⁴⁾	Hi / Med / Lo	dB(A)	30 / 28 / 27	32 / 29 / 27	36 / 31 / 28	37 / 31 / 28	45 / 38 / 32	46 / 39 / 33	47 / 40 / 34	
Dimension	Indoor (H x W x D)	mm	256 x 840 x 840	256 x 840 x 840	256 x 840 x 840	256 x 840 x 840	319 x 840 x 840	319 x 840 x 840	319 x 840 x 840	
	Panel (H x W x D)	mm	33,5 x 950 x 950	33,5 x 950 x 950	33,5 x 950 x 950	33,5 x 950 x 950	33,5 x 950 x 950	33,5 x 950 x 950	33,5 x 950 x 950	
Net weight	Indoor / Panel	kg	19 / 5	19 / 5	20 / 5	20 / 5	25 / 5	25 / 5	25 / 5	
Outdoor unit			U-36PZH2E5	U-50PZH2E5	U-60PZH2E5	U-71PZH2E5	U-100PZH2E5	U-125PZH2E5	U-140PZH2E5	
Power source		V	220 / 230 / 240	220 / 230 / 240	220 / 230 / 240	220 / 230 / 240	220 / 230 / 240	220 / 230 / 240	220 / 230 / 240	
Current	Cool (Hi / Med / Lo)	A	3,35 / 3,20 / 3,05	5,45 / 5,25 / 5,00	7,30 / 6,95 / 6,70	8,25 / 7,90 / 7,55	10,40 / 9,95 / 9,50	15,20 / 14,50 / 13,90	19,10 / 18,20 / 17,50	
	Heat (Hi / Med / Lo)	A	3,55 / 3,40 / 3,25	5,70 / 5,45 / 5,20	8,05 / 7,70 / 7,40	8,60 / 8,25 / 8,00	10,20 / 9,80 / 9,40	14,00 / 13,40 / 12,80	17,20 / 16,50 / 15,80	
Air volume	Cool / Heat	m ³ /min	40 / 40	40 / 45	40 / 45	61 / 60	118 / 108	125 / 122	129 / 116	
Sound pressure	Cool / Heat (Hi)	dB(A)	43 / 44	45 / 48	46 / 49	48 / 50	52 / 52	53 / 53	54 / 54	
Sound power	Cool / Heat (Hi)	dB	62 / 64	64 / 68	65 / 69	65 / 67	69 / 69	70 / 70	71 / 71	
Dimension	H x W x D	mm	695 x 875 x 320	695 x 875 x 320	695 x 875 x 320	996 x 940 x 340	1416 x 940 x 340	1416 x 940 x 340	1416 x 940 x 340	
Net weight		kg	43	43	44	68	99	99	99	
Piping connections	Liquid pipe	Inch (mm)	1/4 (6,35)	1/4 (6,35)	3/8 (9,52)	3/8 (9,52)	3/8 (9,52)	3/8 (9,52)	3/8 (9,52)	
	Gas pipe	Inch (mm)	1/2 (12,70)	1/2 (12,70)	5/8 (15,88)	5/8 (15,88)	5/8 (15,88)	5/8 (15,88)	5/8 (15,88)	
Pipe length range		m	3 ~ 40	3 ~ 40	3 ~ 40	5 ~ 50	5 ~ 85	5 ~ 85	5 ~ 85	
Elevation difference (in/out) ⁵⁾		m	30	30	30	30	30	30	30	
Pipe length for additional gas		m	30	30	30	30	30	30	30	
Additional gas amount		g/m	20	20	35	45	45	45	45	
Refrigerant (R32) / CO ₂ Eq.		kg / T	1,15 / 0,776	1,15 / 0,776	1,45 / 0,979	1,95 / 1,316	3,05 / 2,059	3,05 / 2,059	3,05 / 2,059	
Operating range	Cool Min ~ Max	°C	-15 ~ +46	-15 ~ +46	-15 ~ +46	-15 ~ +46	-15 ~ +46	-15 ~ +46	-15 ~ +46	
	Heat Min ~ Max	°C	-20 ~ +24	-20 ~ +24	-20 ~ +24	-20 ~ +24	-20 ~ +24	-20 ~ +24	-20 ~ +24	

Accessories

CZ-RTC5B	Wired remote controller with Econavi function and datanavi
CZ-RWS3 + CZ-RWRU3	Infrared remote controller
CZ-RE2C2	Simplified remote controller
CZ-KPU3AW	Econavi exclusive panel
CZ-CNEXU1	nano™ X air purifying system

Accessories

PAW-WTRAY	Tray for condenser water compatible with base ground support
PAW-GRDBSE20	Outdoor base ground support for noise and vibration absorption
CZ-CAPWFC1	NEW Commercial WLAN Adaptor

Technical focus

- High performance turbo fan, path system for heat exchanger
- nanoe™ X: The first air purifier technology in commercial air conditioning
- Econavi: Intelligent sensor to reduce waste of energy
- Datanavi simple support tool App with remote controller (CZ-RTC5B)
- Lower noise in slow fan operation
- Light weight, easy piping
- Drain pump included

Group control, circulation function

Circulating operation is activated when a room is unoccupied to evenly distribute air and minimize temperature gaps in both heating and cooling operation.

nanoe™ X deodorises and inhibits certain bacteria & viruses

The newly developed nanoe™ X device produces 10x times more OH radicals (4800 billion)¹ than regular nanoe™ device. Greater amounts of OH radicals contained in nanoe™ X lead to outstanding effects in bacteria, viruses and allergens inhibition as well as deodorisation. A fresher and cleaner home awaits you.

1) Based on Panasonic Survey.

CZ-RTC5B and optional accessory CZ-CNEXU1 are required to use nanoe™ X function.

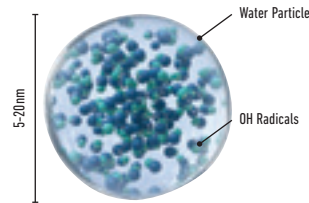

**4800 BILLION
OH RADICALS /
PER SECOND**

			Three Phase			
			7,10kW	10,00kW	12,50kW	14,00kW
KIT			KIT-71PU2ZH8	KIT-100PU2ZH8	KIT-125PU2ZH8	KIT-140PU2ZH8
Remote controller			CZ-RTC5B	CZ-RTC5B	CZ-RTC5B	CZ-RTC5B
Cooling capacity	Nominal (Min - Max)	kW	7,10 (2,20 ~ 9,00)	10,00 (3,10 ~ 12,50)	12,50 (3,20 ~ 14,00)	14,00 (3,30 ~ 16,00)
EER ¹⁾		W/W	4,06	4,41	3,80	3,41
SEER²⁾			7,60 A++	7,70 A++	7,64	7,22
Pdesign		kW	7,10	10,00	12,50	14,00
Input power cooling		kW	1,75	2,27	3,29	4,11
Annual energy consumption ³⁾		kWh/a	327	455	—	—
Heating capacity	Nominal (Min - Max)	kW	8,00 (2,00 ~ 9,00)	11,20 (3,10 ~ 14,00)	14,00 (3,20 ~ 16,00)	16,00 (3,30 ~ 18,00)
COP ¹⁾		W/W	4,30	5,00	4,61	4,30
SCOP²⁾			4,80 A++	4,90 A++	4,73	4,60
Pdesign at -10°C		kW	5,20	8,00	9,50	10,60
Input power heating		kW	1,86	2,24	3,04	3,72
Annual energy consumption ³⁾		kWh/a	1517	2286	—	—
Indoor unit			S-71PU2E5B	S-100PU2E5B	S-125PU2E5B	S-140PU2E5B
Air volume	Hi / Med / Lo	m ³ /min	22,0 / 16,0 / 13,0	36,0 / 26,0 / 18,0	37,0 / 27,0 / 19,0	38,0 / 29,0 / 20,0
Sound pressure ⁴⁾	Hi / Med / Lo	dB(A)	37 / 31 / 28	45 / 38 / 32	46 / 39 / 33	47 / 40 / 34
Dimension	Indoor (H x W x D)	mm	256 x 840 x 840	319 x 840 x 840	319 x 840 x 840	319 x 840 x 840
	Panel (H x W x D)	mm	33,5 x 950 x 950	33,5 x 950 x 950	33,5 x 950 x 950	33,5 x 950 x 950
Net weight	Indoor / Panel	kg	20 / 5	25 / 5	25 / 5	25 / 5
Outdoor unit			U-71PZH2E8	U-100PZH2E8	U-125PZH2E8	U-140PZH2E8
Power source		V	380 / 400 / 415	380 / 400 / 415	380 / 400 / 415	380 / 400 / 415
Current	Cool (Hi / Med / Lo)	A	2,75 / 2,65 / 2,55	3,50 / 3,35 / 3,20	5,15 / 4,90 / 4,70	6,45 / 6,15 / 5,90
	Heat (Hi / Med / Lo)	A	2,90 / 2,80 / 2,70	3,45 / 3,30 / 3,15	4,75 / 4,50 / 4,35	5,85 / 5,55 / 5,35
Air volume	Cool / Heat	m ³ /min	61 / 60	118 / 108	125 / 112	129 / 116
Sound pressure	Cool / Heat (Hi)	dB(A)	48 / 50	52 / 52	53 / 53	54 / 54
Sound power	Cool / Heat (Hi)	dB	65 / 67	69 / 69	70 / 70	71 / 71
Dimension	H x W x D	mm	996 x 940 x 340	1416 x 940 x 340	1416 x 940 x 340	1416 x 940 x 340
Net weight		kg	68	99	99	99
Piping connections	Liquid pipe	Inch (mm)	3/8 (9,52)	3/8 (9,52)	3/8 (9,52)	3/8 (9,52)
	Gas pipe	Inch (mm)	5/8 (15,88)	5/8 (15,88)	5/8 (15,88)	5/8 (15,88)
Pipe length range		m	5 ~ 50	5 ~ 85	5 ~ 85	5 ~ 85
Elevation difference (in/out) ⁵⁾		m	30	30	30	30
Pipe length for additional gas		m	30	30	30	30
Additional gas amount		g/m	45	45	45	45
Refrigerant (R32) / CO ₂ Eq.		kg / T	1,95 / 1,316	3,05 / 2,059	3,05 / 2,059	3,05 / 2,059
Operating range	Cool Min ~ Max	°C	-15 ~ +46	-15 ~ +46	-15 ~ +46	-15 ~ +46
	Heat Min ~ Max	°C	-20 ~ +24	-20 ~ +24	-20 ~ +24	-20 ~ +24

1) EER and COP calculation is based in accordance to EN14511. 2) For models below 12kW, the SEER and SCOP is calculated based on values of EU/626/2011. For models above 12kW, the SEER and SCOP is calculated based on values of EU/2281/2016. 3) The annual energy consumption is calculated in accordance to EU/626/2011. 4) The sound pressure of the units shows the value measured of the position 1,5 below the unit. The sound pressure is measured in accordance with Eurovent 6/C/006-97 specification. 5) When installing the outdoor unit at a higher position than the indoor unit. * Recommended fuse for the indoor 3A.



SEER and SCOP: For KIT-36PU2ZH5. ECONAVI and INTERNET CONTROL: Optional.

Compatible with all Panasonic connectivity solutions. For detailed information go to the Control Systems section.

PACi Standard 4 Way 90x90 Cassette Inverter+

• R32 GAS



CZ-KPU3W
Standard panel.



Large capacity PACi. Trusted comfort and high efficiency

Thanks to advances in design and technology such as the high performance turbo fan which is more efficient and silent, and nano™ X air purification, the U2 Panasonic 4 way 90x90 Cassette offers high energy saving, fresh air and comfort.



CZ-KPU3AW
Optional Econavi panel
(CZ-RTC5B is required).



CZ-CNEXU1
Optional nano™ X kit
(CZ-RTC5B is required).



CZ-RWS3 + CZ-RWRU3
Optional Controller.
Infrared remote controller.



CZ-RE2C2
Optional Controller.
Simplified remote controller.

			Single Phase				
			6,00kW	7,10kW	10,00kW	12,50kW	14,00kW
KIT			KIT-60PU2Z5	KIT-71PU2Z5	KIT-100PU2Z5	KIT-125PU2Z5	KIT-140PU2Z5
Remote controller			CZ-RTC5B	CZ-RTC5B	CZ-RTC5B	CZ-RTC5B	CZ-RTC5B
Cooling capacity	Nominal (Min-Max)	kW	6,00 (2,00 ~ 7,10)	7,10 (2,00 ~ 7,70)	10,00 (3,00 ~ 11,50)	12,50 (3,20 ~ 13,50)	14,00 (3,30 ~ 15,00)
EER ¹⁾	Nominal (Min-Max)	W/W	4,00	3,50	3,82 (5,36 ~ 2,88)	3,58 (5,33 ~ 2,81)	3,23 (5,32 ~ 2,73)
SEER ²⁾			7,60 A++	7,60 A++	6,80 A++	6,75	6,51
Pdesign		kW	6,00	7,10	10,00	12,50	14,00
Input power cooling	Nominal (Min-Max)	kW	1,50	2,03	2,62 (0,56 ~ 4,00)	3,49 (0,60 ~ 4,80)	4,34 (0,62 ~ 5,50)
Annual energy consumption ³⁾		kWh/a	276	327	515	—	—
Heating capacity	Nominal (Min-Max)	kW	6,00 (1,80 ~ 7,00)	7,10 (1,80 ~ 8,10)	10,00 (3,00 ~ 14,00)	12,50 (3,30 ~ 15,00)	14,00 (3,40 ~ 16,00)
COP ¹⁾	Nominal (Min-Max)	W/W	4,72	4,36	4,93 (3,59 ~ 5,36)	4,43 (3,57 ~ 5,50)	4,18 (3,33 ~ 5,48)
SCOP ²⁾			4,70 A++	4,70 A++	4,40 A+	4,01	3,89
Pdesign at -10°C		kW	6,00	6,00	10,00	12,50	14,00
Input power heating	Nominal (Min-Max)	kW	1,27	1,63	2,03 (0,56 ~ 3,90)	2,82 (0,60 ~ 4,20)	3,35 (0,62 ~ 4,80)
Annual energy consumption ³⁾		kWh/a	1787	1787	3182	—	—
Indoor unit			S-60PU2E5B	S-71PU2E5B	S-100PU2E5B	S-125PU2E5B	S-140PU2E5B
Air volume	Hi / Med / Lo	m ³ /min	21,0 / 16,0 / 13,0	22,0 / 16,0 / 13,0	36,0 / 26,0 / 18,0	37,0 / 27,0 / 19,0	38,0 / 29,0 / 20,0
Moisture removal volume		L/h	1,7	2,5	2,7	4,8	6,0
Sound pressure ⁴⁾	Hi / Med / Lo	dB(A)	36 / 31 / 28	37 / 31 / 28	45 / 38 / 32	46 / 39 / 33	47 / 40 / 34
Sound power	Hi / Med / Lo	dB	51 / 46 / 43	52 / 46 / 43	60 / 53 / 47	61 / 54 / 48	62 / 55 / 49
Dimension	Indoor (H x W x D)	mm	256 x 840 x 840	256 x 840 x 840	319 x 840 x 840	319 x 840 x 840	319 x 840 x 840
	Panel (H x W x D)	mm	33,5 x 950 x 950	33,5 x 950 x 950	33,5 x 950 x 950	33,5 x 950 x 950	33,5 x 950 x 950
Net weight	Indoor / Panel	kg	20 / 5	20 / 5	25 / 5	25 / 5	25 / 5
Outdoor unit			U-60PZ2E5	U-71PZ2E5	U-100PZ2E5	U-125PZ2E5	U-140PZ2E5
Power source		V	220 / 230 / 240	220 / 230 / 240	220 / 230 / 240	220 / 230 / 240	220 / 230 / 240
Current	Cool (Hi / Med / Lo)	A	7,40 / 7,05 / 6,75	9,95 / 9,50 / 9,10	12,10 / 11,50 / 11,10	16,30 / 15,60 / 15,00	20,40 / 19,50 / 18,70
	Heat (Hi / Med / Lo)	A	6,25 / 5,95 / 5,70	8,05 / 7,70 / 7,35	9,25 / 8,85 / 8,50	13,10 / 12,60 / 12,00	15,60 / 15,00 / 14,30
Air volume	Cool / Heat	m ³ /min	40 / 45	50 / 45	76 / 70	86 / 78	89 / 83
Sound pressure	Cool / Heat (Hi)	dB(A)	46 / 48	49 / 49	52 / 52	55 / 55	56 / 56
Sound power	Cool / Heat (Hi)	dB	65 / 68	69 / 69	70 / 70	73 / 73	74 / 74
Dimension	H x W x D	mm	695 x 875 x 320	695 x 875 x 320	996 x 980 x 370	996 x 980 x 370	996 x 980 x 370
Net weight		kg	44	44	90	94	94
Piping connections	Liquid pipe	Inch (mm)	3/8 (9,52)	3/8 (9,52)	3/8 (9,52)	3/8 (9,52)	3/8 (9,52)
	Gas pipe	Inch (mm)	5/8 (15,88)	5/8 (15,88)	5/8 (15,88)	5/8 (15,88)	5/8 (15,88)
Pipe length range		m	3 ~ 40	3 ~ 40	5 ~ 50	5 ~ 50	5 ~ 50
Elevation difference (in/out) ⁵⁾		m	30	30	30	30	30
Pipe length for additional gas		m	30	30	30	30	30
Additional gas amount		g/m	35	35	45	45	45
Refrigerant (R32) / CO ₂ Eq.		kg / T	1,45 / 0,979	1,45 / 0,979	2,60 / 1,755	2,98 / 2,0115	2,98 / 2,0115
Operating range	Cool Min ~ Max	°C	-10 ~ +43	-10 ~ +43	-10 ~ +43	-10 ~ +43	-10 ~ +43
	Heat Min ~ Max	°C	-15 ~ +24	-15 ~ +24	-15 ~ +24	-15 ~ +24	-15 ~ +24

Accessories

CZ-RTC5B	Wired remote controller with Econavi function and datanavi
CZ-RWS3 + CZ-RWRU3	Infrared remote controller
CZ-RE2C2	Simplified remote controller
CZ-KPU3AW	Econavi exclusive panel
CZ-CNEXU1	nano™ X air purifying system

Accessories

PAW-WTRAY	Tray for condenser water compatible with base ground support
PAW-GRDBSE20	Outdoor base ground support for noise and vibration absorption
CZ-CAPWFC1	NEW Commercial WLAN Adaptor

Technical focus

- High performance turbo fan, path system for heat exchanger
- nano[™] X: The first air purifier technology in commercial air conditioning
- Econavi: Intelligent sensor to reduce waste of energy
- Datanavi simple support tool App with remote controller (CZ-RTC5B)
- Lower noise in slow fan operation
- Light weight, easy piping
- Drain pump included

Group control, circulation function

Circulating operation is activated when a room is unoccupied to evenly distribute air and minimize temperature gaps in both heating and cooling operation.

nanoe[™] X deodorises and inhibits certain bacteria & viruses

The newly developed nano[™] X device produces 10x times more OH radicals (4800 billion)¹ than regular nano[™] device. Greater amounts of OH radicals contained in nano[™] X lead to outstanding effects in bacteria, viruses and allergens inhibition as well as deodorisation. A fresher and cleaner home awaits you.

1) Based on Panasonic Survey.

CZ-RTC5B and optional accessory CZ-CNEXU1 are required to use nano[™] X function.

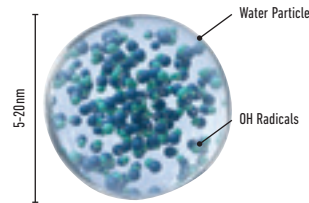

**4800 BILLION
OH RADICALS /
PER SECOND**

KIT	Three Phase			
	10,00kW KIT-100PU2Z8 CZ-RTC5B	12,50kW KIT-125PU2Z8 CZ-RTC5B	14,00kW KIT-140PU2Z8 CZ-RTC5B	
Remote controller				
Cooling capacity	Nominal (Min - Max) kW	10,00 (3,00 - 11,50)	12,50 (3,20 - 13,50)	14,00 (3,30 - 15,00)
EER ¹⁾	Nominal (Min - Max) W/W	3,82 (5,36 - 2,88)	3,58 (5,33 - 2,81)	3,23 (5,32 - 2,73)
SEER ²⁾		6,70 A++	6,73	6,49
Pdesign	kW	10,00	12,50	14,00
Input power cooling	Nominal (Min - Max) kW	2,62 (0,56 - 4,00)	3,49 (0,60 - 4,80)	4,34 (0,62 - 5,50)
Annual energy consumption ³⁾	kWh/a	521	—	—
Heating capacity	Nominal (Min - Max) kW	10,00 (3,00 - 14,00)	12,50 (3,30 - 15,00)	14,00 (3,40 - 16,00)
COP ¹⁾	Nominal (Min - Max) W/W	4,93 (3,59 - 5,36)	4,43 (3,57 - 5,50)	4,18 (3,33 - 5,48)
SCOP ²⁾		4,40 A+	4,01	3,89
Pdesign at -10°C	kW	10,00	12,50	14,00
Input power heating	Nominal (Min - Max) kW	2,03 (0,56 - 3,90)	2,82 (0,60 - 4,20)	3,35 (0,62 - 4,80)
Annual energy consumption ³⁾	kWh/a	3182	—	—
Indoor unit		S-100PU2E5B	S-125PU2E5B	S-140PU2E5B
Air volume	Hi / Med / Lo m ³ /min	36,0 / 26,0 / 18,0	37,0 / 27,0 / 19,0	38,0 / 29,0 / 20,0
Moisture removal volume	L/h	2,7	4,8	6,0
Sound pressure ⁴⁾	Hi / Med / Lo dB(A)	45 / 38 / 32	46 / 39 / 33	47 / 40 / 34
Sound power	Hi / Med / Lo dB	60 / 53 / 47	61 / 54 / 48	62 / 55 / 49
Dimension	Indoor (H x W x D) mm	319 x 840 x 840	319 x 840 x 840	319 x 840 x 840
	Panel (H x W x D) mm	33,5 x 950 x 950	33,5 x 950 x 950	33,5 x 950 x 950
Net weight	Indoor / Panel kg	25 / 5	25 / 5	25 / 5
Outdoor unit		U-100PZ2E8	U-125PZ2E8	U-140PZ2E8
Power source	V	380 / 400 / 415	380 / 400 / 415	380 / 400 / 415
Current	Cool (Hi / Med / Lo) A	4,10 / 3,90 / 3,75	5,45 / 5,20 / 5,00	6,85 / 6,50 / 6,25
	Heat (Hi / Med / Lo) A	3,15 / 3,00 / 2,90	4,40 / 4,15 / 4,00	5,25 / 4,95 / 4,80
Air volume	Cool / Heat m ³ /min	76 / 70	86 / 78	89 / 83
Sound pressure	Cool / Heat (Hi) dB(A)	52 / 52	55 / 55	56 / 56
Sound power	Cool / Heat (Hi) dB	70 / 70	73 / 73	74 / 74
Dimension	H x W x D mm	996 x 980 x 370	996 x 980 x 370	996 x 980 x 370
Net weight	kg	90	94	94
Piping connections	Liquid pipe Inch (mm)	3/8 (9,52)	3/8 (9,52)	3/8 (9,52)
	Gas pipe Inch (mm)	5/8 (15,88)	5/8 (15,88)	5/8 (15,88)
Pipe length range	m	5 - 50	5 - 50	5 - 50
Elevation difference (in/out) ⁵⁾	m	30	30	30
Pipe length for additional gas	m	30	30	30
Additional gas amount	g/m	45	45	45
Refrigerant (R32) / CO ₂ Eq.	kg / T	2,60 / 1,755	2,98 / 2,0115	2,98 / 2,0115
Operating range	Cool Min ~ Max °C	-10 ~ +43	-10 ~ +43	-10 ~ +43
	Heat Min ~ Max °C	-15 ~ +24	-15 ~ +24	-15 ~ +24

1) EER and COP calculation is based in accordance to EN14511. 2) For models below 12kW, the SEER and SCOP is calculated based on values of EU/626/2011. For models above 12kW, the SEER and SCOP is calculated based on values of EU/2281/2016. 3) The annual energy consumption is calculated in accordance to EU/626/2011. 4) The sound pressure of the units shows the value measured of the position 1,5 below the unit. The sound pressure is measured in accordance with Eurovent 6/C/006-97 specification. 5) When installing the outdoor unit at a higher position than the indoor unit. * Recommended fuse for the indoor 3A.



SEER and SCOP: For KIT-60PU2Z5 and KIT-71PU2Z5. ECONAVI and INTERNET CONTROL: Optional.
Compatible with all Panasonic connectivity solutions. For detailed information go to the Control Systems section.

PACi Elite Ceiling Inverter+ • R32 GAS

Ceiling mounted units provide large and wide air distribution which is good for big rooms

The height and depth of all capacities are the same for unified appearance in mixed installations.



CZ-RWS3 + CZ-RWRT3
Optional Controller.
Infrared remote controller.



CZ-RE2C2
Optional Controller.
Simplified remote controller.



CZ-CENS1
Optional Econavi Sensor.

			Single Phase						
			3,60kW	5,00kW	6,00kW	7,10kW	10,00kW	12,50kW	14,00kW
KIT			KIT-36PT2ZH5	KIT-50PT2ZH5	KIT-60PT2ZH5	KIT-71PT2ZH5	KIT-100PT2ZH5	KIT-125PT2ZH5	KIT-140PT2ZH5
Remote controller			CZ-RTC5B	CZ-RTC5B	CZ-RTC5B	CZ-RTC5B	CZ-RTC5B	CZ-RTC5B	CZ-RTC5B
Cooling capacity	Nominal (Min-Max)	kW	3,60(1,50-4,00)	5,00(1,50-5,60)	6,00(2,00-7,10)	7,10(2,20-9,00)	10,00(3,10-12,50)	12,50(3,20-14,00)	14,00(3,30-16,00)
EER ¹⁾		W/W	5,07	4,17	4,08	3,78	4,05	3,45	3,10
SEER²⁾			7,20 A++	7,00 A++	7,20 A++	6,70 A++	7,00 A++	6,59	5,70
P _{design}		kW	3,60	5,00	6,00	7,10	10,00	12,50	14,00
Input power cooling		kW	0,71	1,20	1,47	1,88	2,47	3,62	4,52
Annual energy consumption ³⁾		kWh/a	175	250	292	371	500	—	—
Heating capacity	Nominal (Min-Max)	kW	4,00(1,50-5,00)	5,60(1,50-6,50)	7,00(1,80-8,00)	8,00(2,00-9,00)	11,20(3,10-14,00)	14,00(3,20-16,00)	16,00(3,30-18,00)
COP ¹⁾		W/W	5,19	4,34	4,43	4,15	4,31	3,99	3,67
SCOP²⁾			4,80 A++	4,60 A++	4,70 A++	4,60 A++	4,60 A++	4,36	4,00
P _{design} at -10°C		kW	3,60	4,50	6,00	5,20	8,00	9,50	10,60
Input power heating		kW	0,77	1,29	1,58	1,93	2,60	3,51	4,36
Annual energy consumption ³⁾		kWh/a	1050	1370	1787	1583	2435	—	—
Indoor unit			S-36PT2E5B	S-50PT2E5B	S-60PT2E5B	S-71PT2E5B	S-100PT2E5B	S-125PT2E5B	S-140PT2E5B
Air volume	Hi / Med / Lo	m ³ /min	14,0/12,0/10,5	15,0/12,5/10,5	20,0/17,0/14,5	21,0/18,0/15,5	30,0/25,0/23,0	34,0/28,0/24,0	35,0/29,0/25,0
Sound pressure ⁴⁾	Hi / Med / Lo	dB(A)	36/32/29	37/33/29	38/34/30	39/35/31	42/37/35	46/40/36	47/41/37
Dimension	HxWxD	mm	235x960x690	235x960x690	235x1275x690	235x1275x690	235x1590x690	235x1590x690	235x1590x690
Net weight		kg	27	27	33	33	40	40	40
Outdoor unit			U-36PZH2E5	U-50PZH2E5	U-60PZH2E5	U-71PZH2E5	U-100PZH2E5	U-125PZH2E5	U-140PZH2E5
Power source		V	220/230/240	220/230/240	220/230/240	220/230/240	220/230/240	220/230/240	220/230/240
Current	Cool (Hi / Med / Lo)	A	3,35/3,25/3,10	5,60/5,35/5,10	7,15/6,85/6,55	8,80/8,45/8,10	11,40/10,90/10,50	16,80/16,00/15,40	21,00/20,10/19,30
	Heat (Hi / Med / Lo)	A	3,65/3,50/3,35	6,10/5,85/5,60	7,75/7,40/7,10	8,90/8,50/8,20	12,00/11,50/11,00	16,20/15,50/14,90	20,30/19,40/18,60
Air volume	Cool / Heat	m ³ /min	40/40	40/45	40/45	61/60	118/108	125/122	129/116
Sound pressure	Cool / Heat (Hi)	dB(A)	43/44	45/48	46/49	48/50	52/52	53/53	54/54
Sound power	Cool / Heat (Hi)	dB	62/64	64/68	65/69	65/67	69/69	70/70	71/71
Dimension	HxWxD	mm	695x875x320	695x875x320	695x875x320	996x940x340	1416x940x340	1416x940x340	1416x940x340
Net weight		kg	43	43	44	68	99	99	99
Piping connections	Liquid pipe	Inch (mm)	1/4(6,35)	1/4(6,35)	3/8(9,52)	3/8(9,52)	3/8(9,52)	3/8(9,52)	3/8(9,52)
	Gas pipe	Inch (mm)	1/2(12,70)	1/2(12,70)	5/8(15,88)	5/8(15,88)	5/8(15,88)	5/8(15,88)	5/8(15,88)
Pipe length range		m	3~40	3~40	3~40	5~50	5~85	5~85	5~85
Elevation difference (in/out) ⁵⁾		m	30	30	30	30	30	30	30
Pipe length for additional gas		m	30	30	30	30	30	30	30
Additional gas amount		g/m	20	20	35	45	45	45	45
Refrigerant (R32) / CO ₂ Eq.		kg / T	1,15/0,776	1,15/0,776	1,45/0,979	1,95/1,316	3,05/2,059	3,05/2,059	3,05/2,059
Operating range	Cool Min ~ Max	°C	-15~+46	-15~+46	-15~+46	-15~+46	-15~+46	-15~+46	-15~+46
	Heat Min ~ Max	°C	-20~+24	-20~+24	-20~+24	-20~+24	-20~+24	-20~+24	-20~+24

Accessories

CZ-RTC5B	Wired remote controller with Econavi function and datanavi
CZ-RWS3 + CZ-RWRT3	Infrared remote controller
CZ-RE2C2	Simplified remote controller
PAW-WTRAY	Tray for condenser water compatible with base ground support

Accessories

PAW-GRDBSE20	Outdoor base ground support for noise and vibration absorption
PAW-GRDSTD40	Outdoor elevation platform 400x900x400mm
CZ-CAPWFC1	NEW Commercial WLAN Adaptor

Technical focus

- Wide air distribution for large rooms
- Horizontal air flow reaches maximum 9,5m
- Fresh air connection available on the unit
- Slim design with 235mm height fits narrow space
- Silent operation
- Datanavi simple support tool App with remote controller (CZ-RTC5B)
- Twin, Triple and Double-twin split options
- Easy connection and control of external fan or ERV using the connector PAW-FDC on the indoor unit PCB. The external device can be controlled by the remote control of the Panasonic indoor unit

Air distribution is altered depending on the operational mode

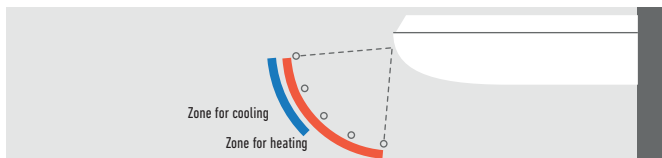

Further comfort improvement with airflow distribution

Horizontal air flow reaches maximum 9,5m. This is ideal for wide rooms. The wide air discharge opening expands the air flow to the left and the right. The unpleasant feeling caused when the air flow directly hits the human body is prevented by the "Draft prevention position", which changes the swing width, so that the degree of comfort is increased.

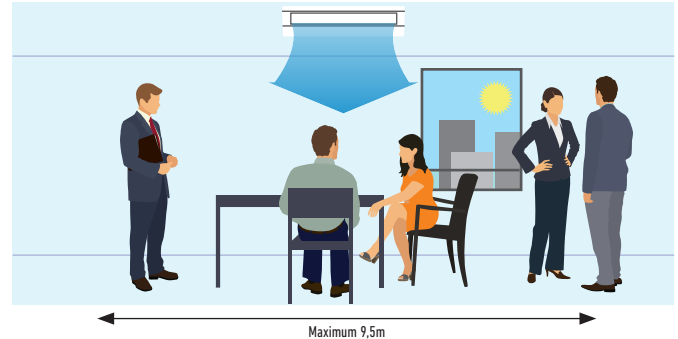

			Three Phase			
			7,10kW	10,00kW	12,50kW	14,00kW
KIT			KIT-71PT2ZH8	KIT-100PT2ZH8	KIT-125PT2ZH8	KIT-140PT2ZH8
Remote controller			CZ-RTC5B	CZ-RTC5B	CZ-RTC5B	CZ-RTC5B
Cooling capacity	Nominal (Min - Max)	kW	7,10 (2,20 - 9,00)	10,00 (3,10 - 12,50)	12,50 (3,20 - 14,00)	14,00 (3,30 - 16,00)
EER ¹⁾		W/W	3,78	4,05	3,45	3,10
SEER ²⁾			6,60 A++	6,90 A++	6,56	6,23
Pdesign		kW	7,10	10,00	12,50	14,00
Input power cooling		kW	1,88	2,47	3,62	4,52
Annual energy consumption ³⁾		kWh/a	375	507	—	—
Heating capacity	Nominal (Min - Max)	kW	8,00 (2,00 - 9,00)	11,20 (3,10 - 14,00)	14,00 (3,20 - 16,00)	16,00 (3,30 - 18,00)
COP ¹⁾		W/W	4,15	4,31	3,99	3,67
SCOP ²⁾			4,60 A++	4,60 A++	4,36	4,28
Pdesign at -10°C		kW	5,20	8,00	9,50	10,60
Input power heating		kW	1,93	2,60	3,51	4,36
Annual energy consumption ³⁾		kWh/a	1583	2435	—	—
Indoor unit			S-71PT2E5B	S-100PT2E5B	S-125PT2E5B	S-140PT2E5B
Air volume	Hi / Med / Lo	m ³ /min	21,0 / 18,0 / 15,5	30,0 / 25,0 / 23,0	34,0 / 28,0 / 24,0	35,0 / 29,0 / 25,0
Sound pressure ⁴⁾	Hi / Med / Lo	dB(A)	39 / 35 / 31	42 / 37 / 35	46 / 40 / 36	47 / 41 / 37
Dimension	H x W x D	mm	235 x 1275 x 690	235 x 1590 x 690	235 x 1590 x 690	235 x 1590 x 690
Net weight		kg	33	40	40	40
Outdoor unit			U-71PZH2E8	U-100PZH2E8	U-125PZH2E8	U-140PZH2E8
Power source		V	380 / 400 / 415	380 / 400 / 415	380 / 400 / 415	380 / 400 / 415
Current	Cool (Hi / Med / Lo)	A	2,95 / 2,85 / 2,75	3,85 / 3,65 / 3,55	5,65 / 5,40 / 5,20	7,10 / 6,75 / 6,50
	Heat (Hi / Med / Lo)	A	3,00 / 2,90 / 2,80	4,05 / 3,85 / 3,75	5,50 / 5,20 / 5,05	6,85 / 6,50 / 6,30
Air volume	Cool / Heat	m ³ /min	61 / 60	118 / 108	125 / 112	129 / 116
Sound pressure	Cool / Heat (Hi)	dB(A)	48 / 50	52 / 52	53 / 53	54 / 54
Sound power	Cool / Heat (Hi)	dB	65 / 67	69 / 69	70 / 70	71 / 71
Dimension	H x W x D	mm	996 x 940 x 340	1416 x 940 x 340	1416 x 940 x 340	1416 x 940 x 340
Net weight		kg	68	99	99	99
Piping connections	Liquid pipe	Inch (mm)	3/8 (9,52)	3/8 (9,52)	3/8 (9,52)	3/8 (9,52)
	Gas pipe	Inch (mm)	5/8 (15,88)	5/8 (15,88)	5/8 (15,88)	5/8 (15,88)
Pipe length range		m	5 - 50	5 - 85	5 - 85	5 - 85
Elevation difference (in/out) ⁵⁾		m	30	30	30	30
Pipe length for additional gas		m	30	30	30	30
Additional gas amount		g/m	45	45	45	45
Refrigerant (R32) / CO ₂ Eq.		kg / T	1,95 / 1,316	3,05 / 2,059	3,05 / 2,059	3,05 / 2,059
Operating range	Cool Min ~ Max	°C	-15 ~ +46	-15 ~ +46	-15 ~ +46	-15 ~ +46
	Heat Min ~ Max	°C	-20 ~ +24	-20 ~ +24	-20 ~ +24	-20 ~ +24

1) EER and COP calculation is based in accordance to EN14511. 2) For models below 12kW, the SEER and SCOP is calculated based on values of EU/626/2011. For models above 12kW, the SEER and SCOP is calculated based on values of EU/2281/2016. 3) The annual energy consumption is calculated in accordance to EU/626/2011. 4) The sound pressure of the units shows the value measured of the position 1m in front of the main body and 1m below the unit. The sound pressure is measured in accordance with Eurovent 6/C/006-97 specification. 5) When installing the outdoor unit at a higher position than the indoor unit. * Recommended fuse for the indoor 3A.



SEER and SCOP: For KIT-36PT2ZH5. INTERNET CONTROL: Optional.

Compatible with all Panasonic connectivity solutions. For detailed information go to the Control Systems section.

PACi Standard Ceiling Inverter+ • R32 GAS

Ceiling mounted units provide large and wide air distribution which is good for big rooms

The height and depth of all capacities are the same for unified appearance in mixed installations.

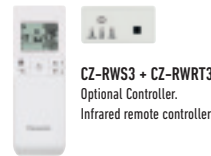

			Single Phase					
			6,00kW	7,10kW	10,00kW	12,50kW	14,00kW	
KIT			KIT-60PT2Z5	KIT-71PT2Z5	KIT-100PT2Z5	KIT-125PT2Z5	KIT-140PT2Z5	
Remote controller			CZ-RTC5B	CZ-RTC5B	CZ-RTC5B	CZ-RTC5B	CZ-RTC5B	
Cooling capacity	Nominal (Min-Max)	kW	6,00(2,00~7,10)	7,10(2,00~7,70)	10,00(3,00~11,50)	12,50(3,20~13,50)	14,00(3,30~15,00)	
EER ¹⁾	Nominal (Min-Max)	W/W	4,00	3,55	3,64(5,36~2,80)	3,32(5,33~2,77)	2,98(5,32~2,73)	
SEER ²⁾			6,80A++	6,50A++	6,50A++	5,77	5,49	
Pdesign			6,00	7,10	10,00	12,50	14,00	
Input power cooling	Nominal (Min-Max)	kW	1,50	2,00	2,75(0,56~4,10)	3,76(0,60~4,88)	4,70(0,62~5,50)	
Annual energy consumption ³⁾			309	382	535	1300	1530	
Heating capacity	Nominal (Min-Max)	kW	6,00(1,80~7,00)	7,10(1,80~8,10)	10,00(3,00~14,00)	12,50(3,30~15,00)	14,00(3,40~16,00)	
COP ¹⁾	Nominal (Min-Max)	W/W	4,80	4,41	4,24(5,36~3,50)	3,89(4,52~3,41)	3,70(5,48~3,08)	
SCOP ²⁾			4,60A++	4,30A+	4,20A+	3,75	3,70	
Pdesign at -10°C			6,00	6,00	10,00	12,50	13,60	
Input power heating	Nominal (Min-Max)	kW	1,25	1,62	2,36(0,56~4,00)	3,21(0,73~4,40)	3,78(0,62~5,20)	
Annual energy consumption ³⁾			1826	1953	3324	4669	5153	
Indoor unit			S-60P2E5B	S-71P2E5B	S-100P2E5B	S-125P2E5B	S-140P2E5B	
Air volume	Hi / Med / Lo	m ³ /min	20,0/17,0/14,5	21,0/18,0/15,5	30/25/23	34/28/24	35/29/25	
Moisture removal volume			3,4	4,2	6,0	7,9	9,0	
Sound pressure ⁴⁾	Hi / Med / Lo	dB(A)	38/34/30	39/35/31	42/37/35	46/40/36	47/41/37	
Sound power	Hi / Med / Lo	dB	56/52/48	57/53/49	60/55/53	64/58/54	65/59/55	
Dimension	HxWxD	mm	235x1275x690	235x1275x690	235x1590x690	235x1590x690	235x1590x690	
Net weight			33	33	40	40	40	
Outdoor unit			U-60P2E5	U-71P2E5	U-100P2E5	U-125P2E5	U-140P2E5	
Power source			V	220/230/240	220/230/240	220/230/240	220/230/240	
Current	Cool (Hi / Med / Lo)	A	7,30/7,00/6,70	9,70/9,30/8,90	12,80/12,20/11,70	17,60/16,90/16,20	22,10/21,20/20,30	
	Heat (Hi / Med / Lo)	A	6,05/5,80/5,55	7,85/7,50/7,20	10,90/10,40/10,00	15,00/14,30/13,70	17,70/16,90/16,20	
Air volume	Cool / Heat	m ³ /min	40/45	50/45	76/70	86/78	89/83	
Sound pressure	Cool / Heat (Hi)	dB(A)	46/48	49/49	52/52	55/55	56/56	
Sound power	Cool / Heat (Hi)	dB	65/68	69/69	70/70	73/73	74/74	
Dimension	HxWxD	mm	695x875x320	695x875x320	996x980x370	996x980x370	996x980x370	
Net weight			44	44	90	94	94	
Piping connections	Liquid pipe	Inch (mm)	3/8(9,52)	3/8(9,52)	3/8(9,52)	3/8(9,52)	3/8(9,52)	
	Gas pipe	Inch (mm)	5/8(15,88)	5/8(15,88)	5/8(15,88)	5/8(15,88)	5/8(15,88)	
Pipe length range			3~40	3~40	5~50	5~50	5~50	
Elevation difference (in/out) ⁵⁾			30	30	30	30	30	
Pipe length for additional gas			30	30	30	30	30	
Additional gas amount			35	35	45	45	45	
Refrigerant (R32) / CO ₂ Eq.			1,45/0,979	1,45/0,979	2,60/1,755	2,98/2,0115	2,98/2,0115	
Operating range	Cool Min ~ Max	°C	-10~+43	-10~+43	-10~+43	-10~+43	-10~+43	
	Heat Min ~ Max	°C	-15~+24	-15~+24	-15~+24	-15~+24	-15~+24	

Accessories

CZ-RTC5B	Wired remote controller with Econavi function and datanavi
CZ-RWS3 + CZ-RWRT3	Infrared remote controller
CZ-RE2C2	Simplified remote controller
PAW-WTRAY	Tray for condenser water compatible with base ground support

Accessories

PAW-GRDBSE20	Outdoor base ground support for noise and vibration absorption
PAW-GRDSTD40	Outdoor elevation platform 400x900x400mm
CZ-CAPWFC1	NEW Commercial WLAN Adaptor

Technical focus

- Wide air distribution for large rooms
- Horizontal air flow reaches maximum 9,5m
- Fresh air connection available on the unit
- Slim design with 235mm height fits narrow space
- Silent operation
- Datanavi simple support tool App with remote controller (CZ-RTC5B)
- Twin, Triple and Double-twin split options
- Easy connection and control of external fan or ERV using the connector PAW-FDC on the indoor unit PCB. The external device can be controlled by the remote control of the Panasonic indoor unit

Air distribution is altered depending on the operational mode

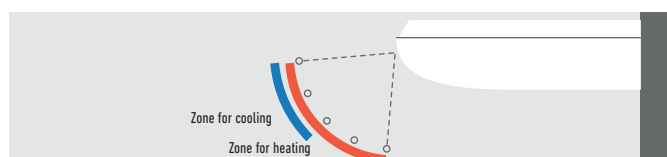

Further comfort improvement with airflow distribution

Horizontal air flow reaches maximum 9,5m. This is ideal for wide rooms. The wide air discharge opening expands the air flow to the left and the right. The unpleasant feeling caused when the air flow directly hits the human body is prevented by the "Draft prevention position", which changes the swing width, so that the degree of comfort is increased.

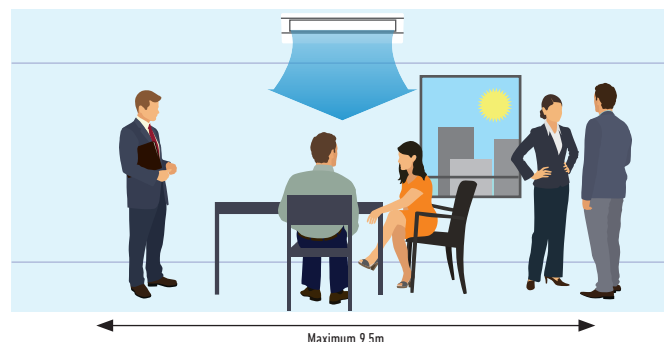

KIT	Three Phase			
	10,00kW KIT-100PT2Z8 CZ-RTC5B	12,50kW KIT-125PT2Z8 CZ-RTC5B	14,00kW KIT-140PT2Z8 CZ-RTC5B	
Remote controller				
Cooling capacity	Nominal (Min-Max) kW	10,00 (3,00 - 11,50)	12,50 (3,20 - 13,50)	14,00 (3,30 - 15,00)
EER ¹⁾	Nominal (Min-Max) W/W	3,64 (5,36 - 2,80)	3,32 (5,33 - 2,77)	2,98 (5,32 - 2,73)
SEER ²⁾		6,50 A++	5,75	5,48
Pdesign	kW	10,00	12,50	14,00
Input power cooling	Nominal (Min-Max) kW	2,75 (0,56 - 4,10)	3,76 (0,60 - 4,88)	4,70 (0,62 - 5,50)
Annual energy consumption ³⁾	kWh/a	538	1304	1534
Heating capacity	Nominal (Min-Max) kW	10,00 (3,00 - 14,00)	12,50 (3,30 - 15,00)	14,00 (3,40 - 16,00)
COP ¹⁾	Nominal (Min-Max) W/W	4,24 (5,36 - 3,50)	3,89 (4,52 - 3,41)	3,70 (5,48 - 3,08)
SCOP ²⁾		4,20 A+	3,75	3,70
Pdesign at -10°C	kW	10,00	12,50	13,60
Input power heating	Nominal (Min-Max) kW	2,36 (0,56 - 4,00)	3,21 (0,73 - 4,40)	3,78 (0,62 - 5,20)
Annual energy consumption ³⁾	kWh/a	3324	4669	5153
Indoor unit		S-100PT2E5B	S-125PT2E5B	S-140PT2E5B
Air volume	Hi / Med / Lo m ³ /min	30/25/23	34/28/24	35/29/25
Moisture removal volume	L/h	6,0	7,9	9,0
Sound pressure ⁴⁾	Hi / Med / Lo dB(A)	42/37/35	46/40/36	47/41/37
Sound power	Hi / Med / Lo dB	60/55/53	64/58/54	65/59/55
Dimension	HxWxD mm	235x1590x690	235x1590x690	235x1590x690
Net weight	kg	40	40	40
Outdoor unit		U-100P2Z8	U-125P2Z8	U-140P2Z8
Power source	V	380/400/415	380/400/415	380/400/415
Current	Cool (Hi / Med / Lo) A	4,37/4,15/4,00	5,90/5,60/5,40	7,40/7,05/6,80
	Heat (Hi / Med / Lo) A	3,72/3,55/3,40	5,00/4,75/4,60	5,90/5,60/5,40
Air volume	Cool / Heat m ³ /min	76/70	86/78	89/83
Sound pressure	Cool / Heat (Hi) dB(A)	52/52	55/55	56/56
Sound power	Cool / Heat (Hi) dB	70/70	73/73	74/74
Dimension	HxWxD mm	996x980x370	996x980x370	996x980x370
Net weight	kg	90	94	94
Piping connections	Liquid pipe Inch (mm)	3/8 (9,52)	3/8 (9,52)	3/8 (9,52)
	Gas pipe Inch (mm)	5/8 (15,88)	5/8 (15,88)	5/8 (15,88)
Pipe length range	m	5 - 50	5 - 50	5 - 50
Elevation difference (in/out) ⁵⁾	m	30	30	30
Pipe length for additional gas	m	30	30	30
Additional gas amount	g/m	45	45	45
Refrigerant (R32) / CO ₂ Eq.	kg / T	2,60 / 1,755	2,98 / 2,0115	2,98 / 2,0115
Operating range	Cool Min ~ Max °C	-10 ~ +43	-10 ~ +43	-10 ~ +43
	Heat Min ~ Max °C	-15 ~ +24	-15 ~ +24	-15 ~ +24

1) EER and COP calculation is based in accordance to EN14511. 2) For models below 12kW, the SEER and SCOP is calculated based on values of EU/626/2011. For models above 12kW, the SEER and SCOP is calculated based on values of EU/2281/2016. 3) The annual energy consumption is calculated in accordance to EU/626/2011. 4) The sound pressure of the units shows the value measured of the position 1m in front of the main body and 1m below the unit. The sound pressure is measured in accordance with Eurovent 6/C/006-97 specification. 5) When installing the outdoor unit at a higher position than the indoor unit. * Recommended fuse for the indoor 3A.



SEER and SCOP: For KIT-60PT2Z5. INTERNET CONTROL: Optional.

Compatible with all Panasonic connectivity solutions. For detailed information go to the Control Systems section.

PACi Elite High Static Pressure Hide Away Inverter+ • R32 GAS

The ducted systems are the ideal solution for flexible, concealed air conditioning and the optional 200mm spigots ensure simple, hassle-free connection to spiral ductwork.



CZ-RWS3 + CZ-RWRC3
Optional Controller.
Infrared remote controller.

CZ-RE2C2
Optional Controller.
Simplified remote controller.

CZ-CENSC1
Optional Econavi
Sensor.

			Single Phase							
			3,60kW	5,00kW	6,00kW	7,10kW	10,00kW	12,50kW	14,00kW	
KIT			KIT-36PF1ZH5	KIT-50PF1ZH5	KIT-60PF1ZH5	KIT-71PF1ZH5	KIT-100PF1ZH5	KIT-125PF1ZH5	KIT-140PF1ZH5	
Remote controller			CZ-RTC5B	CZ-RTC5B	CZ-RTC5B	CZ-RTC5B	CZ-RTC5B	CZ-RTC5B	CZ-RTC5B	
Cooling capacity	Nominal (Min - Max)	kW	3,60 (1,50 - 4,00)	5,00 (1,50 - 5,60)	6,00 (2,00 - 7,10)	7,10 (2,20 - 9,00)	10,00 (3,10 - 12,50)	12,50 (3,20 - 14,00)	14,00 (3,30 - 16,00)	
EER ¹⁾		W/W	4,74	4,03	3,68	3,84	4,13	3,52	3,26	
SEER²⁾			6,10 A++	5,90 A+	6,40 A++	6,50 A++	6,20 A++	5,88	5,73	
P _{design}		kW	3,60	5,00	6,00	7,10	10,00	12,50	14,00	
Input power cooling		kW	0,76	1,24	1,63	1,85	2,42	3,55	4,30	
Annual energy consumption ³⁾		kWh/a	207	297	328	382	564	—	—	
Heating capacity	Nominal (Min - Max)	kW	4,00 (1,50 - 5,00)	5,60 (1,50 - 6,50)	7,00 (1,80 - 8,00)	8,00 (2,00 - 9,00)	11,20 (3,10 - 14,00)	14,00 (3,20 - 16,00)	16,00 (3,30 - 18,00)	
COP ¹⁾		W/W	4,76	4,18	4,14	4,00	4,31	4,02	3,65	
SCOP²⁾			4,30 A+	4,20 A+	4,30 A+	4,60 A++	4,40 A+	4,26	4,18	
P _{design} at -10°C		kW	3,60	4,00	6,00	5,20	8,00	9,50	10,60	
Input power heating		kW	0,84	1,34	1,69	2,00	2,60	3,48	4,38	
Annual energy consumption ³⁾		kWh/a	1172	1500	1953	1582	2545	—	—	
Indoor unit			S-36PF1E5B	S-50PF1E5B	S-60PF1E5B	S-71PF1E5B	S-100PF1E5B	S-125PF1E5B	S-140PF1E5B	
External static pressure ⁴⁾	Nominal (Min - Max)	Pa	70 (10 - 150)	70 (10 - 150)	70 (10 - 150)	70 (10 - 150)	100 (10 - 150)	100 (10 - 150)	100 (10 - 150)	
Air volume	Hi / Med / Lo	m ³ /min	14,0 / 13,0 / 10,0	16,0 / 15,0 / 12,0	21,0 / 19,0 / 15,0	21,0 / 19,0 / 15,0	32,0 / 26,0 / 21,0	34,0 / 29,0 / 23,0	36,0 / 32,0 / 25,0	
Sound pressure ⁵⁾	Hi / Med / Lo	dB(A)	33 / 29 / 25	34 / 30 / 26	35 / 32 / 26	35 / 32 / 26	38 / 34 / 31	39 / 35 / 32	40 / 36 / 33	
Dimension	H x W x D	mm	290 x 800 x 700	290 x 800 x 700	290 x 1000 x 700	290 x 1000 x 700	290 x 1400 x 700	290 x 1400 x 700	290 x 1400 x 700	
Net weight	Indoor / Panel	kg	28	28	33	33	45	45	45	
Outdoor unit			U-36PZH2E5	U-50PZH2E5	U-60PZH2E5	U-71PZH2E5	U-100PZH2E5	U-125PZH2E5	U-140PZH2E5	
Power source		V	220 / 230 / 240	220 / 230 / 240	220 / 230 / 240	220 / 230 / 240	220 / 230 / 240	220 / 230 / 240	220 / 230 / 240	
Current	Cool (Hi / Med / Lo)	A	3,45 / 3,30 / 3,15	5,50 / 5,25 / 5,05	7,65 / 7,30 / 7,00	8,35 / 8,00 / 7,65	10,60 / 10,20 / 9,75	15,90 / 15,20 / 14,60	19,50 / 18,60 / 17,80	
	Heat (Hi / Med / Lo)	A	3,85 / 3,70 / 3,55	6,05 / 5,80 / 5,55	7,95 / 7,60 / 7,25	8,90 / 8,50 / 8,25	11,50 / 11,00 / 10,50	15,60 / 14,90 / 14,30	19,90 / 19,00 / 18,20	
Air volume	Cool / Heat	m ³ /min	40 / 40	40 / 45	40 / 45	61 / 60	118 / 108	125 / 122	129 / 116	
Sound pressure	Cool / Heat (Hi)	dB(A)	43 / 44	45 / 48	46 / 49	48 / 50	52 / 52	53 / 53	54 / 54	
Sound power	Cool / Heat (Hi)	dB	62 / 64	64 / 68	65 / 69	65 / 67	69 / 69	70 / 70	71 / 71	
Dimension	H x W x D	mm	695 x 875 x 320	695 x 875 x 320	695 x 875 x 320	996 x 940 x 340	1416 x 940 x 340	1416 x 940 x 340	1416 x 940 x 340	
Net weight		kg	43	43	44	68	99	99	99	
Piping connections	Liquid pipe	Inch (mm)	1/4 (6,35)	1/4 (6,35)	3/8 (9,52)	3/8 (9,52)	3/8 (9,52)	3/8 (9,52)	3/8 (9,52)	
	Gas pipe	Inch (mm)	1/2 (12,70)	1/2 (12,70)	5/8 (15,88)	5/8 (15,88)	5/8 (15,88)	5/8 (15,88)	5/8 (15,88)	
Pipe length range		m	3 ~ 40	3 ~ 40	3 ~ 40	5 ~ 50	5 ~ 85	5 ~ 85	5 ~ 85	
Elevation difference (in/out) ⁶⁾		m	30	30	30	30	30	30	30	
Pipe length for additional gas		m	30	30	30	30	30	30	30	
Additional gas amount		g/m	20	20	35	45	45	45	45	
Refrigerant (R32) / CO ₂ Eq.		kg / T	1,15 / 0,776	1,15 / 0,776	1,45 / 0,979	1,95 / 1,316	3,05 / 2,059	3,05 / 2,059	3,05 / 2,059	
Operating range	Cool Min ~ Max	°C	-15 ~ +46	-15 ~ +46	-15 ~ +46	-15 ~ +46	-15 ~ +46	-15 ~ +46	-15 ~ +46	
	Heat Min ~ Max	°C	-20 ~ +24	-20 ~ +24	-20 ~ +24	-20 ~ +24	-20 ~ +24	-20 ~ +24	-20 ~ +24	

Accessories

CZ-RTC5B	Wired remote controller with Econavi function and datanavi
CZ-RWS3 + CZ-RWRC3	Infrared remote controller
CZ-RE2C2	Simplified remote controller
PAW-WTRAY	Tray for condenser water compatible with base ground support
PAW-GRDBSE20	Outdoor base ground support for noise and vibration absorption

Accessories

PAW-GRDSTD40	Outdoor elevation platform 400 x 900 x 400mm
CZ-56DAF2	Air Outlet Plenum S...PF1E5B 36, 45 & 50
CZ-90DAF2	Air Outlet Plenum S...PF1E5B 60 & 71
CZ-160DAF2	Air Outlet Plenum S...PF1E5B 100, 125 & 140
CZ-DUMPA90MF2	Air Inlet Plenum S...PF1E5B 60 & 71
CZ-DUMPA160MF2	Air Inlet Plenum S...PF1E5B 100, 125 & 140
CZ-CAPWFC1	NEW Commercial WLAN Adaptor

Technical focus

- High ESP (external static pressure) up to 150 Pa
- Automatic learning function for the required static pressure on site during commissioning (a standard wired remote controller is required)
- DC FAN for better efficiency and control
- Built in drain pump
- Datanavi simple support tool App with remote controller (CZ-RTC5B)
- Twin split options
- Easy connection and control of external fan or ERV using the connector PAW-FDC on the indoor unit PCB. The external device can be controlled by the remote control of the Panasonic indoor unit

The static pressure outside the unit can be increased up to 150 Pa

Type		36	45	50	60	71	100	125	140
Standard	Pa	70	70	70	70	70	100	100	100
Maximum available setting	Pa	150	150	150	150	150	150	150	150

More powerful drain pump

Using a high-lift drain pump, drain piping can be elevated up to 785mm from the base of the unit.

Plenums

Air Outlet Plenum (without regulation adaptor)		
	Diameters	Model
36, 45 & 50	2xØ 200	CZ-56DAF2
60 & 71	3xØ 200	CZ-90DAF2
100, 125 & 140	4xØ 200	CZ-160DAF2

Air Inlet Plenum		
	Diameters	Model
60 & 71	3xØ 200	CZ-DUMPA90MF2
100, 125 & 140	4xØ 200	CZ-DUMPA160MF2

Standardized height of 290mm for all models. Height standardization enables easy and uniform installation for models with different capacities.

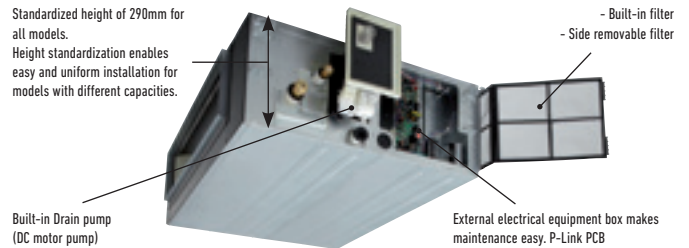

		Three Phase				
		7,10kW	10,00kW	12,50kW	14,00kW	
KIT		KIT-71PF1ZH8	KIT-100PF1ZH8	KIT-125PF1ZH8	KIT-140PF1ZH8	
Remote controller		CZ-RTC5B	CZ-RTC5B	CZ-RTC5B	CZ-RTC5B	
Cooling capacity	Nominal (Min - Max)	kW	7,10 (2,20 - 9,00)	10,00 (3,10 - 12,50)	12,50 (3,20 - 14,00)	14,00 (3,30 - 16,00)
EER ¹⁾		W/W	3,84	4,13	3,52	3,26
SEER ²⁾			6,40 A++	6,10 A++	5,87	5,72
Pdesign		kW	7,10	10,00	12,50	14,00
Input power cooling		kW	1,85	2,42	3,55	4,30
Annual energy consumption ³⁾		kWh/a	388	574	—	—
Heating capacity	Nominal (Min - Max)	kW	8,00 (2,00 - 9,00)	11,20 (3,10 - 14,00)	14,00 (3,20 - 16,00)	16,00 (3,30 - 18,00)
COP ¹⁾		W/W	4,00	4,31	4,02	3,65
SCOP ²⁾			4,60 A++	4,40 A+	4,26	4,18
Pdesign at -10°C		kW	5,20	8,00	9,50	10,60
Input power heating		kW	2,00	2,60	3,48	4,38
Annual energy consumption ³⁾		kWh/a	1582	2545	—	—
Indoor unit			S-71PF1E5B	S-100PF1E5B	S-125PF1E5B	S-140PF1E5B
External static pressure ⁴⁾	Nominal (Min - Max)	Pa	70 (10 - 150)	100 (10 - 150)	100 (10 - 150)	100 (10 - 150)
Air volume	Hi / Med / Lo	m ³ /min	21,0 / 19,0 / 15,0	32,0 / 26,0 / 21,0	34,0 / 29,0 / 23,0	36,0 / 32,0 / 25,0
Sound pressure ⁵⁾	Hi / Med / Lo	dB(A)	35 / 32 / 26	38 / 34 / 31	39 / 35 / 32	40 / 36 / 33
Dimension	HxWxD	mm	290 x 1000 x 700	290 x 1400 x 700	290 x 1400 x 700	290 x 1400 x 700
Net weight	Indoor / Panel	kg	33	45	45	45
Outdoor unit			U-71PZH2E8	U-100PZH2E8	U-125PZH2E8	U-140PZH2E8
Power source		V	380 / 400 / 415	380 / 400 / 415	380 / 400 / 415	380 / 400 / 415
Current	Cool (Hi / Med / Lo)	A	2,80 / 2,70 / 2,60	3,60 / 3,40 / 3,30	5,40 / 5,10 / 4,95	6,60 / 6,25 / 6,05
	Heat (Hi / Med / Lo)	A	3,00 / 2,90 / 2,80	3,90 / 3,70 / 3,55	5,30 / 5,00 / 4,85	6,70 / 6,40 / 6,15
Air volume	Cool / Heat	m ³ /min	61 / 60	118 / 108	125 / 112	129 / 116
Sound pressure	Cool / Heat (Hi)	dB(A)	48 / 50	52 / 52	53 / 53	54 / 54
Sound power	Cool / Heat (Hi)	dB	65 / 67	69 / 69	70 / 70	71 / 71
Dimension	HxWxD	mm	996 x 940 x 340	1416 x 940 x 340	1416 x 940 x 340	1416 x 940 x 340
Net weight		kg	68	99	99	99
Piping connections	Liquid pipe	Inch (mm)	3/8 (9,52)	3/8 (9,52)	3/8 (9,52)	3/8 (9,52)
	Gas pipe	Inch (mm)	5/8 (15,88)	5/8 (15,88)	5/8 (15,88)	5/8 (15,88)
Pipe length range		m	5 ~ 50	5 ~ 85	5 ~ 85	5 ~ 85
Elevation difference (in/out) ⁶⁾		m	30	30	30	30
Pipe length for additional gas		m	30	30	30	30
Additional gas amount		g/m	45	45	45	45
Refrigerant (R32) / CO ₂ Eq.		kg / T	1,95 / 1,316	3,05 / 2,059	3,05 / 2,059	3,05 / 2,059
Operating range	Cool Min ~ Max	°C	-15 ~ +46	-15 ~ +46	-15 ~ +46	-15 ~ +46
	Heat Min ~ Max	°C	-20 ~ +24	-20 ~ +24	-20 ~ +24	-20 ~ +24

1) EER and COP calculation is based in accordance to EN14511. 2) For models below 12kW, the SEER and SCOP is calculated based on values of EU/626/2011. For models above 12kW, the SEER and SCOP is calculated based on values of EU/2281/2016. 3) The annual energy consumption is calculated in accordance to EU/626/2011. 4) Medium External static pressure setting from factory. 5) The sound pressure of the units shows the value measured of the position 1,5 below the unit. The sound pressure is measured in accordance with Eurovent 6/C006-97 specification. 6) When installing the outdoor unit at a higher position than the indoor unit. * Recommended fuse for the indoor 3A.



SEER and SCOP: For KIT-71PF1ZH5. INTERNET CONTROL: Optional.

Compatible with all Panasonic connectivity solutions. For detailed information go to the Control Systems section.

PACi Standard High Static Pressure Hide Away Inverter+ • R32 GAS

The ducted systems are the ideal solution for flexible, concealed air conditioning and the optional 200mm spigots ensure simple, hassle-free connection to spiral ductwork.



CZ-RWS3 + CZ-RWRC3
Optional Controller.
Infrared remote controller.



CZ-RE2C2
Optional Controller.
Simplified remote controller.



CZ-CENSC1
Optional Econavi Sensor.

			Single Phase				
			6,00kW	7,10kW	10,00kW	12,50kW	14,00kW
KIT			KIT-60PF1Z5	KIT-71PF1Z5	KIT-100PF1Z5	KIT-125PF1Z5	KIT-140PF1Z5
Remote controller			CZ-RTC5B	CZ-RTC5B	CZ-RTC5B	CZ-RTC5B	CZ-RTC5B
Cooling capacity	Nominal (Min - Max)	kW	6,00 (2,00 ~ 7,10)	7,10 (2,00 ~ 7,70)	10,00 (3,00 ~ 11,50)	12,50 (3,20 ~ 13,50)	14,00 (3,30 ~ 15,00)
EER ¹⁾	Nominal (Min - Max)	W/W	3,51	3,23	3,66 (5,36 ~ 2,81)	3,52 (5,33 ~ 2,80)	3,18 (5,32 ~ 2,70)
SEER ²⁾			6,10 A++	6,10 A++	5,60 A+	5,56	5,38
P _{design}			6,00	7,10	10,00	12,50	14,00
Input power cooling	Nominal (Min - Max)	kW	1,71	2,20	2,73 (0,56 ~ 4,09)	3,55 (0,60 ~ 4,82)	4,40 (0,62 ~ 5,56)
Annual energy consumption ³⁾			344	407	625	787	911
Heating capacity	Nominal (Min - Max)	kW	6,00 (1,80 ~ 7,00)	7,10 (1,80 ~ 8,10)	10,00 (3,00 ~ 14,00)	12,50 (3,30 ~ 15,00)	14,00 (3,40 ~ 16,00)
COP ¹⁾	Nominal (Min - Max)	W/W	4,55	4,13	4,31 (5,36 ~ 3,51)	4,02 (5,50 ~ 3,45)	3,79 (5,48 ~ 3,13)
SCOP ²⁾			4,20 A+	4,30 A+	3,80 A	3,61	3,54
P _{design} at -10°C			6,00	6,00	10,00	12,50	13,60
Input power heating	Nominal (Min - Max)	kW	1,32	1,72	2,32 (0,56 ~ 3,99)	3,11 (0,60 ~ 4,35)	3,69 (0,62 ~ 5,12)
Annual energy consumption ³⁾			2000	1953	3684	4848	5379
Indoor unit			S-60PF1E5B	S-71PF1E5B	S-100PF1E5B	S-125PF1E5B	S-140PF1E5B
External static pressure ⁴⁾	Nominal (Min - Max)	Pa	70 (10 - 150)	70 (10 - 150)	100 (10 - 150)	100 (10 - 150)	100 (10 - 150)
Air volume	Hi / Med / Lo	m ³ /min	21,0 / 19,0 / 15,0	21,0 / 19,0 / 15,0	32,0 / 26,0 / 21,0	34,0 / 29,0 / 23,0	36,0 / 32,0 / 25,0
Moisture removal volume			3,4	4,2	6,0	7,9	9,0
Sound pressure ⁵⁾	Hi / Med / Lo	dB(A)	35 / 32 / 26	35 / 32 / 26	38 / 34 / 31	39 / 35 / 32	40 / 36 / 33
Sound power	Hi / Med / Lo	dB	57 / 54 / 48	57 / 54 / 48	60 / 56 / 53	61 / 57 / 54	62 / 58 / 55
Dimension	HxWxD	mm	290x1000x700	290x1000x700	290x1400x700	290x1400x700	290x1400x700
Net weight			33	33	45	45	45
Outdoor unit			U-60PZ2E5	U-71PZ2E5	U-100PZ2E5	U-125PZ2E5	U-140PZ2E5
Power source			220 / 230 / 240	220 / 230 / 240	220 / 230 / 240	220 / 230 / 240	220 / 230 / 240
Current	Cool (Hi / Med / Lo)	A	8,05 / 7,70 / 7,35	10,40 / 9,95 / 9,50	12,10 / 11,60 / 11,10	16,10 / 15,50 / 14,80	20,20 / 19,30 / 18,60
	Heat (Hi / Med / Lo)	A	6,05 / 5,80 / 5,55	8,10 / 7,75 / 7,40	10,10 / 9,70 / 9,30	14,00 / 13,40 / 12,90	16,80 / 16,00 / 15,30
Air volume	Cool / Heat	m ³ /min	40 / 45	50 / 45	76 / 70	86 / 78	89 / 83
Sound pressure	Cool / Heat (Hi)	dB(A)	46 / 48	49 / 49	52 / 52	55 / 55	56 / 56
Sound power	Cool / Heat (Hi)	dB	65 / 68	69 / 69	70 / 70	73 / 73	74 / 74
Dimension	HxWxD	mm	695x875x320	695x875x320	996x980x370	996x980x370	996x980x370
Net weight			44	44	90	94	94
Piping connections	Liquid pipe	Inch (mm)	3/8 (9,52)	3/8 (9,52)	3/8 (9,52)	3/8 (9,52)	3/8 (9,52)
	Gas pipe	Inch (mm)	5/8 (15,88)	5/8 (15,88)	5/8 (15,88)	5/8 (15,88)	5/8 (15,88)
Pipe length range			3 ~ 40	3 ~ 40	5 ~ 50	5 ~ 50	5 ~ 50
Elevation difference (in/out) ⁶⁾			30	30	30	30	30
Pipe length for additional gas			30	30	30	30	30
Additional gas amount			35	35	45	45	45
Refrigerant (R32) / CO ₂ Eq.			1,45 / 0,979	1,45 / 0,979	2,60 / 1,755	2,98 / 2,0115	2,98 / 2,0115
Operating range	Cool Min ~ Max	°C	-10 ~ +43	-10 ~ +43	-10 ~ +43	-10 ~ +43	-10 ~ +43
	Heat Min ~ Max	°C	-15 ~ +24	-15 ~ +24	-15 ~ +24	-15 ~ +24	-15 ~ +24

Accessories

CZ-RTC5B	Wired remote controller with Econavi function and datanavi
CZ-RWS3 + CZ-RWRC3	Infrared remote controller
CZ-RE2C2	Simplified remote controller
PAW-WTRAY	Tray for condenser water compatible with base ground support
PAW-GRDBSE20	Outdoor base ground support for noise and vibration absorption

Accessories

PAW-GRDSTD40	Outdoor elevation platform 400x900x400mm
CZ-90DAF2	Air Outlet Plenum S . .PF1E5B 60 & 71
CZ-160DAF2	Air Outlet Plenum S . .PF1E5B 100, 125 & 140
CZ-DUMPA90MF2	Air Inlet Plenum S . .PF1E5B 60 & 71
CZ-DUMPA160MF2	Air Inlet Plenum S . .PF1E5B 100, 125 & 140
CZ-CAPWFC1	NEW Commercial WLAN Adaptor

Technical focus

- High ESP (external static pressure) up to 150 Pa
- Automatic learning function for the required static pressure on site during commissioning (a standard wired remote controller is required)
- DC FAN for better efficiency and control
- Built in drain pump
- Datanavi simple support tool App with remote controller (CZ-RTC5B)
- Twin split options
- Easy connection and control of external fan or ERV using the connector PAW-FDC on the indoor unit PCB. The external device can be controlled by the remote control of the Panasonic indoor unit

The static pressure outside the unit can be increased up to 150 Pa

Type		60	71	100	125	140
Standard	Pa	70	70	100	100	100
Maximum available setting	Pa	150	150	150	150	150

More powerful drain pump

Using a high-lift drain pump, drain piping can be elevated up to 785mm from the base of the unit.

Plenums

Air Outlet Plenum (without regulation adaptor)		
	Diameters	Model
60 & 71	3xØ 200	CZ-90DAF2
100, 125 & 140	4xØ 200	CZ-160DAF2

Air Inlet Plenum		
	Diameters	Model
60 & 71	3xØ 200	CZ-DUMPA90MF2
100, 125 & 140	4xØ 200	CZ-DUMPA160MF2

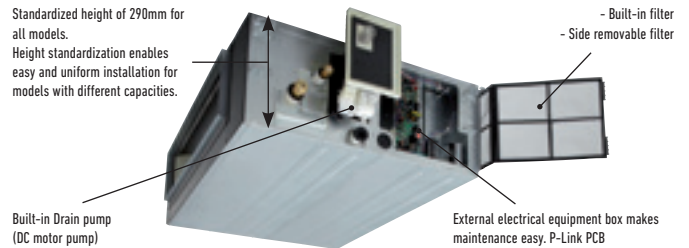

KIT	Three Phase			
	10,00kW	12,50kW	14,00kW	
Remote controller	KIT-100PF1Z8	KIT-125PF1Z8	KIT-140PF1Z8	
	CZ-RTC5B	CZ-RTC5B	CZ-RTC5B	
Cooling capacity	Nominal (Min - Max) kW	10,00 (3,00 - 11,50)	12,50 (3,20 - 13,50)	14,00 (3,30 - 15,00)
EER ¹⁾	Nominal (Min - Max) W/W	3,66 (5,36 - 2,81)	3,52 (5,33 - 2,80)	3,18 (5,32 - 2,70)
SEER ²⁾		5,60 A+	5,54	5,37
Pdesign	kW	10,00	12,50	14,00
Input power cooling	Nominal (Min - Max) kW	2,73 (0,56 - 4,09)	3,55 (0,60 - 4,82)	4,40 (0,62 - 5,56)
Annual energy consumption ³⁾	kWh/a	625	790	912
Heating capacity	Nominal (Min - Max) kW	10,00 (3,00 - 14,00)	12,50 (3,30 - 15,00)	14,00 (3,40 - 16,00)
COP ¹⁾	Nominal (Min - Max) W/W	4,31 (5,36 - 3,51)	4,02 (5,50 - 3,45)	3,79 (5,48 - 3,13)
SCOP ²⁾		3,80 A	3,61	3,54
Pdesign at -10°C	kW	10,00	12,50	13,60
Input power heating	Nominal (Min - Max) kW	2,32 (0,56 - 3,99)	3,11 (0,60 - 4,35)	3,69 (0,62 - 5,12)
Annual energy consumption ³⁾	kWh/a	3684	4848	5379
Indoor unit		S-100PF1E5B	S-125PF1E5B	S-140PF1E5B
External static pressure ⁴⁾	Nominal (Min - Max) Pa	100 (10 - 150)	100 (10 - 150)	100 (10 - 150)
Air volume	Hi / Med / Lo m ³ /min	32,0 / 26,0 / 21,0	34,0 / 29,0 / 23,0	36,0 / 32,0 / 25,0
Moisture removal volume	L/h	6,0	7,9	9,0
Sound pressure ⁵⁾	Hi / Med / Lo dB(A)	38 / 34 / 31	39 / 35 / 32	40 / 36 / 33
Sound power	Hi / Med / Lo dB	60 / 56 / 53	61 / 57 / 54	62 / 58 / 55
Dimension	HxWxD mm	290 x 1400 x 700	290 x 1400 x 700	290 x 1400 x 700
Net weight	kg	45	45	45
Outdoor unit		U-100PZ2E8	U-125PZ2E8	U-140PZ2E8
Power source	V	380 / 400 / 415	380 / 400 / 415	380 / 400 / 415
Current	Cool (Hi / Med / Lo) A	4,15 / 3,95 / 3,80	5,40 / 5,10 / 4,95	6,75 / 6,40 / 6,15
	Heat (Hi / Med / Lo) A	3,45 / 3,30 / 3,20	4,70 / 4,45 / 4,30	5,60 / 5,30 / 5,15
Air volume	Cool / Heat m ³ /min	76 / 70	86 / 78	89 / 83
Sound pressure	Cool / Heat (Hi) dB(A)	52 / 52	55 / 55	56 / 56
Sound power	Cool / Heat (Hi) dB	70 / 70	73 / 73	74 / 74
Dimension	HxWxD mm	996 x 980 x 370	996 x 980 x 370	996 x 980 x 370
Net weight	kg	90	94	94
Piping connections	Liquid pipe Inch (mm)	3/8 (9,52)	3/8 (9,52)	3/8 (9,52)
	Gas pipe Inch (mm)	5/8 (15,88)	5/8 (15,88)	5/8 (15,88)
Pipe length range	m	5 - 50	5 - 50	5 - 50
Elevation difference (in/out) ⁶⁾	m	30	30	30
Pipe length for additional gas	m	30	30	30
Additional gas amount	g/m	45	45	45
Refrigerant (R32) / CO ₂ Eq.	kg / T	2,60 / 1,755	2,98 / 2,0115	2,98 / 2,0115
Operating range	Cool Min ~ Max °C	-10 ~ +43	-10 ~ +43	-10 ~ +43
	Heat Min ~ Max °C	-15 ~ +24	-15 ~ +24	-15 ~ +24

1) EER and COP calculation is based in accordance to EN14511. 2) For models below 12kW, the SEER and SCOP is calculated based on values of EU/626/2011. For models above 12kW, the SEER and SCOP is calculated based on values of EU/2281/2016. 3) The annual energy consumption is calculated in accordance to EU/626/2011. 4) Medium External static pressure setting from factory. 5) The sound pressure of the units shows the value measured of the position 1,5 below the unit. The sound pressure is measured in accordance with Eurovent 6/C/006-97 specification. 6) When installing the outdoor unit at a higher position than the indoor unit. * Recommended fuse for the indoor 3A.



SEER and SCOP: For KIT-71PF1Z5. INTERNET CONTROL: Optional.

Compatible with all Panasonic connectivity solutions. For detailed information go to the Control Systems section.

PACi Elite Low Static Pressure Hide Away Inverter+ • R32 GAS

The depth of only 250mm provides greater installation flexibility and the unit can be used in more applications. Ideal for sites with narrow ceiling voids.

Ultra-slim profile: 250mm height for all models.

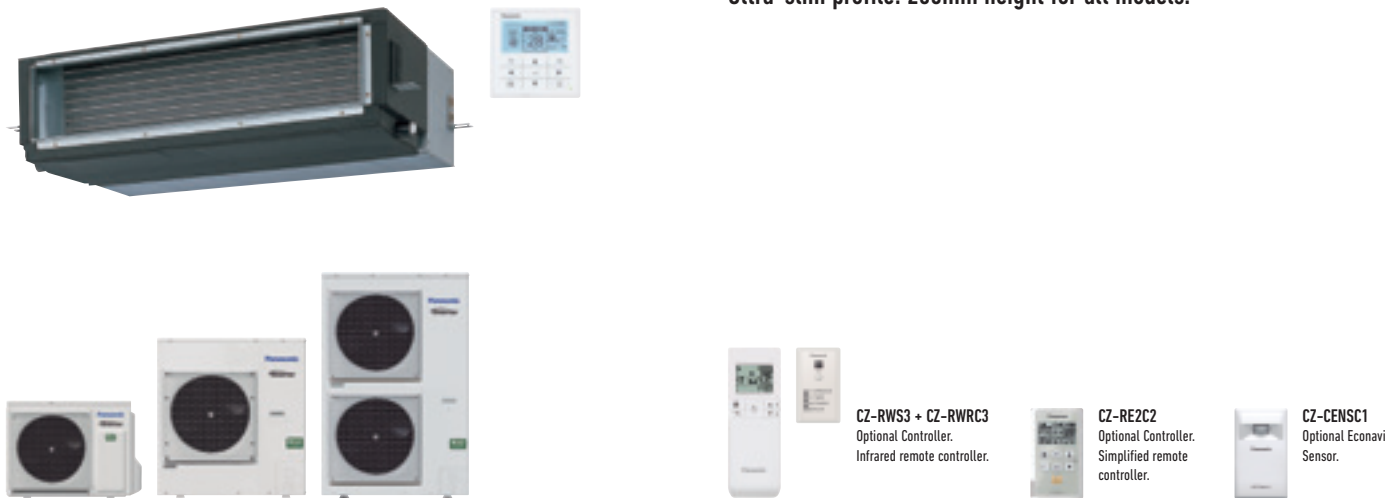

			Single Phase							
			3,60kW	5,00kW	6,00kW	7,10kW	10,00kW	12,50kW	14,00kW	
KIT			KIT-36PN1ZH5	KIT-50PN1ZH5	KIT-60PN1ZH5	KIT-71PN1ZH5	KIT-100PN1ZH5	KIT-125PN1ZH5	KIT-140PN1ZH5	
Remote controller			CZ-RTC5B	CZ-RTC5B	CZ-RTC5B	CZ-RTC5B	CZ-RTC5B	CZ-RTC5B	CZ-RTC5B	
Cooling capacity	Nominal (Min - Max)	kW	3,60 (1,50 - 4,00)	5,00 (1,50 - 5,60)	6,00 (2,00 - 7,10)	7,10 (2,00 - 9,00)	10,00 (3,10 - 12,50)	12,50 (3,20 - 14,00)	14,00 (3,30 - 16,00)	
EER ¹⁾		W/W	3,85	3,40	3,41	3,40	3,95	3,35	3,15	
SEER ²⁾			5,10 A+	5,10 A+	6,00 A+	6,00 A+	6,00 A+	5,95	5,84	
P _{design}		kW	3,60	5,00	6,00	7,10	10,00	12,50	14,00	
Input power cooling		kW	0,93	1,47	1,76	2,09	2,53	3,73	4,45	
Annual energy consumption ³⁾		kWh/a	246	342	350	414	582	—	—	
Heating capacity	Nominal (Min - Max)	kW	4,00 (1,50 - 5,00)	5,60 (1,50 - 6,50)	7,00 (1,80 - 7,00)	8,00 (2,00 - 9,00)	11,20 (3,10 - 14,00)	14,00 (3,30 - 16,00)	16,00 (3,30 - 18,00)	
COP ¹⁾		W/W	4,40	3,50	3,80	3,90	4,00	3,70	3,50	
SCOP ²⁾			4,00 A+	4,00 A+	4,00 A+	4,00 A+	4,00 A+	3,91	3,80	
P _{design} at -10°C		kW	3,60	3,80	5,60	5,20	8,00	9,50	10,60	
Input power heating		kW	0,91	1,60	1,84	2,05	2,80	3,78	4,45	
Annual energy consumption ³⁾		kWh/a	1258	1573	2095	1914	2799	—	—	
Indoor unit			S-36PN1E5B	S-50PN1E5B	S-60PN1E5B	S-71PN1E5B	S-100PN1E5B	S-125PN1E5B	S-140PN1E5B	
External static pressure ⁴⁾	Nominal (Min - Max)	Pa	25 (10 - 80)	25 (10 - 80)	25 (10 - 80)	25 (10 - 80)	40 (10 - 80)	50 (10 - 80)	50 (10 - 80)	
Air volume	Hi / Med / Lo	m ³ /min	14,0 / 12,0 / 10,0	16,0 / 13,0 / 10,0	22,0 / 20,0 / 16,0	22,0 / 20,0 / 16,0	36,0 / 33,0 / 26,0	38,0 / 35,0 / 28,0	40,0 / 37,0 / 30,0	
Sound pressure ⁵⁾	Hi / Med / Lo	dB(A)	35 / 33 / 30	36 / 34 / 30	38 / 36 / 31	38 / 36 / 31	39 / 37 / 32	40 / 38 / 33	41 / 39 / 34	
Dimension	H x W x D	mm	250 x 780 x 650	250 x 780 x 650	250 x 1000 x 650	250 x 1000 x 650	250 x 1200 x 650	250 x 1200 x 650	250 x 1200 x 650	
Net weight	Indoor / Panel	kg	29	29	32	32	41	41	41	
Outdoor unit			U-36PZH2E5	U-50PZH2E5	U-60PZH2E5	U-71PZH2E5	U-100PZH2E5	U-125PZH2E5	U-140PZH2E5	
Power source		V	220 / 230 / 240	220 / 230 / 240	220 / 230 / 240	220 / 230 / 240	220 / 230 / 240	220 / 230 / 240	220 / 230 / 240	
Current	Cool	A	4,20 / 4,00 / 3,85	6,50 / 6,20 / 5,95	8,20 / 7,85 / 7,50	9,45 / 9,00 / 8,60	11,20 / 10,70 / 10,20	16,90 / 16,10 / 15,40	20,00 / 19,30 / 18,40	
	Heat	A	4,10 / 3,90 / 3,75	7,15 / 6,85 / 6,55	8,60 / 8,25 / 7,85	9,20 / 8,85 / 8,45	2,40 / 11,90 / 11,40	17,00 / 16,20 / 15,60	20,20 / 19,30 / 18,50	
Air volume	Cool / Heat	m ³ /min	40 / 40	40 / 45	40 / 45	61 / 60	118 / 108	125 / 122	129 / 116	
Sound pressure	Cool / Heat (Hi)	dB(A)	43 / 44	45 / 48	46 / 49	48 / 50	52 / 52	53 / 53	54 / 54	
Sound power	Cool / Heat (Hi)	dB	62 / 64	64 / 68	65 / 69	65 / 67	69 / 69	70 / 70	71 / 71	
Dimension	H x W x D	mm	695 x 875 x 320	695 x 875 x 320	695 x 875 x 320	996 x 940 x 340	1416 x 940 x 340	1416 x 940 x 340	1416 x 940 x 340	
Net weight		kg	43	43	44	68	99	99	99	
Piping connections	Liquid pipe	Inch (mm)	1/4 (6,35)	1/4 (6,35)	3/8 (9,52)	3/8 (9,52)	3/8 (9,52)	3/8 (9,52)	3/8 (9,52)	
	Gas pipe	Inch (mm)	1/2 (12,70)	1/2 (12,70)	5/8 (15,88)	5/8 (15,88)	5/8 (15,88)	5/8 (15,88)	5/8 (15,88)	
Pipe length range		m	3 ~ 40	3 ~ 40	3 ~ 40	5 ~ 50	5 ~ 85	5 ~ 85	5 ~ 85	
Elevation difference (in/out) ⁶⁾		m	30	30	30	30	30	30	30	
Pipe length for additional gas		m	30	30	30	30	30	30	30	
Additional gas amount		g/m	20	20	35	45	45	45	45	
Refrigerant (R32) / CO ₂ Eq.		kg / T	1,15 / 0,776	1,15 / 0,776	1,45 / 0,979	1,95 / 1,316	3,05 / 2,059	3,05 / 2,059	3,05 / 2,059	
Operating range	Cool Min ~ Max	°C	-15 ~ +46	-15 ~ +46	-15 ~ +46	-15 ~ +46	-15 ~ +46	-15 ~ +46	-15 ~ +46	
	Heat Min ~ Max	°C	-20 ~ +24	-20 ~ +24	-20 ~ +24	-20 ~ +24	-20 ~ +24	-20 ~ +24	-20 ~ +24	

Accessories

CZ-RTC5B	Wired remote controller with Econavi function and datanavi
CZ-RWS3 + CZ-RWRC3	Infrared remote controller
CZ-RE2C2	Simplified remote controller
PAW-WTRAY	Tray for condenser water compatible with base ground support

Accessories

PAW-GRDBSE20	Outdoor base ground support for noise and vibration absorption
PAW-GRDSTD40	Outdoor elevation platform 400 x 900 x 400mm
CZ-CAPWFC1	NEW Commercial WLAN Adaptor

Technical focus

- Automatic learning function for the required static pressure on site during commissioning (a standard wired remote controller is required. S-60/71/100/125/140PN1E5B models only)
- Compact indoor units without losing static pressure (only 250mm high)
- 50 Pa static pressure
- Easy maintenance and service via external electrical box
- 3 speed centrifugal fan through wired or Infrared remote controller
- DC FAN for better efficiency and control
- Easy connection and control of external fan or ERV using the connector PAW-FDC on the indoor unit PCB. The external device can be controlled by the remote control of the Panasonic indoor unit

System Example

An inspection port (450mmx450mm or more) is required at the control-box side of the indoor unit body.

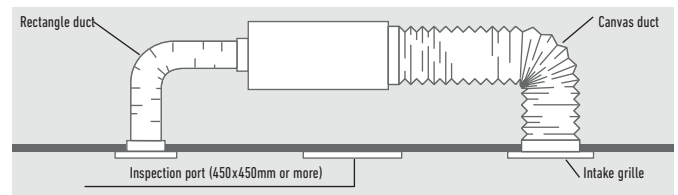

Cold Drafts Reduction at Heating

Accurate DX Coil temperature measurement by E1 and E2 sensor to reduce cold drafts at heating and increasing efficiency and comfort.

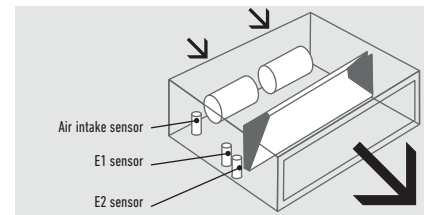

Before spec-in, please consult with an authorized Panasonic dealer.

			Three Phase			
			7,10kW	10,00kW	12,50kW	14,00kW
KIT			KIT-71PN1ZH8	KIT-100PN1ZH8	KIT-125PN1ZH8	KIT-140PN1ZH8
Remote controller			CZ-RTC5B	CZ-RTC5B	CZ-RTC5B	CZ-RTC5B
Cooling capacity	Nominal (Min - Max)	kW	7,10 (2,20 - 9,00)	10,00 (3,10 - 12,50)	12,50 (3,20 - 14,00)	14,00 (3,30 - 16,00)
EER ¹⁾		W/W	3,40	3,95	3,35	3,15
SEER ²⁾			5,90 A+	5,90 A+	5,93	5,82
Pdesign		kW	7,10	10,00	12,50	14,00
Input power cooling		kW	2,09	2,53	3,73	4,45
Annual energy consumption ³⁾		kWh/a	418	588	—	—
Heating capacity	Nominal (Min - Max)	kW	8,00 (2,00 - 9,00)	11,20 (3,10 - 14,00)	14,00 (3,30 - 16,00)	16,00 (3,30 - 18,00)
COP ¹⁾		W/W	3,90	4,00	3,70	3,60
SCOP ²⁾			4,00 A+	4,00 A+	3,91	3,80
Pdesign at -10°C		kW	5,20	8,00	9,50	10,60
Input power heating		kW	2,05	2,80	3,78	4,45
Annual energy consumption ³⁾		kWh/a	1914	2799	—	—
Indoor unit			S-71PN1E5B	S-100PN1E5B	S-125PN1E5B	S-140PN1E5B
External static pressure ⁴⁾	Nominal (Min - Max)	Pa	25 (10 - 80)	40 (10 - 80)	50 (10 - 80)	50 (10 - 80)
Air volume	Hi / Med / Lo	m ³ /min	22,0 / 20,0 / 16,0	36,0 / 33,0 / 26,0	38,0 / 35,0 / 28,0	46,0 / 37,0 / 30,0
Sound pressure ⁵⁾	Hi / Med / Lo	dB(A)	38 / 36 / 31	39 / 37 / 32	40 / 38 / 33	41 / 39 / 34
Dimension	HxWxD	mm	250 x 1000 x 650	250 x 1200 x 650	250 x 1200 x 650	250 x 1200 x 650
Net weight	Indoor / Panel	kg	32	41	41	41
Outdoor unit			U-71PZH2E8	U-100PZH2E8	U-125PZH2E8	U-140PZH2E8
Power source		V	380 / 400 / 415	380 / 400 / 415	380 / 400 / 415	380 / 400 / 415
Current	Cool	A	3,20 / 3,05 / 2,95	3,75 / 3,55 / 3,45	5,65 / 5,40 / 5,20	11,70 / 11,20 / 10,70
	Heat	A	3,20 / 2,95 / 2,85	4,20 / 4,00 / 3,85	5,75 / 5,45 / 5,25	6,80 / 6,45 / 6,20
Air volume	Cool / Heat	m ³ /min	61 / 60	118 / 108	125 / 112	129 / 116
Sound pressure	Cool / Heat (Hi)	dB(A)	48 / 50	52 / 52	53 / 53	54 / 54
Sound power	Cool / Heat (Hi)	dB	65 / 67	69 / 69	70 / 70	71 / 71
Dimension	HxWxD	mm	996 x 940 x 340	1416 x 940 x 340	1416 x 940 x 340	1416 x 940 x 340
Net weight		kg	68	99	99	99
Piping connections	Liquid pipe	Inch (mm)	3/8 (9,52)	3/8 (9,52)	3/8 (9,52)	3/8 (9,52)
	Gas pipe	Inch (mm)	5/8 (15,88)	5/8 (15,88)	5/8 (15,88)	5/8 (15,88)
Pipe length range		m	5 ~ 50	5 ~ 85	5 ~ 85	5 ~ 85
Elevation difference (in/out) ⁶⁾		m	30	30	30	30
Pipe length for additional gas		m	30	30	30	30
Additional gas amount		g/m	45	45	45	45
Refrigerant (R32) / CO ₂ Eq.		kg / T	1,95 / 1,316	3,05 / 2,059	3,05 / 2,059	3,05 / 2,059
Operating range	Cool Min ~ Max	°C	-15 ~ +46	-15 ~ +46	-15 ~ +46	-15 ~ +46
	Heat Min ~ Max	°C	-20 ~ +24	-20 ~ +24	-20 ~ +24	-20 ~ +24

1) EER and COP calculation is based in accordance to EN14511. 2) For models below 12kW, the SEER and SCOP is calculated based on values of EU/626/2011. For models above 12kW, the SEER and SCOP is calculated based on values of EU/2281/2016. 3) The annual energy consumption is calculated in accordance to EU/626/2011. 4) Medium external static pressure setting from factory. 5) The sound pressure of the units shows the value measured of the position 1,5 below the unit. The sound pressure is measured in accordance with Eurovent 6/C006-97 specification. 6) When installing the outdoor unit at a higher position than the indoor unit. * Recommended fuse for the indoor 3A.



SEER and SCOP: KIT-60PN1ZH5, KIT-71PN1ZH5 and KIT-100PN1ZH5. INTERNET CONTROL: Optional.
Compatible with all Panasonic connectivity solutions. For detailed information go to the Control Systems section.

PACi Standard Low Static Pressure Hide Away Inverter+ • R32 GAS

The depth of only 250mm provides greater installation flexibility and the unit can be used in more applications. Ideal for sites with narrow ceiling voids.

Ultra-slim profile: 250mm height for all models.



CZ-RWS3 + CZ-RWRC3
Optional Controller.
Infrared remote controller.



CZ-RE2C2
Optional Controller.
Simplified remote controller.



CZ-CENSC1
Optional Econavi
Sensor.

			Single Phase						
			6,00kW	7,10kW	10,00kW	12,50kW	14,00kW		
KIT			KIT-60PN1Z5	KIT-71PN1Z5	KIT-100PN1Z5	KIT-125PN1Z5	KIT-140PN1Z5		
Remote controller			CZ-RTC5B	CZ-RTC5B	CZ-RTC5B	CZ-RTC5B	CZ-RTC5B		
Cooling capacity	Nominal (Min-Max)	kW	6,00(2,00~7,10)	7,10(2,00~7,70)	10,00(3,00~11,50)	12,50(3,20~13,50)	14,00(3,30~15,00)		
EER ¹⁾		W/W	3,31	3,11	3,30	3,20	3,00		
SEER²⁾			5,80 A+	5,80 A+	5,40 A	5,13	5,02		
P _{design}		kW	6,00	7,10	10,00	12,50	14,00		
Input power cooling		kW	1,81	2,28	3,03	3,90	4,65		
Annual energy consumption ³⁾		kWh/a	361	428	641	—	—		
Heating capacity	Nominal (Min-Max)	kW	6,00(1,80~7,00)	7,10(1,80~8,10)	10,00(3,00~14,00)	12,50(3,30~15,00)	14,00(3,40~16,00)		
COP ¹⁾		W/W	3,90	3,72	3,91	3,60	3,55		
SCOP²⁾			4,00 A+	4,00 A+	3,90 A	3,60	3,51		
P _{design} at -10°C		kW	5,60	5,60	7,60	12,50	14,00		
Input power heating		kW	1,54	1,90	2,56	3,46	3,94		
Annual energy consumption ³⁾		kWh/a	2095	2100	3589	—	—		
Indoor unit			S-60PN1E5B	S-71PN1E5B	S-100PN1E5B	S-125PN1E5B	S-140PN1E5B		
External static pressure ⁴⁾	Nominal (Min - Max)	Pa	25(10 - 80)	25(10 - 80)	40(10 - 80)	50(10 - 80)	50(10 - 80)		
Air volume	Hi / Med / Lo	m ³ /min	22,0 / 20,0 / 16,0	22,0 / 20,0 / 16,0	36,0 / 33,0 / 26,0	38,0 / 35,0 / 28,0	40,0 / 37,0 / 30,0		
Sound pressure ⁵⁾	Hi / Med / Lo	dB(A)	38 / 36 / 31	38 / 36 / 31	39 / 37 / 32	40 / 38 / 33	41 / 39 / 34		
Dimension	HxWxD	mm	250x1000x650	250x1000x650	250x1200x650	250x1200x650	250x1200x650		
Net weight		kg	32	32	41	41	41		
Outdoor unit			U-60PZ2E5	U-71PZ2E5	U-100PZ2E5	U-125PZ2E5	U-140PZ2E5		
Power source		V	220 / 230 / 240	220 / 230 / 240	220 / 230 / 240	220 / 230 / 240	220 / 230 / 240		
Current	Cool	A	8,30 / 8,00 / 7,60	10,60 / 10,10 / 9,60	14,00 / 13,30 / 12,80	17,90 / 17,10 / 16,50	21,50 / 20,50 / 19,60		
	Heat	A	7,00 / 6,70 / 6,40	8,80 / 8,40 / 8,00	11,60 / 11,10 / 10,70	15,80 / 15,10 / 14,50	18,00 / 17,30 / 16,50		
Air volume	Cool / Heat	m ³ /min	40 / 45	50 / 45	76 / 70	86 / 78	89 / 83		
Sound pressure	Cool / Heat (Hi)	dB(A)	46 / 48	49 / 49	52 / 52	55 / 55	56 / 56		
Sound power	Cool / Heat (Hi)	dB	65 / 68	69 / 69	70 / 70	73 / 73	74 / 74		
Dimension	HxWxD	mm	695x875x320	695x875x320	996x980x370	996x980x370	996x980x370		
Net weight		kg	44	44	90	94	94		
Piping connections	Liquid pipe	Inch (mm)	3/8(9,52)	3/8(9,52)	3/8(9,52)	3/8(9,52)	3/8(9,52)		
	Gas pipe	Inch (mm)	5/8(15,88)	5/8(15,88)	5/8(15,88)	5/8(15,88)	5/8(15,88)		
Pipe length range		m	3~40	3~40	5~50	5~50	5~50		
Elevation difference (in/out) ⁶⁾		m	30	30	30	30	30		
Pipe length for additional gas		m	30	30	30	30	30		
Additional gas amount		g/m	35	35	45	45	45		
Refrigerant (R32) / CO ₂ Eq.		kg / T	1,45 / 0,979	1,45 / 0,979	2,60 / 1,755	2,98 / 2,0115	2,98 / 2,0115		
Operating range	Cool Min ~ Max	°C	-10 ~ +43	-10 ~ +43	-10 ~ +43	-10 ~ +43	-10 ~ +43		
	Heat Min ~ Max	°C	-15 ~ +24	-15 ~ +24	-15 ~ +24	-15 ~ +24	-15 ~ +24		

Accessories

CZ-RTC5B	Wired remote controller with Econavi function and datanavi
CZ-RWS3 + CZ-RWRC3	Infrared remote controller
CZ-RE2C2	Simplified remote controller
PAW-WTRAY	Tray for condenser water compatible with base ground support

Accessories

PAW-GRDBSE20	Outdoor base ground support for noise and vibration absorption
PAW-GRDSTD40	Outdoor elevation platform 400x900x400mm
CZ-CAPWFC1	NEW Commercial WLAN Adaptor

Technical focus

- Automatic learning function for the required static pressure on site during commissioning (a standard wired remote controller is required. S-60/71/100/125/140PN1E5B models only)
- Compact indoor units without losing static pressure (only 250mm high)
- 50 Pa static pressure
- Easy maintenance and service via external electrical box
- 3 speed centrifugal fan through wired or Infrared remote controller
- DC FAN for better efficiency and control
- Easy connection and control of external fan or ERV using the connector PAW-FDC on the indoor unit PCB. The external device can be controlled by the remote control of the Panasonic indoor unit

System Example

An inspection port (450mmx450mm or more) is required at the control-box side of the indoor unit body.

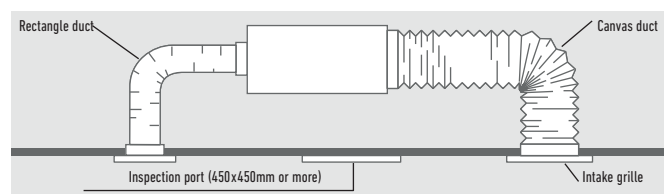

Cold Drafts Reduction at Heating

Accurate DX Coil temperature measurement by E1 and E2 sensor to reduce cold drafts at heating and increasing efficiency and comfort.

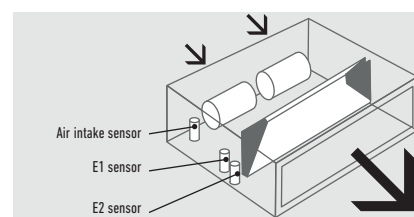

Before spec-in, please consult with an authorized Panasonic dealer.

KIT	Three Phase				
	10,00kW KIT-100PN1Z8 CZ-RTC5B	12,50kW KIT-125PN1Z8 CZ-RTC5B	14,00kW KIT-140PN1Z8 CZ-RTC5B		
Remote controller					
Cooling capacity	Nominal (Min - Max)	kW	10,00 (3,00 - 11,50)	12,50 (3,20 - 13,50)	14,00 (3,30 - 15,00)
EER ¹⁾		W/W	3,30	3,21	3,01
SEER ²⁾			5,40 A	5,11	5,01
Pdesign		kW	10,00	12,50	14,00
Input power cooling		kW	3,03	3,90	4,65
Annual energy consumption ³⁾		kWh/a	648	—	—
Heating capacity	Nominal (Min - Max)	kW	10,00 (3,00 - 14,00)	12,50 (3,30 - 15,00)	14,00 (3,40 - 16,00)
COP ¹⁾		W/W	3,91	3,61	3,55
SCOP ²⁾			3,90 A	3,60	3,51
Pdesign at -10°C		kW	7,60	12,50	14,00
Input power heating		kW	2,56	3,46	3,94
Annual energy consumption ³⁾		kWh/a	3589	—	—
Indoor unit			S-100PN1E5B	S-125PN1E5B	S-140PN1E5B
External static pressure ⁴⁾	Nominal (Min - Max)	Pa	40(10 - 80)	50(10 - 80)	50(10 - 80)
Air volume	Hi / Med / Lo	m ³ /min	36,0 / 33,0 / 26,0	38,0 / 35,0 / 28,0	40,0 / 37,0 / 30,0
Sound pressure ⁵⁾	Hi / Med / Lo	dB(A)	39 / 37 / 32	40 / 38 / 33	41 / 39 / 34
Dimension	HxWxD	mm	250 x 1200 x 650	250 x 1200 x 650	250 x 1200 x 650
Net weight		kg	41	41	41
Outdoor unit			U-100PZ2E8	U-125PZ2E8	U-140PZ2E8
Power source		V	380 / 400 / 415	380 / 400 / 415	380 / 400 / 415
Current	Cool	A	4,70 / 4,50 / 4,30	6,00 / 5,70 / 5,50	7,20 / 6,80 / 6,60
	Heat	A	3,90 / 3,70 / 3,60	5,30 / 5,00 / 4,90	6,00 / 5,70 / 5,50
Air volume	Cool / Heat	m ³ /min	76 / 70	86 / 78	89 / 83
Sound pressure	Cool / Heat (Hi)	dB(A)	52 / 52	55 / 55	56 / 56
Sound power	Cool / Heat (Hi)	dB	70 / 70	73 / 73	74 / 74
Dimension	HxWxD	mm	996 x 980 x 370	996 x 980 x 370	996 x 980 x 370
Net weight		kg	90	94	94
Piping connections	Liquid pipe	Inch (mm)	3/8 (9,52)	3/8 (9,52)	3/8 (9,52)
	Gas pipe	Inch (mm)	5/8 (15,88)	5/8 (15,88)	5/8 (15,88)
Pipe length range		m	5 - 50	5 - 50	5 - 50
Elevation difference (in/out) ⁶⁾		m	30	30	30
Pipe length for additional gas		m	30	30	30
Additional gas amount		g/m	45	45	45
Refrigerant (R32) / CO ₂ Eq.		kg / T	2,60 / 1,755	2,98 / 2,0115	2,98 / 2,0115
Operating range	Cool Min ~ Max	°C	-10 ~ +43	-10 ~ +43	-10 ~ +43
	Heat Min ~ Max	°C	-15 ~ +24	-15 ~ +24	-15 ~ +24

1) EER and COP calculation is based in accordance to EN14511. 2) For models below 12kW, the SEER and SCOP is calculated based on values of EU/626/2011. For models above 12kW, the SEER and SCOP is calculated based on values of EU/2281/2016. 3) The annual energy consumption is calculated in accordance to EU/626/2011. 4) Medium external static pressure setting from factory. 5) The sound pressure of the units shows the value measured of the position 1,5 below the unit. The sound pressure is measured in accordance with Eurovent 6/C006-97 specification. 6) When installing the outdoor unit at a higher position than the indoor unit. * Recommended fuse for the indoor 3A.



SEER and SCOP: For KIT-60PN1Z5 and KIT-71PN1Z5. INTERNET CONTROL: Optional.
Compatible with all Panasonic connectivity solutions. For detailed information go to the Control Systems section.

NEW PANASONIC BIG PACi SERIES R32

20,00 – 25,00kW is ideally suited for small, mid retail applications.

In addition to its light net weight and compact body, split-able Hide Away design newly developed enables easy piping work in narrow installation space.



Panasonic Big PACi, not only environmental friendly but also groundbreaking products

- High efficiency with Panasonic compressor as the driving force
- Compact & light indoor body
- Easy piping work with split-able Hide Away indoor design
- Separable indoor unit allows flexible installation to fit in narrow space
- Water Heat Exchanger compatibility
- Bluefin anti-rust coating
- Cloud Control compatible

Compact and light indoor body keeping high efficiency

15% lighter weight vs conventional model helps installation work drastically.

	Conventional model	New
20,00kW	100kg	86kg
25,00kW	104kg	88kg

DEPTH WAS REDUCED BY 230mm



Heat Exchanger with blue coated fins

Blue coated fins for corrosion resistance are equipped as standard in all R32 PACi models.

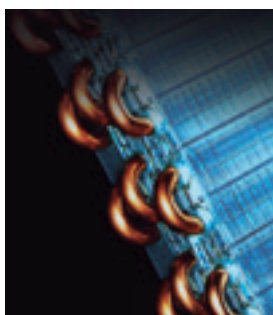

Easy piping work with split-able Hide Away indoor design

Part of heat exchanger and part of fan (fan + casing) can be separated while being installed.

The Hide Away indoor unit newly designed for easy reassemble totally fits in narrow space.

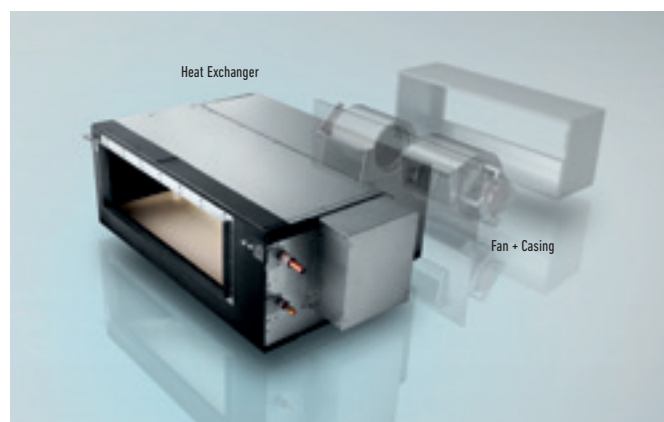

Water Heat Exchanger compatibility

New PACi Water Heat Exchanger is available to connect with Big PACi systems. Offering various possibilities for hydronic application, heating, cooling and DHW.

Cloud Control compatibility

Big PACi is compatible with Panasonic Cloud controls from wherever you are, 24/7/365.

Comfort cloud for end-users, owners

Panasonic AC Smart Cloud for professionals



New Big PACi High Static Pressure Hide Away 20,00–25,00kW Inverter+ • R32 GAS



CZ-RWS3 + CZ-RWRC3
Optional Controller.
Infrared remote controller.



CZ-RE2C2
Optional Controller.
Simplified remote controller.

Big PACi with R32 has been introduced with full renewal of its indoor unit, offering hydronic application by PACi Water Heat Exchanger

Big PACi is useful and cost saving solution for small and mid size of projects, can be offered also with VRF system.

Compact and light indoor body keeping the high efficiency is split-able design for easy piping work at limited narrow space.

Technical focus

- Highly efficient with compact indoor body, -16kg lighter than conventional model (10HP)
- Split-able Hide Away indoor design for easy & flexible piping work
- Better partial load control with Panasonic compressor
- Bluefin anti-rust coating
- PACi Water Heat Exchanger compatible
- Panasonic cloud control compatible
- 0-10V demand control

			Three Phase	
			20,00kW	25,00kW
KIT			KIT-200PE3ZH8	KIT-250PE3ZH8
Remote controller			CZ-RTC5B	CZ-RTC5B
Cooling capacity	Nominal (Min-Max)	kW	19,50(5,70~21,00)	23,20(6,10~27,00)
EER ¹⁾		W/W	3,22	3,11
SEER ²⁾			5,25	4,84
Pdesign		kW	19,50	23,20
Input power cooling		kW	6,06	7,46
Heating capacity	Nominal (Min-Max)	kW	22,40(5,00~25,00)	28,00(5,50~29,00)
COP ¹⁾		W/W	3,61	3,41
SCOP ²⁾			3,61	3,64
Pdesign at -10°C		kW	17,00	20,00
Input power heating		kW	6,21	8,21
Indoor unit			S-200PE3E5B	S-250PE3E5B
Power source		V / ph / Hz	220-230-240 / 1 / 50	220-230-240 / 1 / 50
External static pressure at shipment (adjustable)		Pa	75 ³⁾ -120-180	75 ³⁾ -130-200
Air volume	Hi / Med / Lo	m ³ /min	72 / 63 / 53	84 / 72 / 59
Sound pressure ⁴⁾	Hi / Med / Lo	dB(A)	46 / 44 / 41	47 / 45 / 42
Dimension	H x W x D	mm	486 x 1456 x 916	486 x 1456 x 916
Net weight		kg	86	88
Outdoor unit			U-200PZH2E8	U-250PZH2E8
Power source		V / ph / Hz	380-400-415 / 3 / 50	380-400-415 / 3 / 50
Recommended fuse		A	30	30
Air volume	Cool / Heat	m ³ /min	164 / 164	160 / 160
Sound pressure	Cool / Heat (Hi)	dB(A)	59 / 61	59 / 63
Sound power	Cool / Heat (Hi)	dB	77 / 79	78 / 82
Dimension ⁵⁾	H x W x D	mm	1500 x 980 x 370	1500 x 980 x 370
Net weight		kg	117	128
Piping connections	Liquid pipe	Inch (mm)	3/8(9,52)	1/2(12,70)
	Gas pipe	Inch (mm)	1(25,40)	1(25,40)
Pipe length range		m	5~90	5~60
Elevation difference (in/out) ⁶⁾		m	30	30
Pipe length for additional gas		m	30	30
Additional gas amount		g/m	60	80
Refrigerant (R32) / CO ₂ Eq.		kg / T	4,20 / 2,835	5,20 / 3,51
Operating range	Cool Min ~ Max	°C	-15 ~ +46	-15 ~ +46
	Heat Min ~ Max	°C	-20 ~ +24	-20 ~ +24

Accessories

CZ-RTC5B	Wired remote controller with Econavi function and datanavi
CZ-RWS3 + CZ-RWRC3	Infrared remote controller
CZ-RE2C2	Simplified remote controller

Accessories

PAW-GRDSTD40	Outdoor elevation platform 400x900x400mm
CZ-CAPWFC1	NEW Commercial WLAN Adaptor

- 1) EER and COP calculation is based in accordance to EN14511. 2) For models below 12kW, the SEER and SCOP is calculated based on values of EU/626/2011. For models above 12kW, the SEER and SCOP is calculated based on values of EU/2281/2016. 3) Factory setting. 4) The sound pressure of the units shows the value measured of the position 1,5 below the unit. The sound pressure is measured in accordance with Eurovent 6/C/006-97 specification. 5) Add 100mm for indoor unit or 70mm for outdoor unit for piping port. 6) When installing the outdoor unit at a higher position than the indoor unit. * No filter included. * These models will be available in May 2019.



INTERNET CONTROL: Optional.

Compatible with all Panasonic connectivity solutions. For detailed information go to the Control Systems section.

PACi SINGLE, TWIN, TRIPLE AND DOUBLE-TWIN SYSTEM



With this system, a single outdoor unit can split capacity for up to 4 indoor areas simultaneously. This makes the system particularly apt for common areas. It reduces noise concentration and enables the same temperature to be reached around the room. A mix of indoor units can be installed (Wall, Cassette, Hide Away, Ceiling) in one system.

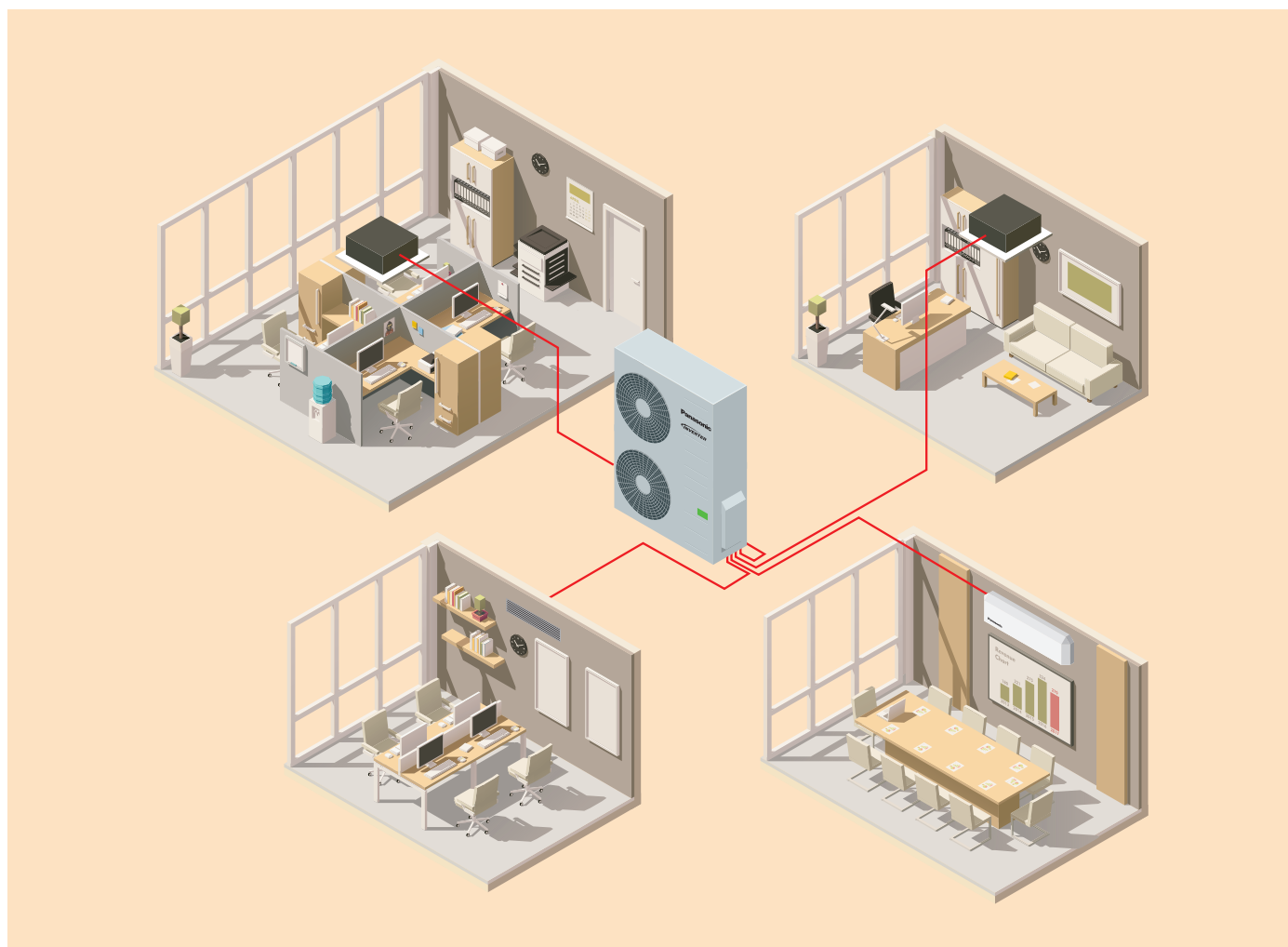

- 1 PACi Standard from 7,10 to 14,00kW**
Up to 2 indoor units connectable on the same outdoor. Panasonic's PACi units can be installed as single and twin systems. The indoor units can be combined following the selection table. The operation will always be simultaneous. All the indoor units will work with the same settings.
- 2 PACi Elite from 7,10 to 14,00kW**
Up to 4 indoor units can be connected to the same outdoor unit. Panasonic's PACi units 71,00, 10,00, 12,50 and 14,00 can be installed as twin, triple and double-twin systems. The indoor units can be combined as per the selection table. The operation will always be simultaneous. All the indoor units will work with the same settings.
- 3 Big PACi Elite from 20,00 to 25,00kW**
Up to 4 indoor units can be connected to the same outdoor unit. Panasonic's PACi units 20,00 and 25,00 can be installed as twin, triple and double-twin systems. The indoor units can be combined as per the selection table. The operation will always be simultaneous. All the indoor units will work with the same settings.

**PACi Elite Outdoor Units • R32 Gas¹**

			7,10kW	10,00kW	12,50kW	14,00kW	20,00kW	25,00kW
Outdoor unit Single Phase			U-71PZH2E5	U-100PZH2E5	U-125PZH2E5	U-140PZH2E5	—	—
Outdoor unit Three Phase			U-71PZH2E8	U-100PZH2E8	U-125PZH2E8	U-140PZH2E8	U-200PZH2E8²	U-250PZH2E8²
Cooling capacity	Nominal (Min - Max)	kW	7,10 (2,20 - 9,00)	10,00 (3,10 - 12,50)	12,50 (3,20 - 14,00)	14,00 (3,30 - 16,00)	20,00 (5,70 - 22,40)	25,00 (6,10 - 28,00)
Heating capacity	Nominal (Min - Max)	kW	8,00 (2,00 - 9,00)	11,20 (3,10 - 14,00)	14,00 (3,20 - 16,00)	16,00 (3,30 - 18,00)	22,40 (5,00 - 25,00)	28,00 (5,50 - 31,50)
Power source	Single Phase	V	220 / 230 / 240	220 / 230 / 240	220 / 230 / 240	220 / 230 / 240	—	—
	Three Phase	V	380 / 400 / 415	380 / 400 / 415	380 / 400 / 415	380 / 400 / 415	380 / 400 / 415	380 / 400 / 415
Connection indoor / outdoor		mm ²	2 x 1,5 or 2,5	2 x 1,5 or 2,5	2 x 1,5 or 2,5	2 x 1,5 or 2,5	—	—
Air volume	Cool / Heat	m ³ /min	61 / 60	118 / 108	125 / 122	129 / 116	164 / 164	160 / 160
Sound pressure	Cool / Heat (Hi)	dB(A)	48 / 50	52 / 52	53 / 53	54 / 54	59 / 61	59 / 63
Sound power	Cool / Heat (Hi)	dB	65 / 67	69 / 69	70 / 70	71 / 71	77 / 79	78 / 82
Dimension	HxWxD	mm	996 x 940 x 340	1416 x 940 x 340	1416 x 940 x 340	1416 x 940 x 340	1500 x 980 x 370	1500 x 980 x 370
Net weight		kg	68	99	99	99	117	128
Piping connections	Liquid pipe	Inch (mm)	3/8 (9,52)	3/8 (9,52)	3/8 (9,52)	3/8 (9,52)	3/8 (9,52)	1/2 (12,70)
	Gas pipe	Inch (mm)	5/8 (15,88)	5/8 (15,88)	5/8 (15,88)	5/8 (15,88)	1 (25,40)	1 (25,40)
Pipe length range	Min ~ Max	m	5 ~ 50	5 ~ 85	5 ~ 85	5 ~ 85	5 ~ 80	5 ~ 60
Elevation difference (in/out)	Max	m	30	30	30	30	30	30
Pipe length for additional gas		m	30	30	30	30	30	30
Additional gas amount		g/m	45	45	45	45	60	80
Refrigerant (R32) / CO ₂ Eq.		kg / T	1,95 / 1,316	3,05 / 2,059	3,05 / 2,059	3,05 / 2,059	4,20 / 2,835	5,20 / 3,51
Operating range	Cool Min ~ Max	°C	-15 ~ +46	-15 ~ +46	-15 ~ +46	-15 ~ +46	-15 ~ +46	-15 ~ +46
	Heat Min ~ Max	°C	-20 ~ +24	-20 ~ +24	-20 ~ +24	-20 ~ +24	-20 ~ +24	-20 ~ +24

1) These models will be available in Winter 2018. 2) These models will be available in May 2019. Tentative data.

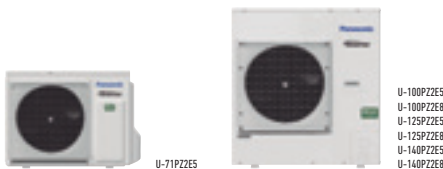
**PACi Standard Outdoor Units • R32 Gas**

			7,10kW	10,00kW	12,50kW	14,00kW
Outdoor unit Single Phase			U-71PZ2E5	U-100PZ2E5	U-125PZ2E5	U-140PZ2E5
Outdoor unit Three Phase			—	U-100PZ2E8	U-125PZ2E8	U-140PZ2E8
Cooling capacity	Nominal (Min - Max)	kW	7,10	10,00 (3,00 - 11,50)	12,50 (3,20 - 13,50)	14,00 (3,30 - 15,00)
Heating capacity	Nominal (Min - Max)	kW	7,10	10,00 (3,00 - 14,00)	12,50 (3,30 - 15,00)	14,00 (3,40 - 16,00)
Power source	Single Phase	V	220 / 230 / 240	220 / 230 / 240	220 / 230 / 240	220 / 230 / 240
	Three Phase	V	—	380 / 400 / 415	380 / 400 / 415	380 / 400 / 415
Connection indoor / outdoor		mm ²	2 x 1,5 or 2,5	2 x 1,5 or 2,5	2 x 1,5 or 2,5	2 x 1,5 or 2,5
Air volume	Cool / Heat	m ³ /min	50 / 45	76 / 70	86 / 78	89 / 83
Sound pressure	Cool / Heat (Hi)	dB(A)	49 / 49	52 / 52	55 / 55	56 / 56
Sound power	Cool / Heat (Hi)	dB	69 / 69	70 / 70	73 / 73	74 / 74
Dimension	HxWxD	mm	695 x 875 x 320	996 x 980 x 370	996 x 980 x 370	996 x 980 x 370
Net weight		kg	44	90	94	94
Piping connections	Liquid pipe	Inch (mm)	3/8 (9,52)	3/8 (9,52)	3/8 (9,52)	3/8 (9,52)
	Gas pipe	Inch (mm)	5/8 (15,88)	5/8 (15,88)	5/8 (15,88)	5/8 (15,88)
Pipe length range	Min ~ Max	m	3 ~ 40	5 ~ 50	5 ~ 50	5 ~ 50
Elevation difference (in/out)	Max	m	30	30	30	30
Pipe length for additional gas		m	30	30	30	30
Additional gas amount		g/m	35	45	45	45
Refrigerant (R32) / CO ₂ Eq.		kg / T	1,45 / 0,979	2,60 / 1,755	2,98 / 2,0115	2,98 / 2,0115
Operating range	Cool Min ~ Max	°C	-10 ~ +43	-10 ~ +43	-10 ~ +43	-10 ~ +43
	Heat Min ~ Max	°C	-15 ~ +24	-15 ~ +24	-15 ~ +24	-15 ~ +24



Wall	Indoor	Cooling capacity	Heating capacity	Dimension		Sound pressure		Air volume	
				HxWxD		Hi / Med / Lo		Hi / Med / Lo	
				mm		dB(A)		m³/min	
3,60kW	S-36PK2E5B	3,60	4,20	302x1120x236		35 / 31 / 27		11,00 / 9,50 / 7,50	
4,50kW	S-45PK2E5B	4,50	5,20	302x1120x236		38 / 34 / 30		12,00 / 10,50 / 8,50	
5,00kW	S-50PK2E5B	5,00	5,60	302x1120x236		40 / 36 / 32		14,00 / 12,00 / 10,50	
6,00kW	S-60PK2E5B	6,00	7,00	302x1120x236		47 / 44 / 40		18,00 / 14,50 / 11,50	
7,10kW	S-71PK2E5B	7,10	8,00	302x1120x236		47 / 44 / 40		18,00 / 14,50 / 11,50	
10,00kW	S-100PK2E5B	10,00	11,20	302x1120x236		47 / 44 / 40		19,00 / 16,50 / 13,00	

4 Way 60x60 Cassette	Indoor (Panels CZ-KPY3AW / CZ-KPY3BW)	Cooling capacity	Heating capacity	Dimension: Indoor / CZ-KPY3AW / CZ-KPY3BW		Sound pressure	Air volume		
				HxWxD				Hi / Med / Lo	Hi / Lo
				mm					
3,60kW	S-36PY2E5B	3,60	4,20	288x583x583 / 31x700x700 / 31x625x625		36 / 32 / 26		9,70 / 9,90	
4,50kW	S-45PY2E5B	4,50	5,20	288x583x583 / 31x700x700 / 31x625x625		38 / 34 / 28		10,00 / 10,30	
5,00kW	S-50PY2E5B	5,00	5,60	288x583x583 / 31x700x700 / 31x625x625		40 / 37 / 33		11,10 / 11,10	

4 Way 90x90 Cassette	Indoor (Panels CZ-KPU3W / CZ-KPU3AW)	Cooling capacity	Heating capacity	Dimension Indoor		Dimension Panel		Sound pressure	Air volume		
				HxWxD		HxWxD				Hi / Med / Lo	Hi / Med / Lo
				mm		mm					
3,60kW	S-36PU2E5B	3,60	4,20	256x840x840		33,5x950x950		30 / 28 / 27		14,50 / 13,00 / 11,50	
4,50kW	S-45PU2E5B	4,50	5,20	256x840x840		33,5x950x950		31 / 28 / 27		15,50 / 13,00 / 11,50	
5,00kW	S-50PU2E5B	5,00	5,60	256x840x840		33,5x950x950		32 / 29 / 27		16,50 / 13,50 / 11,50	
6,00kW	S-60PU2E5B	6,00	7,00	256x840x840		33,5x950x950		38 / 31 / 28		21,00 / 16,00 / 13,00	
7,10kW	S-71PU2E5B	7,10	8,00	256x840x840		33,5x950x950		37 / 31 / 28		22,00 / 16,00 / 13,00	
10,00kW	S-100PU2E5B	10,00	11,20	319x840x840		33,5x950x950		45 / 38 / 32		36,00 / 26,00 / 18,00	
12,50kW	S-125PU2E5B	12,50	14,00	319x840x840		33,5x950x950		46 / 39 / 33		37,00 / 27,00 / 19,00	
14,00kW	S-140PU2E5B	14,00	14,00	319x840x840		33,5x950x950		47 / 40 / 34		38,00 / 29,00 / 20,00	

Ceiling	Indoor	Cooling capacity	Heating capacity	Dimension		Sound pressure		Air volume	
				HxWxD		Hi / Med / Lo		Hi / Med / Lo	
				mm		dB(A)		m³/min	
3,60kW	S-36PT2E5B	3,60	4,20	235x960x690		35 / 32 / 30		14,00 / 12,00 / 10,50	
4,50kW	S-45PT2E5B	4,50	5,20	235x960x690		38 / 33 / 30		15,00 / 12,50 / 10,50	
5,00kW	S-50PT2E5B	5,00	5,60	235x960x690		38 / 33 / 30		15,00 / 12,50 / 10,50	
6,00kW	S-60PT2E5B	6,00	7,00	235x1275x690		39 / 36 / 33		20,00 / 17,00 / 14,50	
7,10kW	S-71PT2E5B	7,10	8,00	235x1275x690		39 / 36 / 33		21,00 / 18,00 / 15,50	
10,00kW	S-100PT2E5B	10,00	11,20	235x1590x690		42 / 38 / 35		30,00 / 25,00 / 23,00	
12,50kW	S-125PT2E5B	12,50	14,00	235x1590x690		45 / 40 / 37		34,00 / 28,00 / 24,00	
14,00kW	S-140PT2E5B	14,00	14,00	235x1590x690		47 / 41 / 37		35,00 / 29,00 / 25,00	

High Static Pressure Hide Away	Indoor	Cooling capacity	Heating capacity	Dimension		External static pressure		Sound pressure		Air volume	
				HxWxD		Hi / Med / Lo		Hi / Med / Lo		Hi / Med / Lo	
				mm		Pa		dB(A)		m³/min	
3,60kW	S-36PF1E5B	3,60	4,20	290x800x700		150 / 70 / 10		33 / 29 / 25		14,00 / 13,00 / 10,00	
4,50kW	S-45PF1E5B	4,50	5,20	290x800x700		150 / 70 / 10		34 / 30 / 26		14,00 / 13,00 / 10,00	
5,00kW	S-50PF1E5B	5,00	5,60	290x800x700		150 / 70 / 10		34 / 30 / 26		16,00 / 15,00 / 12,00	
6,00kW	S-60PF1E5B	6,00	7,00	290x1000x700		150 / 70 / 10		35 / 32 / 26		21,00 / 19,00 / 15,00	
7,10kW	S-71PF1E5B	7,10	8,00	290x1000x700		150 / 70 / 10		35 / 32 / 26		21,00 / 19,00 / 15,00	
10,00kW	S-100PF1E5B	10,00	11,20	290x1400x700		150 / 100 / 10		38 / 34 / 31		32,00 / 26,00 / 21,00	
12,50kW	S-125PF1E5B	12,50	14,00	290x1400x700		150 / 100 / 10		39 / 35 / 32		34,00 / 29,00 / 23,00	
14,00kW	S-140PF1E5B	14,00	14,00	290x1400x700		150 / 100 / 10		40 / 36 / 33		36,00 / 32,00 / 25,00	

Low Static Pressure Hide Away	Indoor	Cooling capacity	Heating capacity	Dimension		External static pressure		Sound pressure		Air volume	
				HxWxD		Hi / Med / Lo		Hi / Med / Lo		Hi / Med / Lo	
				mm		Pa		dB(A)		m³/min	
3,60kW	S-36PN1E5B	3,60	4,20	250x780x650		80 / 50 / 10		40 / 38 / 35		14,00 / 12,00 / 10,00	
4,50kW	S-45PN1E5B	4,50	5,20	250x780x650		80 / 50 / 10		41 / 39 / 35		16,00 / 13,00 / 11,00	
5,00kW	S-50PN1E5B	5,00	5,60	250x780x650		80 / 50 / 10		41 / 39 / 35		16,00 / 13,00 / 11,00	
6,00kW	S-60PN1E5B	6,00	7,00	250x1000x650		80 / 50 / 10		43 / 41 / 36		22,00 / 20,00 / 16,00	
7,10kW	S-71PN1E5B	7,10	8,00	250x1000x650		80 / 50 / 10		43 / 41 / 36		22,00 / 20,00 / 16,00	
10,00kW	S-100PN1E5B	10,00	11,20	250x1200x650		80 / 50 / 10		44 / 42 / 37		36,00 / 33,00 / 26,00	
12,50kW	S-125PN1E5B	12,50	14,00	250x1200x650		80 / 50 / 10		46 / 44 / 39		38,00 / 35,00 / 28,00	
14,00kW	S-140PN1E5B	14,00	14,00	250x1200x650		80 / 50 / 10		46 / 44 / 39		40,00 / 37,00 / 30,00	

PACi Standard from 7,10 to 14,00kW Single/Simultaneous operation system combinations • R32 GAS and • R410A GAS

Indoor	Outdoor			
	7,10kW	10,00kW	12,50kW	14,00kW
3,60kW	Twin ¹ U-71 S-36 S-36			
5,00kW		Twin U-100 S-50 S-50		
6,00kW			Twin U-125 S-60 S-60	
7,10kW	Single ² U-71 S-71			Twin U-140 S-71 S-71
10,00kW		Single ² U-100 S-100		
12,50kW			Single ² U-125 S-125	
14,00kW				Single ² U-140 S-140

PACi Elite from 7,10 to 14,00kW Single/Simultaneous operation system combinations • R32 GAS and • R410A GAS

Indoor	Outdoor			
	7,10kW	10,00kW	12,50kW	14,00kW
3,60kW	Twin U-71 S-36 S-36	Triple U-100 S-36 S-36 S-36	Double-Twin U-125 S-36 S-36 S-36 S-36	
4,50kW			Triple U-125 S-45 S-45 S-45	
5,00kW		Twin U-100 S-50 S-50		Triple U-140 S-50 S-50 S-50
6,00kW			Twin U-125 S-60 S-60	
7,10kW	Single ² U-71 S-71			Twin U-140 S-71 S-71
10,00kW		Single ² U-100 S-100		
12,50kW			Single ² U-125 S-125	
14,00kW				Single ² U-140 S-140

PACi Elite from 20,00 to 25,00kW Single/Simultaneous operation system combinations • R32 GAS and • R410A GAS

Indoor	Outdoor	
	20,00kW	25,00kW
5,00kW	Double-Twin U-200 S-50 S-50 S-50 S-50	
6,00kW		Double-Twin U-250 S-60 S-60 S-60 S-60
7,10kW	Triple U-200 S-71 S-71 S-71	
10,00kW	Twin U-200 S-100 S-100	
12,50kW		Twin U-250 S-125 S-125
20,00kW	Single ² U-200 S-200	
25,00kW		Single ² U-250 S-250

1. Available for only PZ (R32) model with limitations of main pipe and branch pipe. Please contact an authorized Panasonic dealer. 2. PACi 1x1 Kit solution.

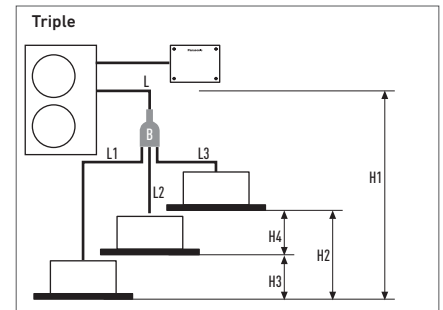
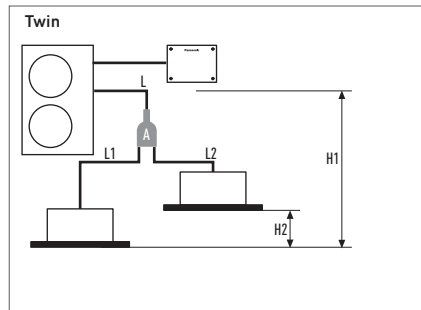
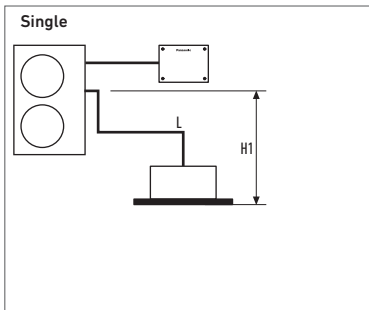

PACi Standard Twin System from 7,10 to 14,00kW

Joint distribution (sold separately)
A= CZ-P224BK2BM

PACi Elite Twin, Triple and Double-Twin System from 7,10 to 14,00kW

Joint distribution (sold separately)
A= CZ-P224BK2BM
B= CZ-P3HPC2BM
C= CZ-P224BK2BM

PACi Elite Twin, Triple and Double-Twin System from 20,0 to 25,00kW

Joint distribution (sold separately)
A= CZ-P680BK2BM
B= CZ-P3HPC2BM
C= CZ-P224BK2BM

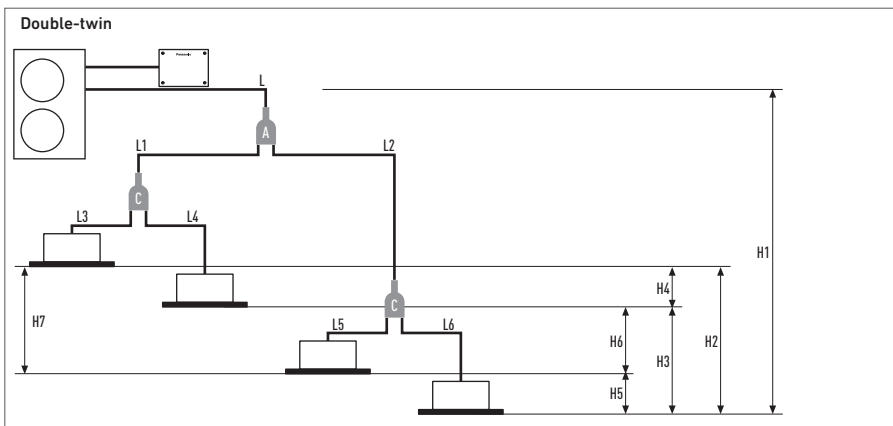

Twin System	PACi Standard Single and Twin System from 7,10 to 14,00kW			PACi Elite Twin, Triple and Double-Twin System from 7,10 to 25kW					
	Indoor unit combinations (see examples above)		Equivalent lengths and height differences (m) for outdoor unit sizes...	Indoor unit combinations (see examples above)				Equivalent lengths and height differences (m) for outdoor unit sizes from 7,10 to 14,00kW	Equivalent lengths and height differences (m) for outdoor unit sizes from 20,00 to 25,00kW
	Single	Twin		Single	Twin	Triple	Double-Twin		
Total pipe length	L	L + L1 + L2	≤ 50m	L	L + L1 + L2	L + L1 + L2 + L3	L + L1 + L2 + L3 + L4 + L5 + L6	U-60/U-71: ≤ 50m U-100/125/140: ≤ 75m	U-200: ≤ 100m U-250: ≤ 80m
Maximum pipe length from outdoor unit to most distant indoor unit	-	-	-	-	L + L1 or L + L2	L + L1 or L + L2 or L3	L + L1 + L3 or L + L1 + L4 or L + L2 + L5 or L + L2 + L6	-	U-200: 90m U-250: 60m
Maximum branch pipe length	-	L1 L2	≤ 15	-	L1 or L2	L1 or L2 or L3	L1 + L3 or L1 + L4 or L2 + L5 or L2 + L6	≤ 15m	≤ 20m
Maximum branch pipe length differences	-	L1 > L2 L1 - L2	≤ 10	-	L1 > L2: L1 - L2	L1 > L2 > L3: L1 - L2 L2 - L3 L1 - L3	L2 + L6 (Max): L1 + L3 (Min): (L2 + L6) - (L1 + L3)	≤ 10m	≤ 10m
Maximum pipe length differences after first branch (Double-Twin)	-	-	-	-	-	-	L2 > L1: L2 - L1	≤ 10m	≤ 10m
Maximum pipe length differences after second branch (Double-Twin)	-	-	-	-	-	-	L4 > L3: L4 - L3 L6 > L5: L6 - L5	≤ 10m	≤ 10m
Height difference (outdoor unit located higher)	H1	H1	≤ 30	H1	H1	H1	H1	≤ 30m	≤ 30m
Height difference (outdoor unit located lower)	H1	H1	≤ 15	H1	H1	H1	H1	≤ 15m	≤ 15m
Height difference between indoor units	-	H2	≤ 0,5	-	H2	H2 or H3 or H4	H2 or H3 or H4 or H5 or H6	≤ 0,5m	≤ 0,5m

Twin System	PACi Standard Single and Twin System from 7,10 to 14,00kW				PACi Elite Twin, Triple and Double-Twin System from 7,10 to 14,00kW						PACi Elite Twin, Triple and Double-Twin System from 20,00 to 25,00kW				
	Outdoor unit main pipe diameter (L)		Indoor unit connection tube (L1, L2)		Outdoor unit main pipe diameter (L)	Indoor unit connection pipe diameter (L1, L2, L3, L4) (mm)					Outdoor unit main pipe diameter (L) (mm)		Double-Twin distribution pipe (L1, L2) ¹⁾		Indoor unit connection pipe diameter ²⁾
Unit type capacity	100	125	50	60	71 - 140	36	45	50	60	71	200	250	100 - 125	50	60 - 125
Liquid pipe (mm)	Ø 9,52	Ø 12,70	Ø 6,35	Ø 9,52	Ø 9,52	Ø 6,35	Ø 6,35	Ø 6,35	Ø 9,52	Ø 9,52	Ø 9,52	Ø 12,70	Ø 9,52	Ø 6,35	Ø 9,52
Gas pipe (mm)	Ø 15,88	Ø 15,88	Ø 12,70	Ø 15,88	Ø 15,88	Ø 12,70	Ø 12,70	Ø 12,70	Ø 15,88	Ø 15,88	Ø 25,40	Ø 25,40	Ø 15,88	Ø 12,70	Ø 15,88
Additional gas amount (g/m)	50	50	20	50	50	20	20	20	50	50	60	80	45	20	45

1) Total capacity of indoor unit connected after the branch. 2) 4 Way Cassette type.

Make additional charges by adding up tube length in an order of main tube (L) → branch tube (L1 → L2 → L3 wide diameter) and then selecting the amount of refrigerant corresponding to the remaining (after charge-less tube length : 30m) liquid tube diameter and tube length from the above table.

NEW PRO-HT TANK SERIES FOR PACi AND ECOi

MAXIMUM
75°C
WATER OUTLET
TEMPERATURE



Enjoy an efficient DHW / heating and cooling tank.
Panasonic commercial PRO-HT Tank solutions meet all needs of your hot water applications providing maximum water temperature 75°C.

PRO-HT TANK

PRO-HT Tank DHW: PAW-VP1000/500/200LDHW. Big volume and high temperature tank for commercial application

1 High performance and high saving

- Maximum A7 COP 5,36 for 200L tank
- System label maximum A+++ (scale from A+++ to G)
- High temperature hot water without booster

2 Hot water production with simultaneous heating and cooling

- Maximum water outlet temperature up to 75°C
- Big volume tank from 200L to 1000L capacity
- Heat exchanger design prevents limescale

3 Trusted quality

- Double tube heat exchanger following drinking-water regulation
- Tank and heat exchanger made with stainless steel
- Internal and external pickling

Solution example DHW tank 1000L + PACi

- Ideal for small hotels and high-end residential
- Hot water temperature up to 75°C
- Up to A7 COP 5,36

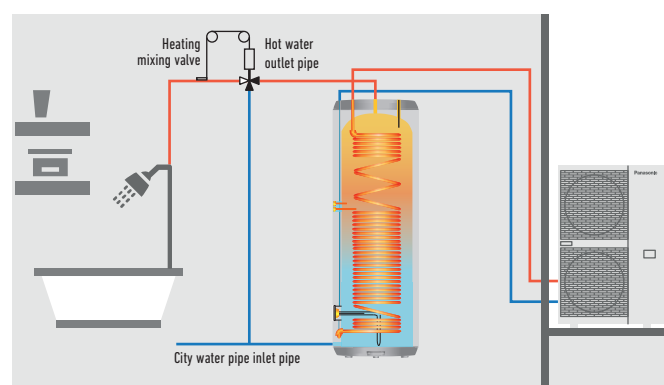

PRO-HT Tank heating and cooling: PAW-VP380L. Waterborne heating and cooling for floor heating, radiators or fan coils

1 High performance and high saving

- A7 COP 3,28, heating water temperature at 45°C
- Maximum 60°C water outlet temperature
- Energy efficiency class : A++ (scale from A++ to G)

2 Simple waterborne heating and cooling solution

- High temperature water without any boosters
- Installation cost can be saved without additional boosters and buffer tanks

3 Trusted quality

- Double tube heat exchanger following drinking-water regulation
- Tank and heat exchanger made with stainless steel
- Internal and external pickling

Heating and cooling tank 380L + PACi 20,00kW

- Ideal offer for small offices
- Cost saving solution with simple waterborne heating and cooling
- Hot water up to 60°C

One by one system compatible list with PACi Elite

Model	Tank type	Product compatibility	Hot water outlet temperature
PAW-VP1000LDHW	DHW	U-250PZH2E8	75°C
PAW-VP500LDHW	DHW	U-100PZH2E5/8	75°C
PAW-VP200LDHW	DHW	U-100PZH2E5/8	75°C
PAW-VP380L	Heating and cooling	U-200PZH2E8	60°C

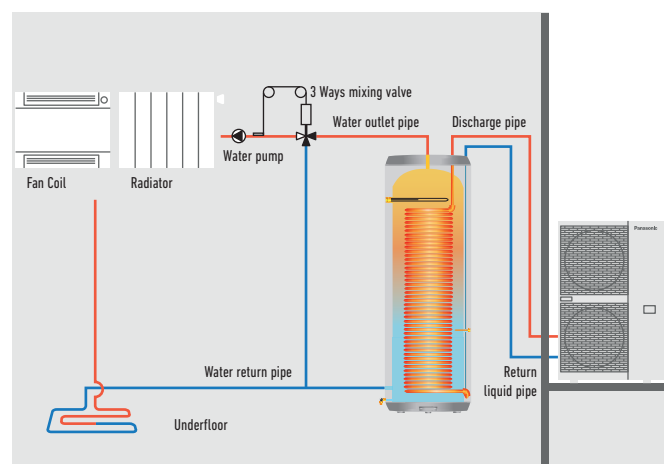

New PRO-HT Tank DHW

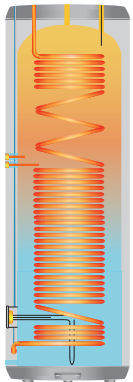

NEW
2019

High temperature hot water is efficiently produced without any boosters

Panasonic commercial PRO-HT Tank solutions can be adapted to adapt various projects from high-end residential to offices and hotels.

Technical focus

- Water volume 200L, 500L and 1000 L
- Maximum hot water production 75°C without boosters
- Tank and heat exchanger made with stainless steel
- Heating coil 23m (200L), 35m (500L) and 63m (1000L)
- Internal and external pickling
- Foam insulation 70mm (200 and 500L) and 100mm (1000L)
- Tank material 2mm (200L) and 3mm (500 and 1000L)
- ABS external

PRO-HT Tank			PAW-VP200LDHW	PAW-VP500LDHW	PAW-VP1000LDHW
Outdoor Unit			U-100PZH2E5	U-100PZH2E5	U-250PZH2E8 **
Volume		L	214	510	933
Height	H x W	mm	1568x590	1660x790	2210x990
Connections to the water supply network			3/4" - 1"	3/4" - 1"	1 1/4"
Net weight / with water		kg	73 / 286	122 / 632	235 / 1167
Nominal electrical power		W	2320	2320	6320
Reference tapping cycle			M	XL	2XL
Energy consumption by chosen cycle A7 / W10-55		kWh	1,09	4,50	6,30
Energy consumption by chosen cycle A15 / W10-55		kWh	0,91	3,60	5,40
COP DHW (A7 / W10-55) EN 16147 ¹⁾			5,36	4,23	3,91
COP DHW (A15 / W10-55) EN 16147 ²⁾			6,42	5,29	4,54
Energy Efficiency Class (from A+ to G) ³⁾			A+	A+	A+
System label (from A+++ to G) ³⁾			A+++	A++	A++
Standby Input power according to EN16147		W	25,10	40,10	80,00
Sound Pressure on 1m		dB(A)	53	63	57
Quantity of refrigerant		g	2,6+0,2	2,6+0,6	6,4+1,0
Operating range - air temperature		°C	-20 ~ +35	-20 ~ +35	-20 ~ +35
Stainless steel 316L tank			Yes	Yes	Yes
Average insulation thickness		mm	70	70	100
Heat exchanger connection for inlet / outlet		Inch (mm)	3/8 (9,52) / 5/8 (15,88)	3/8 (9,52) / 5/8 (15,88)	1/2 (12,70) / 3/4 (19,05)
Maximum power consumption without heater		W	3990	3990	9000
Maximum power consumption with heater		W	5990	6990	15000
Number of electrical heaters x power		W	1 x 2000	1 x 3000	1 x 6000
Voltage / Frequency		V / Hz	230 / 50	230 / 50	400 / 50
Electric protection		A	16	16	16
Moisture protection			IP 24	IP 24	IP 24
Heating with heat pump	Min / Max	°C	5 / 76	5 / 76	5 / 76
Heating with electrical heater	Min / Max	°C	55 / 75	55 / 75	55 / 75
Refrigerant (R32) / CO ₂ Eq.		kg / T	2,8 / 1,890	3,2 / 2,160	7,4 / 4,995

Accessories

PAW-VP-RTC5B-PAC Tank controller for PACi system

PAW-VP-VALV-160/280

1) Heating of sanitary water up to 55°C with inlet air temperature at 7°C, humidity at 89% and inlet water temperature at 10°C. According to EN16147. 2) Heating of sanitary water up to 55°C with inlet air temperature at 15°C, humidity at 74% and inlet water temperature at 10°C. According to EN16147. 3) Following LOT 2 (COMMISSION DELEGATED REGULATION (EU) No. 812/2013).

This product is designed to comply with the European Water Quality Directive 98/83/EC amended by 2015/1787/EU. The lifespan of the product is not guaranteed in the case of the use of groundwater, such as spring water or well water, the use of tap water when salt or other impurities are contained, nor in areas of acidic water quality. Maintenance and warranty costs related to these cases are the customer's responsibility.

* When connected as pressurised, safety valve is mandatory.

** Tentative data.

*** R410A models are also compatibles.

New PRO-HT Tank heating and cooling



High temperature hot water is efficiently produced without any boosters

Panasonic commercial PRO-HT Tank solutions can be combined with PACi to adapt various projects from high-end residential to offices and hotels.

Technical focus

- Water volume 380L
- Maximum hot water production 65°C
- Tank and heat exchanger made with stainless steel
- Heating coil 52m 316L
- Internal and external pickling
- Foam insulation 70mm
- Tank material 2mm 316L
- ABS external

PRO-HT Tank		PAW-VP380L	
Cooling capacity at 35°C, water outlet 7°C		kW	12,80
Heating capacity at +7°C, heating water temperature at 35°C		kW	25,00
Heating capacity at +7°C, heating water temperature at 45°C		kW	23,00
COP at +7°C with heating water temperature at 45°C		W/W	3,28
Heating Energy Efficiency class at 35°C^{1) 2)}			A++
η_s (LOT1) ²⁾		%	156
Dimension	H x W	mm	1820 x 690
Shipping weight		kg	99
Water pipe connector			1 1/4"
Heating water flow at 35°C		m ³ /h	3,9
Input power		kW	TBC
Maximum current		A	TBC
Outdoor Unit		U-200PZH2E8	
Sound pressure		dB(A)	62
Dimension	H x W x D	mm	1500 x 980 x 370
Net weight		kg	119
Piping connections	Liquid pipe	Inch (mm)	3/8 (9,52)
	Gas pipe	Inch (mm)	3/4 (19,05)
Refrigerant (R32) / CO ₂ Eq.		kg	5,60 *Need Additional gas amount at site +1,5kg
Pipe length range		m	50
Elevation difference (in/out)		m	30 (OD above) 30 (OD below)
Pipe length for nominal capacity		m	7,5
Pipe length for additional gas		m	85
Additional gas amount		g/m	Refer to manual
Operation range	Heat Min ~ Max	°C	-20 ~ +35

Accessories

PAW-VP-RTC5B-PAC Tank controller for PACi system

PAW-VP-RTC5B-PAC Tank controller for PACi system

PAW-VP-VALV-160/280

1) Scale from A++ to G and from A+++ to D from 26th September 2019. 2) Seasonal space heating energy efficiency following COMMISSION REGULATION (EU) 811/2013.

This product is designed to meet European water quality standard 98/93 EC. The lifespan of the product is not guaranteed in the case of the use of groundwater, such as spring water or well water, the use of tap water when salt or other impurities are contained, nor in areas of acidic water quality. Maintenance and warranty costs related to these cases are the customer's responsibility.

Performance calculation in agreement with Eurovent. Sound pressure measured at 1m from the outdoor unit and at 1,5m height.

* Flow switch and water filter are not equipped.

NEW WHE FOR PACi



New PACi with Water Heat Exchanger for chilled and hot water production



NEW
2019

Industry first PACi Water Heat Exchanger

Panasonic introduces high-efficiency Water Heat Exchanger for packaged air conditioning systems.

This ground-breaking product gives further possibilities of PACi solutions by adding hydronic options.

Short-term investment

PACi Water Heat Exchanger is ideal for small offices and retails. The investment costs can be amortised within a very short period. This solution allows investors and operators to save money.

Professional solution

New Water Heat Exchanger is compatible with R32 PACi. Many air conditioning manufacturers selling R32 systems and it is becoming the standard refrigerant for split type air conditioning systems because R32 has a much lower global warming potential than R410A and can also provide higher efficiency.

Tentative data

Water Heat Exchanger			PAW-200W5APAC	PAW-250W5APAC
Cooling capacity at 35°C, water outlet 7°C Rated	kW		20,00	25,00
Heating capacity at +7°C, heating water temperature at 45°C	kW		20,00	25,00
COP at +7°C with heating water temperature at 45°C	W/W		3,50	3,40
Heating water flow (ΔT=5 K, 35°C)	m ³ /h		4,0	4,3
Flow switch			Optional	Optional
Water filter			Optional	Optional
Dimension	HxWxD	mm	623x450x350	623x450x350
Outdoor Unit			U-200PZH2E8	U-250PZH2E8
Sound pressure	Cool / Heat (Hi)	dB(A)	60 / 62	61 / 63
Dimension	HxWxD	mm	1500x980x370	1500x980x370
Net weight		kg	119	130
Piping connections	Liquid pipe	Inch (mm)	3/8 (9,52)	1/2 (12,70)
	Gas pipe	Inch (mm)	1 (25,40)	1 (25,40)
Pipe length range		m	5 ~ 90	5 ~ 60
Elevation difference (in/out)		m	30	30
Pipe length for additional gas		m	30	30
Additional gas amount		g/m	60	80
Refrigerant (R32) / CO ₂ Eq.		kg / T	—	—
Operating range	Cool Min ~ Max	°C	-15 ~ +46	-15 ~ +46
	Heat Min ~ Max	°C	-20 ~ +24	-20 ~ +24

*Available until the end of 2019



5 YEARS COMPRESSOR WARRANTY

PANASONIC VENTILATION SOLUTIONS



Panasonic ventilation solutions for maximum savings and easy integration.

AHU Kit connects PACi outdoor units to Air Handling Units system¹

AHU Kit combines air conditioning and fresh air in just one solution.

The Panasonic AHU Kits offer a wealth of connectivity possibilities so can be easily integrated into many systems.

Besides the advantages in terms of indoor air quality, air conditioning offers also an energy saving potential. For example, while uncontrolled ventilation through open windows leads to large amounts of heat being lost to the outside during the heating season or gained from the outside during the cooling season, air conditioning systems provide possibilities to utilize the extra “free” energy in heat recovery modules so that overall operating costs will be reduced.

The larger area of the comfort range, the better the energy saving opportunities.

Application: Hotels, offices, server rooms or all large buildings where air quality control such as humidity control and fresh air and is needed.

Heat exchanger, Fan & Fan motor to be mounted in AHU Kit shall be provided in the field.

Contents of kit: Control for PCB and sensors.



¹) Compatible with R32 models. Special setting is required.

Air Curtain with DX Coil¹

Highly efficient heating effect

The combined air stream, which has a desirable low air current induction factor (mixing factor), can carry the selected initial temperature effect over long distances, and will reach the floor area while still at room temperature. This is necessary to avoid cooling down the interior spaces.



The Panasonic range of air curtains is designed for smooth operation and efficient performance. Air curtains produce a continuous stream of air blown from the top to the bottom of an open doorway and create a barrier that people and products can flow across, but air can't. Designed to improve energy efficiency, minimise heat loss from a building, and to allow retailers to keep doors open to encourage customers, our Air Curtains are suitable for connection to both VRF and PACi Systems.

Heating capacity comparison: Electrical air curtain / Panasonic air curtain

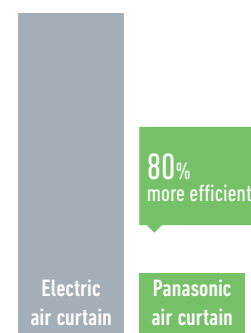

^{*} With the U-100PZH2E5 on the PAW-20PAIRC-LS. Calculation method: Taking as consideration SCOP of the Panasonic combination of 6.0. If 100 is the energy needed for a air curtain, Panasonic Air curtain will need 1/(1-6)*100=20.

Electric Air Curtain

1 Newly designed to maximize performance
High Air volume upgraded 145% compared to conventional model (in the case of FY-3009U1).

2 Comprehensive product line up
1,5m wide model added in the line up.

3 Easier installation & maintenance
Simple structure for easy installation & maintenance.



		FY-3009U1	FY-3012U1	FY-3015U1
Width	mm	900	1200	1500
Voltage	V	220	220	220
Air volume	Hi / Lo m ³ /h	1100 / 920	1400 / 1270	2000 / 1800
Consumption	Hi / Lo W	76 / 70	94 / 85	131 / 110
Current	Hi / Lo A	0,35 / 0,32	0,43 / 0,40	0,59 / 0,50
Air speed	Hi / Lo m/s	10,50 / 8,50	9,50 / 8,00	10,50 / 9,50
Dimension	HxWxD mm	900x231,5x212	1200x231,5x212	1500x231,5x212
Weight	kg	12,0	14,5	18,0
Sound pressure	dB(A)	48,5 / 45,0	48,5 / 44,5	51,5 / 48,0

Air Handling Unit Kit 5,00-25,00kW for PACi. Compatible with R32 or R410A outdoor units



Panasonic AHU Kit, 5,00-25,00kW connected to PACi outdoor unit

The Air Handling Unit Kit has been developed to better meet customer demand: IP 65 Box in order to be installed outside, 0-10V demand control* and easy control by BMS

* Only available with PACi Elite, from 5kW to 25kW.

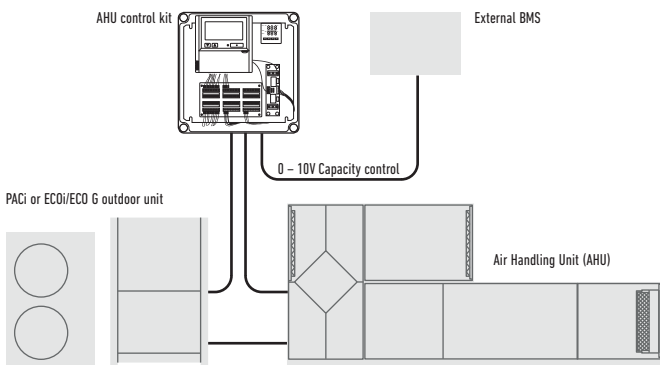

Demand control on the outdoor unit managed by external 0-10 V signal.

Control option 1: PAW-280PAH2L-1

- The system's control is simple: control of actual suction temperature vs. set point
- Control works in the same way as that of any indoor unit
- Fan signal issued by the PCB (OFF while defrosting, for instance)

Control option 2: PAW-280PAH2-1

- System control by probe located at air intake. Sensor works as a 0-10V control thermostat which manages the set point temperature. Control to prevent cold draughts.
- All signals as per standard

Control option 3: PAW-280PAH2-1

- System control by probe located at air intake. Sensor works as a 0-10V control thermostat which manages the set point temperature. Enhances efficiency by adjusting capacity to the ambient temperature and enhances comfort as well.
- All signals as per standard

Control option 4: PAW-280PAH2-1

- System control by a 0-10V control working from an external BMS that manages the set point for the temperature or the capacity. Enhances efficiency by adjusting capacity and enhances comfort as well.
- All signals as per standard

Main components of mechanical ventilation systems

The main components of a mechanical ventilation system are the following: Air Handling Unit (AHU), air ducts and air distribution elements.

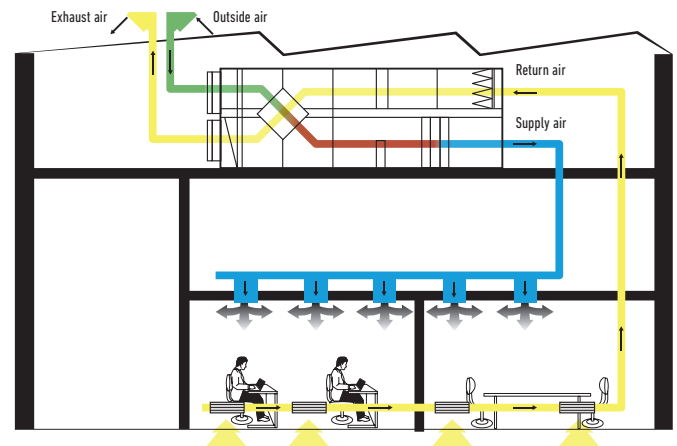

0-10V control

With the 0-10 v demand control the capacity of the outdoor unit can be controlled by 20 steps.

Input Voltage* (V)	0	1,0	1,5	2,0	2,5	3,0	3,5	4,0	4,5	5,0	5,5	6,0	6,5	7,0	7,5	8,0	8,5	9,0	9,5
Demand (% of nominal current)	No cut ¹⁾	40	45	50	55	60	65	70	75	80	85	90	95	100	105	110	115	120	No limit / Full capacity ³⁾
Indoor unit start / stop	Stop ¹⁾	Start																	

1) No cut/Stop: AHU system / indoor unit is completely switched OFF.

2) No Limit: No restrictions applied by BMS to AHU system / indoor unit performance (equivalent to "full-load operation" of AHU system / indoor unit).

AHU Kit connects PACi outdoor units to Air Handling Units system. The Panasonic AHU Kits offer a wealth of connectivity possibilities so can be easily integrated into many systems.

Application: Hotels, offices, server rooms or all large buildings where air quality control such as humidity control and fresh air and is needed.

3 types of AHU Kit: Deluxe, Medium and Light.

Model Code	IP 65	0-10V demand control*	Outdoor temperature shift compensation. Cold draft prevention
PAW-280PAH2-1	Yes	Yes	Yes
PAW-280PAH2M-1	Yes	Yes	No
PAW-280PAH2L-1	Yes	No	No

* With CZ-CAPBC2.

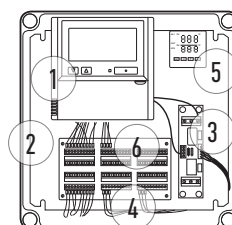

1. Remote control CZ-RTC4
2. New plastic IP 65 Box
3. PAW-T10 PCB for Dry Contact
4. 0-10V demand control PCB
5. Intelligent thermostat for:
 - Cold draft prevention
 - Outdoor temperature shift compensation
6. Terminal base for sensors and power supply

System & regulations. System overview

1. AHU Kit equipment (Field supplied)
2. AHU Kit system controller (Field supplied)
3. AHU Kit controller box (with control PCB)
4. Thermistor for Gas pipe (E2)
5. Thermistor for Liquid pipe (E1)
6. Thermistor for Suction air
7. Inter-unit wiring
8. Outdoor unit

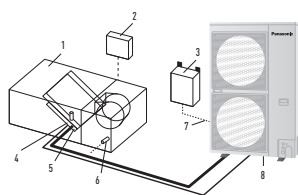

AHU Connection Kit

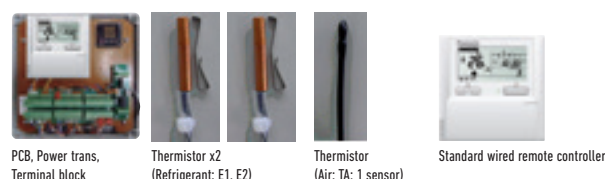

Optional parts: Following functions are available by using different control accessories:

CZ-RTC4 Timer remote controller.

- Operation-ON/OFF
- Mode select
- Temperature setting

* Fan operation signal can be taken from the PCB.

PAW-0CT, DC12 V outlet. OPTION terminal.

- Output signal= Cooling/Heating/Fan status
- Defrost
- Thermostat-ON

CZ-CAPBC2 Mini seri-para I/O unit (advanced version only).

- Easy integration in external AHU control systems and BMS
- Demand control: 40 to 115 % (5 % steps) of nominal current by 0-10 V input signal*
- Target temperature setting by 0-10 V or 0-140 Ω input signal*
- Mode select or/and ON/OFF control
- Fan operation control
- Operation status output/ Alarm output
- Thermostat ON/OFF control

* Demand control by external BMS cannot be combined with the demand control or target temperature setting accomplished by the thermostat. However, if simultaneous demand control and target temperature setting is needed, this can only be achieved by using a second (optional) CZ-CAPBC2 interface.

CZ-T10 terminal / PAW-T10 PCB to connect to T10 connector.

- A Dry contact PCB has been developed to easily control the unit
- Input signal operation ON/OFF
- Remote control prohibition
- Output signal Operation ON status maximum 230 V 5 A (NO/NC)
- Output signal alarm status max. 230 V 5 A (NO/NC)
- Alarm output (by DC12V)
- Additional available contacts:
 - External humidifier control (ON/OFF) 230 VAC 3 A
 - External fan control (ON/OFF) 12V DC
 - External filter status signal potential free
 - External float switch signal potential free
 - External leakage detection sensor or TH. OFF contact potential free (possible usage for external blow out temperature control)

AHU PACi Elite	Cooling capacity	Heating capacity	Dimensions	Piping length	Elevation difference (in/out)
	Nominal kW	Nominal kW	HxWxD mm	Min / Max m	Max m
PAW-280PAH2-1	6,00 / 25,00	7,00 / 28,00	404x425x78	5 / 30*	10
PAW-280PAH2-1+PAW-280PAH2-1	50,00	56,00	404x425x78	5 / 30*	10

* For U-200PE2E8A and U-250PE2E8A.

AHU connection kit / System combination	Air volume Min / Max m ³ /min	Dimensions HxWxD mm	Piping length Min / Max m	Elevation difference (in/out) Max m	Piping connections	
					Liquid pipe Inch (mm)	Gas pipe Inch (mm)
5,00kW	PAW-280PAH2-1	8,00 / 13,00	404x425x78	5/30	10	1/4 (6,35) / 1/2 (12,70)
6,00kW	PAW-280PAH2-1	9,00 / 16,00	404x425x78	5/30	10	3/8 (9,62) / 5/8 (15,88)
7,50kW	PAW-280PAH2-1	12,00 / 25,00	404x425x78	5/30	10	3/8 (9,62) / 5/8 (15,88)
10,00kW	PAW-280PAH2-1	14,00 / 33,00	404x425x78	5/30	10	3/8 (9,62) / 5/8 (15,88)
12,50kW	PAW-280PAH2-1	19,00 / 35,00	404x425x78	5/30	10	3/8 (9,62) / 5/8 (15,88)
14,00kW	PAW-280PAH2-1	19,00 / 35,00	404x425x78	5/30	10	3/8 (9,62) / 5/8 (15,88)
20,00kW	PAW-280PAH2-1	28,00 / 66,00	404x425x78	5/70	10	3/8 (9,62) / 1 (25,40)
25,00kW	PAW-280PAH2-1	38,00 / 74,00	404x425x78	5/70	10	1/2 (12,70) / 1 (25,40)

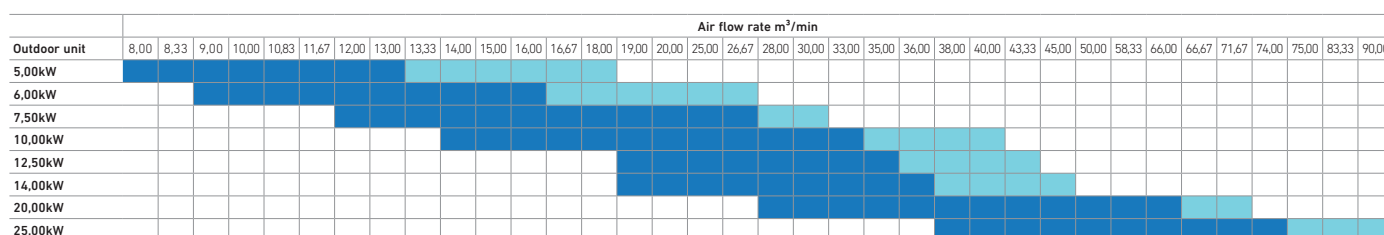

Standard range of air flow rate under standard conditions (air intake temperature in cooling mode from 18 to 32°C DB).

Extended range of air flow rate under special conditions (air intake temperature in cooling mode from 18 to 30°C DB).

Air Curtain with DX Coil, connected to the VRF or PACi Systems. Compatible with R32 or R410A outdoor units

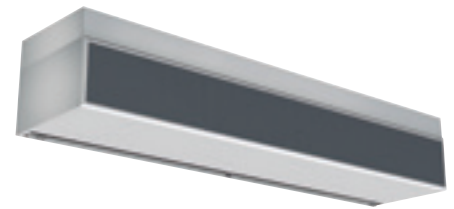

Highly efficient heating effect

The combined air stream, which has a desirable low air current induction factor (mixing factor), can carry the selected initial temperature effect over long distances, and will reach the floor area while still at room temperature. This is necessary to avoid cooling down the interior spaces. Available in different lengths to suit requirements between 1 and 2,5m, both air curtains have outlet grilles that can be adjusted to five different positions. The HS model can be installed up to a height of 3,0m with the LS model up to 2,7m. The outlet grilles can be easily adjusted into five positions to suit different installation requirements and the air filter can be accessed without the need for specialist tools.

- High performance with EC fan motor (40% lower running costs compared

- to a standard AC fan motor)
- Easy Cleaning and Servicing
- Can be connected to either Panasonic VRF or PACi systems
- Built-in drain for cooling operation
- HS and LS models can be controlled via Panasonic's range of remote internet controls

The new HS and LS models are ideal for connection to a ECOi or PACi system. With simple "plug and play" installation, both are fitted with an EC fan motor for a smooth operation and efficient performance. This fan guarantees 40% lower running cost than with a standard AC fan motor. Air curtains run approximately 12 hours per day at shops, and efficient performance contributes to energy savings.

Intelligent Operation

Our air curtains combine airflow and heating / cooling technology to ensure optimum comfort and energy efficiency whilst also creating an effective barrier between indoor and outdoor environments. Design and installation is key to achieving the correct height / temperature settings to achieve optimum performance. Our air curtains are designed to answer the demands of the retail, commercial and industrial markets.

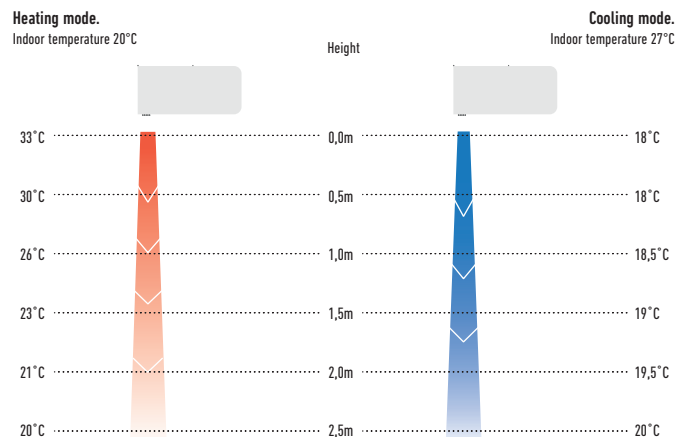

Optimised airflow velocity

1. Energy losses, no air curtain installed
2. Too low velocity air curtain – air curtain not efficient
3. Optimum results with the Frico air curtain connected to Panasonic VRF

4. Too high velocity air curtain – considerable turbulence, energy lost to the outside, air curtain not efficient

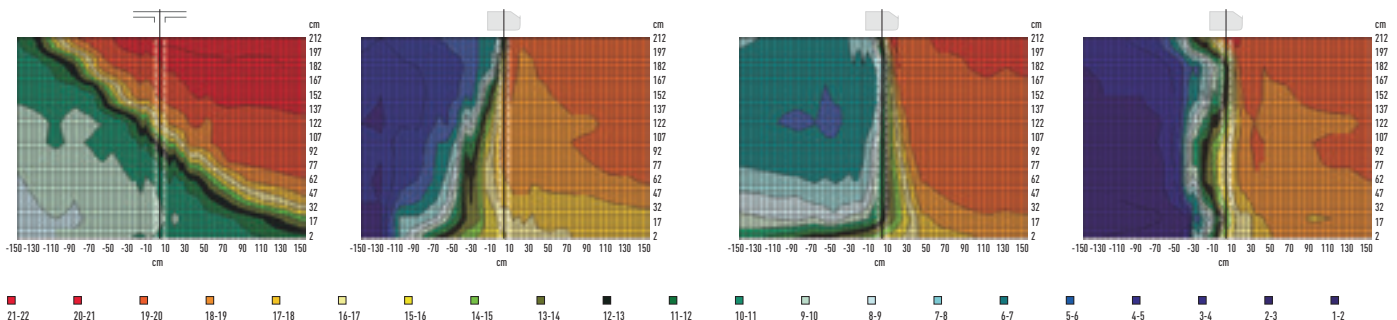

Opening without air curtain.

In an unprotected opening the cold air flows out and the cold storage room becomes much too warm.

Opening with air curtain, wrong angle.

If the angle is too small the hot air is blown into the cold storage room.

Opening with air curtain, too high speed.

Excessive speed creates turbulence, which causes energy loss and increases the cold storage temperature.

Opening with correctly adjusted air curtain.

With a correctly set air curtain unit there is a sharp separation between the different temperature zones.



High efficiency air curtain connected to your PACi or VRF installation. EC Fan motor for a smooth operation and an efficient performance. 2 types of air flow available: LS and HS! Easy installation, regulation, cleaning, service

Technical focus

- Save up to 40% energy costs by use of the integrated EC fan technology (higher efficiency than conventional AC fan, soft start and longer motor duration)
- 4 length of air curtain LS and HS are available 1,0, 1,5, 2,0 and 2,5m
- Installation height up to 3,0m
- Outlet grilles can be adjusted in five positions, to suite different indoor and installation requirements
- Control with Panasonic remote control systems (optional)
- Direct integration to BMS by optional Panasonic interfaces
- Trip dray included in all DX air curtain steps

Features

Comfort: Easy redirection of air flow by means of manual deflector.

Ease of use: Speed selector (high and low) on the unit itself.

Easy installation and maintenance: Easy installation. Compact dimensions improve installation and positioning. Easy cleaning of grid without opening of the unit.

How does it work?

Stale air from the room is taken in and ejected near the door. This creates a 'roll of air' that shields the door area, mixing with the colder incoming air. It then turns away from the door, back into the room and toward the intake screen, where it is partly drawn in again. This flow of air helps to create a barrier for heat loss yet at the same time refreshes room air

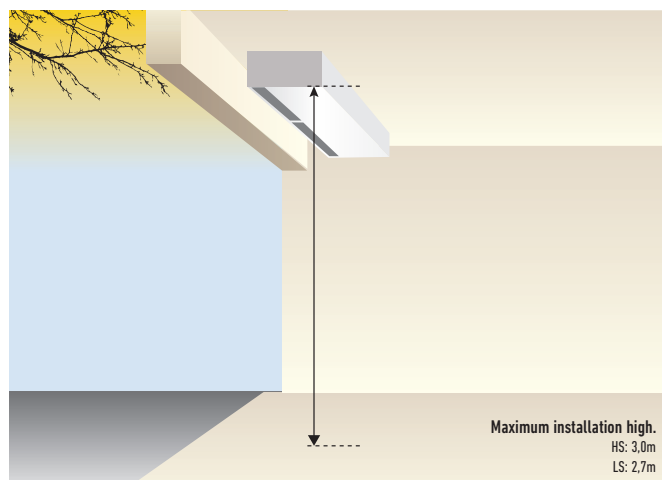

Outdoor units			7,10kW	10,00kW	14,00kW	20,00kW
Air outlet height 2,7m			PAW-10PAIRC-LS	PAW-15PAIRC-LS	PAW-20PAIRC-LS	PAW-25PAIRC-LS
Air volume	High / Low	m ³ /h	1800 / 1000	2700 / 1400	3600 / 1900	4500 / 2400
Cooling capacity ¹⁾	Max	kW	6,10	9,70	13,00	17,00
Heating capacity ²⁾	Max	kW	7,90	12,00	15,00	19,00
Heat Exchanger	Volume	L	1,67	2,85	3,94	5,03
Piping connections	Liquid pipe / Gas pipe	mm	16,6 / 15,0	16,6 / 22,0	16,6 / 22,0	16,6 / 22,0
Electric consumption fan	230V / 50Hz	kW	0,30	0,50	0,60	0,80
Fan type			EC	EC	EC	EC
Currency	230V / 50Hz	A	2,10	3,10	4,10	5,10
Sound Pressure ³⁾		dB(A)	49 / 65	48 / 66	50 / 67	51 / 69
Dimension	H x W x D	mm	1000 x 260 x 460	1500 x 260 x 460	2000 x 260 x 460	2500 x 260 x 460
Weight		kg	50	65	80	95
Door width		m	1,0	1,5	2,0	2,5
Refrigerant			R32 / R410A	R32 / R410A	R32 / R410A	R32 / R410A

Outdoor units			10,00kW	14,00kW	20,00kW	25,00kW
Air outlet height 3,0m			PAW-10PAIRC-HS	PAW-15PAIRC-HS	PAW-20PAIRC-HS	PAW-25PAIRC-HS
Air volume	High / Low	m ³ /h	2700 / 1450	3600 / 1900	5400 / 2900	6300 / 3400
Cooling capacity ¹⁾	Max	kW	9,10	13,00	19,50	23,70
Heating capacity ²⁾	Max	kW	11,80	15,80	23,60	27,60
Heat Exchanger	Volume	L	1,67	2,85	3,94	5,12
Piping connections	Liquid pipe / Gas pipe	mm	16,6 / 15,0	16,6 / 22,0	16,6 / 22,0	16,6 / 22,0
Electric consumption fan	230V / 50Hz	kW	0,75	1,00	1,50	1,75
Fan type			EC	EC	EC	EC
Currency	230V / 50Hz	A	4,10	5,50	8,20	9,60
Sound Pressure ³⁾		dB(A)	50 / 66	49 / 67	51 / 68	52 / 68
Dimension	H x W x D	mm	1000 x 260 x 460	1500 x 260 x 460	2000 x 260 x 460	2500 x 260 x 460
Weight		kg	55	65	85	110
Door width		m	1,0	1,5	2,0	2,5
Refrigerant			R32 / R410A	R32 / R410A	R32 / R410A	R32 / R410A

1) Cooling capacity DX Coil, air temperature in/out +27/+18°C, R32 and R410. 2) Heating capacity condenser, air temperature in/out +20/+33°C, R32 and R410. In the case of lower outdoor temperatures, an outdoor model with higher capacity may be necessary. 3) Measured in distance up to 5,0m, direction factor 2, absorbing surfaces 200m², Min / Max air volume.



Rated Conditions Cooling Outdoor +35°C DB Indoor +27°C DB/+19°C WB, Discharge temperature * 16°C. All combinations under rated conditions: Heating Outdoor +7°C DB/+6°C WB Indoor +20°C DB. In case of lower outdoor temperatures a higher capacity outdoor unit model may be necessary. Specifications subject to change without notice. For detailed information about ERP, please visit our websites www.aircon.panasonic.eu or www.ptc.panasonic.eu.

PANASONIC PACi ELITE CAN COOL ROOMS DOWN TO 8°C

Special application such as wine cellars.



Solutions for cold rooms. Set the room temperature to 8°C

There is a complete range, from 3,60 to 22,00kW. This unique solution is perfect for:

Wine cellars, ice cream factories, flower shops, supermarkets, grain stores, food storage, food processing, food distribution, lunchrooms, vegetable processing... Just like all the indoor units in the PACi range, these units can be monitored via the Internet, generating an alarm if there is a breakdown.



Alternative controller.
Wired remote control.
CZ-RTC5B

Wide range of indoor units.
To meet your company's needs

PACi outdoor unit.
PACi, the next generation of developed commercial air conditioning, with an energy-saving concept. The use of energy-saving designs in the construction of fans, fan motors, compressors and heat exchangers has resulted in a high COP value.

COOLING ROOMS BETWEEN 8°C WB AND 24°C WB

Wine cellars and special low temperature rooms

One of the main features of the PACi series is the possibility of adjusting the product for special applications, not just for regular heating and cooling applications. The purpose of this product information is to explain in detail these special applications that need a cooling operation to maintain the room temperature at +8 ~ +24°C WB (or +10 ~ +30°C DB). In order to do this in terms of enthalpy, the indoor unit needs to be overdimensioned and certain parameters need to be adjustable.

Temperature range – temperature range for wine cellar

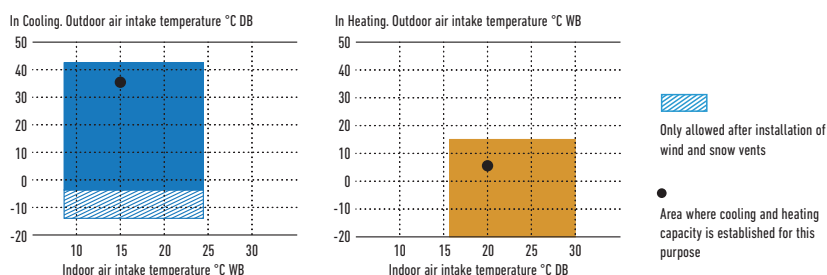

Temperature range for wine cellar

	Indoor	Outdoor
Cooling operation	+8 ~ +24°C WB	-5 (-15) ~ -43°C DB

Examples of installations:

To avoid the growth of bacteria and to increase food safety: Wine cellars, ice cream factories, flower shops, broiler factories, pantries in hotels, supermarkets, grain stores, food storage, food processing, food distribution, lunchrooms, salad processing ...

Application	Single						Twin		
	3,50kW	4,90kW	5,80kW	6,90kW	9,30kW	11,60kW	13,60kW	18,50kW	23,20kW
Cooling capacity	U-36PZH2E5	U-50PZH2E5	U-60PZH2E5	U-71PZH2E5 U-71PZH2E8	U-100PZH2E5 U-100PZH2E8	U-125PZH2E5 U-125PZH2E8	U-140PZH2E5 U-140PZH2E8	U-200PZH2E8	U-250PZH2E8
PACi outdoor units									
PACi indoor units									
	S-60PU2E5B	S-71PU2E5B	S-100PU2E5B	S-125PU2E5B	S-140PU2E5B	S-140PU2E5B	S-100PU2E5B + S-100PU2E5B	S-125PU2E5B + S-125PU2E5B	S-140PU2E5B + S-140PU2E5B
	S-60PT2E5B	S-71PT2E5B	S-100PT2E5B	S-125PT2E5B	S-140PT2E5B	S-140PT2E5B	S-100PT2E5B + S-100PT2E5B	S-125PT2E5B + S-125PT2E5B	S-140PT2E5B + S-140PT2E5B
	S-60PF1E5B	S-71PF1E5B	S-100PF1E5B	S-125PF1E5B	S-140PF1E5B	S-140PF1E5B	S-100PF1E5B + S-100PF1E5B	S-125PF1E5B + S-125PF1E5B	S-140PF1E5B + S-140PF1E5B
	S-60PN1E5B	S-71PN1E5B	S-100PN1E5B	S-125PN1E5B	S-140PN1E5B	S-140PN1E5B	S-100PN1E5B + S-100PN1E5B	S-125PN1E5B + S-125PN1E5B	S-140PN1E5B + S-140PN1E5B

* Above combinations require a special field setting. Please contact authorized Panasonic dealer. ** R410 models (U-PE2E5A, U-PE2E8A) are also compatible.

R22 RENEWAL. FAST, EASY TO INSTALL AND COST EFFECTIVE



An important drive to further reduce the potential damage to our ozone
It is often said that legislation is ruling our lives but sometimes it is there to help save
lives. R22 phase out can be described as one of these and from Jan 1st 2010 the use of
Virgin (new) R22 refrigerant was banned within the European Union.

Panasonic is doing its part

We at Panasonic are also doing our part – recognising that all finances are under pressure at the moment. Panasonic has developed a clean and cost effective solution to enable this latest legislation to offer less financial impact on your business.

The Panasonic renewal system allows good quality existing R22 pipe work to be re-used whilst installing new high efficiency R410A / R32 systems. By bringing a simple solution to the problem Panasonic can renew all Split Systems and PACi systems; and depending upon certain restrictions we don't even limit the manufacturer's equipment we are replacing. By installing a new high efficiency Panasonic R410A / R32 system you can benefit from around 30% running cost saving compared to the R22 system.

Yes...

1. Check the capacity of the system you wish to replace
2. Select from the Panasonic range the best system to replace it with
3. Follow the procedure detailed in the brochure and technical data Simple...



Why renewal?

Unique R22 Renewal from Panasonic: Fast, easy to install and cost effective.

- Panasonic refrigerant oil doesn't react to the most common oil types used in air-conditioning systems. This ensures the mix of oil does not damage the units. Therefore installations are easier

- All Panasonic PACi units can be installed in R22 pipings, no specific models are available
- Up to 33 Bar! When there is any doubt about the strength of the piping, the maximum working pressure can be reduced to 33 Bar with a setting in the software of the outdoor unit

Reuse of existing piping (renewal design & installation)

Notes on reuse of existing refrigerant piping.

It is possible for each series of PE, PEY, PZH, PZ series outdoor unit to reuse the existing refrigerant piping without cleaning when obtained under certain conditions. Make sure that the requirements under the section "Notes on reuse of existing refrigerant piping", "Measurement procedure for renewal" and "Refrigerant piping size and allowable piping length" will be satisfied in order to carry out.

Also, check the items with regard to section "Safety" and "Cleaning".

1. Prerequisite

- If the refrigerant used for the existing unit is other than R22, R407C and R410A / R32, the existing refrigerant piping cannot be used.
- If the existing unit has another use than air conditioning, then existing refrigerant piping cannot be used.

2. Safety

- If there is a hollow, crack or corrosion on the piping, make sure to install new piping.
- If the existing piping is other than capable of reuse of piping as shown in the flowchart, make sure to install new piping.
- In case of multiple operation, use our genuine branch piping for refrigerant R410A / R32.

A local supplier shall assume responsibility for the defects and hollows on the reuse of existing piping surface and recognition of reliability of the piping strength. There is no guarantee that we take responsibility for such damages.
The operational pressure of the refrigerant R410A / R32 becomes higher compared to R22. In the worst case, a lack of compressive strength may lead to piping explosion.

3. Cleaning

- When the refrigerant oil used for the existing unit is other than the listed below, make sure to install new piping or wash it thoroughly before reusing it.
[Mineral Oil] SUNISO, FIORE S, MS
[Synthesized oil] alkyl benzene oil (HAB, parallel freeze), ester oil, ether oil (PVE only)

If the existing unit is GHP type, it is necessary to wash the piping thoroughly.

- If the existing pipes in the outdoor and indoor units remain disconnected, make sure to install a new piping or wash it thoroughly before reusing it.
- If the discoloured oil or residue remains in the existing piping, make sure to install a new piping or wash it thoroughly before reusing it. See "Deterioration Criteria for Refrigerant Oil" in table 3.
- If the compressor of the existing air conditioner has a failure history, make sure to install a new piping or wash it through thoroughly before reusing it.

When reusing the existing piping as it is without removing dirt and dust, inadequate piping could result a renewal appliance in failure.

Notes on renewal for simultaneous operation of multiple units

Only main pipe is applicable for using the different diameter size.
 In case of different diameter size for the branch pipes, a new installation work for a standard size is necessary.
 Be sure to use our genuine branch piping for refrigerant R410A / R32.

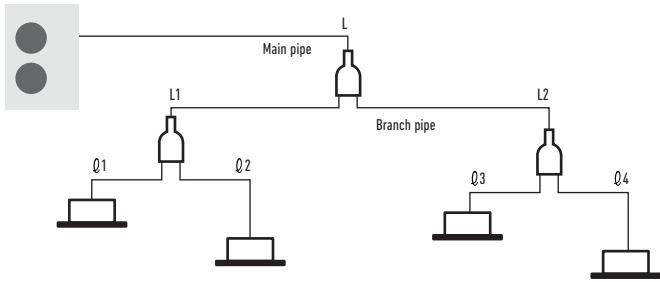

Capacity class	Standard liquid pipe size	Standard gas pipe size
Type 50	Ø 6,35	Ø 12,70
Type from 60 to 140	Ø 9,52	Ø 15,88
Type 200	Ø 9,52	Ø 25,40
Type 250	Ø 12,70	

- Only the main pipe L can be used among different diameter's existing piping
- Installation work as a standard size is capable for L1, L2, l1 - l4 piping
- Be sure to use our genuine branch piping for refrigerant R410A / R32

1. In case of single unit:
 It is not necessary to charge with additional refrigerant until the chargeless pipe length in the table 2.
 If the pipe length is exceeding the charge less pipe length, charge with additional refrigerant amount per 1m according to the equivalent length.
2. In case of simultaneous operation of multiple units:
 Calculate the refrigerant charging amount according to the calculating method of the standard piping diameter.
 As to the additional refrigerant charging amount per 1m, refer to the additional amount in the table 2.

Measurement procedure for Renewal

Observe the following procedure when reusing the existing piping or carrying out renewal installation work.
 Flowchart of existing piping measures criteria for PE, PEY, PZH, PZ series outdoor unit.

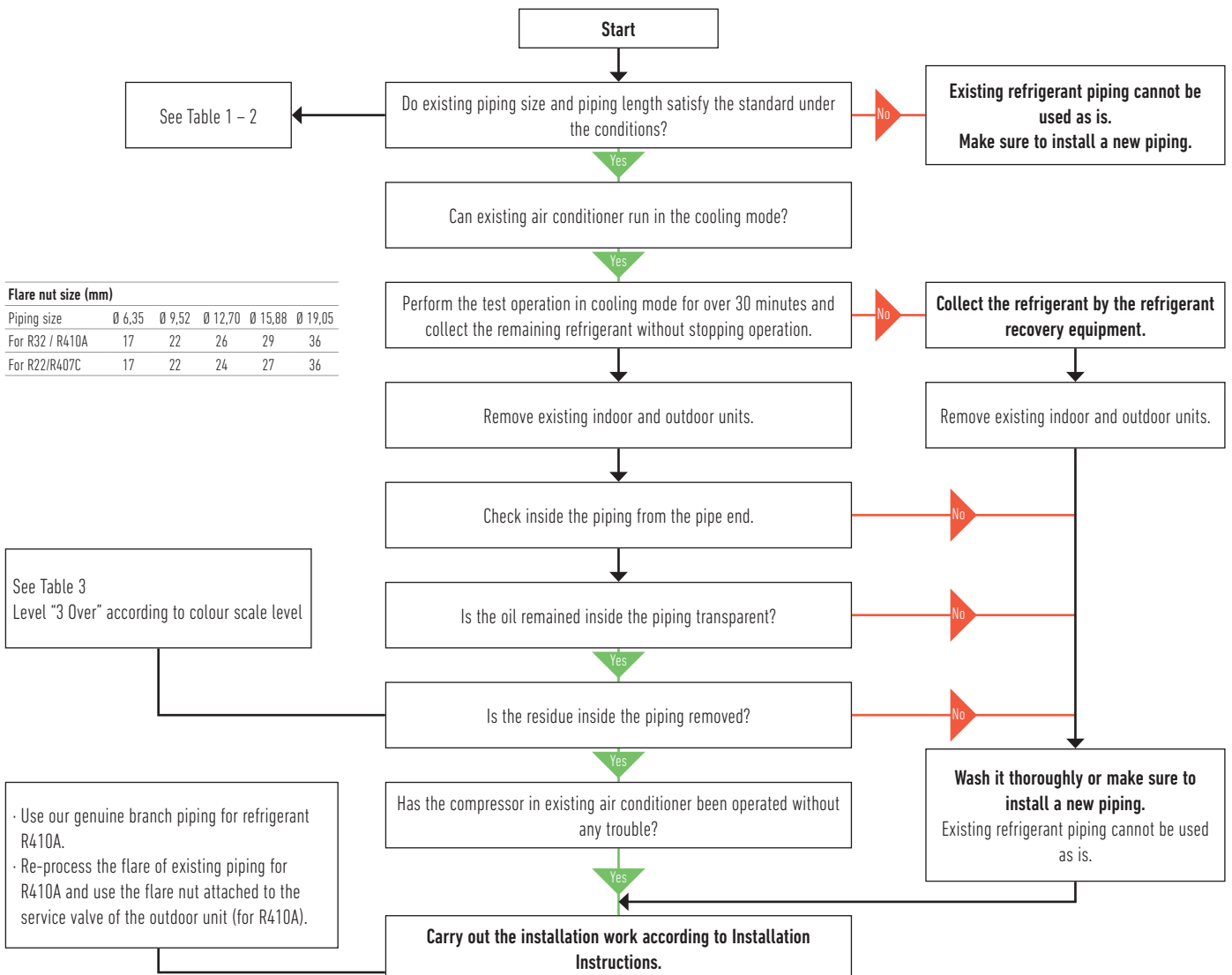

Flare nut size (mm)					
Piping size	Ø 6,35	Ø 9,52	Ø 12,70	Ø 15,88	Ø 19,05
For R32 / R410A	17	22	26	29	36
For R22/R407C	17	22	24	27	36

See Table 3
 Level "3 Over" according to colour scale level

· Use our genuine branch piping for refrigerant R410A.
 · Re-process the flare of existing piping for R410A and use the flare nut attached to the service valve of the outdoor unit (for R410A).

Refrigerant piping size and allowable piping length

Check if reuse of existing refrigerant piping is possible based on the following chart.

The standards other than this one (difference of elevation, etc.) are identical to the requirements of ordinary refrigerant piping.

Table 1 Reusable existing piping (mm)

Material	0				1/2 H, H*			
External diameter	Ø 6,35	Ø 9,52	Ø 12,70	Ø 15,88	Ø 19,05	Ø 22,22	Ø 25,40	Ø 28,58
Thickness	0,80	0,80	0,80	1,00	1,00	1,00	1,00	1,00

* It is impossible to reuse the size of Ø 19.05, Ø 22.22, Ø 25.4 and Ø 28.58 for material 0. Change to material 1/2H or material H.

Table 2 - 1 Refrigerant piping size: 3,6 – 14,0 kW type (mm)

Liquid pipe		Ø 6,35			Ø 9,52			Ø 12,70	
Gas pipe		Ø 9,52	Ø 12,70	Ø 15,88	Ø 12,70	Ø 15,88	Ø 19,05	Ø 15,88	Ø 19,05
PE / PZH	Type 50	✗	Standard 40 m (30 m)	⊙ 40 m (30 m)	□ 20 m (15 m)	□ 20 m (15 m)	✗	✗	✗
	Type 60 Type 71	✗	▽ 10 m (10 m)	□ 10 m (10 m)	▽ 30 m (20 m)	Standard 50 m (20 m)	✗	□ 25 m (10 m)	✗
Additional refrigerant charging amount per 1 m		20 g/m			40 g/m			80 g/m	
PZH	Type 60 Type 71	✗	▽ 10 m (10 m)	□ 10 m (10 m)	▽ 30 m (30 m)	Standard 50 m (30 m)	✗	□ 25 m (15 m)	✗
	Type 100 Type 125 Type 140	✗	✗	✗	✗	Standard 75 m (30 m)	⊙ 75 m (30 m)	□ 35 m (15 m)	□ 35 m (15 m)
	Type 100 Type 125 Type 140	✗	✗	✗	✗	Standard 50 m (30 m)	⊙ 50 m (30 m)	□ 25 m (15 m)	□ 25 m (15 m)
Additional refrigerant charging amount per 1 m		20 g/m			50 g/m			80 g/m	

How to see table definition (example):

In case of type 71, standard size is liquid pipe Ø 9,52 / gas pipe Ø 15,88,

There is a limitation to liquid pipe Ø 9,52 / gas pipe Ø 12,70 and to liquid pipe Ø 12,70 / gas pipe Ø 15,88,

However, they are applicable for different diameter's pipes.

Table 2 - 2 Refrigerant piping size: 20,0 - 25,0 kW type (mm)

Liquid pipe		Ø 9,52			Ø 12,70			Ø 15,88		
Gas pipe		Ø 22,22	Ø 25,40	Ø 28,58	Ø 22,22	Ø 25,40	Ø 28,58	Ø 22,22	Ø 25,40	Ø 28,58
PE	Type 200	▽ 80 m (30 m)	Standard 100 m (30 m)	⊙ 100 m (30 m)	▽ 50 m (15 m)	□ 50 m (15 m)	□ 50 m (15 m)	✗	✗	✗
	Type 250	✗	✗	✗	▽ 80 m (30 m)	Standard 100 m (30 m)	⊙ 100 m (30 m)	▽ 65 m (20 m)	□ 65 m (20 m)	□ 65 m (20 m)
Additional refrigerant charging amount per 1 m		40 g/m			80 g/m			120 g/m		

- ⊙ Allowable
- ▽ Cooling capacity down
- Limited piping length
- ✗ Unallowable
- 50 m Maximum piping length
- (50 m) Charge less piping length in a single connection

Table 3 Deterioration Criteria for Refrigerant Oil

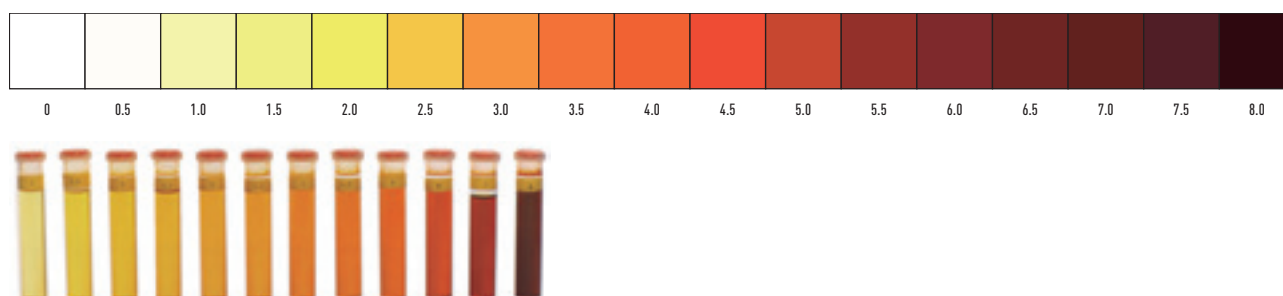

ACCESSORIES AND CONTROL

Branch Pipes, Header



CZ-P224BK2BM
Branch pipe (Capacity after distribution is 22,40kW or less).



CZ-P680BK2BM
Branch pipe (from 22,40kW to 68kW).

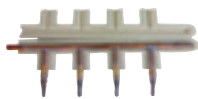

CZ-P3HPC2BM
Header.

Plenums

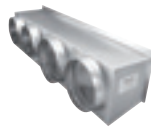

CZ-DUMPA90MF2
Air Inlet Plenum S...PF1E5B 60 & 71.

CZ-DUMPA160MF2
Air Inlet Plenum S...PF1E5B 100, 125 & 140.

CZ-56DAF2
Air Outlet Plenum S...PF1E5B 36, 45 & 50.

CZ-90DAF2
Air Outlet Plenum S...PF1E5B 60 & 71.

CZ-160DAF2
Air Outlet Plenum S...PF1E5B 100, 125 & 140.

CZ-TREMIESPW705
Air Outlet Plenum S-200PE2E5.

CZ-TREMIESPW706
Air Outlet Plenum S-250PE2E5.

Outdoor accessories

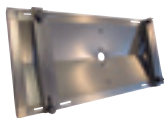

PAW-WTRAY
Tray for condenser water compatible with base ground support.



PAW-GRDSTD40
Outdoor elevation platform 400x900x400mm.



PAW-GRDBSE20
Outdoor base ground support for noise and vibration absorption (600 x 95 x 130mm, 500kg).

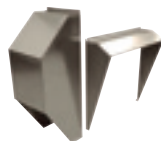

PAW-WPH9
Wind protection shield for U-71PZH2E5/8, U-71PE1E5A/8A and U-100/125PEY1E5/8.



PAW-WPH7
Wind protection shield for U-100/125/140PZH2E5/8, U-100/125/140PE1E5A/8A and U-140PEY1E8.

Panels



CZ-KPU3W
Normal panel for 90x90 Cassette PU2.



CZ-KPU3AW
Econavi panel for 90x90 Cassette PU2.



CZ-KPY3AW
Panel for 60x60 Cassette size 700x700mm.



CZ-KPY3BW
Panel for 60x60 Cassette size 625x625mm.



CZ-CNEXU1
nanoE™ X air purifying system for 90x90 Cassette PU2.



CZ-CENSC1
Econavi energy savings sensor.

Other Accessory

Individual Controls



CZ-RTC5B
Design wired remote controller with Econavi function and datanavi.



CZ-RWS3 + CZ-RWRU3
Infrared remote controller for 4 Way 90x90 Cassette.



CZ-RWS3
Infrared remote controller for Wall Mounted and 4 Way 60x60 (with CZ-KPY3AW).



CZ-RWS3 + CZ-RWRT3
Infrared remote controller for Ceiling.



CZ-RWS3 + CZ-RWRC3
Infrared remote controller for all indoor units.



CZ-RE2C2
Simplified wired remote controller.



CZ-CSRC3
Temperature remote sensor.

Controller and touch controllers for Hotels with Dry Contacts



PAW-RE2C3-WH-1
Stand-Alone with I/O, White.



PAW-RE2C4-MOD-WH
NEW Modbus RS-485 touch room controller with I/O, White.

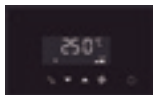

PAW-RE2D4-WH
NEW Touch display control with 2 inputs, White.

PAW-RE2C3-MOD-WH-1
Modbus RS-485 with I/O, White.

PAW-RE2C4-MOD-BK
NEW Modbus RS-485 touch room controller with I/O, Black.

PAW-RE2D4-BK
NEW Touch display control with 2 inputs, Black.

Hotel sensors for Dry Contacts



PAW-WMS-DC
NEW Wall motion sensor 24V.



PAW-CMS-DC
NEW Ceiling motion sensor 24V.



PAW-24DC
NEW Power supply 24V.



PAW-DWC
NEW Door or window contact.

PAW-WMS-AC
NEW Wall motion sensor AC.

PAW-CMS-AC
NEW Ceiling motion sensor AC.

Centralised Controls



CZ-64ESMC3
System Controller with Schedule timer. Operation with various function from center station.



CZ-ANC3
Central ON/OFF controller, up to 16 groups, 64 indoor units.



CZ-256ESMC3
Simplified load distribution ratio (LDR) for each tenant. Intelligent Controller (Touch screen panel).

Centralised Controls. BMS System. PC Base



CZ-CSWK2

PAIMS Basic software.

CZ-CSWAC2

PAIMS Consumption calculation control.

CZ-CSW6C2

PAIMS - Layout display.

CZ-CAPDC2

Serial parallel device controlling outdoor units, up to 4 units.

CZ-CAPC3

Adaptor for ON/OFF control of external devices.

CZ-CAPBC2

Mini series parallel device controlling indoor units, maximum 1 group and 8 indoor unit.

CZ-CFUNC2

Communication Adaptor. Up to 128 groups. Controls 128 units.

CZ-CFUNC2

Communication adaptor.

CZ-CSWBC2

PAIMS - BACnet interface.

CZ-CSWWC2

PAIMS - Web application.



VRF Smart Connectivity



SER8150R0B1194

Remote Controller
Panasonic Net Con, RH, No PIR, R1/R2.

SER8150R5B1194

Remote Controller
Panasonic Net Con, RH, PIR, R1/R2.

VC8000V5094P

Wireless Zigbee Pro module / Green Com card.

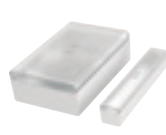

SED-WDC-G-5045

Door / window wireless sensor.



SED-MTH-G-5045

Wall / ceiling (motion) wireless sensor.



SED-CO2-G-5045

CO₂ sensor.



SED-TRH-G-5045

Sensor with room temperature and humidity.

Accessories Interfaces



PA-RC2-WIFI-1

Interface for Intesishome for PACi and ECOi.



PAW-RC2-KNX-1i

KNX Interface.



PAW-RC2-MBS-4

Modbus interface to control 4 indoor/groups.



PAW-RC2-MBS-1

Modbus Interface.



PAW-MBS-TCP2RTU

Modbus RTU Slave devices.



PAW-RC2-BAC-1

BACnet Interface.



CZ-CAPRA1

Domestic with CN-CNT port integration to PACi and ECOi.



CZ-CAPWFC1

NEW Commercial WLAN Adaptor.



PAW-AC2-MBS-16P

NEW Modbus Interface for 16 indoors.

PAW-AC2-MBS-64P

NEW Modbus Interface for 64 indoors.

PAW-AC2-MBS-128P

NEW Modbus Interface for 128 indoors.

PAW-AC2-KNX-16P

NEW KNX Interface for 16 indoors.

PAW-AC2-KNX-64P

NEW KNX Interface for 64 indoors.

PAW-AC2-BAC-16P

NEW BACnet Interface for 16 indoors.

PAW-AC2-BAC-64P

NEW BACnet Interface for 64 indoors.

PAW-AC2-BAC-128P

NEW BACnet Interface for 128 indoors.



Panasonic AC Smart Cloud



CZ-CFUSCC1

Panasonic AC Smart Cloud. Cloud internet control. Up to 128 groups. Controls 128 units.

PAW-MVNOAC-V

PAW-MVNOAC-K
3G communication package (SIM Card included). V, K: Depending on countries.

Accessories PCB



PAW-T10

All T10 functions.



PAW-PACR3

Redundancy of 2 or 3 systems; for PACi and ECOi.



PAW-SERVER-PKEA

Redundancy of 2 units TKEA / PKEA.

Accessories Cables



CZ-T10

Cable for all the T10 functions.



PAW-FDC

Cable to operate external EC fan.



PAW-OCT

Cable for all option monitoring signals.

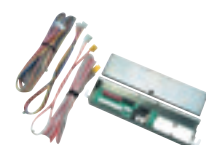

PAW-EXCT

Cable with force Thermo OFF/leakage Detection.

CZ-CAPE2

Option monitoring signals wo. Fan.

A photograph of a modern, multi-story building with a glass and metal facade, situated on a waterfront. The building's reflection is clearly visible in the calm water in the foreground. The sky is a deep blue with some light clouds, suggesting a dusk or dawn setting. The building has a curved, cylindrical section on the right side and a more rectangular section on the left. The overall scene is serene and architectural.

INDUSTRIAL VRF SYSTEMS



Professional solutions for all types of projects.
The new Panasonic VRF System is specifically designed for energy saving, easy installation and high efficiency performance, with a wide choice of outdoor and indoor unit models and unique features which are designed for the most demanding offices and big buildings.

VRF HIGHLIGHTED FEATURES



Panasonic provides an extensive range of solutions for medium-sized and large buildings. Combining the best option to satisfy all needs and site restrictions.



Uniquely, you can choose from both Electrical VRF and Gas-powered VRF systems from Panasonic, delivering best choice that really makes a difference to our customers.

Providing a large choice in indoor units, you can also connect water heat exchangers, air handling units and ventilation units with or without a heat exchanger. And all managed from a simple and powerful stand-alone remote control, new centralised controls or cloud connection with 3G embedded. This cutting edge control technology is called VRF Smart Connectivity, combining the expertise of VRF communication and a leading BEMS company to maximise comfort and efficiency while also reducing installation costs.

	ECOi. Electrical VRF			ECO G. Gas Powered VRF	
	2-Pipe Mini ECOi	2-Pipe ECOi EX	3-Pipe ECOi EX	2-Pipe ECO G GE3	3-Pipe ECO G GF3
Capacity range	4-10HP	8-80HP	8-48HP	16-60HP	16-25HP
Extreme temperatures operation	-20°C	-25°C	-20°C	-21°C	-21°C
Number of indoor units	15	64	52	64	24
Simultaneity ratio	50 ~ 130%	200%	150%	—	50 ~ 200%
Indoor units	All (check restrictions)				
Controls	All				
Other ranges integration	PACi full control integration + Domestic integration by accessory				

Energy saving



Inverter Plus.
The Inverter range provides greater efficiency, more comfort, more precise temperature control, without highs and lows, and keeps the ambient temperature constant with lower energy consumption and a significant reduction in noise and vibration levels.



All inverter compressors.
Multiple large-capacity all inverter compressors (more than 14HP). Two independently controlled inverter compressors achieve high efficiency. Redesigned components in the body provide performance improvement especially in the rated cooling condition and EER performance.



Econavi.
Intelligent Human Activity Sensor and new Sunlight Sensor technologies that can detect and reduce waste by optimising air conditioner operation according to room conditions. With just one touch of a button, you can save energy.



Gas powered.
ECO G technology offers the best in energy efficiency. ECO G gas VRF is specially designed for buildings where the electricity is restricted or CO₂ emissions must be reduced.



High COP.
High efficiency models performs higher COP than standard units and standard combinations.

High performance

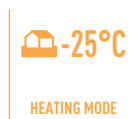

Down to -25°C in heating mode.
The ECOi EX system works in heating mode with performance data at outdoor temperature down to -25°C.



Cooling with outdoor temperature up to 52°C.
The ECOi EX system works in cooling mode with performance data at outdoor temperature up to 52°C.

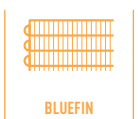

Bluefin.
Panasonic has extended the life of its condensers with an original anti-rust coating.



Self-diagnosing function.
By using electronic control valves past warnings are stored. This makes it easier to diagnose malfunctions, reducing service labour and therefore costs.



Automatic fan operation.
Convenient microprocessor control automatically adjusts fan speed to High, Medium or Low, corresponding to room sensor and maintains comfortable airflow throughout the room.



Mild Dry
By intermittent control of compressor and indoor unit's fan, "Mild Dry" gives you comfort. It realizes efficient dehumidification according to room temperature.

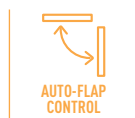

Comfortable auto-flap control.
When the unit is first turned on, flap position is automatically adjusted in accordance with the cooling or heating operation.



Automatic restart.
Automatic restart function for power failure. Even when power failure occurs, preset programmed operation can be reactivated once power is resumed.



Air Sweep.
The air sweep function moves the flap up and down in the air outlet, directing air in a "sweeping" motion around the room and providing comfort in every corner.



Built-in drain pump.
Maximum head 50cm (or 75cm for U type) from the bottom of the unit.



R22 renewal.
The Panasonic renewal system allows good quality existing R22 pipe work to be re-used whilst installing new high efficiency R410A systems.



5 Years Warranty.
We guarantee the outdoor unit compressors for five years.

High connectivity



Panasonic AC Smart Cloud.
The AC Smart Cloud from Panasonic allows you to have complete control of all your installations. In a simple click, receive status updates from all your units in real-time, preventing breakdowns and optimizing costs.



Internet Control.
A next generation system providing a user-friendly remote controller of air conditioning or heat pump units from everywhere, using a simple Android or iOS smartphone, tablet or PC via internet.



BMS connectivity.
The communication port can be integrated into the indoor unit and provides easy connection to, and control of, your Panasonic heat pump to your home or building management system.

PANASONIC: DELIVERING TOP ENERGY EFFICIENCIES FOR MANY YEARS



Particularly suitable for retail, hotels and office applications

Outstanding efficiency at part load conditions:

Panasonic ECOi EX model covers up to 30% part load with extremely high efficiency.

Load %	100%	80%	60%	50%	40%	30%
18HP High Efficiency model	4,54	5,30	6,37	7,12	8,23	6,93
18HP Space saving model	3,38	3,97	4,75	5,25	5,13	4,97

Conditions: Outdoor temperature 35°C DB, Room temperature 19°C WB.

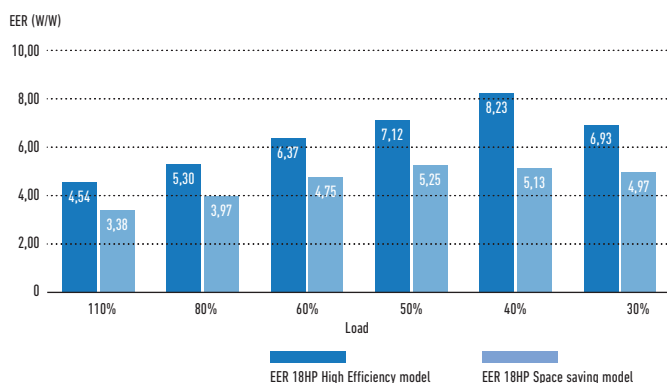

* Data from Panasonic official technical data book.

Load %	100%	80%	60%	50%	40%	30%
18HP High Efficiency model	3,89	5,42	6,90	6,94	6,59	6,11
18HP Space saving model	3,43	4,90	6,36	6,59	6,33	5,92

Conditions: Outdoor temperature 0°C WB, Room temperature 20°C DB.

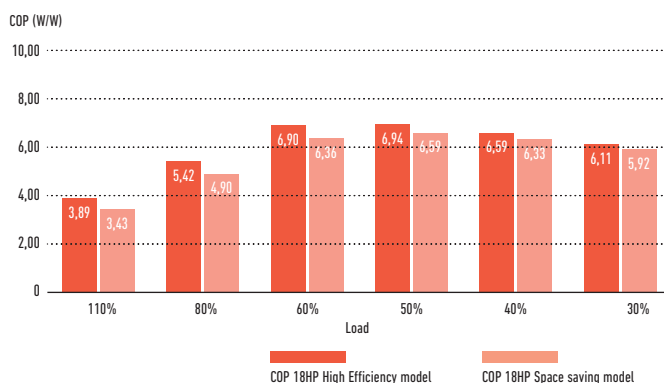

Excellent SEER and SCOP values for VRF 2 and 3-Pipe

Panasonic have a extremely high SEER and SCOP values following LOT21 (seasonal space cooling/heating energy efficiency by COMMISSION REGULATION (EU) 2016/2281).

	Mini ECOi					2-Pipe								3-Pipe				
	4HP	5HP	6HP	8HP	10HP	8HP	10HP	12HP	14HP	16HP	18HP	20HP	8HP	10HP	12HP	14HP	16HP	
SEER	7,85	7,48	7,25	6,27	6,37	7,43	6,83	6,65	7,23	6,43	7,56	7,03	7,02	7,05	6,39	6,69	6,02	
SCOP	4,87	4,40	4,24	4,24	4,31	4,79	4,26	4,72	4,28	4,05	4,29	4,09	4,85	4,25	4,27	4,13	3,81	

Efficient defrost operation

Panasonic uses the second unit to defrost the first unit. This makes the system more efficient during defrost and does not affect comfort.

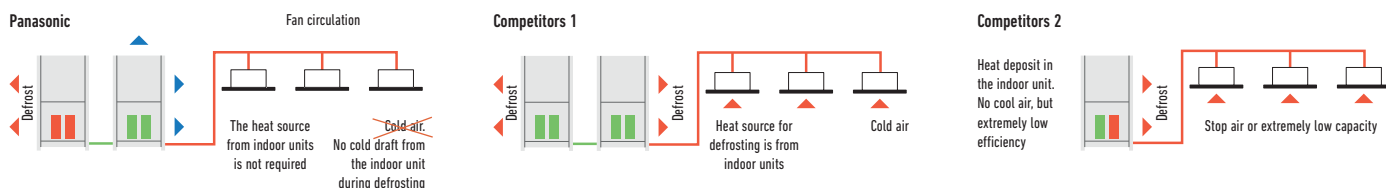

Panasonic ECOi operates at as low as -25°C

This unique feature demonstrate the supremacy of Panasonic ECOi EX Series.

Panasonic use the second unit to defrost the first unit. This makes the system more efficient during defrost and does not affect the comfort.

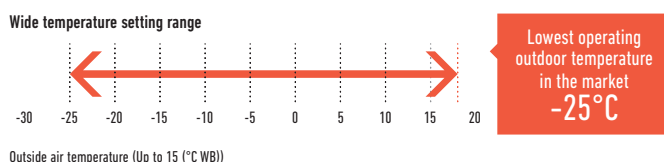

PANASONIC VRF: TOP IN COMFORT



Since 2006, all Panasonic VRF systems have included special VET technology, with variable coolant temperature, as standard.

Variable Evaporation and Condensation Temperature

Our 'smart logic' system checks the temperature every 30 seconds, automatically adjusting coolant temperature according to actual demand and outdoor conditions. This ensures better energy performance at all times.

Temperature varies from 16 °C to 3 °C.

Similarly, the condensation temperature is also variable and is adjusted to the room thermal load, within a range of 33–55 °C.

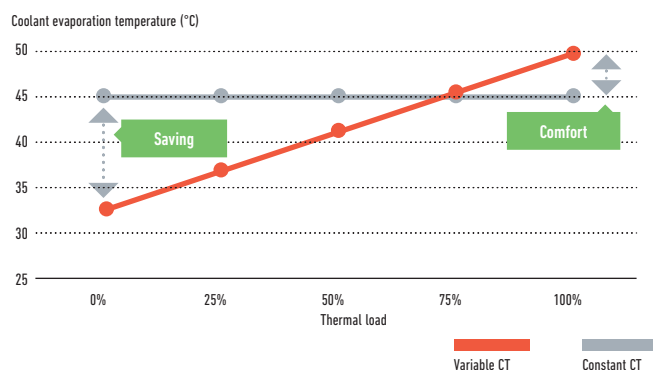
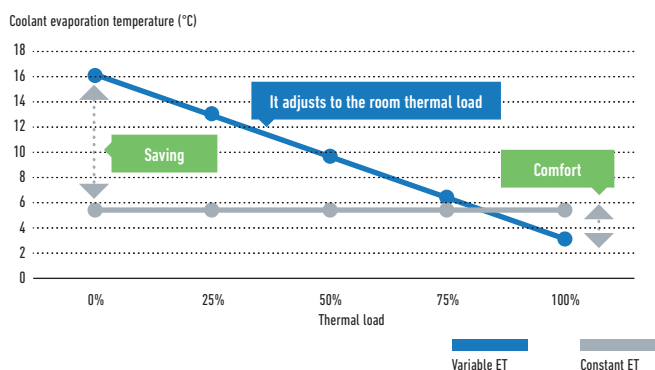

Example of cooling mode (heating mode is also available)

Technical focus Variable temperatures

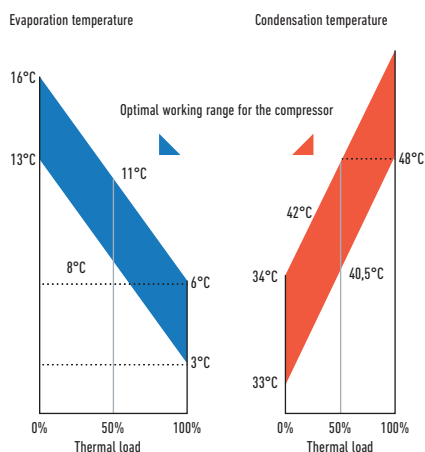

Control of the discharge temperature

This special function is available in all of Panasonic VRF systems' indoor units to guarantee maximum comfort for the end user.

For example, in cooling mode, if the temperature of the discharged air was below 10 °C, the user may feel discomfort, just as he would do in heating mode if the temperature was far too high. With the Panasonic control of the discharge air temperature, this can be adjusted within a cooling range of 7–22 °C.

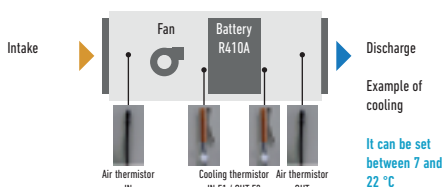

Benefits

- The air will never be too cold or too warm
- Cooling and Heating function
- Comfort
- Energy saving
- It prevents the formation of condensation within ducts and vents, improving levels of hygiene.

SOLUTIONS FOR RESTAURANTS

Full heating, cooling and DHW solutions for Restaurants

Highly efficient at part load conditions.

Panasonic has solutions for optimising the installation of cooling, heating and DHW production in restaurants. While the kitchen needs cooling, heating is needed for DHW and also for heating the public area, with the advantage of 100% fresh air that removes odours. Combining all these needs smartly with Panasonic technology results in a simple and flexible system adaptable to any restaurant requests, with lower utility bills. Additionally, Panasonic is the unique offering solution for areas where electric power is limited, using ECO G, VRF units powered mainly by Natural Gas or Propane, bringing comfort and DHW anywhere.

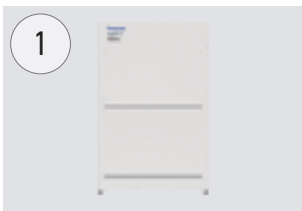

1 ECOi (Electric VRF).

ECOi electrical VRF is specifically designed for the most demanding hotels. High efficiency system. Extended operating range to provide heating at outdoor temperature as low as -20°C. Suitable for refurbishment projects.

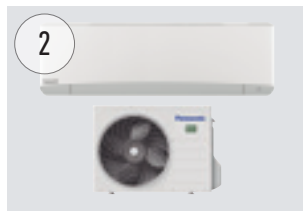

2 TKEA outdoor unit for server room.

Steady cooling, nonstop, even at -20°C and still with high efficiency. Ready for continuous operation and easy to connect 2 systems to automatically alternate and ensure server rooms are kept cool.

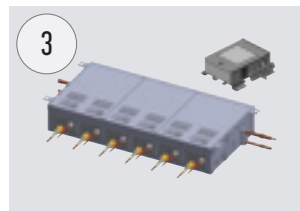

3 3-Pipe control box kit.

New Heat Recovery box to connect multiple indoor units with just one box, 4, 6 and up to 8 indoor units or groups. This is good advantage specially in hotels applications, where space for connecting several boxes is limited.

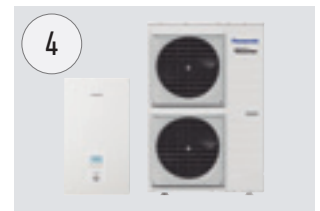

4 Aquarea T-CAP.

Ideal for heating, cooling and for production of big quantities of hot water at 65°C, Aquarea have an extremely quick return on investment and a low CO₂ footprint.



5 Control your way.

Wide variety of controls, from simple user control to full system control via remote access functionality. Touch panel and consumption control.

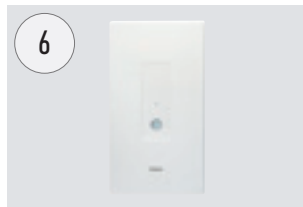

6 Hydrokit for ECOi. Water at 45°C.

Producing LT hot water, compatible with both ECOi, heat pump and heat recovery outdoors.

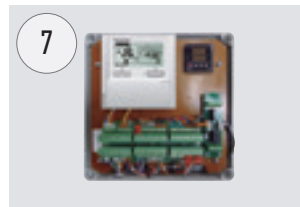

7 Air Handling Unit kits for efficient ventilation.

The new AHU kit is specially designed to improve the efficiency of the pre-heating or pre-cooling process of the ventilation.



8 Hide Away, for power and efficiency.

Super silent units deliver the ideal air supply. Units available from 1,50kW providing precise temperature control even in small rooms. Two models available: slim unit for height restricted areas (MM unit only 200mm deep), another which allows 100% fresh air (MF).

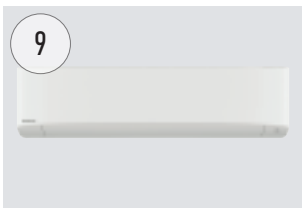

9 Wall Mounted.

The K2 Type wall mounted unit has a stylish smooth panel which not only looks good but is also easy to clean. The unit is also smaller, lighter and substantially quieter than previous models making it ideal for small offices and other commercial applications.

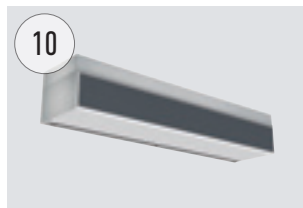

10 Air Curtain with DX Coil.

The Panasonic range of air curtains is designed for smooth operation and efficient performance.

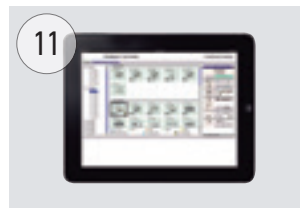

11 Protocol friendly.

Great flexibility for integration into your KNX / Modbus / LonWorks / BACnet projects allows fully bi-directional monitoring and control of all the functioning parameters. Range of solutions to control locally or remotely the full system in bi-directional mode.



12 Panasonic AC Smart Cloud.

Taking your business under control. New service function makes maintenance works simpler.

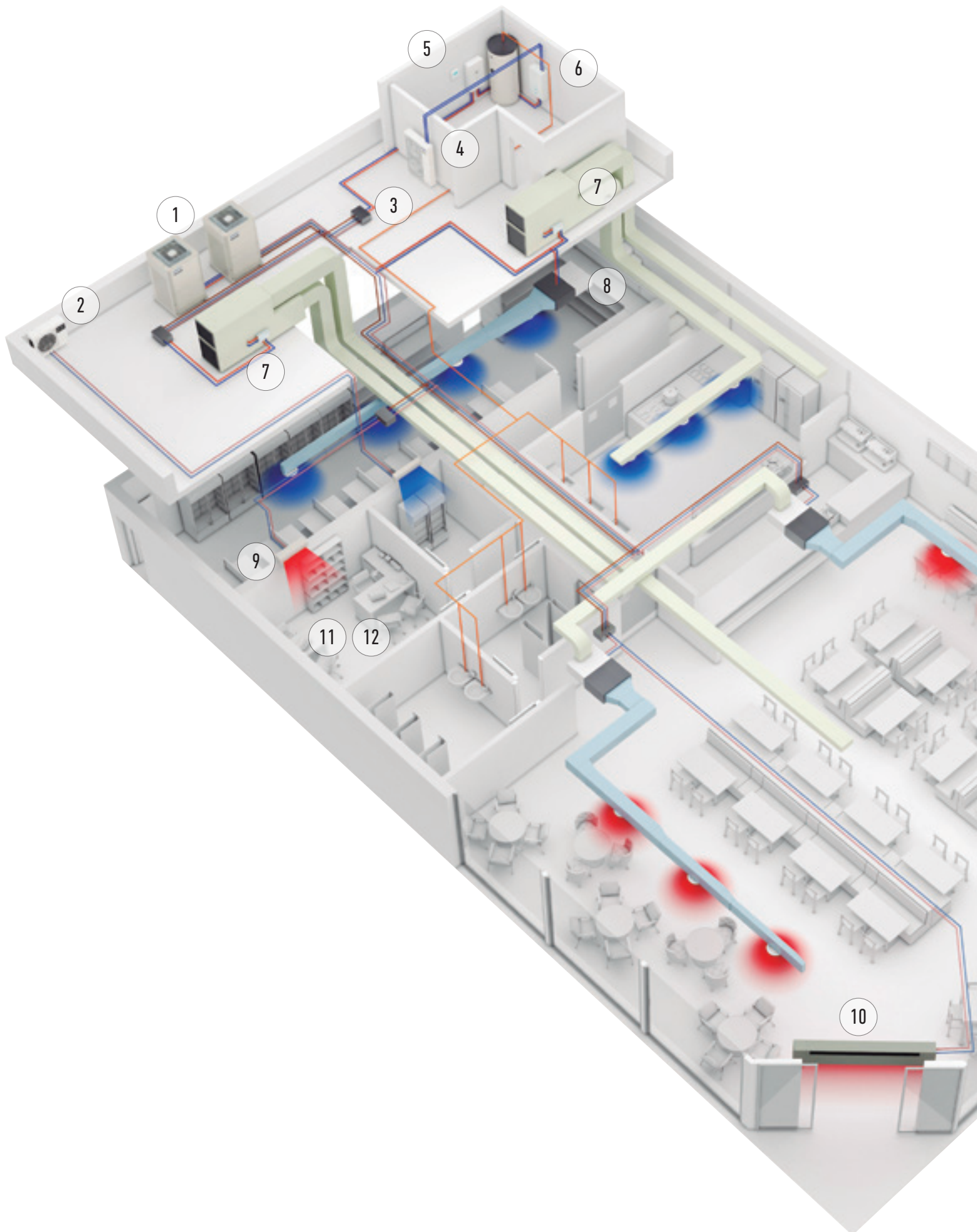

YOUR ENTIRE HOTEL WITH SUPERIOR COMFORT, CONTROL AND SAVINGS TOO



Hybrid system.
Gas + Electricity Hybrid system. Taking advantage of Gas and Electricity to achieve the most efficient performance and maximum energy savings.



ECO G (Gas heat pump).
ECO G gas VRF is designed for buildings where the electricity is restricted or CO₂ emissions must be reduced. Sanitary hot water is produced for free, all year round.

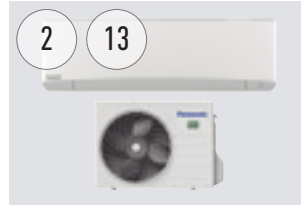

TKEA outdoor unit for server room.
Steady cooling, nonstop, even at -20°C and still with high efficiency. Ready for continuous operation and easy to connect 2 systems to automatically alternate and ensure server rooms are kept cool.

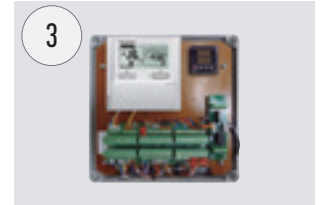

Air Handling Unit kits for efficient ventilation.
The new AHU kit is specially designed to improve the efficiency of the pre-heating or pre-cooling process of the ventilation.

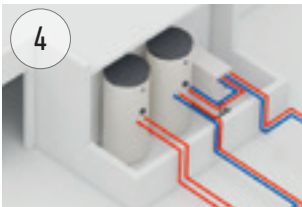

Domestic Hot Water production and buffer tanks.
Panasonic has developed a wide range of efficient domestic hot water tanks and buffer tanks.

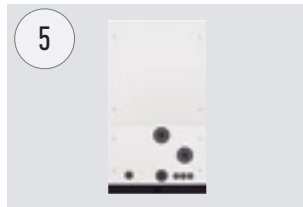

Hydronic units.
For obtaining hot and cold water for heating and refrigeration (Aquarea Air radiators, underfloor heating, radiators...)

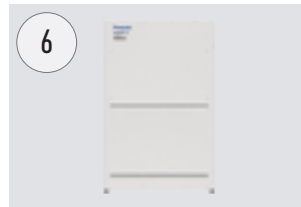

ECOi (Electric VRF).
ECOi electric VRF is specifically designed for the most demanding hotels. High efficiency system. Extended operating range to provide heating at outdoor temperature as low as -20°C.

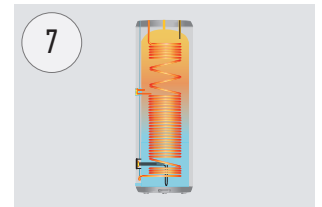

PRO-HT Tank DHW.
DHW tank with maximum outlet temperature 65°C. Ideal solution for high demand of hot water such as shower, spa, swimming pool.

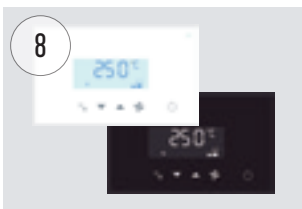

Control your way.
Wide variety of controls, from simple user control to full system control via remote access functionality. Touch panel, web server, consumption control, smartphone control... everything is possible.

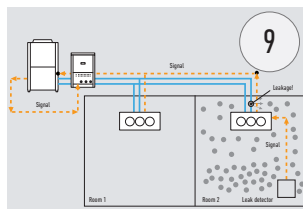

Direct leak detection method for the safety.
Panasonic Pump Down System meets requirements by the Safety of Building Occupant (BS-EN378). The safest solution for hotel rooms.



Wide range of indoor units.
Complete range of indoor units that fits any need. All units provided with supply air temperature sensor and low operation sound level to guarantee maximum guests comfort. From 1,50kW up to 30,00kW.



Panasonic AC Smart Cloud.
Take control of all your premises around the world from a single device. Centralise control of your business premises, from wherever you are, 24/7.



Protocol friendly.
Great flexibility for integration into your KNX / Modbus / LonWorks / BACnet projects allows fully bi-directional monitoring and control of all the functioning parameters.

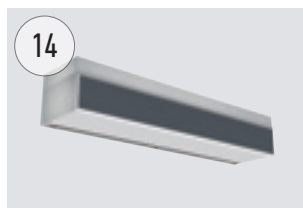

Air Curtain with DX Coil.
The Panasonic range of air curtains is designed for smooth operation and efficient performance.



Maximum savings on hot water production.
Hot water for swimming pool, spa and laundry for free thanks to the residual heat generated by the ECO G units.

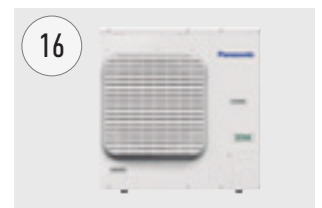

Condensing unit with natural refrigerant.
Panasonic CO₂ unit is the natural choice for an energy saving and environmentally friendly solution.

Panasonic offers the widest range in HVAC, DHW and ventilation available. That enables us to offer the most suitable solution 24 hours a day, 365 days a year. Panasonic Solutions ensure not only a higher customer satisfaction but also a lower energy bill.

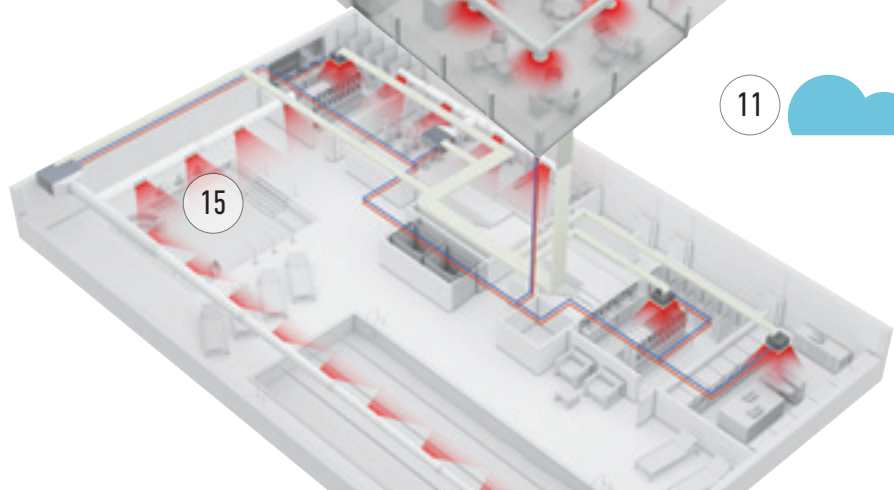
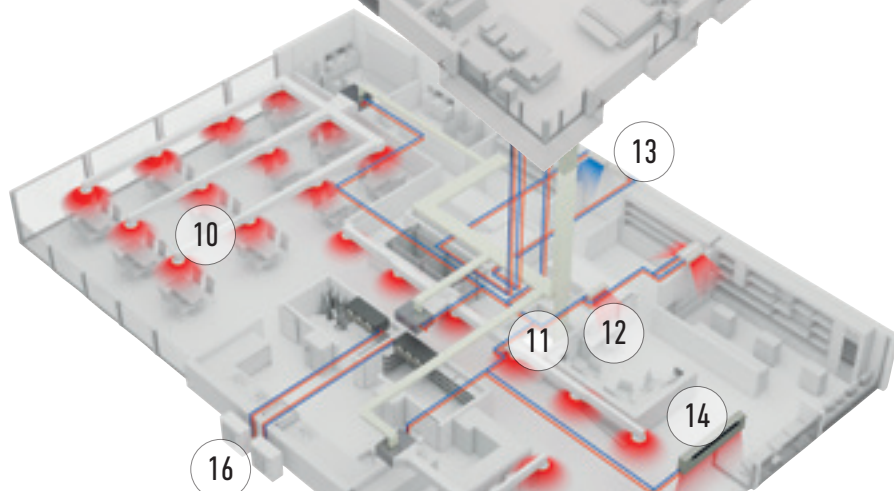
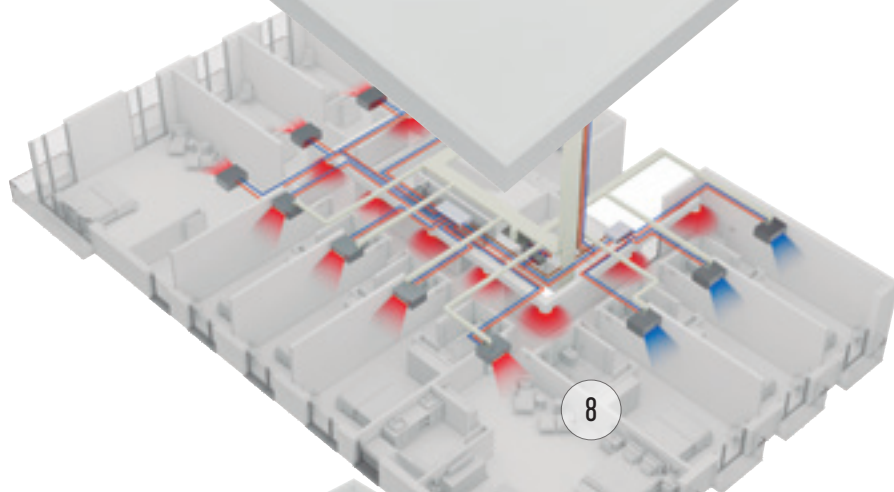
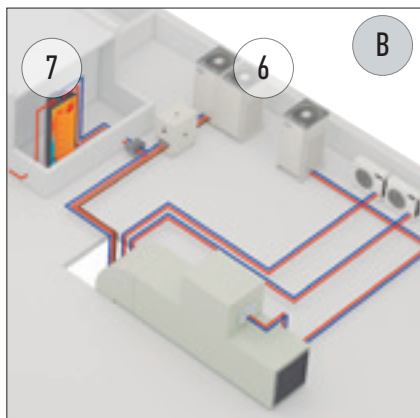
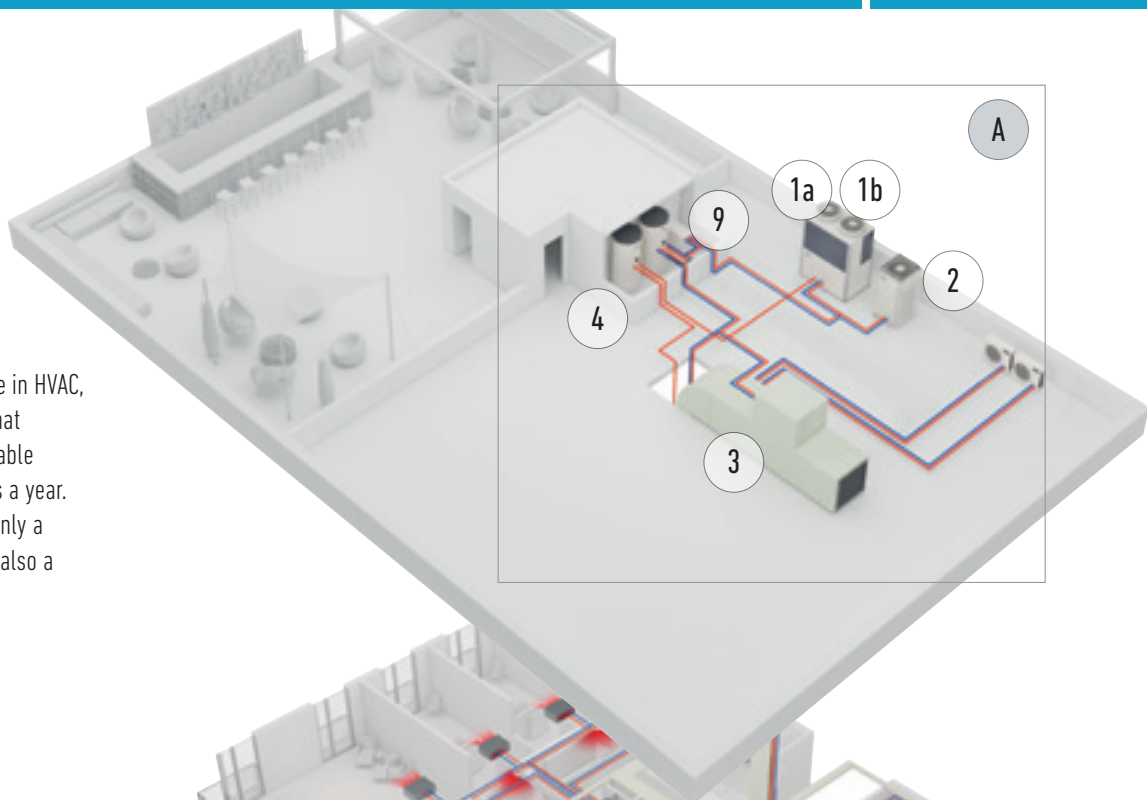

A

Option A: Hybrid Solution. Gas + Electric: When large quantities of hot/cold water is needed.

- ECO G (Gas heat pump)
- Water heat exchanger
- Aquarea HT to produce hot water up to 65°C
- Air Handling Unit kit to connect the ECO G to the Air Handling Unit
- TKEA wall mounted to cool the server rooms efficiently

B

Option B: Full Electric Solution 2 and 3-Pipe. When flexibility is needed and electricity power availability is not an issue.

- ECOi (Electric VRF)
- Direct expansion indoor units
- Air Handling Unit (AHU) kit to connect the ECOi to the AHU
- TKEA wall mounted to cool the server rooms efficiently
- Panasonic Pump Down System

INNOVATIVE SOLUTIONS FOR RETAIL

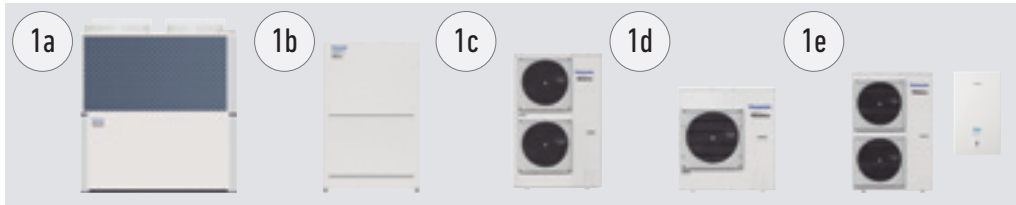

Multi energy solutions, gas or electric.

The Multi energy solution (Gas and Electric) from Panasonic provides the best choice in energy saving and on the flexibility of the installation. Panasonic solutions can be connect to direct expansion systems, water chiller installations and ventilation systems as air handling units.

- 1a: Gas VRF. ECO G
- 1b: Electric VRF. ECOi
- 1c: Electric VRF. Mini ECOi
- 1d: Electric 1x1. PACi
- 1e: Electric A2W. Aquarea



TKEA outdoor unit for server room.
Steady cooling, nonstop, even at -20°C and still with high efficiency. Ready for continuous operation and easy to connect 2 systems to automatically alternate and ensure server rooms are kept cool with maximum operating guaranteed.



Control your way.

Wide variety of controls, from simple user control to full system control via remote access functionality. Touch panel and consumption control.

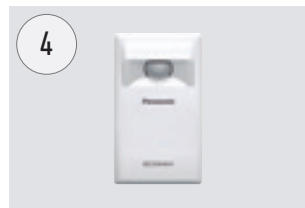

Econavi Sensor.

The Econavi Sensor detects presence in the room, and quietly adapts the PACi or VRF air conditioning system in order to improve comfort and energy savings.



Wide range of indoor units.

Complete range of indoor units that fits any need. All units provided with supply air temperature sensor and low operation sound level to guarantee guests comfort. From 1,50kW up to 30kW.



Hide Away, for power and efficiency.

Super silent units deliver the ideal air supply. Units available from 1,50kW providing precise temperature control even in small rooms. Two models available: slim unit for height restricted areas (MM unit only 200mm deep), another which allows 100% fresh air (MF).

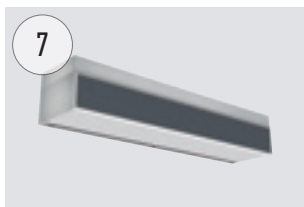

Air Curtain with DX Coil.

The Panasonic range of air curtains is designed for smooth operation and efficient performance.



Protocol friendly.

Great flexibility for integration into your KNX / Modbus / LonWorks / BACnet projects allows fully bi-directional monitoring and control of all the functioning parameters. Range of solutions to control locally or remotely the full system in bi-directional mode.

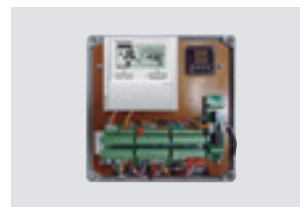

Air Handling Unit kits for efficient ventilation.

The new AHU kit is specially designed to improve the efficiency of the pre-heating or pre-cooling process of the ventilation.

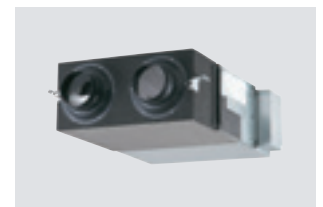

Energy Recovery unit for high efficiency of the system.

Panasonic Energy Recovery Ventilators can reduce the outside air load because they efficiently recover the heat lost by ventilation during the heat recovery process.

Heating and cooling solutions for retail applications

Panasonic has developed solutions for retail applications and office applications where return on investment is a key factor! The comfort inside the shop is key for a good customer experience in the shop. From local control or from Panasonic new cloud control system, a detail status of the heating and cooling system can be displayed, analysed and optimised in order to improve the efficiency, reduce the running time and increase the life time of the units.

8 reason why Panasonic is the best solution for your Retail:

- Complete solution
- Flexibility and adaptation
- Go green retail: low CO₂ emissions
- Comfort - high customer satisfaction
- Future expansion
- Panasonic offers efficient systems meeting expectations over the years
- High quality of service with Panasonic pro-partner installation team
- The system will still operate up to 25% of the connected indoor units. System will not stop when up to 25% of indoor units have power supply breakdown when they are on mode

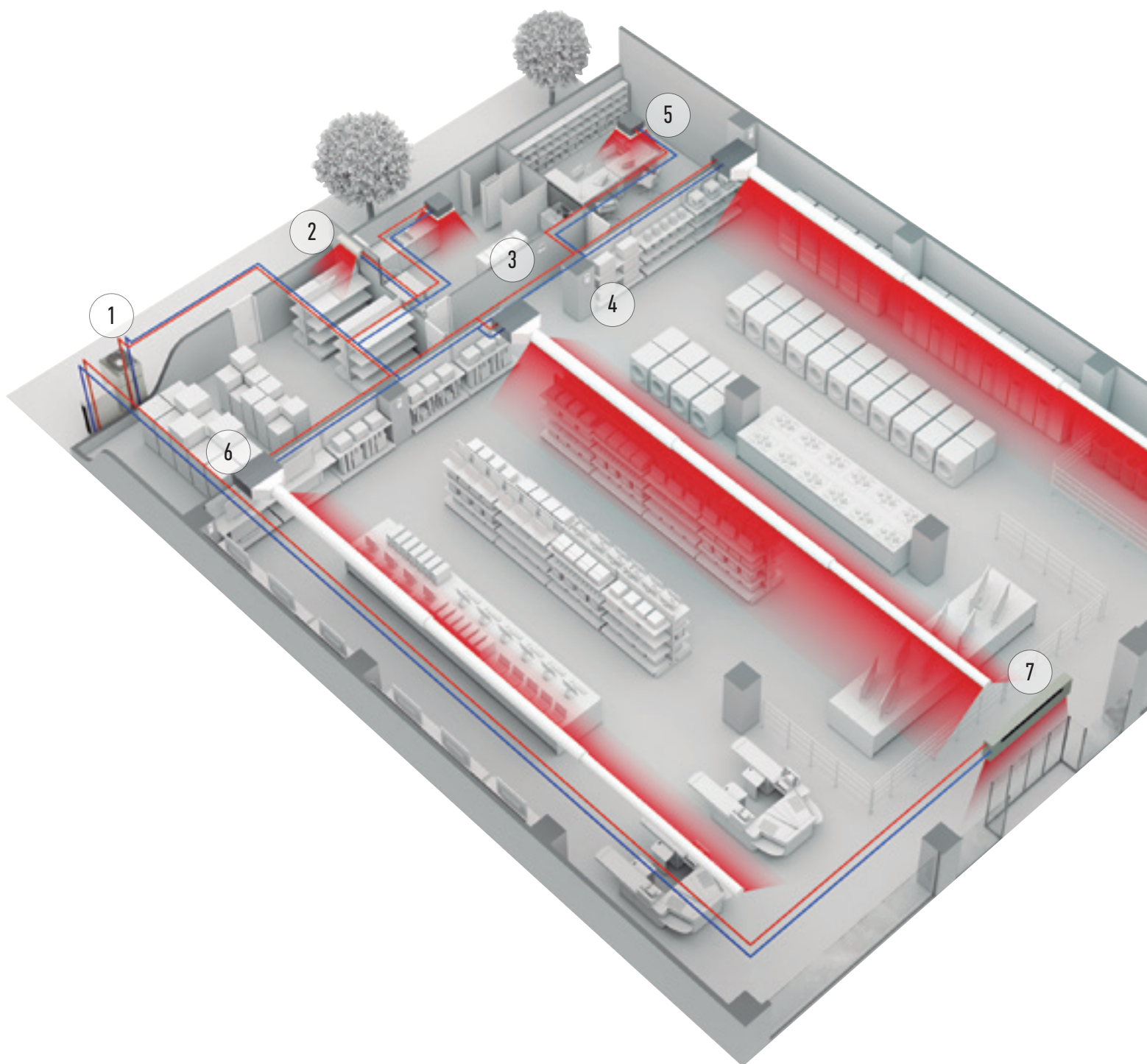

RANGE OF VRF OUTDOOR UNITS

Page	Outdoor units	4HP	5HP	6HP	8HP	10HP	12HP
------	---------------	-----	-----	-----	-----	------	------

P. 220 Mini ECOi LE2 / LE1 Series



U-4LE2E5 / U-4LE2E8 U-5LE2E5 / U-5LE2E8 U-6LE2E5 / U-6LE2E8 U-8LE1E8 U-100LE1E8

P. 232 2-Pipe ECOi EX ME2 Series



U-8ME2E8 U-10ME2E8 U-12ME2E8

P. 242 3-Pipe ECOi EX MF3 Series



U-8MF3E8 U-10MF3E8 U-12MF3E8

P. 252 2-Pipe ECO G GE3 Series

P. 256 3-Pipe ECO G GF3 Series

P. 258 GHP/EHP Hybrid System

14HP

16HP

18HP

20HP

25HP

30HP



U-14ME2E8



U-16ME2E8



U-18ME2E8



U-20ME2E8



U-14MF3E8



U-16MF3E8



U-16GE3E5



U-20GE3E5



U-25GE3E5



U-30GE3E5



U-16GF3E5



U-20GF3E5



U-25GF3E5



U-20GES3E5 / U-10MES2E8

BEST EFFICIENCY ECOi SERIES FROM PANASONIC



The ECOi series is designed for energy savings, easy installation, and high efficiency. Always continuing to evolve, Panasonic uses advanced technologies to meet the requirements of diverse situations and contribute to the creation of comfortable living spaces.

ECOi

Mini ECOi LE Series



The 2-Pipe heat pump small VRF system specifically designed for the European market.

2-Pipe ECOi EX ME2 Series



The VRF system delivering energy-saving performance, powerful operation, reliability and comfort surpassing anything previously possible.

ECOi EX

3-Pipe ECOi EX MF3 Series

ECOi EX



The VRF system that offers high-efficiency and performance for simultaneous heating and cooling.

Lower running and life cycle costs.

Panasonic ECOi systems are highly efficient VRF systems on the market, offering COPs in excess of 4,0 at full load conditions. The system is also designed to make sure that we reduce the running cost of each system by using our unique road map control routine to ensure that the efficient combination of compressors are running at any one time. Improved defrost sequencing also reduces running costs by defrosting each outdoor coil in turn when conditions allow.

Up to 64 indoor units can be connected up to a capacity of 200% indexed indoor unit loads, enabling the system to be used effectively on highly

diversified building loads: this large connectivity feature makes it an easy-to-design solution for schools, hotels, hospitals and other large buildings. Up to 1000m in pipe length enables the VRF ECOi series to be used in very large buildings, with maximum design flexibility. The ECOi system is also easy to control. It has more than 8 types of control from standard wired remote controls to touch screen panels or web access interfaces.

DC-inverter control technology for rapid and powerful cooling & heating. The ever-evolving Panasonic ECOi series.

ECOi Series benefits

Ease of installation.

R410A has a higher operating pressure with a lower pressure loss than previous refrigerants. This enables smaller pipe sizes to be used and allows reduced refrigerant charges.

Simple to design.

Panasonic recognise that designing, selecting and preparing a professional VRF quotation can be a time consuming and costly process, especially as it is often also a speculative exercise. So we have designed proprietary software which is quick and easy to use and produces a full schematic layout of pipework and controls, as well as a full materials list and performance data.

Easy to control.

A wide variety of control options are available to ensure that the ECOi system provides the user with the degree of control that they desire, from simple room controllers through to state of the art BMS controls.

Simple to commission.

Simple set-up procedure including automatic addressing of connected indoor units. Configuration settings can be made from an outdoor unit or via a remote controller.

Easy to position.

The compact design of the ECOi outdoor units means that sizes 4HP to 10HP fit into a standard lift and are easy to handle and position when on site. The small footprint and modular appearance of the units ensure a cohesive appearance to an installation.

Wide selection and connectivity.

With 17 indoor model styles available, ECOi systems are the ideal choice for multiple small capacity indoor unit installations, with the ability to connect up to 40 indoor units to systems of 24HP or greater for 3-Pipe ECOi EX MF3 Series.

Easy to maintain.

Each system allows the use of prognostic and diagnostic controls routines, from refrigerant charge control through to complex fault code diagnostics, all designed to reduce the speed of maintenance calls and unit down time.

Lower running and life cycle costs.

Panasonic ECOi system are also designed to make sure that we reduce the running cost of each system by using our unique road map control routine to ensure that the most efficient combination of compressors are running at any one time. Improved defrost sequencing also reduces running costs by defrosting each outdoor coil in turn when conditions allow.

MINI ECOi LE SERIES FOR LIGHT COMMERCIAL & RESIDENTIAL USE

**NEW
COMPACT
DESIGN**



Mini ECOi with extraordinary energy-saving performance and high external static pressure (35Pa).

Advantages of Mini ECOi LE Series used for medium sized buildings.

1 Efficiency energy control
Upgraded outdoor units deliver high efficiency rating and reduced energy costs.

2 Space saving
Ideal for commercial locations with limited space such as banks and shops.
Compact units integrate easily and discreetly into building design.

3 Flexible installation
Reduced installation time thanks to compact units and extra long piping without additional refrigeration charge. High external static pressure 35Pa and small chassis increase installation options.



7,85 | **4,87***
SEER | **SCOP**
INDUSTRY LEADING EFFICIENCY

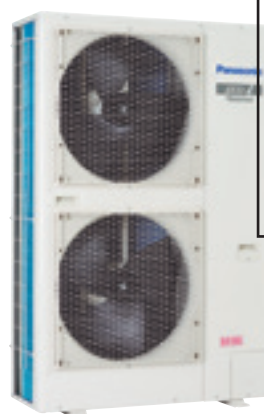

6,37*
SEER
4,31
SCOP

New compact design: LE2 Series – 4 / 5 / 6HP

- Extraordinary energy saving: 7,85 SEER and 4,87 SCOP (4HP)*
- 50 m piping length without additional refrigerant charge
- Quiet operation mode with 4 levels
- High COP mode option

* SEER/SCOP is calculated based on the seasonal space cooling/heating efficiency "η₁" values of the COMMISSION REGULATION (EU) 2016/2281. SEER, SCOP = (η₁ + Correction) × PEF.

LE1 Series – 8 / 10HP

- 60% smaller than ECOi ME2 8 / 10HP with vertical flow type
- Flexible piping length (Total: 300m, Furthest: 150m)
- Maximum number of connectable indoor units: 15

Key features for LE2 / LE1.

- High external static pressure 35Pa
- Full range of ECOi indoor units and controllers
- Variable evaporation temperature control as standard
- Connectable maximum indoor / outdoor capacity ratio up to 130%
- Auto restart from outdoor units
- Demand response (Peak cut) by optional parts
- Suitable for R22 renewable projects

INSTALLATION FLEXIBLE, EASY AND HASSLE-FREE

High external static pressure 35Pa

- High air pressure
- New blade shape
- Good for high class condominiums

When unit is installed on a narrow balcony and exposed to the sun, the barrier at the front side would restrict hot air from being discharged. Heat accumulated in an enclosure can cause over-heating. This could potentially result in damage or shorten the product's life span. A high external static pressure sends the air further away from the outdoor unit and through the barrier. This provides better air circulation and distribution.

And a high air pressure of 35Pa discharges the hot air a sufficient distance.

Previous Model - Low Pressure

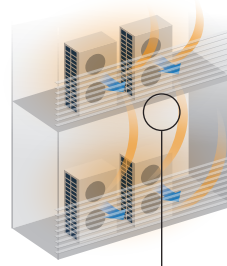

Heat Accumulated.
When the pressure is low, hot air will accumulate in the unit thus affecting its work performance and that of unit above it as well.



Previous fan

LE Series - High Pressure



Heat Discharged.
But with a high pressure of 35Pa, hot air is sent further away preventing overheating inside the outdoor unit enclosure.



New LE2's fan

Long piping design length for greater design flexibility

LE1: Maximum total piping length: 300m.

LE2: Maximum total piping length: 180m.

Maximum height difference between outdoor unit and indoor unit:

50m*

Maximum height difference between indoor units:

15m

Actual piping length

150m

(Equivalent piping length 175m)

* 40m if the outdoor unit is below the indoor unit.

Plug & Play concept

- 50m piping length free of charge
- A 50m pipe length is sufficient for most residential and small business buildings

FREE OF CHARGE 50m

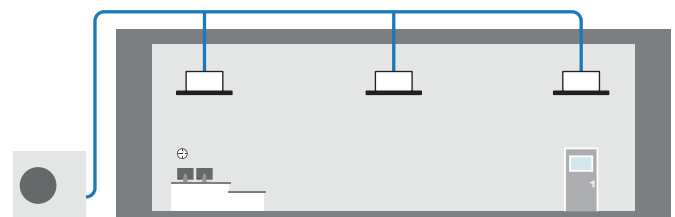

- Compact space-saving design
- High external static pressure 35Pa
- Long piping length for flexible installation
- No refrigeration charge up to 50m
- 130% ratio for connectable indoor capacity units

Up to 15 indoor units connectable

An expansion from Panasonic VRF line up, the mini ECOi is compatible with the same indoor units and controls as the rest of the ECOi range.

Compact design

Mini ECOi LE Series is a single unit.

Perfect for installations with limited space and easy to hide within a modern building. Flexible space-saving options compared to single split system.

LE2 short height of 996mm.

New LE2 Series is 25% smaller in height than conventional model.

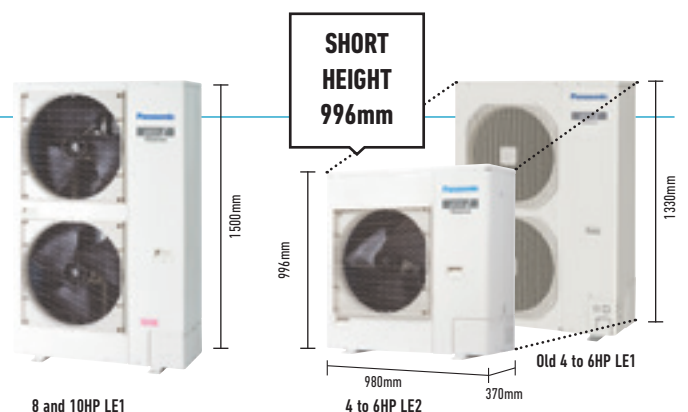

ENERGY CONTROL & RELIABILITY

Energy savings design

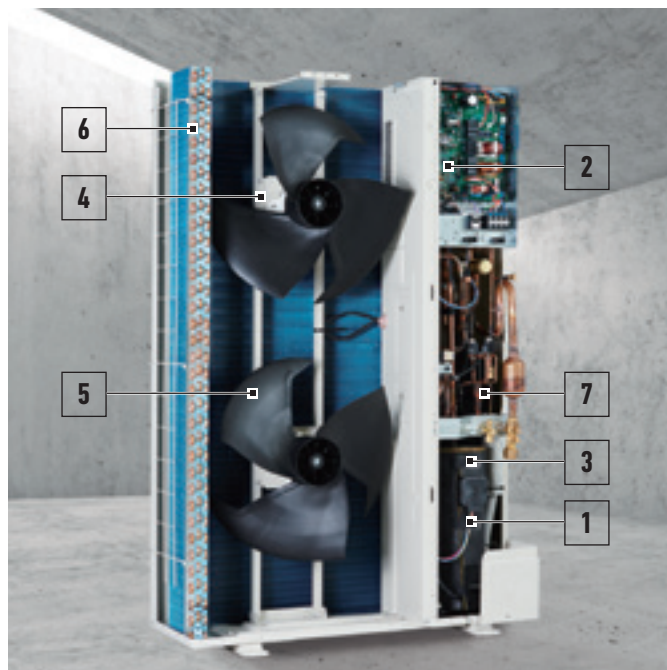

1. **Panasonic Inverter Compressor.** A large-capacity inverter compressor has been adopted. The inverter compressor is superior in performance with improved partial-load capacity.
2. **Printed Circuit Board.** The number of PCB is 2 pieces for making maintenance easier.
3. **Accumulator.** A large accumulator has been adopted to maintain compressor reliability because of the increased refrigerant quantity, which allows an extended maximum piping length.
4. **DC Fan Motor.** Checking load and outside temperature, the DC motor is controlled for optimum air volume.
5. **Newly Designed Fan.** The newly designed fan blades have been developed to inhibit air turbulence and to increase efficiency. As fan diameter has been increased its size, the air volume has been increased whilst maintaining a same sound level.
6. **Heat Exchanger & Copper Tubes.** The heat exchanger size and the copper tube sizes in the heat exchanger have been redesigned to increase efficiency.
7. **Oil Separator.** A centrifugal separator has been adopted to improve oil separation efficiency and reduce refrigerant pressure loss.

Bluefin condenser: High durability outdoor unit

The anti-corrosion Bluefin treatment of the heat exchanger provides greater resistance against corrosion. All models are equipped with Bluefin condenser and corrosion-resistance treated for high resistance to rust and salty air to assure long-lasting performance.

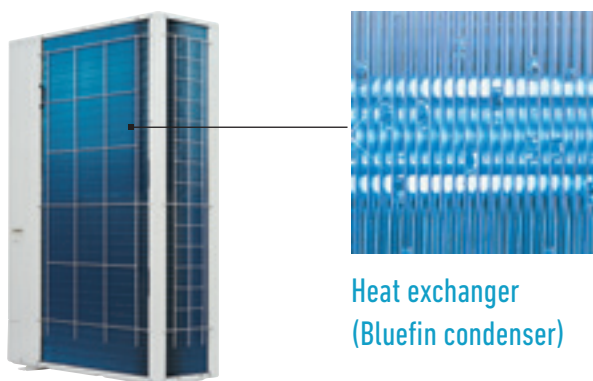

Heat exchanger
(Bluefin condenser)

The new Mini ECOi system delivering energy-saving performance, powerful operation, reliability and comfort surpassing anything previously possible.

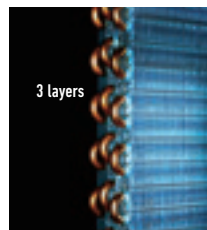

Powerful heat exchanger.
3 layers of heat exchanger for all LE series. LE Series features the same heat exchange volume as conventional model even though it is 15% smaller in size.

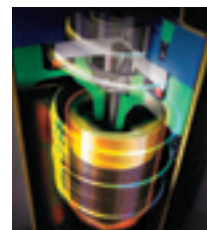

Panasonic twin Rotary Compressor.
A large capacity inverter compressor has been adopted. This new compressor features wider and 0.1Hz step inverter control.



New design fan.
Fan blades have been redesigned to inhibit air resistance and to increase efficiency. The larger fan increases air volume while maintaining low noise levels.

Superior seasonal energy efficiency (SEER/SCOP follows LOT21*)

The operation efficiency has been improved using highly efficient R410A refrigerant, a DC Inverter compressor, DC motor and a heat exchanger design.

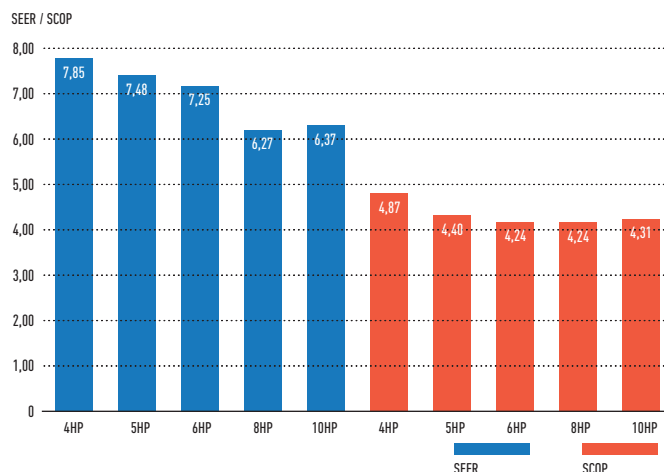

* SEER/SCOP is calculated based on the seasonal space cooling/heating efficiency "η" values of the COMMISSION REGULATION (EU) 2016/2281. SEER, SCOP = (η + Correction) × PEF.

Maximum comfort with quiet operation mode

- Quiet operation mode reduces outdoor unit operating sound by 7dB(A)
- 4-step set point is available
- Silent mode 1 maintains rated cooling capacity

* Timer setting of quiet operation mode is available in High-spec remote controller.

Silent mode options	Sound pressure level
Silent mode 1	-1,5dB(A)
Silent mode 2	-3dB(A)
Silent mode 3	-5dB(A)
Silent mode 4	-7dB(A)

Mini ECOi LE2 Series High Efficiency 4 to 6HP



Panasonic Mini ECOi. Extraordinary energy-saving. The most compact ECOi system ever.

For light commercial use

Mini ECOi allows easier installation in condominiums and medium sized buildings with limited spaces. Utilising R410A and DC inverter technology, Panasonic offers VRF to a new and growing market.

Short height of 996mm

In addition to raising efficiency, the outdoor unit has been designed to be as compact as possible. It can now be installed in places that were previously too small.

Technical focus

- Outstanding SEER and SCOP
- Better efficiency even compared to 2 fan outdoor units
- 50m piping length free of refrigeration charge
- 35Pa high static pressure
- High COP mode selectable with maintenance remote controller
- Selectable silent mode

HP			4HP	5HP	6HP	4HP	5HP	6HP
Outdoor units			U-4LE2E5	U-5LE2E5	U-6LE2E5	U-4LE2E8	U-5LE2E8	U-6LE2E8
Power supply	Voltage	V	220 / 230 / 240	220 / 230 / 240	220 / 230 / 240	380 / 400 / 415	380 / 400 / 415	380 / 400 / 415
	Phase		Single Phase	Single Phase	Single Phase	Three Phase	Three Phase	Three Phase
	Frequency	Hz	50	50	50	50	50	50
Cooling capacity		kW	12,10	14,00	15,50	12,10	14,00	15,50
EER ¹⁾		W/W	4,50	4,06	3,73	4,50	4,06	3,73
SEER ²⁾			7,85	7,48	7,25	7,85	7,48	7,25
Running current cooling		A	13,30 / 12,70 / 12,20	16,30 / 15,60 / 17,00	20,30 / 19,40 / 18,60	4,39 / 4,17 / 4,02	5,58 / 5,30 / 5,11	6,71 / 6,37 / 6,14
Input power cooling		kW	2,69	3,45	4,15	2,69	3,45	4,15
Heating capacity		kW	12,50	16,00	16,5	12,50	16,00	16,50
COP ¹⁾		W/W	5,19	4,60	4,27	5,19	4,60	4,27
SCOP ²⁾			4,87	4,40	4,24	4,87	4,40	4,24
Running current heating		A	12,20 / 11,60 / 11,20	17,60 / 16,80 / 16,10	19,10 / 18,20 / 17,50	3,98 / 3,78 / 3,64	5,62 / 5,34 / 5,14	6,24 / 5,93 / 5,71
Input power heating		kW	2,41	3,48	3,86	2,41	3,48	3,86
Starting current		A	1,00	1,00	1,00	1,00	1,00	1,00
Maximum current		A	17,30	24,30	27,40	7,90	10,10	10,70
Maximum input power		kW	3,50 / 3,66 / 3,82	4,92 / 5,14 / 5,37	5,61 / 5,86 / 6,12	4,34 / 5,09 / 5,28	6,25 / 6,55 / 6,82	6,62 / 6,97 / 7,23
Maximum number of connectable indoor units			7(10) ³⁾	8(10) ³⁾	9(12) ³⁾	7(10) ³⁾	8(10) ³⁾	9(12) ³⁾
External static pressure		Pa	0~35	0~35	0~35	0~35	0~35	0~35
Air volume		m ³ /min	69	72	74	69	72	74
		dB(A)	52	53	54	52	53	53
Sound pressure	Cool (Silent 1 / 2 / 3 / 4)	dB(A)	50,5 / 49 / 47 / 45	51,5 / 50 / 48 / 46	52,5 / 51 / 48 / 46	50,5 / 49 / 49 / 47	48,5 / 50 / 48 / 46	48,5 / 50 / 48 / 46
	Heat	dB(A)	54	56	56	54	56	56
Sound power	Cool / Heat	dB	69 / 72	71 / 75	73 / 75	69 / 72	71 / 75	73 / 75
Dimension	HxWxD	mm	996x980x370	996x980x370	996x980x370	996x980x370	996x980x370	996x980x370
Net weight		kg	106	106	106	106	106	106
Piping connections	Liquid pipe	Inch (mm)	3/8(9,52)	3/8(9,52)	3/8(9,52)	3/8(9,52)	3/8(9,52)	3/8(9,52)
	Gas pipe	Inch (mm)	5/8(15,88)	5/8(15,88)	5/8(15,88)	5/8(15,88)	5/8(15,88)	5/8(15,88)
Maximum piping length (total)		m	150(180)	150(180)	150(180)	150(180)	150(180)	150(180)
Elevation difference (in/out)		m	50 (Outdoor unit upper) / 40 (Outdoor unit lower)	50 (Outdoor unit upper) / 40 (Outdoor unit lower)	50 (Outdoor unit upper) / 40 (Outdoor unit lower)	50 (Outdoor unit upper) / 40 (Outdoor unit lower)	50 (Outdoor unit upper) / 40 (Outdoor unit lower)	50 (Outdoor unit upper) / 40 (Outdoor unit lower)
Refrigerant (R410A) / CO ₂ Eq.		kg / T	6,70(14,40) / 13,9896	6,70(14,40) / 13,9896	6,70(14,40) / 13,9896	6,70(14,40) / 13,9896	6,70(14,40) / 13,9896	6,70(14,40) / 13,9896
Maximum allowable indoor / outdoor capacity ratio		%	50~130	50~130	50~130	50~130	50~130	50~130
Operating range	Cool Min ~ Max	°C	-10 ~ +46	-10 ~ +46	-10 ~ +46	-10 ~ +46	-10 ~ +46	-10 ~ +46
	Heat Min ~ Max	°C	-20 ~ +18	-20 ~ +18	-20 ~ +18	-20 ~ +18	-20 ~ +18	-20 ~ +18

1) EER and COP calculation is based in accordance to EN14511. 2) SEER/SCOP is calculated based on the seasonal space cooling/heating efficiency "η" values of the COMMISSION REGULATION (EU) 2016/2281. SEER, SCOP = (η + Correction) × PEF. 3) In case of 1,50kW indoor unit's connection, able to connect maximum 12 indoor units.



Mini ECOi LE1 Series High Efficiency 8 and 10HP



Prepare to be blown away by Panasonic's New Mini VRF system. The Mini VRF compact system is the ideal solution for minimum outdoor space. Panasonic extends the Mini VRF range by 8 and 10HP units.

Increase external static pressure

When unit is installed on a narrow balcony, the fence at front side will be the obstacle. High external static pressure will overcome this obstacle and maintain operation capacity.

High ambient temperature performance

Cooling operation range up to 46°C. The system can maintain the rated (100%) capacity up to 40°C by 8HP model & up to 37°C by 10HP model.

Technical focus

- Piping flexibility with 150m maximum length
- High efficiency
- 15 indoor units connectable
- Quiet operation mode (one of the lowest in the market)
- High ambient temp performance
- High static pressure 35Pa

HP			8HP	10HP
Outdoor units			U-8LE1E8	U-10LE1E8
Power supply	Voltage	V	380 / 400 / 415	380 / 400 / 415
	Phase		Three Phase	Three Phase
	Frequency	Hz	50	50
Cooling capacity		kW	22,40	28,00
EER ¹⁾		W/W	3,80	3,11
SEER ²⁾			6,27	6,37
Running current cooling		A	9,60 / 9,15 / 8,80	14,70 / 14,00 / 13,50
Input power cooling		kW	5,89	9,00
Heating capacity		kW	25,00	28,00
COP ¹⁾		W/W	4,02	3,93
SCOP ²⁾			4,24	4,31
Running current heating		A	10,20 / 9,65 / 9,30	11,60 / 11,10 / 10,70
Input power heating		kW	6,22	7,13
Starting current		A	1,00	1,00
Maximum current		A	13,70	19,60
Maximum input power		kW	9,16	13,10
Maximum number of connectable indoor units			15 ⁴⁾	15 ⁴⁾
External static pressure		Pa	0 ~ 35	0 ~ 35
Air volume		m ³ /min	150	160
Sound pressure	Cool	dB(A)	60	63
	Cool (Silent 1/2/3/4)	dB(A)	57 / 55 / 53	60 / 58 / 56
	Heat	dB(A)	64	65
Sound power	Cool / Heat	dB	81 / 85	84 / 86
Dimension	HxWxD	mm	1500x980x370	1500x980x370
Net weight		kg	132	133
Piping connections	Liquid pipe	Inch (mm)	3/8 (9,52) ⁵⁾ / 1/2 (12,70) ⁶⁾	3/8 (9,52) ⁵⁾ / 1/2 (12,70) ⁶⁾
	Gas pipe	Inch (mm)	3/4 (19,05) ⁵⁾ / 7/8 (22,22) ⁶⁾	7/8 (22,22) ⁵⁾ / 1 (25,40) ⁶⁾
Maximum piping length (total)		m	7,5 ~ 150 (7,5 ~ 300)	7,5 ~ 150 (7,5 ~ 300)
Elevation difference (in/out)		m	50 (Outdoor unit upper) / 40 (Outdoor unit lower)	50 (Outdoor unit upper) / 40 (Outdoor unit lower)
Refrigerant (R410A) / CO ₂ Eq.		kg / T	6,30 (24,00) / 13,1544	6,60 (24,00) / 13,7808
Maximum allowable indoor / outdoor capacity ratio		%	50 ~ 130	50 ~ 130
Operating range	Cool Min ~ Max	°C	-10 ~ +46	-10 ~ +46
	Heat Min ~ Max	°C	-20 ~ +18	-20 ~ +18

1) EER and COP calculation is based in accordance to EN14511. 2) SEER/SCOP is calculated based on the seasonal space cooling/heating efficiency "η" values of the COMMISSION REGULATION (EU) 2016/2281. SEER, SCOP = (η + Correction) × PEF. 3) In case of 1,50kW indoor unit's connection, able to connect maximum 12 indoor units. 4) If the heating utilized, it is necessary to increase 1 size with respect to the main liquid pipe, depending on the combination of the indoor unit. 5) Under 90m for ultimate indoor unit. 6) Over 90m for ultimate indoor unit. If the longest piping equivalent length exceeds 90m, increase the sizes of the main tubes by 1 rank for gas and liquid pipes.



INTERNET CONTROL: Optional.

ECOi EX THE GAME CHANGER



VRF with outstanding energy-saving performance and powerful operation SEER 7,56 (2-Pipe 18HP model).



A game-changing VRF system delivering energy-saving performance, powerful operation, reliability and comfort surpassing anything previously possible. It represents a true paradigm shift in air conditioning solutions. Taking quality to the extreme — that's the Panasonic challenge.

1 High performance at extreme conditions

ECOi EX is highly reliable, with strong cooling & heating power, even when operating at extreme ambient temperatures. The units can operate at 100% of capacity at 43°C, reaching a great cooling operation up to 52°C and in heating -25°C*.

Also, the ECOi EX features include Bluefin in newly designed heat exchanger improving efficiency as well in marine ambient. A silicone coated PCB (Printed Circuit Board) protects the unit from being damaged by environmental factors such as moisture and dust.

2 Outstanding efficiency and comfort

The new ECOi EX system is designed to increase energy efficiency by delivering high SEER rating, as well as high efficiency for part-load operations.

The system has reduced energy costs thanks to "All-Inverter Compressors", with independent control to deliver highly flexible performance. Also, the ECOi EX features an enlarged heat exchanger with triple surfaces that allow for improved heat transfer and a newly designed curved air discharge bell-mouth for better aerodynamics. The three-stage oil recovery design makes it able to minimise the frequency of forced oil recovery, leading to reduced energy costs and sustained comfort.

3 Superior flexibility

With its up to 1000* meters of pipeline, its maximum 30 meters height difference between indoor units and its 200 meters length, the design possibilities have grown exponentially making the new ECOi EX the ideal air conditioning option for long haul buildings, such as train stations, airports, schools or hospitals. These advantages are enhanced with the wide range of indoor unit models and capacities facilitating the perfect adaptation to all kind of projects. The careful selection of controls and peripherals such as the Pump Down, the AHU or/and the chiller, enables an optimum system use. Connectable maximum allowable indoor / outdoor capacity ratio up to 200%*.

* Conditions of 2-Pipe ECOi EX ME2 Series.



TOP EFFICIENCY AND COMFORT

Remarkable improvement on key components: extraordinary energy-saving performance and redesigned for smooth and better air discharge.

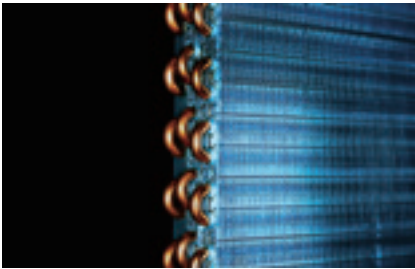

Enlarged heat exchanger surface area with triple surface.

* For 8 & 10HP unit, the heat exchanger is 2 row design.



Multiple large-capacity all inverter compressors (more than 14HP).



Newly designed curved air discharge bell mouth for better aerodynamics.

Improvements on refrigerant circuit

Compressor.

Redesigned components in the body provide performance improvement especially in the rated cooling condition and AEER performance.



Accumulator.

New oil returning circuit with control valve makes efficient oil recovery to compressor.

Oil separator.

Modified tank design makes efficient oil separation with less pressure drop.



Receiver tank less design

Improved refrigerant control program recovers the remaining refrigerant gas in the system back to the accumulator tank effectively.

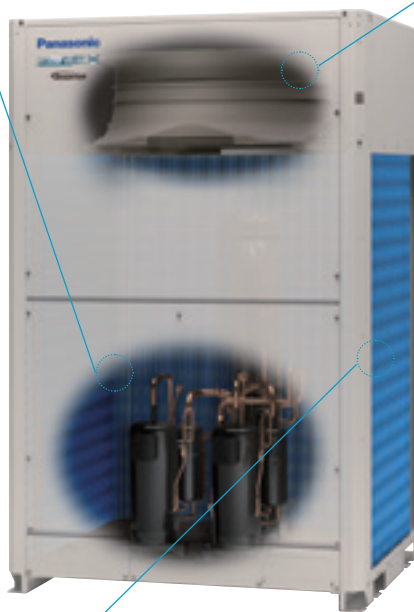

Smooth exhaust flow by new bell-mouth

The new curved shape with integrated top and bottom assure smooth exhaust flow. This gives more air-volume with same sound level, less input power at same air volume.

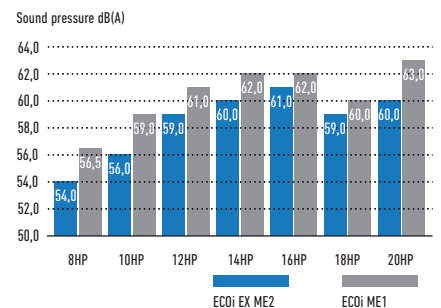
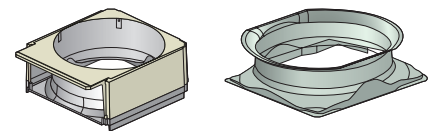

Combined 3 surface heat exchanger

The highly efficient piping pattern increases heat exchange performance by 5%. The new heat exchanger features a 3 surface construction. Compared to the divided dual-surface construction in current models, there is no divided space and the face area of heat exchanger becomes larger.

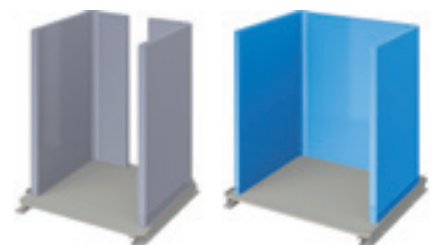

OIL RECOVERY INTELLIGENT CONTROL

Intelligent 3-stage Oil Management System

In a VRF system, where lengthy piping and a large number of indoor units need to be controlled collectively, the key to maintaining the system's reliability is to ensure an appropriate amount of oil is secured in the compressors. In order to avoid oil shortage in the compressor, maximum operation is normally forcibly conducted at regular intervals to recover oil from indoor units. This method, typically employed in a standard VRF, causes the system to overheat or overcool and thus waste energy. In Panasonic VRF systems, a sensor for detecting oil levels is mounted in each compressor. In installations with multiple outdoor units, a shortage of oil in one compressor can be compensated for by recovering oil either from another compressor in the same unit, from a compressor in an adjacent outdoor unit, or from a connected indoor unit. Panasonic VRF systems provide users with a comfortable environment whilst saving energy.

Oil recovery intelligent control advantages:

1. Higher efficiency
2. Durability
3. Comfort:
 - Continuous operation
 - Low noise
 - Low vibration

Features of oil recovery design

Oil sensors installed in each compressor.

Oil sensors installed in each Panasonic compressor precisely monitor oil levels, eliminating unnecessary oil recovery.

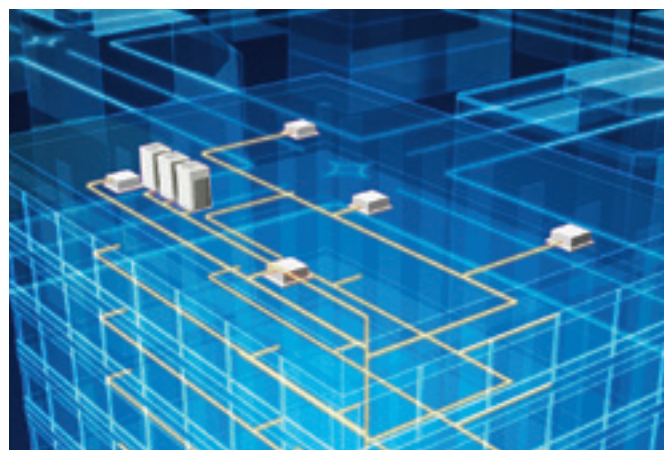
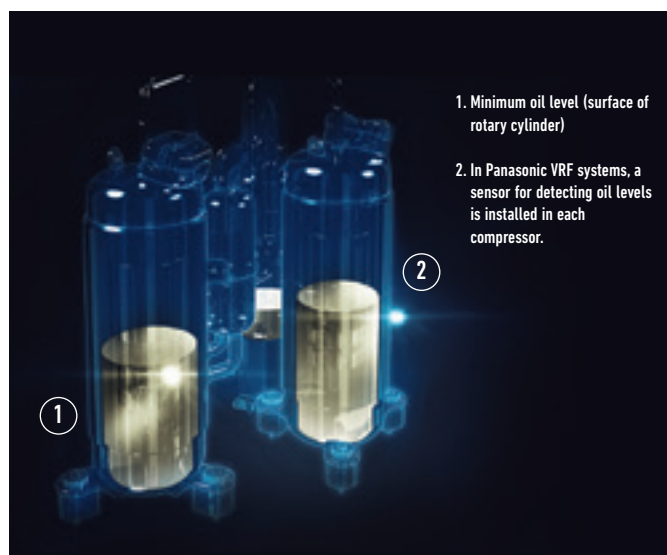

The Panasonic system efficiently manages oil recovery in three stages; minimising the frequency of forced oil recovery while reducing energy cost and maintaining comfort.

STAGE-1: Panasonic compressors are equipped with sensors which monitor oil levels precisely at all times. If oil levels fall, oil can be transferred from other compressors within the same outdoor unit.

STAGE-2: If oil levels in all compressors within the outdoor unit fall, oil can be replenished from adjacent outdoor units.

STAGE-3: Forced oil recovery is implemented only if oil levels become insufficient in spite of above measures. The Panasonic system's design concept is radically different from conventional oil systems.

Highly functional oil separator.

Thanks to extended separate piping, oil recovery efficiency reaches 90%, minimising the oil to be discharged from the compressor.



TWIN ROTARY INVERTER COMPRESSOR

New twin rotary inverter compressor

Two independently controlled inverter compressors achieve high efficiency. Redesigned components in the body provide performance improvement especially in the rated cooling condition and EER performance.

- Wider and flexible control on Inverter compressor
- Better oil lubrication
- Smooth start up



Extraordinary energy-saving performance

Designed for Actual Operation Performance. Panasonic builds air conditioning systems not only with a high EER for rated operation, but also with Seasonal-EER appropriate to the customer's actual environment of use. For instance, with rated operation, outdoor temperature is constant at 35°C, but in reality the outdoor temperature is continuously changing. Consequently, required air conditioning performance also changes. That's why Panasonic implements the following kind of proprietary control.

1. Set temperature is rapidly attained; full-load operating time is kept to a minimum.
2. The frequency of forced oil recovery is minimised. The volume of oil within the compressors is monitored precisely by sensors, so forced oil recovery under full-load operation is conducted only when necessary. Since this suppresses noise due to oil recovery, comfort is maintained.
3. Panasonic pursues a high EER, of course, as well as high EER in part load, for energy saving performance under a broad range of loads. Panasonic's design concept contributes to substantial energy cost reductions.

Compressor efficiency electric system VRF.

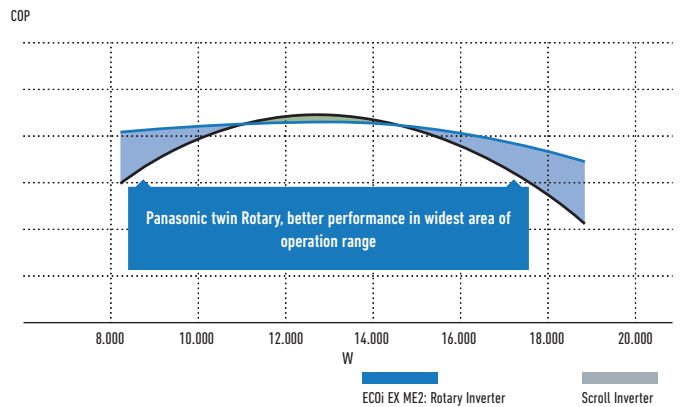

Number of Inverter compressors

Size	2-Pipe ECOi EX ME2				3-Pipe ECOi EX MF3							
	Small		Medium		Medium		Large					
HP	8HP	10HP	12HP	14HP	16HP	18HP	20HP	8HP	10HP	12HP	14HP	16HP
Number	1 pc.		1 pc.	2 pcs.		2 pcs.		1 pc.		2 pcs.		

Actual operation data graph of Panasonic VRF

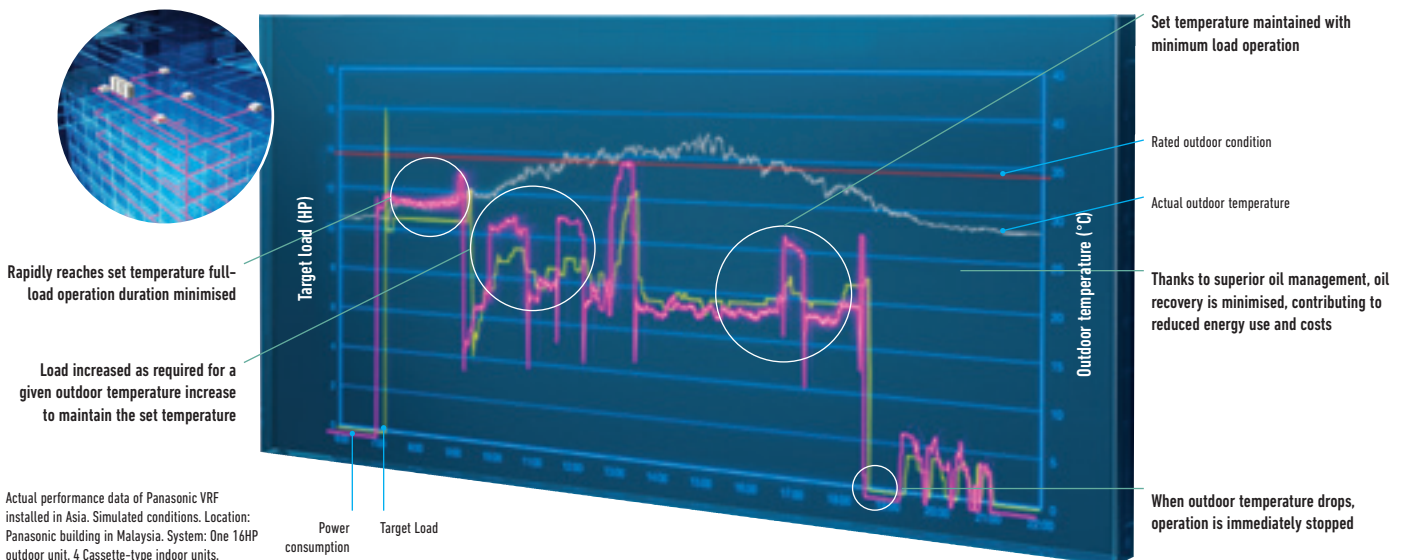

Actual performance data of Panasonic VRF installed in Asia. Simulated conditions. Location: Panasonic building in Malaysia. System: One 16HP outdoor unit, 4 Cassette-type indoor units.

SUPERIOR QUALITY, RELIABILITY AND DURABILITY

High safety operation in case of breakdown!

Automatic Back-Up operation. Ensures heating and cooling.

It is possible for the system to keep working, even if the compressors, fan motor and the temperature sensor are damaged (even when a compressor fails in single unit with 2 compressors inside).

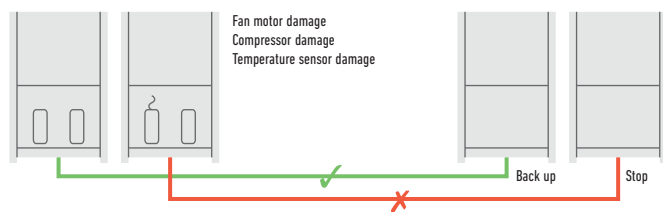

The system will still operate up to 25% of the connected indoor units.

System will not stop when up to 25% of indoor units have power supply breakdown when they are ON Mode.

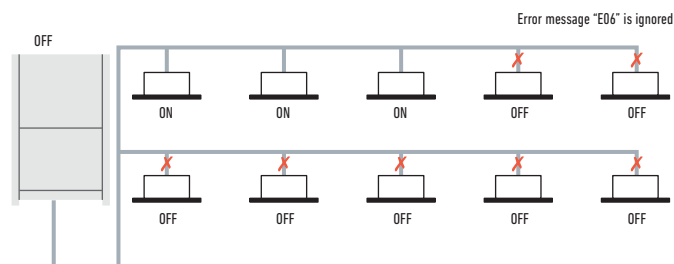

Hi-durability outdoor unit

Treated for high resistance to corrosion (rust and salty air) to ensure long-lasting performance.

Note: Selecting this unit does not completely eliminate the possibility of rust developing. For details concerning unit installation and maintenance, please consult an authorised dealer.

Specially protected parts.

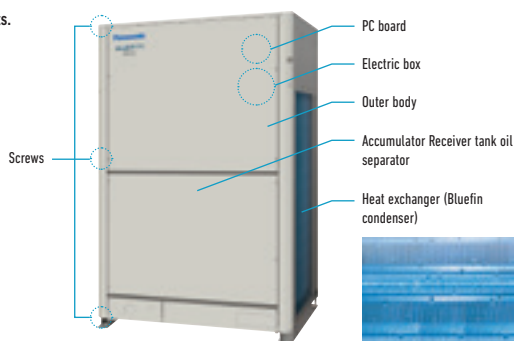

Extended compressor life by uniform compressor operation time

The total run-time of compressors are monitored by a built-in microcomputer, which ensures that operation times of all compressors within the same refrigerant circuit are balanced.

Compressors with histories showing shorter run times are selected first, ensuring equal wear and tear across all units and extending the working life of the system.

System example.

A.C: DC inverter compressor
B.D: Constant speed compressor

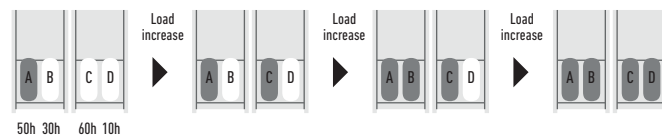

* Depend on accumulated operation time of each compressors.
* Compressor priority has possibility to be changed.
(e.g) Case 1: A→C→B→D, Case 2: C→A→D→B, Case 3: A→C→D→B, Case 4: C→A→B→D
* Also other cases available.

A large number of indoor unit models can be connected



2-PIPE ECOi EX ME2 SERIES EXTRAORDINARY PARTIAL LOAD AND SEER/SCOP

Efficiency in VRF systems

The only way to compare so far, was the nominal efficiency at outdoor ambient temperature of 35°C (EER) in Cooling and at 7°C in heating (COP). With new EN-14825 seasonal efficiency will be shown, the result will be SEER and SCOP. New ECOi EX is reaching excellent performance without using any additional saving functions.

The highest EER/COP rating in most capacities

Compared to conventional model ECOi (ME1)

The ECOi EX marks a revolutionary step forward in VRF efficiency. A look at the incredible EER/COP value clearly indicates that. What's more, this high EER/COP value is achieved even during part load operation. This shows the extraordinary energy-saving performance the ECOi EX is capable of providing.

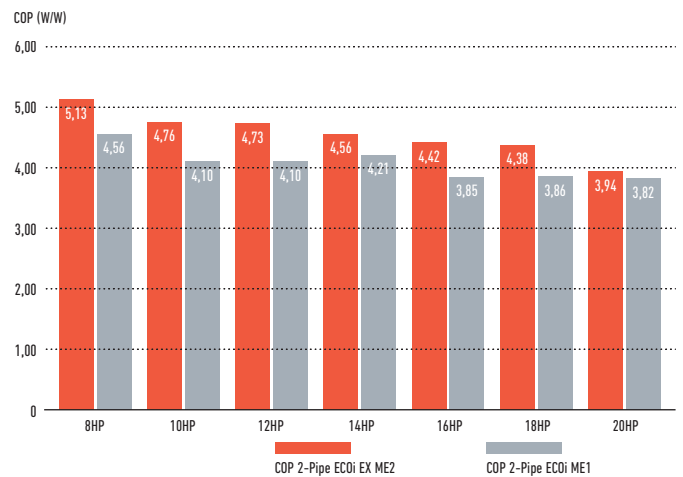
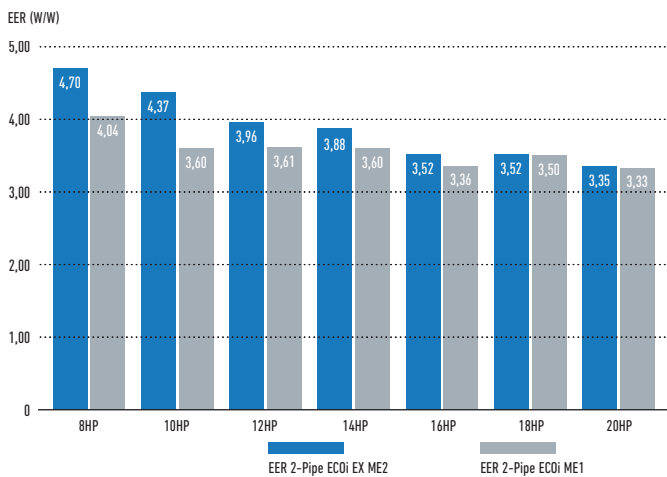

Partial load for seasonal and real system efficiency

VRF units are designed to adapt to the heating and cooling demand, adapting its performance to different outdoor conditions. When compressor runs at lower than 100% capacity, the system is working at partial load. A wider compressor operating range results in better system performance both at full load and partial load conditions. Panasonic ECOi EX partial load is excellent, reaching a minimum of 15% of compressor capacity.

Excellent efficiency at any condition and partial load

In both heating and cooling mode, Panasonic ECOi EX is reaching exceptional levels of efficiency.

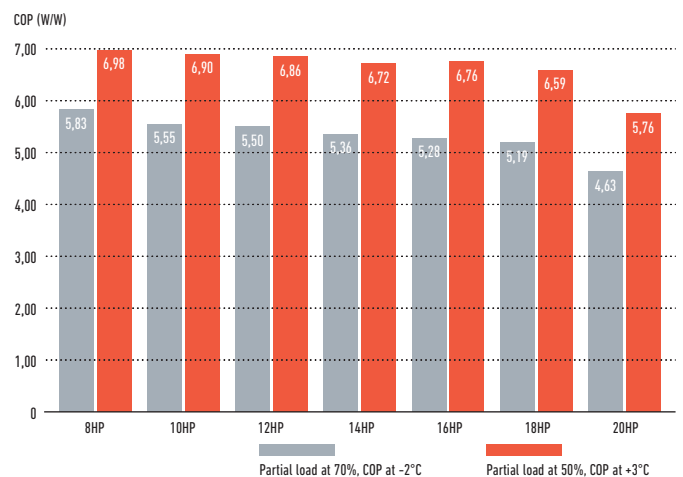
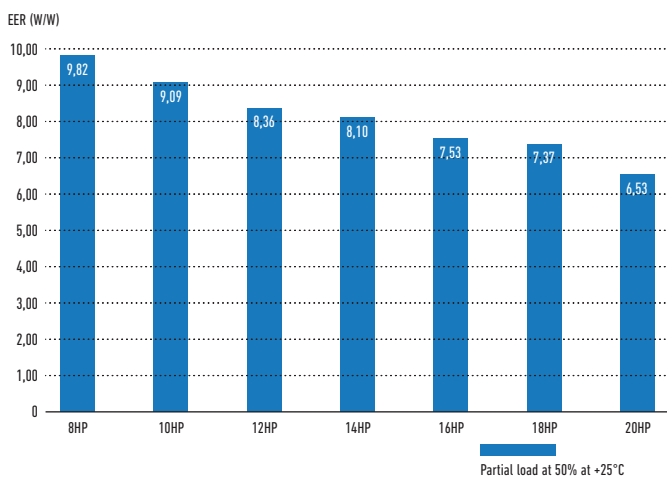

SEER and SCOP following to EN-14825

When better partial load, better efficiency is achieved in real operation. New EN-14825 is showing the way to calculate considering full year operation hours at different conditions. New Panasonic ECOi EX is designed to save energy in any partial load conditions. Most of operation hours system is under partial load conditions, 80% of total operation hours is less than 70% of full load.

In below graphs is the example for average ambient conditions, this uses Strasbourg ambient conditions for calculation.

Outside temperature distribution

Time distribution (hours / year)

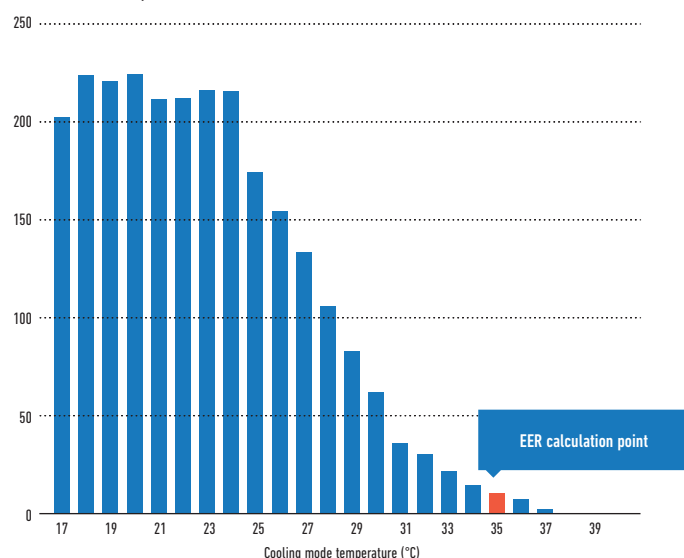

Outside temperature distribution

Time distribution (hours / year)

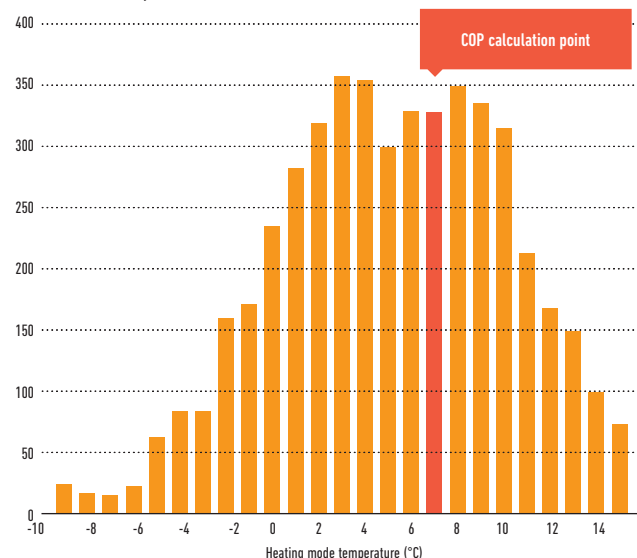

In the characteristics EER and COP only a single temperature for the assessment of the efficiency is taken as a basis in each case. Data calculated under EN-14825 conditions, not additional saving function considered for this calculation. Compressor frequency according to ambient temperature and building design.

SEER and SCOP values

ECOi EX models have superior seasonal space cooling/heating efficiency following not only EN 14825 but also COMMISSION REGULATION (EU) 2016/2281. This regulation requires to use "η" values in the technical documents from January 2018.

Please visit our websites www.aircon.panasonic.eu or www.ptc.panasonic.eu.

SEER / SCOP

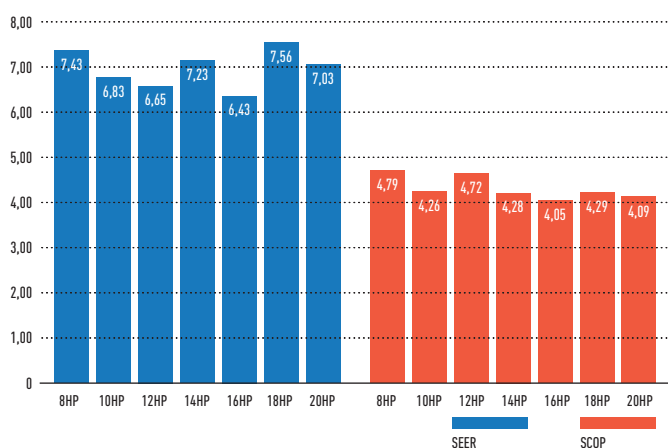

However, if it was necessary by setting on commissioning Panasonic, can increase efficiency additionally by "20%" increasing evaporation refrigerant temperature range, for a higher efficiency and lower energy consumption.

ESEER (W/W)

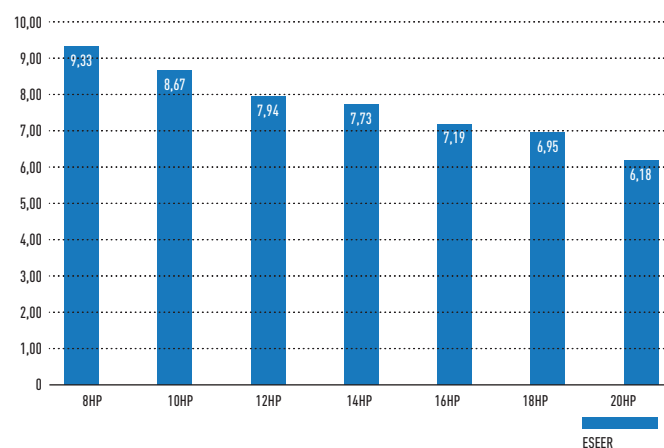

2-PIPE ECOi EX ME2 SERIES HIGH PERFORMANCE AT EXTREME CONDITIONS

The ECOi EX can still operate at 100% capacity when the outside temperature is as high as 43°C. This high power capability enables reliable operation even under extremely high temperature conditions.

Extremely high capacity at -20°C and unique heating capacity at -25°C

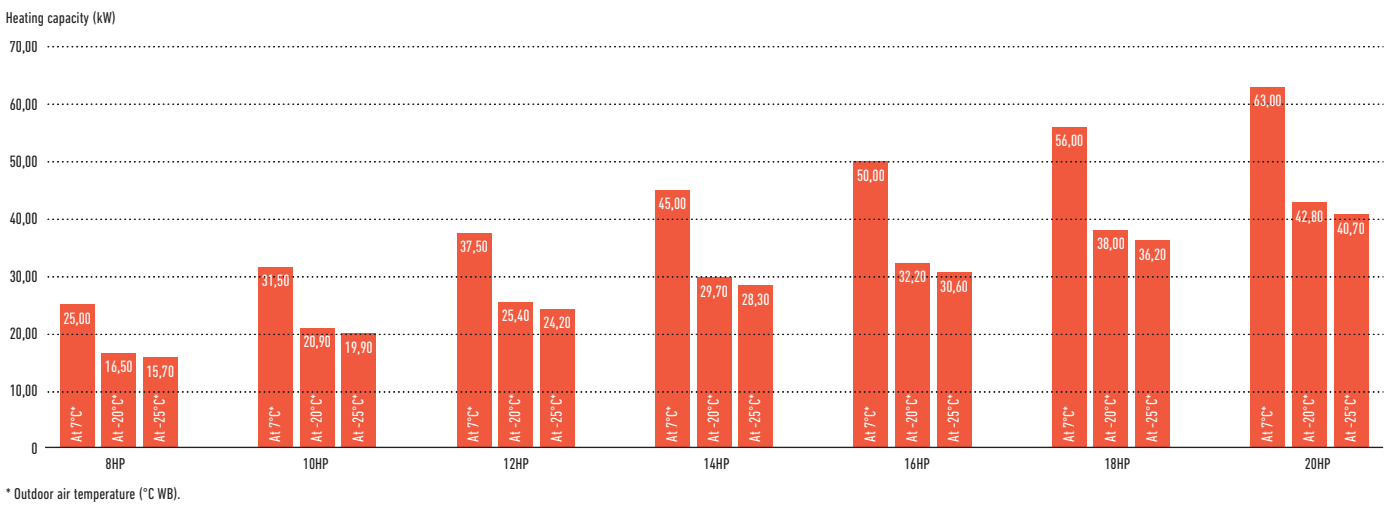

Trusted reliability even under high and low temperature conditions

Designed to be durable enough to withstand extreme heat, 2-Pipe ECOi EX ME2 Series ensures reliable cooling operation over an extended operation range up to 52°C, and heating operation also at minus -25°C.

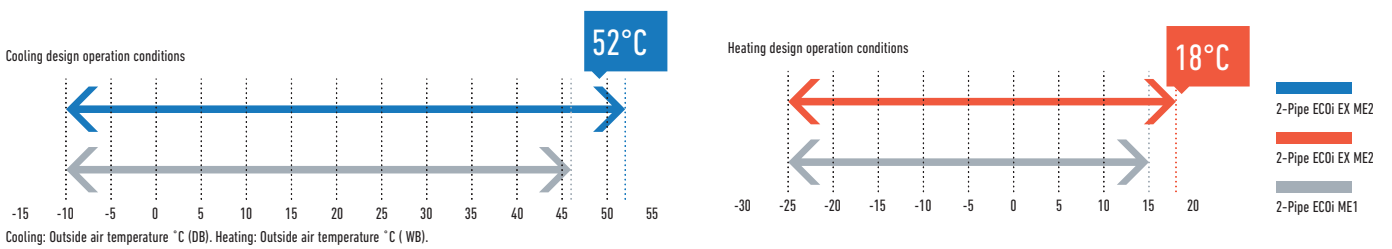

2-PIPE ECOi EX ME2 SERIES SUPERIOR FLEXIBILITY

Connectable maximum allowable indoor / outdoor capacity ratio up to 200%*

ECOi EX attain maximum indoor unit connection capacity of up to 130% of the unit's connection range. This limit can be overpassed and reach up to 200% if some conditions are satisfied. With this feature, ECOi EX provides an ideal air conditioning solution for locations where full cooling/heating are not always required in all spaces at same time.

System (HP)	8	10	12	14	16	18	20	22	24	26	28	30	32	34	36	38	40	42	44	46	48	50	52	54	56	58	60	62	64	66	68	70	72	74	76	78	80						
Connectable indoor units: 130%	13	16	19	23	26	29	33	36	40	43	46	50	53	56	59															64													
Connectable indoor units: 200%	20	25	30	35	40	45	50	55	60											64																							

Note: If more than 100% indoor units are operated with a high load, the units may not perform at the rated capacity. For the details, please consult with an authorised Panasonic dealer. * If the following conditions are satisfied, the effective range is above 130% up to 200%. Obey the limited number of connectable indoor units. The lower limit of operating range for heating outdoor temperature is limited to -10°C WB (standard -25°C WB). Simultaneous operation is limited to less than 130% of connectable indoor units. 1.50kW capacity of Indoor Units are included.

Increased piping lengths and design flexibility

Adaptable to various building types and sizes. Actual piping length: 200m. Maximum piping length: 1.000m.

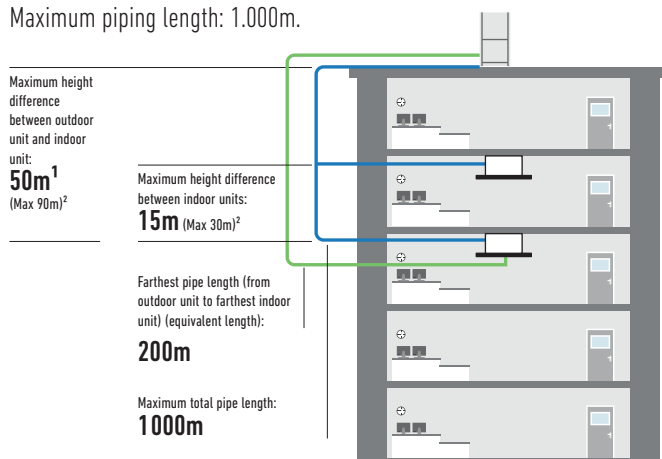

1. 40m if the outdoor unit is below the indoor unit.
2. Setting change is necessary. Please contact an authorized Panasonic dealer in the case of conditions below:
 - 50 < Height difference between OU and IU ≤ 90 or 15 < Height difference between IUs ≤ 30.

Up to 50m length difference between the longest and the shortest piping from the first branch

Flexible piping layout makes it easier to design systems for locations such as train stations, airports, schools and hospitals.

- Up to 64 units can be connected to one system
- Difference between maximum and minimum pipe runs after first branch can be a maximum of 50m
- Larger pipe runs can be up to 200m

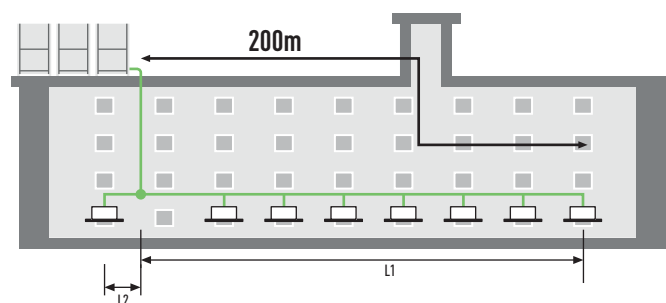

L1 = Longest pipe run. L2 = Shortest pipe run. L1 - L2 = Maximum 50m.

Compact design

The ME2 series has reduced the installation space required with up to 20HP available in a single chassis. 8 - 10HP are able to fit inside a lift for easy handling on site.

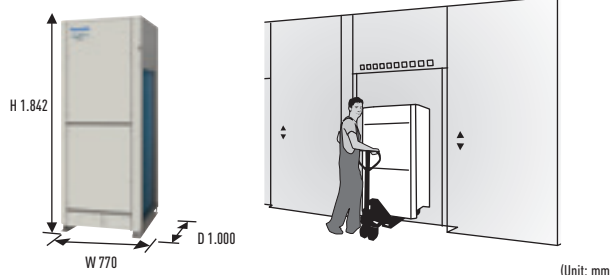
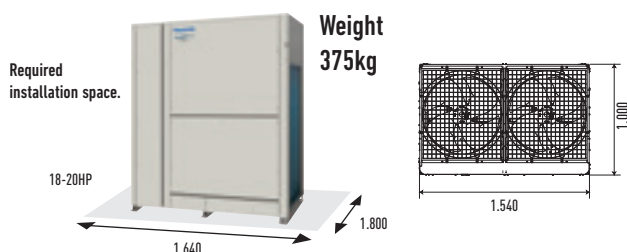

2-PIPE ECOi EX ME2 SERIES PIPING DESIGN

Select installation locations so that the lengths and sizes of refrigerant piping are within the allowable ranges shown in the figure below.

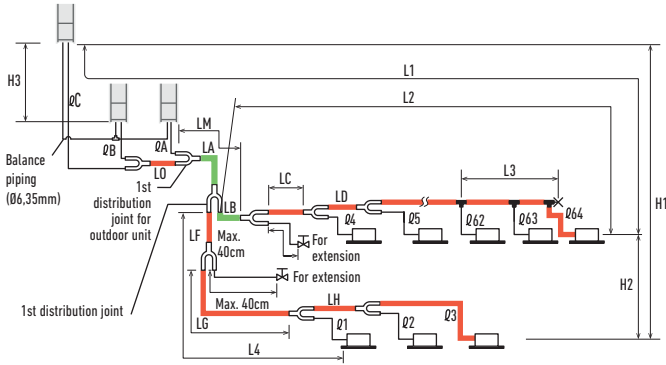

- Main piping length (maximum piping size) LM= LA + LB ...
 - Main distribution tubes LC - LH are selected according to the capacity after the distribution joint.
 - Sizes of indoor unit connection piping Q1 - Q64 are determined by the connection piping sizes on the indoor units.
 - Distribution joint (CZ: optional parts).
 - T-joint (field supply).
 - Ball valve (field supply).
 - Solidly welded shut (pinch weld).
- The outdoor connection main piping (LO portion) is determined by the total capacity of the outdoor units that are connected to the tube ends.
 Note: Be sure to use special R410A distribution joints (CZ: optional parts) for outdoor unit connections and piping branches.
- R410A distribution joint.**
 CZ-P680PH2BM (for outdoor unit)
 CZ-P1350PH2BM (for outdoor unit)
 CZ-P160BK2BM (for indoor unit)
 CZ-P680BK2BM (for indoor unit)
 CZ-P1350BK2BM (for indoor unit)

Ranges that apply to refrigerant piping lengths and to differences in installation heights

Items	Mark	Contents	Length (m)
Allowable piping length	L1	Maximum piping length	Actual length ≤200 ¹⁾ Equivalent length ≤210 ¹⁾
	Δ L (L2-L4)	Difference between maximum length and minimum length from the 1st distribution joint	≤50 ²⁾
	LM	Maximum length of main piping (at maximum size) * Even after 1st distribution joint, LM is allowed if at maximum piping length.	— ³⁾
	Q1, Q2- Q64	Maximum length of each distribution tube	≤50 ⁴⁾
	L1+ Q1+ Q2- Q63+ QA+QB+LF+LG+LH	Total maximum piping length including length of each distribution tube (only liquid piping)	≤1000
Allowable elevation difference	QA, QB+LO, QC+LO	Maximum piping length from outdoor's 1st distribution joint to each outdoor unit	≤10
	H1	When outdoor unit is installed higher than indoor unit	≤50
	H2	When outdoor unit is installed lower than indoor unit	≤40
	H3	Maximum difference between indoor units	≤15
Allowable length of joint piping	L3	T-joint piping (field-supply); Maximum piping length between the first T-joint and solidly welded-shut end point	≤2

L = Length, H = Height

1) If the longest piping length (L1) exceeds 90m (equivalent length), increase the sizes of the main tubes (LM) by 1 rank for gas tubes and liquid tubes. Use a field supply reducer. Select the tube size from the table of main piping sizes (Table 3) and from the table of refrigerant piping sizes (Table 8). 2) When the piping length exceeds 40m, increase a longer liquid or gas piping by 1 rank. Refer to the Technical Data for the details. 3) If the longest main piping length (LM) exceeds 50m, increase the main piping size at the portion before 50m by 1 rank for the gas tubes. Use a field supply reducer. Determine the length less than the limitation of allowable maximum piping length. For the portion that exceeds 50m, set based on the main piping size (LA) listed in Table 3. 4) If any of the piping length exceeds 30m, increase the size of the liquid and gas tubes by 1 rank. 5) If the total distribution piping length exceeds 500m, maximum allowable elevation difference (H2) between the indoor units is calculated by the following formula. Make sure the indoor unit's actual elevation difference should fall within the figure calculated as follows. Unit of account (meter): $15 \times 2 - \text{total piping length (m)} \div 500$.
 * The outdoor connection main piping (LO portion) is determined by the total capacity of the outdoor units that are connected to the tube ends. If the size of the existing piping is already larger than the standard piping size, it is not necessary to further increase the size. ** If the existing piping is used, and the amount of on-site refrigerant charge exceeds the value listed below, then change the size of the piping to reduce the amount of refrigerant. Total amount of refrigerant for the system with 1 outdoor unit: 50kg. Total amount of refrigerant for the system with 2 outdoor units: 80kg. Total amount of refrigerant for the system with 3 outdoor units or 4 outdoor units: 105kg.

Necessary amount of additional refrigerant charge per outdoor unit.

U-8ME2E8	U-10ME2E8	U-12ME2E8	U-14ME2E8	U-16ME2E8
5,5kg	5,5kg	7,0kg	7,0kg	7,0kg

System limitations.

Maximum number allowable connected outdoor units	4 ¹⁾
Maximum capacity allowable connected outdoor units	224kW (80HP)
Maximum connectable indoor units	64 ²⁾
Maximum allowable indoor / outdoor capacity ratio	50-130% ³⁾

1) Up to 4 units can be connected if the system has been extended.
 2) In the case of 38HP or smaller units, the number is limited by the total capacity of the connected indoor units.
 3) If the following conditions are satisfied, the effective range is above 130% and below 200%.
 A) Obey the limited number of connectable indoor units. B) The lower limit of operating range for heating outdoor temperature is limited to -10°C WB (standard -25°C WB). C) Simultaneous operation is limited to less than 130% of connectable indoor units.

Additional refrigerant charge.

Liquid piping size Inch (mm)	Amount of refrigerant charge/m (g/m)
1/4 (6,35)	26
3/8 (9,52)	56
1/2 (12,70)	128
5/8 (15,88)	185
3/4 (19,05)	259
7/8 (22,22)	366
1 (25,40)	490

Refrigerant piping (existing piping can be used).

Piping size (mm)				Material Temper - 1/2 H, H									
Material Temper - 0				Material Temper - 1/2 H, H									
Ø6,35	t 0,8	Ø12,70	t 0,8	Ø19,05	t 1,2	Ø22,22	t 1,0	Ø28,58	t 1,0	Ø38,10	over t 1,35	Ø44,45	over t1,55
Ø9,52	t 0,8	Ø15,88	t 1,0			Ø25,40	t 1,0	Ø31,75	t 1,1	Ø41,28	over t 1,45	Ø44,45	over t1,55

* When bending the tubes, use a bending radius that is at least 4 times the outer diameter of the tubes. In addition, take sufficient care to avoid crushing or damaging the tubes when bending them.

2-Pipe ECOi EX ME2 Series



A VRF system delivering energy-saving performance, powerful operation, reliability and comfort surpassing anything previously possible. It represents a true paradigm shift in air conditioning solutions

VRF with outstanding energy-saving performance and powerful operation SEER 7,56 (18HP model).

Technical focus

- New twin rotary inverter compressor
- High performance at extreme conditions
- Outstanding efficiency and comfort
- Extraordinary partial load and SEER/SCOP
- SEER and SCOP following to EN-14825
- Oil recovery intelligent control
- Top comfort
- Superior flexibility
- Bluefin full line up EX
- Extremely high capacity at -20°C and unique heating capacity at -25°C
- Smooth exhaust flow by new bell-mouth

			8HP	10HP	12HP	14HP	16HP	18HP	20HP
Outdoor Units			U-8ME2E8	U-10ME2E8	U-12ME2E8	U-14ME2E8	U-16ME2E8	U-18ME2E8	U-20ME2E8
Power supply	Voltage	V	380 / 400 / 415	380 / 400 / 415	380 / 400 / 415	380 / 400 / 415	380 / 400 / 415	380 / 400 / 415	380 / 400 / 415
	Phase		Three Phase	Three Phase	Three Phase	Three Phase	Three Phase	Three Phase	Three Phase
	Frequency	Hz	50	50	50	50	50	50	50
Cooling capacity		kW	22,40	28,00	33,50	40,00	45,00	50,00	56,00
EER ¹⁾		W/W	4,70	4,37	3,96	3,88	3,52	3,52	3,35
ESEER		W/W	9,33	8,67	7,94	7,73	7,19	6,95	6,18
SEER ²⁾			7,43	6,83	6,65	7,23	6,43	7,56	7,03
Running current cooling		A	7,40 / 7,14	10,20 / 9,80	13,00 / 12,50	16,50 / 15,90	20,10 / 19,40	22,00 / 21,20	25,40 / 24,50
Input power cooling		kW	4,77	6,41	8,47	10,30	12,80	14,20	16,70
Heating capacity		kW	25,00	31,50	37,50	45,00	50,00	56,00	63,00
COP ¹⁾		W/W	5,13	4,76	4,73	4,56	4,42	4,38	3,94
SCOP ²⁾			4,79	4,26	4,72	4,28	4,05	4,29	4,09
Running current heating		A	7,56 / 7,29	10,50 / 11,10	12,30 / 11,80	15,80 / 15,20	17,90 / 17,30	20,10 / 19,40	24,60 / 23,70
Input power heating		kW	4,87	6,62	7,92	9,86	11,30	12,80	16,00
Starting current		A	1,00	1,00	1,00	2,00	2,00	2,00	2,00
External static pressure (Max)		Pa	80	80	80	80	80	80	80
Air volume		m ³ /min	224	224	232	232	232	405	405
Sound pressure	Normal mode	dB(A)	54	56	59	60	61	59	60
	Silent mode	dB(A)	51	53	56	57	58	56	57
Sound power	Normal mode	dB	75	77	80	81	82	80	81
Dimension	HxWxD	mm	1842 x 770 x 1000	1842 x 770 x 1000	1842 x 1180 x 1000	1842 x 1180 x 1000	1842 x 1180 x 1000	1842 x 1540 x 1000	1842 x 1540 x 1000
Net weight		kg	210	210	270	315	315	375	375
Piping connections ³⁾	Liquid pipe	Inch (mm)	3/8 (9,52) / 1/2 (12,70)	3/8 (9,52) / 1/2 (12,70)	1/2 (12,70) / 5/8 (15,88)	1/2 (12,70) / 5/8 (15,88)	1/2 (12,70) / 5/8 (15,88)	5/8 (15,88) / 3/4 (19,05)	5/8 (15,88) / 3/4 (19,05)
	Gas pipe	Inch (mm)	3/4 (19,05) / 7/8 (22,22)	7/8 (22,22) / 1 (25,40)	1 (25,40) / 1-1/8 (28,58)	1 (25,40) / 1-1/8 (28,58)	1-1/8 (28,58) / 1-1/4 (31,75)	1-1/8 (28,58) / 1-1/4 (31,75)	1-1/8 (28,58) / 1-1/4 (31,75)
	Balance pipe	Inch (mm)	1/4 (6,35)	1/4 (6,35)	1/4 (6,35)	1/4 (6,35)	1/4 (6,35)	1/4 (6,35)	1/4 (6,35)
Refrigerant (R410A) / CO ₂ Eq.		kg / T	5,60 / 11,6928	5,60 / 11,6928	8,30 / 17,3304	8,30 / 17,3304	8,30 / 17,3304	9,50 / 19,836	9,50 / 19,836
Maximum allowable indoor / outdoor capacity ratio % ⁴⁾			50 ~ 130 (200)	50 ~ 130 (200)	50 ~ 130 (200)	50 ~ 130 (200)	50 ~ 130 (200)	50 ~ 130 (200)	50 ~ 130 (200)
Operating range	Cool Min ~ Max	°C	-10 ~ +52	-10 ~ +52	-10 ~ +52	-10 ~ +52	-10 ~ +52	-10 ~ +52	-10 ~ +52
	Heat Min ~ Max	°C	-25 ~ +18	-25 ~ +18	-25 ~ +18	-25 ~ +18	-25 ~ +18	-25 ~ +18	-25 ~ +18

1) EER and COP calculation is based in accordance to EN14511. 2) SEER/SCOP is calculated based on the seasonal space cooling/heating efficiency "η" values of the COMMISSION REGULATION (EU) 2016/2281. SEER, SCOP = (η + Correction) × PEF. 3) Pipe diameter under 90m for ultimate indoor unit / over 90m for ultimate indoor unit (if the longest piping equivalent length exceeds 90m, increase the sizes of the main tubes by 1 rank for gas tubes and liquid tubes). 4) If the following conditions are satisfied, the effective range is above 130% and below 200%: A. Obey the limited number of connectable indoor units. B. The lower limit of operating range for heating outdoor temperature is limited to -10°C WB (standard -25°C WB). C. Simultaneous operation is limited to less than 130% of connectable indoor units.



2-Pipe ECOi EX ME2 Series

High Efficiency model combination

from 18 to 64HP

			18HP	20HP	22HP	24HP	26HP	28HP
Model name			U-8ME2E8 U-10ME2E8	U-10ME2E8 U-10ME2E8	U-10ME2E8 U-12ME2E8	U-12ME2E8 U-12ME2E8	U-10ME2E8 U-16ME2E8	U-12ME2E8 U-16ME2E8
Power supply	Voltage	V	380 / 400 / 415	380 / 400 / 415	380 / 400 / 415	380 / 400 / 415	380 / 400 / 415	380 / 400 / 415
	Phase		Three Phase	Three Phase	Three Phase	Three Phase	Three Phase	Three Phase
	Frequency	Hz	50	50	50	50	50	50
Cooling capacity		kW	50,00	56,00	61,50	68,00	73,00	78,50
EER ¹⁾		W/W	4,55	4,38	4,13	3,93	3,80	3,69
Running current cooling		A	17,30 / 16,60	20,30 / 19,60	23,10 / 22,30	26,60 / 25,60	30,10 / 29,00	33,10 / 31,90
Input power cooling		kW	11,00	12,80	14,90	17,30	19,20	21,30
Heating capacity		kW	56,00	63,00	69,00	76,50	81,50	87,50
COP ¹⁾		W/W	4,96	4,77	4,76	4,69	4,55	4,56
Running current heating		A	17,70 / 17,10	20,90 / 20,20	22,70 / 21,90	25,30 / 24,40	28,40 / 27,40	30,10 / 29,00
Input power heating		kW	11,30	13,20	14,50	16,30	17,90	19,20
Starting current		A	2,00	2,00	2,00	2,00	3,00	3,00
External static pressure (Max)		Pa	80	80	80	80	80	80
Air volume		m ³ /min	448	448	456	464	456	464
Sound pressure	Normal / Silent mode	dB(A)	58,50 / 55,50	59,00 / 56,00	61,00 / 58,00	62,00 / 59,00	62,50 / 59,50	63,50 / 60,50
Sound power	Normal mode	dB	79,50	80,00	82,00	83,00	83,50	84,50
Dimension / Net weight	HxWxD	mm / kg	1842 x 1600 x 1000 / 420	1842 x 1600 x 1000 / 420	1842 x 2010 x 1000 / 480	1842 x 2420 x 1000 / 540	1842 x 2010 x 1000 / 535	1842 x 2420 x 1000 / 585
Piping connections ²⁾	Liquid pipe	Inch (mm)	5/8(15,88) / 3/4(19,05)	5/8(15,88) / 3/4(19,05)	5/8(15,88) / 3/4(19,05)	5/8(15,88) / 3/4(19,05)	3/4(19,05) / 7/8(22,22)	3/4(19,05) / 7/8(22,22)
	Gas pipe	Inch (mm)	1-1/8(28,58) / 1-1/4(31,75)	1-1/8(28,58) / 1-1/4(31,75)	1-1/8(28,58) / 1-1/4(31,75)	1-1/8(28,58) / 1-1/4(31,75)	1-1/4(31,75) / 1-1/2(38,10)	1-1/4(31,75) / 1-1/2(38,10)
	Balance pipe	Inch (mm)	1/4(6,35)	1/4(6,35)	1/4(6,35)	1/4(6,35)	1/4(6,35)	1/4(6,35)
Refrigerant (R410A) / CO ₂ Eq.		kg / T	11,20 / 23,3856	11,20 / 23,3856	13,90 / 29,0232	16,60 / 34,6608	13,90 / 29,0232	16,60 / 34,6608
Maximum allowable indoor / outdoor capacity ratio % ³⁾			50 ~ 130(200)	50 ~ 130(200)	50 ~ 130(200)	50 ~ 130(200)	50 ~ 130(200)	50 ~ 130(200)
Operating range	Cool / Heat Min ~ Max	°C	-10 ~ +52 / -25 ~ +18	-10 ~ +52 / -25 ~ +18	-10 ~ +52 / -25 ~ +18	-10 ~ +52 / -25 ~ +18	-10 ~ +52 / -25 ~ +18	-10 ~ +52 / -25 ~ +18

			30HP	32HP	34HP	36HP	38HP	40HP
Model name			U-14ME2E8 U-16ME2E8	U-16ME2E8 U-16ME2E8	U-10ME2E8 U-12ME2E8 U-12ME2E8	U-12ME2E8 U-12ME2E8 U-12ME2E8	U-10ME2E8 U-12ME2E8 U-16ME2E8	U-12ME2E8 U-12ME2E8 U-16ME2E8
Power supply	Voltage	V	380 / 400 / 415	380 / 400 / 415	380 / 400 / 415	380 / 400 / 415	380 / 400 / 415	380 / 400 / 415
	Phase		Three Phase	Three Phase	Three Phase	Three Phase	Three Phase	Three Phase
	Frequency	Hz	50	50	50	50	50	50
Cooling capacity		kW	85,00	90,00	96,00	101,00	107,00	113,00
EER ¹⁾		W/W	3,68	3,52	4,05	3,95	3,84	3,75
Running current cooling		A	36,60 / 35,30	40,20 / 38,70	36,80 / 35,50	39,30 / 37,90	43,80 / 42,20	46,70 / 45,00
Input power cooling		kW	23,10	25,60	23,70	25,60	27,90	30,10
Heating capacity		kW	95,00	100,00	108,00	113,00	119,00	127,00
COP ¹⁾		W/W	4,48	4,42	4,72	4,73	4,61	4,57
Running current heating		A	33,60 / 32,40	35,80 / 34,60	35,90 / 34,60	37,10 / 35,80	40,50 / 39,00	43,60 / 42,00
Input power heating		kW	21,20	22,60	22,90	23,90	25,80	27,80
Starting current		A	4,00	4,00	3,00	3,00	4,00	4,00
External static pressure (Max)		Pa	80	80	80	80	80	80
Air volume		m ³ /min	464	464	688	696	688	696
Sound pressure	Normal / Silent mode	dB(A)	63,50 / 60,50	64,00 / 61,00	63,00 / 60,00	64,00 / 61,00	64,00 / 61,00	64,50 / 61,50
Sound power	Normal mode	dB	84,50	85,00	84,00	85,00	85,00	85,50
Dimension / Net weight	HxWxD	mm / kg	1842 x 2420 x 1000 / 630	1842 x 2420 x 1000 / 630	1842 x 3250 x 1000 / 750	1842 x 3660 x 1000 / 810	1842 x 3250 x 1000 / 795	1842 x 3660 x 1000 / 855
Piping connections ²⁾	Liquid pipe	Inch (mm)	3/4(19,05) / 7/8(22,22)	3/4(19,05) / 7/8(22,22)	3/4(19,05) / 7/8(22,22)	3/4(19,05) / 7/8(22,22)	3/4(19,05) / 7/8(22,22)	3/4(19,05) / 7/8(22,22)
	Gas pipe	Inch (mm)	1-1/4(31,75) / 1-1/2(38,10)	1-1/4(31,75) / 1-1/2(38,10)	1-1/4(31,75) / 1-1/2(38,10)	1-1/2(38,10) / 1-5/8(41,28)	1-1/2(38,10) / 1-5/8(41,28)	1-1/2(38,10) / 1-5/8(41,28)
	Balance pipe	Inch (mm)	1/4(6,35)	1/4(6,35)	1/4(6,35)	1/4(6,35)	1/4(6,35)	1/4(6,35)
Refrigerant (R410A) / CO ₂ Eq.		kg / T	16,60 / 34,6608	16,60 / 34,6608	22,20 / 46,3536	24,90 / 51,9912	22,20 / 46,3536	24,90 / 46,3536
Maximum allowable indoor / outdoor capacity ratio % ³⁾			50 ~ 130(200)	50 ~ 130(200)	50 ~ 130(200)	50 ~ 130(200)	50 ~ 130(200)	50 ~ 130(200)
Operating range	Cool / Heat Min ~ Max	°C	-10 ~ +52 / -25 ~ +18	-10 ~ +52 / -25 ~ +18	-10 ~ +52 / -25 ~ +18	-10 ~ +52 / -25 ~ +18	-10 ~ +52 / -25 ~ +18	-10 ~ +52 / -25 ~ +18

Data is for reference. 1) EER and COP calculation is based in accordance to EN14511. 2) Pipe diameter under 90m for ultimate indoor unit / over 90m for ultimate indoor unit (if the longest piping equivalent length exceeds 90m, increase the sizes of the main tubes by 1 rank for gas tubes and liquid tubes). 3) If the following conditions are satisfied, the effective range is above 130% and below 200%: A. Obey the limited number of connectable indoor units. B. The lower limit of operating range for heating outdoor temperature is limited to -10°C WB (standard -25°C WB). C. Simultaneous operation is limited to less than 130% of connectable indoor units.



			42HP	44HP	46HP	48HP	50HP	52HP
Model name			U-10ME2E8	U-12ME2E8	U-14ME2E8	U-16ME2E8	U-10ME2E8	U-12ME2E8
			U-16ME2E8	U-16ME2E8	U-16ME2E8	U-16ME2E8	U-12ME2E8	U-12ME2E8
			U-16ME2E8	U-16ME2E8	U-16ME2E8	U-16ME2E8	U-16ME2E8	U-16ME2E8
Power supply	Voltage	V	380 / 400 / 415	380 / 400 / 415	380 / 400 / 415	380 / 400 / 415	380 / 400 / 415	380 / 400 / 415
	Phase		Three Phase	Three Phase	Three Phase	Three Phase	Three Phase	Three Phase
	Frequency	Hz	50	50	50	50	50	50
Cooling capacity		kW	118,00	124,00	130,00	135,00	140,00	145,00
EER ¹⁾		W/W	3,69	3,62	3,62	3,52	3,87	3,82
Running current cooling		A	50,20 / 48,40	53,20 / 51,30	56,90 / 54,90	60,20 / 58,10	56,20 / 54,20	59,00 / 56,80
Input power cooling		kW	32,00	34,30	35,90	38,40	36,20	38,00
Heating capacity		kW	132,00	138,00	145,00	150,00	155,00	160,00
COP ¹⁾		W/W	4,49	4,50	4,46	4,42	4,65	4,66
Running current heating		A	46,60 / 44,90	48,20 / 46,40	51,50 / 49,70	53,80 / 51,80	52,20 / 50,40	53,80 / 51,90
Input power heating		kW	29,40	30,70	32,50	33,90	33,30	34,30
Starting current		A	5,00	5,00	6,00	6,00	5,00	5,00
External static pressure (Max)		Pa	80	80	80	80	80	80
Air volume		m ³ /min	688	696	696	696	920	928
Sound pressure	Normal / Silent mode	dB(A)	65,00 / 62,00	65,50 / 62,50	65,50 / 62,50	66,00 / 63,00	65,50 / 62,50	66,00 / 63,00
Sound power	Normal mode	dB	86,00	86,50	86,50	87,00	86,50	87,00
Dimension / Net weight	HxWxD	mm / kg	1842x3250 x1000/840	1842x3660 x1000/900	1842x3660 x1000/945	1842x3660 x1000/945	1842x4490 x1000/1065	1842x4900 x1000/1125
Piping connections ²⁾	Liquid pipe	Inch (mm)	3/4 (19,05) / 7/8 (22,22)	3/4 (19,05) / 7/8 (22,22)	3/4 (19,05) / 7/8 (22,22)	3/4 (19,05) / 7/8 (22,22)	3/4 (19,05) / 7/8 (22,22)	3/4 (19,05) / 7/8 (22,22)
	Gas pipe	Inch (mm)	1-1/2 (38,10) / 1-5/8 (41,28)	1-1/2 (38,10) / 1-5/8 (41,28)	1-1/2 (38,10) / 1-5/8 (41,28)	1-1/2 (38,10) / 1-5/8 (41,28)	1-1/2 (38,10) / 1-5/8 (41,28)	1-1/2 (38,10) / 1-5/8 (41,28)
	Balance pipe	Inch (mm)	1/4 (6,35)	1/4 (6,35)	1/4 (6,35)	1/4 (6,35)	1/4 (6,35)	1/4 (6,35)
Refrigerant (R410A) / CO ₂ Eq.		kg / T	22,20 / 51,9912	24,90 / 51,9912	24,90 / 51,9912	24,90 / 51,9912	30,50 / 63,6840	33,20 / 69,3216
Maximum allowable indoor / outdoor capacity ratio % ³⁾			50 ~ 130 (200)	50 ~ 130 (200)	50 ~ 130 (200)	50 ~ 130 (200)	50 ~ 130 (200)	50 ~ 130 (200)
Operating range	Cool / Heat Min ~ Max	°C	-10 ~ +52 / -25 ~ +18	-10 ~ +52 / -25 ~ +18	-10 ~ +52 / -25 ~ +18	-10 ~ +52 / -25 ~ +18	-10 ~ +52 / -25 ~ +18	-10 ~ +52 / -25 ~ +18

			54HP	56HP	58HP	60HP	62HP	64HP
Model name			U-10ME2E8	U-12ME2E8	U-10ME2E8	U-12ME2E8	U-14ME2E8	U-16ME2E8
			U-12ME2E8	U-12ME2E8	U-16ME2E8	U-16ME2E8	U-16ME2E8	U-16ME2E8
			U-16ME2E8	U-16ME2E8	U-16ME2E8	U-16ME2E8	U-16ME2E8	U-16ME2E8
			U-16ME2E8	U-16ME2E8	U-16ME2E8	U-16ME2E8	U-16ME2E8	U-16ME2E8
Power supply	Voltage	V	380 / 400 / 415	380 / 400 / 415	380 / 400 / 415	380 / 400 / 415	380 / 400 / 415	380 / 400 / 415
	Phase		Three Phase	Three Phase	Three Phase	Three Phase	Three Phase	Three Phase
	Frequency	Hz	50	50	50	50	50	50
Cooling capacity		kW	151,00	156,00	162,00	168,00	174,00	180,00
EER ¹⁾		W/W	3,75	3,71	3,65	3,60	3,60	3,52
Running current cooling		A	63,20 / 60,90	65,30 / 63,00	69,70 / 67,10	73,30 / 70,60	75,80 / 73,00	80,30 / 77,40
Input power cooling		kW	40,30	42,10	44,40	46,70	48,30	51,20
Heating capacity		kW	169,00	175,00	182,00	189,00	195,00	201,00
COP ¹⁾		W/W	4,56	4,56	4,47	4,47	4,45	4,42
Running current heating		A	58,80 / 56,70	60,20 / 58,10	64,60 / 62,20	67,10 / 64,70	69,50 / 67,00	72,20 / 69,60
Input power heating		kW	37,10	38,40	40,70	42,30	43,80	45,50
Starting current		A	6,00	6,00	7,00	7,00	8,00	8,00
External static pressure (Max)		Pa	80	80	80	80	80	80
Air volume		m ³ /min	920	928	920	928	928	928
Sound pressure	Normal / Silent mode	dB(A)	66,00 / 63,00	66,50 / 63,50	66,50 / 63,50	67,00 / 64,00	67,00 / 64,00	67,00 / 64,00
Sound power	Normal mode	dB	87,00	87,50	87,50	88,00	88,00	88,00
Dimension / Net weight	HxWxD	mm / kg	1842x4490 x1000/1110	1842x4900 x1000/1170	1842x4490 x1000/1155	1842x4900 x1000/1215	1842x4900 x1000/1260	1842x4900 x1000/1260
Piping connections ²⁾	Liquid pipe	Inch (mm)	3/4 (19,05) / 7/8 (22,22)	3/4 (19,05) / 7/8 (22,22)	3/4 (19,05) / 7/8 (22,22)	3/4 (19,05) / 7/8 (22,22)	3/4 (19,05) / 7/8 (22,22)	3/4 (19,05) / 7/8 (22,22)
	Gas pipe	Inch (mm)	1-1/2 (38,10) / 1-5/8 (41,28)	1-1/2 (38,10) / 1-5/8 (41,28)	1-1/2 (38,10) / 1-5/8 (41,28)	1-1/2 (38,10) / 1-5/8 (41,28)	1-5/8 (41,28) / 1-3/4 (44,45)	1-5/8 (41,28) / 1-3/4 (44,45)
	Balance pipe	Inch (mm)	1/4 (6,35)	1/4 (6,35)	1/4 (6,35)	1/4 (6,35)	1/4 (6,35)	1/4 (6,35)
Refrigerant (R410A) / CO ₂ Eq.		kg / T	30,50 / 63,6840	33,20 / 69,3216	30,50 / 63,6840	33,20 / 69,3216	33,20 / 69,3216	33,20 / 69,3216
Maximum allowable indoor / outdoor capacity ratio % ³⁾			50 ~ 130 (200)	50 ~ 130 (200)	50 ~ 130 (200)	50 ~ 130 (200)	50 ~ 130 (200)	50 ~ 130 (200)
Operating range	Cool / Heat Min ~ Max	°C	-10 ~ +52 / -25 ~ +18	-10 ~ +52 / -25 ~ +18	-10 ~ +52 / -25 ~ +18	-10 ~ +52 / -25 ~ +18	-10 ~ +52 / -25 ~ +18	-10 ~ +52 / -25 ~ +18

Data is for reference. 1) EER and COP calculation is based in accordance to EN14511. 2) Pipe diameter under 90m for ultimate indoor unit / over 90m for ultimate indoor unit (if the longest piping equivalent length exceeds 90m, increase the sizes of the main tubes by 1 rank for gas tubes and liquid tubes). 3) If the following conditions are satisfied, the effective range is above 130% and below 200%: A. Obey the limited number of connectable indoor units. B. The lower limit of operating range for heating outdoor temperature is limited to -10°C WB (standard -25°C WB). C. Simultaneous operation is limited to less than 130% of connectable indoor units.

2-Pipe ECOi EX ME2 Series

Space Saving model combination

from 22 to 80HP

			22HP	24HP	26HP	28HP	30HP	32HP	34HP
Model name			U-10ME2E8 U-12ME2E8	U-12ME2E8 U-12ME2E8	U-10ME2E8 U-16ME2E8	U-12ME2E8 U-16ME2E8	U-14ME2E8 U-16ME2E8	U-16ME2E8 U-16ME2E8	U-14ME2E8 U-20ME2E8
Power supply	Voltage	V	380/400/415	380/400/415	380/400/415	380/400/415	380/400/415	380/400/415	380/400/415
	Phase		Three Phase	Three Phase	Three Phase	Three Phase	Three Phase	Three Phase	Three Phase
	Frequency	Hz	50	50	50	50	50	50	50
Cooling capacity		kW	61,50	68,00	73,00	78,50	85,00	90,00	96,00
EER ¹⁾		W/W	4,13	3,93	3,80	3,69	3,68	3,52	3,56
Running current cooling		A	23,10/22,30	26,60/25,60	30,10/29,00	33,10/31,90	36,60/35,30	40,20/38,70	41,90/40,40
Input power cooling		kW	14,90	17,30	19,20	21,30	23,10	25,60	27,00
Heating capacity		kW	69,00	76,50	81,50	87,50	95,00	100,00	108,00
COP ¹⁾		W/W	4,76	4,69	4,55	4,56	4,48	4,42	4,17
Running current heating		A	22,70/21,90	25,30/24,40	28,40/27,40	30,10/29,00	33,60/32,40	35,80/34,60	40,60/39,20
Input power heating		kW	14,50	16,30	17,90	19,20	21,20	22,60	25,90
Starting current		A	2,00	2,00	3,00	3,00	4,00	4,00	4,00
External static pressure (Max)		Pa	80	80	80	80	80	80	80
Air volume		m ³ /min	456	464	456	464	464	464	637
Sound pressure	Normal / Silent mode	dB(A)	61,00/58,00	62,00/59,00	62,50/59,50	63,50/60,50	63,50/60,50	64,00/61,00	63,00/60,00
Sound power	Normal mode	dB	82,00	83,00	83,50	84,50	84,50	85,00	84,00
Dimension / Net weight	HxWxD	mm / kg	1842x2010 x1000/480	1842x2420 x1000/540	1842x2010 x1000/525	1842x2420 x1000/585	1842x2420 x1000/630	1842x2420 x1000/630	1842x2780 x1000/690
Piping connections ²⁾	Liquid pipe	Inch (mm)	5/8(15,88) / 3/4(19,05)	5/8(15,88) / 3/4(19,05)	3/4(19,05) / 7/8(22,22)	3/4(19,05) / 7/8(22,22)	3/4(19,05) / 7/8(22,22)	3/4(19,05) / 7/8(22,22)	3/4(19,05) / 7/8(22,22)
	Gas pipe	Inch (mm)	1-1/8(28,58) / 1-1/4(31,75)	1-1/8(28,58) / 1-1/4(31,75)	1-1/4(31,75) / 1-1/2(38,10)	1-1/4(31,75) / 1-1/2(38,10)	1-1/4(31,75) / 1-1/2(38,10)	1-1/4(31,75) / 1-1/2(38,10)	1-1/4(31,75) / 1-1/2(38,10)
	Balance pipe	Inch (mm)	1/4(6,35)	1/4(6,35)	1/4(6,35)	1/4(6,35)	1/4(6,35)	1/4(6,35)	1/4(6,35)
Refrigerant (R410A) / CO ₂ Eq.		kg / T	13,90/23,3856	16,60/34,6608	13,90/29,0232	16,60/34,6608	16,60/34,6608	16,60/34,6608	17,80/37,1664
Maximum allowable indoor / outdoor capacity ratio % ³⁾			50 ~ 130(200)	50 ~ 130(200)	50 ~ 130(200)	50 ~ 130(200)	50 ~ 130(200)	50 ~ 130(200)	50 ~ 130(200)
Operating range	Cool Min ~ Max	°C	-10 ~ +52	-10 ~ +52	-10 ~ +52	-10 ~ +52	-10 ~ +52	-10 ~ +52	-10 ~ +52
	Heat Min ~ Max	°C	-25 ~ +18	-25 ~ +18	-25 ~ +18	-25 ~ +18	-25 ~ +18	-25 ~ +18	-25 ~ +18

			36HP	38HP	40HP	42HP	44HP	46HP	48HP
Model name			U-16ME2E8 U-20ME2E8	U-18ME2E8 U-20ME2E8	U-20ME2E8 U-20ME2E8	U-10ME2E8 U-16ME2E8 U-16ME2E8	U-12ME2E8 U-16ME2E8 U-16ME2E8	U-14ME2E8 U-16ME2E8 U-16ME2E8	U-16ME2E8 U-16ME2E8
Power supply	Voltage	V	380/400/415	380/400/415	380/400/415	380/400/415	380/400/415	380/400/415	380/400/415
	Phase		Three Phase	Three Phase	Three Phase	Three Phase	Three Phase	Three Phase	Three Phase
	Frequency	Hz	50	50	50	50	50	50	50
Cooling capacity		kW	101,00	107,00	113,00	118,00	124,00	130,00	135,00
EER ¹⁾		W/W	3,42	3,42	3,34	3,69	3,62	3,62	3,52
Running current cooling		A	45,30/43,70	48,10/46,30	51,40/49,50	50,20/48,40	53,20/51,30	56,90/54,90	60,20/58,10
Input power cooling		kW	25,9	31,3	33,8	32,0	34,3	35,9	38,4
Heating capacity		kW	113,00	119,00	127,00	132,00	138,00	145,00	150,00
COP ¹⁾		W/W	4,14	4,13	3,92	4,49	4,50	4,46	4,42
Running current heating		A	42,40/40,80	44,70/43,10	49,80/48,00	46,60/44,90	48,20/46,40	51,50/49,70	53,80/51,80
Input power heating		kW	27,30	28,80	32,40	29,40	30,70	32,50	33,90
Starting current		A	4,00	4,00	4,00	5,00	5,00	6,00	6,00
External static pressure (Max)		Pa	80	80	80	80	80	80	80
Air volume		m ³ /min	637	810	810	688	696	696	696
Sound pressure	Normal / Silent mode	dB(A)	63,50/60,50	62,50/59,50	63,00/60,00	65,00/62,00	65,50/62,50	65,50/62,50	66,00/63,00
Sound power	Normal mode	dB	84,50	83,50	84,00	86,00	86,50	86,50	87,00
Dimension / Net weight	HxWxD	mm / kg	1842x2780 x1000/690	1842x3140 x1000/750	1842x3140 x1000/750	1842x3250 x1000/840	1842x3660 x1000/900	1842x3660 x1000/945	1842x3660 x1000/945
Piping connections ²⁾	Liquid pipe	Inch (mm)	3/4(19,05) / 7/8(22,22)	3/4(19,05) / 7/8(22,22)	3/4(19,05) / 7/8(22,22)	3/4(19,05) / 7/8(22,22)	3/4(19,05) / 7/8(22,22)	3/4(19,05) / 7/8(22,22)	3/4(19,05) / 7/8(22,22)
	Gas pipe	Inch (mm)	1-1/2(38,10) / 1-5/8(41,28)	1-1/2(38,10) / 1-5/8(41,28)	1-1/2(38,10) / 1-5/8(41,28)	1-1/2(38,10) / 1-5/8(41,28)	1-1/2(38,10) / 1-5/8(41,28)	1-1/2(38,10) / 1-5/8(41,28)	1-1/2(38,10) / 1-5/8(41,28)
	Balance pipe	Inch (mm)	1/4(6,35)	1/4(6,35)	1/4(6,35)	1/4(6,35)	1/4(6,35)	1/4(6,35)	1/4(6,35)
Refrigerant (R410A) / CO ₂ Eq.		kg / T	17,80/37,1664	19,00/39,672	19,00/39,672	22,20/46,3536	24,90/51,9912	24,90/51,9912	24,90/51,9912
Maximum allowable indoor / outdoor capacity ratio % ³⁾			50 ~ 130(200)	50 ~ 130(200)	50 ~ 130(200)	50 ~ 130(200)	50 ~ 130(200)	50 ~ 130(200)	50 ~ 130(200)
Operating range	Cool Min ~ Max	°C	-10 ~ +52	-10 ~ +52	-10 ~ +52	-10 ~ +52	-10 ~ +52	-10 ~ +52	-10 ~ +52
	Heat Min ~ Max	°C	-25 ~ +18	-25 ~ +18	-25 ~ +18	-25 ~ +18	-25 ~ +18	-25 ~ +18	-25 ~ +18

1) EER and COP calculation is based in accordance to EN14511. 2) Pipe diameter under 90m for ultimate indoor unit / over 90m for ultimate indoor unit (if the longest piping equivalent length exceeds 90m, increase the sizes of the main tubes by 1 rank for gas tubes and liquid tubes). 3) If the following conditions are satisfied, the effective range is above 130% and below 200%: A. Obey the limited number of connectable indoor units. B. The lower limit of operating range for heating outdoor temperature is limited to -10°C WB (standard -25°C WB). C. Simultaneous operation is limited to less than 130% of connectable indoor units.



			50HP	52HP	54HP	56HP	58HP	60HP	62HP	64HP	
Model name			U-14ME2E8	U-16ME2E8	U-14ME2E8	U-16ME2E8	U-18ME2E8	U-20ME2E8	U-14ME2E8	U-16ME2E8	U-16ME2E8
			U-16ME2E8	U-16ME2E8	U-20ME2E8	U-20ME2E8	U-20ME2E8	U-20ME2E8	U-16ME2E8	U-16ME2E8	U-16ME2E8
			U-20ME2E8	U-20ME2E8	U-20ME2E8	U-20ME2E8	U-20ME2E8	U-20ME2E8	U-16ME2E8	U-16ME2E8	U-16ME2E8
Power supply	Voltage	V	380/400/415	380/400/415	380/400/415	380/400/415	380/400/415	380/400/415	380/400/415	380/400/415	380/400/415
	Phase		Three Phase	Three Phase	Three Phase	Three Phase	Three Phase	Three Phase	Three Phase	Three Phase	Three Phase
	Frequency	Hz	50	50	50	50	50	50	50	50	50
Cooling capacity	kW		140,00	145,00	151,00	156,00	162,00	168,00	174,00	180,00	
EER ¹⁾	W/W		3,55	3,46	3,49	3,41	3,40	3,35	3,60	3,52	
Running current cooling	A		61,10/58,90	65,00/62,70	66,50/64,10	70,30/67,80	73,10/70,40	76,10/73,40	75,80/73,00	80,30/77,40	
Input power cooling	kW		39,40	41,90	43,30	45,80	47,60	50,10	48,30	51,20	
Heating capacity	kW		155,00	160,00	169,00	175,00	182,00	189,00	195,00	201,00	
COP ¹⁾	W/W		4,29	4,27	4,11	4,08	4,06	3,94	4,45	4,42	
Running current heating	A		56,60/54,60	58,80/56,70	63,80/61,50	66,60/64,20	69,50/67,00	73,70/71,00	69,50/67,00	72,20/69,60	
Input power heating	kW		36,10	37,50	41,10	42,90	44,80	48,00	43,80	45,50	
Starting current	A		6,00	6,00	6,00	6,00	6,00	6,00	8,00	8,00	
External static pressure (Max)	Pa		80	80	80	80	80	80	80	80	
Air volume	m ³ /min		869	869	1042	1042	1215	1215	928	928	
Sound pressure	Normal / Silent mode	dB(A)	65,50 / 62,50	65,50 / 62,50	65,00 / 62,00	65,50 / 62,50	64,50 / 61,50	65,00 / 62,00	67,00 / 64,00	67,00 / 64,00	
Sound power	Normal mode	dB	86,50	86,50	86,00	86,50	85,50	86,00	88,00	88,00	
Dimension / Net weight	H x W x D	mm / kg	1842 x 4020 x 1000 / 1005	1842 x 4020 x 1000 / 1005	1842 x 4380 x 1000 / 1065	1842 x 4380 x 1000 / 1065	1842 x 4740 x 1000 / 1125	1842 x 4740 x 1000 / 1125	1842 x 4900 x 1000 / 1260	1842 x 4900 x 1000 / 1260	
Piping connections ²⁾	Liquid pipe	Inch (mm)	3/4 (19,05) / 7/8 (22,22)	3/4 (19,05) / 7/8 (22,22)	3/4 (19,05) / 7/8 (22,22)	3/4 (19,05) / 7/8 (22,22)	3/4 (19,05) / 7/8 (22,22)	3/4 (19,05) / 7/8 (22,22)	3/4 (19,05) / 7/8 (22,22)	3/4 (19,05) / 7/8 (22,22)	
	Gas pipe	Inch (mm)	1-1/2 (38,10) / 1-5/8 (41,28)	1-1/2 (38,10) / 1-5/8 (41,28)	1-1/2 (38,10) / 1-5/8 (41,28)	1-1/2 (38,10) / 1-5/8 (41,28)	1-1/2 (38,10) / 1-5/8 (41,28)	1-1/2 (38,10) / 1-5/8 (41,28)	1-5/8 (41,28) / 1-3/4 (44,45)	1-5/8 (41,28) / 1-3/4 (44,45)	
	Balance pipe	Inch (mm)	1/4 (6,35)	1/4 (6,35)	1/4 (6,35)	1/4 (6,35)	1/4 (6,35)	1/4 (6,35)	1/4 (6,35)	1/4 (6,35)	
Refrigerant (R410A) / CO ₂ Eq.	kg / T		26,10/54,4968	26,10/54,4968	27,30/57,0024	27,30/57,0024	28,50/59,508	28,50/59,508	33,20/69,3216	33,20/69,3216	
Maximum allowable indoor / outdoor capacity ratio % ³⁾			50 ~ 130 (200)	50 ~ 130 (200)	50 ~ 130 (200)	50 ~ 130 (200)	50 ~ 130 (200)	50 ~ 130 (200)	50 ~ 130 (200)	50 ~ 130 (200)	
Operating range	Cool Min ~ Max	°C	-10 ~ +52	-10 ~ +52	-10 ~ +52	-10 ~ +52	-10 ~ +52	-10 ~ +52	-10 ~ +52	-10 ~ +52	
	Heat Min ~ Max	°C	-25 ~ +18	-25 ~ +18	-25 ~ +18	-25 ~ +18	-25 ~ +18	-25 ~ +18	-25 ~ +18	-25 ~ +18	

			66HP	68HP	70HP	72HP	74HP	76HP	78HP	80HP	
Model name			U-10ME2E8	U-12ME2E8	U-10ME2E8	U-16ME2E8	U-16ME2E8	U-16ME2E8	U-18ME2E8	U-20ME2E8	U-20ME2E8
			U-16ME2E8	U-16ME2E8	U-20ME2E8	U-16ME2E8	U-18ME2E8	U-20ME2E8	U-20ME2E8	U-20ME2E8	U-20ME2E8
			U-20ME2E8	U-20ME2E8	U-20ME2E8	U-20ME2E8	U-20ME2E8	U-20ME2E8	U-20ME2E8	U-20ME2E8	U-20ME2E8
			U-20ME2E8	U-20ME2E8	U-20ME2E8	U-20ME2E8	U-20ME2E8	U-20ME2E8	U-20ME2E8	U-20ME2E8	U-20ME2E8
Power supply	Voltage	V	380/400/415	380/400/415	380/400/415	380/400/415	380/400/415	380/400/415	380/400/415	380/400/415	
	Phase		Three Phase	Three Phase	Three Phase	Three Phase	Three Phase	Three Phase	Three Phase	Three Phase	
	Frequency	Hz	50	50	50	50	50	50	50	50	
Cooling capacity	kW		185,00	190,00	196,00	202,00	208,00	213,00	219,00	224,00	
EER ¹⁾	W/W		3,52	3,49	3,47	3,42	3,42	3,39	3,38	3,35	
Running current cooling	A		80,80/77,80	83,70/80,70	86,80/83,60	90,60/87,30	93,40/90,00	96,60/93,10	98,30/94,70	101,50/97,80	
Input power cooling	kW		52,60	54,50	56,50	59,00	60,80	62,90	64,70	66,80	
Heating capacity	kW		207,00	213,00	219,00	226,00	233,00	239,00	245,00	252,00	
COP ¹⁾	W/W		4,16	4,18	4,05	4,14	4,12	4,03	4,03	3,94	
Running current heating	A		77,10/74,30	79,20/76,30	83,10/80,10	84,70/81,70	87,70/84,50	92,00/88,70	93,40/90,00	98,30/94,70	
Input power heating	kW		49,70	51,00	54,10	54,60	56,50	59,30	60,80	64,00	
Starting current	A		7,00	7,00	7,00	8,00	8,00	8,00	8,00	8,00	
External static pressure (Max)	Pa		80	80	80	80	80	80	80	80	
Air volume	m ³ /min		1266	1274	1439	1274	1447	1447	1620	1620	
Sound pressure	Normal / Silent mode	dB(A)	66,00 / 63,00	66,50 / 63,50	65,50 / 62,50	66,50 / 63,50	66,50 / 63,50	66,50 / 63,50	66,00 / 63,00	66,00 / 63,00	
Sound power	Normal mode	dB	87,00	87,50	86,50	87,50	87,50	87,50	87,00	87,00	
Dimension / Net weight	H x W x D	mm / kg	1842 x 5210 x 1000 / 1275	1842 x 5620 x 1000 / 1335	1842 x 5570 x 1000 / 1335	1842 x 5620 x 1000 / 1380	1842 x 5980 x 1000 / 1440	1842 x 5980 x 1000 / 1440	1842 x 6340 x 1000 / 1500	1842 x 6340 x 1000 / 1500	
Piping connections ²⁾	Liquid pipe	Inch (mm)	3/4 (19,05) / 7/8 (22,22)	7/8 (22,22) / 1 (25,04)	7/8 (22,22) / 1 (25,04)	7/8 (22,22) / 1 (25,04)	7/8 (22,22) / 1 (25,04)	7/8 (22,22) / 1 (25,04)	7/8 (22,22) / 1 (25,04)	7/8 (22,22) / 1 (25,04)	
	Gas pipe	Inch (mm)	1-5/8 (41,28) / 1-3/4 (44,45)	1-5/8 (41,28) / 1-3/4 (44,45)	1-5/8 (41,28) / 1-3/4 (44,45)	1-3/4 (44,45) / 2 (50,80)	1-3/4 (44,45) / 2 (50,80)	1-3/4 (44,45) / 2 (50,80)	1-3/4 (44,45) / 2 (50,80)	1-3/4 (44,45) / 2 (50,80)	
	Balance pipe	Inch (mm)	1/4 (6,35)	1/4 (6,35)	1/4 (6,35)	1/4 (6,35)	1/4 (6,35)	1/4 (6,35)	1/4 (6,35)	1/4 (6,35)	
Refrigerant (R410A) / CO ₂ Eq.	kg / T		32,90/68,6952	35,60/74,3328	34,10/19,836	35,80/68,6952	36,80/19,836	36,80/19,836	38,00/79,344	38,00/79,344	
Maximum allowable indoor / outdoor capacity ratio % ³⁾			50 ~ 130 (200)	50 ~ 130 (200)	50 ~ 130 (200)	50 ~ 130 (200)	50 ~ 130 (200)	50 ~ 130 (200)	50 ~ 130 (200)	50 ~ 130 (200)	
Operating range	Cool Min ~ Max	°C	-10 ~ +52	-10 ~ +52	-10 ~ +52	-10 ~ +52	-10 ~ +52	-10 ~ +52	-10 ~ +52	-10 ~ +52	
	Heat Min ~ Max	°C	-25 ~ +18	-25 ~ +18	-25 ~ +18	-25 ~ +18	-25 ~ +18	-25 ~ +18	-25 ~ +18	-25 ~ +18	

1) EER and COP calculation is based in accordance to EN14511. 2) Pipe diameter under 90m for ultimate indoor unit / over 90m for ultimate indoor unit (if the longest piping equivalent length exceeds 90m, increase the sizes of the main tubes by 1 rank for gas tubes and liquid tubes). 3) If the following conditions are satisfied, the effective range is above 130% and below 200%: A. Obey the limited number of connectable indoor units. B. The lower limit of operating range for heating outdoor temperature is limited to -10°C WB (standard -25°C WB). C. Simultaneous operation is limited to less than 130% of connectable indoor units.

3-PIPE ECOi EX MF3 SERIES

Simultaneous heating and cooling VRF System

The Panasonic 3-Pipe ECOi EX MF3 series offers the ideal solution to meet customer's demand.

Upgraded energy efficiency utilized ECOi EX technology.

- SEER / SCOP improved in full capacities from 8 to 16HP
- SEER / SCOP follows LOT21 from started from January 2018
- EER / COP is certified in Eurovent

Design flexibility.

- High reliability even under tough temperature condition
- Maximum 52 indoor units connectable
- Slim heat recovery box with just 200 height
- Farthest piping length between indoor units and outdoor units: 200m

Excellent seasonal energy saving.

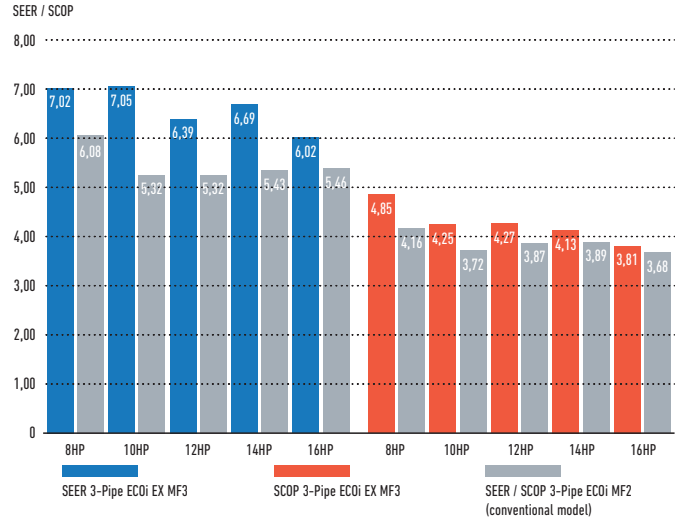

Extended design operation conditions

Cooling design operation conditions: The cooling operation range has been extended to -10°C ~ 52°C by changing the outdoor fan to an Inverter type. Heating design operation conditions: Stable heating operation even with an outside air temperature of -20°C. The heating operation range has been extended to -20°C by use of a compressor with a high-pressure vessel.

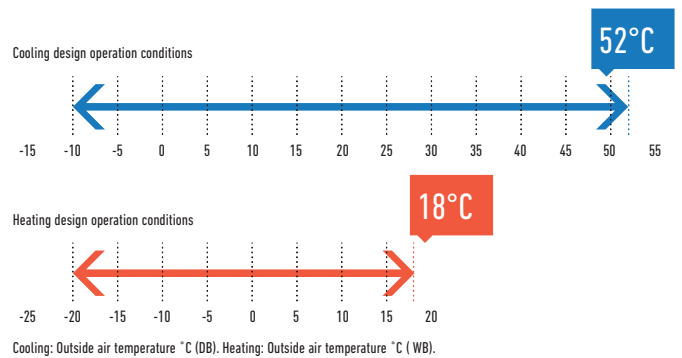

Wide temperature setting range

Wired remote control heating temperature setting range is 16 to 30°C.

Increased maximum number of connectable indoor units

Maximum 48HP with 52 indoor units can be set up according to user needs. Connectable indoor/outdoor unit capacity ratio up to 150%.

System (HP)	8	10	12	14	16	18	20	22	24	26	28	30	32	34	36	38	40	42	44	46	48
Connectable indoor units*: 150 %	19	24	29	34	39	43	48	52				52									

*Depending on indoor units types. Please check service manuals.

Power suppression control for energy saving (Demand control)¹

The 3-Pipe ECOi EX MF3 Series has a built-in demand function which uses the inverter characteristics. With this demand function, the power consumption can be set in three steps, and operation² at optimum performance is performed according to the setting and the power consumption. This function is useful to reduce the annual power consumption and to save electricity costs while maintaining comfort.

¹ An outdoor Seri-Para I/O unit is required for demand input.

² Setting is possible as 0% or in the range from 40 to 100% (in steps of 5%). At the time of shipping, setting has been done to the three steps of 0%, 70%, and 100%.

Simultaneous heating and cooling VRF system.
The 3-Pipe ECOi EX MF3 Series offers the solution for the most demanding customers.



Slim 3-Pipe Control Box Kit / Multiple connection type

Heat Recovery Box to connect multiple indoor units with just one box, 4, 6 and up to 8 indoor units or groups.

The height is only 200mm. This is good advantage specially in hotel applications, where space for connecting several boxes is limited.

Individual control of multiple indoor units with solenoid valve kits.

- Any design and layout can be used in a single system.
- Cooling operation is possible up to an outdoor temperature of -10°C.

System structure.

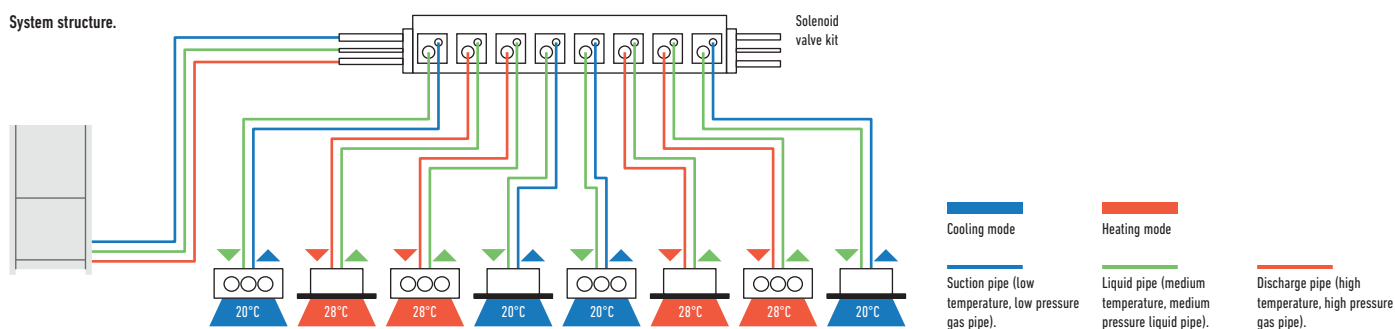

	1 port	4 port	6 port	8 port
56 type	CZ-P56HR3	CZ-P456HR3	CZ-P656HR3	CZ-P856HR3
160 type	CZ-P160HR3	CZ-P4160HR3	—	—

Solenoid valve kit / wiring work

Current model / single connection type

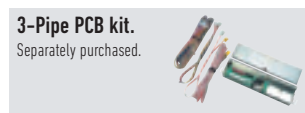
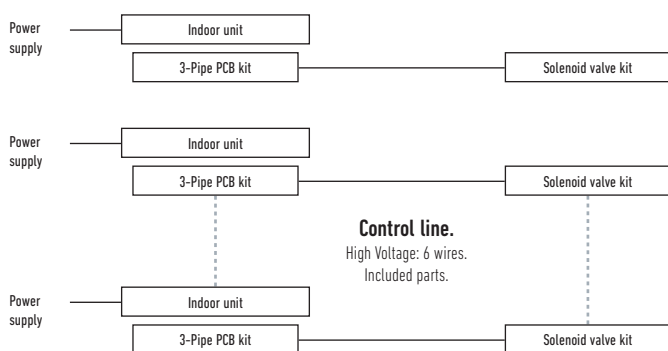

New model / multiple connection type

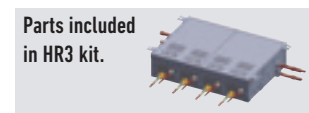
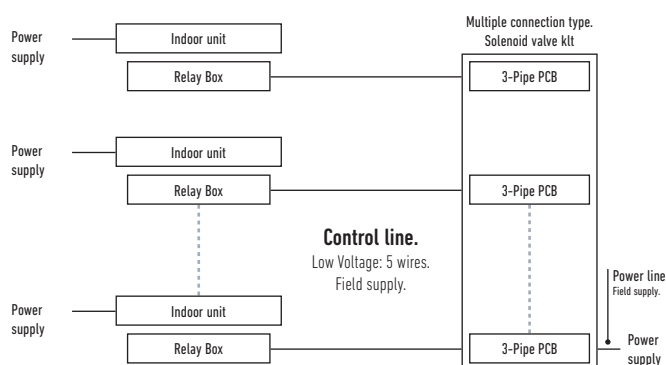

3-PIPE ECOi EX MF3 SERIES SUPERIOR FLEXIBILITY

Increased piping lengths and design flexibility

Adaptable to various building types and sizes. Actual piping length: 200m.
Maximum piping length: 500m.

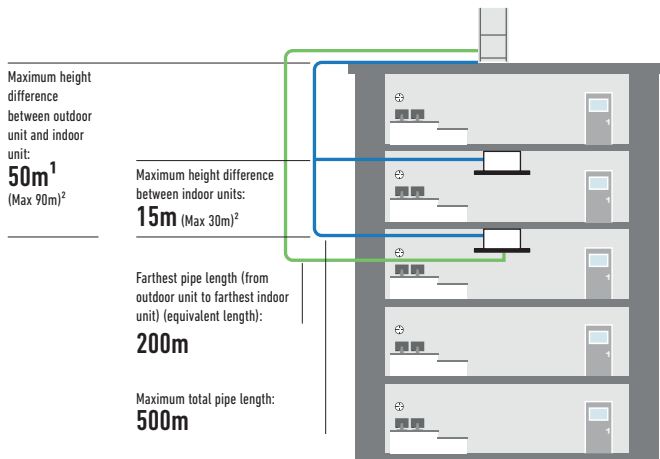

1. 40m if the outdoor unit is below the indoor unit.
2. Setting change is necessary. Please contact an authorized Panasonic dealer in the case of conditions below:
50 < Height difference between OU and IU ≤ 90 or 15 < Height difference between IUs ≤ 30.

Excellent cost saving and smaller piping size

By using R410A with low pressure loss, pipe sizes for discharge, suction and liquid are all reduced.

This makes it possible to aim for reduced piping space, improved workability at the site, and reduction of the piping material costs.

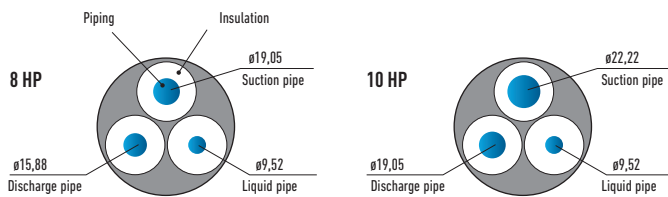

Up to 40m piping after first branch

Up to 52 units can be connected to one system. Flexible piping layout makes it easier to design systems for locations such as train stations, airports, schools and hospitals.

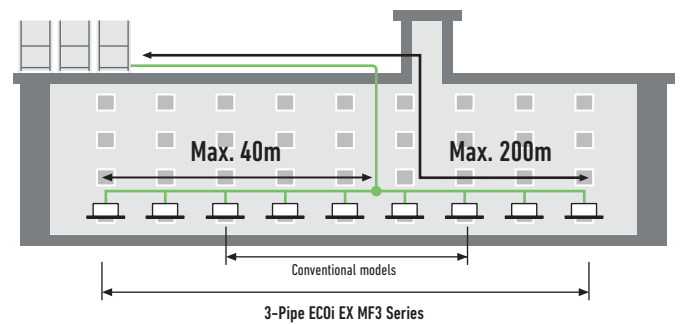

High external static pressure on condensers

With a newly designed fan, fan guard, motor, and casing, new models can be custom-installed on-site to provide up to 80 Pa of external static pressure.

An air discharge duct prevents shortages of air circulation, allowing outdoor units to be installed on every floor of a building.

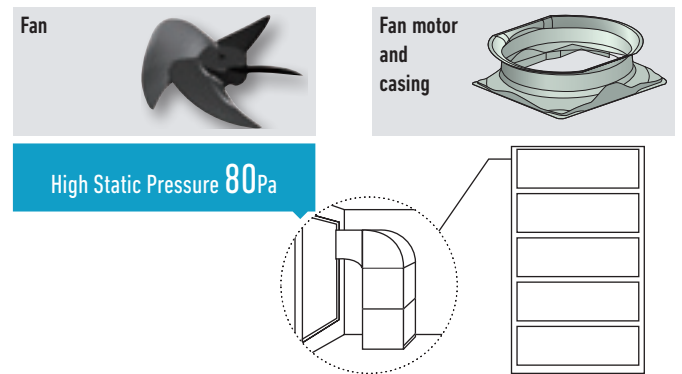

3-PIPE ECOi EX MF3 SERIES PIPING DESIGN

Select the installation location so that the length and size of refrigerant tubing are within the allowable range shown in the figure below.

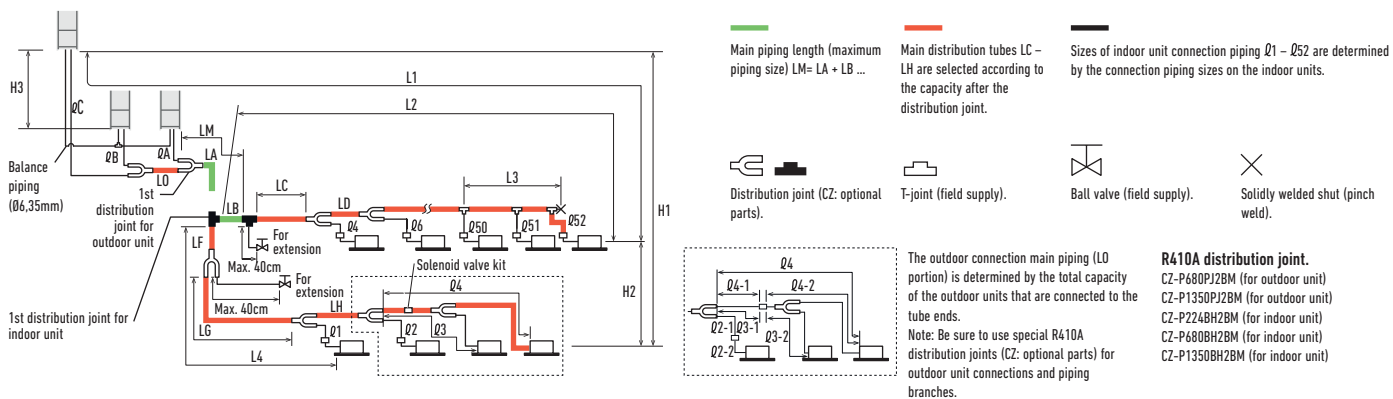

Ranges that apply to refrigerant piping lengths and to differences in installation heights

Items	Mark	Contents	Length (m)
Allowable piping length	L1	Maximum piping length	Actual length ≤200 ¹⁾ Equivalent length ≤210 ¹⁾
	Δ L (L2-L4)	Difference between maximum length and minimum length from the 1st distribution joint	≤50 ²⁾
	LM	Maximum length of main piping (at maximum size) * Even after 1st distribution joint, LM is allowed if at maximum piping length.	— ³⁾
	Q1, Q2- Q52	Maximum length of each distribution tube	≤50 ⁴⁾
	L1+ Q1+ Q2- Q51+ QA+QB+LF+LG+LH	Total maximum piping length including length of each distribution tube (only liquid piping)	≤500
	QA, QB+LO, QC+LO	Maximum piping length from outdoor's 1st distribution joint to each outdoor unit	≤10
Allowable elevation difference	H1	When outdoor unit is installed higher than indoor unit	≤50
	H2	When outdoor unit is installed lower than indoor unit	≤40
	H3	Maximum difference between indoor units	≤15 ⁵⁾
Allowable length of joint piping	L3	T-joint piping (field-supply); Maximum piping length between the first T-joint and solidly welded-shut end point	≤2

L = Length, H = Height

1) If the longest piping length (L1) exceeds 90m (equivalent length), increase the sizes of the main pipes (LM) by 1 rank for suction pipes, discharge pipes and liquid pipes. Use a field supply reducer. Select the pipe size from the table of main piping sizes (Table 3) and from the table of refrigerant piping sizes (Table 8). 2) If the longest main piping length (LM) exceeds 50m, increase the main piping size at the portion before 50 m by 1 rank for the suction pipes and discharge pipes. Use a field supply reducer. Determine the length less than the limitation of allowable maximum piping length. For the portion that exceeds 50m, set based on the main piping size (LA) listed in Table 3. 3) If the piping length marked "L" (L2-L4) exceeds 40m, increase the piping size at the portion after the 1st distribution joint by 1 rank for the liquid pipe, suction pipe and discharge pipe. Refer to the Technical Data for the details. 4) If any of the piping length exceeds 30m, increase the size of the suction pipes, discharge pipes and liquid pipes by 1rank.

* The outdoor connection main piping (LO portion) is determined by the total capacity of the outdoor units that are connected to the pipe ends.

System limitations.

Maximum number allowable connected outdoor units	3
Maximum capacity allowable connected outdoor units	135kW (48HP)
Maximum connectable indoor units	52
Maximum allowable indoor / outdoor capacity ratio	50-150%

- In the case of 24 HP (type 68kW) or smaller units, the number is limited by the total capacity of the connected indoor units.
- Up to 3 units can be connected if the system has been extended.
- It is strongly recommended that you choose the unit so the load can become between 50 and 130%.

Additional refrigerant charge.

Liquid piping size Inch (mm)	Amount of refrigerant charge/m (g/m)
1/4 (6,35)	26
3/8 (9,52)	56
1/2 (12,70)	128
5/8 (15,88)	185
3/4 (19,05)	259
7/8 (22,22)	366

Necessary amount of additional refrigerant charge per meter, according to discharge piping size.

Discharge piping size	Inch (mm)	1/2 (12,70)	5/8 (15,88)	3/4 (19,05)	7/8 (22,22)	1 (25,40)	1-1/8 (28,58)	1-1/4 (31,75)	1-1/2 (38,10)
Additional amount	g/m	12	21	31	41	55	71	89	126

Refrigerant piping.

Piping size Inch (mm)	Material Temper - 0	Material Temper - 1/2 H, H
1/4 (6,35)	t 0,8	7/8 (22,22) t 1,0
3/8 (9,52)	t 0,8	1 (25,40) t 1,0
1/2 (12,70)	t 0,8	1-1/8 (28,58) t 1,0
5/8 (15,88)	t 1,0	1-1/4 (31,75) t 1,1
3/4 (19,05)	t 1,2	1-1/2 (38,10) t 1,15
		1-1/5 41,28 t 1,20

* When bending the tubes, use a bending radius that is at least 4 times the outer diameter of the tubes. In addition, take sufficient care to avoid crushing or damaging the tubes when bending them.

3-Pipe ECOi EX MF3 Series



**4,85
SCOP**

Simultaneous heating and cooling operation with heat recovery type

The 3-Pipe ECOi EX MF3 Series is one of the most advanced VRF systems.

Not only high-efficient performance for simultaneous heating and cooling, but also sophisticated installation and maintenance available.

- Achieving SCOP 4,77 as the top class in the industry (LOT21 Seasonal heating efficiency value for 8HP outdoor unit)
- Simultaneous cooling and heating operation with up to 39 indoor units
- Slim heat recovery boxes with just 200mm height fit with the ceiling space limited in hotel applications
- Rotation operation function and back-up operation function provided

Technical focus

- High SEER/SCOP at full Load capacity (Follows LOT21)
- EER, COP: Eurovent certified
- Standardisation of outdoor unit to one compact casing size
- The constant-speed compressor adopts a high-performance internal high-pressure scroll
- Up to 52 indoor units connectable
- High external static pressure 80 Pa with a newly designed fan, fan guard, motor, and casing
- Silent outdoor unit operation: Minimum 54dB(A) for 8HP
- Bluefin condenser outdoor unit

			8HP	10HP	12HP	14HP	16HP
Outdoor Units			U-8MF3E8	U-10MF3E8	U-12MF3E8	U-14MF3E8	U-16MF3E8
Power supply	Voltage	V	380/400/415	380/400/415	380/400/415	380/400/415	380/400/415
	Phase		Three Phase	Three Phase	Three Phase	Three Phase	Three Phase
	Frequency	Hz	50	50	50	50	50
Cooling capacity		kW	22,40	28,00	33,50	40,00	45,00
EER ¹⁾		W/W	5,11	4,72	3,91	3,70	3,49
SEER²⁾			7,02	7,05	6,39	6,69	6,02
Running current cooling		A	7,16/6,80/6,55	9,90/9,41/9,07	3,19/13,20/12,70	18,20/17,30/16,70	21,30/20,20/19,50
Input power cooling		kW	4,38	5,93	8,57	10,80	12,90
Heating capacity		kW	25,00	31,50	37,50	45,00	50,00
COP ¹⁾		W/W	5,25	5,17	4,51	4,21	4,17
SCOP²⁾			4,85	4,25	4,27	4,13	3,81
Running current heating		A	7,78/7,39/7,12	10,20/9,66/9,31	13,40/12,80/12,30	18,10/17,20/16,50	20,00/19,00/18,30
Input power heating		kW	4,76	6,09	8,32	10,70	12,00
Starting current		A	1,00	1,00	1,00	2,00	2,00
External static pressure (Max)		Pa	80	80	80	80	80
Air volume		m/min	210	220	232	232	232
Sound pressure	Normal mode	dB(A)	54,00	57,00	60,00	61,00	62,00
	Silent mode 1 / 2	dB(A)	51,00/49,00	54,00/52,00	57,00/55,00	58,00/56,00	59,00/57,00
Sound power	Normal mode	dB	76,00	78,00	81,00	82,00	82,00
Dimension	H x W x D	mm	1842 x 1180 x 1000	1842 x 1180 x 1000	1842 x 1180 x 1000	1842 x 1180 x 1000	1842 x 1180 x 1000
Net weight		kg	261	262	286	334	334
Piping connections ³⁾	Liquid pipe	Inch (mm)	3/8(9,52)/1/2(12,70)	3/8(9,52)/1/2(12,70)	1/2(12,70)/5/8(15,88)	1/2(12,70)/5/8(15,88)	1/2(12,70)/5/8(15,88)
	Discharge pipe	Inch (mm)	5/8(15,88)/3/4(19,05)	3/4(19,05)/7/8(22,22)	3/4(19,05)/7/8(22,22)	7/8(22,22)/1(25,40)	7/8(22,22)/1(25,40)
	Suction pipe	Inch (mm)	3/4(19,05)/7/8(22,22)	7/8(22,22)/1(25,40)	1(25,40)/1-1/8(28,58)	1(25,40)/1-1/8(28,58)	1-1/8(28,58)/1-1/4(31,75)
	Balance pipe	Inch (mm)	1/4(6,35)	1/4(6,35)	1/4(6,35)	1/4(6,35)	1/4(6,35)
Refrigerant (R410A) / CO ₂ Eq.		kg / TCO ₂ Eq.	6,80 / 14,1984	6,80 / 14,1984	8,30 / 17,3304	8,30 / 17,3304	8,30 / 17,3304
Maximum allowable indoor / outdoor capacity ratio %			50 ~ 150	50 ~ 150	50 ~ 150	50 ~ 150	50 ~ 150
Operating range	Cool Min ~ Max	°C	-10 ~ +52	-10 ~ +52	-10 ~ +52	-10 ~ +52	-10 ~ +52
	Heat Min ~ Max	°C	-20 ~ +18	-20 ~ +18	-20 ~ +18	-20 ~ +18	-20 ~ +18
	Simultaneous op.	°C	-10 ~ +24	-10 ~ +24	-10 ~ +24	-10 ~ +24	-10 ~ +24

Solenoid valve kit

KIT-P56HR3	KIT-P56HR3	3-Pipe control Solenoid valve kit (up to 5,60kW)
	CZ-P56HR3	Solenoid valve kit (up to 5,60kW)
	CZ-CAPE2	3-Pipe control PCB
KIT-P160HR3	KIT-P160HR3	3-Pipe control Solenoid valve kit (from 5,60 to 16,00kW)
	CZ-P160HR3	Solenoid valve kit (up to 16,00kW)
	CZ-CAPE2	3-Pipe control PCB
CZ-CAPEK2		3-Pipe control PCB for wall mounted

3-Pipe control box kit

CZ-P456HR3	4 ports 3 pipe box (up to 5,60kW)
CZ-P656HR3	6 ports 3 pipe box (up to 5,60kW)
CZ-P856HR3	8 ports 3 pipe box (up to 5,60kW)
CZ-P4160HR3	4 ports 3 pipe box (up to 16,00kW)

1) EER and COP calculation is based in accordance to EN14511. 2) SEER/SCOP is calculated based on the seasonal space cooling/heating efficiency "η" values of the COMMISSION REGULATION (EU) 2016/2281. SEER, SCOP = (η + Correction) × PEF. 3) Pipe diameter under 90m for ultimate indoor unit / over 90m for ultimate indoor unit (if the longest piping equivalent length exceeds 90m, increase the sizes of the main tubes by 1 rank for gas tubes and liquid tubes).



3-Pipe ECOi EX MF3 Series combination from 18 to 48HP



HP	18HP		20HP		22HP		24HP		26HP		28HP		30HP		32HP	
Model name	U-8MF3E8 U-10MF3E8		U-8MF3E8 U-12MF3E8		U-10MF3E8 U-12MF3E8		U-12MF3E8 U-12MF3E8		U-10MF3E8 U-16MF3E8		U-12MF3E8 U-16MF3E8		U-14MF3E8 U-16MF3E8		U-16MF3E8 U-16MF3E8	
	Power supply	Voltage	V	380 / 400 / 415	380 / 400 / 415	380 / 400 / 415	380 / 400 / 415	380 / 400 / 415	380 / 400 / 415	380 / 400 / 415	380 / 400 / 415	380 / 400 / 415	380 / 400 / 415	380 / 400 / 415	380 / 400 / 415	380 / 400 / 415
	Phase		Three Phase	Three Phase	Three Phase	Three Phase	Three Phase	Three Phase	Three Phase	Three Phase	Three Phase	Three Phase	Three Phase	Three Phase	Three Phase	Three Phase
	Frequency	Hz	50	50	50	50	50	50	50	50	50	50	50	50	50	50
Cooling capacity	kW		50,00	56,00	61,50	68,00	73,00	78,50	85,00	90,00						
EER ¹⁾	W/W		4,90	4,31	4,24	3,89	3,88	3,65	3,59	3,49						
Running current cooling	A		16,80/16,00/15,40	21,00/20,00/19,20	23,70/22,50/21,70	28,30/26,90/25,90	31,00/29,50/28,40	35,10/33,40/32,20	39,60/37,60/36,20	42,60/40,50/39,00						
Input power cooling	kW		10,20	13,00	14,50	17,50	18,80	21,50	23,70	25,8						
Heating capacity	kW		56,00	63,00	69,00	76,50	81,50	87,50	95,00	100,00						
COP ¹⁾	W/W		5,23	4,77	4,79	4,47	4,50	4,31	4,19	4,17						
Running current heating	A		17,70/16,80/16,20	21,30/20,30/19,50	23,50/22,30/21,50	27,60/26,30/25,30	30,20/28,70/27,70	33,50/31,80/30,70	37,90/36,00/34,70	40,10/38,10/36,70						
Input power heating	kW		10,70	13,20	14,40	17,10	18,10	20,30	22,70	24,00						
Starting current			2,00	2,00	2,00	2,00	3,00	3,00	4,00	4,00						
External static pressure (Max)			80	80	80	80	80	80	80	80						
Air volume	m ³ /min		430	442	452	464	452	464	464	464						
Sound pressure	Normal mode	dB(A)	59,00	61,00	62,00	63,00	63,50	64,50	64,50	65,00						
	Silent mode 1 / 2	dB(A)	56,00 / 54,00	58,00 / 56,00	59,00 / 57,00	60,00 / 58,00	60,50 / 58,50	61,50 / 59,50	61,50 / 59,50	62,00 / 60,00						
Sound power	Normal mode	dB	81,50	84,00	84,50	86,00	84,50	86,00	86,00	86,00						
Dimension	H x W x D	mm	1842 x 2360 (+60) x 1000	1842 x 2360 (+60) x 1000	1842 x 2360 (+60) x 1000	1842 x 2360 (+60) x 1000	1842 x 2360 (+60) x 1000	1842 x 2360 (+60) x 1000	1842 x 2360 (+60) x 1000	1842 x 2360 (+60) x 1000						
Net weight	kg		523	547	548	574	596	620	668	668						
Piping connections ²⁾	Liquid pipe	Inch (mm)	5/8 (15,88) / 3/4 (19,05)	5/8 (15,88) / 3/4 (19,05)	5/8 (15,88) / 3/4 (19,05)	5/8 (15,88) / 3/4 (19,05)	3/4 (19,05) / 7/8 (22,22)	3/4 (19,05) / 7/8 (22,22)	3/4 (19,05) / 7/8 (22,22)	3/4 (19,05) / 7/8 (22,22)						
	Discharge pipe	Inch (mm)	7/8 (22,22) / 1 (25,40)	7/8 (22,22) / 1 (25,40)	1-1/8 (28,58)	1-1/8 (28,58)	1-1/8 (28,58)	1-1/8 (28,58)	1-1/8 (28,58)	1-1/4 (31,75)	1-1/8 (28,58) / 1-1/4 (31,75)	1-1/8 (28,58) / 1-1/4 (31,75)	1-1/8 (28,58) / 1-1/4 (31,75)	1-1/8 (28,58) / 1-1/4 (31,75)	1-1/8 (28,58) / 1-1/4 (31,75)	1-1/8 (28,58) / 1-1/4 (31,75)
	Suction pipe	Inch (mm)	1-1/8 (28,58) / 1-1/4 (31,75)	1-1/8 (28,58) / 1-1/4 (31,75)	1-1/8 (28,58) / 1-1/4 (31,75)	1-1/8 (28,58) / 1-1/4 (31,75)	1-1/4 (31,75)	1-1/4 (31,75)	1-1/4 (31,75) / 1-1/2 (38,10)	1-1/4 (31,75) / 1-1/2 (38,10)	1-1/4 (31,75) / 1-1/2 (38,10)	1-1/4 (31,75) / 1-1/2 (38,10)	1-1/4 (31,75) / 1-1/2 (38,10)	1-1/4 (31,75) / 1-1/2 (38,10)	1-1/4 (31,75) / 1-1/2 (38,10)	1-1/4 (31,75) / 1-1/2 (38,10)
	Balance pipe	Inch (mm)	1/4 (6,35)	1/4 (6,35)	1/4 (6,35)	1/4 (6,35)	1/4 (6,35)	1/4 (6,35)	1/4 (6,35)	1/4 (6,35)	1/4 (6,35)	1/4 (6,35)	1/4 (6,35)	1/4 (6,35)	1/4 (6,35)	1/4 (6,35)
Refrigerant (R410A) / CO ₂ Eq.	kg / T		13,60 / 28,3968	15,10 / 31,5288	15,10 / 31,5288	16,60 / 34,6608	15,10 / 31,5288	16,60 / 34,6608	16,60 / 34,6608	16,60 / 34,6608						
Maximum allowable indoor / outdoor capacity ratio %			50 ~ 150	50 ~ 150	50 ~ 150	50 ~ 150	50 ~ 150	50 ~ 150	50 ~ 150	50 ~ 150						
Operating range	Cool Min ~ Max	°C	-10 ~ +52	-10 ~ +52	-10 ~ +52	-10 ~ +52	-10 ~ +52	-10 ~ +52	-10 ~ +52	-10 ~ +52						
	Heat Min ~ Max	°C	-20 ~ +18	-20 ~ +18	-20 ~ +18	-20 ~ +18	-20 ~ +18	-20 ~ +18	-20 ~ +18	-20 ~ +18						
	Simultaneous op.	°C	-10 ~ +24	-10 ~ +24	-10 ~ +24	-10 ~ +24	-10 ~ +24	-10 ~ +24	-10 ~ +24	-10 ~ +24						

HP	34HP		36HP		38HP		40HP		42HP		44HP		46HP		48HP	
Model name	U-8MF3E8 U-10MF3E8 U-16MF3E8		U-8MF3E8 U-12MF3E8 U-16MF3E8		U-10MF3E8 U-12MF3E8 U-16MF3E8		U-8MF3E8 U-16MF3E8 U-16MF3E8		U-10MF3E8 U-16MF3E8 U-16MF3E8		U-12MF3E8 U-16MF3E8 U-16MF3E8		U-14MF3E8 U-16MF3E8 U-16MF3E8		U-16MF3E8 U-16MF3E8 U-16MF3E8	
	Power supply	Voltage	V	380 / 400 / 415	380 / 400 / 415	380 / 400 / 415	380 / 400 / 415	380 / 400 / 415	380 / 400 / 415	380 / 400 / 415	380 / 400 / 415	380 / 400 / 415	380 / 400 / 415	380 / 400 / 415	380 / 400 / 415	380 / 400 / 415
	Phase		Three Phase	Three Phase	Three Phase	Three Phase	Three Phase	Three Phase	Three Phase	Three Phase	Three Phase	Three Phase	Three Phase	Three Phase	Three Phase	Three Phase
	Frequency	Hz	50	50	50	50	50	50	50	50	50	50	50	50	50	50
Cooling capacity	kW		96,00	101,00	107,00	113,00	118,00	124,00	130,00	135,00						
EER ¹⁾	W/W		4,10	3,90	3,88	3,72	3,72	3,58	3,55	3,49						
Running current cooling	A		38,60/36,70/35,40	42,30/40,20/38,70	45,60/43,30/41,70	50,20/47,70/46,00	52,40/49,70/47,90	56,50/53,70/51,80	61,10/58,10/56,00	63,90/60,70/58,50						
Input power cooling	kW		23,40	25,90	27,60	30,40	31,70	34,60	36,60	38,70						
Heating capacity	kW		108,00	113,00	119,00	127,00	132,00	138,00	145,00	150,00						
COP ¹⁾	W/W		4,64	4,48	4,51	4,31	4,36	4,25	4,18	4,17						
Running current heating	A		38,90/37,00/35,60	41,60/39,50/38,10	43,60/41,40/39,90	49,30/46,80/45,10	50,60/48,10/46,30	53,70/51,00/49,10	57,90/55,00/53,00	60,10/57,10/55,00						
Input power heating	kW		23,30	25,20	26,40	29,50	30,30	32,50	34,70	36,00						
Starting current			4,00	4,00	4,00	5,00	5,00	5,00	6,00	6,00						
External static pressure (Max)			80	80	80	80	80	80	80	80						
Air volume	m ³ /min		662	674	684	674	684	696	696	696						
Sound pressure	Normal mode	dB(A)	64,00	64,50	65,00	65,50	66,00	66,50	66,50	67,00						
	Silent mode 1 / 2	dB(A)	61,00 / 59,00	61,50 / 59,50	62,00 / 60,00	62,50 / 60,50	63,00 / 61,00	63,50 / 61,50	63,50 / 61,50	64,00 / 62,00						
Sound power	Normal mode	dB	84,50	85,50	85,50	85,50	86,00	86,50	87,00	87,00						
Dimension	H x W x D	mm	1842 x 3540 (+120) x 1000	1842 x 3540 (+120) x 1000	1842 x 3540 (+120) x 1000	1842 x 3540 (+120) x 1000	1842 x 3540 (+120) x 1000	1842 x 3540 (+120) x 1000	1842 x 3540 (+120) x 1000	1842 x 3540 (+120) x 1000						
Net weight	kg		857	881	882	929	930	954	1002	1002						
Piping connections ³⁾	Liquid pipe	Inch (mm)	3/4 (19,05) / 7/8 (22,22)	3/4 (19,05) / 7/8 (22,22)	3/4 (19,05) / 7/8 (22,22)	3/4 (19,05) / 7/8 (22,22)	3/4 (19,05) / 7/8 (22,22)	3/4 (19,05) / 7/8 (22,22)	3/4 (19,05) / 7/8 (22,22)	3/4 (19,05) / 7/8 (22,22)						
	Discharge pipe	Inch (mm)	1-1/8 (28,58) / 1-1/4 (31,75)	1-1/8 (28,58) / 1-1/4 (31,75)	1-1/4 (31,75) / 1-1/2 (38,10)	1-1/4 (31,75) / 1-1/2 (38,10)	1-1/4 (31,75) / 1-1/2 (38,10)	1-1/4 (31,75) / 1-1/2 (38,10)	1-1/4 (31,75) / 1-1/2 (38,10)	1-1/4 (31,75) / 1-1/2 (38,10)	1-1/4 (31,75) / 1-1/2 (38,10)	1-1/4 (31,75) / 1-1/2 (38,10)	1-1/4 (31,75) / 1-1/2 (38,10)	1-1/4 (31,75) / 1-1/2 (38,10)	1-1/4 (31,75) / 1-1/2 (38,10)	1-1/4 (31,75) / 1-1/2 (38,10)
	Suction pipe	Inch (mm)	1-1/4 (31,75) / 1-1/2 (38,10)	1-1/2 (38,10) / 1-5/8 (41,28)	1-1/2 (38,10) / 1-5/8 (41,28)	1-1/2 (38,10) / 1-5/8 (41,28)	1-1/2 (38,10) / 1-5/8 (41,28)	1-1/2 (38,10) / 1-5/8 (41,28)	1-1/2 (38,10) / 1-5/8 (41,28)	1-1/2 (38,10) / 1-5/8 (41,28)	1-1/2 (38,10) / 1-5/8 (41,28)	1-1/2 (38,10) / 1-5/8 (41,28)	1-1/2 (38,10) / 1-5/8 (41,28)	1-1/2 (38,10) / 1-5/8 (41,28)	1-1/2 (38,10) / 1-5/8 (41,28)	1-1/2 (38,10) / 1-5/8 (41,28)
	Balance pipe	Inch (mm)	1/4 (6,35)	1/4 (6,35)	1/4 (6,35)	1/4 (6,35)	1/4 (6,35)	1/4 (6,35)	1/4 (6,35)	1/4 (6,35)	1/4 (6,35)	1/4 (6,35)	1/4 (6,35)	1/4 (6,35)	1/4 (6,35)	1/4 (6,35)
Refrigerant (R410A) / CO ₂ Eq.	kg / T		21,90 / 45,72719	23,40 / 48,85919	23,40 / 48,85919	23,40 / 48,85919	23,40 / 48,85919	23,40 / 48,85919	24,90 / 46,3536	24,90 / 51,9912						
Maximum allowable indoor / outdoor capacity ratio %			50 ~ 150	50 ~ 150	50 ~ 150	50 ~ 150	50 ~ 150	50 ~ 150	50 ~ 150	50 ~ 150						
Operating range	Cool Min ~ Max	°C	-10 ~ +52	-10 ~ +52	-10 ~ +52	-10 ~ +52	-10 ~ +52	-10 ~ +52	-10 ~ +52	-10 ~ +52						
	Heat Min ~ Max	°C	-20 ~ +18	-20 ~ +18	-20 ~ +18	-20 ~ +18	-20 ~ +18	-20 ~ +18	-20 ~ +18	-20 ~ +18						
	Simultaneous op.	°C	-10 ~ +24	-10 ~ +24	-10 ~ +24	-10 ~ +24	-10 ~ +24	-10 ~ +24	-10 ~ +24	-10 ~ +24						

ECO G, THE GAS DRIVEN VRF



ECO G

The advanced Gas Driven VRF system offers increased efficiency and performance across the range. Improvements include increased part load performance, reduced gas consumption with a Miller-cycle engine and reduced electrical consumption by using DC-Fan motors.

1 Limited electric supply

Electric consumption of ECO G is only 9% compared to ECOi because gas engine is utilized for the compressor driving source.

2 High demand of DHW with heating and cooling cogeneration

DHW is produced effectively thanks to heat from engine exhaust during heating and cooling.

3 Open and flexible design

ECO G system is designed to connect various Indoor units and controllers which is available for ECOi system. With new GE3 series, Pump down system has been also implemented to answer commercial needs.

4 Quick start up in heating at low ambient temperature

Gas heat pump systems make your building comfortably warm by a quick start up with waste heat from engine. Heating mode works from -21°C of ambient temperature.

Comparison of heating capacity.

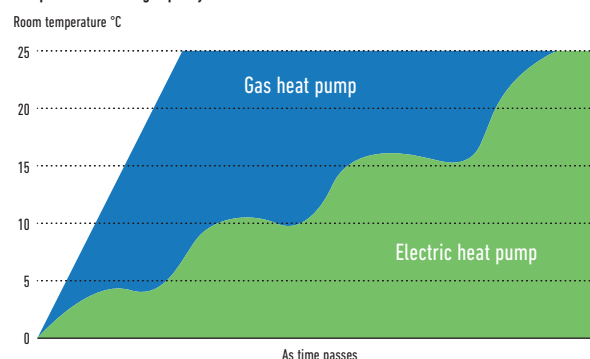

2-Pipe ECO G GE3 Series

Designed for better energy efficiency. SEER has been increased by maximum 120%.



NEW 3-Pipe ECO G GF3 Series

Domestic hot water can be supplied by effectively using waste heat generated by heating & cooling.

GE3/GF3 connectable indoor units

Type	Model number reference	2-Pipe ECO G GE3 Series	NEW 3-Pipe ECO G GF3 Series
Standard A2A indoor units	—	Yes ¹	Yes ¹
Water Heat Exchanger	PAW-250/500W(P)5G	Yes ²	No
High Static Pressure Hide Away	S-ME2E5	Yes	No
Heat Recovery with DX Coil	PAW-ZDX3N	Yes	Yes
Air Curtain with DX Coil	PAW-EAIRC-HS/LS	Yes	Yes ³
AHU Connection Kit	PAW-MAH2/M/L	Yes	Yes ³

1) Except for 1,50kW capacity. 2) Allowed 1:1 and also mixed. If mixed, not operate at the same time WHE + DX only operate separately. 3) Smaller capacity than 16kW only.

ECO G, THE GAS DRIVEN VRF

200.000
GHP outdoor units
were sold in all over
the world

ECO G satisfies special requirement for your application and environmentally friendly solution by Panasonic professional technology.

Reliable quality by long development history since 1985.

Our ECO G VRF range of commercial systems is leading the industry in the development of efficient and flexible systems



What is GHP? The Gas Heat Pump (GHP)

Panasonic Gas Heat Pump is a direct expansion system with compressor as same as VRF system. Gas engine is used as driving source of compressor instead of electric motor. This gas engine compressor drive has 2 advantages:

1. Waste heat from the gas engine available
2. No need for motor power consumption thanks to gas engine

GHP is the natural choice for commercial projects, especially for those projects where power restrictions apply.

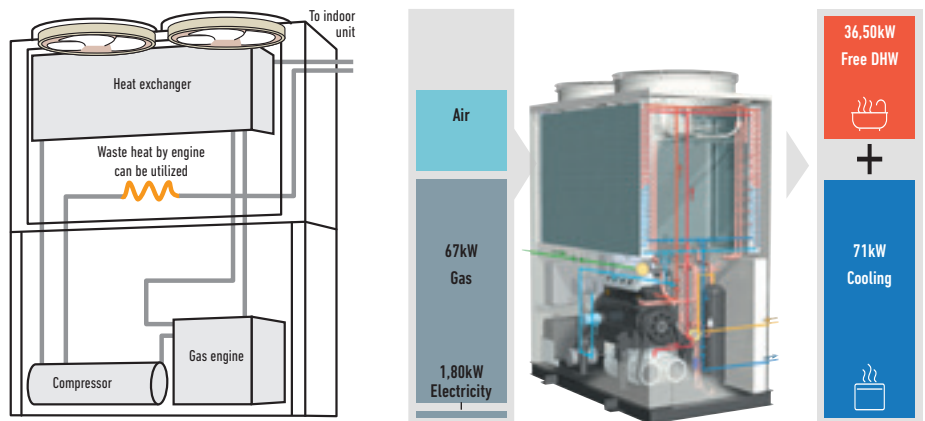

* Regarding a 25HP model.

Power supply problems?

If you are short of electric power, our ECO G is a perfect solution.

- Runs on natural gas or LPG and just needs single phase supply
- Enables the building's electrical power supply to be used for other critical electrical demands
- Reduces capital cost to upgrade power substations to run heating and cooling systems
- Reduces power loadings within a building especially during peak periods
- Electricity supply freed up for other uses such as IT servers, commercial refrigeration, manufacturing, lighting, etc...

Limited electricity area.

Comparison of electrical consumption on a 71kW outdoor unit.

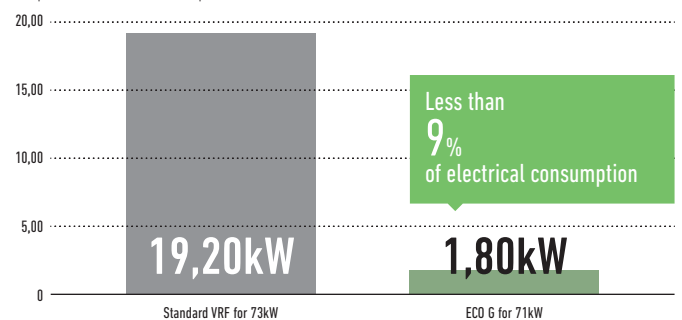

High demand of Domestic Hot Water in heating and cooling

The rejected heat from the engine is available for DHW production and can supply up to 46kW of hot water at 65°C. DHW at 65°C is also ready to use in heating without additional electric heaters.

Application example: Hotel

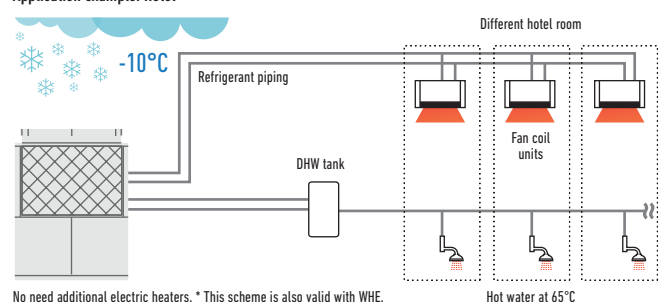

Quick start up and great heating capacity at low ambient temperature

Waste heat from gas engine is utilized to raise temperature quicker than electric VRF system.

This contributes great heating capacity at extremely low ambient temperature.

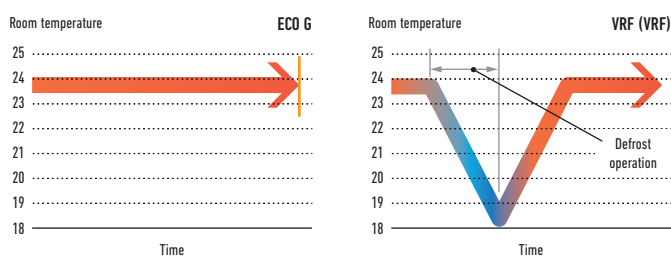

Lowest nitrogen oxide emissions.

The ECO G VRF systems have low nitrogen oxide emissions. In a pioneering development, the Panasonic ECO G features a brand new lean-burn combustion system that utilizes air fuel ratio feedback control to reduce NOx emissions to an all time low.

Water chiller option.

Our ECO G system is also available with a water chiller option, which can be combined with individual outdoor units or as part of a DX chilled water mix of indoor units. The system can be operated via a BMS system or a Panasonic supplied control panel, with chilled water set points from -15°C ~ +15°C and heating set points 35°C ~ +55°C.

Application

Application	Condition	ECO G
Hotel	High DHW demand	✓
Hotel	Needs to warm up swimming pool	✓ Energy recovery of ECO G system can fulfill different requirement
Office	Quick start up is necessary	✓ Speed of start up is quicker than VRF system
Winery	1) Outlet water demand at specific temperature 2) Needs high amount of power temporary (not every month)	✓ 1) Chiller application with hydro module (ECO G + WHE) can make this special process ✓ 2) Running cost can be saved since fixed Gas tariff per month is cheaper than fixed electric tariff.
Any building	In a city with power restriction	✓ - No need an additional power transformer - Space and cost can be saved
	At extremely low ambient condition	✓ Heating capacity is kept up to -20°C without defrost process

Project Case Studies



Savills HQ Dublin & Google Block R. Ireland.

ECO G 3-way units with a 243kW load. The project has been such a success that it has recently been awarded a Panasonic PRO Award for Best Contribution of efficient projects within Europe.



Thomas Cook's Sunprime Atlantic View resort.

A holiday resort in the Canaries, Spain. 229 rooms plus full spa and swimming pool facility.



CAPITA call centre. UK.

11 ECO G 3-way units. Over 150 indoor units in meeting rooms and open-plan areas. Intelligent touch screen controller, the CZ-256ESMC2.



French winery Genevilliers, France.

ECO G 3-way units. One of the best solution utilized our ECO G solution for wine production process.

ECO G 3 SERIES

Improvement in blast efficiency

New 3-blades fan.

Propeller shape with 3 blades is more efficient
Max. 30% of fan electrical consumption is saved compared to conventional fan.

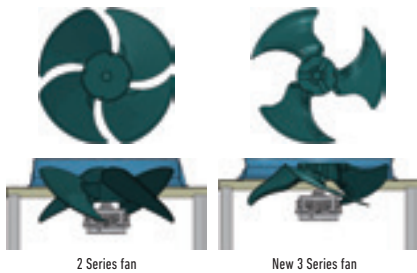

New "L" type heat exchanger

Heat exchanger surface area is included by 25% compared to conventional model to optimize efficiency.

Heat exchanger surface area **25% up**

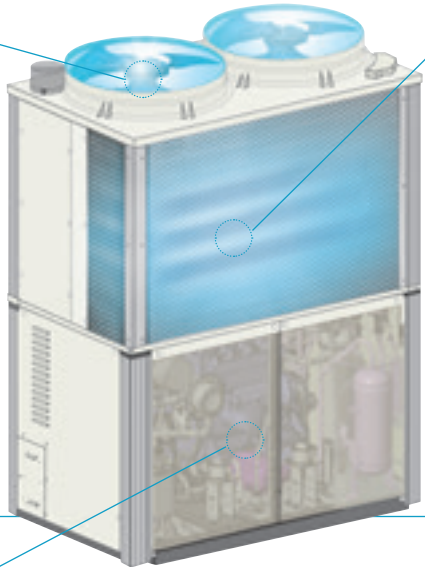
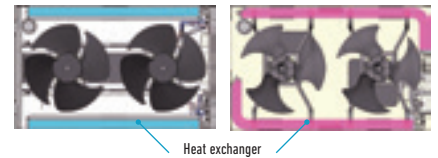

Better partial load control

Reduce start / stop loss has reduced by expanding the are where continuous operation is possible. Annual operation efficiency has further improved by better efficiency at lower partial load.

Compressor.

- Amount of internal leakage has reduced by the reduction of clearance, the compressor efficiency in the low load and low rotation region has been greatly improved.
- Moreover, efficiency of high speed and high load is also improved by reduction of suction pressure loss due to expansion of suction path
- Optimize compressor capacity

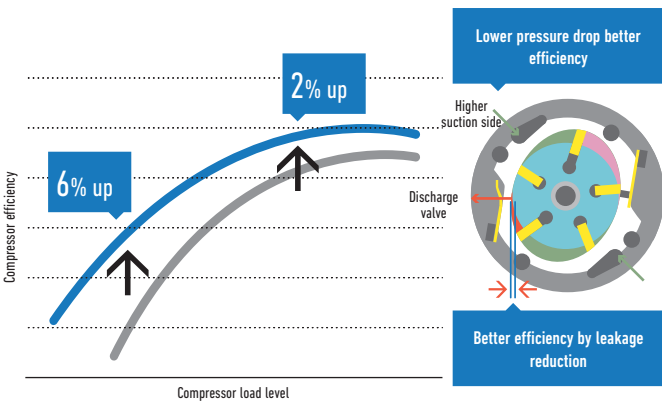

Engine.

- Continuous operation area has expanded at lower partial load by expanding operation area of lower speed
- Engine efficiency has improved by shifting output points to higher torque side

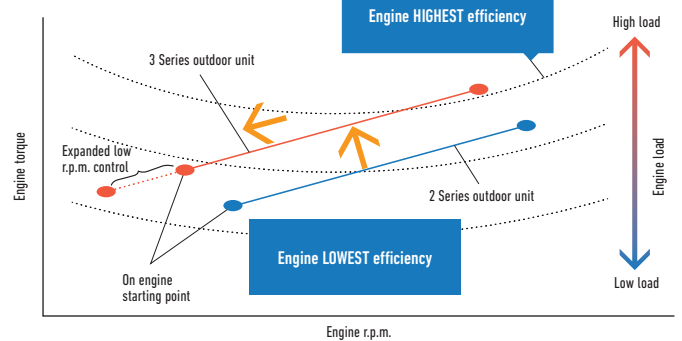

Engine pulley.

- Bigger diameter of engine pulley contributes the optimization of the compressor rotation speed ratio with engine speed
- Higher engine pulley diameter giving better performance at partial load and reducing ON/OFF operation.

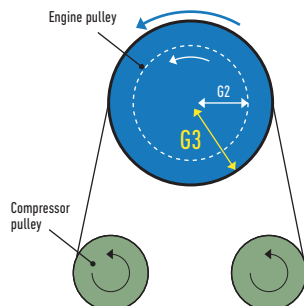

Line up of GE3 2-Pipe W-Multi

- For new or renewal
- Available for water heat exchanger
- Maximum 60HP combination

Introducing new ECO G 3 Series. Optimized energy saving with reliable Panasonic technologies.

The highest seasonal performance in all capacity ranges

High power efficiency of W-Multi system.

ECO G 3 Series system offers seasonal efficiency which has been drastically improved with new heat exchanger design, blast efficiency, partial load control.

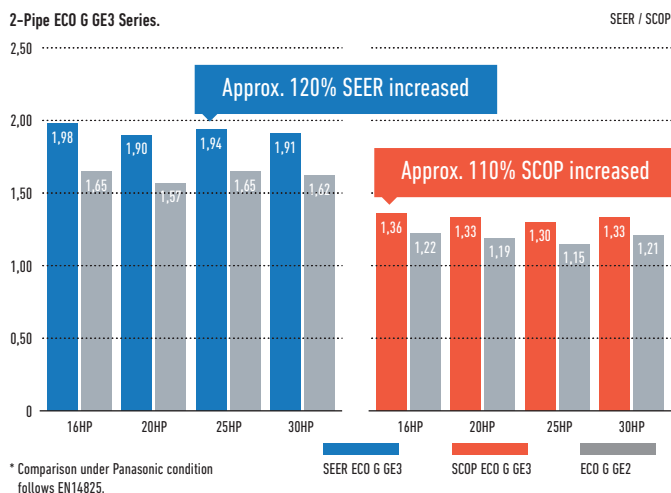

Compared to conventional model ECO G 2 Series.

All models are newly developed and have maximum 25% of SEER, 15% of SCOP better than conventional model.

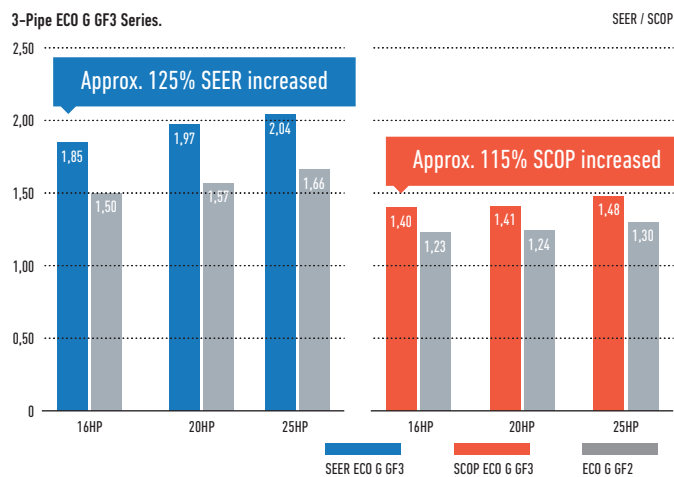

Heating design operation conditions (GE3)

Operating range in heating has been expanded up to 24°C (WB) for air to water system to meet the demand of swimming pool application.

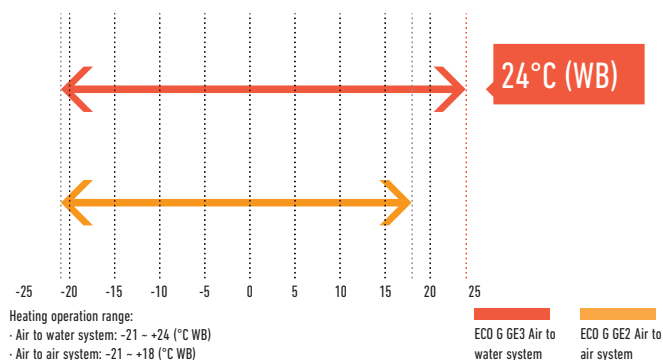

DHW priority mode setting in heating (GE3)

Ambient temperature range for DHW production is expandable by setting depending on DHW needs. Hot water at 65°C is available in heating without additional electric heaters.

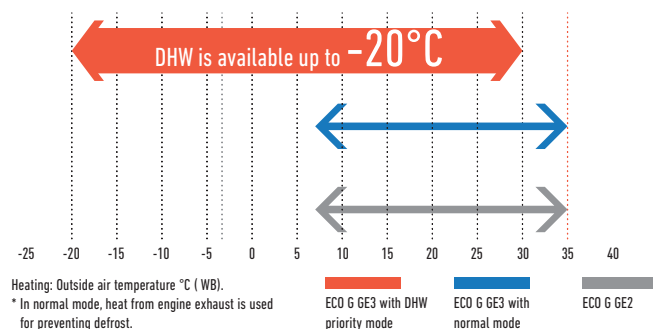

No defrost requirement (GE3 / GF3)

No defrost mode is selectable to get higher capacity under low ambient temperature.

Flexible design with wide line up of indoor units

The advanced GE3 series can connect up to 64 indoor units.

Series	16HP	20HP	25HP	30HP	32HP	36HP	40HP	45HP	50HP	55HP	60HP
2-Pipe ECO G GE3 Series	26	33	41	50	52	59	64	64	64	64	64
3-Pipe ECO G GF3 Series	24	24	24	—	—	—	—	—	—	—	—

2-Pipe ECO G GE3 Series

The new GE3 Series has a top level of seasonal efficiency in this category. In addition, this product fits with special needs for commercial application thanks to DHW priority setting and Auto pump down functions.



Technical focus

- Superior seasonal energy efficiency, maximum 240,1%
- DHW priority setting
- Operating range in heating down to -21°C and up to +24°C for air to water system
- No defrost cycle
- Capacity ratio 50 ~ 200%¹
- 0-10V control demand by a connection with 3rd party controllers (CZ-CAPBC2 required)
- Option of DX or chilled water for indoor heat exchange
- Maximum total piping length: 780m

1) 50 ~ 200% only when one outdoor unit is installed. In other cases 50 ~ 130%.

HP			16HP	20HP	25HP	30HP
Model			U-16GE3E5	U-20GE3E5	U-25GE3E5	U-30GE3E5
Power supply	Voltage	V	220 / 230 / 240	220 / 230 / 240	220 / 230 / 240	220 / 230 / 240
	Phase		Single Phase	Single Phase	Single Phase	Single Phase
	Frequency	Hz	50	50	50	50
Cooling capacity		kW	45,00	56,00	71,00	85,00
Refrigeration load Pdesign		kW	45,00	56,00	71,00	85,00
η_{sc} (LOT21)¹		%	220,60	219,30	240,10	229,30
Input power cooling		kW	1,17	1,12	1,80	1,80
Hot water in cooling mode (at 65°C outlet)		kW	23,60	29,10	36,40	46,00
Max COP in hot water		W/W	1,55	1,55	1,49	1,47
Gas consumption cooling		kW	41,10	52,10	67,20	84,10
Heating capacity	Standard	kW	50,00	63,00	80,00	95,00
	Low temperature	kW	53,00	67,00	78,00	90,00
Refrigeration load Pdesign		kW	37,00	53,00	60,00	65,00
η_{sh} (LOT21)¹		%	150,60	143,70	146,90	151,30
Input power heating		kW	0,56	1,05	0,91	1,75
Gas consumption heating	Standard	kW	38,00	51,10	68,60	75,30
	Low temperature	kW	45,40	62,70	60,70	73,90
Starter amperes		A	30	30	30	30
External static pressure		Pa	10	10	10	10
Air volume		m ³ /min	370	420	460	460
Sound power	Normal / Silent mode	dB	80 / 77	80 / 77	84 / 81	84 / 81
Dimension	HxWxD	mm	2255 x 1650 x 1000	2255 x 1650 x 1000	2255 x 2026 x 1000	2255 x 2026 x 1000
Net weight		kg	765	765	870	880
Piping connections	Liquid pipe	Inch (mm)	1/2 (12,70)	5/8 (15,88)	5/8 (15,88)	3/4 (19,05)
	Gas pipe	Inch (mm)	1-1/8 (28,58)	1-1/8 (28,58)	1-1/8 (28,58)	1-1/4 (31,75)
	Fuel gas	Inch (mm)	19,05 (R3/4)	19,05 (R3/4)	19,05 (R3/4)	19,05 (R3/4)
	Exhaust drain	mm	25	25	25	25
	Hot water supply in/out		Rp3/4 (Nut, thread)	Rp3/4 (Nut, thread)	Rp3/4 (Nut, thread)	Rp3/4 (Nut, thread)
Elevation difference (in/out)			50	50	50	50
Refrigerant (R410A) / CO ₂ Eq.		kg / T	11,50 / 24,00	11,50 / 24,00	11,50 / 24,00	11,50 / 24,00
Maximum number of connectable indoor units			26	33	41	50
Operating range	Cool Min ~ Max	°C (DB)	-10 ~ +43	-10 ~ +43	-10 ~ +43	-10 ~ +43
	Heat Min ~ Max	°C (WB)	-21 ~ +18	-21 ~ +18	-21 ~ +18	-21 ~ +18

1) SEER/SCOP is calculated based on the seasonal space cooling/heating efficiency "η" values of the COMMISSION REGULATION (EU) 2016/2281.

Hot water take out function added, EU safety regulation standard cleared. 25HP chassis enlarged due to specification improvement. Pre-coat corrosion fin. Auto pump down function.

2-Pipe ECO G GE3 Series combination



The new GE3 Series has a top level of seasonal efficiency in this category. In addition, this product fits with special needs for commercial application thanks to DHW priority setting and Auto pump down functions.

Technical focus

- Maximum 60HP combination
- Superior seasonal energy efficiency, maximum 240,1%
- DHW priority setting
- Operating range in heating down to -21°C and up to +24°C for air to water system
- No defrost cycle
- 0-10V control demand by a connection with 3rd party controllers (CZ-CAPBC2 required)
- Option of DX or chilled water for indoor heat exchange
- Maximum total piping length: 780m

HP			32HP	36HP	40HP	45HP	50HP	55HP	60HP
Model			U-16GE3E5	U-16GE3E5	U-20GE3E5	U-20GE3E5	U-25GE3E5	U-25GE3E5	U-30GE3E5
			U-16GE3E5	U-20GE3E5	U-20GE3E5	U-25GE3E5	U-25GE3E5	U-30GE3E5	U-30GE3E5
Power supply	Voltage	V	220 / 230 / 240	220 / 230 / 240	220 / 230 / 240	220 / 230 / 240	220 / 230 / 240	220 / 230 / 240	220 / 230 / 240
	Phase		Single Phase	Single Phase	Single Phase	Single Phase	Single Phase	Single Phase	Single Phase
	Frequency	Hz	50	50	50	50	50	50	50
Cooling capacity		kW	90,00	101,00	112,00	127,00	142,00	156,00	170,00
Input power cooling		kW	2,34	2,29	2,24	2,92	3,60	3,60	3,60
Hot water in cooling mode (at 65°C outlet)		kW	47,20	52,70	58,20	65,50	72,80	82,40	92,00
Max COP in hot water		W/W	1,55	1,55	1,55	1,52	1,49	1,48	1,47
Gas consumption cooling		kW	82,20	93,20	104,20	119,30	134,40	151,30	168,20
Heating capacity	Standard	kW	100,00	113,00	126,00	143,00	160,00	175,00	190,00
	Low temperature	kW	106,00	120,00	134,00	145,00	156,00	168,00	180,00
Input power heating		kW	1,12	1,61	2,10	1,96	1,82	2,66	3,50
Gas consumption heating	Standard	kW	76,00	89,10	102,20	119,70	137,20	143,90	150,60
	Low temperature	kW	90,80	108,10	125,40	123,40	121,40	134,60	147,80
Starter amperes		A	30	30	30	30	30	30	30
External static pressure		Pa	10	10	10	10	10	10	10
Air volume		m ³ /min	370 / 370	370 / 420	420 / 420	420 / 460	460 / 460	460 / 460	460 / 460
Sound power	Normal / Silent mode	dB	83 / 80	83 / 80	83 / 80	86 / 83	87 / 84	87 / 84	87 / 84
	Height	mm	2255	2255	2255	2255	2255	2255	2255
Dimension	Width	mm	1650 + 100 + 1650	1650 + 100 + 1650	1650 + 100 + 1650	1650 + 100 + 2026	2026 + 100 + 2026	2026 + 100 + 2026	2026 + 100 + 2026
	Depth	mm	1000	1000	1000	1000	1000	1000	1000
	Net weight	kg	1530 (765 + 765)	1530 (765 + 765)	1530 (765 + 765)	1635 (765 + 870)	1740 (870 + 870)	1750 (870 + 880)	1760 (880 + 880)
Piping connections	Liquid pipe	Inch (mm)	3/4 (19,05)	3/4 (19,05)	3/4 (19,05)	3/4 (19,05)	3/4 (19,05)	7/8 (22,22)	7/8 (22,22)
	Gas pipe	Inch (mm)	1-1/4 (31,75)	1-1/4 (31,75)	1-1/2 (38,10)	1-1/2 (38,10)	1-1/2 (38,10)	1-1/2 (38,10)	1-1/2 (38,10)
	Fuel gas	Inch (mm)	19,05 (R3/4)	19,05 (R3/4)	19,05 (R3/4)	19,05 (R3/4)	19,05 (R3/4)	19,05 (R3/4)	19,05 (R3/4)
	Exhaust drain port	mm	25	25	25	25	25	25	25
	Hot water supply in/out		Rp3/4 (Nut, thread)	Rp3/4 (Nut, thread)	Rp3/4 (Nut, thread)	Rp3/4 (Nut, thread)	Rp3/4 (Nut, thread)	Rp3/4 (Nut, thread)	Rp3/4 (Nut, thread)
Elevation difference (in/out)			50	50	50	50	50	50	50
Refrigerant (R410A) / CO ₂ Eq.		kg / T	2x11,50 / 24,00	2x11,50 / 24,00	2x11,50 / 24,00	2x11,50 / 24,00	2x11,50 / 24,00	2x11,50 / 24,00	2x11,50 / 24,00
Maximum number of connectable indoor units			52	59	64	64	64	64	64
Operating range	Cool Min ~ Max	°C	-10 ~ +43	-10 ~ +43	-10 ~ +43	-10 ~ +43	-10 ~ +43	-10 ~ +43	-10 ~ +43
	Heat Min ~ Max	°C	-21 ~ +18	-21 ~ +18	-21 ~ +18	-21 ~ +18	-21 ~ +18	-21 ~ +18	-21 ~ +18

Data is for reference. Hot water take out function added, EU safety regulation standard cleared. 25HP chassis enlarged due to specification improvement. Pre-coat corrosion fin. Auto pump down function.



3-PIPE ECO G GF3 SERIES



Power supply problems?

If you are short of electrical power, our gas heat pump could be the perfect solution:

- Runs on natural gas or LPG and just needs Single Phase supply
- Enables the building's electrical power supply to be used for other critical electrical demands
- Reduces capital cost to upgrade power substations to run heating and cooling systems
- Reduces power loadings within a building especially during peak periods
- Electricity supply freed up for other uses such as IT servers, commercial refrigeration, manufacturing, lighting etc.

ECO G Outdoor Heat Exchanger.

- Integrated DX and hot water coil
- No defrost required
- Faster reaction to demand for heating

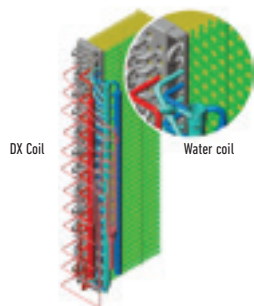

DHW production in heating and cooling

Free DHW is available 365 days a year, in all seasons. Hot water is produced effectively from waste heat from engine. Perfect solution for hotel projects required high demand of hot water.

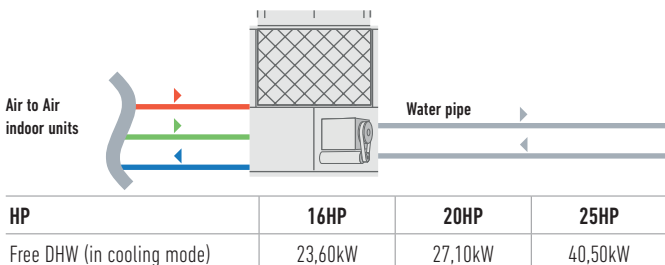

Excellent performance and free Domestic Hot Water

Panasonic 3-Pipe Multi system is capable of simultaneous heating/cooling and individual operation of each indoor unit by only one outdoor unit. As a result, efficient individual air conditioning is possible in buildings having diverse room temperatures.

In addition, Domestic Hot Water is created for free in cooling mode without additional boilers or electric heaters.

System example.

Improved maintenance intervals. The unit only needs to be serviced every 10,000 hours. This is the best in the industry.

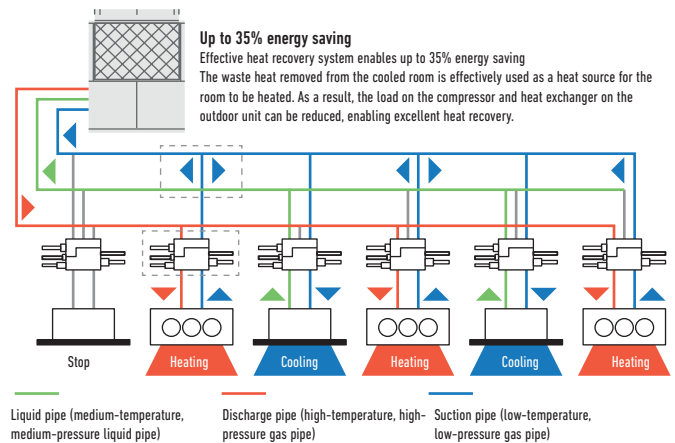

Solenoid valve kit.

To be fitted on all 'zones' to allow simultaneous heating and cooling. Up to 24 indoor units are capable of simultaneous heating/cooling operation. Oil-recovery operation to gives more stable comfort air-conditioning control.

3-Pipe control Solenoid valve kit

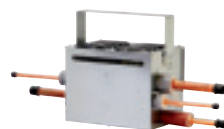

CZ-P56HR3
Up to 5,60kW
CZ-P160HR3
Up to 16,00kW

KIT-P56HR3
(CZ-P56HR3+CZ-CAPE2)
KIT-P160HR3
(CZ-P160HR3+CZ-CAPE2)

3-Pipe control PCB



CZ-CAPE2*
3-Pipe control PCB

* For wall mounted. Must be added to the CZ-P56HR3 or CZ-P160HR3.



**HOT WATER
AT 65°C
OUTLET FOR
FREE**

3-Pipe ECO G GF3 Series



DHW available in all seasons

Domestic hot water can be taken out from waste heat of engine effectively in heating & cooling - all year round.

Outstanding seasonal energy efficiency, maximum 204,9%

- Capacity ratio 50 ~ 200%
- No defrost cycle
- Maximum total piping length: 780m

Flexible installation

- Full heating capacity down to -21°C (WB)
- DHW production for all the year
- Maximum 24 indoor units connectable

HP			16HP	20HP	25HP
Model			U-16GF3E5	U-20GF3E5	U-25GF3E5
Power supply	Voltage	V	220 / 230 / 240	220 / 230 / 240	220 / 230 / 240
	Phase		Single Phase	Single Phase	Single Phase
	Frequency	Hz	50	50	50
Cooling capacity		kW	45,00	56,00	71,00
Refrigeration load Pdesign		kW	45,00	56,00	71,00
η_{sc} (LOT21)¹		%	185,20	198,80	204,90
Input power cooling		kW	1,17	1,40	1,80
Hot water in cooling mode (at 65°C outlet)		kW	23,60	27,10	40,50
Gas consumption cooling		kW	45,80	54,80	73,70
Heating capacity	Standard	kW	50,00	63,00	80,00
	Low temperature	kW	53,00	67,00	78,00
Refrigeration load Pdesign		kW	38,00	52,00	60,00
η_{sh} (LOT21)¹		%	139,20	140,20	150,90
Input power heating		kW	0,56	1,05	0,91
Gas consumption heating	Standard	kW	42,20	51,10	68,60
Starter amperes		A	30	30	30
Air volume		m ³ /min	370	400	460
Sound power	Normal / Silent mode	dB	80 / 77	81 / 78	84 / 81
Dimension	HxWxD	mm	2255 x 1650 x 1000	2255 x 1650 x 1000	2255 x 2026 x 1000
Net weight		kg	775	775	880
Piping connections	Liquid pipe	Inch (mm)	3/4 (19,05)	3/4 (19,05)	3/4 (19,05)
	Gas pipe	Inch (mm)	1 1/8 (28,58)	1 1/8 (28,58)	1 1/8 (28,58)
	Discharge	Inch (mm)	7/8 (22,22)	1 (25,40)	1 (25,40)
	Fuel gas	Inch (mm)	19,05 (R3/4)	19,05 (R3/4)	19,05 (R3/4)
	Exhaust drain port	mm	25	25	25
	Hot water supply in/out		Rp3/4 (Nut, thread)	Rp3/4 (Nut, thread)	Rp3/4 (Nut, thread)
Elevation difference (in/out)		m	50	50	50
Refrigerant (R410A) / CO ₂ Eq.		kg / T	11,50 / 24,00	11,50 / 24,00	11,50 / 24,00
Maximum number of connectable indoor units			24	24	24
Operating range	Cool Min ~ Max	°C	-10 ~ +43	-10 ~ +43	-10 ~ +43
	Heat Min ~ Max	°C	-21 ~ +18	-21 ~ +18	-21 ~ +18

Solenoid valve kit

KIT-P56HR3	KIT-P56HR3	3-Pipe control Solenoid valve kit (up to 5,60kW)
	CZ-P56HR3	Solenoid valve kit (up to 5,60kW)
	CZ-CAPE2	3-Pipe control PCB
KIT-P160HR3	KIT-P160HR3	3-Pipe control Solenoid valve kit (from 5,60 to 16,00kW)
	CZ-P160HR3	Solenoid valve kit (up to 16,00kW)
	CZ-CAPE2	3-Pipe control PCB
CZ-CAPEK2		3-Pipe control PCB for wall mounted

3-Pipe control box kit

CZ-P456HR3	4 ports 3 pipe box (up to 5,60kW)
CZ-P656HR3	6 ports 3 pipe box (up to 5,60kW)
CZ-P856HR3	8 ports 3 pipe box (up to 5,60kW)
CZ-P4160HR3	4 ports 3 pipe box (up to 16,00kW)

1) SEER/SCOP is calculated based on the seasonal space cooling/heating efficiency "η" values of the COMMISSION REGULATION (EU) 2016/2281.

Hot water take out function added, EU safety regulation standard cleared, 25HP chassis enlarged due to specification improvement. Pre-coat corrosion fin. Auto pump down function.



PANASONIC GHP/EHP HYBRID SYSTEM. FIRST INTELLIGENT TECHNOLOGY

GHP + EHP
HYBRID
VRF SYSTEM



Taking advantage of Gas and Electricity to achieve better energy saving ever.

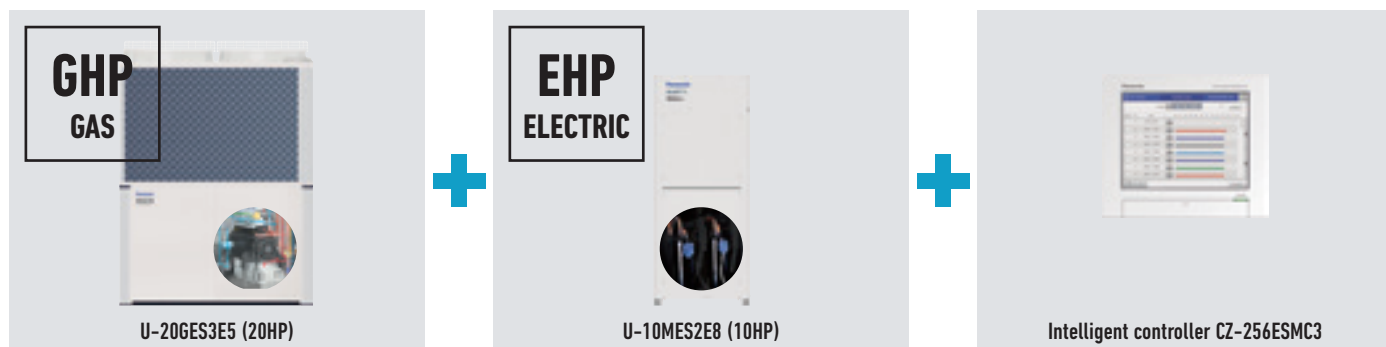

- Master unit GHP**
- Load calculation of GHP&EHP
 - Operation in accordance with the upper limit setting.
 - Individual capacity control
 - Device control
 - Special control (Defrost, Oil recovery, 4Way-valve matching / Abnormality processing)
- Slave Unit EHP**
- Intelligent controller**
- Demand monitoring
 - Indoor/Total load calculation
 - Operation Ratio Indication upper limit setting of MAP according to:
 - Energy unit price
 - Electric power demand
 - Air conditioning load

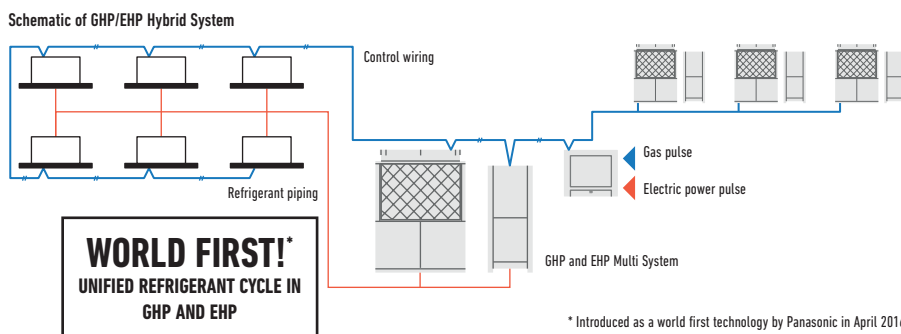

* Introduced as a world first technology by Panasonic in April 2016.

1 Peak cut of electricity consumption

Electrical peak demand is significantly reduced thanks to GHP system consuming less than 10% of electricity of EHP system.

* Image of Hotel project.

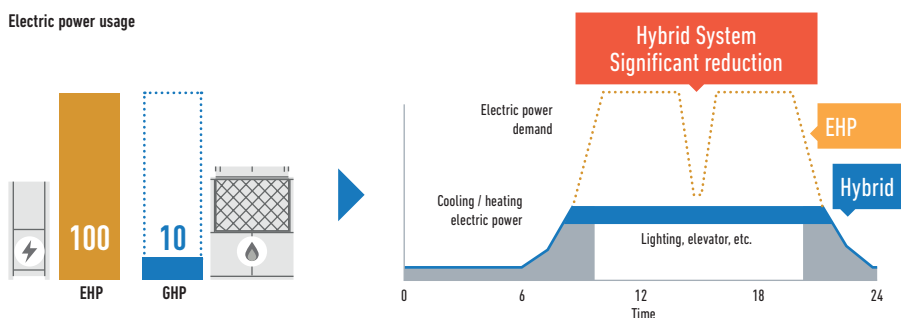

2 Optimal control to maximize energy saving

Switching the operation between GHP and EHP system on the basis of usage, energy demand, part load.

* Specification is tentative.

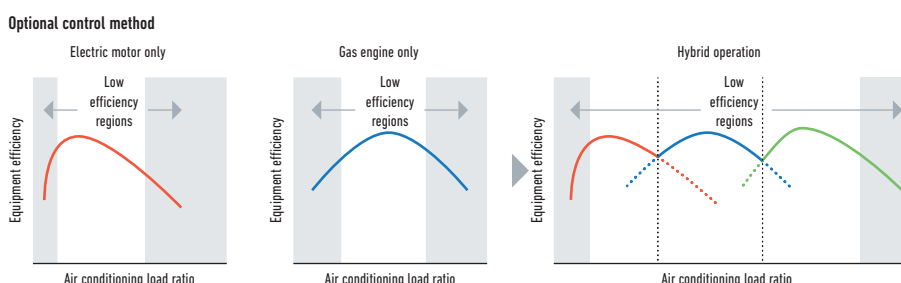

3 Free Hot Water production by GHP system

Hot water is effectively produced from waste heat of engine.

* Specification is tentative.

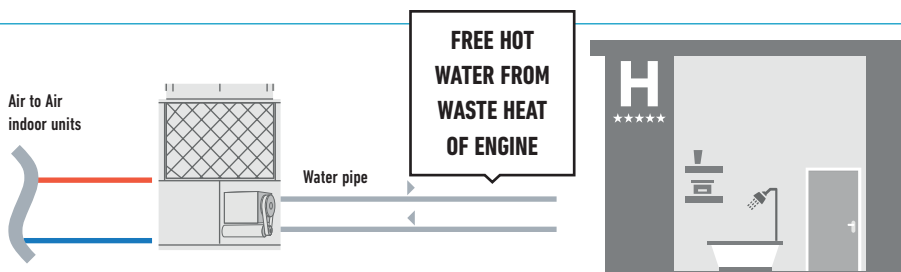

GHP/EHP HYBRID SYSTEM

It is time to save energy utilising the advantages from gas and electricity by Panasonic reliable ECO G / ECOi technology

New hybrid system can offer intelligent operation logic for better economy and efficiency by taking the best of ECO G and ECOi. This is like a hybrid car in heating and cooling system.

How smartly operate GHP and EHP system depending on your needs?

4 different mode settings are available with the intelligent controller. Switch the operation between GHP and EHP or operating both units together to maximize the effect for different requirement such as economy and efficiency.

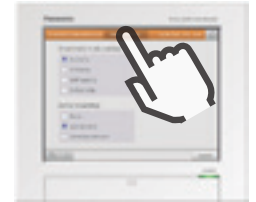

Economy mode

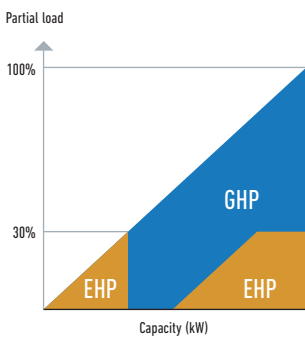

Efficiency mode

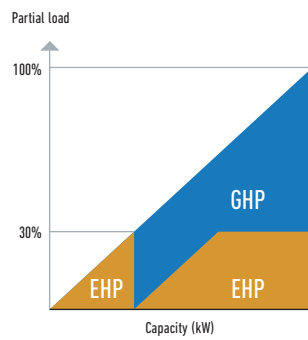

GHP first mode

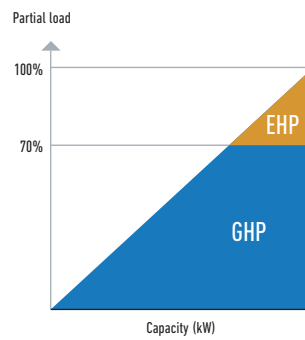

EHP first mode

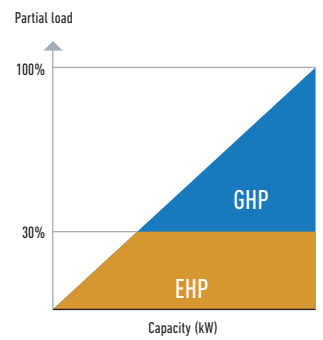

Optimal control example: Economy mode

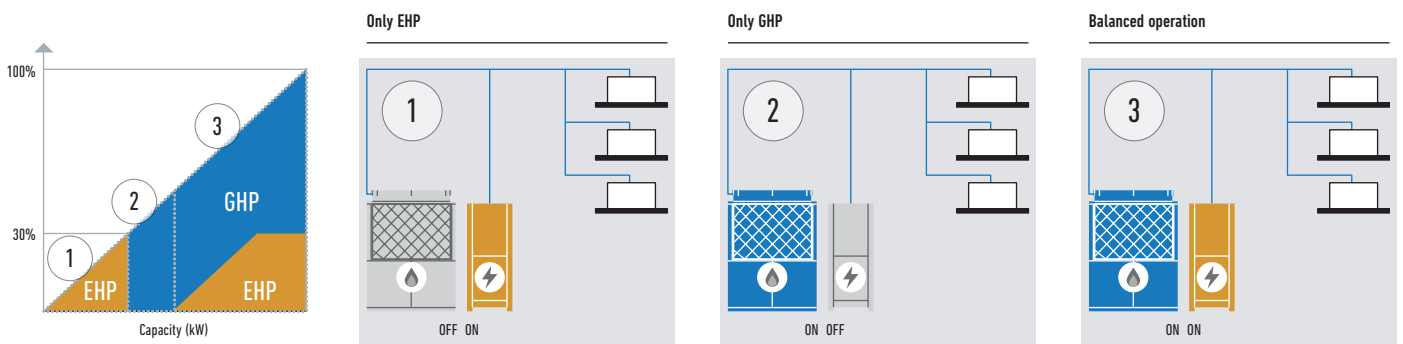

DHW priority mode in Hybrid + WHE System

When DHW is demanded during cooling operation by EHP, EHP is automatically turned "OFF" and GHP is turned "ON" to produce DHW for free.

High efficiency mode

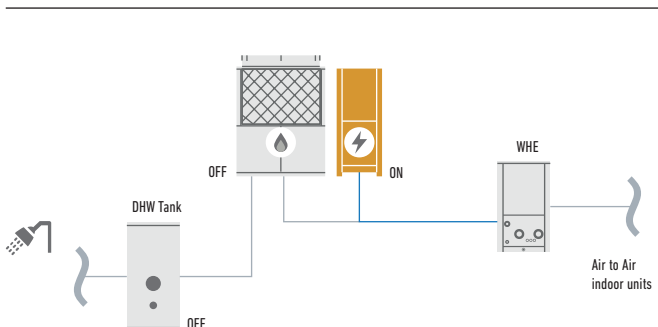

DHW priority mode

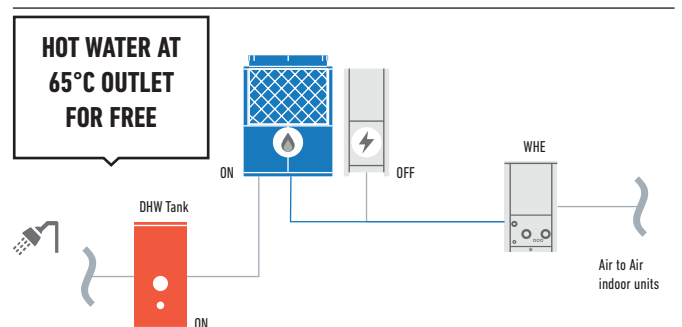

2-Pipe Hybrid GHP/EHP



- Extended lifespan with intelligent energy management.
The goal is for the EHP and GHP to work at optimal speeds
- Low energy cost
- Low emissions

Technical focus

- 4 different setting (Economy, Efficiency, GHP first mode, EHP first mode)
- DHW energy recovery 26,2kW (at 65°C) by waste heat of engine
- Unified refrigerant cycle in GHP and EHP for easy installation
- DHW priority mode with WHE system
- Up to 48 indoor units connectable

			Hybrid GHP	Hybrid EHP
			20HP	10HP
			U-20GES3E5	U-10MES2E8
HP				
Outdoor Units				
Power supply	Voltage	V	220 / 230 / 240	220 / 230 / 240
	Phase		Single Phase	Three Phase
	Frequency	Hz	50	50
Cooling capacity		kW	56,00	28,0
η_{sh} (LOT21)¹		%	211,80	275,40
Running current cooling		A	5,18	10,70 / 10,20 / 9,80
Input power cooling		kW	1,12	6,41
Hot water in cooling mode (at 65°C outlet)		kW	26,20	—
Gas consumption cooling		kW	52,10	—
Heating capacity		kW	63,00	31,50
η_{sh} (LOT21)¹		%	143,20	167,60
Running current heating		A	4,79	11,10 / 10,50 / 10,10
Input power heating		kW	1,05	6,62
Gas consumption heating	Standard	kW	51,10	—
Starting current		A	30	1
Air volume		m ³ /min	420	224
Sound pressure	Normal mode	dB(A)	58	56
Sound power	Normal mode	dB	80	77
Dimension	H x W x D	mm	2255 x 1650 x 1000	1842 x 770 x 1000
Net weight		kg	765	210
Piping connections ²⁾	Liquid pipe	Inch (mm)	5/8 (15,88)	3/8 (9,52)
	Gas pipe	Inch (mm)	1 1/8 (28,58)	7/8 (22,22)
	Balance pipe	Inch (mm)	1/4 (6,35)	1/4 (6,35)
Drain heater		W	40	—
Refrigerant (R410A) / CO ₂ Eq.		kg / T	11,05 / 23,0724	5,60 / 11,6928
Maximum allowable indoor / outdoor capacity ratio %			50 ~ 130	50 ~ 130
Operating range	Cool Min ~ Max	°C	-10 ~ +43	-10 ~ +43
	Heat Min ~ Max	°C	-21 ~ +18	-21 ~ +18

1) SEER/SCOP is calculated based on the seasonal space cooling/heating efficiency "η" values of the COMMISSION REGULATION (EU) 2016/2281.

2) Please refer service manual when the maximum piping length exceeds 90 meters (equivalent length).

WATER HEAT EXCHANGER FOR HYDRONIC APPLICATIONS



Chiller replacement. Chilled water supply to fan coils

Chiller replacement.

When some old chillers needed replacing at the end of their operational lifetime, ECO Gs with Water Heat Exchangers enabled the project to be carried out in stages whilst still utilising the existing water pipe work and fan coils. This enabled the project to be delivered on time, to a restricted budget and avoided all issues regarding refrigerant in confined spaces.



When a top London restaurant opened, it needed large volumes of fresh air to ensure the optimum dining environment. ECO G units connected to the cooling coils within the air handling equipment ensured the air was introduced in the right condition in both summer and winter.

Connection to 'close control' computer equipment

Computer room applications.

When all available electrical power needed to be utilised for the IT equipment for a leading international bank, the cooling load of over 450kW had to be powered by gas. The outdoor units were connected via Water Heat Exchangers to cooling coils inside the 'close control' units thereby maintaining a conditioned environment for temperature and humidity. By utilising the hot water function over 100kW of hot water are supplied to the building and therefore the additional benefit of considerable CO₂ savings is ensured.

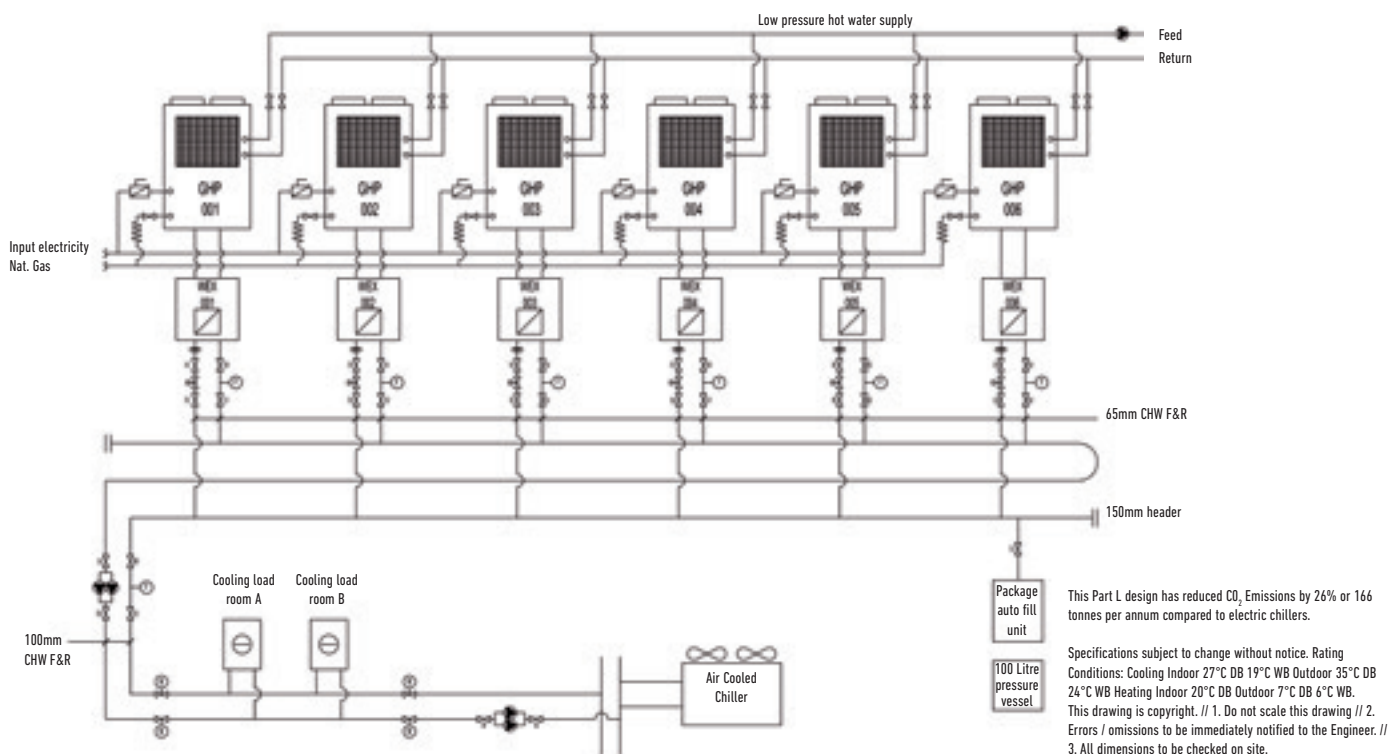

ECOi Water Heat Exchanger

Electrical VRF with Water Heat Exchanger

With this easy to install Water Heat Exchanger unit, you can now cover projects up to 51kW hot water demand or 44kW on chilled application on a efficient way and cost effective

System example.

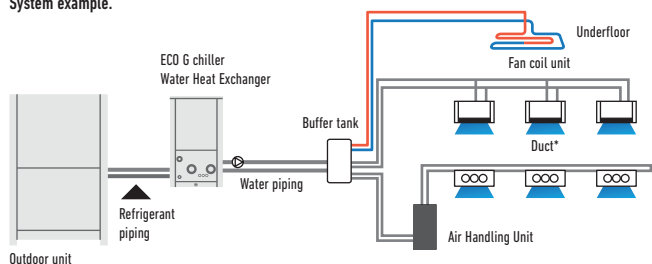

A Buffer tank of minimum 280l for 28kW and 500l for 50kW is always needed.

Example of Hotel renewal of existing Chiller and Boiler system with Panasonic ECO G and Aquarea mixed solution.

ECO G and Aquarea are the smart solution for renewal Chiller/Boiler applications with annual running cost savings around 13.600€.

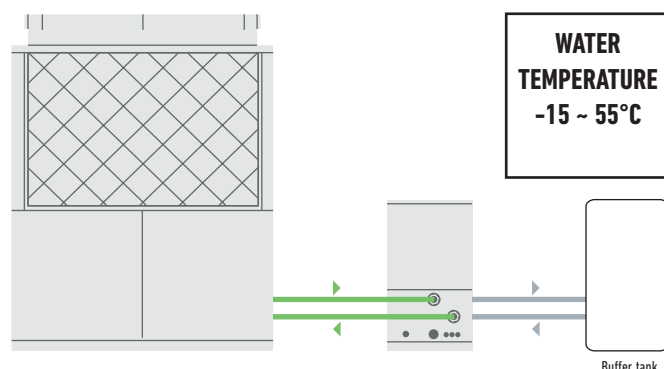

2-Pipe ECOi with Water Heat Exchanger for chilled and hot water production



Water Heat Exchanger (WHE) for hydronic applications

WHE for ECOi system controlled by a timer remote control CZ-RTC5B.
Energy-efficient capacity control with superior external static pressure is now ready.
Availability of easy vertical stacking allows installations in a limited space (up to 3 units)*.
Stainless steel plate heat exchanger with anti-freeze protection control.
Change over between heating and cooling operation.

* Stacking kit (PAW-3WSK) is necessary.

- Heating, cooling and DHW
- A class water pump included (only in P model)
- Flexible modularity from 25kW
- Better partial load vs standard chiller system
- Compatible with all centralized controllers
- Maximum distance between outdoor unit and WHE: 170m
- Maximum hot water outlet temperature: 45°C
- Minimum chilled water outlet temperature: 5°C
- Outdoor temperature range in heating mode: -11°C to +15°C (with low temperature kit -25°C)

Technical focus

Hydrokit with A class water pump		PAW-250WP5G	PAW-500WP5G
Hydrokit without pump		PAW-250W5G	PAW-500W5G
Cooling capacity at 35°C, water outlet 7°C	kW	25,00	50,00
Heating capacity	kW	28,00	56,00
Heating capacity at +7°C, heating water temperature at 45°C	kW	28,00	56,00
COP at +7°C with heating water temperature at 45°C	W/W	2,97	3,10
Heating Energy Efficiency class at 35°C ¹⁾		A+	A+
η _{sh} (LOT21) ²⁾	%	164,00	158,00
Dimension	HxWxD	1000 x 575 x 1110	1000 x 575 x 1110
Net weight		135 (140 with pump)	155 (165 with pump)
Water pipe connector		Rp2 Female Thread (50A)	Rp2 Female Thread (50A)
Heating water flow (ΔT=5 K, 35°C)	m ³ /h	5,16	10,32
Capacity of integrated electric heater	kW	Not equipped	Not equipped
Flow switch		Equipped	Equipped
Water filter		Equipped	Equipped
Input power	kW	0,329 (with A class water pump) / 0,024 (without pump)	0,574 (with A class water pump) / 0,024 (without pump)
Maximum current	A	1,43 (with A class water pump) / 0,10 (without pump)	2,50 (with A class water pump) / 0,10 (without pump)
Outdoor unit		U-10ME2E8	U-20ME2E8
Sound pressure		56	60
Dimension	HxWxD	1842 x 770 x 1000	1842 x 770 x 1000
Net weight		210	375
Piping connections	Liquid pipe	Inch (mm)	3/8 (9,52)
	Gas pipe	Inch (mm)	7/8 (22,22)
Refrigerant (R410A) / CO ₂ Eq.	kg	5,6 *Need Additional gas amount at site	9,5 *Need Additional gas amount at site
Pipe length range / Elevation difference (in/out)	m	170 / 50 (OD above) 35 (OD below)	170 / 50 (OD above) 35 (OD below)
Pipe length for nominal capacity	m	7,5	7,5
Pipe length for additional gas / Additional gas amount (R410A)	m / g/m	0 < / Refer to manual	0 < / Refer to manual
Operation range	Heat Min ~ Max	°C	-11 ~ +15 ³⁾
	Cool Min ~ Max	°C	+5 ~ +15
Water outlet temperature range	Heat Min ~ Max	°C	+35 ~ +45

Accessories

PAW-3WSK Stacking kit for vertical stacking (4 sets in the Kit)

1) Unit efficiency energy level: Scale from A++ to G. 2) Seasonal space cooling/heating energy efficiency following COMMISSION REGULATION (EU) 813/2013. 3) With accessory low temperature kit -25 ~ +15°C.

Performance calculation in agreement with Eurovent. Sound pressure measured at 1m from the outdoor unit and at 1,5m height.

Stacking kit PAW-3WSK.

It is possible to stack up to 3 units. When stacking units, always anchor the bottom unit to the ground using the anchor holes.

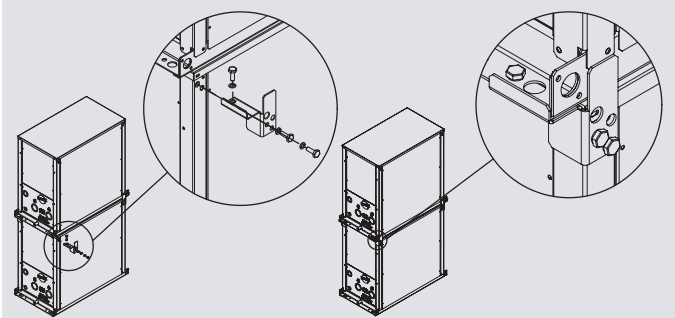

2-Pipe ECO G with Water Heat Exchanger for chilled and hot water production



Water Heat Exchanger (WHE) for hydronic applications

WHE for ECO G system controlled by a timer remote control CZ-RTC5B.

Energy-efficient capacity control with superior external static pressure is now ready.

Availability of easy vertical stacking allows installations in a limited space (up to 3 units)*.

Stainless steel plate heat exchanger with anti-freeze protection control.

Change over between heating and cooling operation.

* Stacking kit (PAW-3WSK) is necessary.

Technical focus

- Heating, cooling and DHW
- A class water pump included (only in P model)
- No cascade installation up to 80kW
- Free DHW from waste heat of engine
- Compatible with all centralized controllers
- Maximum distance between outdoor unit and WHE: 170m
- Hot water outlet temperatures from 35°C to 55°C
- Chilled water outlet temperatures from -15°C to +15°C
- Minimum outdoor temperature in heating mode: -21°C

Hydrokit with A class water pump			PAW-500WP5G	PAW-710WP5G
Hydrokit without pump			PAW-500W5G	PAW-710W5G
Heating capacity	kW		60,00	80,00
Heating capacity at +7°C, heating water temperature at 35°C	kW		60,90	81,20
COP at +7°C with heating water temperature at 35°C	W/W		1,15	1,18
Heating capacity at +7°C, heating water temperature at 45°C	kW		60,00	80,00
COP at +7°C with heating water temperature at 45°C	W/W		1,02	1,04
Heating capacity at -7°C, heating water temperature at 35°C	kW		48,20	50,80
COP at -7°C, heating water temperature at 35°C	W/W		0,80	0,80
Heating capacity at -15°C, heating water temperature at 35°C	kW		46,30	50,00
COP at -15°C with heating water temperature at 35°C	W/W		0,80	0,80
Refrigeration load Pdesign	kW		48,00	—
Heating Energy Efficiency class at 35°C¹⁾			A+	—
η_{sh} (LOT21) ²⁾	%		130,04	127,94
Cooling capacity	kW		—	—
Cooling capacity at +35°C, outlet temperature 7°C, inlet temperature 12°C	kW		50,00	67,00
EER at +35°C, outlet temperature 7°C, inlet temperature 12°C	W/W		0,78	0,89
Dimension	HxWxD	mm	1000 x 575 x 1110	1000 x 575 x 1110
Net weight		kg	155 (165 with pump)	160 (175 with pump)
Water pipe connector			Rp2 Female Thread (50A)	Rp2 Female Thread (50A)
Heating water flow ($\Delta T=5$ K, 35°C)	m ³ /h		10,32	13,76
Capacity of integrated electric heater	kW		Not equipped	Not equipped
Flow switch			Equipped	Equipped
Water filter			Equipped	Equipped
Input power	kW		0,574 (with A class water pump) / 0,024 (without pump)	0,824 (with A class water pump) / 0,024 (without pump)
Maximum current	A		2,50 (with A class water pump) / 0,10 (without pump)	3,60 (with A class water pump) / 0,10 (without pump)
Outdoor Unit			U-20GE3E5	U-30GE3E5
Sound power	Normal / Silent	dB	80 / 77	84 / 81
Dimension	HxWxD	mm	2255 x 1650 x 1000	2255 x 2026 x 1000
Net weight		kg	765	880
Piping connections	Liquid pipe	Inch (mm)	5/8 (15,88)	3/4 (19,05)
	Gas pipe	Inch (mm)	1-1/8 (28,58)	1-1/4 (31,75)
Pipe length / Pipe length for nominal capacity		m	7 / 170	7 / 170
Elevation difference (in/out)		m	50 (OD above) 35 (OD below)	50 (OD above) 35 (OD below)
Operation range	Heat Min ~ Max	°C	-21 ~ +24 (until outlet temperature 45)	-21 ~ +24 (until outlet temperature 45)
	Cool Min ~ Max	°C	-15 ~ +15	-15 ~ +15
Water outlet temperature range	Heat Min ~ Max	°C	+35 ~ +55	+35 ~ +55

Accessories

PAW-3WSK	Stacking kit for vertical stacking (4 sets in the Kit)
----------	--

1) Unit efficiency energy level: Scale from A++ to G. 2) Seasonal space cooling/heating energy efficiency following COMMISSION REGULATION (EU) 813/2013.

Performance calculation in agreement with Eurovent. Sound pressure measured at 1m from the outdoor unit and at 1,5m height.

LEAK DETECTION AND AUTOMATIC REFRIGERANT PUMP DOWN



Improving safety and the environment

Panasonic has developed an innovative solution to detect refrigerant leaks that offer complete assurance and protection for end users, building occupiers and the environment. Panasonic's Pump Down System is ideal for hotels, offices and public buildings where safety for occupants and the building owners is of utmost importance.

The system monitors refrigerant leakage continually and provides a warning before refrigerant leaks, preventing major refrigerant loss and potentially damaging the system's efficiency. The new system can improve potential refrigerant loss to approximately 90%.

As well as ensuring safe and reliable operation, Panasonic's Pump Down System contributes to a building qualifying for additional BREEAM points and enables compliance with current EN378 2008 standards, covering applications where refrigeration concentration levels exceed practical safety limits of 0,44 kg/m³.

Panasonic has developed two detection methods that can operate simultaneously to offer complete protection for owners, building occupiers and the environment.

Pump Down system

This innovative pump down system can be connected in two ways:

- With sensor leakage
- Without sensor leakage, using only an innovative algorithm

Basic pump down function:

- Detect the leakage
- Activate pump down process
- Collect the gas in the tank
- Close the valves to isolate the gas

Key points:

- Comply with legislation
- Protect personnel
- Protect the environment
- Save on operating costs

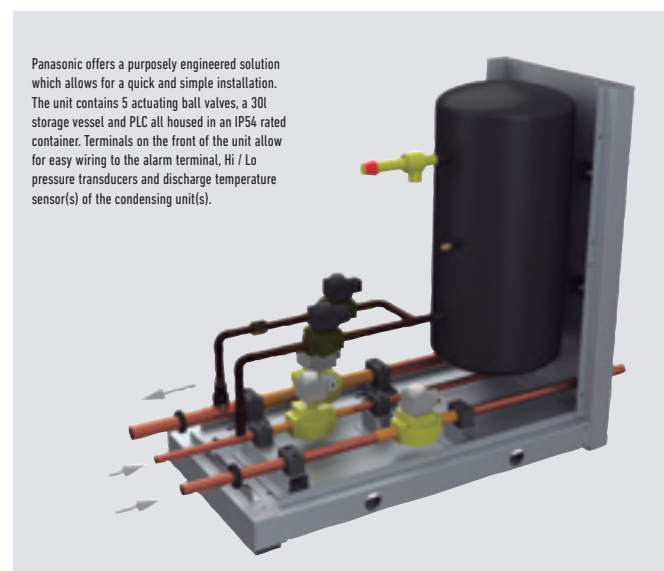

R22 Renewal

Panasonic's advanced technology enables the system to work with previously installed pipe work by managing the working pressure within the system down to R22 (33 bar) levels, this ensures the system works safely and efficiently without loss of capacity.

The new equipment can offer increased COP/EER by using state of the art inverter compressor and heat exchanger technology.

Having contacted your Panasonic supplier regarding pipe work restrictions

and gained approval to use the Panasonic Renewal

System there are three main tests that have to be carried out to ensure that the system can be used effectively. Firstly a thorough inspection of the pipe work must be carried out and any damage must be repaired.

Secondly an oil test has to be carried out to ensure that the system has not been subject to a compressor burnout during its lifetime. Lastly a VRF Renewal Kit (CZ-SLK2) has to be installed within the pipe work to ensure that the system is cleaned of any remnants of oil.

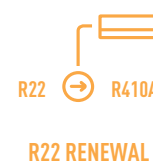

DESIGN SUPPORT SOFTWARE FOR VRF



Features the unique Mounting Scheme function providing more thorough spec-in and tender quotation support for easier, faster completion of work



The Panasonic VRF Designer software can be used for all Panasonic VRF ME2, LE and MF3.

Panasonic has identified the importance of ever-increasing demands for fast and accurate responses to customer requests in our industry. More and more emphasis is being placed upon energy-efficiency in our marketplace. The ability to calculate cooling/heating loads and produce information of actual design conditions is a major advantage to any architect, consultant, contractor or end user.

Panasonic understands the time-poor and demanding industry we are in and we are pleased to announce the launch of the next generation of our system design software program.

The Panasonic VRF Designer software has been customised to make the selection and design process as quick and easy as possible.

The design package utilises system wizards and import tools to enable both simple and complex systems to be created. In addition, the system will allow outdoor and indoor units to be dragged on an interactive desktop. This allows users to create everything from realistic floor plans with detailed piping and wiring schematics to send out with quotations, through to installation guidance drawings.

Features include:

- Mounting scheme. Design selection from building floor drawing
- Any kind of drawing format. (dxf, jpg, png..etc.)
- Conventional principal scheme
- Easy to use system wizards
- Auto piping and wiring features
- Converted duties for conditions and pipework
- Auto(CAD) (dxf), Excel and PDF export
- Detailed wiring and pipework diagrams
- Automatic price quotation
- Automatic tender document assist
- SEER, SCOP
- ESEER

Panasonic's Advanced VRF software with AutoCAD® compatibility makes design easier than ever

Panasonic provides bespoke software helping system designers, installers and dealers to very quickly design and size systems, create wiring diagrams and issue bills of quantities at the push of a button.



Panasonic VRF Service Checker

Panasonic will make available to installers and commissioning companies the VRF Service Checker as a communication interface to Panasonic VRF systems. This easy to manage tool checks all parameters of the system.

The VRF Service Checker allows:

- On ECOi and Mini ECOi connect anywhere on the P-Link
- Search the P-Link to validate systems that are connected
- Monitor all indoor and outdoor units simultaneously on 1 screen
- Monitor all Temperature data, Pressure data, Valve position, and alarm status on 1 screen
- Data can be viewed in Graph or number format
- Controlling the indoor unit ON/OFF, MODE, SET POINT, FAN, and TEST mode
- Switching between various systems on same communication P-Link (ECOi only)
- Monitor and record at a set interval time
- Record and review the data at a later date
- Update software as ROM flash writer

This Panasonic VRF Service Checker is available from your service partner.









Interface Box







NEW VRF SYSTEMS INDOOR UNITS





ECOi AND ECO G SYSTEMS INDOOR UNITS RANGE

Page		1,50kW	2,20kW	2,80kW	3,00kW	3,60kW	4,00kW	4,50kW
P. 272	U2 Type 4 Way 90x90 Cassette							
			S-22MU2E5A	S-28MU2E5A		S-36MU2E5A		S-45MU2E5A
P. 274	Y2 Type 4 Way 60x60 Cassette							
		S-15MY2E5A	S-22MY2E5A	S-28MY2E5A		S-36MY2E5A		S-45MY2E5A
P. 275	L1 Type 2 Way Cassette							
			S-22ML1E5	S-28ML1E5		S-36ML1E5		S-45ML1E5
P. 276	D1 Type 1 Way Cassette							
				S-28MD1E5		S-36MD1E5		S-45MD1E5
P. 277	F2 Type Variable Static Pressure Hide Away							
		S-15MF2E5A	S-22MF2E5A	S-28MF2E5A		S-36MF2E5A		S-45MF2E5A
P. 278	M1 Type Slim Variable Static Pressure Hide Away							
		S-15MM1E5A	S-22MM1E5A	S-28MM1E5A		S-36MM1E5A		S-45MM1E5A
P. 279	E2 Type High Static Pressure Hide Away							
P. 280	Heat Recovery with DX Coil							
					PAW-500ZDX3N		PAW-800ZDX3N	PAW-01KZDX3N
P. 281	T2 Type Ceiling							
						S-36MT2E5A		S-45MT2E5A
P. 282	NEW G1 Type Floor Console							
			S-22MG1E5	S-28MG1E5		S-36MG1E5		S-45MG1E5
P. 284	K2 Type Wall Mounted							
		S-15MK2E5A	S-22MK2E5A	S-28MK2E5A		S-36MK2E5A		S-45MK2E5A
P. 285	P1 Type Floor Standing							
			S-22MP1E5	S-28MP1E5		S-36MP1E5		S-45MP1E5
P. 286	R1 Type Concealed Floor Standing							
			S-22MR1E5	S-28MR1E5		S-36MR1E5		S-45MR1E5
P. 287	Hydrokit for ECOi, water at 45°C							

Page		16,00kW	28,00kW	56,00kW	84,00kW	112,00kW	140,00kW	168,00kW
P. 294	AHU Connection Kit 16, 28 and 56kW							
		PAW-160MAH2/M/L	PAW-280MAH2/M/L	PAW-560MAH2/M/L	PAW-280MAH2/M/L + PAW-560MAH2/M/L	PAW-560MAH2/M/L x 2	PAW-280MAH2/M/L + PAW-560MAH2/M/L x 2	PAW-560MAH2/M/L x 3

Page		250m ³ /h	350m ³ /h	500m ³ /h	800m ³ /h	1000m ³ /h
P. 298	Energy Recovery Ventilation					
		FY-250ZDY8R	FY-350ZDY8R	FY-500ZDY8R	FY-800ZDY8R	FY-01KZDY8R

5,60kW 6,00kW 7,30kW 9,00kW 10,60kW 14,00kW 16,00kW 22,40kW 28,00kW



S-56MU2E5A S-60MU2E5A S-73MU2E5A S-90MU2E5A S-106MU2E5A S-140MU2E5A S-160MU2E5A



S-56MY2E5A



S- 56ML1E5



S-73ML1E5



S-56MD1E5



S-73MD1E5



S-56MF2E5A S-60MF2E5A S-73MF2E5A S-90MF2E5A S-106MF2E5A S-140MF2E5A S-160MF2E5A



S-56MM1E5A



S-224ME2E5



S-280ME2E5



S-56MT2E5A



S-73MT2E5A



S-106MT2E5A



S-140MT2E5A



S-56MG1E5



S-56MK2E5A

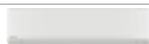

S-73MK2E5A



S-106MK2E5A



S-56MP1E5



S-71MP1E5



S-56MR1E5



S-71MR1E5



S-80MW1E5



S-125MW1E5

Page

7,90kW

12,00kW

15,00kW

19,00kW

23,60kW

27,60kW

P. 296

Air Curtain LS type with DX Coil



PAW-10EAIRC-LS



PAW-15EAIRC-LS



PAW-20EAIRC-LS



PAW-25EAIRC-LS

P. 296

Air Curtain HS type with DX Coil



PAW-10EAIRC-HS



PAW-15EAIRC-HS



PAW-20EAIRC-HS



PAW-25EAIRC-HS

4 WAY 90x90 CASSETTE WITH NANOE™ X

Large capacity VRF. Trusted power and high efficiency. These Cassettes offer upgraded Econavi and nanoe™ X purification systems as accessories for making application space more comfortable, healthy and efficient.

Thanks to advances in design and technology such as the new high performance turbo fan which is more efficient and silent, and nanoe™ X air purification, for total healthy and the floor temperature & humidity sensor to more control, the new U2 Panasonic 4 Way 90x90 Cassette offers healthy and comfort.

Always fresh and clean air with nanoe™ X

The nanoe™ X is available with the advanced technology of room air conditioning.

- Purifying operation can work simultaneously or independently from heating/cooling operation.
- Inhibiting certain viruses, bacteria & deodorisation (bacteria, fungus, pollen, virus and cigarette smoke). OH radicals in nanoe™ X pull bacteria's hydrogen out to effectively deodorise and sterilise
- Clean inside by nanoe™ X + Dry control: inside of indoor unit can be cleaned by short operation circuit with nanoe™ X and drying

CZ-RTC5B and optional accessory CZ-CNEXU1 are required to use nanoe™ X function.

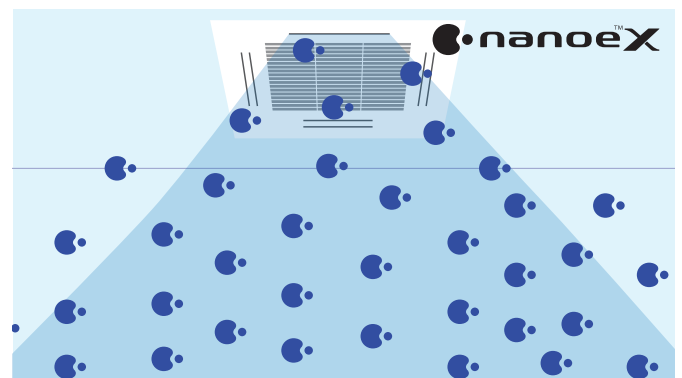

Econavi intelligent sensor

Human activity sensor and floor temperature sensor can reduce waste of energy by optimising air conditioner operation.



Advanced Econavi functions.

2 sensors (movement and floor temperature) can find waste of energy and control effectively. Floor temperature can detect up to 5m ceiling height.

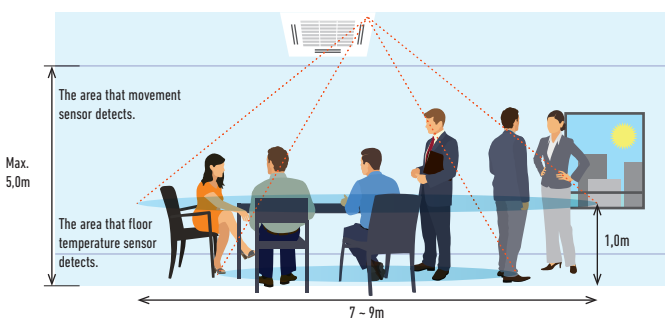

Econavi exclusive panel. Optional (CZ-KPU3AW)

Floor temperature sensor.
This sensor detects average floor temperature and operates circulation if floor temperature is low.

Movement sensor.
This sensor detects the amount of human activity, and operates effectively.

Wired remote controller CZ-RTC5B is required.

Humidity sensor.

New Humidity sensor has air suction function, and realises comfort and energy saving based on temperature and humidity.

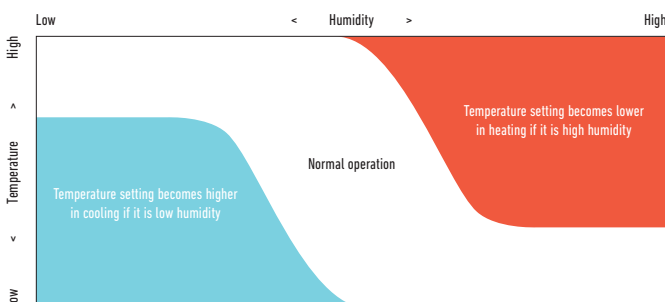

Group control, circulation function.

Circulating operation is activated when a room is unoccupied to evenly distribute air and minimize temperature gaps in both heating and cooling operation.

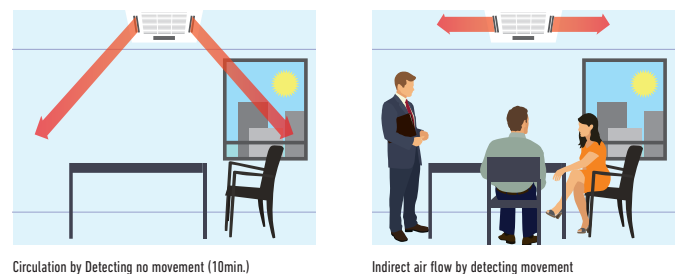

U2 Type 4 Way 90x90 Cassette

The U2 Panasonic 4 Way 90x90 Cassettes with new panel design and 2 types of body with height difference



CZ-KPU3W
Standard panel.

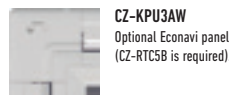

CZ-KPU3AW
Optional Econavi panel
(CZ-RTCSB is required).



CZ-CNEU1
Optional nanoe™ X kit
(CZ-RTCSB is required).



PAW-RE2CA
Optional Controller.
Control for hotel application.



CZ-RTCSB
Optional Controller.
Wired remote controller.
Compatible with Econavi.

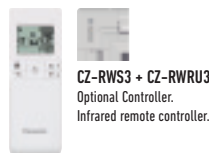

CZ-RWS3 + CZ-RWRU3
Optional Controller.
Infrared remote controller.



CZ-RE2C2
Optional Controller.
Simplified wired remote controller.

Technical focus

- High performance turbo fan, new path system for heat exchanger
- Lower noise in slow fan operation
- Ceiling height up to 5,0m
- Industry top light weight, easy piping
- Econavi: Floor temperature and humidity sensor added. Activity amount detection and new circulator
- nanoe™ X: The first 10x for CAC (10 times more purification power). Inside cleaning by 10x nanoe™ X + dry control
- Powerful drain pump gives 850mm lift
- Fresh air knockout
- Branch duct connection
- Optional air-intake plenum CZ-FDU2

Model		S-22MU2E5A	S-28MU2E5A	S-36MU2E5A	S-45MU2E5A	S-56MU2E5A	S-60MU2E5A	S-73MU2E5A	S-90MU2E5A	S-106MU2E5A	S-140MU2E5A	S-160MU2E5A
Cooling capacity	kW	2,20	2,80	3,60	4,50	5,60	6,00	7,30	9,00	10,60	14,00	16,00
Input power cooling	W	20,00	20,00	20,00	20,00	25,00	35,00	40,00	40,00	95,00	100,00	115,00
Current (cool)	A	0,19	0,19	0,19	0,19	0,22	0,31	0,33	0,36	0,71	0,76	0,89
Heating capacity	kW	2,50	3,20	4,20	5,00	6,30	7,10	8,00	10,00	11,40	16,00	18,00
Input power heating	W	20,00	20,00	20,00	20,00	25,00	35,00	40,00	40,00	85,00	100,00	105,00
Current (heat)	A	0,17	0,17	0,17	0,17	0,20	0,30	0,32	0,34	0,65	0,73	0,80
Fan type		Turbo fan	Turbo fan	Turbo fan	Turbo fan	Turbo fan	Turbo fan	Turbo fan	Turbo fan	Turbo fan	Turbo fan	Turbo fan
Air volume	Hi / Med / Lo m ³ /min	14,50 / 13,00 / 11,50	14,50 / 13,00 / 11,50	14,50 / 13,00 / 11,50	15,50 / 13,00 / 11,50	17,00 / 13,50 / 11,50	21,00 / 16,00 / 13,00	22,50 / 16,00 / 13,00	23,00 / 18,50 / 14,00	35,00 / 26,00 / 20,00	36,00 / 27,00 / 21,50	37,00 / 29,00 / 25,00
Sound pressure / power	Hi / Med / Lo dB(A) / dB	30 / 29 / 28 / 45 / 44 / 43	30 / 29 / 28 / 45 / 44 / 43	30 / 29 / 28 / 45 / 44 / 43	31 / 29 / 28 / 46 / 44 / 43	33 / 30 / 28 / 48 / 45 / 43	36 / 32 / 29 / 51 / 47 / 44	37 / 32 / 29 / 52 / 47 / 44	38 / 35 / 32 / 53 / 50 / 47	44 / 38 / 34 / 59 / 53 / 49	45 / 39 / 35 / 60 / 54 / 50	46 / 40 / 38 / 61 / 55 / 53
Dimension (H x W x D)	Indoor (Panel) mm	256 x 840 x 840 (33,5 x 950 x 950)	256 x 840 x 840 (33,5 x 950 x 950)	256 x 840 x 840 (33,5 x 950 x 950)	256 x 840 x 840 (33,5 x 950 x 950)	256 x 840 x 840 (33,5 x 950 x 950)	256 x 840 x 840 (33,5 x 950 x 950)	256 x 840 x 840 (33,5 x 950 x 950)	256 x 840 x 840 (33,5 x 950 x 950)	319 x 840 x 840 (33,5 x 950 x 950)	319 x 840 x 840 (33,5 x 950 x 950)	319 x 840 x 840 (33,5 x 950 x 950)
Net weight (Panel)	kg	21 (5)	21 (5)	21 (5)	21 (5)	21 (5)	21 (5)	21 (5)	21 (5)	25 (5)	25 (5)	25 (5)
Piping connections	Liquid Gas	Inch (mm) Inch (mm)	1/4 (6,35) 1/2 (12,70)	1/4 (6,35) 1/2 (12,70)	1/4 (6,35) 1/2 (12,70)	1/4 (6,35) 1/2 (12,70)	3/8 (9,52) 5/8 (15,88)	3/8 (9,52) 5/8 (15,88)	3/8 (9,52) 5/8 (15,88)	3/8 (9,52) 5/8 (15,88)	3/8 (9,52) 5/8 (15,88)	3/8 (9,52) 5/8 (15,88)

Panel design

Flat design, well-matched with interior, building.
Position of 4 air wings can be set individually.

2 types of body with height difference (same as current ones)

25,6cm and 31,9cm.

Panasonic introduces a modern flat panel design to blend into any space. These Cassettes have been developed to satisfy today's customer needs such as high energy saving, comfort and healthier air.

The drain pipe can be raised to a maximum height of 850mm from the bottom of the ceiling

Do not attempt to raise it higher than 850mm.
Doing so will result in water leakage.

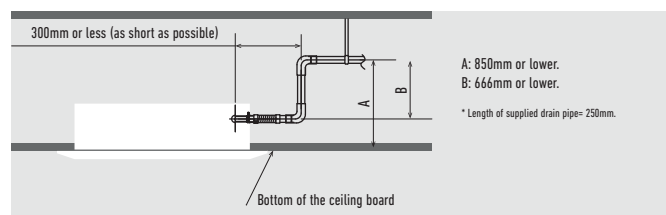

ECONAVI 28%

nanoe X

SELF-DIAGNOSING

AUTOMATIC FAN

HUMIDITY CONTROL MILD DRY

AUTO-FLAP CONTROL

AUTOMATIC RESTART

AIR SWEEP

BUILT-IN DRAIN PUMP

OPTIONAL WLAN

BMS CONNECTIVITY

ECONAVI AND INTERNET CONTROL: Optional.

Y2 Type 4 Way 60x60 Cassette



CZ-KPY3AW
Panel 700 x 700mm.

CZ-KPY3BW
Panel 625 x 625mm.

Designed to fit exactly into a 600 x 600mm ceiling grid without the need to alter the bar configuration

The Y2 is ideal for small commercial and retrofit applications. In addition, the improvements to efficiency make this one of the most advanced units in the industry.

Technical focus

- Mini Cassette fits into a 600 x 600mm ceiling grid
- Fresh air distribution
- Multidirectional airflow
- Powerful drain pump gives 850mm lift
- Turbo fans and heat exchanger fins with improved design
- DC-Fan motors with variable speed, new heat exchangers, etc. ensure an efficient power consumption



PAW-RE2C4
Optional Controller.
Control for hotel application.



CZ-RTCSB
Optional Controller.
Wired remote controller.
Compatible with Econavi.



CZ-CENSC1
Optional Econavi Sensor.



CZ-RWS3
Optional Controller.
Infrared remote controller.



CZ-RE2C2
Optional Controller.
Simplified wired remote controller.

Model		S-15MY2E5A	S-22MY2E5A	S-28MY2E5A	S-36MY2E5A	S-45MY2E5A	S-56MY2E5A
Cooling capacity	kW	1,50	2,20	2,80	3,60	4,50	5,60
Input power cooling	W	35,00	35,00	35,00	40,00	40,00	45,00
Operating current cooling	A	0,30	0,30	0,30	0,30	0,32	0,35
Heating capacity	kW	1,70	2,50	3,20	4,20	5,00	6,30
Input power heating	W	30,00	30,00	30,00	35,00	35,00	40,00
Operating current heating	A	0,25	0,25	0,30	0,30	0,30	0,30
Fan type		Centrifugal fan	Centrifugal fan	Centrifugal fan	Centrifugal fan	Centrifugal fan	Centrifugal fan
Air volume (Hi / Med / Lo)	Cool	m ³ /min 8,90 / 8,20 / 5,60	m ³ /min 9,10 / 8,20 / 5,60	m ³ /min 9,30 / 8,40 / 5,60	m ³ /min 9,70 / 8,70 / 6,00	m ³ /min 10,00 / 9,30 / 8,20	m ³ /min 10,40 / 9,80 / 8,50
	Heat	m ³ /min 9,10 / 8,40 / 5,60	m ³ /min 9,30 / 8,40 / 5,60	m ³ /min 9,60 / 8,70 / 5,60	m ³ /min 9,90 / 9,10 / 6,00	m ³ /min 10,30 / 9,60 / 8,20	m ³ /min 11,10 / 9,80 / 8,70
Sound pressure	Hi / Med / Lo	dB(A) 34 / 31 / 25	dB(A) 35 / 31 / 25	dB(A) 35 / 31 / 25	dB(A) 36 / 32 / 26	dB(A) 38 / 34 / 28	dB(A) 40 / 37 / 34
Sound power	Hi / Med / Lo	dB 49 / 46 / 40	dB 50 / 46 / 40	dB 50 / 46 / 40	dB 51 / 47 / 41	dB 53 / 49 / 43	dB 55 / 52 / 49
Dimension (HxWxD)	Indoor	mm 288 x 583 x 583	mm 288 x 583 x 583	mm 288 x 583 x 583	mm 288 x 583 x 583	mm 288 x 583 x 583	mm 288 x 583 x 583
	Panel 3A	mm 31 x 700 x 700	mm 31 x 700 x 700	mm 31 x 700 x 700	mm 31 x 700 x 700	mm 31 x 700 x 700	mm 31 x 700 x 700
	Panel 3B	mm 31 x 625 x 625	mm 31 x 625 x 625	mm 31 x 625 x 625	mm 31 x 625 x 625	mm 31 x 625 x 625	mm 31 x 625 x 625
Net weight	kg	20,4 (18 + 2,4)	20,4 (18 + 2,4)	20,4 (18 + 2,4)	20,4 (18 + 2,4)	20,4 (18 + 2,4)	20,4 (18 + 2,4)
Piping connections	Liquid pipe	Inch (mm) 1/4 (6,35)	Inch (mm) 1/4 (6,35)	Inch (mm) 1/4 (6,35)	Inch (mm) 1/4 (6,35)	Inch (mm) 1/4 (6,35)	Inch (mm) 1/4 (6,35)
	Gas pipe	Inch (mm) 1/2 (12,70)	Inch (mm) 1/2 (12,70)	Inch (mm) 1/2 (12,70)	Inch (mm) 1/2 (12,70)	Inch (mm) 1/2 (12,70)	Inch (mm) 1/2 (12,70)

A drain height of approximately 850mm from the ceiling surface

The drain height can be increased by approximately 350mm over the conventional value by using a high-lift drain pump, and long horizontal piping is possible.

A lightweight unit at 18,4kg the unit is also very slim with a height of only 288mm, making installation possible even in narrow ceilings.

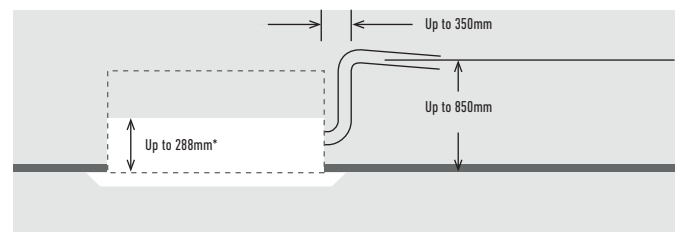

ECONAVI AND INTERNET CONTROL: Optional

L1 Type 2 Way Cassette

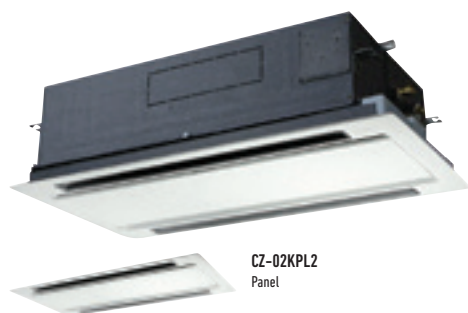

CZ-02KPL2
Panel



CZ-03KPL2
Panel for S-73ML1E5).



PAW-RE2C4
Optional Controller.
Control for hotel application.



CZ-RTC5B
Optional Controller.
Wired remote controller.
Compatible with Econavi.



CZ-RWS3 + CZ-RWRL3
Optional Controller.
Infrared remote controller.



CZ-RE2C2
Optional Controller.
Simplified wired remote controller.

Slim, compact and lightweight units

Remarkable size and weight reductions have been achieved by improvement of the design around the fan, the weight of all models now being 30kg.

Technical focus

- Airflow and distribution is automatically altered depending on the operational mode of the unit
- Drain up is possible up to 500mm from the drain port
- Simple maintenance

Simple maintenance

The drain pan is equipped with site wiring and can be removed. The fan case has a split construction, and the fan motor can be removed easily when the lower case is removed.

Model			S-22ML1E5	S-28ML1E5	S-36ML1E5	S-45ML1E5	S-56ML1E5	S-73ML1E5
Cooling capacity	kW		2,20	2,80	3,60	4,50	5,60	7,30
Input power cooling	W		90,00	92,00	93,00	97,00	97,00	145,00
Operating current cooling	A		0,45	0,45	0,45	0,45	0,45	0,65
Heating capacity	kW		2,50	3,20	4,20	5,00	6,30	8,00
Input power heating	W		58,00	60,00	61,00	65,00	65,00	109,00
Operating current heating	A		0,29	0,29	0,29	0,29	0,29	0,48
Fan type			Sirocco fan	Sirocco fan	Sirocco fan	Sirocco fan	Sirocco fan	Sirocco fan
Air volume	Hi / Med / Lo	m ³ /min	8,00 / 7,00 / 6,00	9,00 / 8,00 / 7,00	9,70 / 8,70 / 7,70	11,00 / 9,00 / 8,00	11,00 / 9,00 / 8,00	19,00 / 16,00 / 14,00
Sound pressure	Hi / Med / Lo	dB(A)	30 / 27 / 24	33 / 29 / 26	34 / 31 / 28	35 / 33 / 29	35 / 33 / 29	38 / 35 / 33
Dimension	Indoor	mm	350 x 840 x 600	350 x 840 x 600	350 x 840 x 600	350 x 840 x 600	350 x 840 x 600	350 x 1140 x 600
	Panel	mm	8 x 1060 x 680	8 x 1060 x 680	8 x 1060 x 680	8 x 1060 x 680	8 x 1060 x 680	8 x 1360 x 680
Net weight (Panel)		kg	23 (5,5)	23 (5,5)	23 (5,5)	23 (5,5)	23 (5,5)	30 (9)
Piping	Liquid pipe	Inch (mm)	1/4 (6,35)	1/4 (6,35)	1/4 (6,35)	1/4 (6,35)	1/4 (6,35)	3/8 (9,52)
connections	Gas pipe	Inch (mm)	1/2 (12,70)	1/2 (12,70)	1/2 (12,70)	1/2 (12,70)	1/2 (12,70)	5/8 (15,88)

Auto flap control

Airflow and distribution is automatically altered depending on the operational mode of the unit.

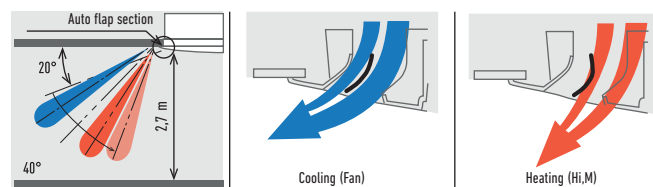

Drain up is possible up to 500mm from the drain port

Maintenance of the drain pump is possible from two sides, from the left side (piping side) and from the inside of the unit.

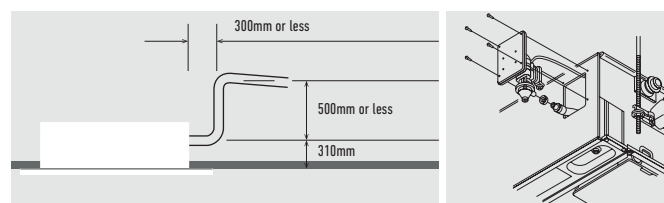

- SELF-DIAGNOSING
- AUTOMATIC FAN
- HUMIDITY CONTROL DRY
- AUTO-FLAP CONTROL
- AUTOMATIC RESTART
- AIR SWEEP
- BUILT-IN DRAIN PUMP
- OPTIONAL WLAN
- BMS CONNECTIVITY
- INTERNET CONTROL: Optional.

D1 Type 1 Way Cassette

Designed for installation within the ceiling void, the D1 range of slimline 1 way blow Cassettes feature powerful yet quiet fans for up to 4,2m.



CZ-KPD2
Panel

Technical focus

- Ultra-Slim
- Suitable for standard and high ceilings
- Built-in drain pump provides 590mm lift
- Easy to install and maintain
- Hanging height can be easily adjusted
- Uses a DC-Fan motor to improve energy-efficiency



PAW-RE2C4
Optional Controller.
Control for hotel application.



CZ-RTCSB
Optional Controller.
Wired remote controller.
Compatible with Econavi.



CZ-RWS3 + CZ-RWRD3
Optional Controller.
Infrared remote controller.



CZ-RE2C2
Optional Controller.
Simplified wired remote controller.

Model		S-28MD1E5	S-36MD1E5	S-45MD1E5	S-56MD1E5	S-73MD1E5
Cooling capacity	kW	2,80	3,60	4,50	5,60	7,30
Input power cooling	W	51,00	51,00	51,00	60,00	87,00
Operating current cooling	A	0,39	0,39	0,39	0,46	0,70
Heating capacity	kW	3,20	4,20	5,00	6,30	8,00
Input power heating	W	40,00	40,00	40,00	48,00	76,00
Operating current heating	A	0,35	0,35	0,35	0,41	0,65
Fan type		Sirocco fan	Sirocco fan	Sirocco fan	Sirocco fan	Sirocco fan
Air volume	Hi / Med / Lo	m ³ /min 12,00 / 10,00 / 9,00	12,00 / 10,00 / 9,00	12,00 / 11,00 / 10,00	13,00 / 11,50 / 10,00	18,00 / 15,00 / 13,00
Sound pressure	Hi / Med / Lo	dB(A) 36 / 34 / 33	36 / 34 / 33	36 / 35 / 34	38 / 36 / 34	45 / 40 / 36
Dimension (HxWxD)	Indoor	mm 200x1000x710	200x1000x710	200x1000x710	200x1000x710	200x1000x710
	Panel	mm 20x1230x800	20x1230x800	20x1230x800	20x1230x800	20x1230x800
Net weight (Panel)		kg 21 (5,5)	21 (5,5)	21 (5,5)	21 (5,5)	22 (5,5)
Piping connections	Liquid pipe	Inch (mm) 1/4 (6,35)	1/4 (6,35)	1/4 (6,35)	1/4 (6,35)	3/8 (9,52)
	Gas pipe	Inch (mm) 1/2 (12,70)	1/2 (12,70)	1/2 (12,70)	1/2 (12,70)	5/8 (15,88)

Drain height

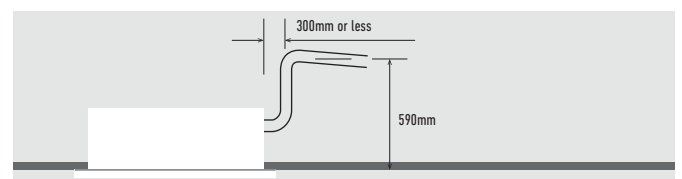

With 3 types of air-blow systems, the units can be used in various ways

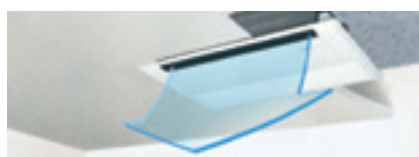

1. One-direction "down-blow" system.
Powerful one-direction "down-blow" system reaches the floor even from high ceilings (up to 4,2m).



2. Two-direction ceiling-mounted system.
"Down-blow" and "front-blow" systems are combined in a ceiling-mounted unit to blow air over a wide area.



3. One-direction ceiling-mounted system.
This powerful ceiling-mounted "front-blow" system efficiently air-conditions the space in front of the unit. (Additional accessories required).

- SELF-DIAGNOSING
- AUTOMATIC FAN
- HUMIDITY CONTROL DRY
- AUTO-FLAP CONTROL
- AUTOMATIC RESTART
- AIR SWEEP
- BUILT-IN DRAIN PUMP
- OPTIONAL WLAN
- BMS CONNECTIVITY
- INTERNET CONTROL: Optional.

F2 Type Variable Static Pressure Hide Away

The F2 type is designed specifically for applications requiring fixed square ducting

The internal filter is equipped as standard.



Technical focus

- Industry-leading low sound levels from 25dB(A)
- Built-in drain pump provides 785mm lift
- Easy to install and maintain
- Air OFF sensor avoids cold air dumping
- Configurable air temperature control

Air inlet Plenum	Dampers diameters	Model
15, 22, 28, 36, 45 & 56	2 x Ø200	CZ-DUMPA56MF2
60, 73 & 90	3 x Ø200	CZ-DUMPA90MF2
106, 140 & 160	4 x Ø200	CZ-DUMPA160MF2



PAW-RE2C4
Optional Controller.
Control for hotel application.



CZ-RTC5B
Optional Controller.
Wired remote controller.
Compatible with Econavi.



CZ-CENSC1
Optional Econavi Sensor.



CZ-RWS3 + CZ-RWRC3
Optional Controller.
Infrared remote controller.



CZ-RE2C2
Optional Controller.
Simplified wired remote controller.

Model		S-15MF2E5A	S-22MF2E5A	S-28MF2E5A	S-36MF2E5A	S-45MF2E5A	S-56MF2E5A	S-60MF2E5A	S-73MF2E5A	S-90MF2E5A	S-106MF2E5A	S-140MF2E5A	S-160MF2E5A
Cooling capacity	kW	1,50	2,20	2,80	3,60	4,50	5,60	6,00	7,30	9,00	10,60	14,00	16,00
Input power cooling	W	70,00	70,00	70,00	70,00	70,00	100,00	120,00	120,00	135,00	195,00	215,00	225,00
Current (cool)	A	0,57	0,57	0,57	0,57	0,57	0,74	0,89	0,89	0,97	1,30	1,44	1,50
Heating capacity	kW	1,70	2,50	3,20	4,20	5,00	6,30	7,10	8,00	10,00	11,40	16,00	18,00
Input power heating	W	70,00	70,00	70,00	70,00	70,00	100,00	120,00	120,00	135,00	200,00	210,00	225,00
Current (heat)	A	0,57	0,57	0,57	0,57	0,57	0,74	0,89	0,89	0,97	1,34	1,42	1,50
Fan type		Sirocco fan	Sirocco fan	Sirocco fan	Sirocco fan	Sirocco fan	Sirocco fan	Sirocco fan	Sirocco fan	Sirocco fan	Sirocco fan	Sirocco fan	Sirocco fan
Air volume ¹	Hi / Med / Lo m ³ /min	14,00/13,00/ 9,00	14,00/13,00/ 9,00	14,00/13,00/ 9,00	14,00/13,00/ 9,00	14,00/13,00/ 10,00	16,00/15,00/ 12,00	21,00/19,00/ 15,00	21,00/19,00/ 15,00	25,00/23,00/ 19,00	32,00/26,00/ 21,00	34,00/29,00/ 23,00	36,00/32,00/ 25,00
External static pressure	Pa	70(10-150)	70(10-150)	70(10-150)	70(10-150)	70(10-150)	70(10-150)	70(10-150)	70(10-150)	70(10-150)	100(10-150)	100(10-150)	100(10-150)
Sound pressure / power	Hi / Med / Lo dB(A) / dB	33 / 29 / 22 55 / 51 / 44	33 / 29 / 22 55 / 51 / 44	33 / 29 / 22 55 / 51 / 44	33 / 29 / 22 55 / 51 / 44	34 / 32 / 25 56 / 54 / 47	34 / 32 / 25 56 / 54 / 47	35 / 32 / 26 57 / 54 / 48	35 / 32 / 26 57 / 54 / 48	37 / 34 / 28 59 / 56 / 50	38 / 34 / 31 60 / 56 / 53	39 / 35 / 32 61 / 57 / 54	40 / 36 / 33 62 / 58 / 55
Dimension / Net weight	H x W x D mm / kg	290 x 800 x 700 / 29	290 x 800 x 700 / 29	290 x 800 x 700 / 29	290 x 800 x 700 / 29	290 x 800 x 700 / 29	290 x 800 x 700 / 29	290 x 1000 x 700 / 34	290 x 1000 x 700 / 34	290 x 1000 x 700 / 34	290 x 1400 x 700 / 46	290 x 1400 x 700 / 46	290 x 1400 x 700 / 46
Piping connections	Liquid Inch (mm)	1/4 (6,35)	1/4 (6,35)	1/4 (6,35)	1/4 (6,35)	1/4 (6,35)	1/4 (6,35)	3/8 (9,52)	3/8 (9,52)	3/8 (9,52)	3/8 (9,52)	3/8 (9,52)	3/8 (9,52)
	Gas Inch (mm)	1/2 (12,70)	1/2 (12,70)	1/2 (12,70)	1/2 (12,70)	1/2 (12,70)	1/2 (12,70)	5/8 (15,88)	5/8 (15,88)	5/8 (15,88)	5/8 (15,88)	5/8 (15,88)	5/8 (15,88)

1) Value referred to standard settings at shipment (H curve 8, M curve 5, L curve 1).

More powerful drain pump

Using a high-lift drain pump, drain piping can be elevated up to 785mm from the base of the unit.

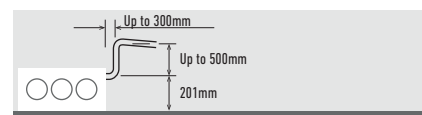

F2 Advantages

Automatic learning function for the required static pressure, to be activated easily by the standard wired timer remote controller.

Possible to increase the sensible cooling capacity by adjusting the air volume flow in order to almost completely eliminate latent losses. This is possible due to the outstanding big heat exchanger surface in combination with increasing the air volume flow by a manual selection of higher fan speed curves through the standard wired remote controller when commissioning the system together with the default active off-coil temperature control and the room load based variable evaporation temperature control.

Diagram 1 S-22MF2E5A

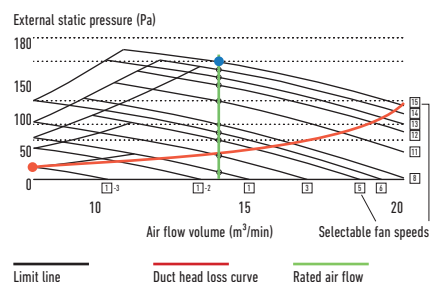

ECONAVI 28%

FILTER INCLUDED

SELF-DIAGNOSING

AUTOMATIC FAN

HUMIDITY CONTROL DRY

AUTOMATIC RESTART

BUILT-IN DRAIN PUMP

OPTIONAL WLAN

BMS CONNECTIVITY

ECONAVI and INTERNET CONTROL: Optional.

M1 Type Slim Variable Static Pressure Hide Away Concealed Duct

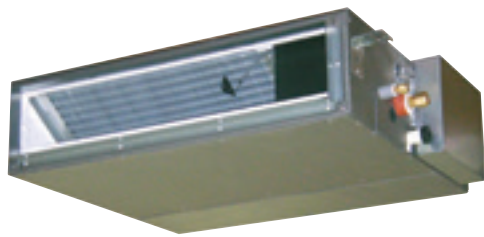

The ultra slim M1 type is one of the leading products of its type in the industry

With a depth of only 200mm it provides greater flexibility and can be used in far more applications. In addition, its high-efficiency and extremely quiet sound levels make it very popular with many users, including hotels and small offices.

Technical focus

- Ultra-slim profile: 200mm for all models
- DC-Fan motor greatly reduces power consumption
- Ideal for hotel application with very narrow false ceilings
- Easy maintenance and service by external electrical box
- 40Pa static pressure enables ductwork to be fitted.
- Includes drain pump



PAW-RE2C4
Optional Controller.
Control for hotel application.



CZ-RTCSB
Optional Controller.
Wired remote controller.
Compatible with Econavi.



CZ-CENSC1
Optional Econavi Sensor.



CZ-RWS3 + CZ-RWRC3
Optional Controller.
Infrared remote controller.



CZ-RE2C2
Optional Controller.
Simplified wired remote controller.

Model		S-15MM1E5A	S-22MM1E5A	S-28MM1E5A	S-36MM1E5A	S-45MM1E5A	S-56MM1E5A	
Cooling capacity	kW	1,50	2,20	2,80	3,60	4,50	5,60	
Input power cooling	W	36,00	36,00	40,00	42,00	49,00	64,00	
Operating current cooling	A	0,26	0,26	0,30	0,31	0,37	0,48	
Heating capacity	kW	1,70	2,50	3,20	4,20	5,00	6,30	
Input power heating	W	26,00	26,00	30,00	32,00	39,00	54,00	
Operating current heating	A	0,23	0,23	0,27	0,28	0,34	0,45	
Fan type		Sirocco fan	Sirocco fan	Sirocco fan	Sirocco fan	Sirocco fan	Sirocco fan	
Air volume	Hi / Med / Lo	m ³ /min	8,00 / 7,00 / 6,00	8,00 / 7,00 / 6,00	8,50 / 7,50 / 6,50	9,00 / 8,00 / 7,00	10,50 / 9,50 / 8,00	12,50 / 11,50 / 10,00
External static pressure	Pa	10 (30)	10 (30)	15 (30)	15 (40)	15 (40)	15 (40)	
Sound pressure	Hi / Med / Lo ¹	dB(A)	28 / 27 / 25 (30 / 29 / 27)	28 / 27 / 25 (30 / 29 / 27)	30 / 29 / 27 (32 / 31 / 29)	32 / 30 / 28 (34 / 32 / 30)	34 / 32 / 30 (36 / 34 / 32)	35 / 33 / 31 (37 / 35 / 32)
Sound power	Hi / Med / Lo	dB	43 / 42 / 40	43 / 42 / 40	45 / 44 / 42	47 / 45 / 43	49 / 47 / 45	50 / 48 / 46
Dimension	HxWxD	mm	200 x 750 x 640	200 x 750 x 640	200 x 750 x 640	200 x 750 x 640	200 x 750 x 640	
Net weight		kg	19	19	19	19	19	
Piping connections	Liquid pipe	Inch (mm)	1/4 (6,35)	1/4 (6,35)	1/4 (6,35)	1/4 (6,35)	1/4 (6,35)	
	Gas pipe	Inch (mm)	1/2 (12,70)	1/2 (12,70)	1/2 (12,70)	1/2 (12,70)	1/2 (12,70)	

1) By DIP switches or by RC setting.

Air Outlet & Inlet Plenum

S-...MM1E5A	Diameters	Air Outlet Plenum	Diameters	Air Inlet Plenum
22, 28 & 36	2 x Ø200	CZ-DUMPA22MMS2	2 x Ø200	CZ-DUMPA22MMR2
45 & 56	3 x Ø160	CZ-DUMPA45MMS3	2 x Ø200	CZ-DUMPA22MMR3

Ultra-slim profile for all models

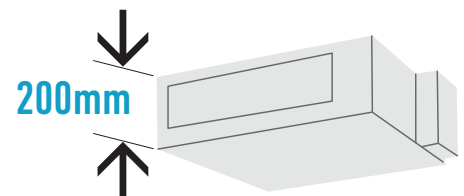

Drain pump with increased power!

By adoption of a high-lift drain pump, the drain piping rise height can be increased to 785mm from the lower surface of the body.

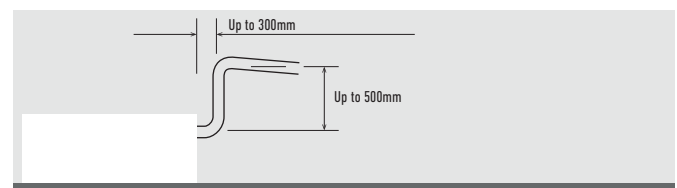

ECONAVI and INTERNET CONTROL: Optional.

E2 Type High Static Pressure Hide Away



High pressure duct and 100% Fresh air duct function. The E2 range of ducted units offers improved design flexibility for extended duct layouts as a result of their increased external static pressures and reduces energy consumption.

Technical focus

- No need of rap valve
- 100% Fresh air duct function
- DC-Fan motor for more savings
- Complete flexibility for ductwork design
- Can be located into a weatherproof housing for external sitting
- Air OFF sensor avoids cold air dumping
- Configurable air temperature control



PAW-RE2C4
Optional Controller.
Control for hotel application.



CZ-RTC5B
Optional Controller.
Wired remote controller.
Compatible with Econavi.



CZ-RWS3 + CZ-RWRC3
Optional Controller.
Infrared remote controller.



CZ-RE2C2
Optional Controller.
Simplified wired remote controller.

Model	100% Fresh air duct function (by using Kit for 100% Fresh air)				High pressure duct				
	S-224ME2E5		S-280ME2E5		S-224ME2E5		S-280ME2E5		
	Cooling	Heating	Cooling	Heating	Cooling	Heating	Cooling	Heating	
Capacity	kW	22,40	21,20	28,00	26,50	22,40	25,00	28,00	31,50
Input power	W	290,00	290,00	350,00	350,00	440,00	440,00	715,00	715,00
Operating current	A	1,85	1,85	2,20	2,20	2,45	2,45	3,95	3,95
Air volume	Hi / Med / Lo	m ³ /min		35,00 / — / —		56,00 / 51,00 / 44,00		72,00 / 63,00 / 53,00	
External static pressure	Pa	200		200		140(60-270) ¹		140(72-270) ¹	
Sound pressure ²	Hi / Med / Lo	dB(A)		44 / — / —		45 / 43 / 41		49 / 47 / 43	
Sound power	Hi / Med / Lo	dB		75 / — / —		77 / 75 / 73		81 / 79 / 75	
Dimension	HxWxD	mm		479 x 1453 x 1205		479 x 1453 x 1205		479 x 1453 x 1205	
Net weight	kg	102		106		102		106	
Piping connections	Liquid pipe	Inch (mm)		3/8 (9,52)		3/8 (9,52)		3/8 (9,52)	
	Gas pipe	Inch (mm)		7/8 (22,22)		3/4 (19,05)		7/8 (22,22)	

Rating Conditions for 100% Fresh air duct function: Cooling Outdoor 33°C DB / 28°C WB. Heating Outdoor 0°C DB / -2.9°C WB. 1) Available to select the setting by initial setup. 2) Values with 140Pa setting. * No filter included. No compatible with 3-Pipe ECO G GF3.

System example

An inspection port (450 x 450mm or more) is required at the lower side of the indoor unit body (field supply).

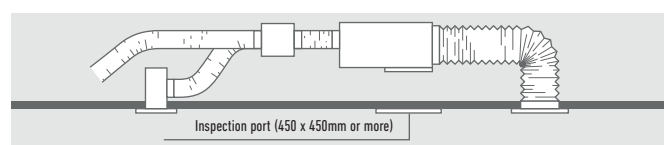

100% Fresh air duct function

The E2 duct with 100% fresh air duct function have exceptional discharge temperature.

	Discharge Range		
	Min	Max	Default
Cooling	15°C	24°C	18°C
Heating	17°C	45°C	40°C

Plenums

Air Outlet Plenum (suitable for rigid + flexible duct)

	Number of exits with diameters	Model
S-224ME1E5A / S-280ME1E5	1 x 500mm	CZ-TREMIESPW706

Kit for 100% Fresh air function

For 2-Pipe systems		For 3-Pipe systems	
2x CZ-P160RVK2	Rap valve kit	2x CZ-P160HR3	3-Pipe valve kit
2x CZ-CAPE2	3-Pipe control PCB	2x CZ-CAPE2	3-Pipe control PCB
CZ-P680BK2	Distribution Joint kit	CZ-P680BH2	Distribution Joint kit
1x Remote control		1x Remote control	



ECONAVI and INTERNET CONTROL: Optional.

Heat Recovery With DX Coil



PAW-RE2C4
Optional Controller.
Control for hotel
application.



CZ-RTCSB
Optional Controller.
Wired remote controller.
Compatible with Econavi.

Motorised heat recovery by-pass device automatically controlled by unit control to use fresh air free-cooling when convenient.

- Galvanized steel self-supporting panels, internally and externally insulated
- High efficiency enthalpic heat recover, static cross flow type, made by membrane with high moisture permeability, good air tightness, excellent tear resistance, and aging resistance, it is structures with flat plates and corrugated plates. Total heat exchange with temperature efficiency up to 76% and enthalpy efficiency up to 67%, also at high level during summer season
- ISO16890 ePm_{2,5} 95% (F9 EN 779) efficiency class filter with synthetic cleanable media and COARSE 50% (G3 EN 779) pre-filter ON fresh air, COARSE 50% filter on return air intake
- Removable side panel to access filters and heat recovery in the event of scheduled maintenance
- Low consumption, high efficiency & low noise direct driven fans
- Supply section complete with DX Coil (R410A) fitted with solenoid control valve, freon filter, contact temperature sensors on liquid and gas line, NTC sensors upstream and downstream airflow
- Built-in electric box equipped with PCB to control internal fan speed and to interconnect outdoor/indoor units
- Duct connection by circular plastic collars

Model	PAW-500ZDX3N		PAW-800ZDX3N		PAW-01KZDX3N		
Power source	Voltage	V	230		230		
	Phase		Single Phase		Single Phase		
	Frequency	Hz	50		50		
Air volume		m ³ /min	8,33	13,33	16,66		
External static pressure ¹		Pa	90	120	115		
Maximum current	Total full load	A	0,6	1,4	2,1		
Input power		W	150	320	390		
Sound pressure ²		dB(A)	39	42	43		
Piping connections	Liquid pipe	Inch (mm)	1/4 (6,35)		1/4 (6,35)		
	Gas pipe	Inch (mm)	1/2 (12,70)		1/2 (12,70)		
Heat recovery			Cooling	Heating	Cooling	Heating	
	Temperature efficiency	%	76	76	76	76	
	Enthalpy efficiency	%	63	67	63	62	
	Saved power summer mode or winter mode*	kW	1,70	4,30 (4,80)	2,50	6,50 (7,30)	3,20
DX Coil							
Total / Sensible capacity		kW	3,00 / 2,10	2,50 / 2,70	5,10 / 3,50	4,40 / 4,80	5,80 / 4,10
Off temperature		°C	15,9	28,0 (27,3)	15,5	29,6 (29,0)	16,2
Off relative humidity		%	90	16 (15)	90	14 (13)	89

Nominal summer conditions: Outside air: 32°C DB, RH 50%. Ambient air: 26°C DB, RH 50%. Nominal winter conditions: Outside air: -5°C DB, RH 80%. Ambient air: 20°C DB, RH 50%. Cooling mode air inlet condition: 28.5°C DB, RH 50%; evaporating temperature 7°C. Heating mode air inlet condition: 13°C DB, RH 40% (11°C DB, RH 45%); condensating temperature 40°C. DB: Dry Bulb; RH: Relative Humidity.

1) Referred to the nominal air flow after filter and plate heat exchanger. 2) Sound pressure level calculated at 1m far from: ducted supply exhaust air ducted return - first air intake / service side, at normal condition. * Tentative data.

Balanced ventilation

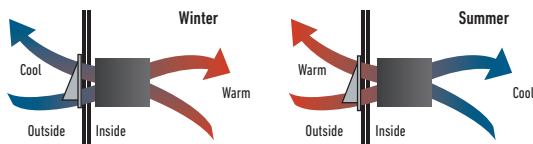

Interconnection to outdoor/indoor units

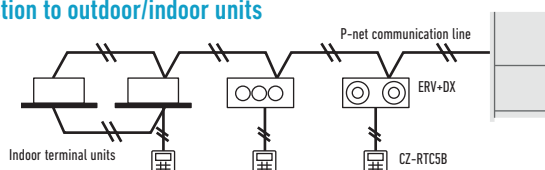

Characteristic curves

The following curves show the unit external static pressure at maximum fan speed for each model.

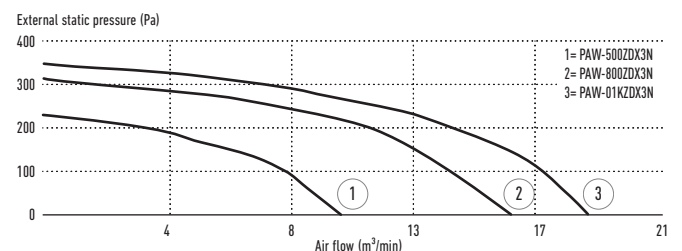

INTERNET CONTROL: Optional.

T2 Type Ceiling



The T2 Type Ceiling mounted units feature a DC-Fan motor for increased efficiency and reduced operating sound levels

All the units are the same height and depth for a uniform appearance in mixed installations and feature a fresh air knockout for improved air quality.

Technical focus

- Low sound levels
- New design, all units just 235mm high
- Large and wide air distribution
- Easy to install and maintain
- Fresh air knockout



PAW-RE2C4
Optional Controller.
Control for hotel application.



CZ-RTCSB
Optional Controller.
Wired remote controller.
Compatible with Econavi.



CZ-CENSC1
Optional Econavi Sensor.



CZ-RWS3 + CZ-RWRT3
Optional Controller.
Infrared remote controller.



CZ-RE2C2
Optional Controller.
Simplified wired remote controller.

Model		S-36MT2E5A	S-45MT2E5A	S-56MT2E5A	S-73MT2E5A	S-106MT2E5A	S-140MT2E5A	
Cooling capacity	kW	3,60	4,50	5,60	7,30	10,60	14,00	
Input power cooling	W	35,00	40,00	40,00	55,00	80,00	100,00	
Operating current cooling	A	0,36	0,38	0,38	0,44	0,67	0,79	
Heating capacity	kW	4,20	5,00	6,30	8,00	11,40	16,00	
Input power heating	W	35,00	40,00	40,00	55,00	80,00	100,00	
Operating current heating	A	0,36	0,38	0,38	0,44	0,67	0,79	
Fan type		Sirocco fan	Sirocco fan	Sirocco fan	Sirocco fan	Sirocco fan	Sirocco fan	
Air volume	Hi / Med / Lo	m ³ /min	14,00 / 12,00 / 10,50	15,00 / 12,50 / 10,50	15,00 / 12,50 / 10,50	21,00 / 18,00 / 15,50	30,00 / 25,00 / 23,00	32,00 / 28,00 / 24,00
Sound pressure	Hi / Med / Lo	dB(A)	36 / 32 / 30	37 / 33 / 30	37 / 33 / 30	39 / 35 / 33	42 / 37 / 36	46 / 40 / 37
Sound power	Hi / Med / Lo	dB	54 / 50 / 48	55 / 51 / 48	55 / 51 / 48	57 / 53 / 51	60 / 55 / 54	62 / 58 / 55
Dimension	H x W x D	mm	235 x 960 x 690	235 x 960 x 690	235 x 960 x 690	235 x 1275 x 690	235 x 1590 x 690	235 x 1590 x 690
Net weight		kg	27	27	27	33	40	40
Piping connections	Liquid pipe	Inch (mm)	1/4 (6,35)	1/4 (6,35)	1/4 (6,35)	3/8 (9,52)	3/8 (9,52)	3/8 (9,52)
	Gas pipe	Inch (mm)	1/2 (12,70)	1/2 (12,70)	1/2 (12,70)	5/8 (15,88)	5/8 (15,88)	5/8 (15,88)

Air distribution is altered depending on the operational mode

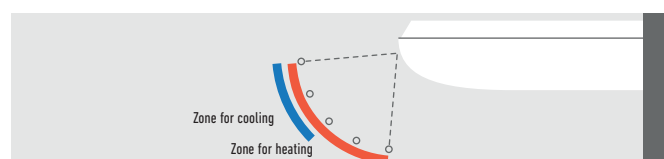

Further comfort improvement with airflow distribution

Horizontal air flow reaches maximum 9,5m. This is ideal for wide rooms. The wide air discharge opening expands the air flow to the left and the right. The unpleasant feeling caused when the air flow directly hits the human body is prevented by the "Draft prevention position", which changes the swing width, so that the degree of comfort is increased.

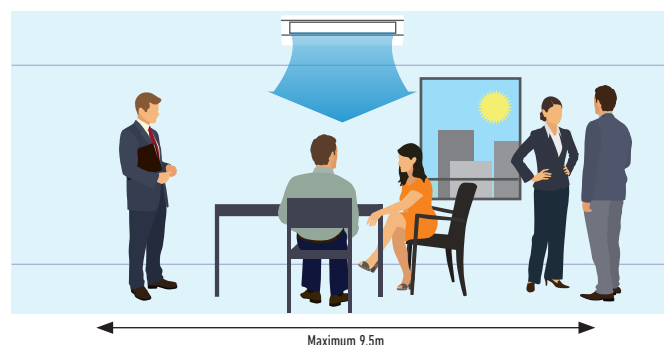

ECONAVI

SELF-DIAGNOSING

AUTOMATIC FAN

HUMIDITY CONTROL DRY

AUTO-FLAP CONTROL

AUTOMATIC RESTART

AIR SWEEP

OPTIONAL WLAN

BMS CONNECTIVITY

ECONAVI and INTERNET CONTROL: Optional.

NEW VRF FLOOR CONSOLE

1 Stylish and simple

- Clean and modern European design with slim depth
- Modern matt white color panel
- Washable air filter

The stylish and compact unit profile, also used for residential market range, is easy to integrate into any design of building.

High end residential.



Dimension:
W x H x D = 750 x 600 x 207mm

Weight:
14kg

Cafe / Restaurant.



2 Flexible easy installation

Four different mounting styles possible:

- Exposed (floor or wall)
- Semi-recessed
- Recessed

Flexible installation with 4 different options.

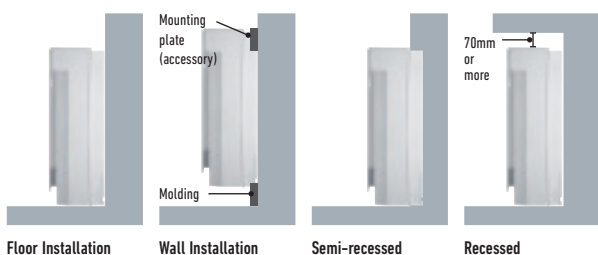

The compact unit can be installed within a limited space, such as under a window. Thus, it is a perfect solution to replace an existing boiler system radiator.



3 Functions for comfort

- Double Air Flow direction to maximize comfort
- Self-cleaning function
- Compatible with New Commercial WLAN Adaptor for cloud control

Self-cleaning function.

- Self cleaning function can be pre-scheduled with remote controller, up to a maximum of 90 minutes following cooling/dry operation
- Air flow will not blow directly at occupants during self-cleaning

Double Air Flow direction.

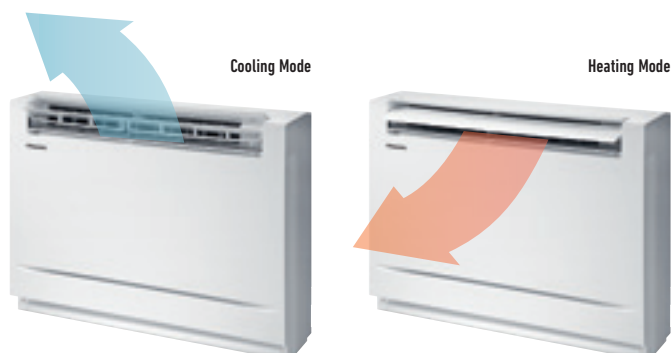

New G1 Type Floor Console



NEW
2019

The stylish and compact unit profile, also used for residential market range, is easy to integrate into any design of building

Compact and versatile, this system is capable of being installed in an area with limited space. It is a perfect solution for retrofit, replacing existing radiator panels.

Technical focus

- Clean and stylish design with slim depth
- Modern matt white color panel
- Flexible and easy installation
- Washable air filter
- Quiet operation
- Dry mode to reduce humidity in rooms
- New Cloud Control "Comfort Cloud" compatible



PAW-RE2C4
Optional Controller.
Control for hotel application.



CZ-RTC5B
Optional Controller.
Wired remote controller.
Compatible with Econavi.



CZ-CENSC1
Optional Econavi Sensor.



CZ-RWS3
Optional Controller.
Infrared remote controller.

Model		S-22MG1E5A	S-28MG1E5A	S-36MG1E5A	S-45MG1E5A	S-56MG1E5A	
Cooling capacity	kW	2,20	2,80	3,60	4,50	5,60	
Input power cooling	W	18,00	18,00	20,00	26,00	29,00	
Operating current cooling	A	0,18	0,18	0,21	0,23	0,25	
Heating capacity	kW	2,50	3,20	4,20	5,00	6,30	
Input power heating	W	19,00	19,00	21,00	27,00	30,00	
Operating current heating	A	0,18	0,18	0,22	0,24	0,26	
Fan type		Cross flow	Cross flow	Cross flow	Cross flow	Cross flow	
Air volume	Cool (Hi / Med / Lo)	m ³ /min	9,20 / 7,50 / 6,00	9,20 / 7,50 / 6,00	9,70 / 8,20 / 6,00	10,50 / 9,00 / 6,50	12,00 / 9,50 / 6,50
	Heat (Hi / Med / Lo)	m ³ /min	9,70 / 8,00 / 6,50	9,70 / 8,00 / 6,50	10,20 / 8,70 / 6,50	11,00 / 9,50 / 7,00	12,50 / 10,00 / 7,00
Sound pressure	Hi / Med / Lo	dB(A)	38 / 34 / 29	38 / 34 / 29	39 / 35 / 29	42 / 37 / 30	44 / 38 / 30
Dimension	H x W x D	mm	600 x 750 x 207	600 x 750 x 207	600 x 750 x 207	600 x 750 x 207	600 x 750 x 207
Net weight		kg	14	14	14	14	14
Piping connections	Liquid pipe	Inch (mm)	1/4 (6,35)	1/4 (6,35)	1/4 (6,35)	1/4 (6,35)	1/4 (6,35)
	Gas pipe	Inch (mm)	1/2 (12,70)	1/2 (12,70)	1/2 (12,70)	1/2 (12,70)	1/2 (12,70)

* Infrared remote controller (CZ-RWS3) doesn't need receiver as an optional. Receiver is included in the unit shipment.

Simple operation design for easy to use



Washable air filter

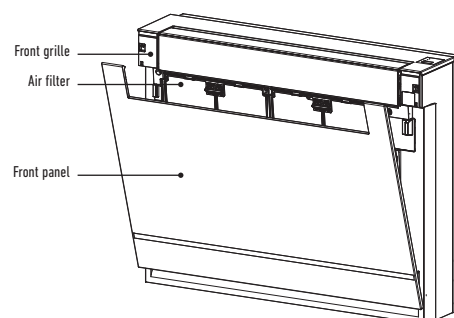

ECONAVI and INTERNET CONTROL: Optional.

K2 Type Wall Mounted



The Wall mounted unit has a stylish smooth panel that looks good and easy to clean

The unit is also smaller, lighter and substantially quieter than previous models making it ideal for small offices and other commercial applications.

Technical focus

- Closed discharge port
- Lighter and smaller units make the installation easy
- Quiet operation
- Smooth and durable design
- Piping outlet in three directions
- Air distribution is automatically altered depending on the operational mode



PAW-RE2C4
Optional Controller.
Control for hotel application.



CZ-RTCSB
Optional Controller.
Wired remote controller.
Compatible with Econavi.



CZ-CENSC1
Optional Econavi Sensor.



CZ-RWS3
Optional Controller.
Infrared remote controller.



CZ-RE2C2
Optional Controller.
Simplified wired remote controller.

Model		S-15MK2E5A	S-22MK2E5A	S-28MK2E5A	S-36MK2E5A	S-45MK2E5A	S-56MK2E5A	S-73MK2E5A	S-106MK2E5A	
Cooling capacity	kW	1,50	2,20	2,80	3,60	4,50	5,60	7,30	10,60	
Input power cooling	W	25,00	25,00	25,00	30,00	30,00	35,00	55,00	80,00	
Operating current cooling	A	0,20	0,21	0,23	0,25	0,32	0,35	0,51	0,70	
Heating capacity	kW	1,70	2,50	3,20	4,20	5,00	6,30	8,00	11,40	
Input power heating	W	25,00	25,00	25,00	30,00	30,00	35,00	55,00	80,00	
Operating current heating	A	0,20	0,21	0,23	0,25	0,32	0,35	0,51	0,70	
Fan type		Cross flow	Cross flow	Cross flow	Cross flow	Cross flow	Cross flow	Cross flow	Cross flow	
Air volume	Cool	m ³ /min	7,90 / 7,40 / 6,50	9,00 / 7,50 / 6,50	9,50 / 8,30 / 6,50	10,90 / 9,00 / 6,50	14,50 / 12,50 / 10,00	16,00 / 14,00 / 12,00	19,50 / 17,00 / 14,00	21,50 / 18,50 / 15,00
	Hi / Med / Lo									
	Heat	m ³ /min	9,00 / 7,70 / 6,80	9,20 / 8,30 / 6,80	9,70 / 8,50 / 6,80	11,20 / 9,50 / 6,80	14,50 / 12,50 / 10,00	16,00 / 14,00 / 12,00	19,50 / 17,00 / 14,00	21,50 / 18,50 / 15,00
	Hi / Med / Lo									
Sound pressure	Hi / Med / Lo	dB(A)	34 / 32 / 29	36 / 33 / 29	37 / 34 / 29	40 / 36 / 29	38 / 35 / 33	40 / 37 / 35	47 / 44 / 40	49 / 46 / 42
Sound power	Hi / Med / Lo	dB	49 / 47 / 44	51 / 48 / 44	52 / 49 / 44	55 / 51 / 44	53 / 50 / 48	55 / 52 / 50	62 / 59 / 55	64 / 61 / 57
Dimension	H x W x D	mm	290 x 870 x 214	290 x 870 x 214	290 x 870 x 214	290 x 870 x 214	302 x 1120 x 236	302 x 1120 x 236	302 x 1120 x 236	302 x 1120 x 236
Net weight		kg	9	9	9	9	13	13	14	14
Piping connections	Liquid pipe	Inch (mm)	1/4 (6,35)	1/4 (6,35)	1/4 (6,35)	1/4 (6,35)	1/4 (6,35)	1/4 (6,35)	3/8 (9,52)	3/8 (9,52)
	Gas pipe	Inch (mm)	1/2 (12,70)	1/2 (12,70)	1/2 (12,70)	1/2 (12,70)	1/2 (12,70)	1/2 (12,70)	5/8 (15,88)	5/8 (15,88)

Closed discharge port

When the unit is turned OFF, the flap closes completely to prevent entry of dust into the unit and to keep the equipment clean. Lighter and smaller units make the installation easy. The width has been decreased by 17% and the units are lighter.

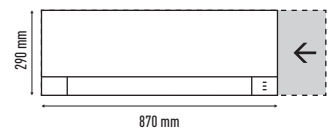

Air distribution is automatically altered depending on the operational mode of the unit

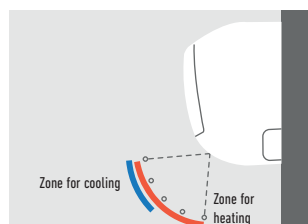

Piping outlet in six directions

Piping outlet is possible in the six directions of right, right rear, right bottom, left, left rear and left bottom, making the installation work easier.

Quiet operation

These units are among the quietest in the industry, making them ideal for hotels and hospitals.

External valve (Optional)

CZ-P56SVK2 (model sizes 15 to 56)
CZ-P160SVK2 (model sizes 73 to 106)



ECONAVI and INTERNET CONTROL: Optional.

P1 Type Floor Standing



The compact Floor Standing P1 units are the ideal solution for providing perimeter air conditioning

The standard wired controller can be incorporated into the body of the unit.

Technical focus

- Pipes can be connected to either side of the unit from the bottom or rear
- Easy to install
- Front panel opens fully for easy maintenance
- Removable air discharge grille gives flexible airflow
- Room for condensate pump
- For build-in remote control, only CZ-RTC2 is suitable



PAW-RE2C4
Optional Controller.
Control for hotel application.



CZ-RTC5B
Optional Controller.
Wired remote controller.
Compatible with Econavi.



CZ-RTC2
Optional Controller.
Timer remote controller.
For Floor Standing (P1) indoor units.



CZ-RWS3 + CZ-RWRC3
Optional Controller.
Infrared remote controller.



CZ-RE2C2
Optional Controller.
Simplified wired remote controller.

Model		S-22MP1E5	S-28MP1E5	S-36MP1E5	S-45MP1E5	S-56MP1E5	S-71MP1E5	
Cooling capacity	kW	2,20	2,80	3,60	4,50	5,60	7,10	
Input power cooling	W	56,00	56,00	85,00	126,00	126,00	160,00	
Operating current cooling	A	0,25	0,25	0,38	0,56	0,56	0,72	
Heating capacity	kW	2,50	3,20	4,20	5,00	6,30	8,00	
Input power heating	W	40,00	40,00	70,00	91,00	91,00	120,00	
Operating current heating	A	0,18	0,18	0,31	0,41	0,41	0,54	
Fan type		Sirocco fan	Sirocco fan	Sirocco fan	Sirocco fan	Sirocco fan	Sirocco fan	
Air volume	Hi / Med / Lo	m ³ /min	7,00 / 6,00 / 5,00	7,00 / 6,00 / 5,00	9,00 / 7,00 / 6,00	12,00 / 9,00 / 8,00	15,00 / 13,00 / 11,00	17,00 / 14,00 / 12,00
External static pressure	Pa	15	15	15	15	15	15	
Sound pressure	Hi / Med / Lo	dB(A)	33 / 30 / 28	33 / 30 / 28	39 / 35 / 29	38 / 35 / 31	39 / 36 / 31	41 / 38 / 35
Dimensions	H x W x D	mm	615 x 1065 x 230	615 x 1065 x 230	615 x 1065 x 230	615 x 1380 x 230	615 x 1380 x 230	615 x 1380 x 230
Net weight	kg	29	29	29	39	39	39	
Piping connections	Liquid pipe	Inch (mm)	1/4 (6,35)	1/4 (6,35)	1/4 (6,35)	1/4 (6,35)	3/8 (9,52)	
	Gas pipe	Inch (mm)	1/2 (12,70)	1/2 (12,70)	1/2 (12,70)	1/2 (12,70)	5/8 (15,88)	

Effective perimeter handling

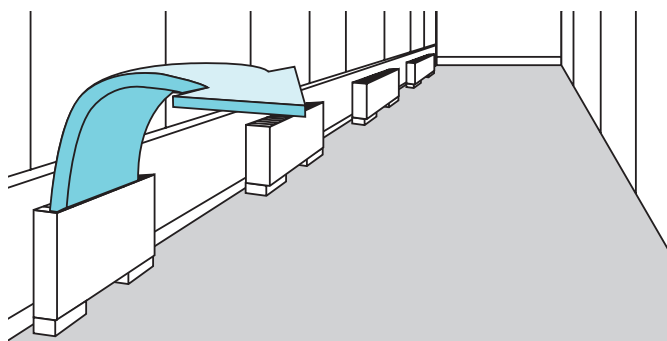

Effective perimeter handling



INTERNET CONTROL: Optional.

R1 Type Concealed Floor Standing

At just 229mm deep, the R1 unit can be easily concealed in perimeter areas to provide powerful and effective air conditioning

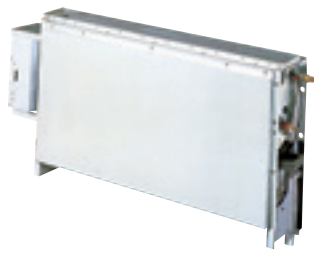

Technical focus

- Chassis unit for discreet installation
- Complete with removable filters
- Pipes can be connected to either side of the unit from the bottom or rear
- Easy to install



PAW-RE2C4
Optional Controller.
Control for hotel application.



CZ-RTCSB
Optional Controller.
Wired remote controller.
Compatible with Econavi.



CZ-RWS3 + CZ-RWRC3
Optional Controller.
Infrared remote controller.



CZ-RE2C2
Optional Controller.
Simplified wired remote controller.

Model		S-22MR1E5	S-28MR1E5	S-36MR1E5	S-45MR1E5	S-56MR1E5	S-71MR1E5	
Cooling capacity	kW	2,20	2,80	3,60	4,50	5,60	7,10	
Input power cooling	W	56,00	56,00	85,00	126,00	126,00	160,00	
Operating current cooling	A	0,25	0,25	0,38	0,56	0,56	0,72	
Heating capacity	kW	2,50	3,20	4,20	5,00	6,30	8,00	
Input power heating	W	40,00	40,00	70,00	91,00	91,00	120,00	
Operating current heating	A	0,18	0,18	0,31	0,41	0,41	0,54	
Fan type		Sirocco fan	Sirocco fan	Sirocco fan	Sirocco fan	Sirocco fan	Sirocco fan	
Air volume	Hi / Med / Lo	m ³ /min	7,00 / 6,00 / 5,00	7,00 / 6,00 / 5,00	9,00 / 7,00 / 6,00	12,00 / 9,00 / 8,00	15,00 / 13,00 / 11,00	17,00 / 14,00 / 12,00
External static pressure	Pa	15	15	15	15	15	15	
Sound pressure	Hi / Med / Lo	dB(A)	33 / 30 / 28	33 / 30 / 28	39 / 35 / 29	38 / 35 / 31	39 / 36 / 31	41 / 38 / 35
Dimensions	HxWxD	mm	616 x 904 x 229	616 x 904 x 229	616 x 904 x 229	616 x 1219 x 229	616 x 1219 x 229	616 x 1219 x 229
Net weight	kg	21	21	21	28	28	28	
Piping connections	Liquid pipe	Inch (mm)	1/4 (6,35)	1/4 (6,35)	1/4 (6,35)	1/4 (6,35)	3/8 (9,52)	
	Gas pipe	Inch (mm)	1/2 (12,70)	1/2 (12,70)	1/2 (12,70)	1/2 (12,70)	5/8 (15,88)	

Perimeter air conditioning with high interior quality

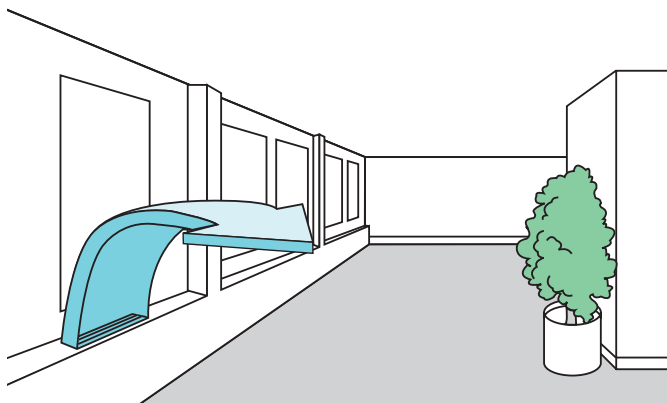

SELF-DIAGNOSING
 AUTOMATIC FAN
 HUMIDITY CONTROL DRY
 AUTOMATIC RESTART
 OPTIONAL WLAN
 BMS CONNECTIVITY
 INTERNET CONTROL: Optional.

Hydrokit for ECOi Water at 45°C



CZ-RTC5B
Optional Controller.
Wired remote controller.
Compatible with Econavi.

Connect the Hydrokit to your VRF system, together with other indoor units

Basic principle & advantage.

Hydrokit module provides hot water by using waste heat that is recovered from standard air-conditioning indoor unit in cooling mode. Total system performs high energy efficiency by this heat recovering operation, and it gives an advantage for sustainability related assessment methods, such as BREEAM in UK.

Technical focus

- Only with 3-Pipe ECOi EX MF3 Series outdoor units
- Remote controller CZ-RTC5B common use with DX Coil indoor units ECOi and PACi

Model	S-80MW1E5		S-125MW1E5	
Power source	230V / Single Phase / 50 Hz		230V / Single Phase / 50 Hz	
Cooling capacity	kW	8,00	kW	12,50
Heating capacity	kW	9,00	kW	14,00
Maximum temperature	°C	~45 / ~65 ¹	°C	~45 / ~65 ¹
Dimension	H x W x D	mm	892 x 502 x 353	892 x 502 x 353
Water pipe connector		Inch	R 1 ¼	R 1 ¼
Water pump (built-in)			DC motor (A class)	DC motor (A class)
Water flow rate	Cool	L/min	22,90	35,80
	Heat	L/min	25,80	40,10
Piping connections	Liquid pipe	Inch (mm)	3/8 (9,52)	3/8 (9,52)
	Gas pipe	Inch (mm)	5/8 (15,88)	5/8 (15,88)
	Drain piping		15 ~ 17mm (inner size)	15 ~ 17mm (inner size)
Operation range	Cool	Ambient	°C	+10 ~ +43
		Water	°C	+5 ~ +20
	Heat	Ambient	°C	-20 ~ +32
		Water	°C	+25 ~ +45
Connectable system	3-Pipe (heat recovery type) VRF System (system capable up to 48HP)			
Maximum Indoor ratio (connectable hydrokit module capacity ratio)	Total indoor unit + Hydrokit capacity: up to 130% (** ~ **% vs total outdoor unit capacity)			

1) Max 45°C by refrigerant circuit (heat pump cycle), over 45°C is provided by electric heater operation.

Hydrokit control function / CZ-RTC5B

- CZ-RTC5B is updated version from CZ-RTC3. It can be used for hydrokit and also normal indoor unit. CZ-RTC5B checks the type of connected unit and switch hydrokit or air conditioner style of display automatically

- Operating mode on hydrokit style to be set at initial setting of the system from following modes: tank mode or air conditioning mode

Overview: hydromodule in VRF system

- Multiple hydromodule connection in same circuit is available
- Each module can be set different operation mode either hot water supply mode or space heating mode (both operation modes are not able to set at 1 hydromodule)
- 3-Pipe control solenoid valve kit is necessary for each indoor unit and hydromodule

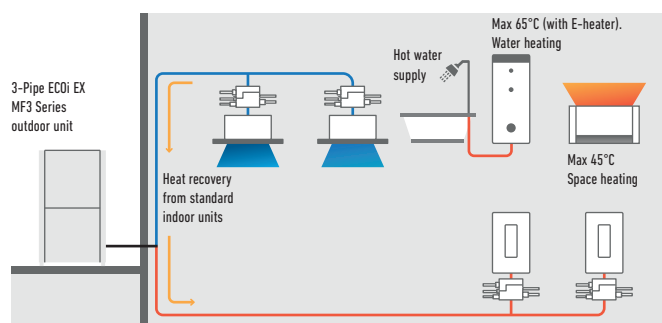

NEW PRO-HT TANK SERIES FOR PACi AND ECOi

**MAXIMUM
75°C
WATER OUTLET
TEMPERATURE**



PRO-HT Tank DHW. Big volume and high temperature tank for commercial application

1 High performance and high saving

- A7 COP 4,2 for ECOi 2-Pipe, 6,70 for ECOi 3-Pipe in case of heat recovery
- System label maximum A+++ (scale from A+++ to G)
- Efficient hot water production by heat recovery
- High temperature hot water without booster

2 Hot water production with simultaneous heating and cooling

- Maximum water outlet temperature up to 75°C
- Big volume tank of 1000L capacity
- Heat exchanger design prevents limescale

3 Trusted quality

- Double tube heat exchanger following drinking-water regulation
- Tank and heat exchanger made with stainless steel
- Internal and external pickling

Solution example DHW tank 1000L + ECOi 3-Pipe mixed system

- Ideal offer for hotel projects
- DHW production under spontaneous heating and cooling
- Hot water up to 65°C is efficiently produced by heat recovery
- A7 COP 6,70 considering heat recovery

One by one system compatible list with ECOi

Model	Tank type	Product compatibility	Hot water outlet temperature
PAW-VP1000LDHW	DHW	U-10ME2 (2-Pipe)	75°C
		U-16MF3 (3-Pipe)	65°C

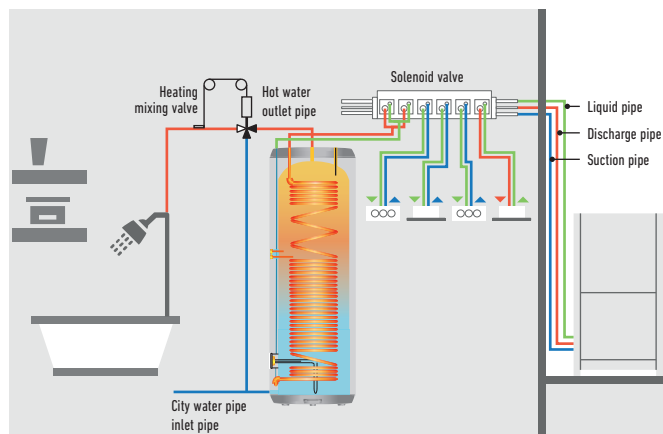

New PRO-HT Tank DHW

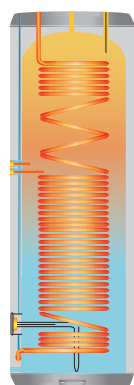

NEW
2019

PRO-HT TANK

Enjoy an efficient DHW and heating and cooling tank.

Panasonic commercial PRO-HT Tank solutions meet all needs of your hot water applications providing maximum water temperature 75°C.

High temperature hot water is efficiently produced without any boosters.

Panasonic commercial PRO-HT Tank solutions can be combined with ECOi 2-Pipe and 3-Pipe to adapt various projects from high-end residential to offices and hotels.

Technical focus

- Water volume 1000L
- Maximum hot water production 75°C without boosters
- Tank and heat exchanger made with stainless steel
- Heating coil 63m
- Internal and external pickling
- Foam insulation 100mm
- Tank material 3mm
- ABS external

PRO-HT Tank			PAW-VP1000LDHW	
Outdoor Unit			U-10ME2E8	U-16MF3E8
Volume		L	933	933
Height	H x W	mm	2210x990	2210x990
Connections to the water supply network			1 1/4"	1 1/4"
Net weight / with water		kg	186 / 1119	186 / 1119
Nominal electrical power		W	6620	6920
Reference tapping cycle			2XL	2XL
Energy consumption by chosen cycle A7 / W10-55		kWh	5,80	5,06
Energy consumption by chosen cycle A15 / W10-55		kWh	4,90	4,46
COP DHW (A7 / W10-55) EN 16147 ¹⁾			4,23	4,85
COP DHW (A15 / W10-55) EN 16147 ²⁾			5,00	5,50
Energy Efficiency Class (from A+ to G) ³⁾			A+	A+
System label (from A+++ to G) ³⁾			A+++	—
Standby Input power according to EN16147		W	77,00	73,00
Sound Pressure on 1m		dB(A)	53	53
Quantity of refrigerant		g	6,8 + 1,0	9,3 + 1,0
Operating range - air temperature		°C	-20 ~ +35	-20 ~ +35
Stainless steel 316L tank			Yes	Yes
Average insulation thickness		mm	100	100
Heat exchanger connection for inlet / outlet		Inch (mm)	1/2 (12,70) / 3/4 (19,05)	1/2 (12,70) / 3/4 (19,05)
Maximum power consumption without heater		W	9000	18500
Maximum power consumption with heater		W	15000	24500
Number of electrical heaters x power		W	1 x 6000	1 x 6000
Voltage / Frequency		V / Hz	400 / 50	400 / 50
Electric protection		A	16	16
Moisture protection			IP24	IP24
Heating with heat pump	Min / Max	°C	5/76	5 / 76
Heating with electrical heater	Min / Max	°C	55 / 75	55 / 75
Refrigerant (R410A) / CO ₂ Eq.		kg / T	7,80 / 16,2864	10,30 / 21,5064

Accessories

PAW-VP-RTC5B-VRF Tank Controller for ECOi system

PAW-VP-VALV-160/280 Expansion Valve Kit, 16/28kW

1) Heating of sanitary water up to 55°C with inlet air temperature at 7°C, humidity at 89% and inlet water temperature at 10°C. According to EN16147. 2) Heating of sanitary water up to 55°C with inlet air temperature at 15°C, humidity at 74% and inlet water temperature at 10°C. According to EN16147. 3) Following LOT2 (COMMISSION DELEGATED REGULATION (EU) No. 812/2013).

This product is designed to meet the European Drinking Directive 98/83/EC amended by 2015/1787/EU. The lifespan of the product is not guaranteed in the case of the use of groundwater, such as spring water or well water, the use of tap water when salt or other impurities are contained, nor in areas of acidic water quality. Maintenance and warranty costs related to these cases are the customer's responsibility.

* When connected as pressurised, safety valve is mandatory.

AQUAREA AIR

AQUAREA
AIR

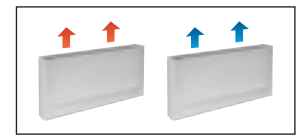

Air flow	Speed	PAW-AAIR-200-2			PAW-AAIR-700-2			PAW-AAIR-900-2		
		Min	Med	Max	Min	Med	Max	Min	Med	Max
Heating mode										
Total heating capacity	W	217,00	470,00	570,00	708,00	1032,00	1188,00	886,00	1420,00	1703,00
Water flow	kg/h	37,30	80,80	98,00	121,80	177,50	204,30	152,40	244,20	292,90
Water pressure drop	kPa	0,40	2,00	2,90	0,30	0,80	1,00	0,50	1,60	2,20
Inlet water temperature	°C	35	35	35	35	35	35	35	35	35
Outlet water temperature	°C	30	30	30	30	30	30	30	30	30
Inlet air temperature	°C	19,00	19,00	19,00	19,00	19,00	19,00	19,00	19,00	19,00
Outlet air temperature	°C	38,90	32,00	30,00	33,30	31,80	30,60	30,20	31,10	30,60
Cooling mode										
Total cooling capacity	W	237,00	345,00	555,00	756,00	1039,00	1204,00	1153,00	1518,00	1746,00
Sensible cooling capacity	W	230,00	314,00	504,00	646,00	903,00	1058,00	1061,00	1384,00	1598,00
Water flow	kg/h	40,00	59,00	95,00	129,00	178,00	207,00	198,00	261,00	300,00
Water pressure drop	kPa	0,40	2,00	2,90	1,00	2,00	2,00	6,00	9,00	12,00
Inlet water temperature	°C	10	10	10	10	10	10	10	10	10
Outlet water temperature	°C	15	15	15	15	15	15	15	15	15
Inlet air temperature	°C	27,00	27,00	27,00	27,00	27,00	27,00	27,00	27,00	27,00
Outlet air temperature	°C	15,00	17,00	18,00	14,00	16,00	17,00	16,00	17,00	18,00
Relative humidity of inlet air	%	47	47	47	47	47	47	47	47	47
Air flow	m ³ /min	0,90	1,90	2,70	2,60	4,20	5,30	4,10	6,10	7,70
Maximum input power	W	7,00	9,00	13,00	14,00	18,00	22,00	16,00	20,00	24,00
Sound pressure	dB(A)	23	33	40	24	36	42	25	36	44
Dimension (HxWxD)	mm	735 x 579 x 129			935 x 579 x 129			1135 x 579 x 129		
Net weight	kg	17			20			23		
3 ways valve included		Yes			Yes			Yes		
Touch screen thermostat		Yes			Yes			Yes		

Super low temperature radiators for heat pump application

The slimline Panasonic Aquarea Air radiators deliver high efficiency climate control.

With a depth of just under 13cm they are at the cutting edge of the market. Blending easily into the home, Aquarea Air's elegant design and product refinements are clear to see in every detail. Exceptional ventilation efficiency means the motor uses considerably less energy (low wattage). The fan speed is continuously modulated by the temperature controller with proportional integral logic, with undoubted advantages for regulating the temperature and humidity in summer mode.



With standard cast radiators.

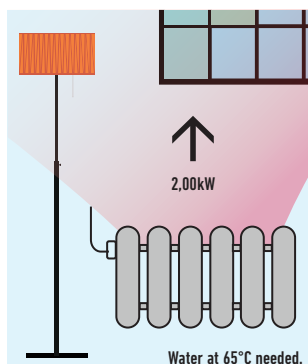

With Aquarea Air.

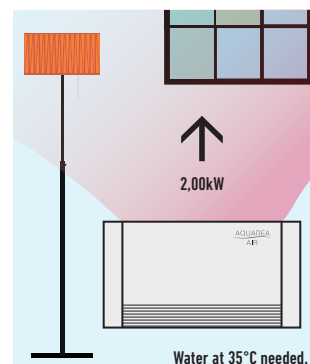

Technical focus:

- High heating capacity
- 3 fan speeds and capacities
- Exclusive design
- Extremely compact (only 12,9cm deep)
- Cooling and dehumidification functions possible (drain is needed)
- 3-way valve included (no overflow valve needed on the installation if more than 3 radiators installed)
- Touch screen thermostat

All temperature curves and capacity are available on www.panasonicproclub.com

FAN COILS

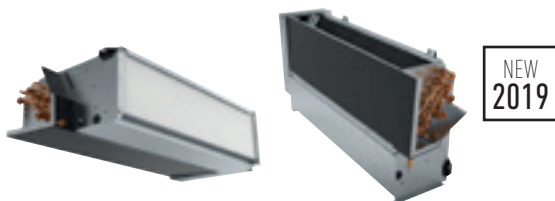

PAW-FC-303TC
Optional Controller.
Wired remote controller.



PAW-FC-RC1
Optional Controller.
Wired remote controller.

			Compact units							High Static Pressure	
Left side connection			PAW-FC-D11-1	PAW-FC-D15-1	PAW-FC-D24-1	PAW-FC-D28-1	PAW-FC-D40-1	PAW-FC-D55-1	PAW-FC-D65-1	PAW-FC-D90-1	PAW-FC-H150
Right side connection			PAW-FC-D11-1-R	PAW-FC-D15-1-R	PAW-FC-D24-1-R	PAW-FC-D28-1-R	PAW-FC-D40-1-R	PAW-FC-D55-1-R	PAW-FC-D65-1-R	PAW-FC-D90-1-R	PAW-FC-H150-R
Total cooling capacity ¹⁾	Med / S-Hi	kW	1,0 / 1,5	1,2 / 1,7	2,0 / 2,5	2,4 / 3,2	3,2 / 4,6	4,6 / 5,8	6,1 / 7,3	6,1 / 8,1	11,9 / 14,8
Sensible cooling capacity ¹⁾	Med / S-Hi	kW	0,8 / 1,1	0,9 / 1,3	1,5 / 1,9	1,8 / 2,3	2,2 / 3,3	3,3 / 4,5	4,3 / 5,1	4,6 / 6,3	9,6 / 12,9
Heating capacity ¹⁾	Med / S-Hi	kW	1,4 / 2,0	1,5 / 2,2	2,4 / 3,1	2,9 / 4,0	4,1 / 5,7	5,3 / 7,1	7,9 / 9,3	8,1 / 11,6	14,9 / 19,9
Power consumption	S-Lo / Med / S-Hi	W	14 / 24 / 36	10 / 18 / 29	16 / 37 / 45	15 / 37 / 56	28 / 55 / 72	37 / 75 / 105	53 / 100 / 147	90 / 112 / 188	180 / 421 / 675
Fuse rating	A		2	2	2	2	2	2	2	2	6
Dimensions (including pan and electrical box)	HxWxD	mm	220x570x430	220x570x430	220x753x430	220x938x430	220x1122x430	220x1307x430	220x1121x530	220x1316x530	356x1600x798
Weight (without water content)	kg		13	13	15	20	22	26	27	38	63
Sound power global	S-Lo / Med / S-Hi	dB(A)	33 / 40 / 49	31 / 43 / 50	30 / 45 / 52	30 / 44 / 51	34 / 46 / 56	38 / 51 / 58	43 / 56 / 61	50 / 55 / 64	52 / 64 / 71
Sound pressure global	S-Lo / Med / S-Hi	dB(A)	24 / 31 / 40	22 / 34 / 41	21 / 36 / 43	21 / 35 / 42	25 / 37 / 47	29 / 42 / 49	34 / 47 / 52	41 / 46 / 55	31 / 45 / 51
Static pressure	Max	Pa	30	30	50	50	70	70	70	70	110
Airflow ¹⁾	Med / S-Hi	m ³ /h	190 / 283	179 / 265	274 / 390	357 / 499	486 / 716	640 / 933	893 / 1064	936 / 1397	2112 / 3176
Water pressure drop	Med / S-Hi	kPa	19,5 / 39,2	3,9 / 6,3	19,3 / 28,8	17,1 / 28	22,8 / 46,9	37,4 / 60,2	15,4 / 21,5	19,3 / 32,5	19,8 / 26,1
Fan speeds			3 speeds	3 speeds	3 speeds	3 speeds	3 speeds	3 speeds	3 speeds	3 speeds	3 speeds
Fan motor and total speeds			AC 5 speeds	AC 5 speeds	AC 5 speeds	AC 5 speeds	AC 5 speeds	AC 5 speeds	AC 5 speeds	AC 5 speeds	AC 5 speeds
Drain pan and Air filter			Included	Included	Included	Included	Included	Included	Included	Included	Included
Water connections	Inch		1/2	1/2	1/2	1/2	1/2	1/2	3/4	3/4	1

Accessories

PAW-FC-RC1	Advanced wired control for Fan Coil
PAW-FC-303TC	Wired remote controller
PAW-FC-2WY-11/55-1	2 way valve + drain pan (for PAW-FC-D11/15/24/28/40/55-1)
PAW-FC-2WY-65/90-1	2 way valve + drain pan (for PAW-FC-D65/90-1)

Accessories

PAW-FC-2WY-150	2 way valve (for PAW-FC-H150)
PAW-FC-3WY-11/55-1	3 way valve + drain pan (for PAW-FC-D11/15/24/28/40/55-1)
PAW-FC-3WY-65/90-1	3 way valve + drain pan (for PAW-FC-D65/90-1)
PAW-FC-3WY-150	3 way valve (for PAW-FC-H150)

1) Airflow and capacity at 0Pa of static pressure. * Performances based on: Cooling: Air: 27°C DB / 19°C WB, Chilled water: 7°C / 12°C - Heating: Air: 20°C DB, Hot water: 50°C / 45°C.



New range of Fan Coil units

Easy to install, improved sound level and performance. New Fan Coil range consist on one compact ducted range ideal for residential and commercial use and one model with high static pressure for commercial applications. The range certified by Eurovent includes drain pan and filter and are equipped with a low consumption fan motor. The new D type is even more flexible thanks to L Drain pan, same unit can be installed in both Horizontal or in Vertical position.

Fan Coil controller PAW-FC-RC1

This advance control can bring higher level of comfort in heating. The sensor can be used as water flow sensor, stopping the fan when low water temperature, avoiding cold drafts in winter. Also is ready to use J Generation new feature of defrost mode and stop the Fan Coil.

Features:

- Room thermostat
- 3 outputs, 230V relays for fan control
- 2 outputs, 230V relays for heating / cooling control
- Modbus RTU slave
- 1 DI for presses detection (key card switch)
- 1 AI for sensor

1 Innovation for an optimum comfort

2 Low energy consumption fan

3 Quality and efficient Coil

4 Flexible vertical - horizontal installation

PANASONIC VENTILATION SOLUTIONS



For maximum savings and easy integration.

AHU connection kit 16kW, 28kW and 56kW

AHU connection kit contains: IP65 box with PCBs and terminal connections mounted inside, expansion valve and sensors.

Heat exchanger, fan & fan motor to be mounted in the AHU itself shall be provided in the field.

Application: Hotels, offices, server rooms or all large buildings where air quality control such as humidity control and fresh air and is needed.



AHU Kit combines air conditioning and fresh air in just one solution.

New AHU Kits connect ECOi systems to air handling unit systems, using the same refrigerant circuit as the VRF system. Large connectivity possibilities mean the Panasonic AHU Kit can be easily integrated.

3 types of AHU Kit: Deluxe, Medium and Light.

Model Code	IP 65	0-10V demand control*	Outdoor temperature shift compensation. Cold draft prevention
PAW-160MAH2 / PAW-280MAH2 / PAW-560MAH2	Yes	Yes	Yes
PAW-160MAH2M / PAW-280MAH2M / PAW-560MAH2M	Yes	Yes	No
PAW-160MAH2L / PAW-280MAH2L / PAW-560MAH2L	Yes	No	No

* With CZ-CAPBC2.

Heat Recovery With DX Coil

Motorised heat recovery by-pass device automatically controlled by unit control to use fresh air free-cooling when convenient.



- Galvanized steel self-supporting panels, internally and externally insulated
- High efficiency enthalpic heat recover, static cross flow type, made by membrane with high moisture permeability, good air tightness, excellent tear resistance, and aging resistance, it is structures with flat plates and corrugated plates. Total heat exchange with temperature efficiency up to 76% and enthalpy efficiency up to 67%, also at high level during summer season
- ISO16890 ePm_{2.5} 95% (F9 EN 779) efficiency class filter with synthetic cleanable media and COARSE 50% (G3 EN 779) pre-filter ON fresh air, COARSE 50% filter on return air intake
- Removable side panel to access filters and heat recovery in the event of scheduled maintenance
- Low consumption, high efficiency & low noise direct driven fans with 3-speed EC motors
- Supply section complete with DX Coil (R410A) fitted with solenoid control valve, freon filter, contact temperature sensors on liquid and gas line, NTC sensors upstream and downstream airflow

Air Curtain with DX Coil

Highly efficient heating effect.

The combined air stream, which has a desirable low air current induction factor (mixing factor), can carry the selected initial temperature effect over long distances, and will reach the floor area while still at room temperature. This is necessary to avoid cooling down the interior spaces.



The Panasonic range of air curtains is designed for smooth operation and efficient performance. Air curtains produce a continuous stream of air blown from the top to the bottom of an open doorway and create a barrier that people and products can flow across, but air can't. Designed to improve energy efficiency, minimise heat loss from a building, and to allow retailers to keep doors open to encourage customers, our Air Curtains are suitable for connection to both VRF and PACi Systems.

Heating capacity comparison: Electrical air curtain / Panasonic air curtain

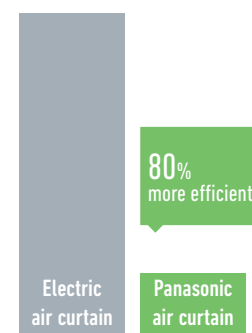

* With the U-100PZH2E5 on the PAW-20PAIRC-LS. Calculation method: Taking as consideration SCOP of the Panasonic combination of 6.0. If 100 is the energy needed for a air curtain, Panasonic Air curtain will need 1/(1-6)*100=20.

Energy Recovery Ventilation

Panasonic Energy Recovery Ventilators help you with your comfort and energy-saving plan.



Panasonic Energy Recovery Ventilators can reduce the outside air load because they efficiently recover the heat lost by ventilation during the heat recovery process. This results in energy-saving ventilation and lower running costs for air-conditioning and heating equipment. Furthermore, by designing our current models with an counter-flow heat-exchange element, we achieved products with slim body shapes and quiet operation that create a comfortable and pleasant air-conditioned environment while saving energy.

- Dramatic energy savings achieved through adoption of a high-efficiency counter-flow heat-exchange element
- Counter-flow heat exchange element used for reduced noise and slimmer, more compact body shape
- All maintenance can be performed through a single inspection hole
- Straight air supply / exhaust system used for easier installation

When a regular ventilation fan is used¹ When a Energy Recovery Ventilator is used²

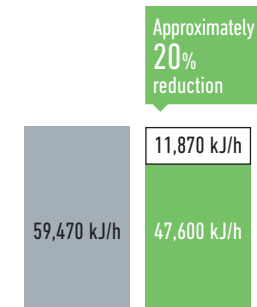

1) Two FY-27FPK7 units. 2) One FY-500ZY8R unit.

AHU connection kit 16, 28 and 56kW for ECOi and ECO G



Panasonic AHU Kit, 16-56kW connected to ECOi or ECO G

PCB, Transformer, Solenoid Control Valve, Thermistor x 4 pcs, Terminal Base and Electrical Component Box.

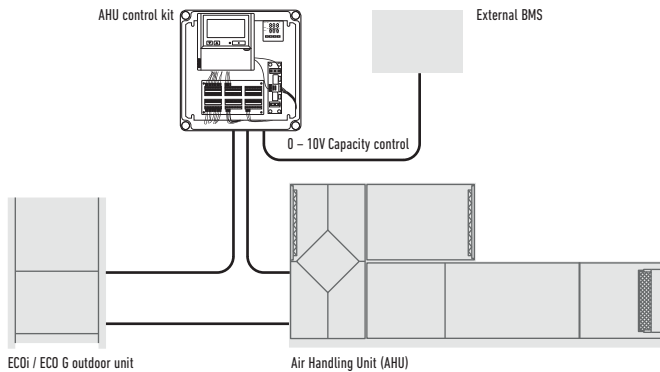

Demand control on the outdoor unit managed by external 0-10 V signal.

System example for large capacity (more than 56kW)
 3 x [PCB, Transformer, Solenoid Control Valve, Thermistor x 4 pcs, Terminal Base and Electrical Component Box].
 Example 140kW system

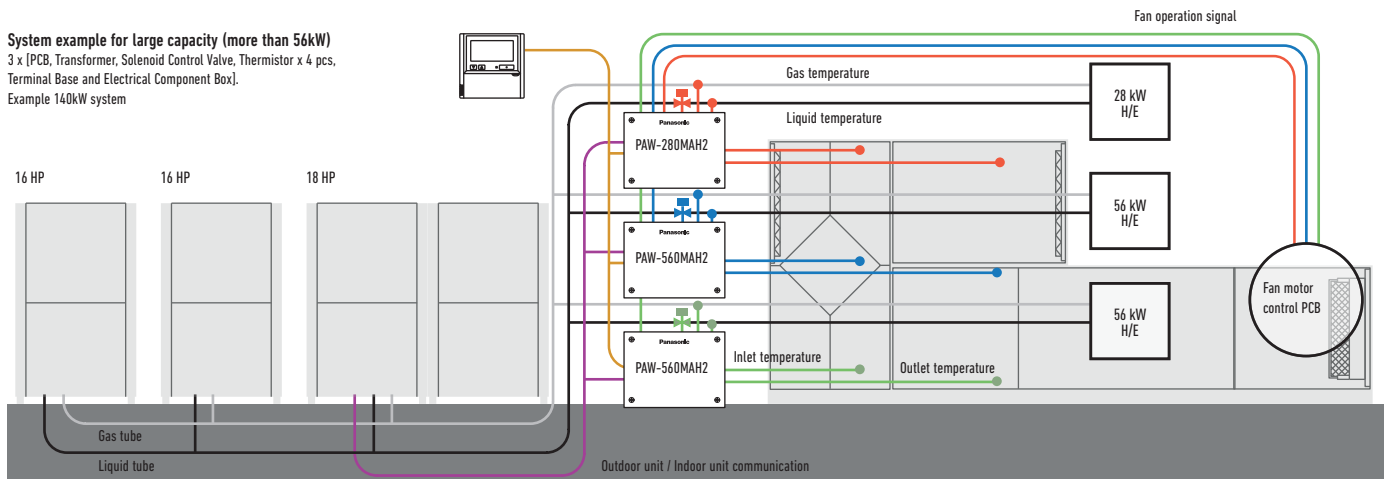

Optional parts: Following functions are available by using different control accessories:

CZ-RTC4 Timer remote controller.

- Operation-ON/OFF
- Mode select
- Temperature setting

* Fan operation signal can be taken from the PCB.

CZ-T10 terminal.

- Input signal= Operation ON/OFF
- Remote controller prohibition
- Output signal= Operating-ON status
- Alarm output (by DC12V)

PAW-OCT, DC12 V outlet. OPTION terminal.

- Output signal= Cooling/Heating/Fan status
- Defrost
- Thermostat-ON

CZ-CAPBC2 Mini seri-para I/O unit.

- Demand control 40% to 120% (5% steps) by 0-10V input signal
- Temperature setting by 0-10V or 0-140 Ω input signal
- Room (inlet air) temp outlet by 4-20mA
- Mode select or/and ON/OFF control
- Fan operation control
- Operation status output/ Alarm output
- Thermostat ON/OFF control

PAW-T10 PCB to connect to T10 connector.

- A Dry contact PCB has been developed to easily control the unit
- Input signal operation ON/OFF
- Remote control prohibition
- Output signal Operation ON status maximum 230V 5A (NO/NC)
- Output signal alarm status max. 230 V 5 A (NO/NC)
- Additional available contacts:
 - External humidifier control (ON/OFF) 230 VAC 3A
 - External fan control (ON/OFF) 12V DC
 - External filter status signal potential free
 - External float switch signal potential free
 - External leakage detection sensor or TH. OFF contact potential free (possible usage for external blow out temperature control)

ECOi 2-Pipe Series outdoor unit shall be used for AHU Connection Kit. 3 models for VRF system: 5HP (PAW-160MAH2/M/L), 10HP (PAW-280MAH2/M/L) and 20HP (PAW-560MAH2/M/L).

With ECO G outdoor units

- One AHU kit may be used for one ECO G unit (2-Pipe, 56kW). Multiple AHU kits cannot be used
- Mixed with standard indoor units is not allowed
- Power specifications are Single Phase 220V to 240V

Technical focus

- Maximum capacity/system: 60HP (168kW)
- Maximum piping length: 100m (120m equivalent)
- Elevation difference (indoor unit / indoor unit): 4m
- In/Out capacity ratio: 50~100%
- Maximum indoor unit number: 3 units*
- Outdoor temperature range in heating: -20 ~ +15°C
- Available temperature range for the suction air at AHU Kit: cool: +18 ~ +32°C / heat: +16 ~ +30°C

* To be simultaneous operation controlled by one remote controller sensor.

- The systems is controlled by the suction air (or room return air) temperature (same as standard indoor unit). (Selectable mode: Automatic / Cooling / Heating / Fan / Dry (but same as Cool))
- The discharge air temperature is also controlled to prevent too-low air discharge in cooling or too-high air discharge in heating (in case of VRF)
- Demand control (Forcible thermostat-OFF control by operating current)
- Defrost operation signal, Thermo-ON/OFF states output
- Drain pump control (Drain-pump and the float switch to be supplied in local)
- External target temperature setting via Indoor/Outdoor signal interface is available with CZ-CAPBC2 (Ex. 0 – 10V)
- Demand control 40% to 120% (5% steps) by 0-10V input signal
- Connectable with P-Link system. Special care for electrical noise may be necessary depending on the on-side system
- Fan control signal from the PCB can be used for control the air volume (high/mid/low and LL for Th-OFF). Need to change the fan control circuit wiring at field

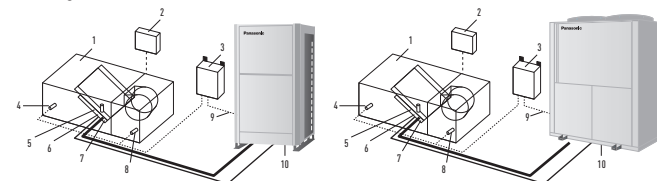

System & regulations. System overview.

1. AHU Unit equipment (field supplied)
2. AHU Unit system controller (field supplied)
3. AHU Kit controller box (with control PCB)
4. Thermistor for discharge air
5. Electronic expansion valve
6. Thermistor for gas pipe (E3)
7. Thermistor for liquid pipe (E1)
8. Thermistor for suction air
9. Inter-unit wiring
10. Outdoor unit

HP	5HP		10HP		20HP		30HP		40HP		50HP		60HP	
	PAW-160MAH2/M/L		PAW-280MAH2/M/L		PAW-560MAH2/M/L		PAW-280MAH2/M/L		PAW-560MAH2/M/L		PAW-560MAH2/M/L		PAW-560MAH2/M/L	
Nominal cooling capacity @ 50Hz	kW		14,00		28,0		56,0		84,0		112,0		140,0	
Nominal heating @ 50Hz	kW		16,00		31,5		63,0		95,0		127,0		155,0	
Cooling airflow	Hi / Lo	m ³ /min	2600 / 1140		5000 / 3500		10000 / 7000		15000 / 10500		20000 / 14000		25000 / 17500	
Bypass factor			0,9 (recommended)		0,9 (recommended)		0,9 (recommended)		0,9 (recommended)		0,9 (recommended)		0,9 (recommended)	
Dimensions	H x W x D	mm	303 x 232 x 110		404 x 425 x 78		404 x 425 x 78		404 x 425 x 78		404 x 425 x 78		404 x 425 x 78	
Weight		kg	3,2		6,3		6,3		6,3		6,3		6,3	
Piping length	Min / Max	m	10 / 100		10 / 100		10 / 100		10 / 100		10 / 100		10 / 100	
Elevation difference (in/out)	Max	m	10		10		10		10		10		10	
Piping connections	Liquid pipe	Inch (mm)	3/8 (9,52)		3/8 (9,52)		5/8 (15,88)		3/4 (19,05)		3/4 (19,05)		3/4 (19,05)	
	Gas pipe	Inch (mm)	5/8 (15,88)		7/8 (22,22)		1 1/8 (28,58)		1 1/4 (31,75)		1 1/2 (38,15)		1 1/2 (38,15)	
Intake temperature of AHU Kit	Cool Min ~ Max	°C DB	+18 ~ +32		+18 ~ +32		+18 ~ +32		+18 ~ +32		+18 ~ +32		+18 ~ +32	
	Cool Min ~ Max	°C WB	+13 ~ +23		+13 ~ +23		+13 ~ +23		+13 ~ +23		+13 ~ +23		+13 ~ +23	
	Heat Min ~ Max	°C	+16 ~ +30		+16 ~ +30		+16 ~ +30		+16 ~ +30		+16 ~ +30		+16 ~ +30	
Ambient temperature of outdoor unit	Cool Min ~ Max	°C	-10 ~ +43		-10 ~ +43		-10 ~ +43		-10 ~ +43		-10 ~ +43		-10 ~ +43	
	Heat Min ~ Max	°C	-20 ~ +15		-20 ~ +15		-20 ~ +15		-20 ~ +15		-20 ~ +15		-20 ~ +15	

AHU connection kit / System combination

Capacity (HP)	Outdoor unit combination	AHU kit combination
28kW (10HP)	U-10ME2E8	PAW-280MAH2
56kW (20HP)	U-20ME2E8	PAW-560MAH2
84kW (30HP)	U-16ME2E8 U-14ME2E8	PAW-560MAH2 PAW-280MAH2
112kW (40HP)	U-20ME2E8 U-20ME2E8	PAW-560MAH2 PAW-560MAH2
140kW (50HP)	U-18ME2E8 U-16ME2E8	PAW-560MAH2 PAW-560MAH2 PAW-280MAH2
168kW (60HP)	U-20ME2E8 U-20ME2E8	PAW-560MAH2 PAW-560MAH2 PAW-560MAH2
56kW (20HP)	U-20GE3E5	PAW-560MAH2

Air Curtain with DX Coil, connected to the VRF or PACi Systems

Highly efficient heating effect

The combined air stream, which has a desirable low air current induction factor (mixing factor), can carry the selected initial temperature effect over long distances, and will reach the floor area while still at room temperature. This is necessary to avoid cooling down the interior spaces.

Available in different lengths to suit requirements between 1 and 2,5m, both air curtains have outlet grilles that can be adjusted to five different positions. The HS model can be installed up to a height of 3,0m with the LS model up to 2,7m. The outlet grilles can be easily adjusted into five positions to suit different installation requirements and the air filter can be accessed without the need for specialist tools.

- High performance with EC fan motor (40% lower running costs compared to a standard AC fan motor)
- Easy Cleaning and Servicing
- Can be connected to either Panasonic VRF or PACi systems
- Built-in drain for cooling operation
- HS and LS models can be controlled via Panasonic's range of remote internet controls

The new HS and LS models are ideal for connection to a ECOi or PACi system. With simple "plug and play" installation, both are fitted with an EC fan motor for a smooth operation and efficient performance. This fan guarantees 40% lower running cost than with a standard AC fan motor. Air curtains run approximately 12 hours per day at shops, and efficient performance contributes to energy savings.

Internet Control

An App added to your tablet or smartphone or via the Internet allows you to control and manage the system remotely. There is also the option to integrate into existing BMS systems by using other Panasonic interfaces.

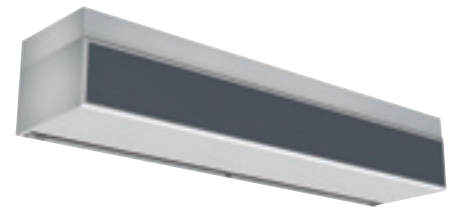
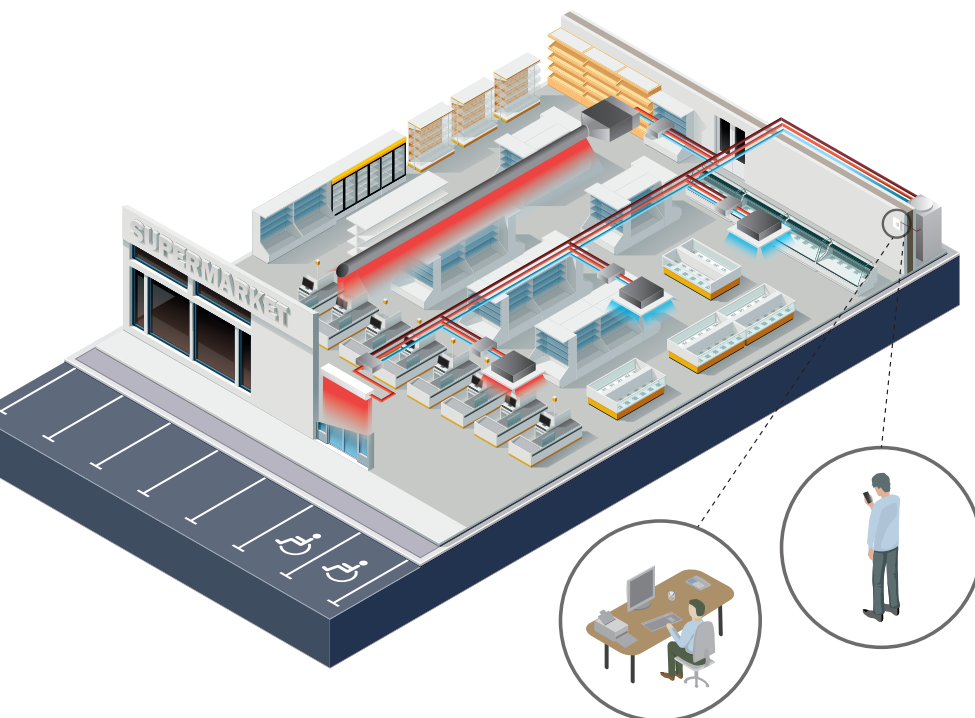

Intelligent Operation

Our air curtains combine airflow and heating / cooling technology to ensure optimum comfort and energy efficiency whilst also creating an effective barrier between indoor and outdoor environments. Design and installation is key to achieving the correct height / temperature settings to achieve optimum performance. Our air curtains are designed to answer the demands of the retail, commercial and industrial markets.

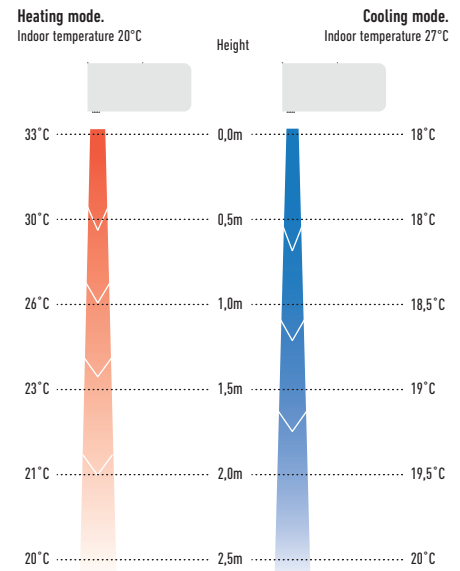

How does it work?

Stale air from the room is taken in and ejected near the door. This creates a 'roll of air' that shields the door area, mixing with the colder incoming air. It then turns away from the door, back into the room and toward the intake screen, where it is partly drawn in again. This flow of air helps to create a barrier for heat loss yet at the same time refreshes room air

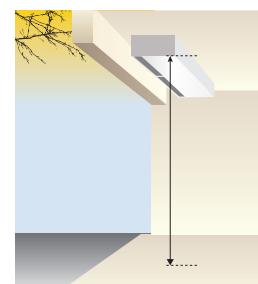

Max installation high.
HS: 3,0m
LS: 2,7m



High efficiency air curtain connected to your PACi or VRF installation. EC Fan motor for a smooth operation and an efficient performance. 2 types of air flow available: LS and HS! Easy installation, regulation, cleaning, service.

Technical focus

- Save up to 40% energy costs by use of the integrated EC fan technology (higher efficiency than conventional AC fan, soft start and longer motor duration)
- 4 length of air curtain LS and HS are available 1,0, 1,5, 2,0 and 2,5m
- Installation height up to 3,0m
- Outlet grilles can be adjusted in five positions, to suite different indoor and installation requirements
- Control with Panasonic remote control systems (optional)
- Direct integration to BMS by optional Panasonic interfaces
- Trip dray included in all DX air curtain steps

Features

Comfort: Easy redirection of air flow by means of manual deflector.

Ease of use: Speed selector (high and low) on the unit itself.

Easy installation and maintenance: Easy installation. Compact dimensions improve installation and positioning. Easy cleaning of grid without opening of the unit.

Optimised airflow velocity

1. Energy losses, no air curtain installed
2. Too low velocity air curtain – air curtain not efficient
3. Optimum results with the Frico air curtain connected to Panasonic VRF
4. Too high velocity air curtain – considerable turbulence, energy lost to the outside, air curtain not efficient

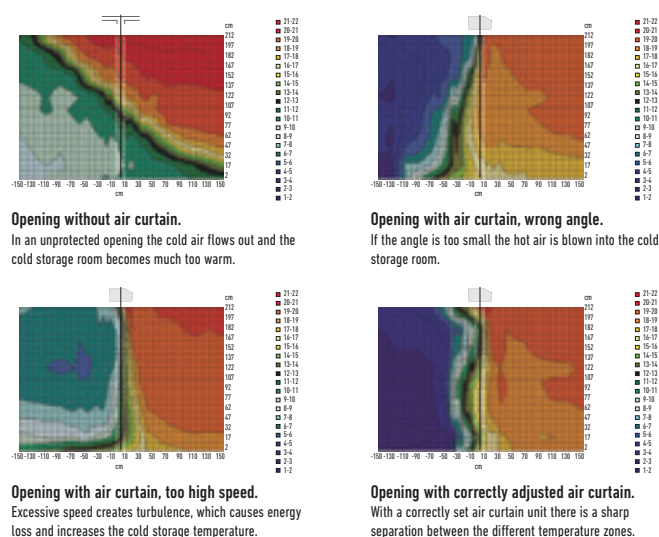

Outdoor units			4HP	4HP	5HP	8HP
Air outlet height 2,7m			PAW-10EAIRC-LS	PAW-15EAIRC-LS	PAW-20EAIRC-LS	PAW-25EAIRC-LS
Air volume	High / Low	m ³ /h	1800 / 1000	2700 / 1400	3600 / 1900	4500 / 2400
Cooling capacity ¹⁾	Max	kW	6,10	9,70	13,00	17,00
Heating capacity ²⁾	Max	kW	7,90	12,00	15,00	19,00
Heat Exchanger	Volume	L	1,67	2,85	3,94	5,03
Piping connections	Liquid pipe / Gas pipe	mm	16,6 / 15,0	16,6 / 22,0	16,6 / 22,0	16,6 / 22,0
Electric consumption fan	230V / 50Hz	kW	0,30	0,50	0,60	0,80
Fan type			EC	EC	EC	EC
Currency	230V / 50Hz	A	2,10	3,10	4,10	5,10
Sound Pressure ³⁾		dB(A)	49 / 65	48 / 66	50 / 67	51 / 69
Dimension	H x W x D	mm	1000 x 260 x 460	1500 x 260 x 460	2000 x 260 x 460	2500 x 260 x 460
Weight		kg	50	65	80	95
Door width		m	1,0	1,5	2,0	2,5
Refrigerant			R410A	R410A	R410A	R410A

Outdoor units			4HP	6HP	8HP	10HP
Air outlet height 3,0m			PAW-10EAIRC-HS	PAW-15EAIRC-HS	PAW-20EAIRC-HS	PAW-25EAIRC-HS
Air volume	High / Low	m ³ /h	2700 / 1450	3600 / 1900	5400 / 2900	6300 / 3400
Cooling capacity ¹⁾	Max	kW	9,10	13,00	19,50	23,70
Heating capacity ²⁾	Max	kW	11,80	15,80	23,60	27,60
Heat Exchanger	Volume	L	1,67	2,85	3,94	5,12
Piping connections	Liquid pipe / Gas pipe	mm	16,6 / 15,0	16,6 / 22,0	16,6 / 22,0	16,6 / 22,0
Electric consumption fan	230V / 50Hz	kW	0,75	1,00	1,50	1,75
Fan type			EC	EC	EC	EC
Currency	230V / 50Hz	A	4,10	5,50	8,20	9,60
Sound Pressure ³⁾		dB(A)	50 / 66	49 / 67	51 / 68	52 / 68
Dimension	H x W x D	mm	1000 x 260 x 460	1500 x 260 x 460	2000 x 260 x 460	2500 x 260 x 460
Weight		kg	55	65	85	110
Door width		m	1,0	1,5	2,0	2,5
Refrigerant			R410A	R410A	R410A	R410A

1) Cooling capacity DX Coil, air temperature in/out +27/+18°C, R32 and R410. 2) Heating capacity condenser, air temperature in/out +20/+33°C, R32 and R410. In the case of lower outdoor temperatures, an outdoor model with higher capacity may be necessary. 3) Measured in distance up to 5,0m, direction factor 2, absorbing surfaces 200m², Min / Max air volume.



Energy Recovery Ventilation

Energy efficiency and ecology

Energy consumption is dramatically reduced by using a counter-flow heat-exchange element. Air conditioning load is reduced by approximately 20%, resulting in significant energy savings.

Comparison of former and current elements

With the cross-flow element, air moves in a straight line across the element; with the counter-flow element, air flows through the element for a longer time (longer distance), so the heat-exchange effect remains unchanged even if the element is made thinner.

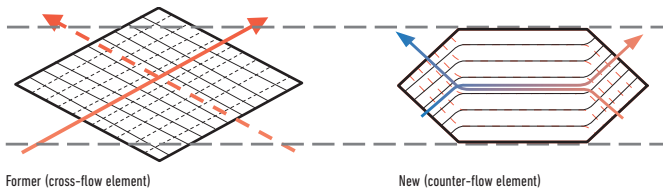

Heat exchange ventilation and normal ventilation

Energy-saving ventilation can be achieved through the proper use of heat-exchange ventilation and normal ventilation.

Heat exchange ventilation.

When a room is cooled or heated, the exhausted cooling / heating energy is recovered by heat-exchange ventilation.

Normal ventilation.

This is used in the spring and autumn, when rooms are not cooled or heated, that is, when there is little difference between the indoor and outdoor air conditions. In addition, at night during the hot season, when the outside air temperature drops the outside air is drawn inside without heat exchange, alleviating the load on the air conditioning equipment. The heat exchanger is made up of a membrane manufactured from a special material covered in resin for optimal heat transmission. The nylon/polyester fibre filter offers high dust retention capacity. We have also redesigned the air ducts to obtain a long-lasting heat exchange system which does not need periodic cleaning.

Heat exchanger

With the cross-flow element, air moves in a straight line across the element. With the counter-flow element, airflows through the element for a longer time (longer distance), so the heat-exchange effect remains unchanged even if the element is made thinner.



More comfort

Quiet operation

Low noise operation results in noticeably quieter units. All models with capacities below 500m³/h run at noise levels below 32dB (High setting) and even our largest 1.000m³/h-capacity model runs at only 37,5dB (High setting).

Long service life of heat-exchange element

We used a nonwoven cloth filter with a high dust collection efficiency and redesigned the air flow passages to achieve a durable heat-exchange element that requires no periodic cleaning.

Changes in airflow resistance based on number of years in service.

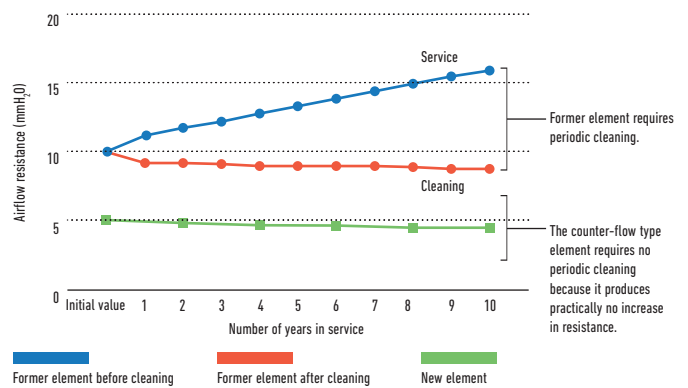

Easy installation and maintenance

Slim shape and easier installation.

Counter-flow heat exchange element used for reduced noise and slimmer, more compact body shape.

270mm Height: FY-250ZDY8R // FY-350ZDY8R // FY-500ZDY8R

388mm Height: FY-800ZDY8R // FY-01KZDY8R

Reverse mountable direct air supply / exhaust system.

Adoption of straight air supply / exhaust system: Duct design is simplified because the air supply / exhaust ducts are straight.

Since each unit can be mounted in reverse position, only one inspection hole is needed for two units: Two units can share one inspection hole so duct work is easier and more flexible.

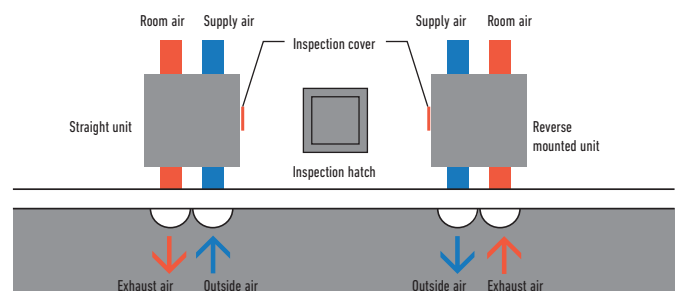

Suppresses indoor temperature changes while providing fresh air. Recovers up to 77% of the heat in the outgoing air, for an ecological and energy efficient building.

Features

Energy efficiency and ecology.

- Up to 20% energy saving in the installation
- Recovers up to 77% of the heat in the outgoing air

Comfort.

- Cleaning reduced due to the revolutionary structure (every 6 months)
- Ideal for indoor spaces without windows

Easy installation and maintenance.

- 5 models for easier selection
- Reduced system height (270mm and 388mm)
- Side opening for cleaning (inspection of filter, motor and other parts)
- Installation can be reversed to share an inspection opening between 2 machines
- Easy connection to the air conditioning unit (without additional elements)
- Installation in false ceilings
- Units operate at 220 - 240V
- High static pressure for easier installation

Technical focus

- High energy saving, up to 20%
- Counter Cross Flow technology for better efficiency
- Long life element core
- Easy installation and 20% less thickness
- Easy connection to air conditioning units
- Silent units

Balanced ventilation

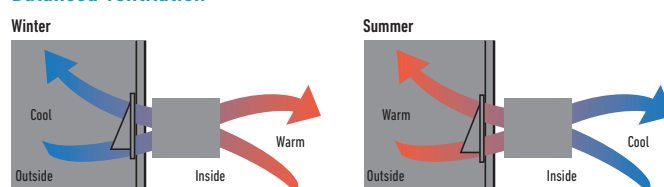

A new intuitive & stylish control

- Included as a standard control
- Compact and flat panel
- Filter cleaning support
 - Signal alert for clearing
 - Filter usage condition by 1/2/3/4 months
- Size (W x H x D) 116 x 120 x 40mm



Included wired remote controller.

Rated flow rate	250m ³ /h			350m ³ /h			500m ³ /h			800m ³ /h			1000m ³ /h						
Models	FY-250ZDY8R			FY-350ZDY8R			FY-500ZDY8R			FY-800ZDY8R			FY-01KZDY8R						
																			
	E-High	High	Low	E-High	High	Low	E-High	High	Low	E-High	High	Low	E-High	High	Low				
Power source	220V / 240V / 50Hz			220V / 240V / 50Hz			220V / 240V / 50Hz			220V / 240V / 50Hz			220V / 240V / 50Hz						
Heat exchange ventilation	E-High	High	Low	E-High	High	Low	E-High	High	Low	E-High	High	Low	E-High	High	Low				
Input power	112,00 / 128,00	108,00 / 123,00	87,00 / 96,00	182,00 / 190,00	178,00 / 185,00	175,00 / 168,00	263,00 / 289,00	204,00 / 225,00	165,00 / 185,00	387,00 / 418,00	360,00 / 378,00	293,00 / 295,00	437,00 / 464,00	416,00 / 432,00	301,00 / 311,00				
Air volume	250	250	190	350	350	240	500	500	440	800	800	630	1000	1000	700				
External static pressure	105	95	45	140	60	45	120	60	35	140	110	55	105	80	75				
Sound power	30,00 / 31,50	29,50 / 30,50	23,50 / 26,50	32,50 / 33,00	30,50 / 31,00	22,50 / 25,50	36,50 / 37,50	34,50 / 35,50	31,00 / 32,50	37,00 / 37,50	36,50 / 37,00	33,50 / 34,50	37,50 / 40,50	37,00 / 39,50	33,50 / 36,50				
Temperature exchange efficiency	75	75	77	75	75	78	75	75	76	75	75	76	75	75	79				
Normal ventilation	E-High	High	Low	E-High	High	Low	E-High	High	Low	E-High	High	Low	E-High	High	Low				
Input power	112,00 / 128,00	108,00 / 123,00	87,00 / 96,00	182,00 / 190,00	178,00 / 185,00	175,00 / 168,00	263,00 / 289,00	204,00 / 225,00	165,00 / 185,00	387,00 / 418,00	360,00 / 378,00	293,00 / 295,00	437,00 / 464,00	416,00 / 432,00	301,00 / 311,00				
Air volume	250	250	190	350	350	240	500	500	440	800	800	630	1000	1000	700				
External static pressure	105	95	45	140	60	45	120	60	35	140	110	55	105	80	75				
Sound power	30,00 / 31,50	29,50 / 30,50	23,50 / 26,50	32,50 / 33,00	30,50 / 31,00	22,50 / 25,50	37,50 / 38,50	37,00 / 38,00	31,00 / 32,50	37,00 / 37,50	36,50 / 37,00	33,50 / 34,50	39,50 / 40,50	39,00 / 39,50	35,50 / 36,50				
Temperature exchange efficiency	—	—	—	—	—	—	—	—	—	—	—	—	—	—	—				
Dimension	HxWxD	mm			270 x 882 x 599			317 x 1050 x 804			317 x 1090 x 904			388 x 1322 x 884			388 x 1322 x 1134		
Net weight	kg	29			49			57			71			83					

This noise of the product is the value which was measured at the acoustic room. Actually, in the established condition, that undergo influence by the echoing of the room and so that become bigger than the display numerical value. The input, the current and the exchange efficiency are values at the time of the mentioned air volume. The noise level shall be measured 1,5m below the centre of the unit. The temperature exchange efficiency averages that of when cooling and when heating.

Rating Conditions: Cooling Indoor 27°C DB / 19°C WB, Cooling Outdoor 35°C DB / 24°C WB, Heating Indoor 20°C DB, Heating Outdoor 7°C DB / 5°C WB. (DB: Dry Bulb; WB: Wet Bulb)
Specifications subject to change without notice. For detailed information about ErP / Energy Labelling, please visit our websites www.aircon.panasonic.eu or www.gtc.panasonic.eu.

Heat Recovery with DX Coil

Panasonic launches an heat recovery solution for greater energy efficiency.

Panasonic's heat recovery solution performs well in extreme weather conditions and can achieve up to 77% efficiency (63% in enthalpy efficiency).

The counter-flow heat exchanger reduces the air conditioning load, enabling customers – typically owners of hotels, restaurants and other large commercial buildings – to reduce their energy consumption and save on the cost of maintaining comfortable room temperatures.

Energy efficiency

As the latest example of Panasonic's continued commitment to developing unbeatable, energy-efficient air conditioning technologies for commercial applications, the company has introduced a heat recovery device.

The unit features a DX Coil designed to recover up to 77% of the heat from outgoing air, and a air purifying system which helps to improve air quality. In even the most demanding commercial applications, business owners will benefit from the unit's ability to by-pass the heat exchange process when the outside air temperature is cool enough for fresh air to be drawn directly inside (free cooling).

This alleviates the load on the air conditioning equipment and consequently reduces energy bills.



Supply section complete

The supply section comes complete with the DX Coil (using R410A refrigerant) – fitted with a solenoid control valve, freon filter, contact temperature sensors on the liquid and gas line, and NTC sensors on the upstream and downstream airflows. The built-in electric box is equipped with a PCB to control the internal fan speed and to interconnect the outdoor and indoor units, and the ducts are connected by circular plastic collars.

Characteristic curves

The following curves show the unit external static pressure at maximum fan speed for each model.

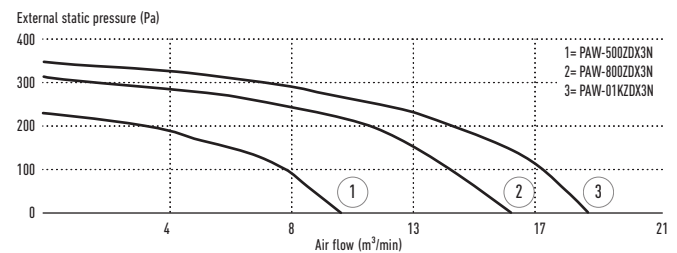

Balanced Ventilation

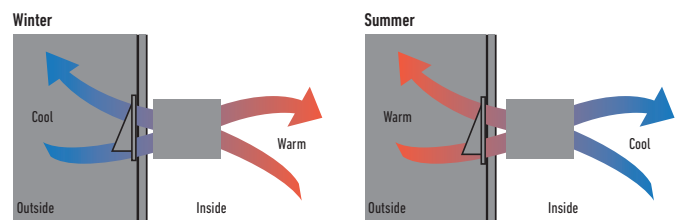

Interconnection

This ventilation unit is connected to an ECOi indoor unit (3,00kW, 4,00kW or 4,50kW) and can be controlled by the easy-to-use ECOi remote controller CZ-RTC5B.

This capability makes the system an excellent choice for hotels, offices (large and small), educational settings and other buildings requiring different temperatures in multiple rooms. The system also integrates easily with building management systems.

Technical focus

- Motorised heat recovery by-pass device automatically controlled by unit control to use fresh air free-cooling when convenient

General characteristics

- Galvanized steel self-supporting panels, internally and externally insulated
- High efficiency enthalpic heat recover, static cross flow type, made by membrane with high moisture permeability, good air tightness, excellent tear resistance, and aging resistance, it is structures with flat plates and corrugated plates. Total heat exchange with temperature efficiency up to 76% and enthalpy efficiency up to 67%, also at high level during summer season



PAW-RE2C4
Optional Controller.
Control for hotel application.



CZ-RTC5B
Optional Controller.
Wired remote controller.
Compatible with Econavi.

- ISO16890 ePm_{2.5} 95% (F9 EN 779) efficiency class filter with synthetic cleanable media and COARSE 50% (G3 EN 779) pre-filter ON fresh air, COARSE 50% filter on return air intake
- Removable side panel to access filters and heat recovery in the event of scheduled maintenance
- Low consumption, high efficiency & low noise direct driven fans
- Supply section complete with DX Coil (R410A) fitted with solenoid control valve, freon filter, contact temperature sensors on liquid and gas line, NTC sensors upstream and downstream airflow
- Built-in electric box equipped with PCB to control internal fan speed and to interconnect outdoor/indoor units
- Duct connection by circular plastic collars
- CZ-RTC5B Timer remote controller (option)

Interconnection to outdoor/indoor units

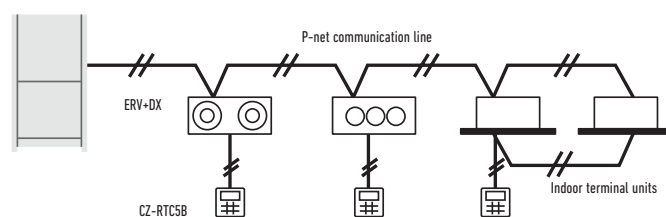

Model	PAW-500ZDX3N		PAW-800ZDX3N		PAW-01KZDX3N			
Power source	Voltage	V	230	230	230	230		
	Phase		Single Phase	Single Phase	Single Phase	Single Phase		
	Frequency	Hz	50	50	50	50		
Air volume		m ³ /min	8,33	13,33	16,66	16,66		
External static pressure ¹		Pa	90	120	115	115		
Maximum current	Total full load		A	0,6	1,4	2,1		
Input power		W	150	320	390	390		
Sound pressure ²			dB(A)	39	42	43		
Piping connections	Liquid pipe	Inch (mm)	1/4 (6,35)	1/4 (6,35)	1/4 (6,35)	1/4 (6,35)		
	Gas pipe	Inch (mm)	1/2 (12,70)	1/2 (12,70)	1/2 (12,70)	1/2 (12,70)		
Heat recovery			Cooling	Heating	Cooling	Heating	Cooling	Heating
Temperature efficiency		%	76	76	76	76	76	76
Enthalpy efficiency		%	63	67	63	65	60	62
Saved power summer mode or winter mode*		kW	1,70	4,30 (4,80)	2,50	6,50 (7,30)	3,20	8,20 (9,00)
DX Coil								
Total / Sensible capacity		kW	3,00 / 2,10	2,50 / 2,70	5,10 / 3,50	4,40 / 4,80	5,80 / 4,10	5,20 / 6,70
Off temperature		°C	15,9	28,0 (27,3)	15,5	29,6 (29,0)	16,2	28,5 (27,8)
Off relative humidity		%	90	16 (15)	90	14 (13)	89	15 (14)

Nominal summer conditions: Outside air: 32°C DB, RH 50%. Ambient air: 26°C DB, RH 50%. Nominal winter conditions: Outside air: -5°C DB, RH 80%. Ambient air: 20°C DB, RH 50%. Cooling mode air inlet condition: 28.5°C DB, RH 50%; evaporating temperature 7°C. Heating mode air inlet condition: 13°C DB, RH 40% (11°C DB, RH 45%); condensating temperature 40°C. DB: Dry Bulb; RH: Relative Humidity.

1) Referred to the nominal air flow after filter and plate heat exchanger. 2) Sound pressure level calculated at 1m far from: ducted supply exhaust air ducted return - first air intake / service side, at normal condition. * Tentative data.

SELF-DIAGNOSING

AUTOMATIC FAN

HUMIDITY CONTROL DRY

AUTOMATIC RESTART

BUILT-IN DRAIN PUMP

OPTIONAL WLAN

BMS CONNECTIVITY

INTERNET CONTROL: Optional

DIMENSIONS AND TUBE SIZES OF BRANCHES AND HEADERS FOR ECOi 2-PIPE SYSTEMS

Optional Distribution Joint Kits

See the installation instructions packaged with the distribution joint kit for the installation procedure.

Model name	Cooling capacity after distribution	Remarks
1. CZ-P680PH2BM	68,00kW or less	For outdoor unit
2. CZ-P1350PH2BM	From 68,00kW to 168,00kW	For outdoor unit
3. CZ-P224BK2BM	22,40kW or less	For indoor unit
4. CZ-P680BK2BM	From 22,40kW to 68,00kW	For indoor unit
5. CZ-P1350BK2BM	From 68,00kW to 168,00kW	For indoor unit

Tube size (with thermal insulation)

1. CZ-P680PH2BM: For outdoor unit side (Capacity after distribution joint is 68,00kW or less).

Gas tubing

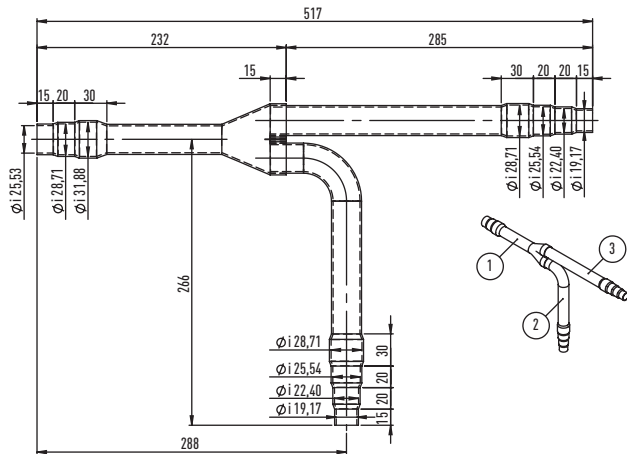

Liquid tubing

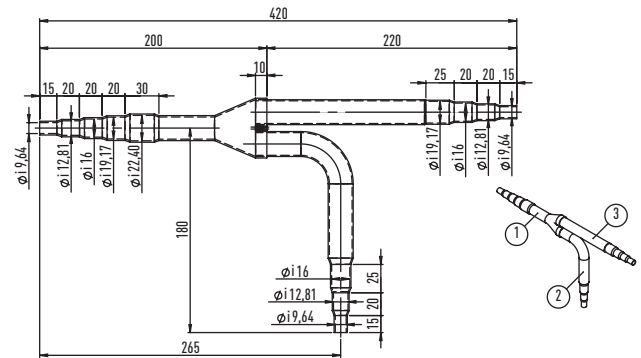

Unit: mm

2. CZ-P1350PH2BM: For outdoor unit side (Capacity after distribution joint is greater than 68,00kW and no more than 168,00kW).

Gas tubing

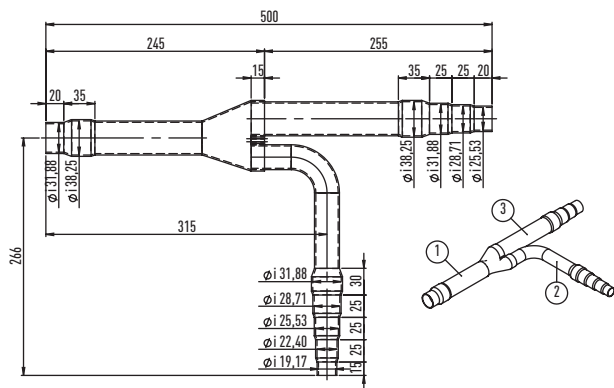

Liquid tubing

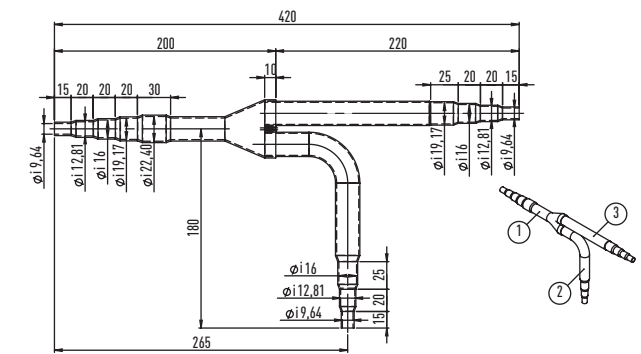

Unit: mm

3. CZ-P224BK2BM: For indoor unit side (Capacity after distribution joint is 22,40kW or less).

Gas tubing

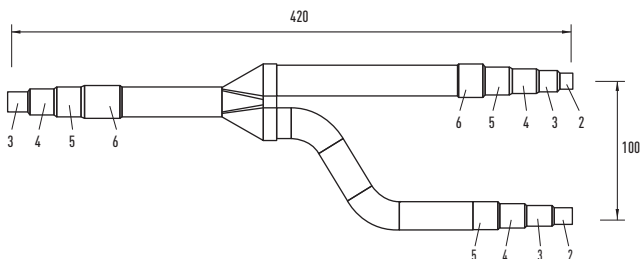

Liquid tubing

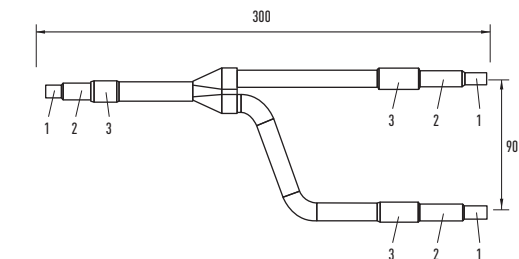

Unit: mm

4. CZ-P680BK2BM: For indoor unit side (Capacity after distribution joint is greater than 22,40kW and no more than 68,00kW).

Gas tubing

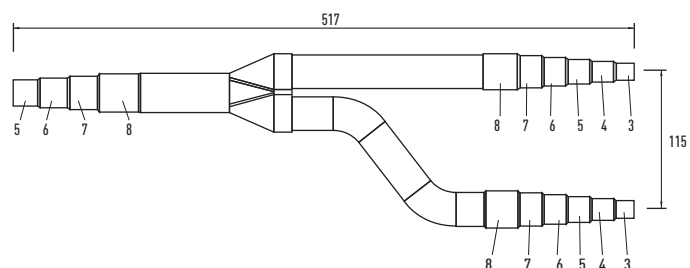

Liquid tubing

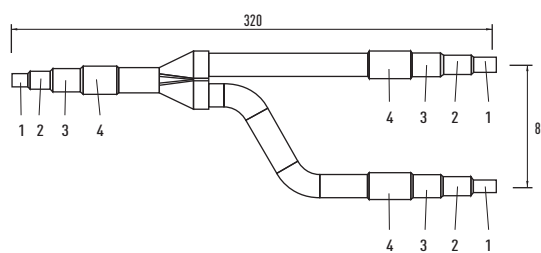

Unit: mm

5. CZ-P1350BK2BM: For indoor unit side (Capacity after distribution joint is greater than 68,00kW and no more than 168,00kW).

Gas tubing

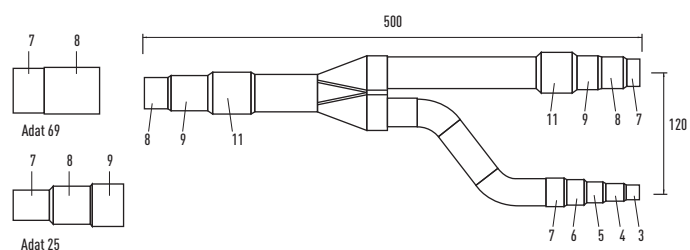

Liquid tubing

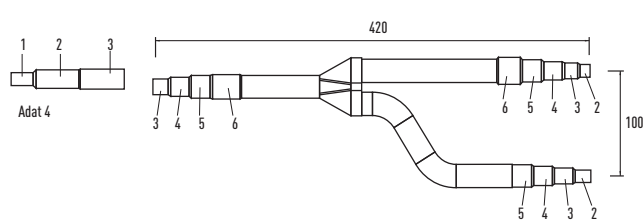

Unit: mm

Diameters		Diameters		Diameters	
1	6,35 mm 1/4"	6	22,40 mm 7/8"	11	38,10 mm 1 1/2"
2	9,52 mm 3/8"	7	25,40 mm 1"	12	41,28 mm 1 5/8"
3	12,70 mm 1/2"	8	28,57 mm 1 1/8"	13	44,45 mm 1 3/4"
4	15,88 mm 5/8"	9	31,75 mm 1 1/4"	14	50,80 mm 2"
5	19,05 mm 3/4"	10	34,92 mm 1 3/8"		

Header pipe set for ECOi 2-Pipe system

CZ-P4HP4C2BM: Header pipe models for 2-Pipe systems.

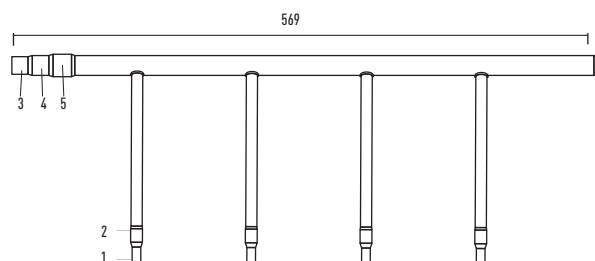
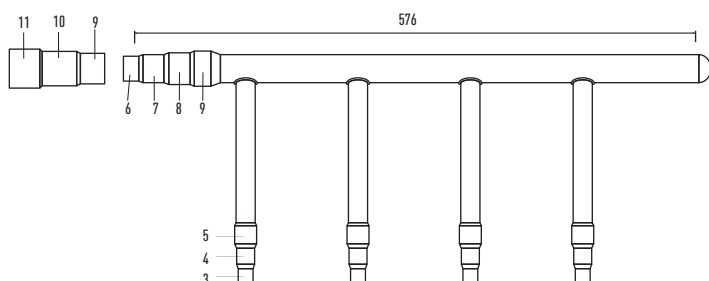

Diameters		Diameters		Diameters	
1	6,35 mm 1/4"	5	19,05 mm 3/4"	9	31,75 mm 1 1/4"
2	9,52 mm 3/8"	6	22,40 mm 7/8"	10	34,92 mm 1 3/8"
3	12,70 mm 1/2"	7	25,40 mm 1"	11	38,10 mm 1 1/2"
4	15,88 mm 5/8"	8	28,57 mm 1 1/8"		

BRANCHES AND HEADERS FOR 3-PIPE ECOi AND MINI ECOi

Optional distribution joint Kits for 3-Pipe ECOi EX MF3 Series

See the installation instructions packaged with the distribution joint kit for the installation procedure.

* In case the total capacity of indoor units connected after distribution exceeds the total capacity of the outdoor units, select the distribution piping size for the total capacity of the outdoor units.

Model name	Cooling capacity after distribution	Remarks
1. CZ-P680PJ2BM	68,00kW or less	For outdoor unit
2. CZ-P1350PJ2BM	Greater than 68,00kW and no more than 135,00kW	For outdoor unit
3. CZ-P224BH2BM	22,40kW or less	For indoor unit
4. CZ-P680BH2BM	Greater than 22,40kW and no more than 68,00kW	For indoor unit
5. CZ-P1350BH2BM	Greater than 68,00kW and no more than 135,00kW	For indoor unit

Piping size for 3-Pipe ECOi EX MF3 Series

1. CZ-P680PJ2BM

For outdoor unit side (capacity after distribution joint is 68,00kW or less).

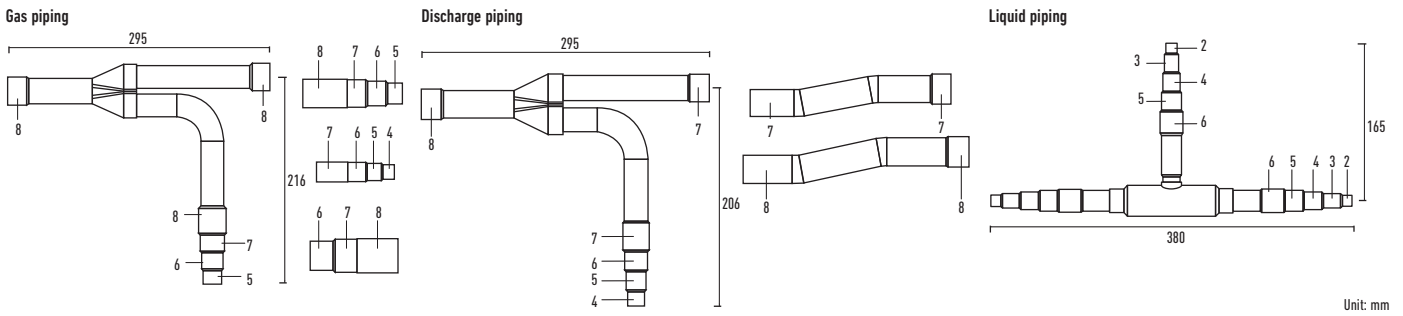

2. CZ-P1350PJ2BM

For outdoor unit side (capacity after distribution joint is greater than 68,00kW and no more than 135,00kW).

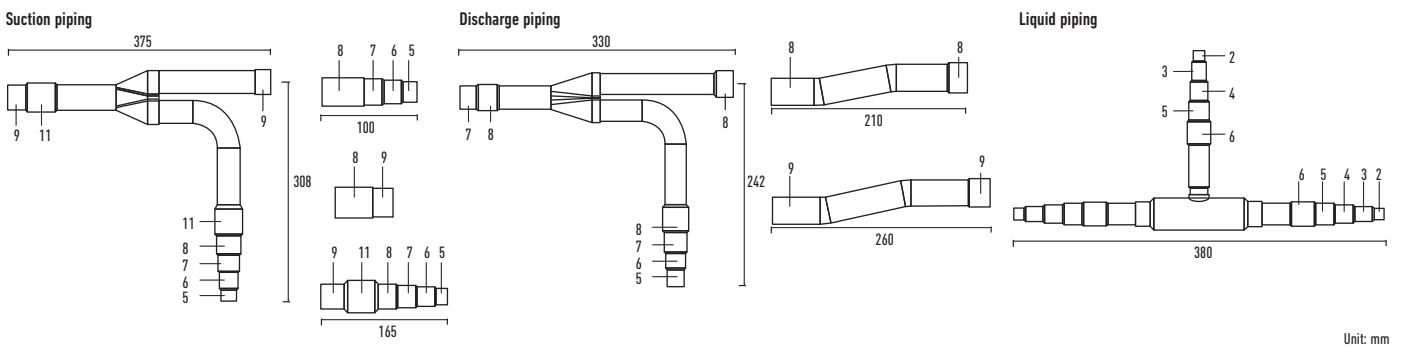

3. CZ-P224BH2BM

For indoor unit side (capacity after distribution joint is 22,40kW or less).

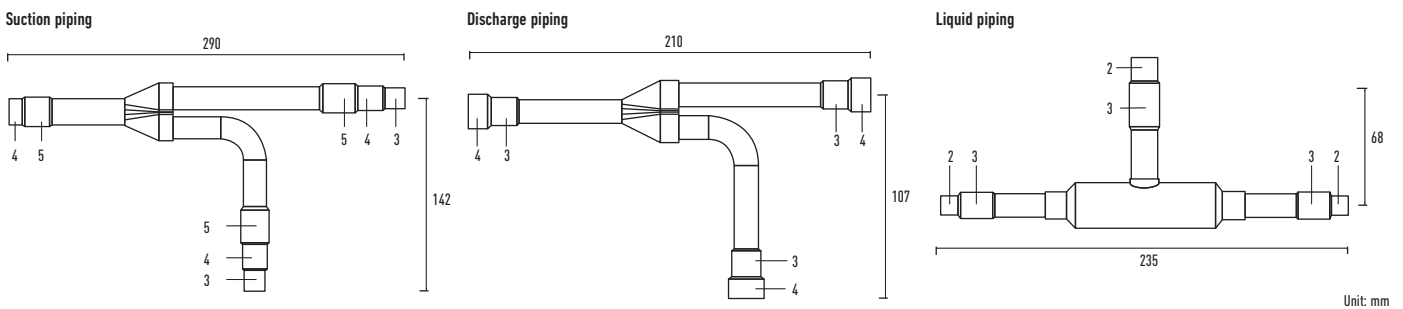

Size of connection point on each part (shown are inside diameters of piping)

Size	Part 1	Part 2	Part 3	Part 4	Part 5	Part 6	Part 7	Part 8	Part 9	Part 10	Part 11	Part 12	Part 13	Part 14
Dimension	mm	6,35	9,52	12,70	15,88	19,05	22,40	25,40	28,57	31,75	34,92	38,10	41,28	44,45
	Inches	1/4	3/8	1/2	5/8	3/4	7/8	1	1 1/8	1 1/4	13/8	11/2	15/8	13/4

4. CZ-P680BH2BM

For indoor unit side (capacity after distribution joint is greater than 22,40kW and no more than 68,00kW).

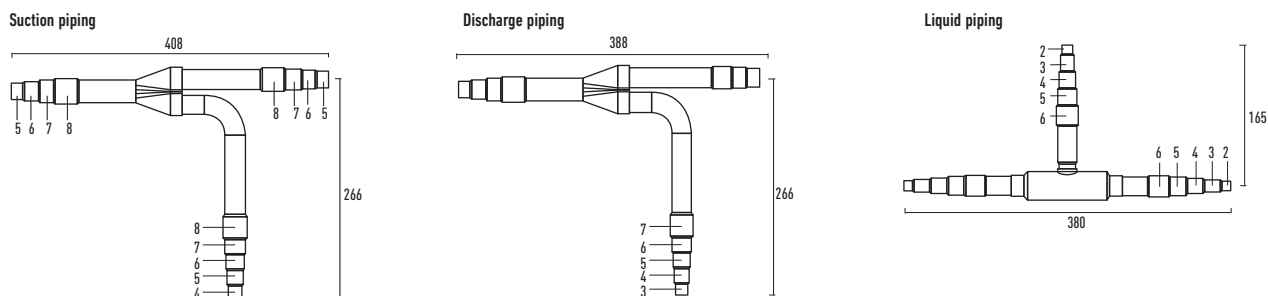

Unit: mm

5. CZ-P1350BH2BM

For indoor unit side (capacity after distribution joint is greater than 68,00kW and no more than 135,00kW).

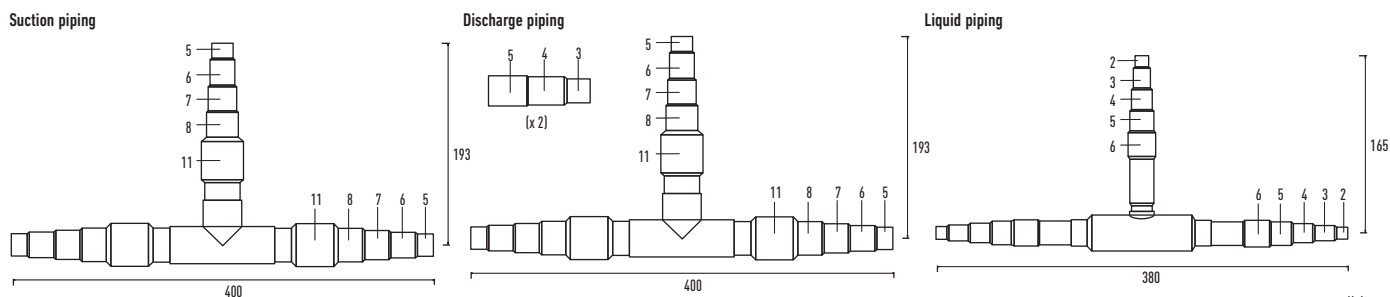

Unit: mm

Header pipe set for 3-Pipe ECOi EX MF3 Series

CZ-P4HP3C2BM

Header pipe model for 3-Pipe systems.

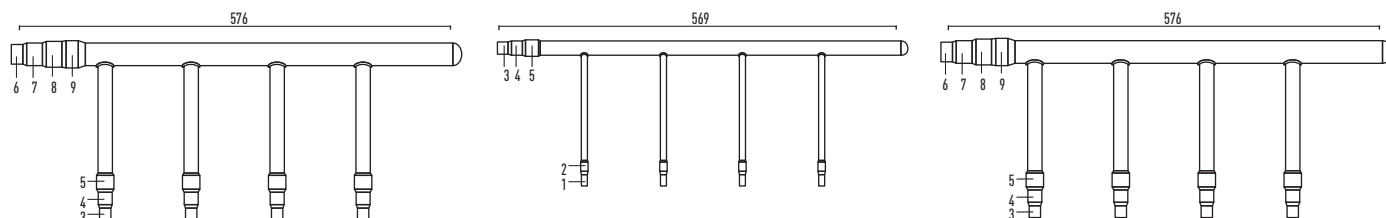

Size of connection point on each part (shown are inside diameters of piping)

Size	Part 1	Part 2	Part 3	Part 4	Part 5	Part 6	Part 7	Part 8	Part 9	Part 10	Part 11	
Dimension	mm	6,35	9,52	12,70	15,88	19,05	22,40	25,40	28,57	31,75	34,92	38,10
	Inches	1/4	3/8	1/2	5/8	3/4	7/8	1	1 1/8	1 1/4	13/8	11/2

Distribution joint Kits for Mini ECOi LE Series

CZ-P160BK2BM

For indoor unit (capacity after distribution joint is 22,40kW or less).

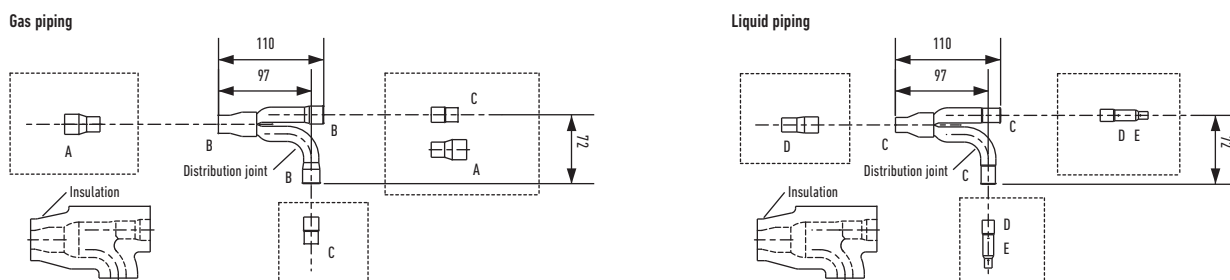

Unit: mm

Size of connection point on each part (shown are inside diameters of piping)

Size	Part A	Part B	Part C	Part D	Part E	
Dimension	mm	19,05	15,88	12,70	9,52	6,35
	Inches	3/4	5/8	1/2	3/8	1/4

ACCESSORIES & CONTROL

Distribution Joint Kits

CZ-P680PH2BM

ECOi 2-Pipe for outdoor unit (68,00kW or less).

CZ-P224BK2BM

ECOi 2-Pipe for indoor unit (22,40kW or less*).

CZ-P1350BK2BM

ECOi 2-Pipe for indoor unit (more than 68,00kW*).

CZ-P1350PJ2BM

ECOi 3-Pipe for outdoor unit (greater than 68,00kW and no more than 135,00kW).

CZ-P680BH2BM

ECOi 3-Pipe for indoor unit (greater than 22,40kW and no more than 68,00kW).

CZ-P160BK2BM

ECOi 2-Pipe and Mini ECOi for indoor unit (22,40kW or less*).

CZ-P1350PH2BM

ECOi 2-Pipe for outdoor unit (more than 68,00kW).

CZ-P680BK2BM

ECOi 2-Pipe for indoor unit (68,00kW or less*).

CZ-P680PJ2BM

ECOi 3-Pipe for outdoor unit (68,00kW or less).

CZ-P224BH2BM

ECOi 3-Pipe for indoor unit (22,40kW or less).

CZ-P1350BH2BM

ECOi 3-Pipe for indoor unit (greater than 68,00kW and no more than 135,00kW).

CZ-P4HP3C2BM

3-Pipe header pipe.

* In case the total capacity of indoor units connected after distribution exceeds the total capacity of the outdoor units, select the distribution piping size for the total capacity of the outdoor units.

Heat Recovery Box

KIT-P56HR3

Box recovery kit up to 5,60kW (CZ-P56HR3 + CZ-CAPE2).

KIT-P160HR3

Box recovery kit from 5,60kW (CZ-P160HR3 + CZ-CAPE2).

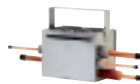

CZ-P56HR3

Heat recovery box up to 5,60kW.



CZ-P160HR3

Solenoid valve kit up to 16,00kW.



CZ-CAPE2

Heat recovery PCB.



CZ-P456HR3

4 ports 3 pipe box up to 5,60kW.



CZ-P656HR3

6 ports 3 pipe box up to 5,60kW.



CZ-P856HR3

8 ports 3 pipe box up to 5,60kW.



CZ-P4160HR3

4 ports 3 pipe box up to 16,00kW.

Panels



CZ-KPU3W

Normal panel for 90x90 Cassette.



CZ-KPU3AW

Econavi panel for 90x90 Cassette.



CZ-KPY3AW

Panel for 60x60 Cassette size 700x700mm.



CZ-KPY3BW

Panel for 60x60 Cassette size 625x625mm.



CZ-02KPL2

Panel for 2 Way Cassette (for S-22 to S-56 models).



CZ-03KPL2

Panel for 2 Way Cassette (for S-73 models).



CZ-KPD2

Panel for 1 Way Cassette.

Individual Controls



CZ-RTC5B

Design wired remote controller with Econavi function.



CZ-RWS3 + CZ-RWRU3

Infrared remote controller for 4 Way 90x90 Cassette.



CZ-RWS3

Infrared remote controller for Wall, 4 Way 60x60 (with CZ-KPY3AW) and Floor Console.



CZ-RWS3 + CZ-RWRD3

Infrared remote controller for 1 Way Cassette.



CZ-RWS3 + CZ-RWR73

Infrared remote controller for Ceiling.



CZ-RWS3 + CZ-RWRC3

Infrared remote controller for all indoor units.



CZ-RWS3 + CZ-RWRL3

Infrared remote controller for 2 Way Cassette.



CZ-RTC2

Standard wired remote controller for Floor Standing (P1).



CZ-RE2C2

Simplified wired remote controller.



CZ-CSRC3

Temperature remote sensor.

Controller and touch controllers for Hotels with Dry Contacts



PAW-RE2C3-WH-1

Stand-Alone with I/O, White.



PAW-RE2C4-MOD-WH

NEW Modbus RS-485 touch room controller with I/O, White.

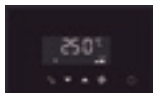

PAW-RE2D4-WH

NEW Touch display control with 2 inputs, White.

PAW-RE2C3-MOD-WH-1

Modbus RS-485 with I/O, White.

PAW-RE2C4-MOD-BK

NEW Modbus RS-485 touch room controller with I/O, Black.

PAW-RE2D4-BK

NEW Touch display control with 2 inputs, Black.

Hotel sensors for Dry Contacts



PAW-WMS-DC

NEW Wall motion sensor 24V.



PAW-CMS-DC

NEW Ceiling motion sensor 24V.



PAW-24DC

NEW Power supply 24V.



PAW-DWC

NEW Door or window contact.

PAW-WMS-AC

NEW Wall motion sensor AC.

PAW-CMS-AC

NEW Ceiling motion sensor AC.

Centralised Controls



CZ-64ESMC3

System Controller with Schedule timer. Operation with various function from center station.



CZ-ANC3

Central ON/OFF controller, up to 16 groups, 64 indoor units.



CZ-256ESMC3

Simplified load distribution ratio (LDR) for each tenant. Intelligent Controller (Touch screen panel).

Centralised Controls. BMS System. PC Base



CZ-CSWKC2
PAIMS Basic software.

CZ-CFUNC2
Communication adaptor.



CZ-CSWAC2
PAIMS Consumption calculation control.

CZ-CSWBC2
PAIMS - BACnet interface.

CZ-CSWGC2
PAIMS - Layout display.

CZ-CSWWC2
PAIMS - Web application.

Centralised Controls. Connection with 3rd Party Controller



CZ-CAPDC2
Serial parallel device controlling outdoor units, up to 4 units.



CZ-CAPC3
Adaptor for ON/OFF control of external devices.



CZ-CAPBC2
Mini series parallel device controlling indoor units, maximum 1 group and 8 indoor unit.



CZ-CFUNC2
Communication Adaptor. Up to 128 groups. Controls 128 units.

VRF Smart Connectivity



SER8150R0B1194
Remote Controller Panasonic Net Con, RH, No PIR, R1/R2.



SER8150R5B1194
Remote Controller Panasonic Net Con, RH, PIR, R1/R2.



VCM8000V5094P
Wireless Zigbee Pro module / Green Com card.



SED-WDC-G-5045
Door / window wireless sensor.



SED-MTH-G-5045
Wall / ceiling (motion) wireless sensor.



SED-CO2-G-5045
CO₂ sensor.



SED-TRH-G-5045
Sensor with room temperature and humidity.



Accessories Interfaces



PAW-RC2-KNX-1i
KNX Interface.

PAW-AC-KNX-64
KNX Interface for 64 I_U.

PAW-AC-KNX-128
KNX Interface for 128 I_U.

PAW-AC2-KNX-16P
NEW KNX Interface for 16 I_U.

PAW-AC2-KNX-64P
NEW KNX Interface for 64 I_U.



PAW-AC-BAC-1
BACnet Interface for 1 unit.

PAW-AC-BAC-64
BACnet Interface for 64 I_U.

PAW-AC-BAC-128
BACnet Interface for 128 I_U.

PAW-MBS-TCP2RTU
ModBus RTU Slave devices.



PAW-RC2-MBS-1
Modbus Interface.

PAW-AC-MBS-64
Modbus Interface for 64 I_U.

PAW-TM-MBS-RTU-64
Modbus Interface for 64 I_U.

PA-RC2-WIFI-1
Interface for Intesishome for PACi and ECOi.



PAW-RC2-MBS-4
Modbus interface to control 4 indoor/groups.

PAW-AC-MBS-128
Modbus Interface for 128 I_U.

PAW-TM-MBS-TCP-128
Modbus Interface for 128 I_U.



PAW-AC2-MBS-16P
NEW Modbus Interface for 16 I_U.

PAW-AC2-MBS-64P
NEW Modbus Interface for 64 I_U.

PAW-AC2-MBS-128P
NEW Modbus Interface for 128 I_U.



PAW-AC2-BAC-16P
NEW BACnet Interface for 16 I_U.

PAW-AC2-BAC-64P
NEW BACnet Interface for 64 I_U.

PAW-AC2-BAC-128P
NEW BACnet Interface for 128 I_U.

Panasonic AC Smart Cloud



CZ-CFUSCC1
Panasonic AC Smart Cloud. Cloud internet control. Up to 128 groups. Controls 128 units.

PAW-MVNOAC-V
PAW-MVNOAC-K
3G communication package (SIM Card included). V, K: Depending on countries.

Accessories PCB



PAW-T10
All T10 functions.

PAW-ECF
PCB for fan speed control of external EC Fan.



PAW-PACR3
Redundancy of 2 or 3 systems; for PACi and ECOi.

Accessories Cables



CZ-T10
Cable for all the T10 functions.



PAW-FDC
Cable to operate external EC fan.



PAW-OCT
Cable for all option monitoring signals.

PAW-EXCT
Cable with force Thermo OFF/leakage Detection.

Pump Down System



PAW-PUDME1A-1
ECOi 2-Pipe Pump down for 1 outdoor unit system.

PAW-PUDME1A-2
ECOi 2-Pipe Pump down for 2 outdoor units system.

PAW-PUDME1A-3
ECOi 2-Pipe Pump down for 3 outdoor units system.

PAW-PUDMF2A-1
ECOi 3-Pipe Pump down for 1 outdoor unit system.

PAW-PUDMF2A-2
ECOi 3-Pipe Pump down for 2 outdoor units system.

PAW-PUDMF2A-3
ECOi 3-Pipe Pump down for 3 outdoor units system.

PAW-PUDME1A-1R
ECOi 2-Pipe Pump down for 1 outdoor unit system + Receiver Kit 30L.

PAW-PUDME1A-2R
ECOi 2-Pipe Pump down for 2 outdoor units system + Receiver Kit 30L.

PAW-PUDME1A-3R
ECOi 2-Pipe Pump down for 3 outdoor units system + Receiver Kit 30L.

PAW-PUDMF2A-1R
ECOi 3-Pipe Pump down for 1 outdoor unit system + Receiver Kit 30L.

PAW-PUDMF2A-2R
ECOi 3-Pipe Pump down for 2 outdoor units system + Receiver Kit 30L.

PAW-PUDMF2A-3R
ECOi 3-Pipe Pump down for 3 outdoor units system + Receiver Kit 30L.

PAW-PUDRK30L
Receiver Kit 30L.

Other Accessory



CZ-CNEXU1
nanoe™ X air purifying system for 90x90 Cassette.



CZ-CENSC1
Econavi energy savings sensor.

Fan coil Controller



PAW-FC-303TC
Fan coil control.



PAW-FC-RC1
NEW Wired remote controller.

R-22 Replacement Kit

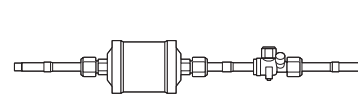

CZ-SLK2
Replacement kit for R-22.



CONTROL AND CONNECTIVITY



Panasonic has developed the largest range of control systems to offer the best option for commercial need. From the individual remote controller for the residential single units up to the newest technology to control each your buildings around the world from an easy to use software in the cloud by your portable device.

VRF SMART CONNECTIVITY+

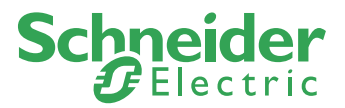

Through thorough energy management, Panasonic's VRF Smart Connectivity is a completely new, state-of-the-art solution providing energy saving and comfort as well as simple installation, operation and running.

VRF Smart Connectivity+ offers efficient energy management and a new air conditioning control solution with high IAQ (Indoor Air Quality).

<p>Energy Management System for Rooms</p>	<p>Each room is monitored by high-precision sensors, making it possible to make every room's temperature comfortable without wasting energy.</p>
<p>Management System for the Entire Building</p>	<p>A Building Energy Management System (BEMS) can also be connected for Plug & Play centralised control of the building's entire energy consumption.</p>

Advantages



Dramatic Reduction of OpEx with Outstanding IAQ.

- 3 Built-in sensors: Temperature, RH and Occupancy
- ZigBee wireless sensors: CO₂ / Temperature / RH%, window / door, ceiling / wall / water leakage
- Relay Pack, Hotel Room Controller



User-/Owner-friendly.

- Colour touch screen
- Ease and simply of use
- 22 Languages
- Easy-to-understand error description



Ultimate Customisation.

- Background colour customisable
- Custom display/icons, messages
- Programmable logic (also stand alone)
- Various controls and various external connection devices



Easy Design and Plug and Play to Reduce CapEx.

- Simple Plug & Play VRF connection to Building Energy Management System (BEMS)
- Stand alone or BEMS connected
- Easy Installation of ZigBee Sensors

VRF Smart Connectivity+: New SE8000.

1 Quality Air Control

Optimum IAQ is realized using the CO₂ and humidity sensors. The interior remains comfortable, while heating and cooling costs are minimized.

The CO₂ sensor controls ventilation systems which contributes to improving the room's air quality.

2 Room Key Card or Key Cardless Solutions for Hotels

Solutions are provided that meet the needs of various regions and hotel grades.

Whilst the previous model's automatic detection function offered optimal air conditioning with or without a hotel room key card, the latest model enables conventional key cards to control air conditioners and other devices coordinately. The increase in the types of devices that can be connected enables customized control of any hotel room.



3 Other Equipment Control

One room controller manages various devices including lighting and the blinds.

A ventilation system and other external connection devices (Dry Contact input) can be connected by HRC or TE2 devices so that various control is possible with this controller alone, even without BEMS.

ENERGY MANAGEMENT SYSTEM FOR ROOMS

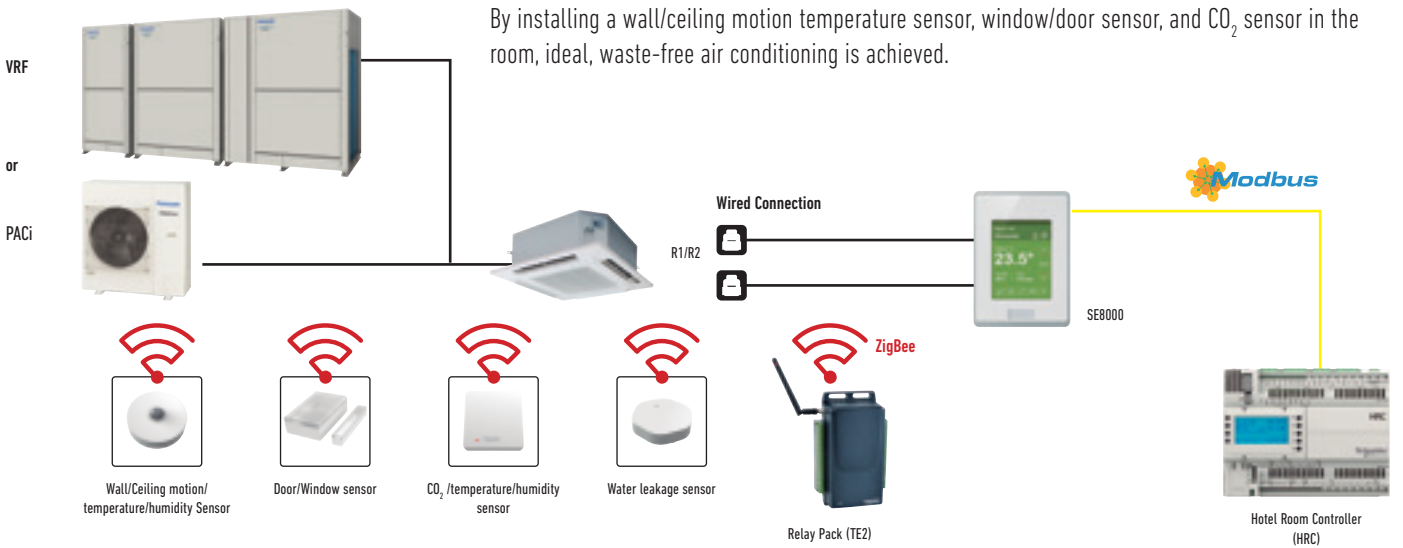

Sensing & Control technology

Using sensors from Schneider Electric, high-quality occupancy control and automatic IAQ control were realised. The sensors detect the presence or absence of occupants, and the opening and closing of doors and windows to achieve the most efficient energy management for exceptional air-conditioned comfort.

Flexible installation is possible to match different applications and building features such as walls, ceilings and proximity to doors and windows. No wiring means extra installation versatility.

Batteries last for up to five years (10-year battery for CO₂ sensor) and are easy to install and replace.

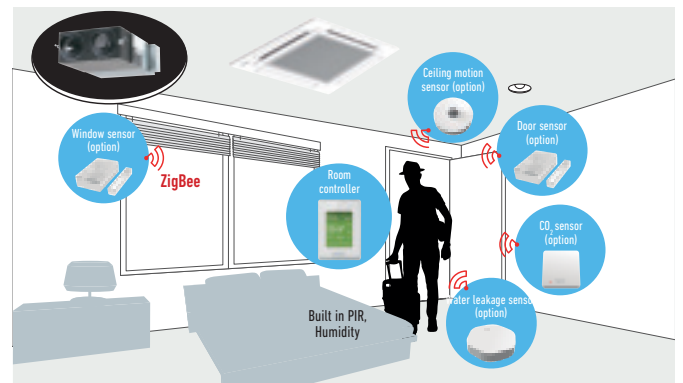

Door/Window sensor
Door and window contact detection sensor to monitor opening and closing.



Wall/Ceiling motion/temperature/humidity Sensor
Wall and ceiling sensor to detect the presence or absence of occupants.



CO₂ /temperature/humidity sensor
Monitor indoor air quality, review data on interfacing devices, and control fresh air inside customizable zones.



Water leakage sensor
Two sensing pads under the body activate when water is present between the two pads. Detecting the water, the sensor reports the event to the controller.



Relay Pack (TE2)
Wireless programmable terminal equipment controllers for HVAC equipment and pulse counting. Includes local memory to store fail safe control sequence.



Hotel Room Controller (HRC)
The Hotel Room Controller controls connected guest room devices and aggregates data, making it visible to guest room and property management systems.

MANAGEMENT SYSTEM FOR THE ENTIRE BUILDING

The smarter solution to simplify energy management, optimise building efficiency and drive savings.

Plug and Play BEMS connection

With the SE8000, connection to BEMS is extremely easy. Better still, a remote controller is all that's needed to enable use as a stand-alone system. In addition to dramatically reducing the burden on system integrators, this cuts costs.

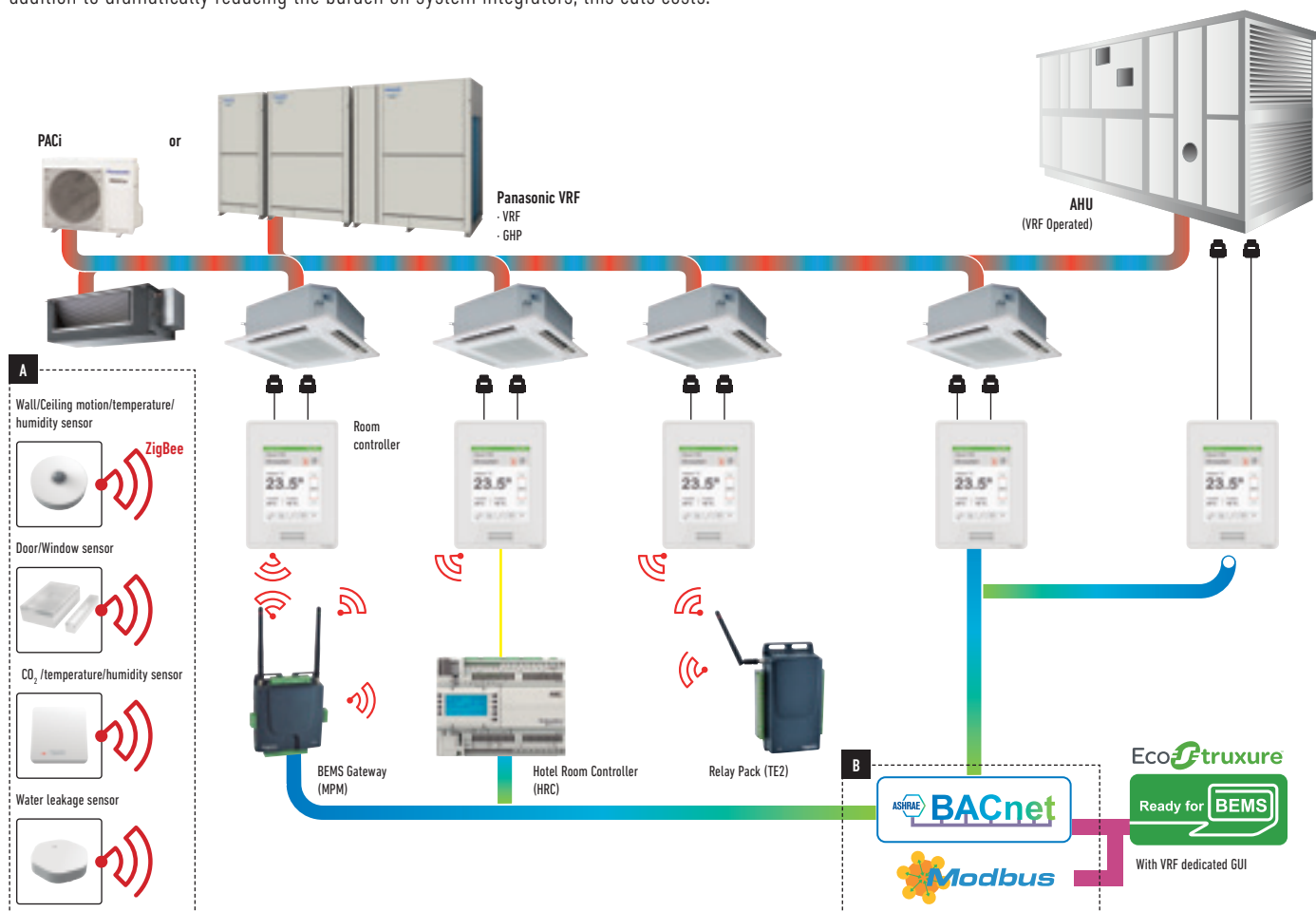

A SE8000 smart controller with direct hub to ZigBee® Pro sensors. Great Occupancy and IAQ control.
Ex: Hotel room occupancy check by PIR sensor, IAQ by CO₂ sensor, Door / Window contacts.

B BACnet MS/TP and Modbus RTU are embedded.

C For Schneider Electric BEMS connection, Panasonic VRF widgets enable easy Plug and Play.

C Better understanding for VRF as a chiller system.

BEMS Gateway (MPM)
Multi-Purpose Management devices enable the control, monitoring, and management of entire sites via Schneider Electric's BMS system.

Schneider Electric BEMS Widget (Exclusive)

* Graphic shows combination of products from Panasonic, Schneider Electric and others. Please consult authorised dealer for more details.

Reference	Description
SER8150R081194	Pana Net Con, RH, No PIR, SE Brand, R1R2
SER8150R5B1194	Pana Net Con, RH, PIR, SE Brand, R1R2
VCM8000V5094P	Wireless ZigBee Pro communication card
TE2*	
SEC-TEA-R-230-5045	Smart Terminal Controller ZigBee Pro High Power, External Antenna, 4U/4AD/5DO, 220-240VAC
SEC-TEA-R-24-5045	Smart Terminal Controller ZigBee Pro High Power, External Antenna, 4U/4AD/5DO, 24VAC

Reference	Description
MPM*	
MPM-UN-014-5045	Universal network controller with Building Expert and StruXureWare integration, High Power, 6 I/6O, Modbus
MPM-RAEC-5045	Universal network controller Cable extension
HRC*	
HRCEP14R	Hotel Room Expansion Module 14 indoor units
HRCPB628R	Hotel Room Controller 28 indoor units
HRCPD642R	Hotel Room Controller w/Display 42 indoor units

Reference	Description
ZigBee Sensors	
SED-CO2-G-5045	Sensor with room CO ₂ , temperature and humidity
SED-TRH-G-5045	Sensor with room temperature and humidity
SED-WDC-G-5045	Door/window sensor
SED-MTH-G-5045	Wall/ceiling motion/temperature/humidity sensor
SED-WLS-G-5045	Water leakage sensor

* Those accessories require system integrator support on site.

SMART MANAGEMENT SOLUTIONS

1 Hotels

Room Key Card or Key Cardless Solutions for Hotels.

The SE8000 and ZigBee Sensor automatic detection function offer optimal air conditioning regardless of whether there is a hotel room key or not. Sensors detect the presence or absence of occupants and the opening and closing of doors and windows for the optimum air-conditioned environment guests expect. Automatic control ensures the most efficient operation when guests are away or when windows are open. This contributes to an appreciable reduction in operation costs.



1. Remote sensing & IAQ control.

In addition to detecting a room's temperature, humidity and CO₂ concentration, ZigBee remote sensors detect the opening/closing of windows and doors, and the presence/absence of people in a room. Various IAQ controls and detailed energy savings are possible by using TE2 (Relay Pack) based on this detected information.

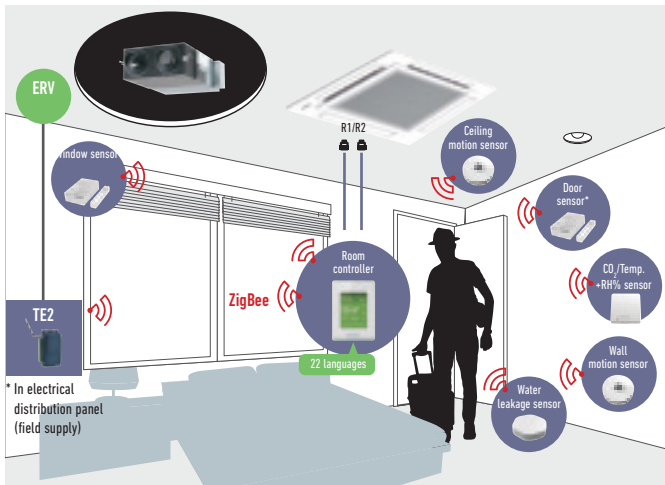

2. BEMS Connectivity.

With MPM as the BEMS gateway and by setting HRC as the guestroom controller, sensing, control and BEMS connection can be realized in coordination with SE8000!

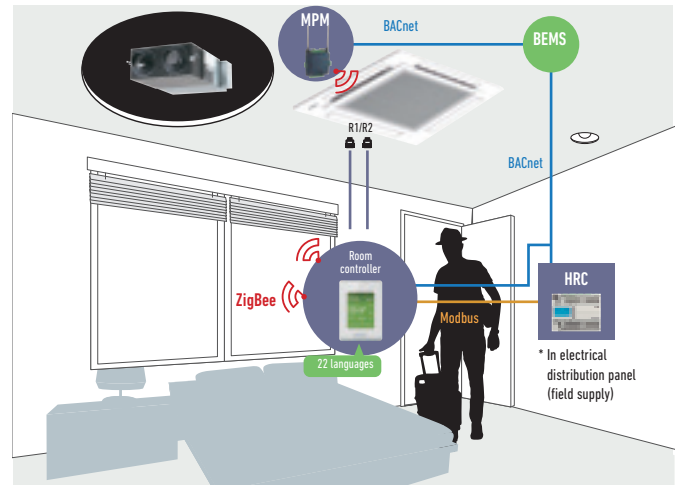

3. Key Cardless control.

The introduction of TE2 and HRC enables conventional wired keycards to be connected to the system so that it is possible to meet the specific requirements of various hotel and room types.

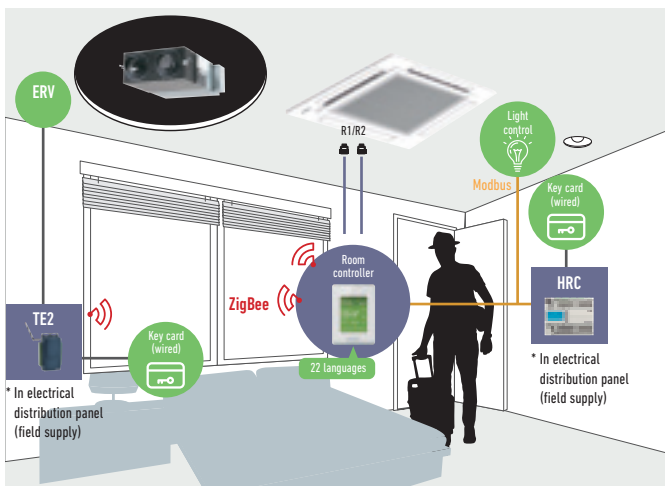

4. Other control

The introduction of TE2 and HRC enables the ON/OFF control of devices having Dry Contact input, such as ventilation, lighting and blinds.

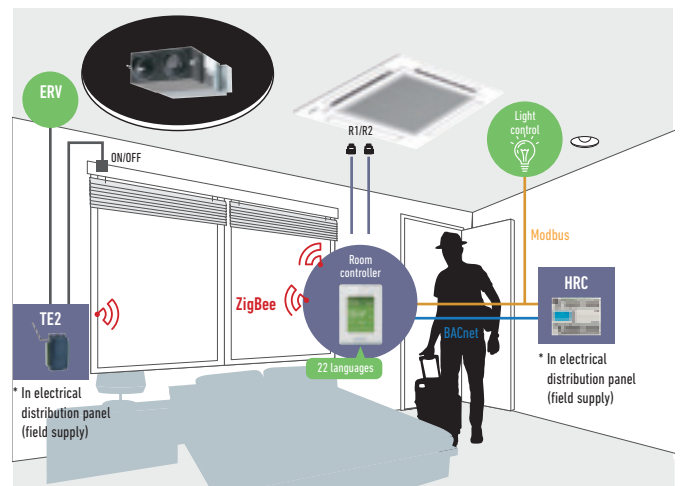

2 Small and medium offices

CO₂ sensors (option) and Humidity sensors.

CO₂ sensors (option) take measurements in units of ppm, and humidity sensors enable fine air quality control. This creates the most comfortable space for occupants while contributing to improved employee satisfaction.



3 Super markets

Humidity sensors.

Humidity sensors enable automatic dehumidification for the optimum IAQ regardless of climatic conditions. This creates an even more comfortable environment for customers, employees, and products themselves.



Innovative and unrivalled advantages

Colour and design to match office interiors.

Colour combinations and design can be set to match different facilities.



Easy-to-understand error description.

Error description during an emergency is easy to understand, enabling staff to respond quickly.



Customisation in 22 languages possible.

The display can be customised to match the native languages of guests to enable smooth, stress-free communication for hospitality at its finest.



Programmable logic.

Full customisation of remote controller logic possible, and updating to match conditions.

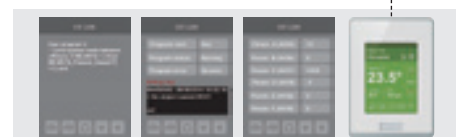



Smart connectivity devices

	SED-WDC-G-5045 Door/window sensor		SED-MTH-G-5045 Wall/ceiling motion/temperature/humidity sensor
	SED-CO2-G-5045 CO ₂ temperature/humidity sensor		SED-WLS-G-5045 Water leakage sensor



ZigBee communication card
VCM





Schneider Electric
brand - SE8000

*With optional VCM communication card.

Features

- Up to 5-year battery life batteries included
- Battery life of CO₂ sensor up to 10-year.
- Battery level is a point
- Sensor points visible when SE8000 is integrated via BACnet MS/TP
- Sensor status and battery level visible when SE8150 is integrated via ZigBee® Pro
- Integration to BMS only recommended when each MPM is connected to Ethernet and set as a ZigBee® Coordinator node

PANASONIC AC SMART CLOUD

With Panasonic AC Smart Cloud, have your business under control, and start saving!



Flexible solution and scalable solution

- Energy saving
- Zero downtime
- Site(s) management

Centralize control of your business premises, from wherever you are, 24/7/365. It doesn't matter how many sites you have, or where they are! The AC Smart Cloud system from Panasonic allows you to have complete control of all your installations, from your tablet or from your computer. In a simple click, all your units from several locations, receive status updates in real-time of all your installations, preventing breakdowns and optimizing costs.

Flexible solution for your business.



Every time



Everywhere



Multiplatform



Internet browser

Scalable solution for your business.



Small to large



1 to multi sites



Upgrade features*

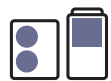

PACi / ECOi / ECO G

* Customized to meet user demand / Continuous upgrades: new functions and product introductions / IT smart management.

Panasonic AC Smart Cloud offers continuous improvement always thinking about users

New e-CUT function

E-CUT functions are newly available in Panasonic AC Smart Cloud. 5 energy saving settings reduces automatically its energy consumption.

1. Set temperature auto return.

When you want to return to the set temperature after a certain time even if the temperature is changed.

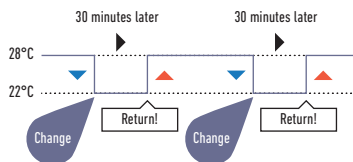

2. Unattended auto shut OFF.

When you want to operate outside of a schedule but to monitor and stop automatically.

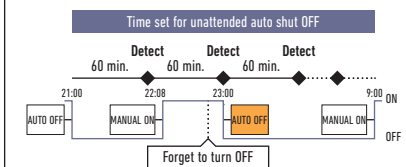

3. Set temperature range limit.

When you want to limit the temperatures that can be set.

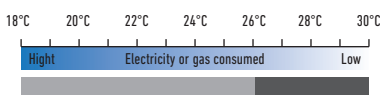

Reduced consumption of electricity or gas by over cooling.

Set temperature restricted to the range between 26°C and 30°C.

4. Energy saving timer / Efficient operation setting.

Specify time slots when you want operation capacity reduced.

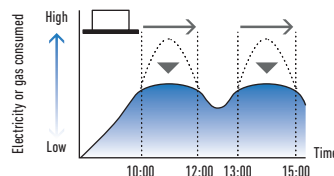

5. Demand / peak shaving settings/ Peak cut settings.

Specify time slots when you want operation capacity of the outdoor units reduced.

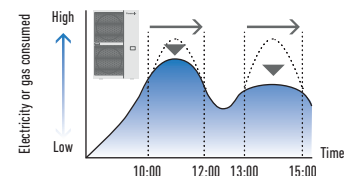

Key functions and uniqueness

Multi site monitoring.

- It doesn't matter how many sites you have, easy to manage, operate, compare sites, locations, rooms.



Schedule setting.

- Yearly / weekly / holiday timer setting as you want



Powerful statistics for energy savings.

- Power consumption, capacity, efficiency level can be compared with different parameters (Yearly / monthly / weekly / daily bases)



Maintenance notification.

- Error notification by email and with floor layout
- Maintenance notification of ECOi / ECO G outdoor units
- Remote service checker function



User customization¹.

Site administrator can create users as desired and assign customized profiles.

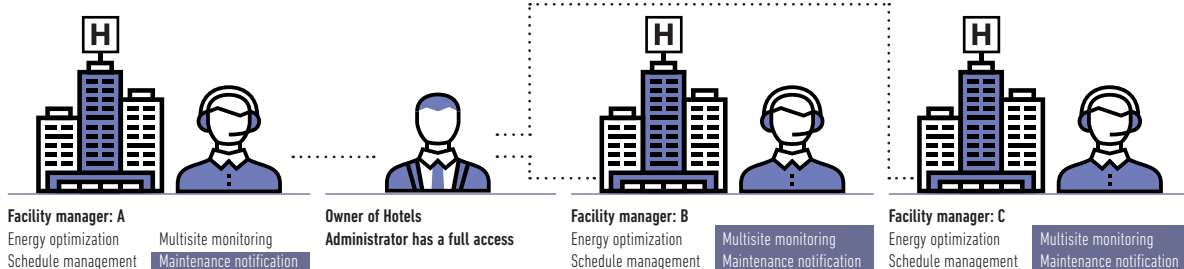

Main functions per user type

Function / Main Tab	Sub-Tab	Basic type (Eg.: Owners, facility managers)	Professional type (Eg.: Installers, maintenance companies)
AC setting	I, U / O, U operation details	✓	✓
	Cloud adapter (CZ-CFUSCC1) details	✓	✓
	AC maintenance	✓	✓
	Map view	✓	✓
Energy saving function	NEW e-CUT	✓	✓
Schedule	Yearly, weekly schedule setting / view	✓	✓
	Power consumption	✓	✓
Powerful statistics	Capacity	✓	✓
	Efficiency ranking	✓	✓

Function / Main Tab	Sub-Tab	Basic type (Eg.: Owners, facility managers)	Professional type (Eg.: Installers, maintenance companies)
Maintenance function	Notification overview / details	✓	✓
	Maintenance settings	✓	✓
	Map view	✓	✓
	Remote service checker	✓	✓
User account ¹	New / update user registration	✓	✓
	Distribution group overview / details	✓	✓
System setting	Cut OFF request	✓	✓
	Map editor	✓	✓

One of our uniqueness is "Stable and secured communication package"

- Connectivity is included in the service. Customers do not have to take time to find and prepare suitable connectivity.
 - With an all inclusive service offering, the customer has peace of mind and a one stop shop for all AC Smart Cloud issues they may face including connectivity
- This reduces installation time, requiring no integration with existing IT network infrastructure.



Remote service checker function



Zero down time

- Quick analysis & response
- Time & Cost saving for service maintenance task

Recording service checker parameters from wherever you are!

- Data duration: Max. 120 minutes
- Data frequency: 10 – 90 seconds
- Mode selection: With test run or Without test run
- Count down schedule setting available

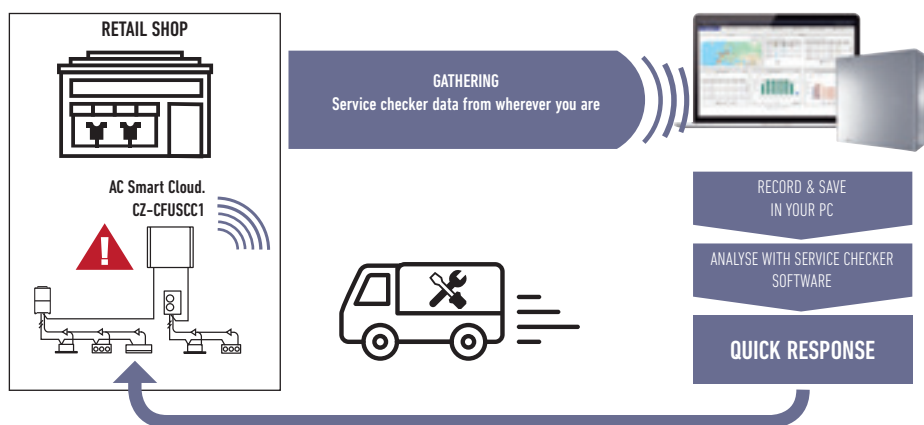

Panasonic AC Smart Cloud parts lists

* Cloud service fee is additionally required. Please contact an authorized Panasonic dealer.

CZ-CFUSCC1	AC Smart Cloud communication adaptor. Up to 128 groups. 128 units control
PAW-MVNOAC-V	3G communication package (SIM Card included). V, K: Depending on countries ¹
PAW-MVNOAC-K	

1) Please contact an authorized Panasonic dealer.

NEW COMMERCIAL WLAN ADAPTOR

NEW
2019



Panasonic

Download on the
App Store

ANDROID APP ON
Google play

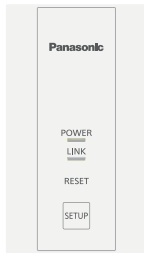

New Panasonic CZ-CAPWFC1 interface adaptor, allows connection of one or a group of indoor units to be managed by the Panasonic Comfort Cloud App, which provides control, monitoring, scheduling and error alerts.

Advanced smartphone control

Control PACi, ECOi and ECO G units from wherever and whenever with your smartphone, by using Panasonic Comfort Cloud App and Commercial WLAN Adaptor. This scalable solution is ideal for one system, one site or multiple locations. Coupling the adapter with the already feature rich systems, makes it an ideal solution for residential and commercial applications.

1 From 1 to 200 units

User can control up to 10 different sites, with up to 20 units / groups per site.

2 1 indoor or 1 group

One simple WLAN adaptor CZ-CAPWFC1 can be connected to 1 indoor or to a group of indoors (maximum 8 indoors).

3 Multi user

The Panasonic Comfort Cloud App allows multi-user access control. Restrict user access to specific units.

4 Easy scheduling

Complex weekly scheduling made simple. Not only for one units, but across multiple sites and from a smartphone.

5 Energy monitor

See the estimated power consumption and compare with other periods to see how energy consumption can be reduced even more. Check list of units that provides consumption*.

* Function available depending on the model.

6 Error codes

Error code notification through the App, provides early notification and allows for faster repair.

Commercial WLAN Adaptor for internet control - CZ-CAPWFC1

Commercial WLAN Adaptor wiring length is 1,9m and connects to indoor unit thru T10 connector and R1/R2 terminal connectors.

Indoor Unit

Other hardware requirements (purchase and subscribe separately)

Download free App

Input Voltage	DC 12V (supplied from T10 connector)	Wireless LAN Standard	IEEE 802.11 b/g/n
Power Consumption	Maximum 2,4W	Frequency Range	2,4GHz band
Size (H x W x D)	120 x 70 x 25mm	Operation range	0 ~ 55°C, 20 ~ 80RH%
Weight	190g (including communications lines)	Connectable indoor unit	1 unit
Interface	1 x Wireless LAN	Length of communication line	1,9m (included in the shipment)

Cloud control is available for all indoor units with P-link

Compatible type: Model code starting with "S-" except S-80/125MW1E5.

Incompatible type: Model code starting with "PAW-", "FY-" and S-80/125MW1E5.

Basic wiring diagram

If there is one indoor unit or if there are multiple indoor units, connect one WLAN adaptor and one remote controller. A remote controller must be connected and it should be set as the "main unit" in the main-sub remote controller settings.

Example when there is 1 indoor unit.

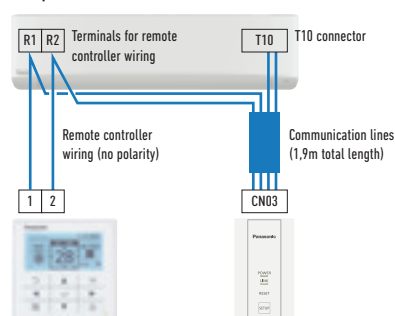

Example when there are multiple indoor units.

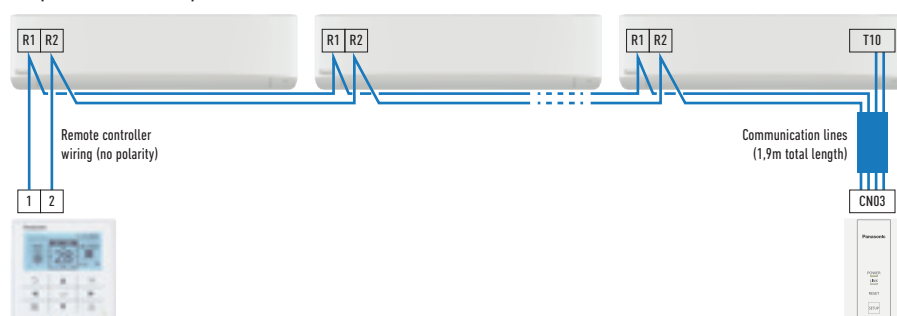

NEW BMS INTERFACE WITH P-LINK

NEW
2019



New BMS interface with Panasonic communication bus helps you to get significant savings.

In addition to reducing the time of configuration and installation, the potential mistakes can be avoided.

Easy to use and reliable interfaces for a straightforward integration.



Modbus®



1 Direct connection to P-Communication bus

- No need additional gateway (CZ-CFUNC2)
- Significant 50% of cost saving for BMS interface*
- Reduce time of configuration and avoid potential mistakes

* In the case of PAW-AC2-BAC-16P by Panasonic calculation.

2 Upgraded specifications and easy configuration

- Base PCB board with MCU, Ethernet, RS485, RS232 & USB
- Configuration by IP or USB
- New single configuration tool for all models (IntesisBox MAPS)
- Modular expansion PCBs (KNX, RS485, DALI, MBUS, LON, ANYBUS)

3 BTL certified for BACnet

- BACnet: Version 14 and BTL certified

Direct connection to P-Communication bus

New interface can provide faster, cheaper, easier solution in your projects!

Conventional interface

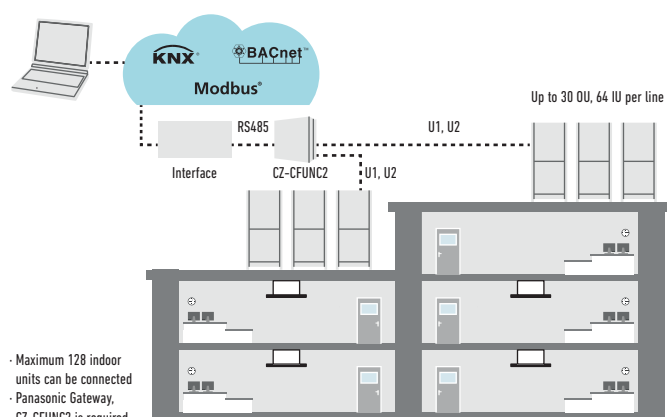

NEW Interface with P-communication bus

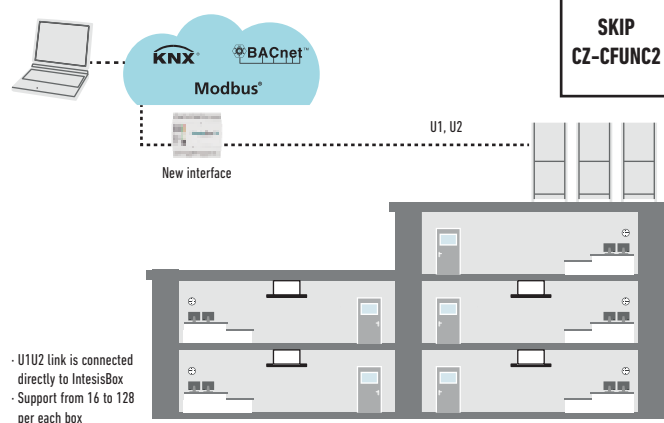

Key upgrade

- Base PCB board with MCU, Ethernet, RS485, RS232 and USB
- Modular expansion PCBs (KNX, RS485, DALI, MBUS, LON, ANYBUS)
- Frontal PCB with all Leds buttons and USB console Port
- New single configuration tool for all models (IntesisBox MAPS)
- Recovery of current configuration project working
- USB port will allow to store logs without PC
- Configuration by IP or USB (old generation RS232)



Model for BACnet	Maximum number of indoor units connected
PAW-AC2-BAC-16P	16 indoor units
PAW-AC2-BAC-64P	64 indoor units
PAW-AC2-BAC-128P	128 indoor units
Model for Modbus	Maximum number of indoor units connected
PAW-AC2-MBS-16P	16 indoor units
PAW-AC2-MBS-64P	64 indoor units
PAW-AC2-MBS-128P	128 indoor units
Model for KNX	Maximum number of indoor units connected
PAW-AC2-KNX-16P	16 indoor units
PAW-AC2-KNX-64P	64 indoor units

Version	Connectable indoor units	Connectable outdoor units	Nr. of P-Communication bus Port
16	1-16	1-16	1
64	1-64	1-30	1
128	128 (1-64/P-Communication bus Port)	60 (1-30/P-Communication bus Port)	2

REMOTE CONTROLLER WITH ECONAVI



Easy to use, attractive, clear design, with new demand control functions and energy consumption display! This useful feature makes this remote controller unique!

Design

The CZ-RTC5B wired remote controller is ideal for integration into the most demanding interior architectures. The touch panel features a very sleek and easy to use display, which with its compact display is only 120 x 120 x 16mm.

Display of information

The information is mainly based on pictograms to ensure easy understanding. The minimal amount of text is available in 6 languages (English / German / French / Spanish / Italian / Polish). The screen is back lit to enable reading even during the night.

Key Functions

- Easy setup of the timer and settings of the indoor unit
- Energy consumption display (for all R32 PACi line-up)
- Limitation of the energy consumption (Demand control) by timer.

Easy Access to the menus.

With the new pictograms, the navigation, the selection and the settings are simple and easy to follow.

Basic function (Operation display & indication)

- All functions are easily available on the remote controller.
- OFF/ON timer · Weekly timer · Quiet operation · Remote controller sensor · Operation prohibit · Filter sign · Energy saving · Centralized control indication · Mode change prohibit · Automatic temperature return · Temperature range limitation · OFF remind · Schedule demand control · Ventilation · Out Function

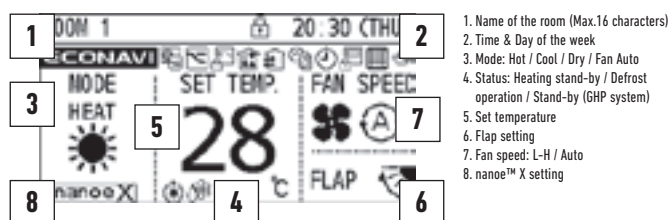

1. Name of the room (Max.16 characters)
2. Time & Day of the week
3. Mode: Hot / Cool / Dry / Fan Auto
4. Status: Heating stand-by / Defrost operation / Stand-by (GHP system)
5. Set temperature
6. Flap setting
7. Fan speed: L-H / Auto
8. nanoe™ X setting

Easy operation and quick access to all menus

1. Set temperature will be selected, when any arrow button is touched
2. Select the item (Mode or Fan speed) by left/right ◀▶ key
3. Change the setting by up/down ▲▼ key



Example of easy access to the functions: Air direction setting

1. Select "Air direction" and press "Enter" key
2. Select the unit number by up/down ▲▼ key
3. Select the flap position by up/down ▲▼ key
4. Press "Return" key to go back the Menu display



Backup control by using CZ-RTC5B

Group wiring of 2 systems of PACi can do auto individual control: Rotation operation, Backup operation and Support operation.

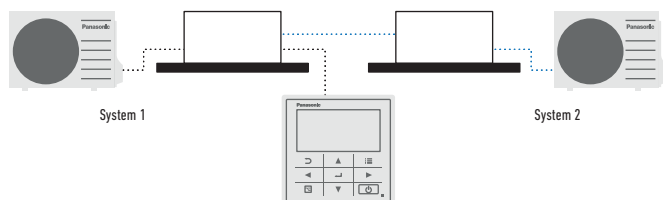

Functions available on the CZ-RTC5B

Control item	Controllability	Indoor Units		
		PACi Standard	PACi Elite	All VRF
Basic Operation	Operation, Mode, Temperature setting, Airflow volume, Airflow direction	✓	✓	✓
	Time display	✓	✓	✓
Timer function	Easy ON/OFF timer	✓	✓	✓
	Weekly Program timer	✓	✓	✓
	Outing function	✓	✓	✓
	Temperature auto return	✓	✓	✓
Energy saving	Temperature setting range limitation	✓	✓	✓
	OFF remind	✓	✓	✓
	Energy saving mode	✓	✓	✓
	Schedule demand control	✓ ¹⁾	✓	✓
	Energy monitoring - R32	✓	✓	—
Maintenance	System failure information	✓	✓	✓
	Service contact registration	✓	✓	✓
	Filter sign (rest time display) & Reset	✓	✓	✓
	Auto-address, Test run	✓	✓	✓
	Sensor value monitor	✓	✓	✓
	Simple / Detail setting mode	✓	✓	✓
	Key lock	✓	✓	✓
Others	Ventilation fan control	✓	✓	✓
	Display contrast adjustment	✓	✓	✓
	Remote controller sensor	✓	✓	✓
	Quiet operation mode	✓ ¹⁾	✓	—
	Prohibit setting control from Central controller	✓	✓	✓

All specifications subject to change without notice. 1) PACi Standard R410A line up is not available.

DATANAVI

FAST
AND
INTUITIVE

EASY
ACCESS TO
MANUAL
DATABASE

ACCURATE
SERVICE DATA
ON YOUR
SMARTPHONE



datanavi

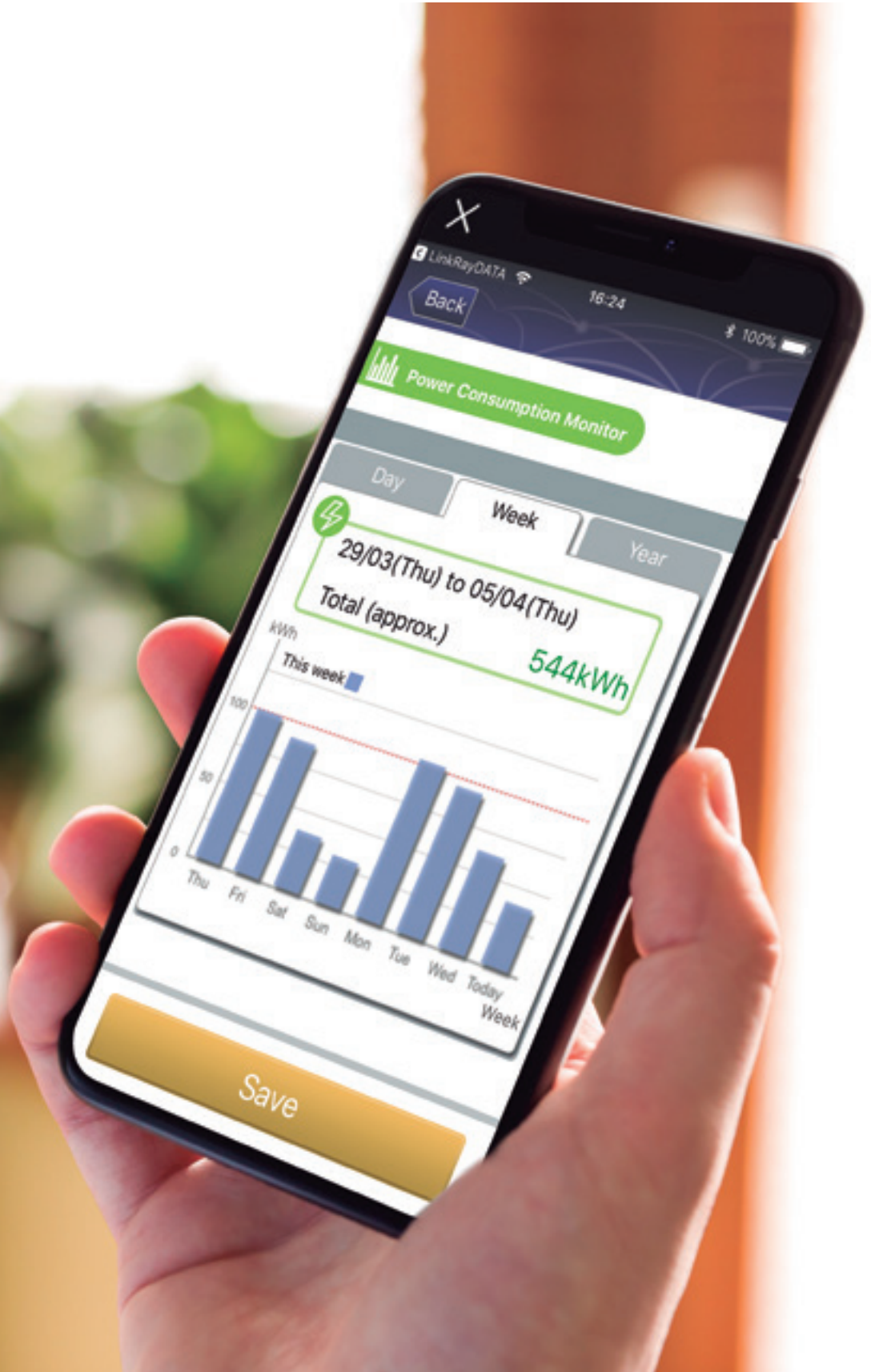

Datanavi, a new way to connect.
Simple and easy support tool with your smartphone.



Overview of datanavi system

Just holding up your smartphone to the LED display on a remote controller (CZ-RTC5B) to receive useful AC system information super fast by Panasonic Light ID Technology. Datanavi also connects to Panasonic Cloud Server for the quick view of manuals, saving data received by Light ID.



What is the Light ID technology developed by Panasonic?
Visible light transmission technology, which enables to transmit information by high-speed and invisible flashing of an LED light source.

Key Functions

- Scan & Save AC system info
- Easy access to manual database
- Commissioning, F gas check data history

User / Administrator (person in charge of AC) functions

- **Fast and intuitive.** Regular operation data, Energy consumption data display
- **Easy access to data base.** Getting manuals related on demand
- **No idea what to do when an error happens?** You can share error information and contact service easily



Installer / Service company functions

- **Getting technical data depends on your need**
Service manual, Q & A list, Test run information
- **Accurate error information**



Regular operation

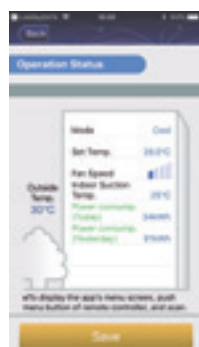

Energy management

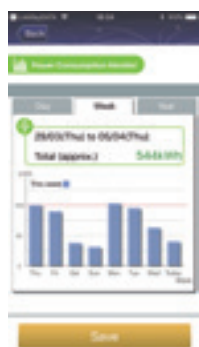

Malfunction notice

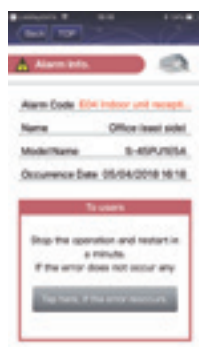

Operating manual



Test run info



Service data



* User interface image may be updated without notification.

- Simple F-gas regulation check list
- Repair speed check list

Download free apps, try datanavi!
2 free apps are necessary to use datanavi.

ECONAVI SENSOR



The all Econavi Sensor detects presence in the room, and quietly adapts the PACi or VRF air conditioning system in order to improve comfort and energy savings.

- Detects human activity and adjusts temperature by 2 degrees (up or down) to optimize comfort and efficiency
- If there is no activity detected for a set time, the Econavi will stop the unit or move to a new temperature previously set
- The Econavi device is installed independently of the indoor unit, and is located in the area best suited for detection

Applications

Saving Energy for Offices: if the air conditioning is left on after the last employee leaves the office, Econavi will automatically react, reducing or stopping the system.

Increased comfort in hotel rooms: when presence is detected in the room, the temperature is automatically adjusted to achieve best comfort.

Key points

- Compatible with Cassette, Wall Mounted, Hide Away and Ceiling
- Improves efficiency
- Better Comfort
- Can be installed in the best place of the room for detection purposes

Sensor location image

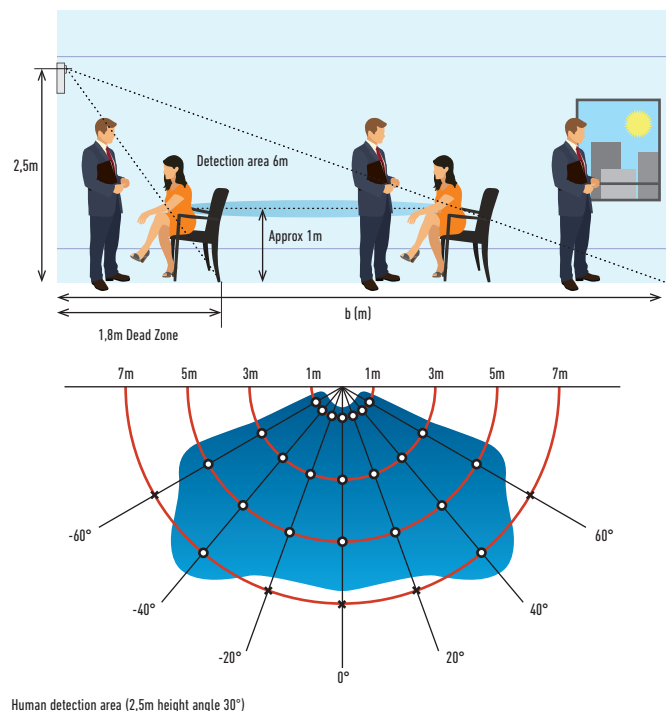

Human detection area (2.5m height angle 30°)

Providing outstanding energy-saving performance, Panasonic's Inverter system can be connected to Econavi to detect when energy is being wasted. Econavi senses the presence or absence of people and the level of activity in each area of an office. When unnecessary heating or cooling is detected, indoor units are individually controlled to match office conditions for energy-saving operation.

Detection of the level of activity enables precise power saving.

Presence or absence of people at their desks and the level of activity in the office are detected in real time. Set temperature is automatically adjusted to optimise the lower power consumption.



Remote Econavi sensor allows optimum energy operation.

Pillars, walls, cabinets and other fittings obstruct the sensor, reducing the area of detection and lowering the energy-saving effect. Taking into consideration blind spots, Panasonic enables the optimum layout for sensors in any office.



In the morning.
Thorough cooling when there is a high level of activity

In the afternoon.
Reduced cooling when there are fewer people

At night.
Automatic Thermo OFF depending on conditions at the end of the day

INTELLIGENT CONTROLLER



This controller is the smart solution for your advanced requirement in buildings.

Intuitive operation

The screens used for operations all follow a common pattern, with the screens being easy to read and easy to use.

- Enlarged screen (10,4 inch) with colour LDC
- Smartphone-like operations (Swiping, flicking)

Large screen display. Enlarged by 60%.



Easy Swipe or flick operation.

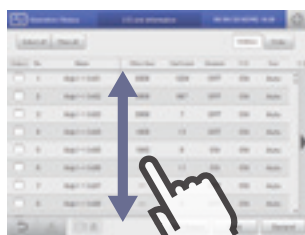

Swipe.
This is an operation where the finger is slid in a direction (up or down) on the touch panel. This is used to scroll slowly.

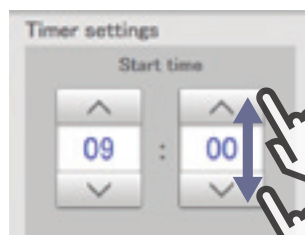

Select.
This is an up and down movement of the finger touching the screen, used to pick settings in elements such as spin boxes.



Pull out.
This is an operation where the finger on the touch panel is flicked in a direction (up or down). This is used to scroll quickly.

Enhanced functions for energy saving as standards

- Set temperature auto return settings, Auto shut OFF, Set temperature range limit settings
- Demand control function

Screen of Set temperature auto return setting.

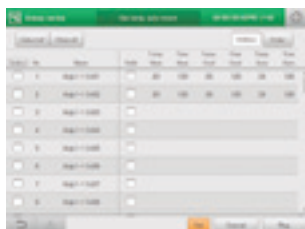

Auto shut OFF.



Screen of Outdoor demand control.



- Outdoor demand input and timer settings possible
- Indoor can be set at $\pm 1^{\circ}\text{C}$ / $\pm 2^{\circ}\text{C}$ or thermostat OFF
- Indoor units controlled in sequence at 10-minute intervals

Energy Visualization

- Energy-saving plans are supported with graph display function
- Displays electricity & gas usage distribution

Screen of graph display.

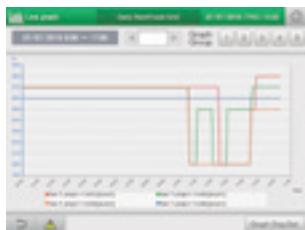

Useful parameters are shown for your better energy saving.
Ex.) Bar graph:

- Indoor unit: Total operating time, thermostat ON operation time (Min.)
Amount used (electricity, gas)
Electricity or gas charges
- Outdoor unit: Outdoor unit operation cycles (# cycles)
Engine time in operation (Hrs.)
Cumulative Inverter power output
Cumulative PV power output

Pulse value selection per different data intervals 1 hour/1 day/ 1 month compared with last year.

Main function

Gesture function (Flick, Swipe)	✓
Graph display (Trends, comparisons)	✓
Web functions (Max. 64 users)	✓
Recipient setting for warning email	✓ (Maximum 8)
Automatic return to setting temperature	✓
Limitation of setting temperature range	✓
Left-on prevention	✓
Quiet operation of outdoor unit	✓
Occupant sensor linkage	✓
Demand function	✓
Charge calculation	✓
Log display	Warning 10.000 items Status change 50.000 items
Linked control	✓
Event definition 50 events, Input: 32, Output: 32	✓
Under maintenance (Under inspection registration)	✓

NEW CONTROLLER FOR HOTEL APPLICATION

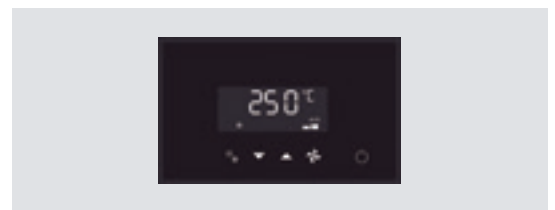
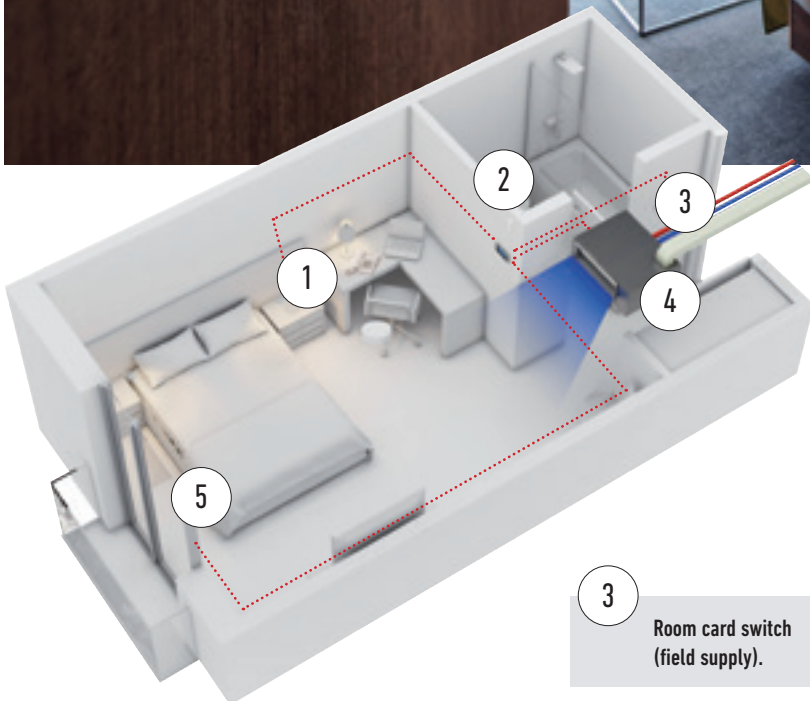
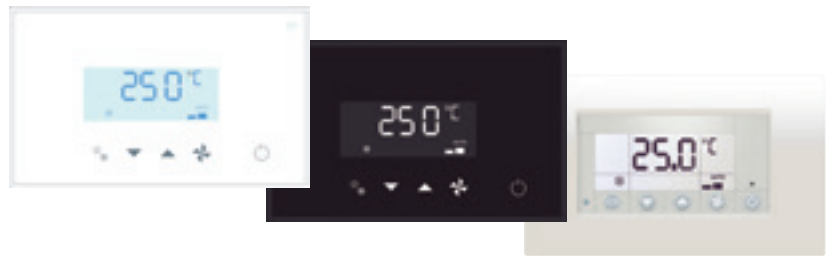

3
Room card switch (field supply).

Controller to integrate all room hotel needs in one device.
Card switch. Heating and cooling control. Light control. Window control. Possible to connect to Modbus.



1
Lighting control.

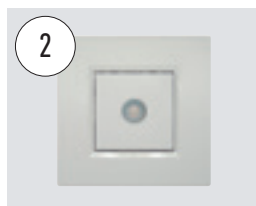

2
Wall sensor PAW-WMS-AC (-DC).

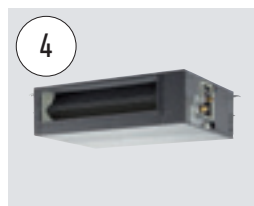

4
Indoor unit. Variable static pressure hide away.



5
Window contact PAW-DWC.

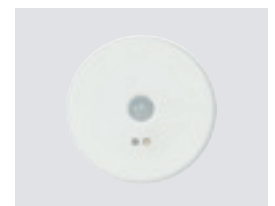

5
Ceiling motion sensor PAW-CMS-AC (-DC).

Innovative line up of room controllers specially designed for hotel applications. With a modern cosmetic that match room interiors and simple operation for hotel guests.

- Easy to install
- Cost effective installation as all electrical cable are centralized on this remote: The lighting, card contact, motion detector, window contact and the air conditioning are controlled
- Architect inspired attractive design with 2 colors: black or white
- Stand-Alone and Modbus

Energy saving functions included on the device: Turns OFF air conditioning and lighting when room is unoccupied. Disables air conditioning when window is open. Maximum/minimum setpoint temperature configurable.

Easy remote controller: The hotel guest will have access to limited functions to control the air conditioning: ON/OFF, Temperature and Fan speed.

Easy set up: Stand-Alone model with easy configuration menu to access all parameters. A pre-define scenario can be uploaded on the remote controller connected to a computer to make installation on site plug and play (only on the Modbus models).

New NFC fast set up: with the new Touch Display Control and Touch Room Controller setting are quicker than ever. Just touching smartphone with NFC capability the settings will be saved. This function is also possible even when the control is not wired. Giving flexibility to save the setting even before installation.

Type	Model	Colors	Digital inputs	Digital output	BMS	Inst. set up	T. Sensor
Touch display controller	PAW-RE2D4-WH	White	2			NFC	Built-in
	PAW-RE2D4-BK	Black	2			NFC	Built-in
Touch room controller	PAW-RE2C4-MOD-WH	White	4	4	Modbus	NFC	Built-in
	PAW-RE2C4-MOD-BK	Black	4	4	Modbus	NFC	Built-in
Room controller	PAW-RE2C3-WH-1	White	4	4		Buttons	Built-in
	PAW-RE2C3-MOD-WH-1	White	4	4	Modbus	Buttons	Built-in

Room Controller: 4 Digital Inputs & 4 Digital Output

Room controller offers flexibility and easy installation thanks to 4 preconfigured options. This is available in both Stand Alone and Modbus type. Modbus references: PAW-RE2C4-MOD-WH, PAW-RE2C4-MOD-BK, PAW-RE2C3-MOD-WH-1. Stand Alone references: PAW-RE2C3-WH-1.

Wiring configuration example for Option 2 in Modbus type.

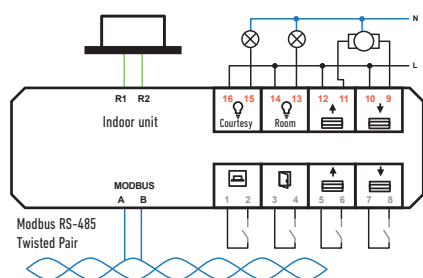

Configurations	4 options available I/O configurations: Inputs				Available I/O Configurations: Outputs			
	Digital 1-2	Digital 3-4	Digital 5-6	Analog 7-8	Relay 15-16	Relay 13-14	Relay 11-12	Relay 9-10
Option 1	Card	Window	Lighting	Temperature	Courtesy	Lighting	Not used	Valve actuator
Option 2	Card	Window	Blinds up	Blinds down	Courtesy	Lighting	Blinds up	Blinds down
Option 3	Motion sensor	Window	Door contact	Temperature	Courtesy	Lighting	Not used	Valve actuator
Option 4	Lighting	Window	Blinds up	Blinds down	Not used	Lighting	Blinds up	Blinds down

Display: 2 Digital Inputs

Display control allows to handle 2 inputs to perform most common operation in room hotels.

References: PAW-RE2D4-WH, PAW-RE2D4-BK.

Wiring example for Display Controller.

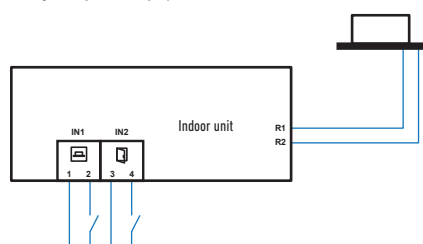

Configurations	3 options available: Inputs	
	IN1 (1-2)	IN2 (3-4)
Option 1	Card	Window
Option 2	Motion sensor	Window
Option 3	Motion sensor	Door contact

Hotel Room Controller

PAW-RE2C4-MOD-WH	Modbus RS-485 Touch room controller with I/O, White
PAW-RE2C4-MOD-BK	Modbus RS-485 Touch room controller with I/O, Black
PAW-RE2C3-MOD-WH-1	Modbus RS-485 room controller with I/O, White
PAW-RE2C3-WH-1	Stand -Alone room controller with I/O, White
PAW-RE2D4-WH	Touch display control with 2 Inputs, White
PAW-RE2D4-BK	Touch display control with 2 Inputs, Black

Accessories Sensors

PAW-WMS-DC	Wall silent motion sensor 24V
PAW-WMS-AC	Wall silent motion sensor AC
PAW-CMS-DC	Ceiling silent motion sensor 24V
PAW-CMS-AC	Ceiling silent motion sensor AC
PAW-24DC	Power supply 24V
PAW-DWC	Door or window contact

CONTROL AND CONNECTIVITY

Centralized Control Systems

BMS System. PC Base



CZ-CSWKC2
P-AIMS. Basic Software
Up to 1024 groups. Controls 1024 units.

Connection with 3rd Party Controller



CZ-CAPDC2
Seri-Para I/O unit for outdoor unit.
Up to 4 outdoor units.



CZ-CAPC3
ON/OFF control for external devices such as ERV.
Controls 1 unit.

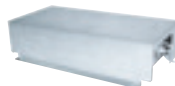

CZ-CAPBC2
Mini Seri-Para I/O Unit 0 - 10V.
Controls 1 indoor unit or a group of 8 indoor units.



CZ-CFUNC2
Communication Adaptor.
Up to 128 groups. Controls 128 units.

AC Smart Cloud



CZ-CFUSCC1
Cloud internet control.
Up to 128 groups. Controls 128 units.

Domestic integration to P-Link - CZ-CAPRA1

Can connect all ranges to P-Link. Full control is now possible.

Integrates any unit in big system control

- TKEA / PKEA Server room integration
- Small offices with Domestic indoors
- Tender for refurbishment (old system Domestic and VRF in one installation)

Centralized Control Systems: 64 Indoor Units

Intelligent Controller / Web Server: 256 Indoor Units

P-AIMS: 1024 Indoor Units

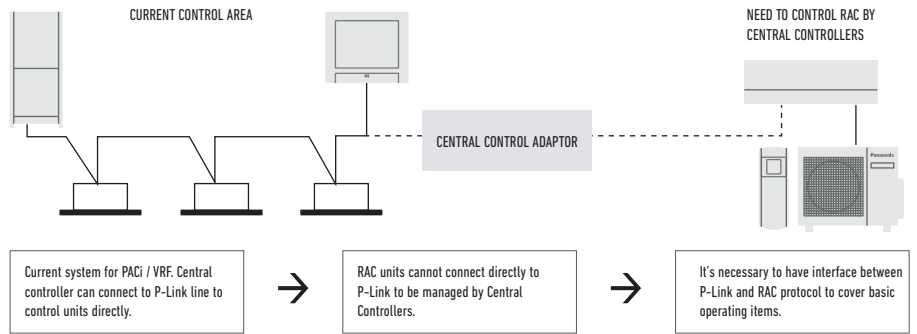

Basic operation items

ON/OFF	✓
Mode select	✓
Temperature setting	✓
Fan speed	✓
Flap setting	✓
Remote controller prohibit	✓

External input

ON/OFF control signal	✓
Abnormal stop signal	✓
External output for Relay¹	
Operation status (ON/OFF)	✓
Alarm status output	✓



1) Because current CN-CNT connector can not provide the power for external output relay, additional Input power for external relay is necessary.

Easy connection to KNX, Modbus, LonWorks and BACnet

Great flexibility for integration into your KNX / Modbus / LonWorks / BACnet projects allows fully bi-directional monitoring and control of all the functioning parameters.

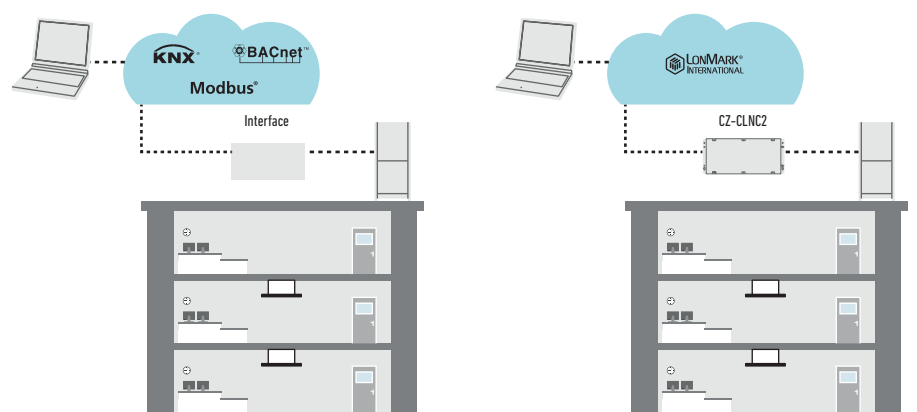
For more information, contact Panasonic.



			Econavi control	Built-in thermostat	Indoor units which can be controlled	Use limitations	Function ON/OFF	Mode setting	Fan speed setting	Temperature setting	Air flow direction	Permit/Prohibit switching	Weekly program	BMS protocol
Individual Controllers														
Touch room controller for Hotel with Dry Contacts		PAW-RE2C4-MOD-WH PAW-RE2C4-MOD-BK WH: White, BK: Black	-	✓	1 indoor unit	-	✓	✓	✓	✓	-	✓	-	Modbus + 4 Digital I/O Signals
Room controller for Hotel with Dry Contacts		PAW-RE2C3-WH-1 PAW-RE2C3-MOD-WH-1 White	-	✓	1 indoor unit	-	✓	✓	✓	✓	-	✓	-	Stand Alone or Modbus + 4 Digital I/O Signals
Touch display control for Hotel with Dry Contacts		PAW-RE2D4-WH PAW-RE2D4-BK WH: White, BK: Black	-	✓	1 indoor unit	-	✓	✓	✓	✓	-	✓	-	Stand Alone + 2 Digital Inputs
Design wired remote controller with datanavi		CZ-RTC5B	✓	✓	1 group, 8 units	· Up to 2 controllers can be connected per group	✓	✓	✓	✓	✓	-	✓	-
Wired remote controller		CZ-RTC2 (for Floor Standing (MP1) indoor units)	-	✓	1 group, 8 units	· Up to 2 controllers can be connected per group	✓	✓	✓	✓	✓	-	✓	-
Infrared remote controller		CZ-RWS3 + CZ-RWRU3 / CZ-RWS3 / CZ-RWS3 + CZ-RWRL3 / CZ-RWS3 + CZ-RWRD3 / CZ-RWS3 + CZ-RWRT3 / CZ-RWS3 + CZ-RWRC3	-	✓	1 group, 8 units	· Up to 2 controllers can be connected per group	✓	✓	✓	✓	✓ ¹	-	-	-
Quick and easy operation. Simplified remote controller		CZ-RE2C2	-	✓	1 group, 8 units	· CZ-RE2C2: up to 2 controllers can be connected per group	✓	✓	✓	✓	✓ ¹	-	-	-
Centralized Controllers														
Central controller with weekly timer		CZ-64ESMC3	✓	-	64 groups, maximum 64 units	· Up to 10 controllers, can be connected to one system · Main unit/sub unit (1 main unit + 1 sub unit) connection is possible · Use without remote controller is possible	✓	✓	✓	✓	✓ ¹	✓	✓	-
Only ON/OFF operation from center station. ON/OFF Controller		CZ-ANC3	-	-	16 groups, maximum 64 units	· Up to 8 controllers (4 main units + 4 sub units) can be connected to one system · Use without remote controller is impossible	✓	-	-	-	-	✓	-	-
Simplified load distribution ratio (LDR) for each tenant. Intelligent Controller (Touch screen panel)		CZ-256ESMC3	✓	-	Main unit: 128. Up to 256 units can be expanded	· Communication adaptor CZ-CFUNC2 is necessary for connection with more than 128 units	✓	✓	✓	✓	✓ ¹	✓	✓	-

1. Setting is not possible when a remote controller unit is present (use the remote controller for setting). * All specifications subject to change without notice.

INDIVIDUAL CONTROLLERS

Room controller for Hotel rooms

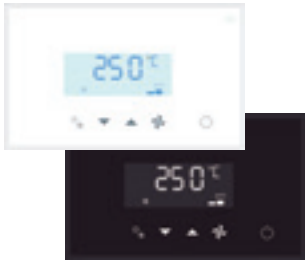

PAW-RE2C3-WH-1 // PAW-RE2C3-MOD-WH-1 // PAW-RE2C4-MOD-WH // PAW-RE2C4-MOD-BK

- Easy to install
- Cost effective installation as all electrical cable are centralized on this remote
- Architect inspired attractive design
- Direct connection to the Indoor unit with most of the functions of the indoor unit
- 2 options available: Stand-Alone and Modbus communication
- Colours: WH: White. BK: Black
- Room controller: 4 Digital Inputs and 4 Digital Outputs

From this remote controller.

The lighting, card contact, motion detector, window contact and the air conditioning are controlled.

Energy saving functions included on the device.

- Turns OFF air conditioning and lighting when room is unoccupied
- Disables air conditioning when window is open
- Maximum/minimum setpoint temperature configurable

Fast and simple set up.

Set up is simple and easy for room controllers. But it is extremely easy and quick with Touch models, which can be set up by using smartphone with NFC technology, even when control is not yet installed / powered (for PAW-RE2C4-MOD-WH // PAW-RE2C4-MOD-BK).

Display control for Hotel rooms

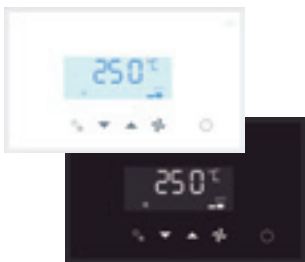

PAW-RE2D4-WH // PAW-RE2D4-BK

- Easy to install
- Cost effective installation as all electrical cable are centralized on this remote
- Architect inspired attractive design
- Direct connection to the Indoor unit with most of the functions of the indoor unit
- 2 options available: Stand-Alone and Modbus communication
- Colours: WH: White. BK: Black
- Basic hotel function: 2 Digital Inputs

From this remote controller.

The card contact, motion detector, window contact and the air conditioning are controlled.

Energy saving functions included on the device.

- Disables air conditioning when window is open
- Maximum/minimum setpoint temperature configurable

Fast and simple set up.

Set up with smartphone with NFC technology, even when control is not yet installed/powerd.

Design wired remote controller



CZ-RTC5B

- Power consumption monitor (only for PACi)
- Flat face design & Touch sensor switch for stylish design and operating usability
- New functions such as for Energy saving & monitoring and for Service use are available on the Full dot LCD (3,5" display)
- Improved illumination
- White LED backlight
- Blink when alarm occurs

datanavi

- Scan & Save AC system info
- Easy access to manual database
- Commissioning, F gas check data history

* Panasonic App is required on your smartphone.

Basic Operation.

· Operation · Mode · Temperature setting · Airflow volume · Airflow direction



Timer function.

- Outing function · Weekly Program timer · Easy ON/OFF timer
- Time display

Energy saving.

- Outing function · Temperature setting range limitation
- Temperature auto return · OFF remind · Schedule demand control
- Energy saving mode · Energy monitoring

Others.

- Key lock · Ventilation fan control · Display contrast adjustment · Remote controller sensor · Quiet operation mode · Prohibit setting control from Central controller · Rotation / Back up control

* Power consumption monitoring is available for all PACi systems except R410A PACi Standard.
* Rotation and backup control with CZ-RTC5B is available for all PACi systems.

Wired remote controller (for Floor Standing (P1) indoor units)



CZ-RTC2

- Time Function 24 hours real time clock (week day indicator)
- Weekly programme function (a maximum of 6 actions can be programmed for each day)
- Sleeping function (this function controls the room temperature for comfortable sleeping)
- Maximum 8 indoor units can be controlled from one remote controller
- Remote controller by main remote controller and sub controller is possible (maximum 2 remote controllers (main remote controller and sub controller) can be installed for one indoor unit)

- Possible to connect to the outdoor unit using PAW-MRC cable for servicing purposes
- Outing function (this function can prevent the room temperature from dropping or rising when the occupants are out for a long time)

Basic remote controller ON/OFF.

- Operation mode changeover (Cooling, Heating, Dry, Auto, Fan)
- Temperature setting (Cooling / Dry: 18-30°C Heating: 16-30°C)
- Fan speed setting High / Medium / Low and Auto
- Air flow direction adjustment
- Dimensions (H x W x D): 120 x 120 x 16mm

Infrared remote controller



CZ-RWS3 + CZ-RWRU3
For 4 Way 90x90 Cassette.



CZ-RWS3
For Wall Mounted and 4 Way 60x60
(with CZ-KPY3AW).



CZ-RWS3 + CZ-RWRL3
For 2 Way Cassette.



CZ-RWS3 + CZ-RWRD3
For 1 Way Cassette.



CZ-RWS3 + CZ-RWRT3
For Ceiling.



CZ-RWS3 + CZ-RWRC3
For all indoor units.

CZ-RWS3 + CZ-RWRU3 // CZ-RWS3 // CZ-RWS3 + CZ-RWRL3 // CZ-RWS3 + CZ-RWRD3 // CZ-RWS3 + CZ-RWRT3 // CZ-RWS3 + CZ-RWRC3

- Easy installation for the 4 Way cassette type simply by replacing the corner part
- 24 hour timer function
- Remote controller by main remote controller and sub controller is possible (Max. 2 remote controllers (main remote controller and sub controller) can be installed for one indoor unit)

- When CZ-RWS3 is used, infrared control becomes possible for all indoor units (1: when a separate receiver is set up in a different room, control from that room also becomes possible. 2: automatic operation by means of the emergency operation button is possible even when the remote controller has been lost or the batteries have been exhausted)
- Operation of separate energy recovery ventilators (When commercial ventilation fans or heat-exchange ventilation fans have been installed, they can be operated with this remote controller (interlocked operation with the indoor unit or independent ventilation ON/OFF))

Simplified remote controller. Quick and easy operation

CZ-RE2C2. A remote controller with simple functions and basic operation.

- Suitable for open rooms or hotels where detailed functions are not required
- ON/OFF, operation mode switching, temperature setting, air speed switching, air flow direction setting, alarm display, and remote controller self-diagnosis can be performed

- Batch group control for up to 8 indoor units
- Remote controller by main remote controller and sub controller is possible with a simplified remote controller or a wired remote controller (up to two units)
- Dimensions (H x W x D): 120 x 70 x 16mm



Remote sensor

CZ-CSRC3

- This remote sensor can be connected to any indoor unit. Please use it to detect the room temperature when no remote controller sensor or body sensor is used (connection to a system without a remote controller is possible)
- For joint use with a remote controller switch, use the remote controller switch as main remote controller
- Batch group control for up to 8 indoor units
- Appearance design based on simplified remote controller chassis

- Dimensions (H x W x D): 120 x 70 x 17mm
- Weight: 70g
- Temperature/Humidity range: 0°C to 40°C / 20 % to 80 % (no condensation) (indoor use only)
- Power Source: DC16V (supplied from indoor unit)
- Maximum number of connectable indoor units: Up to 8 units



Control contents	Part name, model No.	Quantity
Standard Control	High spec wired remote controller: CZ-RTC5B Wired remote controller: CZ-RE2C2 Infrared remote controller: CZ-RWS3 + CZ-RWRU3 // CZ-RWS3 + CZ-RWRL3 // CZ-RWS3 // CZ-RE2C2	1 unit each
(1) Group control	High spec wired remote controller: CZ-RTC5B Wired remote controller: CZ-RE2C2 Infrared remote controller: CZ-RWS3 + CZ-RWRU3 // CZ-RWS3 + CZ-RWRL3 // CZ-RWS3 // CZ-RE2C2	1 unit
(2) Main/sub remote controller	Main or sub. High spec wired remote controller: CZ-RTC5B Infrared remote controller: CZ-RWS3 + CZ-RWRU3 // CZ-RWS3 + CZ-RWRL3 // CZ-RWS3 // CZ-RE2C2	As required

CENTRALISED CONTROLLERS

System Controller with Schedule timer. Operation with various function from center station



Sample display image /
Operation status display

Operation Status ALL



Operation Status ZONE



Operation Status GROUP



CZ-64ESMC3

Panasonic unveils state-of-the-art digital controller

Panasonic has launched its latest controller, an innovative and easy to use interface that offers full functionality with an integrated schedule timer and system controller, making managing heating and cooling systems easier than ever before. The CZ-64ESMC3 includes Panasonic's popular schedule timer, which gives users full flexibility over when they want their property heated or cooled. Users can adjust the system for holidays, pausing operations for long periods of time so that energy isn't wasted heating or cooling an empty home or office. The controller also allows six operations per day to be programmed.

Mix of current 2 controllers: System controller + Schedule timer.

System controller will be designed by taking priority on these 2 operations with following technical key points:

- Same operation feeling as wired remote controller by touch-key panel
- High visibility and usability by Full-dot LCD
- Based on High wired remote controller
- Maximum 64 group of indoor units, Individual control for 64 units
- 4 zone control; 1 zone = Maximum 16 groups
- Several energy saving function (based on CZ-RTC5B)
- 6 timer program per day for 1 week (7 days) operation (Total 6 x 7 = 42 programs)
- Basic setting items (Temperature, Mode, Fan speed, Flap position) can be set by same manner as CZ-RTC5B

Function list:

Central control functions:

- Central control / individual setting
 - Start-stop prohibition for remote controller
 - Start-stop / Mode change / Temperature setting prohibition for remote controller
 - Mode change / Temperature setting prohibition for remote controller
 - Mode change prohibition for remote controller
 - Select items for prohibition

- Filter information
 - Filter sign
 - Filter sign reset
- Ventilation setting

Timer functions and external I/O:

- Weekly Timer
 - Timer setting Enable / Disable
 - Copy of Timer setting
- Maintenance
 - External signal (Start / Stop) (Demand control)
 - Centralized control master-slave setting
 - Alarm history
- Initial setting
 - Clock

Energy saving, maintenance and operating functions:

- Energy-saving control
 - Econavi ON/OFF
- Filter information
 - Filter sign and hour counter display
- Maintenance
 - Service contact
- Initial setting
 - Clock display setting
 - Name Setting
 - Operation lock setting
 - Operation sound setting
 - LCD contrast setting
 - LCD backlight setting
 - Select displayed language (EN / FR / IT / ES / DE)
 - Administrator password
- Setting information list

ON/OFF Controller. Only ON/OFF operation from center station



CZ-ANC3

- 16 groups of indoor units can be controlled
- Collective control and individual group (unit) control can also be performed
- Up to 8 ON/OFF controller (4 main, 4 sub) can be installed in one link system
- The operation status can be determined immediately
- Dimensions (H x W x D): 121 x 122 x 14 + 52mm (embedding dimension)

Power supply: AC 220 to 240V.

I/O part: Remote input (effective voltage: within DC 24V): All ON/OFF.

Remote output (allowable voltage: within DC 30V): ON, Alarm.

Note: As operation mode and temperature settings are not possible with the ON/OFF controller, it must be used together with a remote controller, a system controller etc.

Intelligent Controller (Touch screen panel). Simplified load distribution ratio (LDR) for each tenant



CZ-256ESMC3

Dimensions (H x W x D): 240 x 280 x 20 (+60)mm.
 Power supply: Single Phase 100-240V ~ 50/60Hz.
 Maximum number of connectable indoor units: 256 units (maximum per link: 64 units).
 Maximum number of connectable outdoor units: 120 units (maximum per link: 30 units).
 - Central control device: Up to 10 units
 Enlarged Display Screen: 10,4 inch Touch-panel colour LCD.
 Pursuing visibility, ease of use. Retrieve data from USB memory: Place the USB port inside the panel (USB memory available in stores). Communication adaptor: CZ-CFUNC2*.

* CZ-CFUNC2 is required to connect more than 128 indoor units.

Functions:

- Graph display (trends, comparisons)
- Econavi ON/OFF
- Outdoor unit quiet operation ON/OFF
- Energy-saving functions: Set temperature auto return settings, Auto shut OFF, Set temperature range limit settings, Energy saving for PAC current value, etc.
- Event control (such as equipment linkage)
- Performs closing at end of any period

Operation and status.

You can check to operational status (ON/OFF, operating mode, alarms, etc.) of all indoor units and outdoor units in real time. You can also select indoor units to change their settings.

Operation scheduling.

You can register daily operation schedules (ON/OFF time, operating modes, set temperatures, etc.) for individual indoor units or groups of indoor units. Operations can be schedule for up to 2 years in advance.

Load distribution calculation for each tenant.

- Air-conditioner load distribution ratio is calculated for each unit (tenant) with used energy consumption data (m³, kWh)

- Calculated data is stored as a CSV type file
- Data from the last 365 days is stored

Web application. Web access & control from remote station.

- Accessing from remote PC
- You can monitor/operate system by using Web browser

Remote controller.

The LAN terminal on this unit enables you connect it to a network. Connecting to Internet will enable you to operate the unit and check the status using a PC from a remote location.

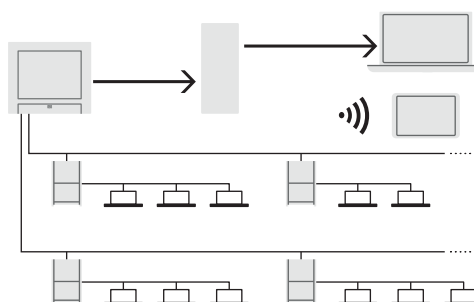

Back up tool to save your commissioning time.

Various data such as distribution, setting, log history etc. can be saved by CSV file. Setting data of CSV file is available to edit and import to the controller again. You can save time for commissioning and change setting flexibly and easily by your PC.

- Customize data
- Data recovery

Data can be imported again by general USB.

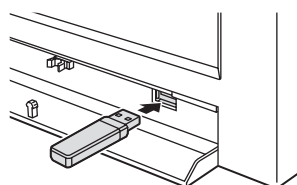

System Configuration Example.

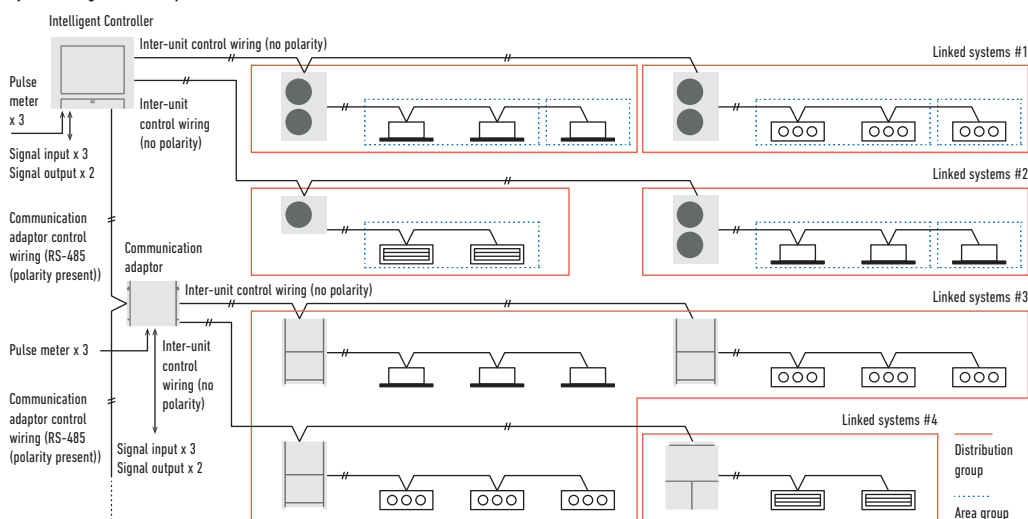

CENTRALISED CONTROLLERS

P-AIMS. Panasonic Total Air Conditioning Management System



CZ-CSWK2 / P-AIMS Basic software.

Up to 1024 indoor units can be controlled by one PC.

Functions of basic software.

- Standard remote controller for all indoor units.
- Many timer schedule programs can be set on the calendar.
- Detailed information display for alarms.
- CSV file output with alarm history, operating status.
- Automatic data backup to HDD.

P-AIMS is suitable for large shopping centers and universities with many areas/ buildings. 1 "P-AIMS" PC can have 4 independent systems at once.

Each system can have maximum 8 C/A units, and control maximum 512 units. In total, 1024 indoor units can be controlled by 1 "P-AIMS" PC.

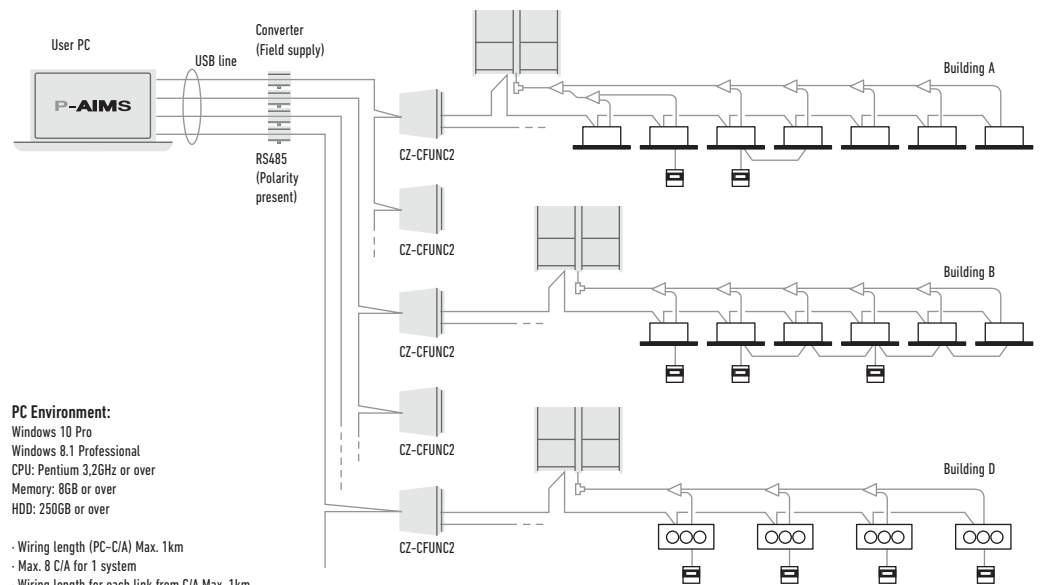

P-AIMS optional software CZ-CSWAC2 for Load distribution.

Load distribution calculation for each tenant.

- Air-conditioner load distribution ratio is calculated for each unit (tenant) with used energy consumption data (m³, kWh)
- Calculated data is stored as a CSV type file
- Data from the last 365 days is stored

display. Whole system can be controlled visually.

- Operating status monitor is available on the layout display
- Object's layout and indoor unit's location can be checked at once
- Each unit can be controlled by virtual remote controller on the display
- Max. 4 layout screens are shown at once

P-AIMS optional software CZ-CSWWC2 for Web application.

Web access & control from remote station.

- Accessing P-AIMS software from remote PC
- You can monitor/operate ECOi 6N system by using Web browser (Internet Explorer)

P-AIMS optional software CZ-CSWBC2 for BACnet software interface. Connectable to BMS system.

- Can communicate with other equipment by BACnet protocol
- ECOi 6N system can be controlled by both BMS and P-AIMS
- Max. 255 indoor units can be connected to 1 PC (that has P-AIMS basic & BACnet software).

P-AIMS optional software CZ-CSWGC2 for Object layout

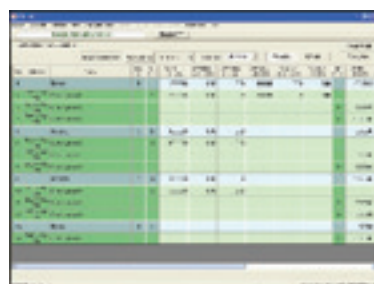

With 4 upgrade packages the basic software can be upgraded to suit individual requirements.

Seri-Para I/O unit for outdoor unit. Connection with 3rd Party Controller

CZ-CAPDC2 for ECOi / CZ-CAPDC3 for Mini ECOi and PACi.

- This unit can control up to 4 outdoor units
- From the central control device, mode changing and batch operation/batch stop are possible
- Required for demand control

Dimensions (H x W x D): 80 x 290 x 260mm.

Power supply: Single Phase 100/200V (50/60Hz), 18W.

Input: Batch operation/Batch stop (non-voltage contact/DC 24 V, pulse signal). Cooling/Heating (non-voltage contact/static signal).

Demand 1/2 (non-voltage contact/static signal) (Local stop by switching).

Output: Operation output (non-voltage contact). Alarm output (non-voltage contact).
Wiring length: Indoor/Outdoor operation lines: Total length 1km.
Digital signal: 100m or shorter.

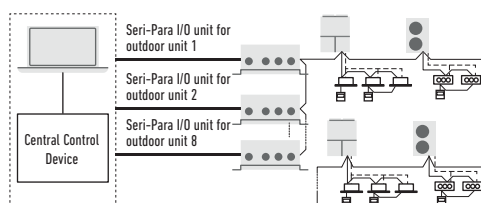

Local adaptor for ON/OFF control. Connection with 3rd Party Controller

CZ-CAPC3

- Control and status monitoring is possible for individual indoor unit (or any external electrical device up to 250 V AC, 10 A) by contact signal

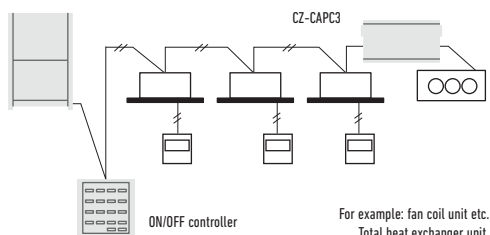

MINI Seri-Para I/O Unit 0 -10V. Connection with 3rd Party Controller

CZ-CAPBC2

- Control and status monitoring is possible for individual indoor unit (1 group)
- In addition to operation and stop, there is a digital input function for air speed and operation mode
- Temperature setting and measuring of the indoor suction temperature can be performed from central monitoring
- Power is supplied from the T10 terminal of the indoor units
- The analog input for demand of the outdoor capacity by 20 steps (from 40% to 120%) by 0-10V

- The analog input for temperature setting is 0 to 10V, or 0 to 140 Ohm
- Separate power supply also is possible (in case of suction temperature measuring)

* Ask to your distributor.

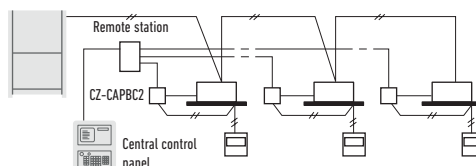

Communication adaptor for VRF Connectivity

CZ-CFUNC2

This communication interface is required to connect a ECOi and GHP systems to a BMS. An additional interface is needed to convert the information into KNX / Modbus / BACnet language. CZ-CFUNC2 is very easy to operate and to connect to the Panasonic P-Link, which is the ECOi bus. From the CZ-CFUNC2, all

the indoor and outdoor units of the installation can be easily control. Two linked wiring systems can be connected to one CZ-CFUNC2.

Dimensions (H x W x D): 260 x 200 x 68mm

* As this is not a splash-proof design, it must be installed indoors or in the control panel, etc.



PACi AND VRF CONTROL AND CONNECTIVITY



Controls and connectivities are the key to offer better comfort and price. Panasonic offers its customers cutting-edge technology, specially designed to ensure our air conditioning systems deliver optimal performance. You can properly manage the air conditioning and perform comprehensive monitoring and control, with all of the features the remote controller provides at home, from anywhere in the world thanks to the internet applications Panasonic has created for you.



Panasonic PACi, ECOi and ECO G protocol room controllers and Interfaces.

Type of connection	Number of units	RC or IF	Modbus	KNX	BACnet	LonWorks
ECOi / PACi Indoor Units	1 unit/group	Room controller	PAW-RE2C3-MOD-WH-1		SER8150R081194	
			SER8150R081194		SER8150R581194	
	4 units/groups	Interfaces	PAW-RC2-MBS-1	PAW-RC2-KNX-1i	PAW-AC-BAC-1	
			PAW-RC2-MBS-4			
PACi / ECOi / ECO G P-Link	16 indoors	Interfaces	PAW-AC2-MBS-16P	PAW-AC2-KNX-16P	PAW-AC2-BAC-16P	
	64 indoors	Interfaces				CZ-CLNC2 ¹
			PAW-AC2-MBS-64P	PAW-AC2-KNX-64P	PAW-AC2-BAC-64P	
	128 indoors	Interfaces	PAW-AC2-MBS-128P		PAW-AC2-BAC-128P	

1) 16 groups of maximum 8 indoor units, in total maximum 64 indoor units.

PACi, ECOi and ECO G Connectivity

The interface has been designed specifically for Panasonic and provides complete monitoring, control and full functionality of the line-up from IntesisHome, KNX, Modbus, BACnet and LonWorks installations.

This connectivity solution with "PAW" model names is made by a third party company, please contact Panasonic for more information.

	Model name	Interface	Maximum number of indoor units connected
ECOi / PACi Indoor Units	PAW-RC2-KNX-1i	KNX	1 (1 Group of Indoor units)
	PAW-RC2-MBS-1	Modbus RTU ¹	1 (1 Group of Indoor units)
	PAW-RC2-MBS-4	Modbus	4 indoor/groups
	PA-RC2-WIFI-1	IntesisHome	1 (1 Group of Indoor units)
PACi / ECOi / ECO G P-Link	PAW-AC2-KNX-16P	KNX	16
	PAW-AC2-KNX-64P	KNX	64
	PAW-AC2-MBS-16P	Modbus	16
	PAW-AC2-MBS-64P	Modbus	64
	PAW-AC2-MBS-128P	Modbus	128
	PAW-TM-MBS-RTU-64	Modbus RTU ²	64
	PAW-TM-MBS-TCP-128	Modbus TCP ²	128
	PAW-AC-BAC-1	BACnet	1
	PAW-AC2-BAC-16P	BACnet	16
	PAW-AC2-BAC-64P	BACnet	64
	PAW-AC2-BAC-128P	BACnet	128
	CZ-CLNC2	LonWorks	16 groups of maximum 8 indoor units, in total maximum 64 indoor units

1) Interface Modbus RTU/TCP is needed in case if Modbus TCP connection. PAW-MBS-TCP2RTU (ModBus RTU Slave devices). 2) Interface CZ-CFUNC2 needed.

Airzone. Control of the Hide Aways

Airzone has developed interfaces to easily connect to Panasonic Commercial Hide Away units. Ensuring optimum performance, comfort and energy savings, the new system is efficient and easy to install.

Airzone full range of accessories for any duct project.



Different type of outlets



Also plenum automatic doors



Full range of remote controls (wired / Infrared, ...)

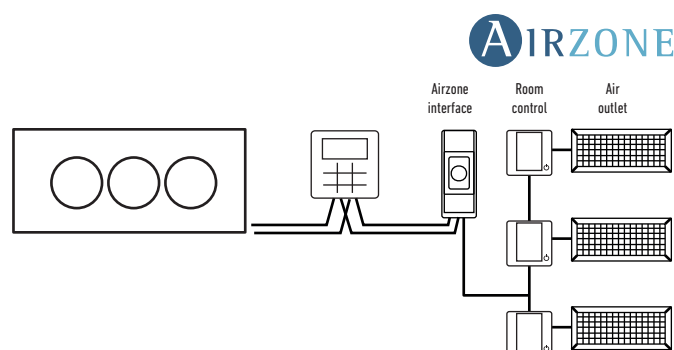

ECOi, ECO G AND PACi CONNECTIVITY INDOOR UNITS

PCB's and cables for ECOi, ECO G and PACi indoor units

Name of the cables	Function	Comment
CZ-T10	All T10 functions	Requires field supplied accessory
PAW-FDC	Operate external fan	Requires field supplied accessory
PAW-OCT	All option monitoring signals	Requires field supplied accessory
CZ-CAPE2	Option monitoring signals wo. fan	Requires additional wires from spare part supply
PAW-EXCT	Forced Thermo OFF/Leakage D.	Requires field supplied accessory
Name of the PBC	Function	Comment
PAW-T10	All T10 functions	Allows easy connection "Plug & Play"
PAW-PACR3	Redundancy of 2 or 3 systems; for ECOi and PACi	Redundancy of 2 or 3 ECOi or PACi systems including temperature monitoring, error indication, backup, alternative run

T10 connector (CN015)



CZ-T10

Panasonic has developed an optional accessory (consisting of plug + wires) called CZ-T10 to enable an easy connection to this T10 connector.

Connecting an ECOi indoor unit to an external device is easy. The T10 terminal featured in the electronic circuit board of all indoor units enables digital connection to external devices.

T10 terminal Specification (T10: CN015 at indoor unit PCB).

- Control items: 1. Start/stop input
- 2. Remote controller prohibit input
- 3. Start signal output
- 4. Alarm signal output

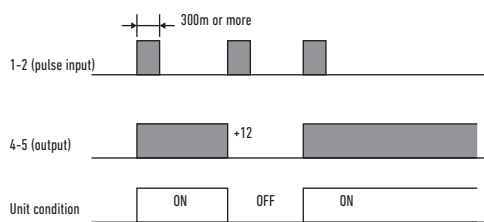

NOTE: The wire length from indoor unit to the Relay must be within 2.0m. Pulse signal changeable to static by cutting jumper JP001.

Condition

- 1-2 (Pulse input): Unit ON/OFF condition switching with a pulse signal. (1 pulse signal: shortage status more than 300msec. or more)
- 2-3 (Static input): Open / Operation with Remote is permitted (Normal condition) Close / Remote controller is prohibited
- 3-4-5 (Static output): 12V output during the unit ON / No output at OFF
- 4-5-6 (Static output): 12V output when some errors occur / No output at normal

Example of wiring

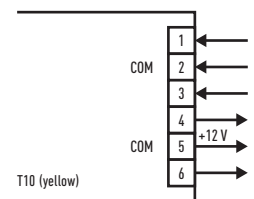

Usage Example.

Forced OFF control.

Term 1 & 2: Free contact for ON/OFF signal (cut *JP1* for static signal) when the hotel card is it connected the contact must be close (the unit can be used).

Term 2 & 3: Free contact to prohibit all function in the remote controller install in the room when the hotel card is it removed the contact must be closed (the unit can not work).

Terminal = T10

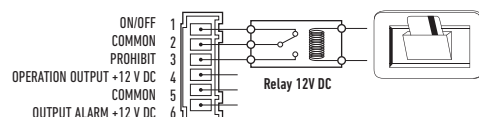

Operation ON/OFF signal output.

Condition:

4-5 (Static output): 12V output during the unit ON / No output at OFF

Example of wiring

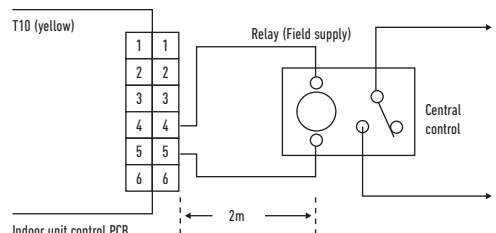

NOTE: The wire length from indoor unit to the Relay must be within 2.0m. Pulse signal changeable to static by cutting jumper JP001.

Fan Drive Connector (CN032)

PAW-FDC

Panasonic has developed an optional accessory (consisting of plug + wires) called PAW-FDC to enable an easy connection to this Fan Drive Connector (CN032).

Operating the ventilation fan from the remote controller

- Start / stop of external ventilation and total heat exchanger fans
- Works even if indoor unit is stopped
- In case of group control → all fans will operate; no individual control

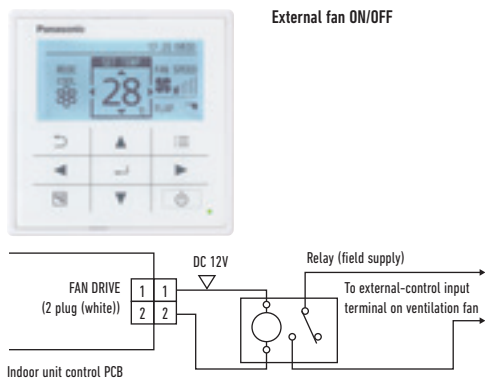

Option Connector (CN060) Output external signals

PAW-OCT

Panasonic has developed an optional accessory (consisting of plug + wires) called PAW-OCT to enable an easy connection to this Option Connector (CN060).

With the combination of the T10 and the option CN060 an external control of the indoor units is possible!

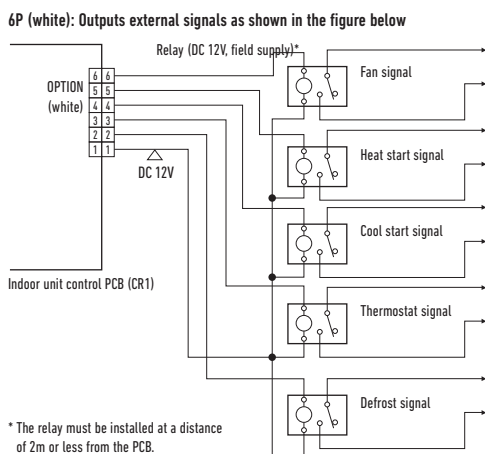

EXCT Connector (CN009)

PAW-EXCT

Panasonic has developed an optional accessory (consisting of plug + wires) called PAW-EXCT to enable an easy connection to this EXCT Connector (CN009).

A) With static input.

→ STATIC INPUT → THERMO OFF → ENERGY SAVING

2P plug (red): Can be used for demand control. When input is present, forces the unit to operate with the thermostat OFF.

Note: The length of the wiring from the indoor unit control PCB to the relay must be 2m or less.

· Examples of wiring:

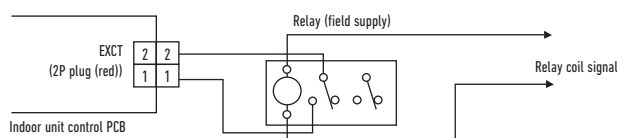

B) Example: In connection with a refrigerant sensor.

- Signal from leakage detector: non voltage, static.
- Indoor unit setting: Code 0b → 1
- Connector for leak detector: EXCT
- Outdoor unit setting:
 - Code C1 → 1 power output if alarm from O2 connector 230V
 - Code C1 → 2 power output if alarm from O2 connector 0V
- Displayed alarm message P14

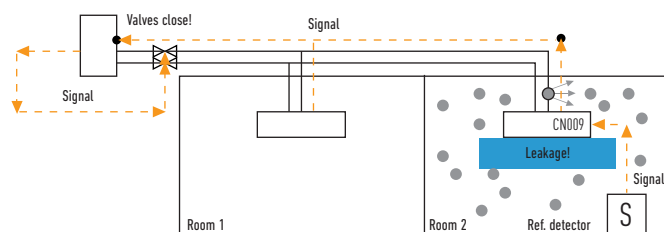

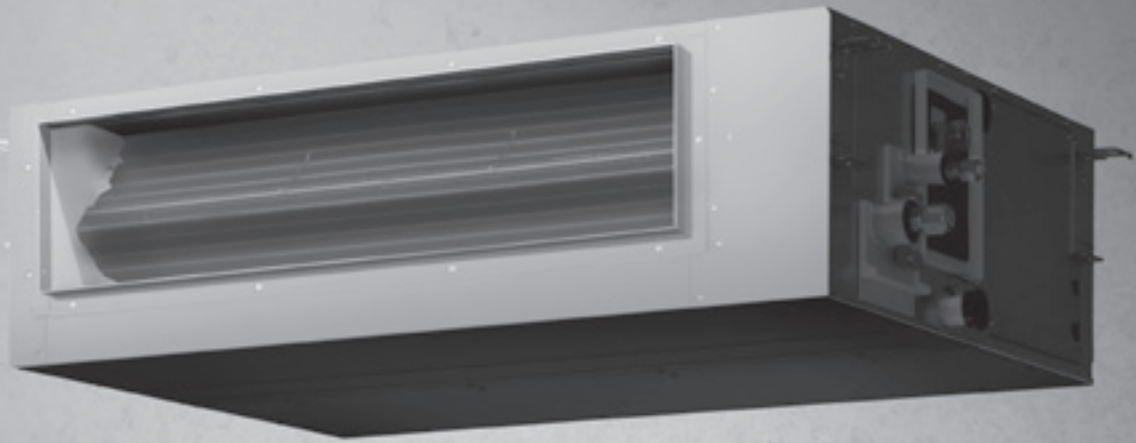

DIMENSIONS

All in One H Generation

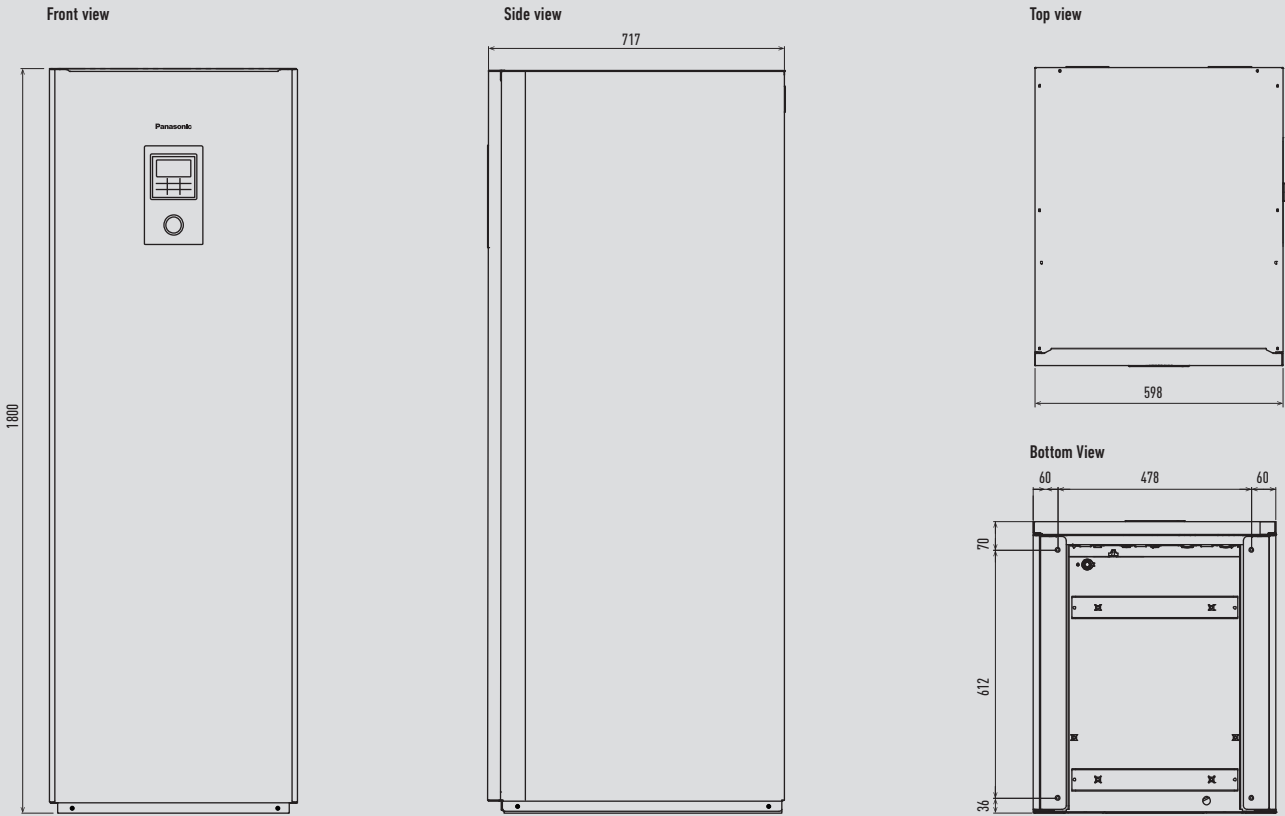

Unit: mm

Hydraulic Module H Generation

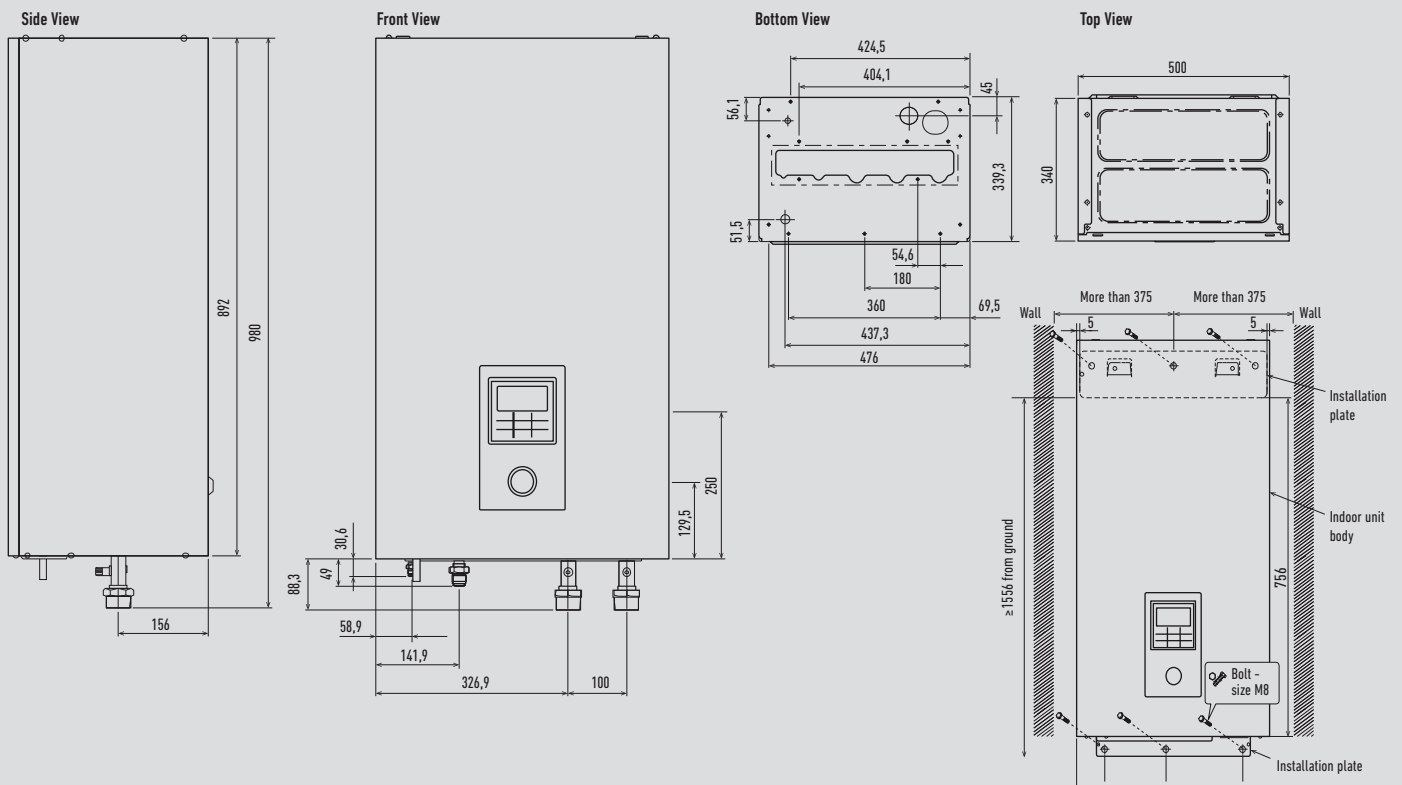

Unit: mm

Hydraulic Module F Generation

Side View

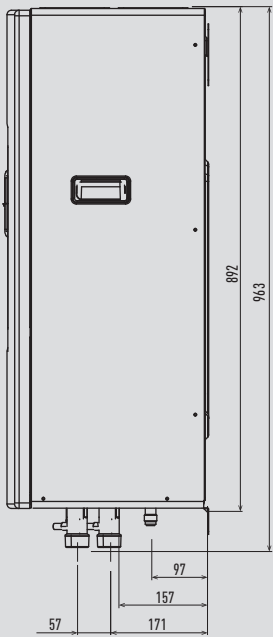

Front View

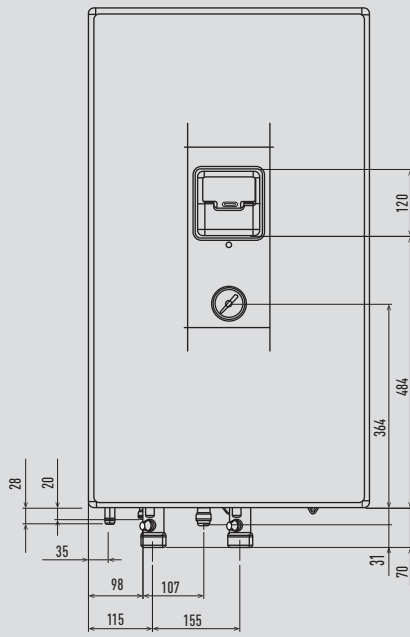

Bottom View

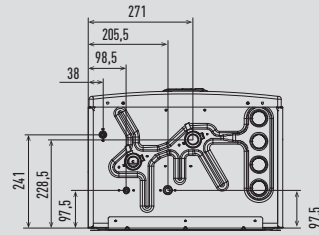

Relative position between the indoor unit and the installation plate Front View

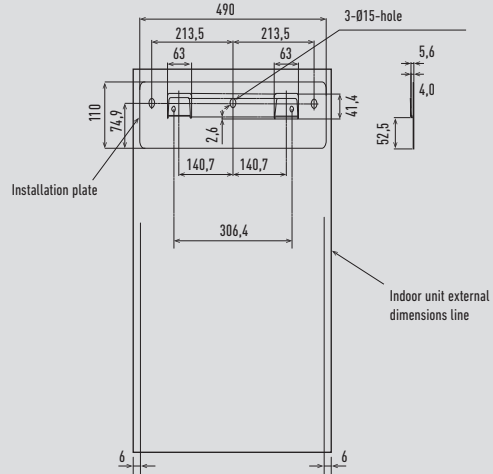

Top View

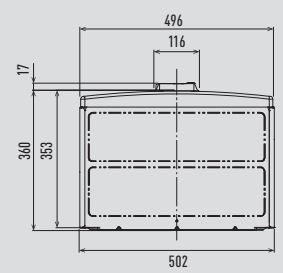

Unit: mm

Bi-bloc outdoor unit 3 and 5kW

Space necessary for installation

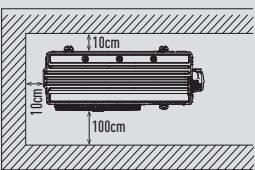

Anchor bolt pitch 355 x 260

Top View

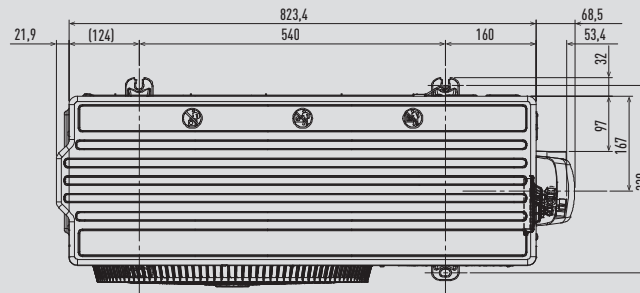

Side View

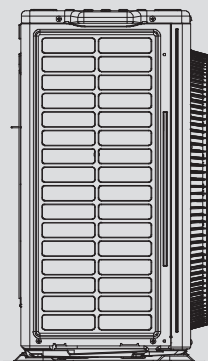

Front View

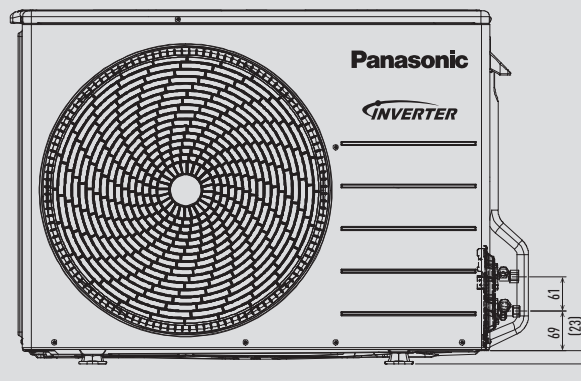

Side View

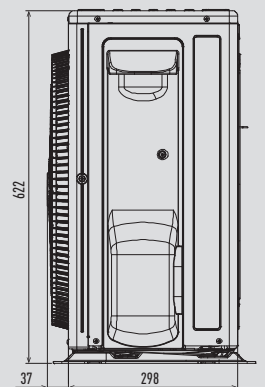

Unit: mm

Bi-bloc outdoor unit 7 and 9kW

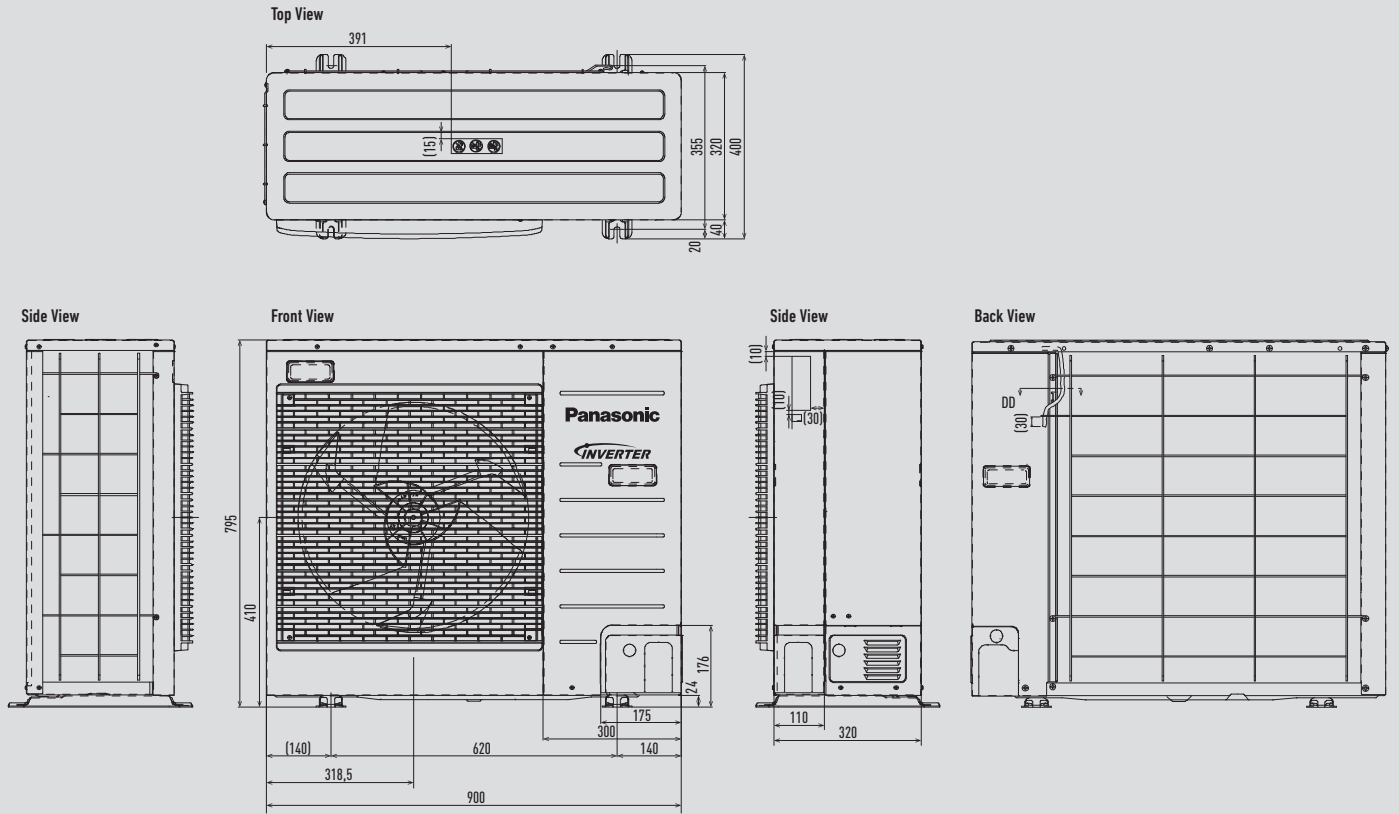

Bi-bloc outdoor unit from 9 to 16kW

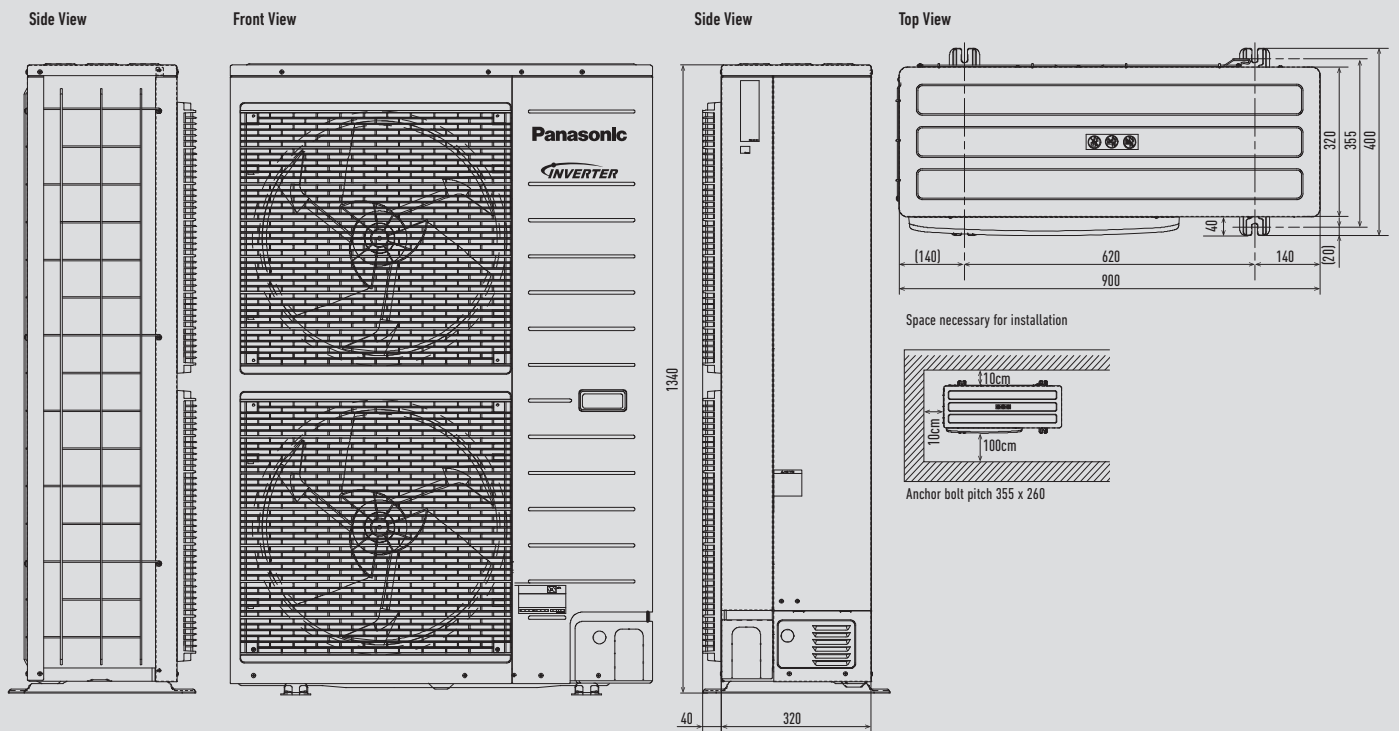

Mono-bloc outdoor unit from 5 to 9kW

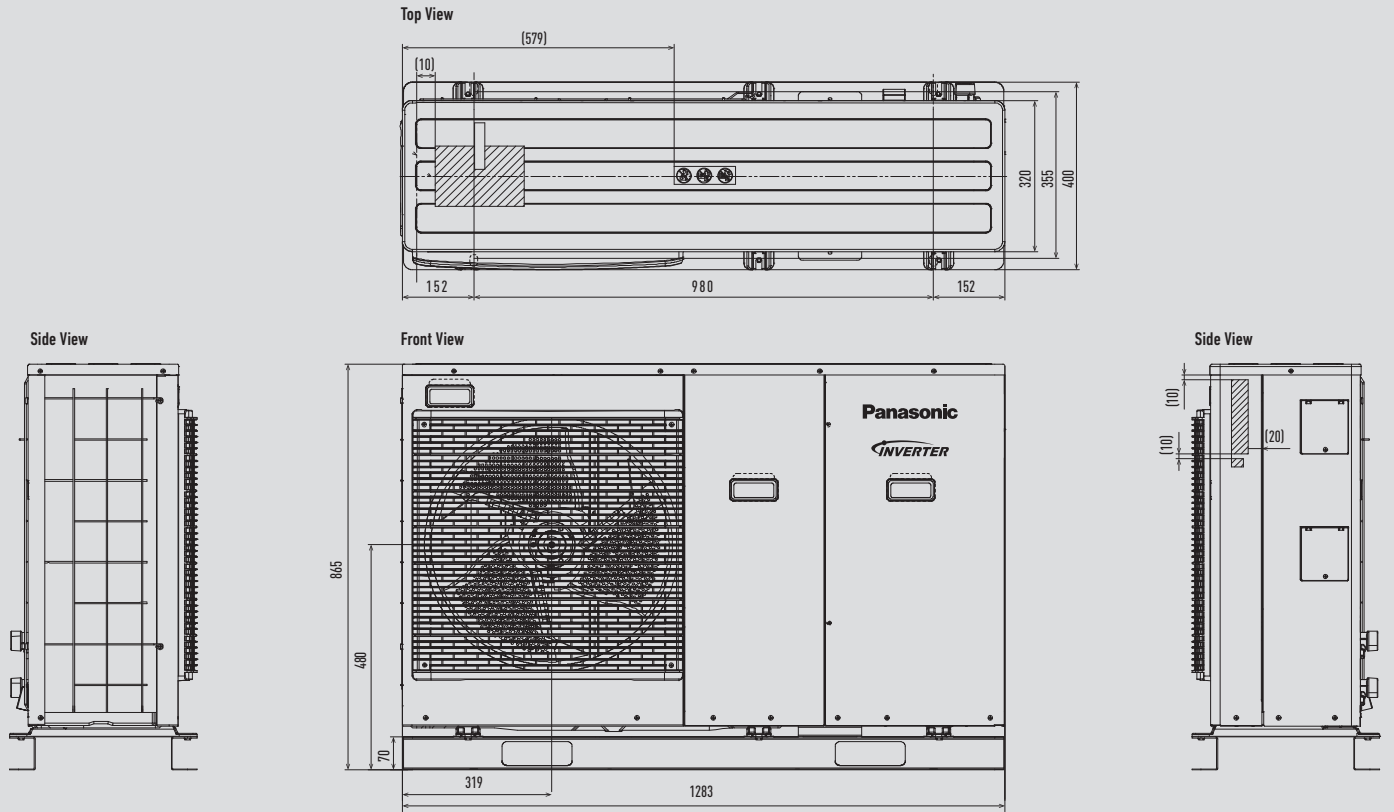

Unit: mm

Bi-bloc Super Quiet outdoor unit and Mono-bloc outdoor unit from 9 to 16kW

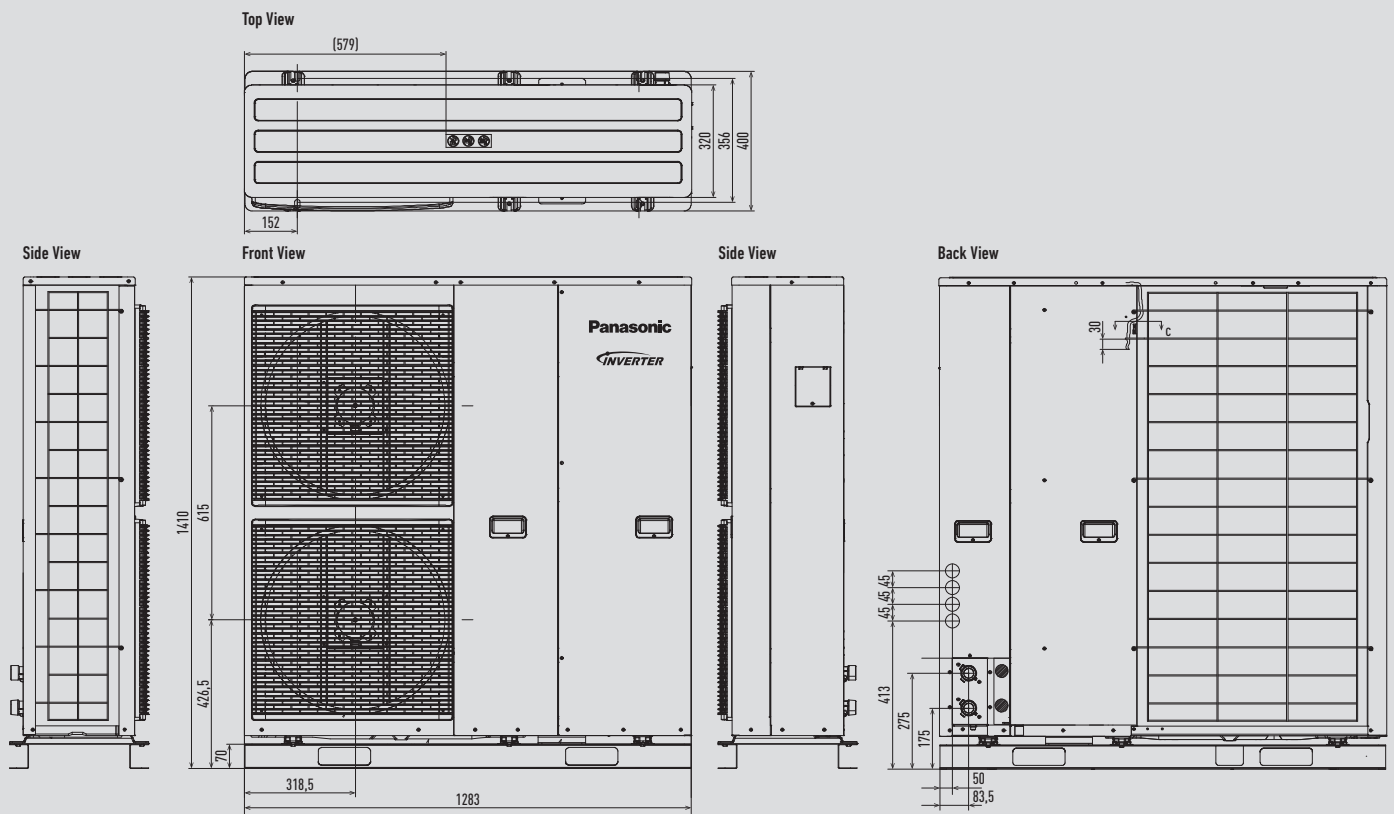

Unit: mm

DHW Stand Alone

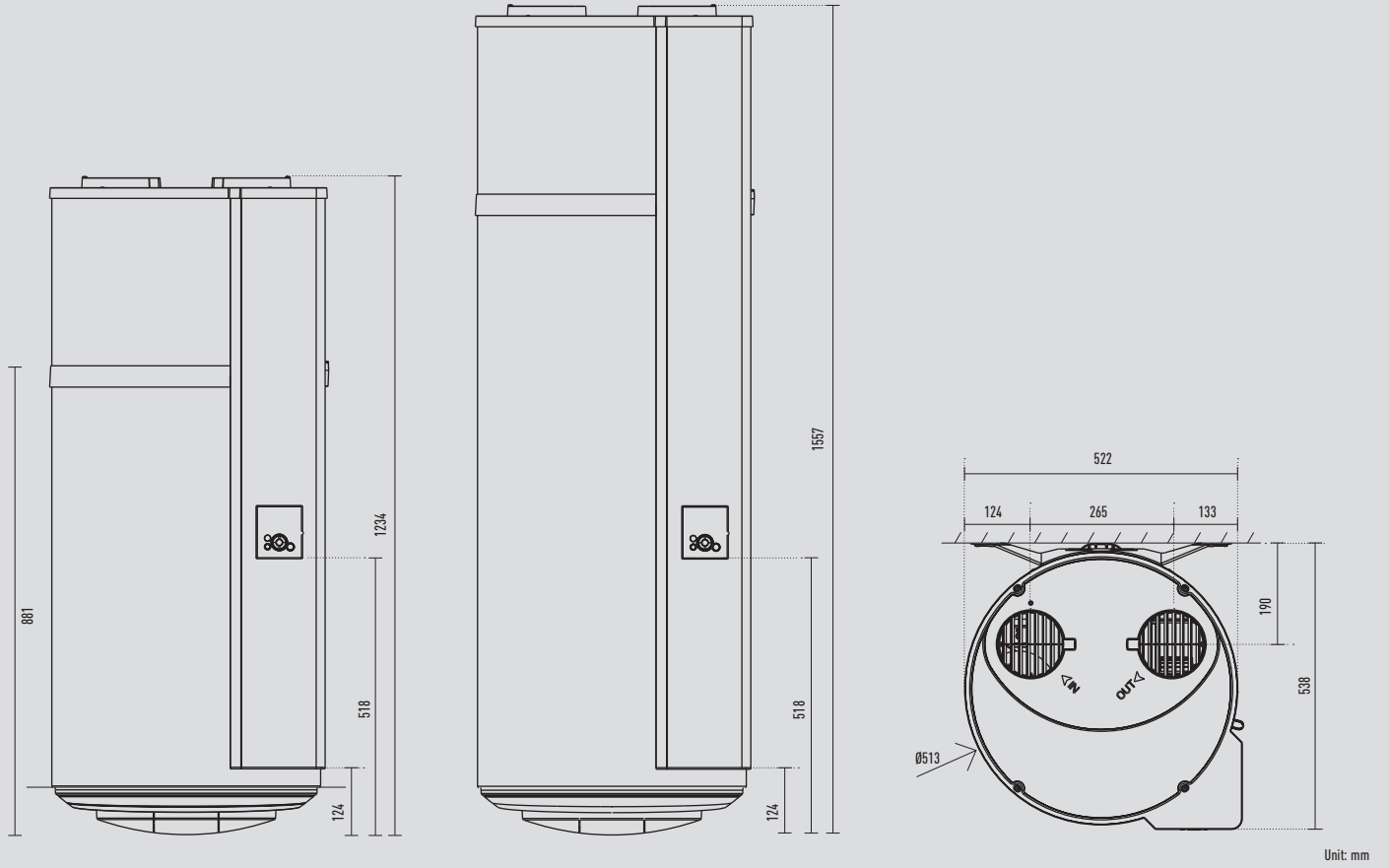

Buffer tank

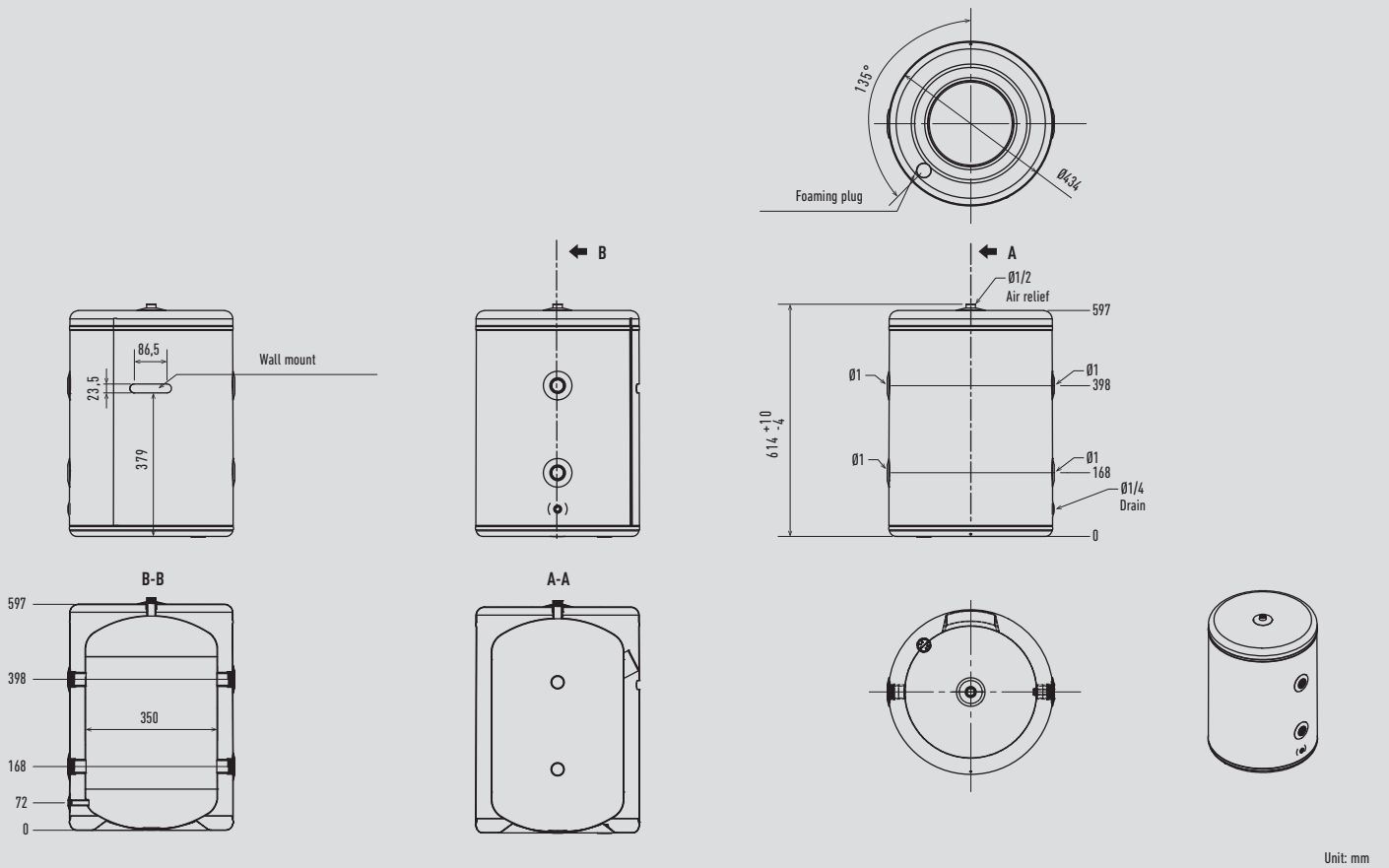

Wall Mounted TKEA

CS-Z25TKEA / CS-Z35TKEA

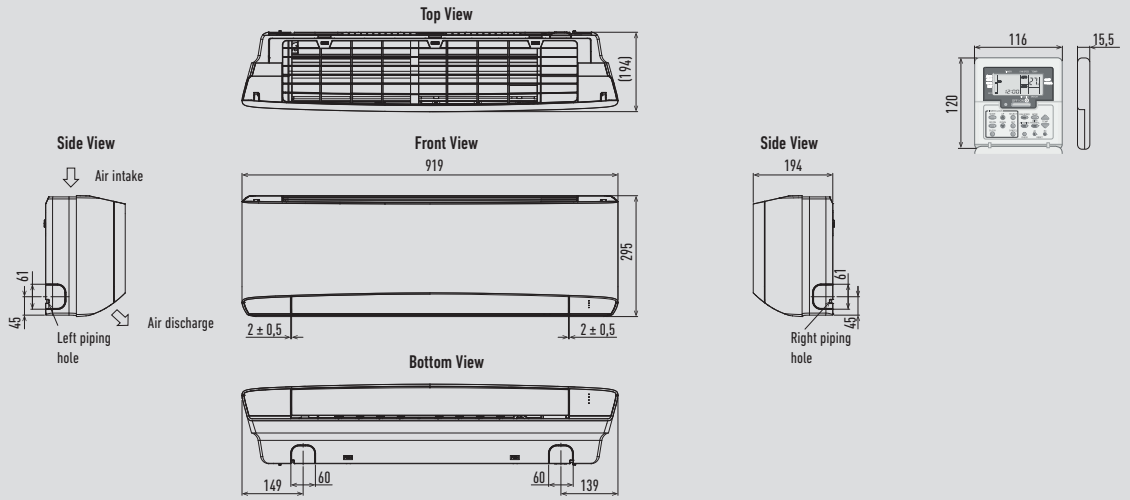

CS-Z42TKEA / CS-Z50TKEA / CS-Z71TKEA

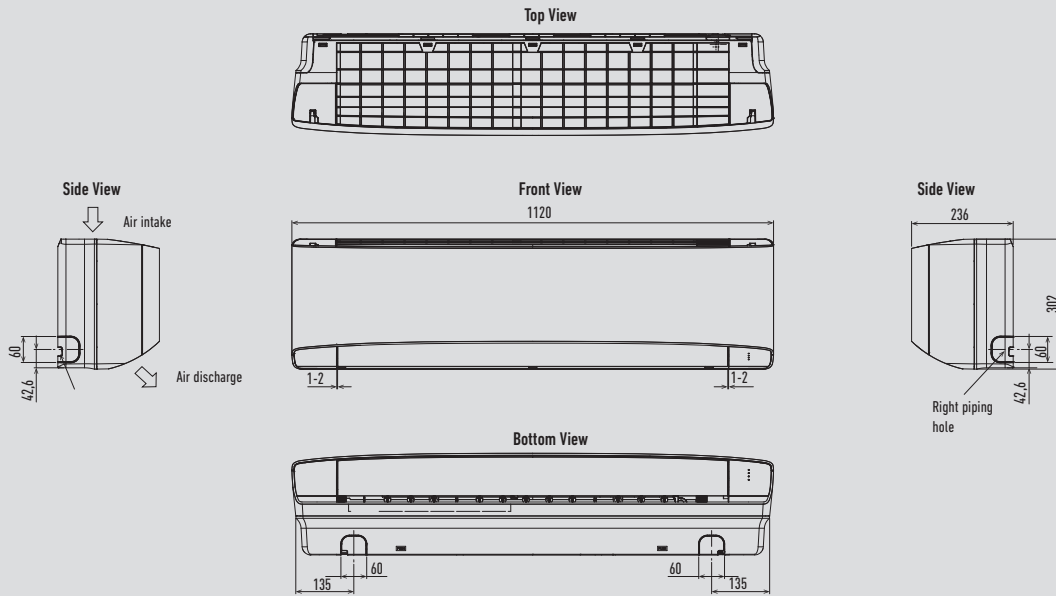

CU-Z25TKEA / CU-Z35TKEA / CU-Z42TKEA

CU-Z50TKEA / CU-Z71TKEA

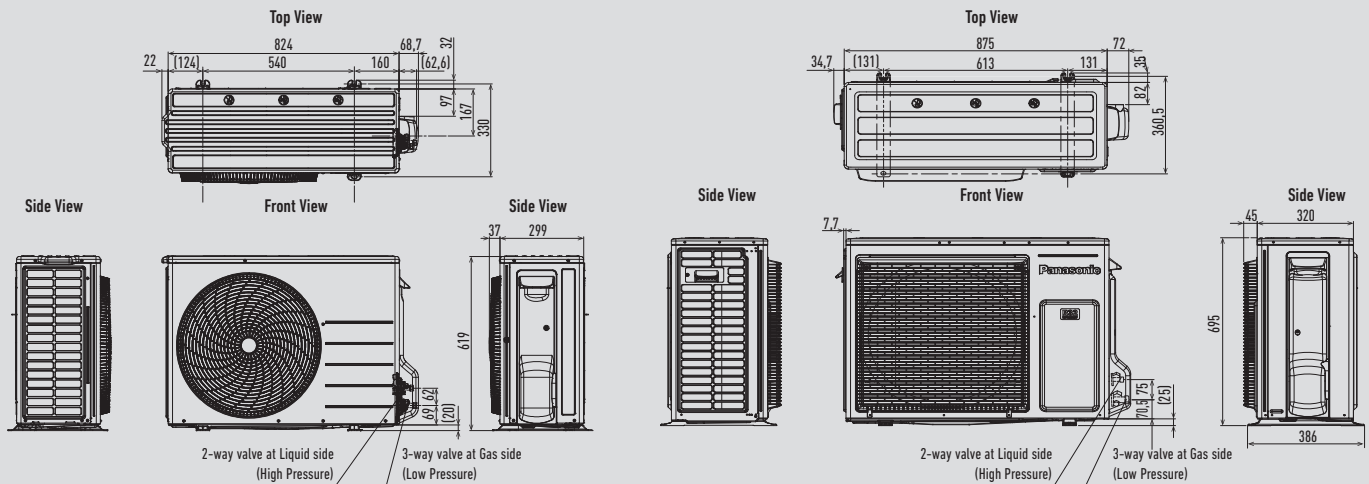

Wall Mounted PKEA

CS-E9PKEA / CS-E12PKEA

CS-E15PKEA / CS-E18PKEA

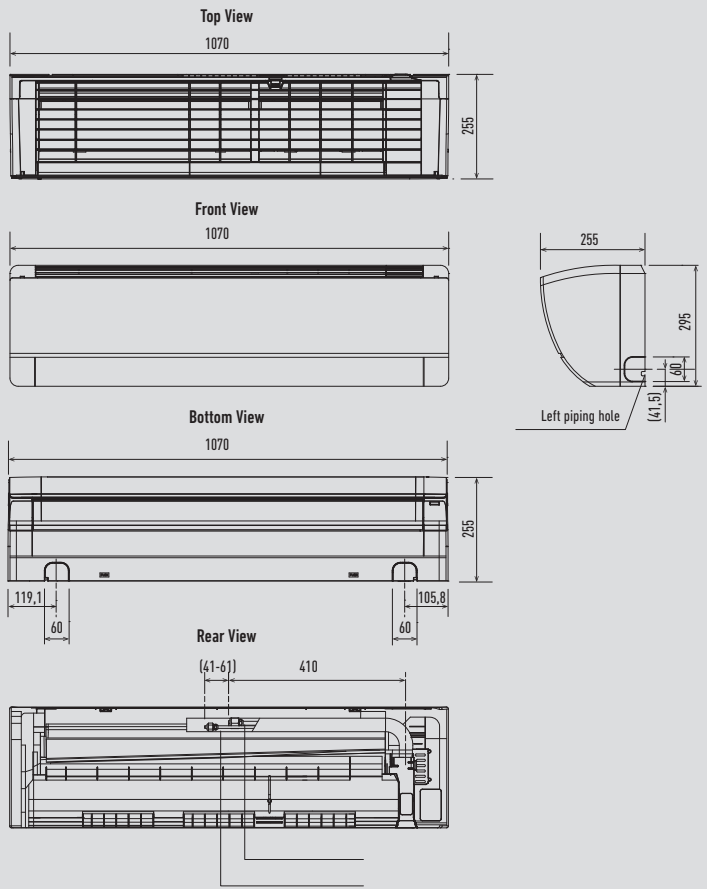
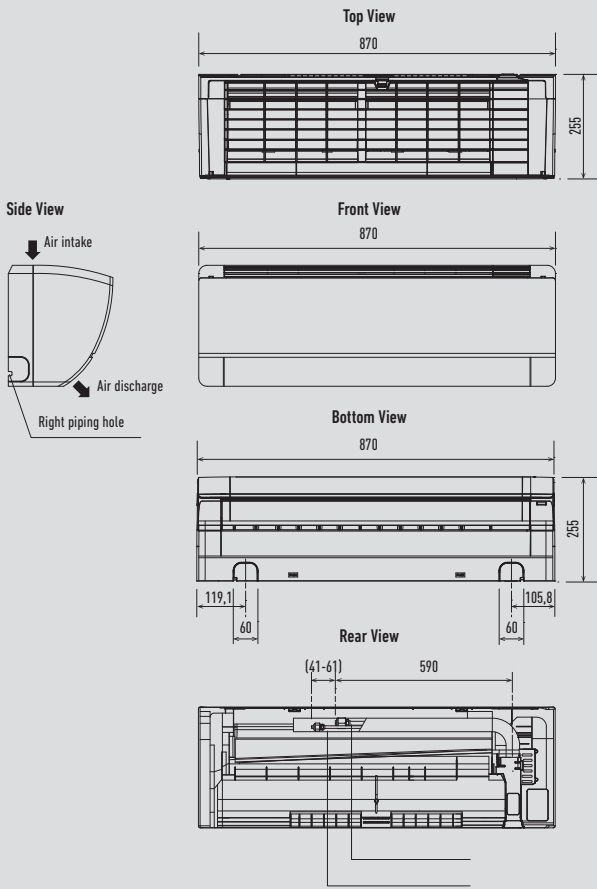

CU-E9PKEA / CU-E12PKEA

CU-E15PKEA / CU-E18PKEA

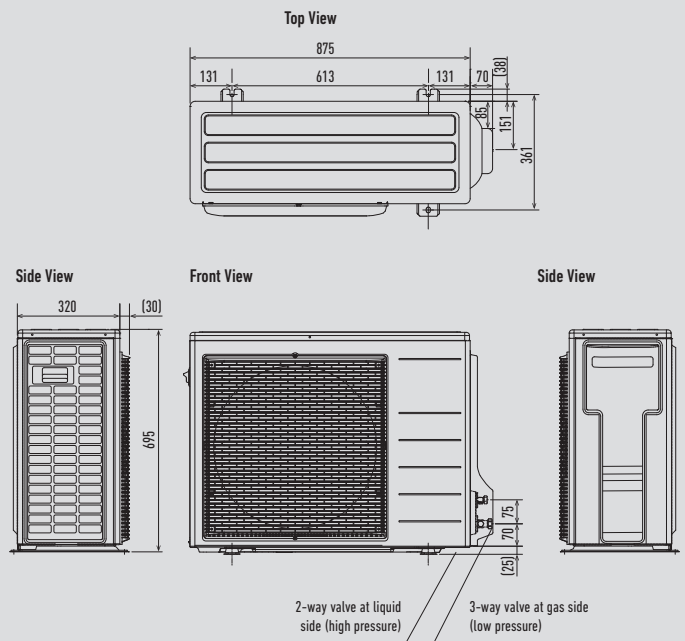
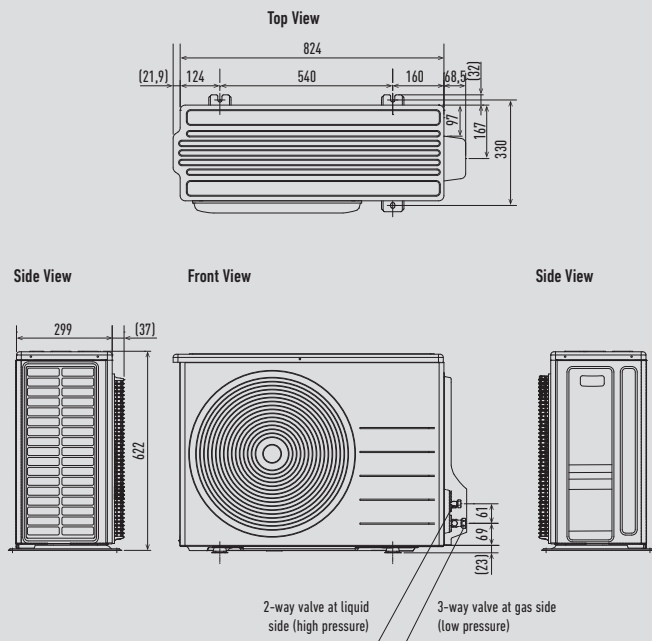

PACi Wall Mounted

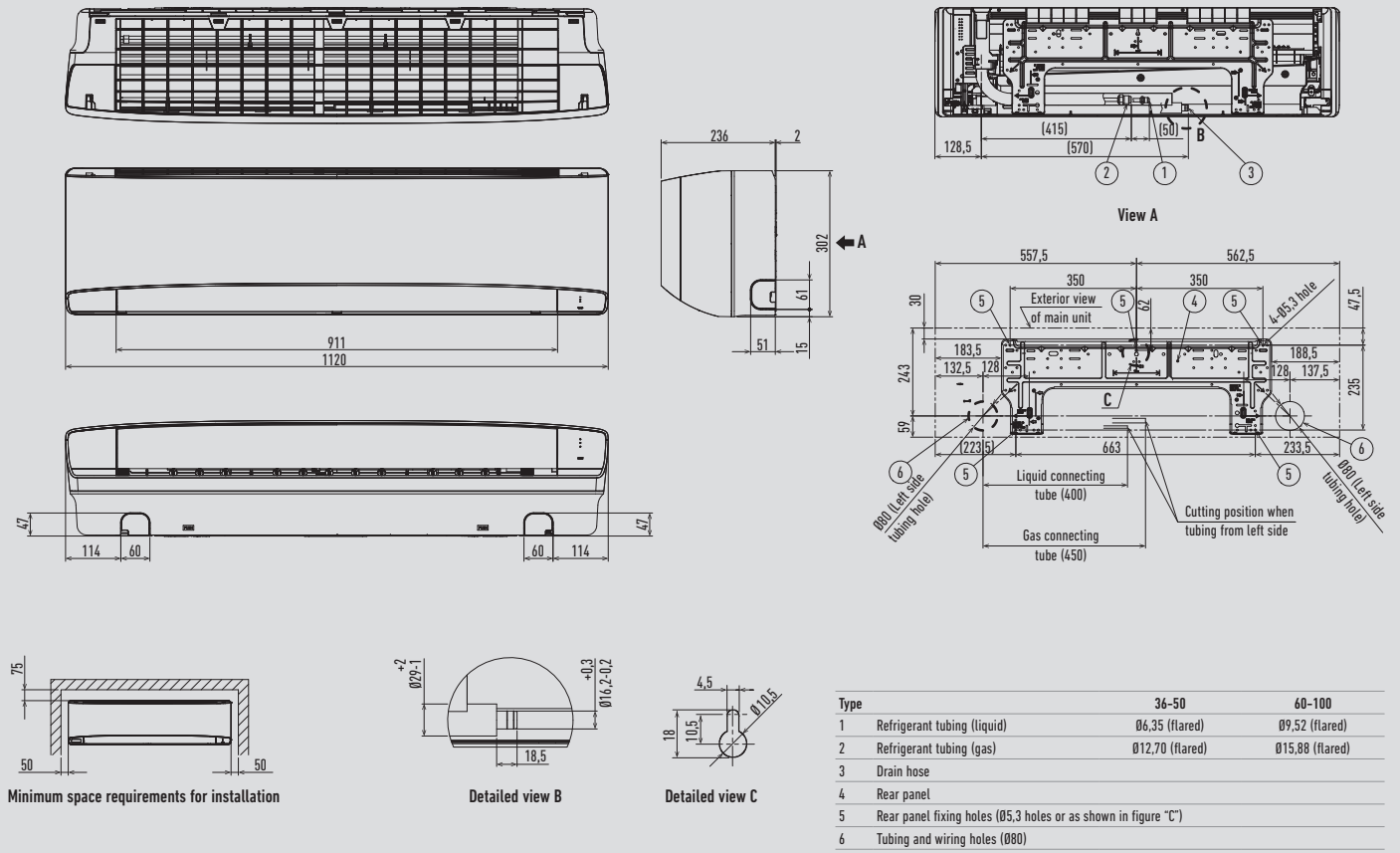

PACi 4-Way 60x60 Cassette

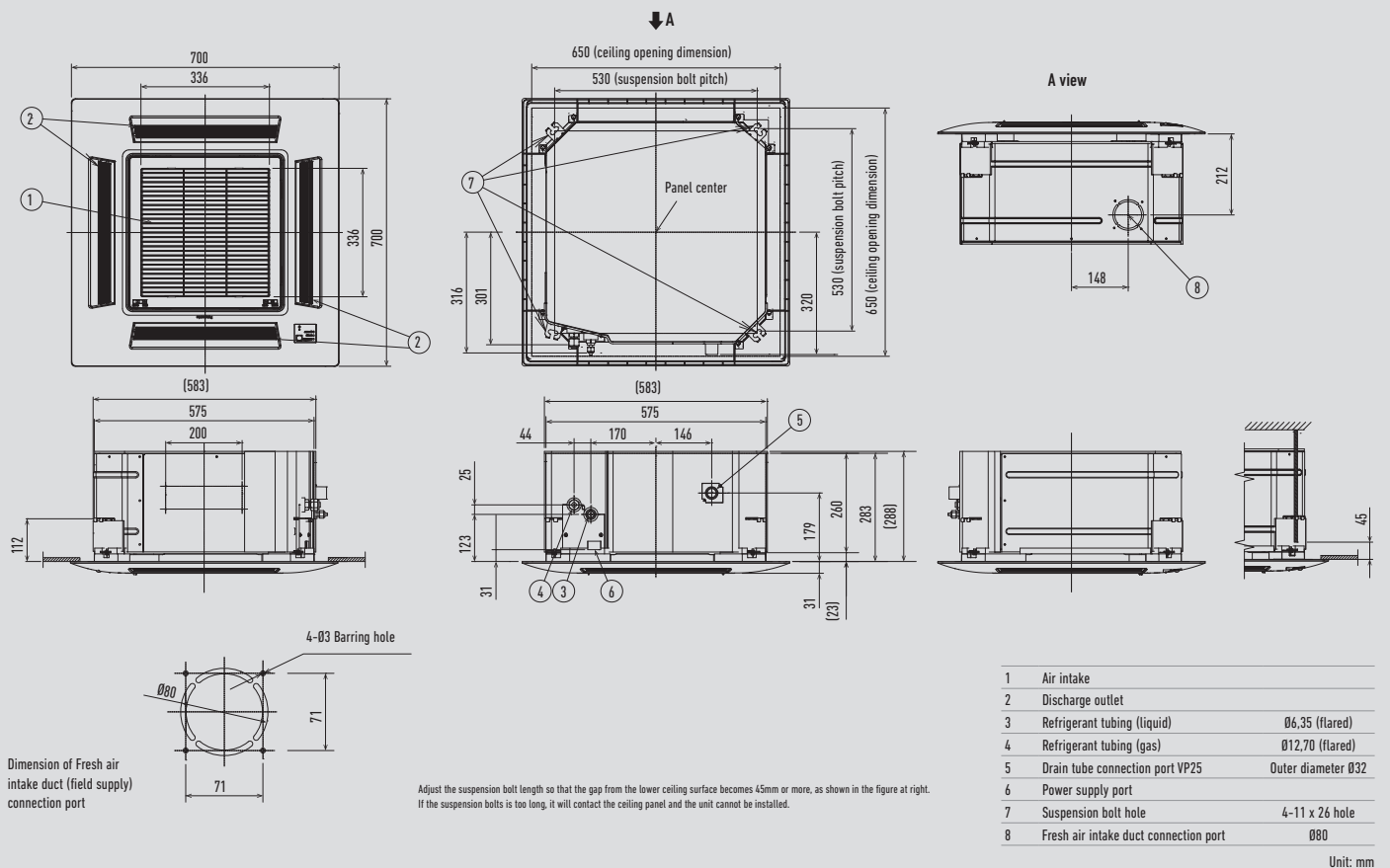

PACi 4 Way 90x90 Cassette

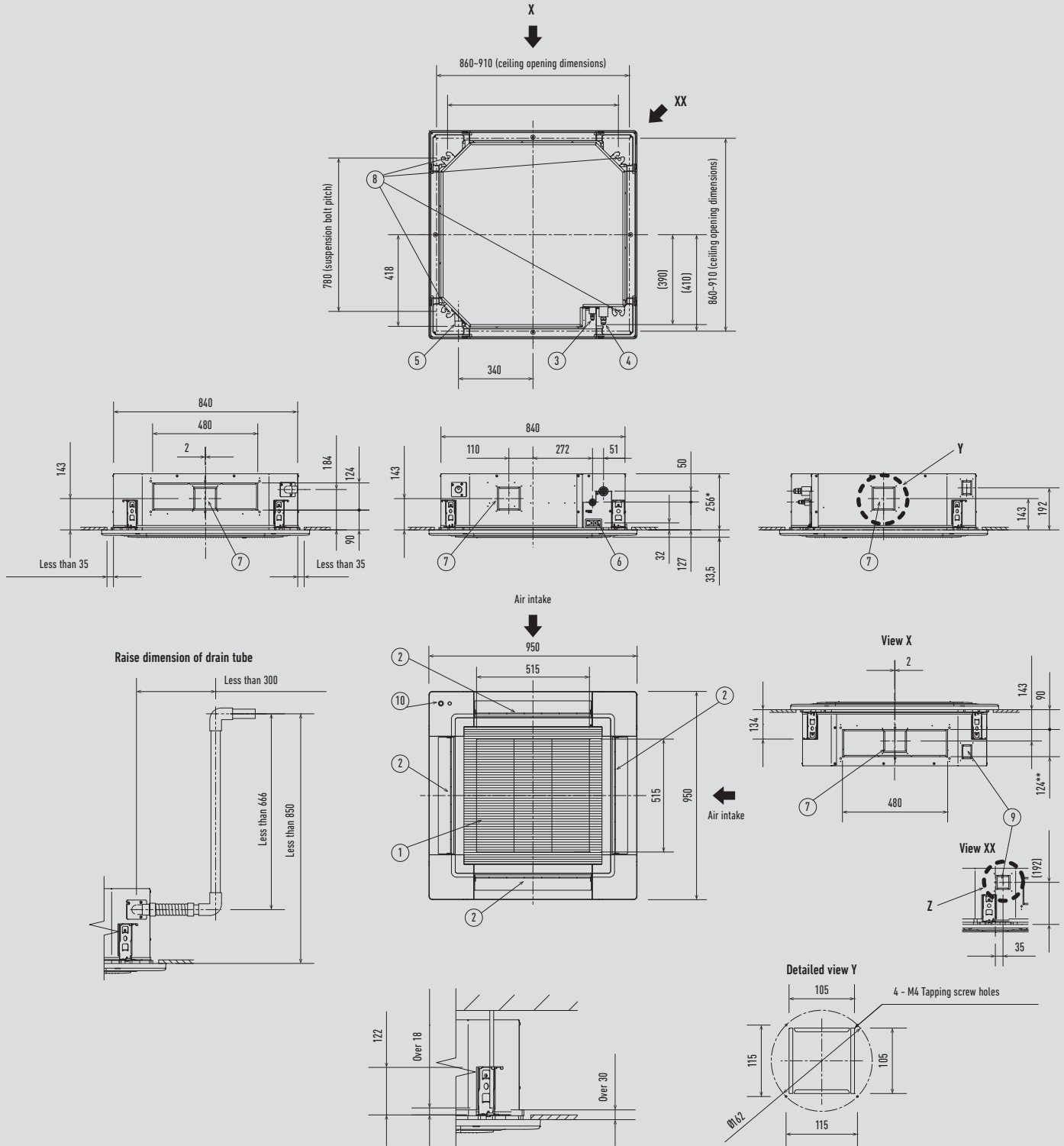

The length of the suspension bolts should be selected so that there is a gap of 30mm or more below the lower surface of the ceiling (18mm or more below the lower surface of the main unit), as shown in the figure at right. If the suspension bolt is too long, it will contact the ceiling panel and the unit cannot be installed.
Filter dimension: 520 x 520 x 15mm.

* 319mm for S-100PUZE5B / S-125PUZE5B / S-140PUZE5B.
** 187mm for S-100PUZE5B / S-125PUZE5B / S-140PUZE5B.

Type	36-50	60-140
1 Air intake		
2 Discharge outlet		
3 Refrigerant tubing (liquid)	Ø6,35 (flared)	Ø9,52 (flared)
4 Refrigerant tubing (gas)	Ø12,70 (flared)	Ø15,88 (flared)
5 Drain tube connection port VP25	Outer diameter Ø32	
6 Power supply port		
7 Suspension bolt hole	4-12x30 elongated hole	
8 Fresh air intake duct connection port	Ø100 ¹	
9 Suspension bolt hole	4-12x30 elongated hole	
10 Econavi sensor (Only CZ-KPU3A)		

1) Necessary to attach duct connecting flange (field supplied).

Unit: mm

PACi Ceiling

S-36PT2E5B / S-45PT2E5B / S-50PT2E5B

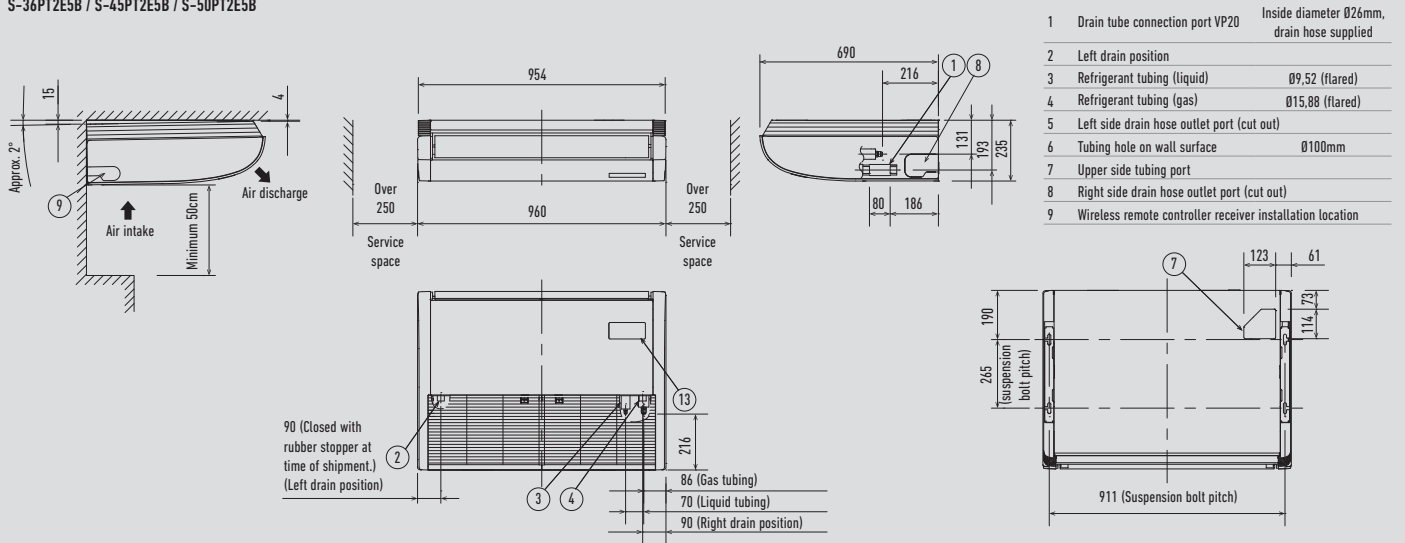

S-60PT2E5B / S-71PT2E5B

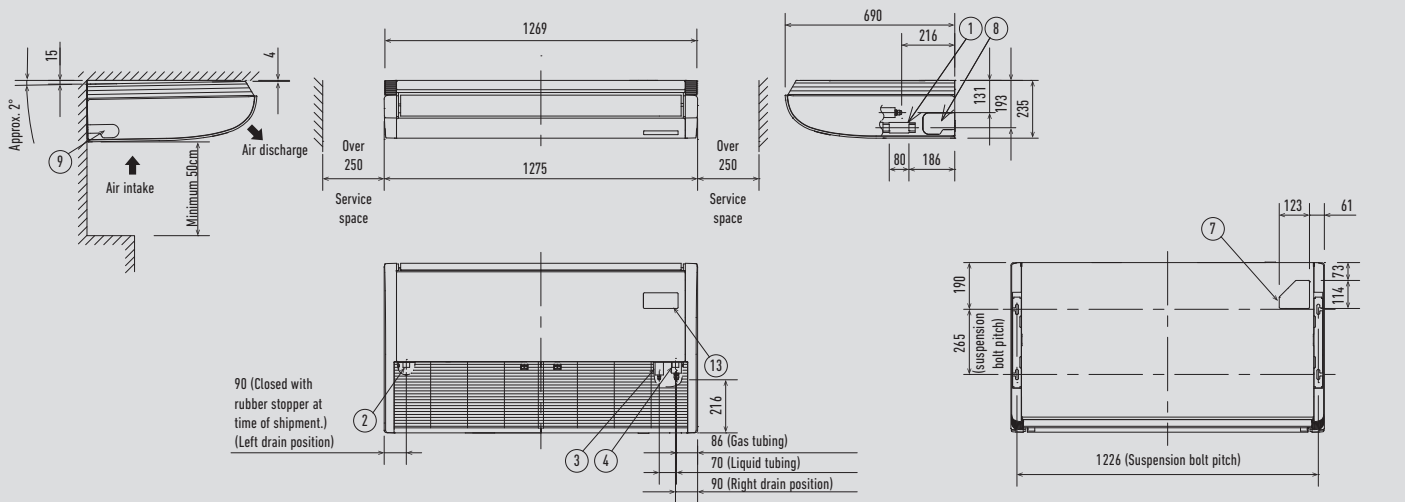

S-100PT2E5B / S-125PT2E5B / S-140PT2E5B

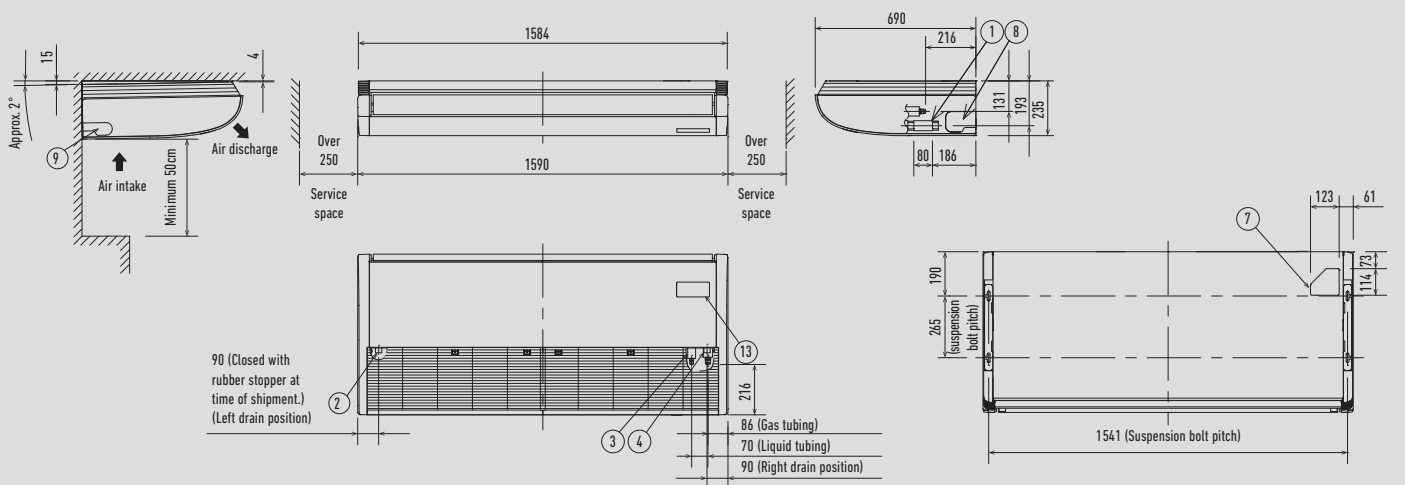

PACi High Static Pressure Hide Away

S-36PF1E5B / S-45PF1E5B / S-50PF1E5B

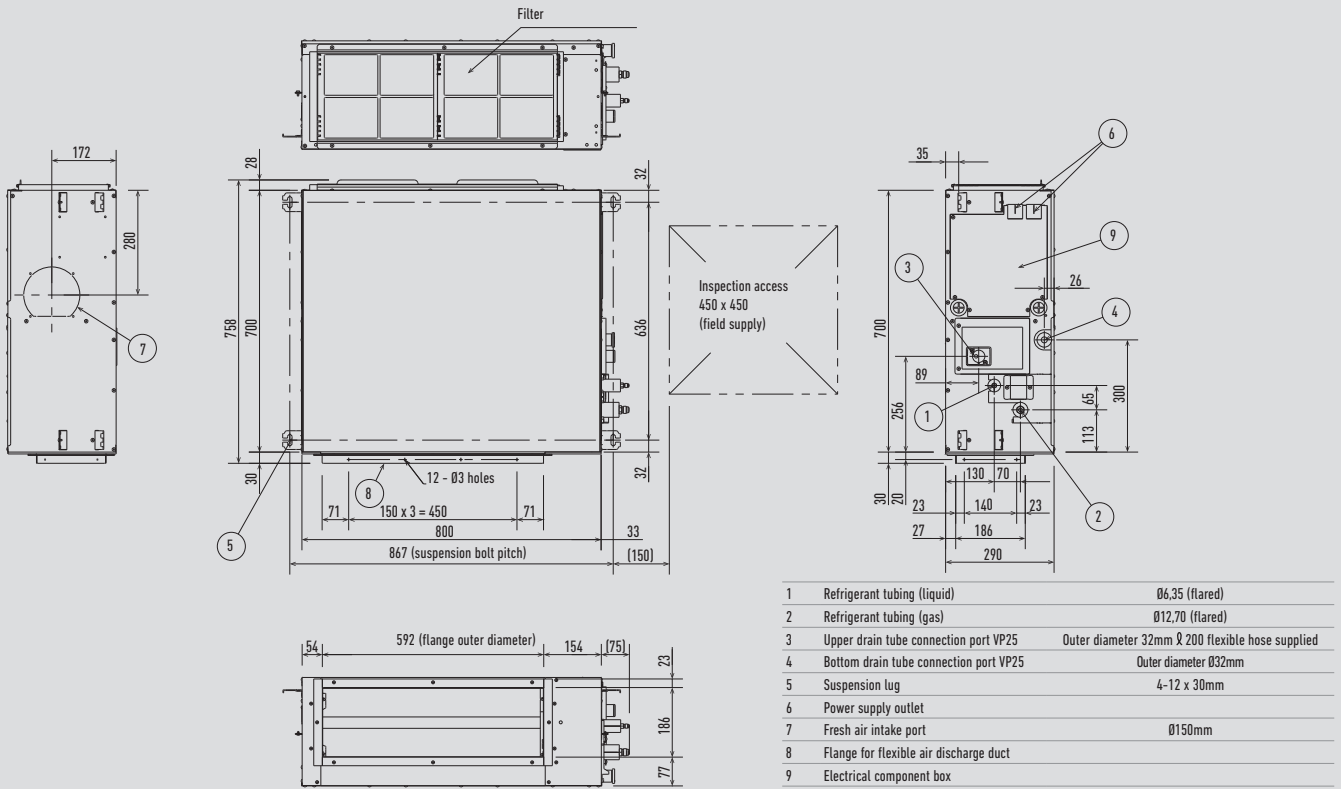

S-60PF1E5B / S-71PF1E5B

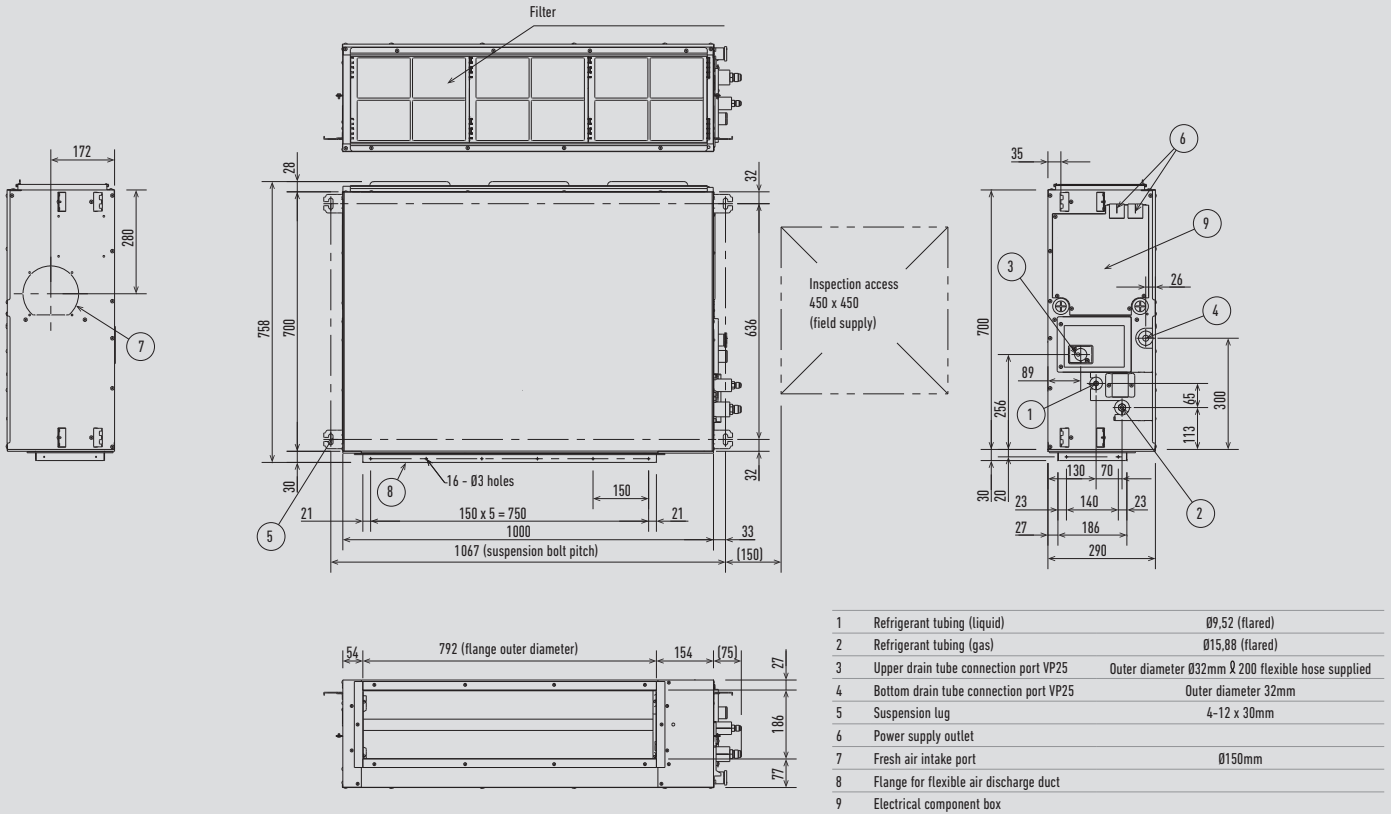

High Static Pressure Hide Away (Cont.)

S-100PF1E5B / S-125PF1E5B / S-140PF1E5B

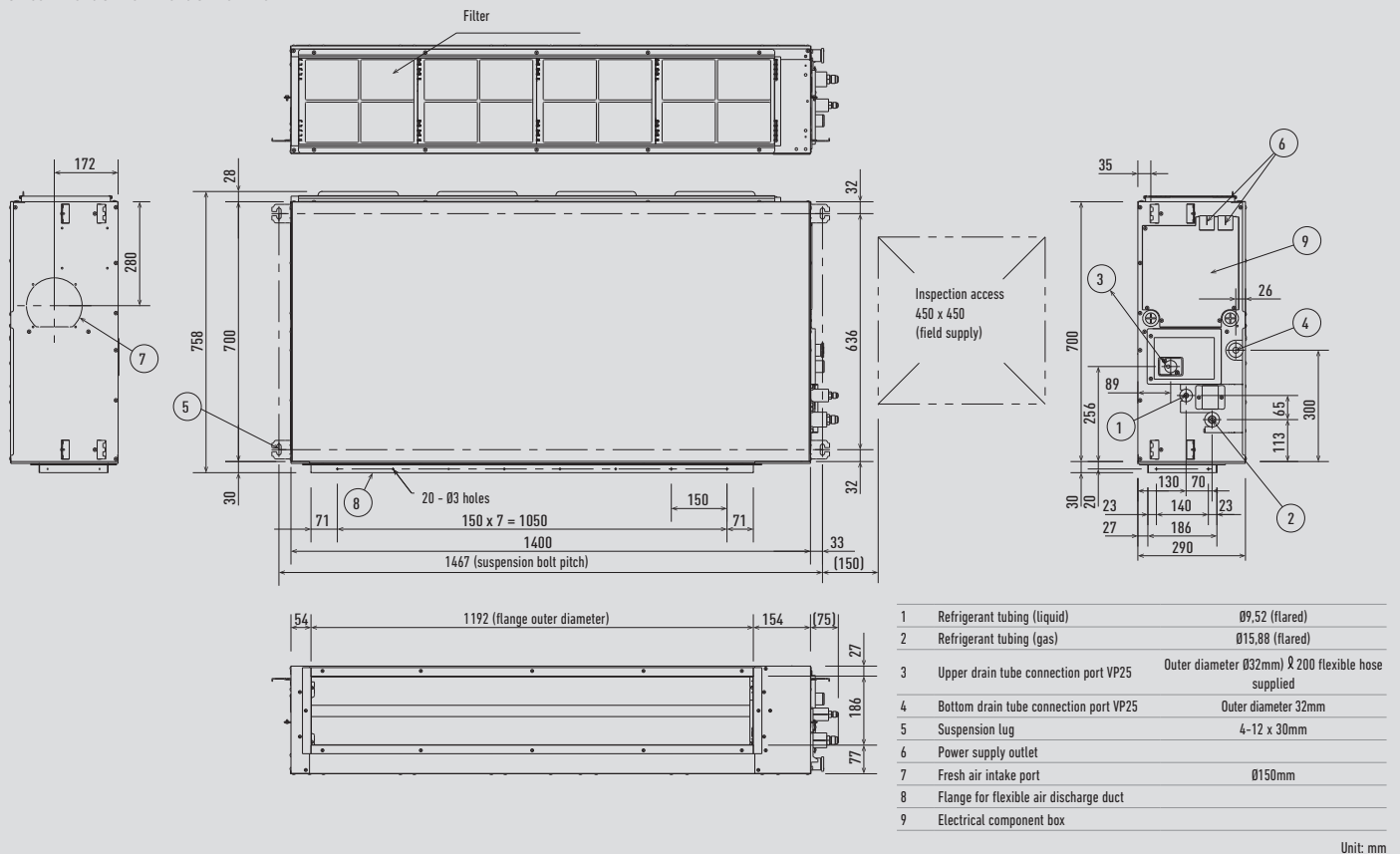

PACi Low Static Pressure Hide Away

S-36PN1E5A / S-45PN1E5A / S-50PN1E5A

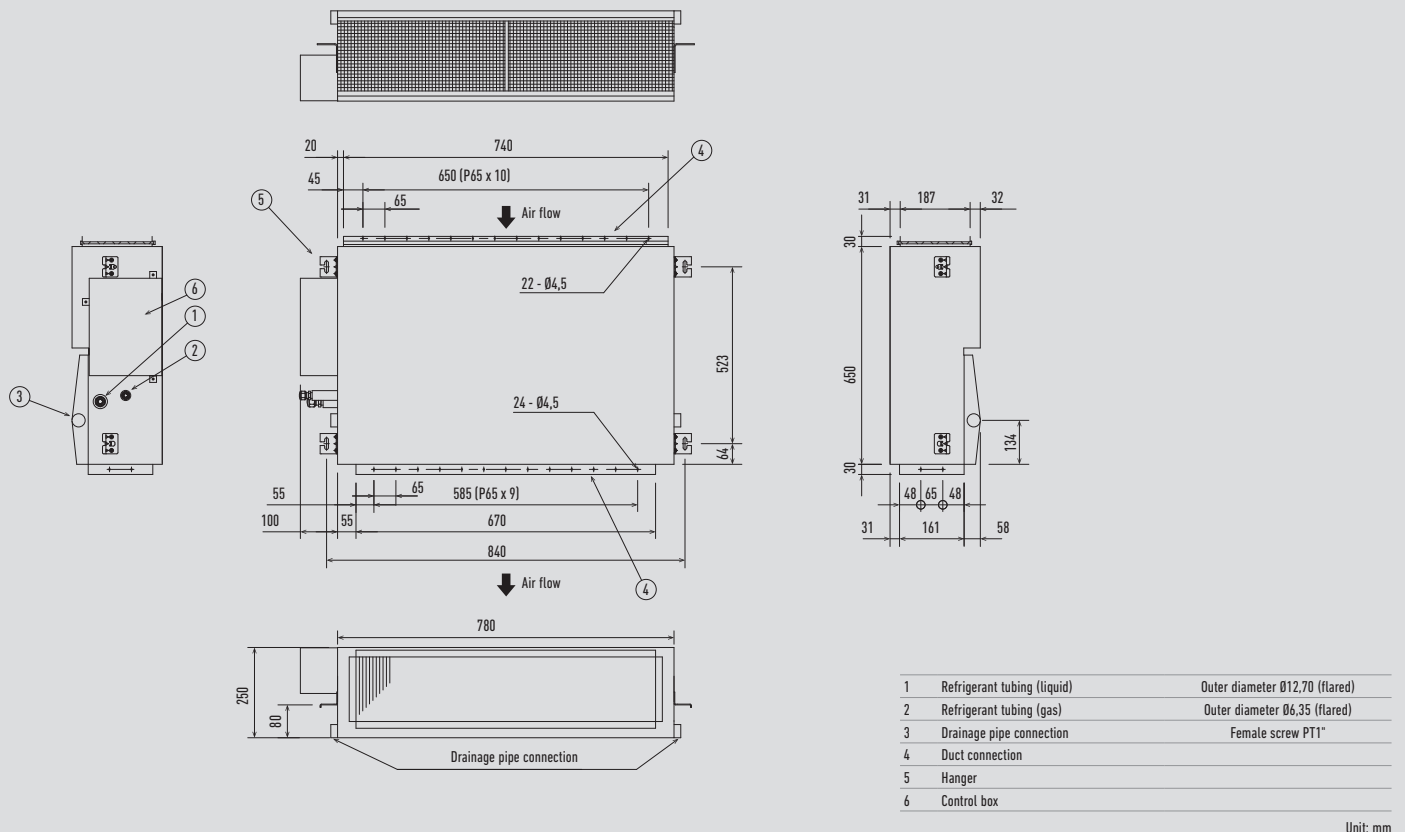

PACi Low Static Pressure Hide Away (Cont.)

S-60PN1E5A / S-71PN1E5A

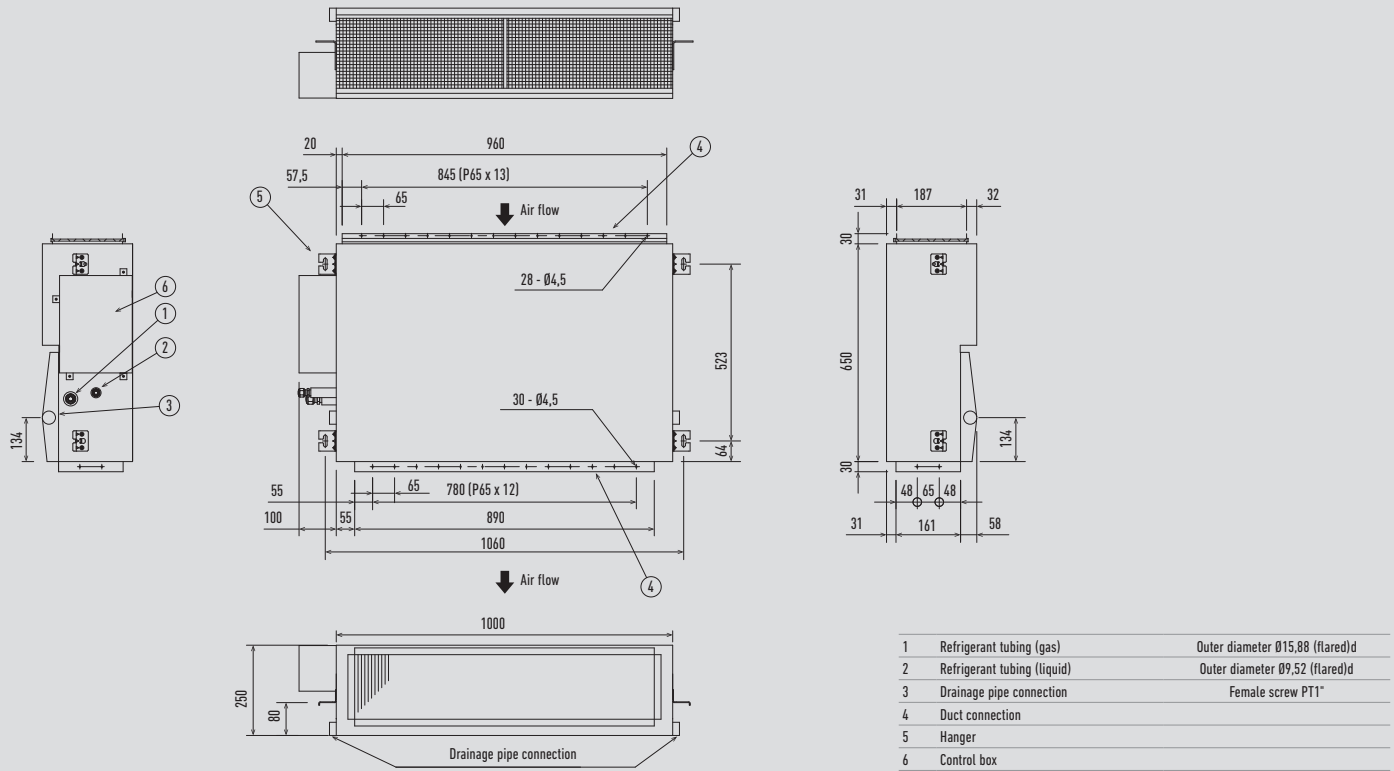

S-100PN1E5A / S-125PN1E5A / S-140PN1E5A

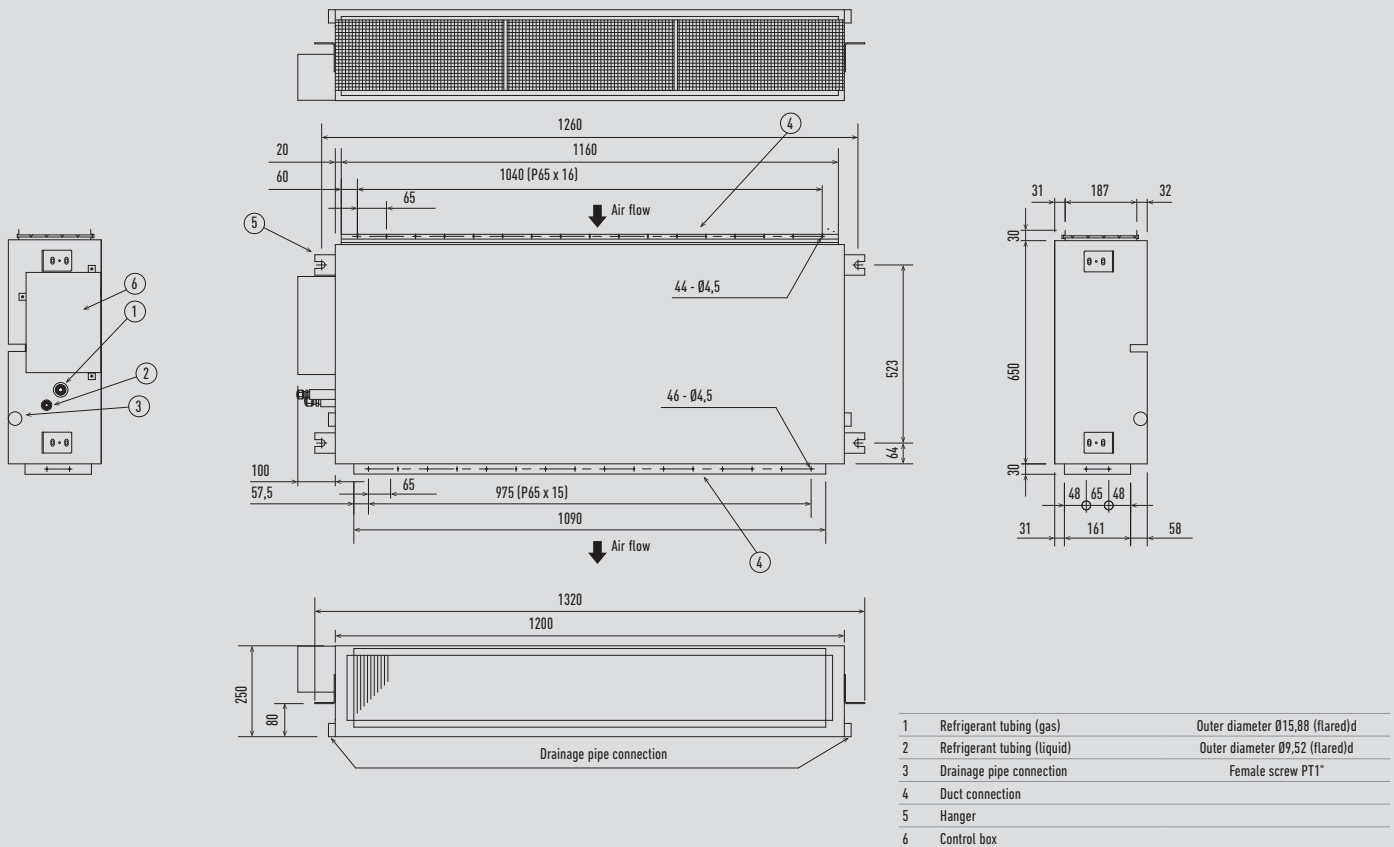

PACi High Static Pressure Hide Away 20,00-25,00kW

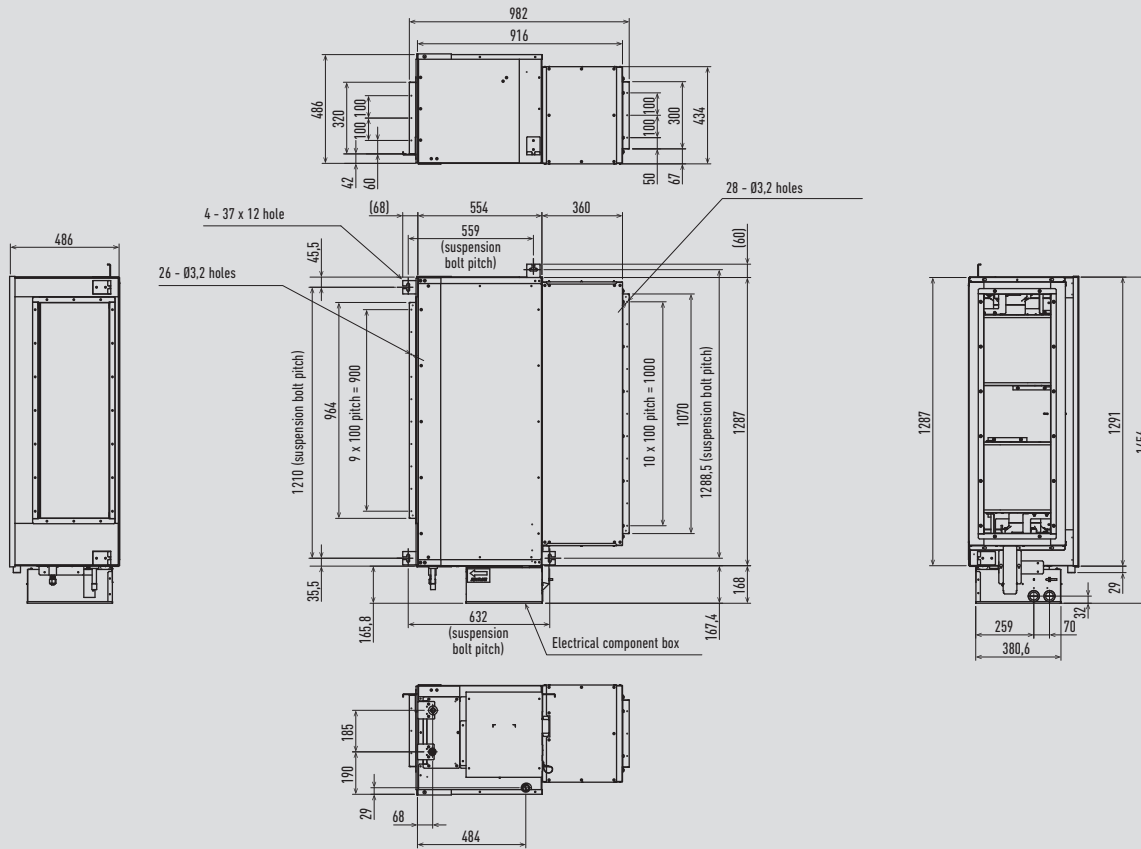

Unit: mm

PACi R32 outdoor unit: small 1 fan

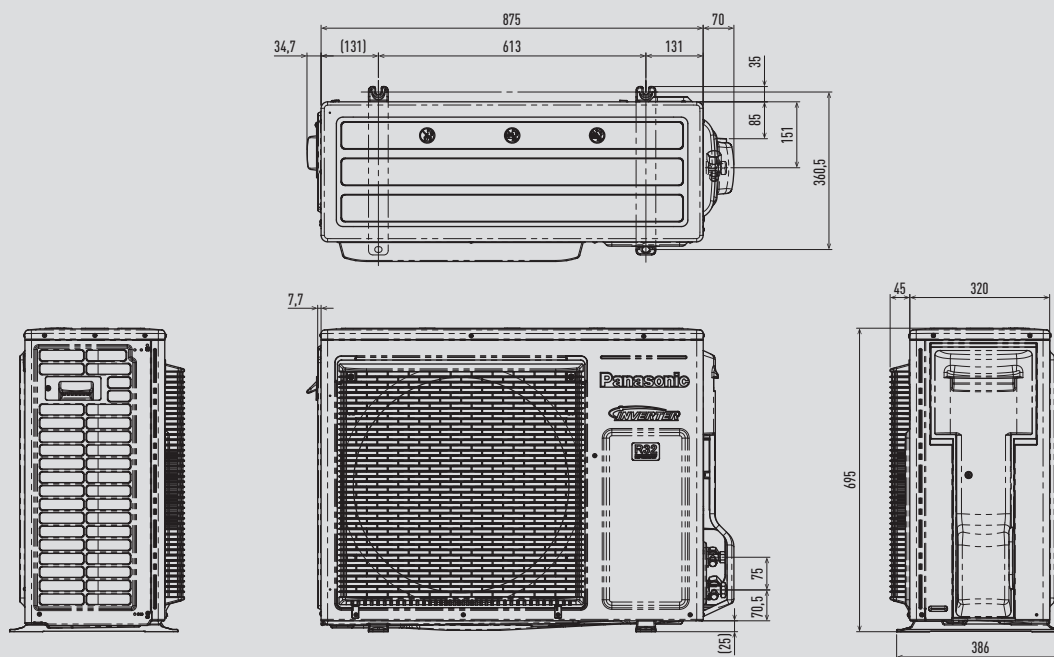

Unit: mm

PACi Elite R32 outdoor unit: medium 1 fan

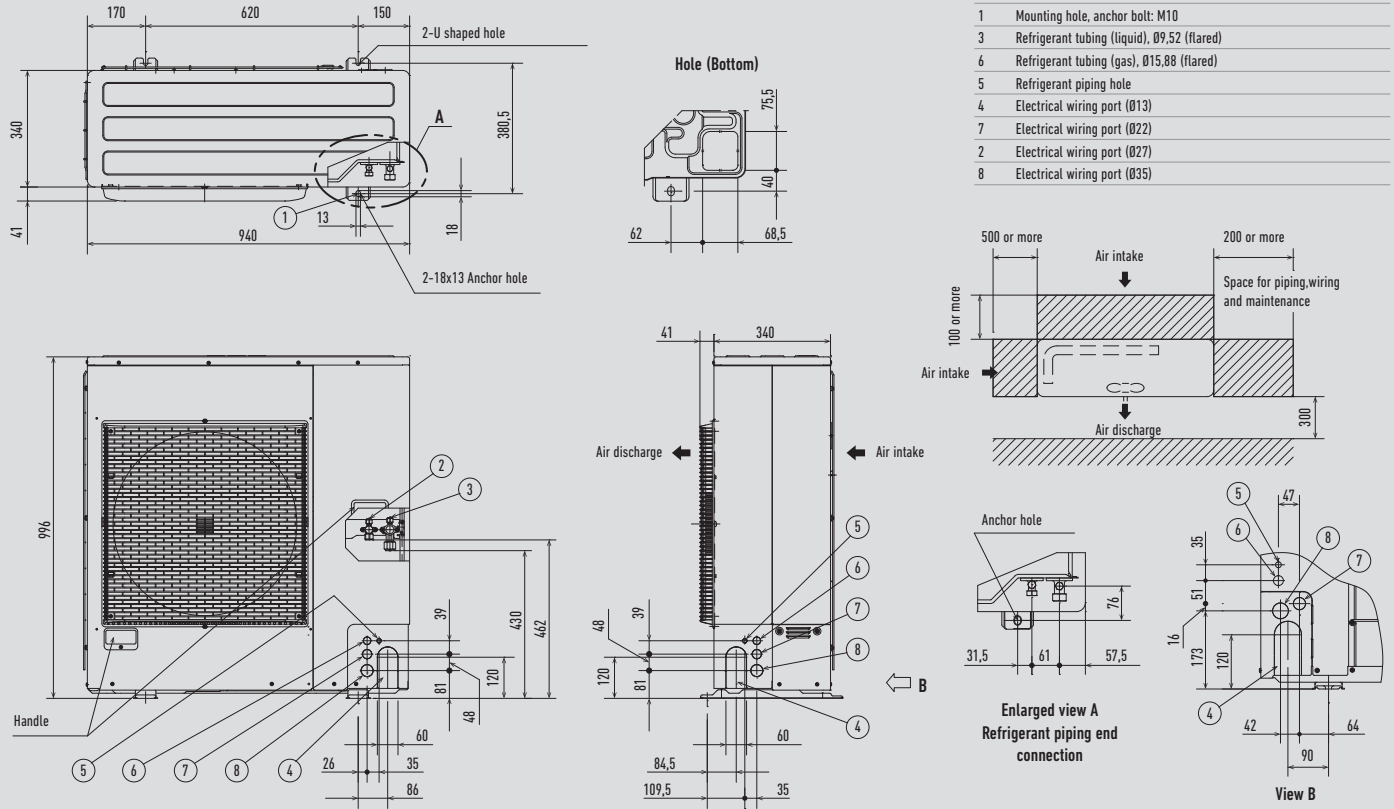

Unit: mm

PACi Standard R32 outdoor unit: medium 1 fan

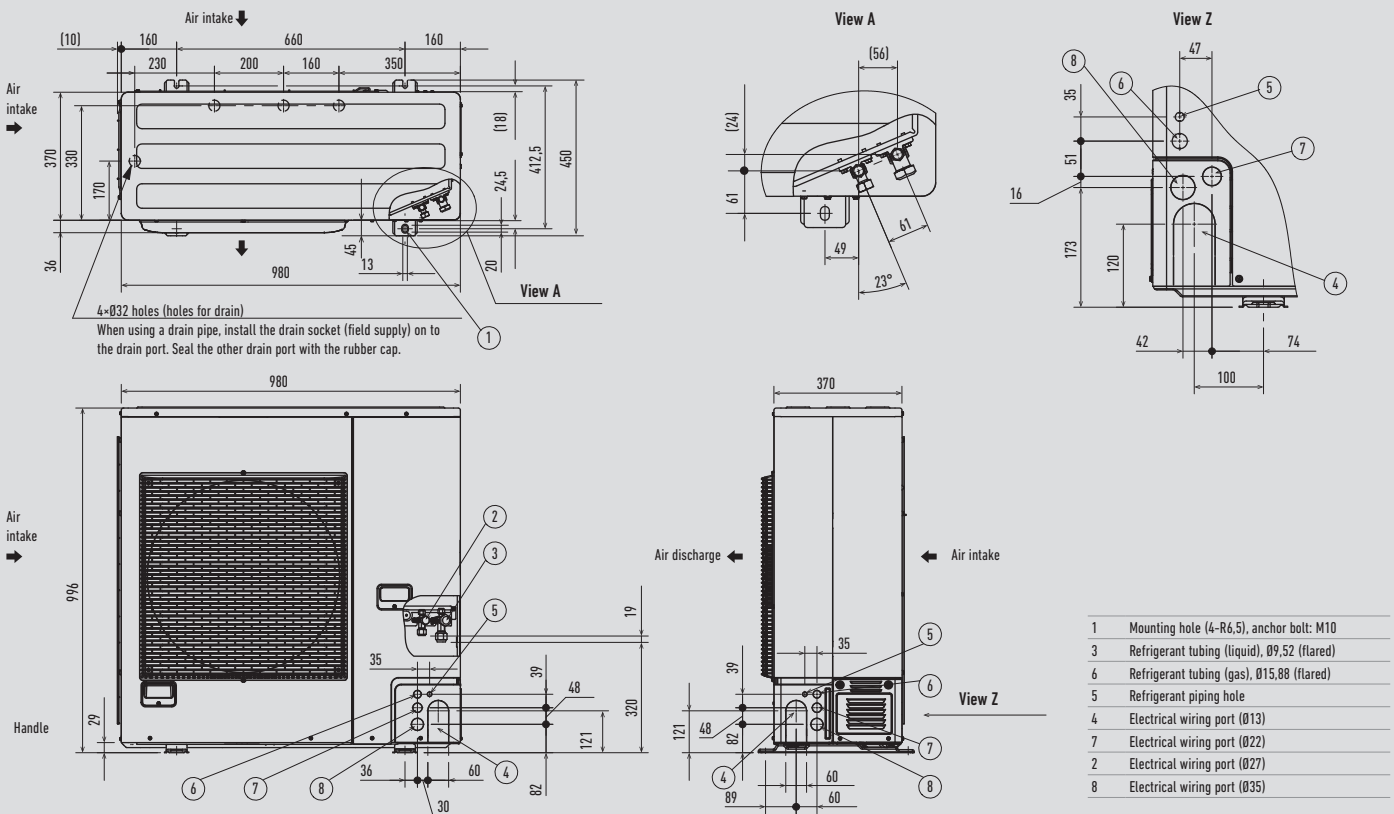

Unit: mm

PACi R410A outdoor unit: small 1 fan

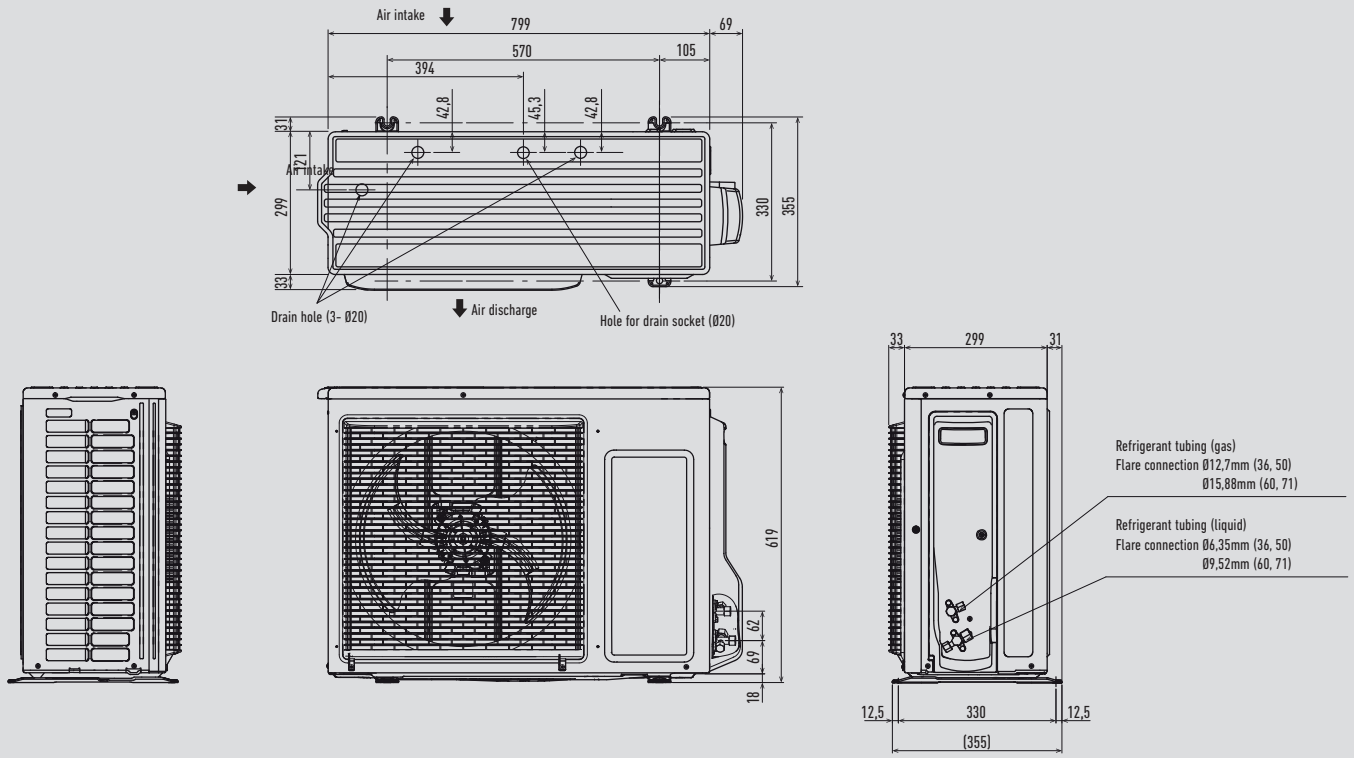

Unit: mm

PACi R410A outdoor unit: medium 1 fan

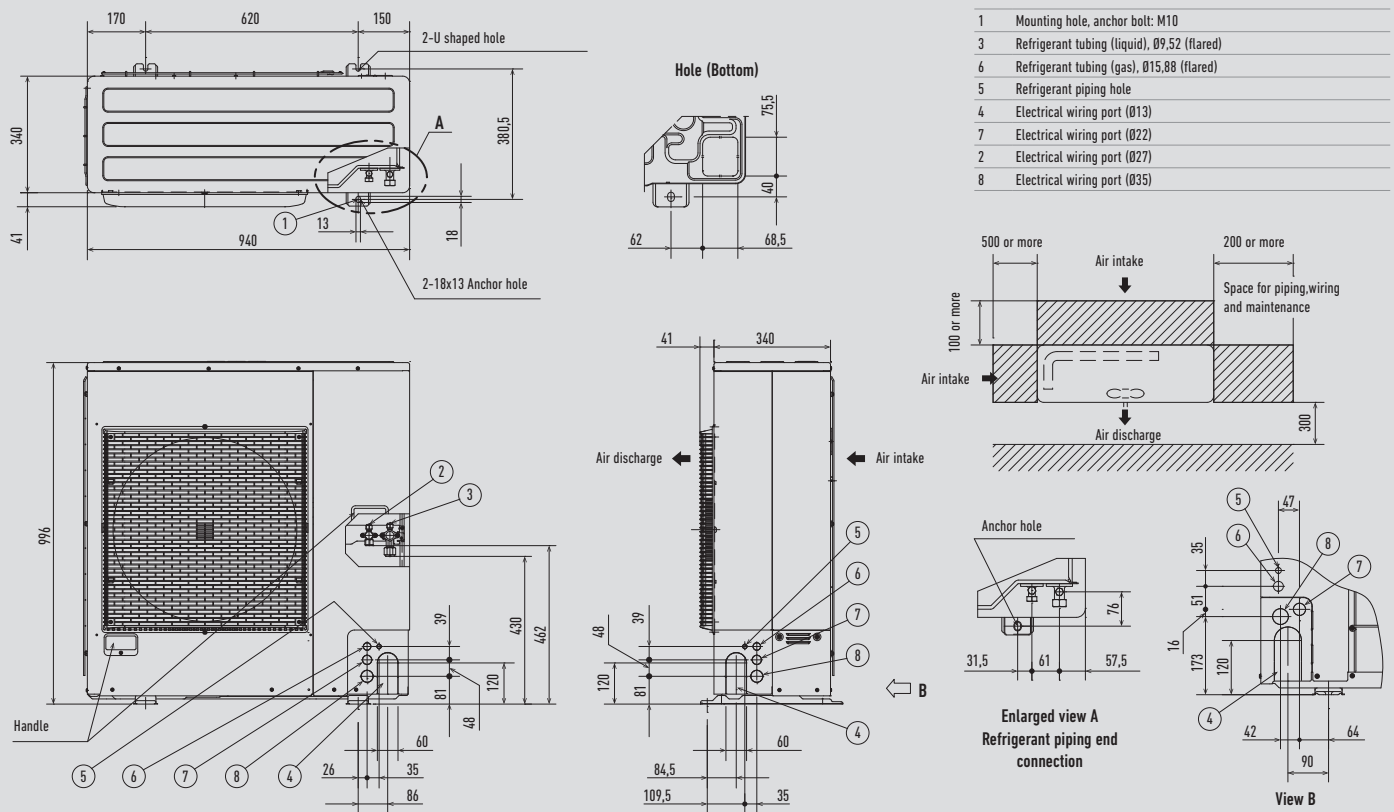

Unit: mm

AHU Connection Kit

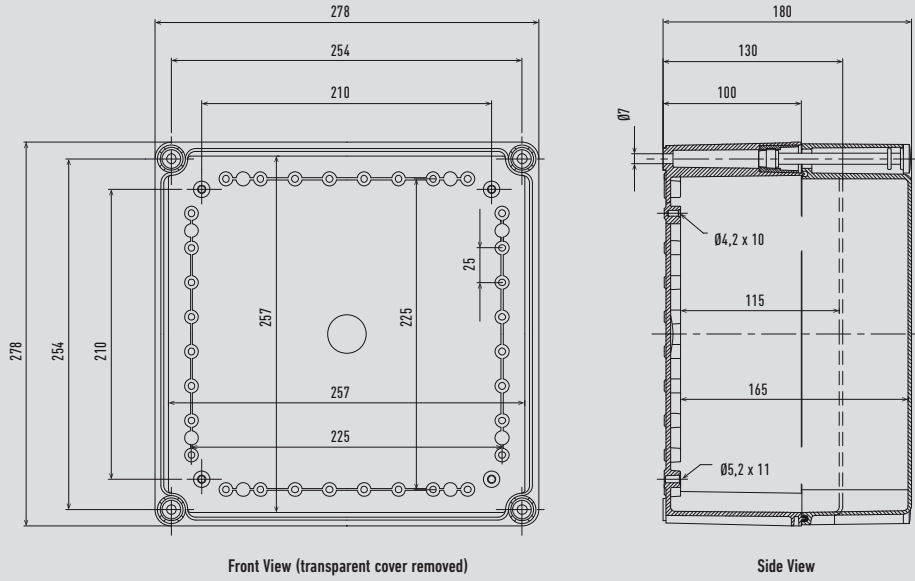

Unit: mm

Electric Air Curtain

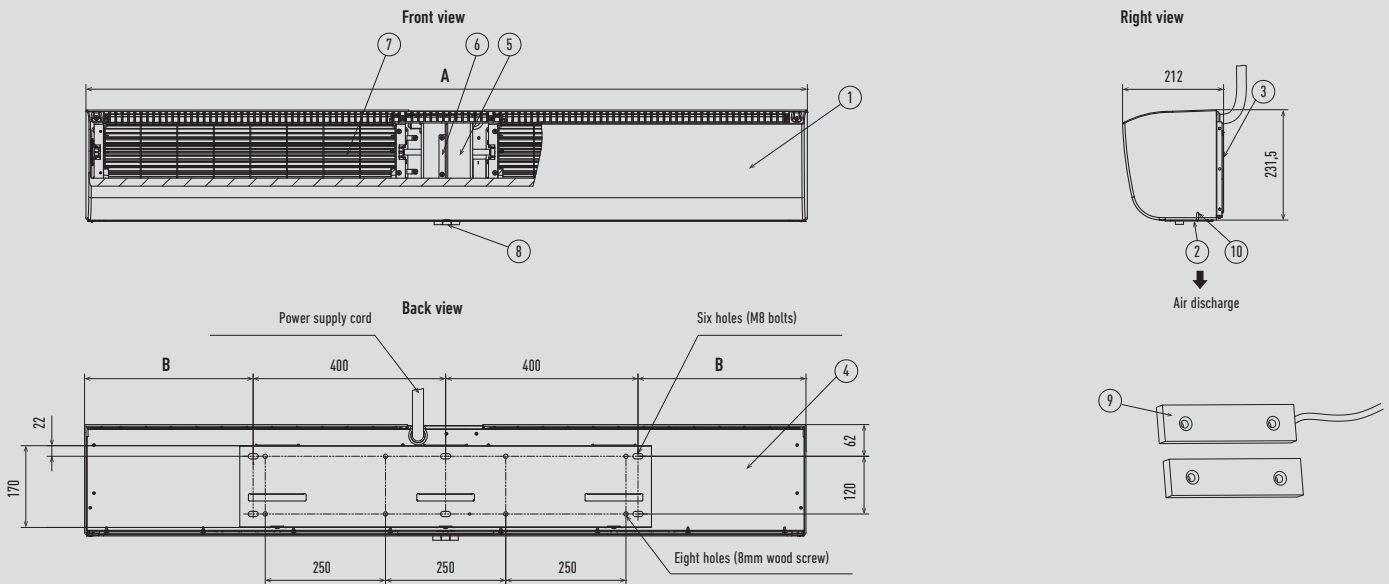

- 1 Front panel
- 2 Air discharge
- 3 Mounting plate
- 4 Back panel
- 5 Motor
- 6 Motor support
- 7 Cross-flow impeller
- 8 Push-button switch
- 9 Gate magnetic switch
- 10 Guide plate

	FY-3009U1	FY-3012U1	FY-3015U1
A	900	1200	1500
B	50	200	350

Unit: mm

Air Curtain with DX Coil

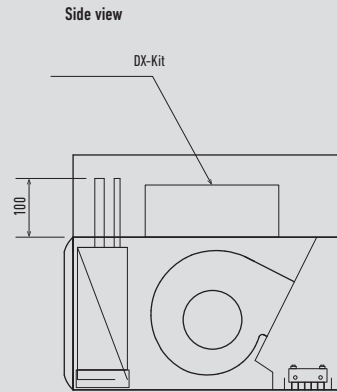
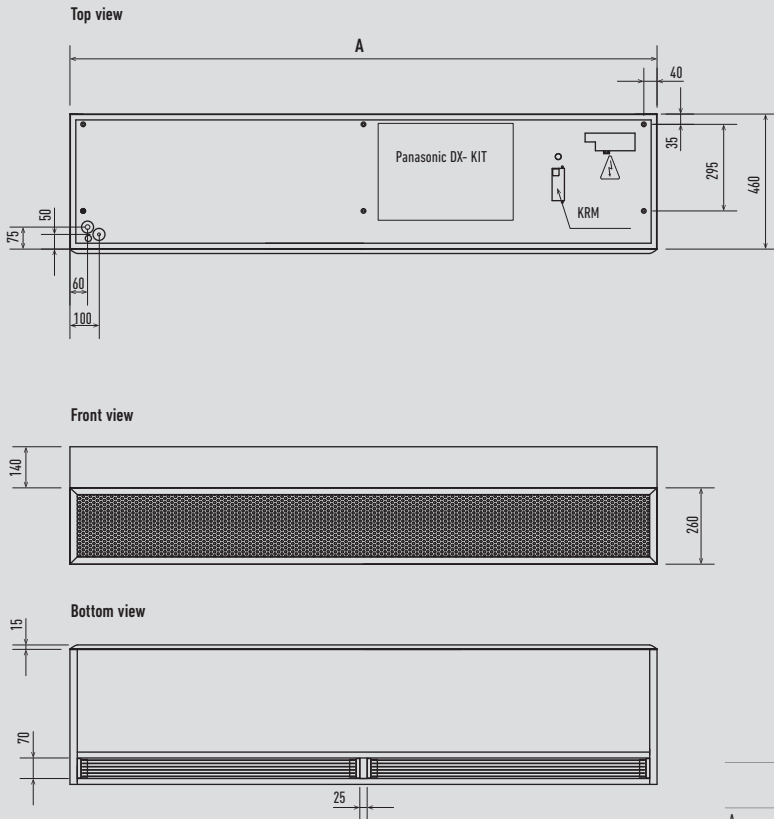

	PAW-10PAIRC-LS	PAW-15PAIRC-LS	PAW-20PAIRC-LS	PAW-25PAIRC-LS
	PAW-10PAIRC-HS	PAW-15PAIRC-HS	PAW-20PAIRC-HS	PAW-25PAIRC-HS
A	1,0m	1,5m	2,0m	2,5m

Unit: mm

Mini ECOi LE2 Series High Efficiency 4 to 6HP

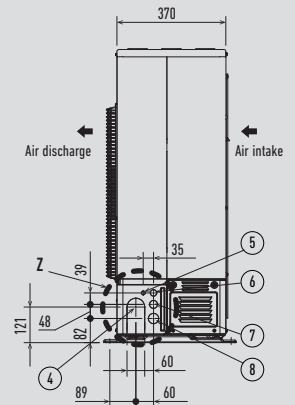
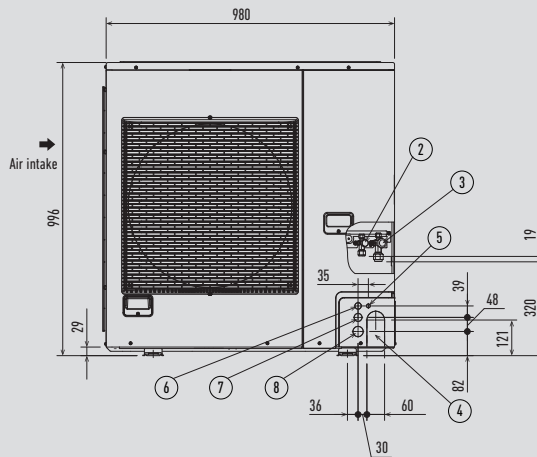
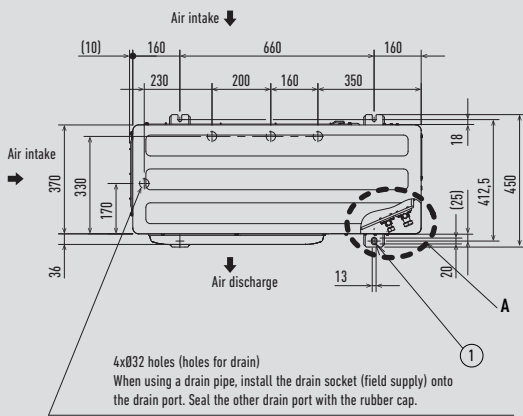

A View

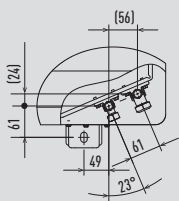

View Z

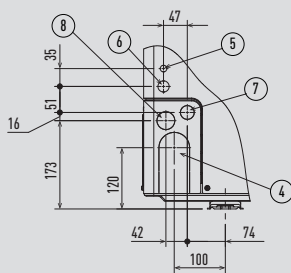

- 1 Mounting hole (4-R6.5), anchor bolt: M10
- 2 Refrigerant tubing (liquid), Ø9.52 (flared)
- 3 Refrigerant tubing (gas), Ø19.05 (flared)
- 4 Refrigerant piping port
- 5 Electrical wiring port (Ø13)
- 6 Electrical wiring port (Ø22)
- 7 Electrical wiring port (Ø27)
- 8 Electrical wiring port (Ø35)

Unit: mm

Mini ECOi LE1 Series High Efficiency 8 and 10HP

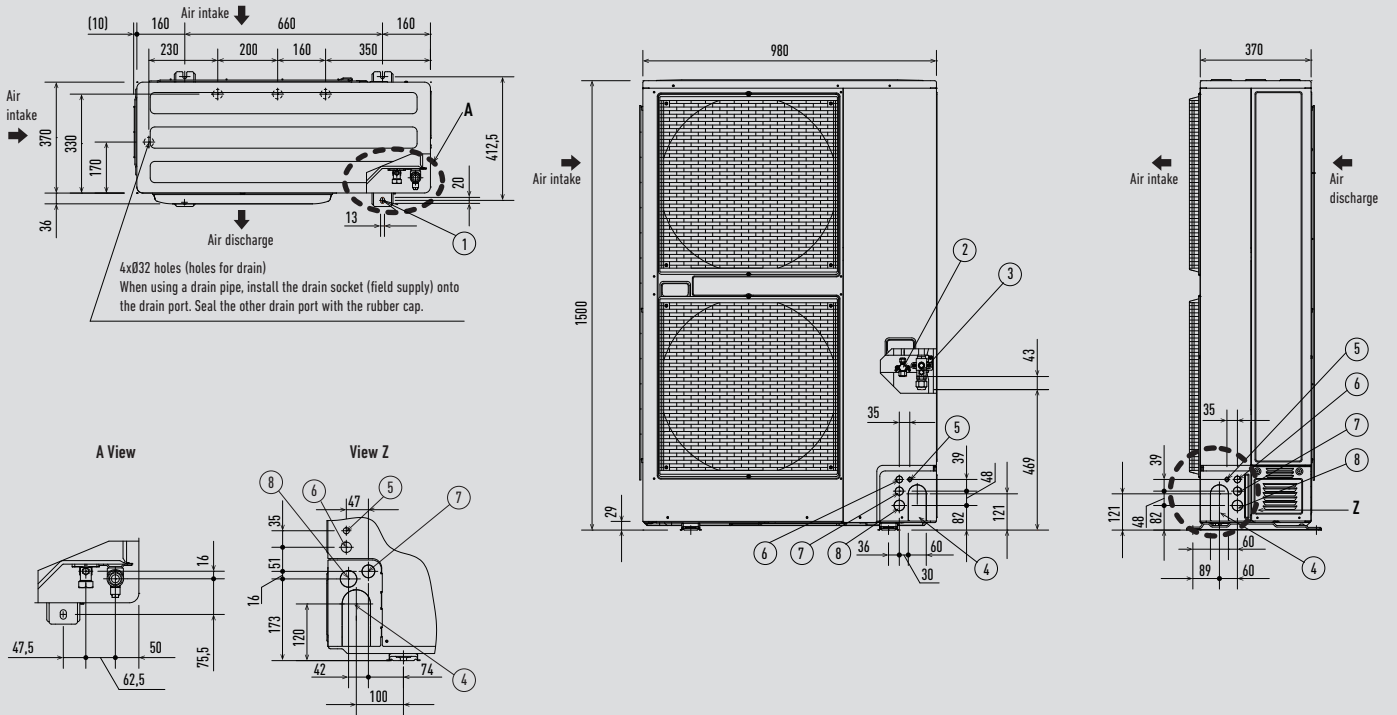

- | | | | |
|---|---|---|------------------------------|
| 1 | Mounting hole (4-R6,5), anchor bolt: M10 | 5 | Electrical wiring port (Ø13) |
| 2 | Refrigerant tubing (liquid), Ø9,52 (flared) | 6 | Electrical wiring port (Ø22) |
| 3 | Refrigerant tubing (gas), Ø19,05 (flared) | 7 | Electrical wiring port (Ø27) |
| 4 | Refrigerant piping port | 8 | Electrical wiring port (Ø35) |

The piping of the gas main has a diameter of $\phi 22.22$, but the connection to the service valve of the outdoor unit has a diameter of $\phi 19.05$, so a flare has to be used. Consequently, be sure to use the enclosed joint tube B and joint tube A in making connections (brazing).

Unit: mm

2-Pipe ECOi EX ME2 Series 8 and 10HP

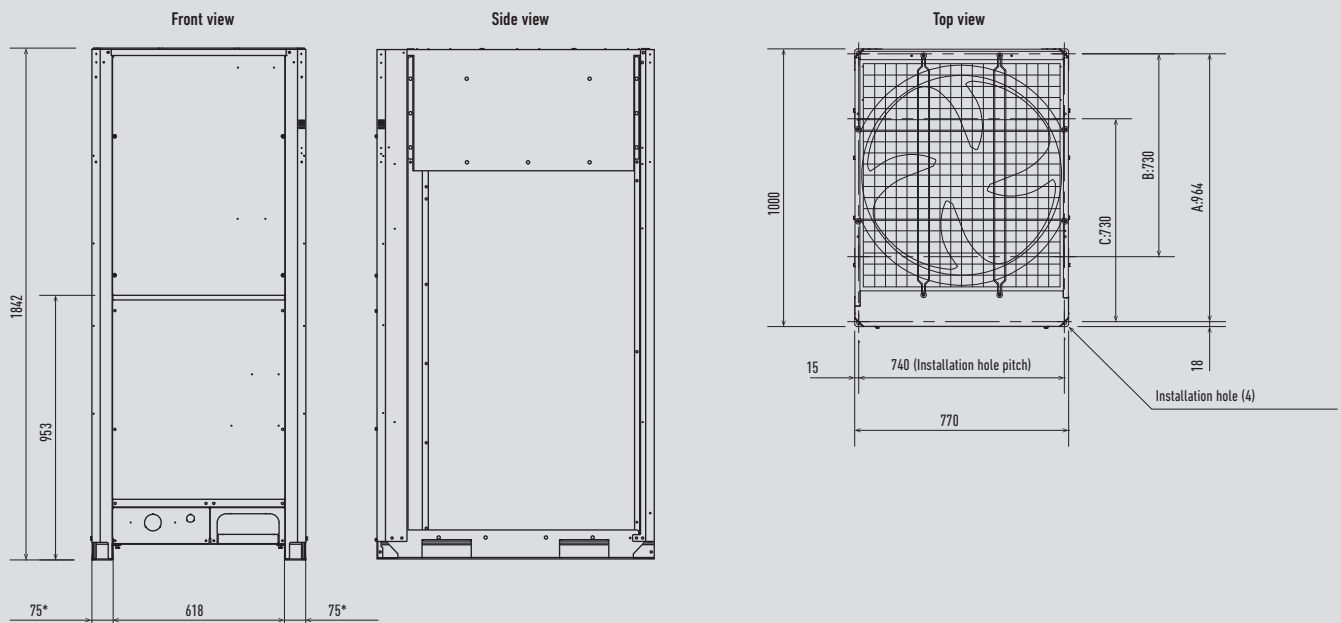

According to the installation site, you may choose the setting position in the depth direction of the anchor bolt from A, B or C.

- A: 964 (Installation hole pitch). The piping is routed out from the front.
- B: 730 (Installation hole pitch)*. The piping is routed out from the bottom.
- C: 730 (Installation hole pitch).

* Installation fixing bracket. Installation side.

Unit: mm

2-Pipe ECOi EX ME2 Series 12, 14 and 16HP / 3-Pipe ECOi EX MF3 Series 8-16HP

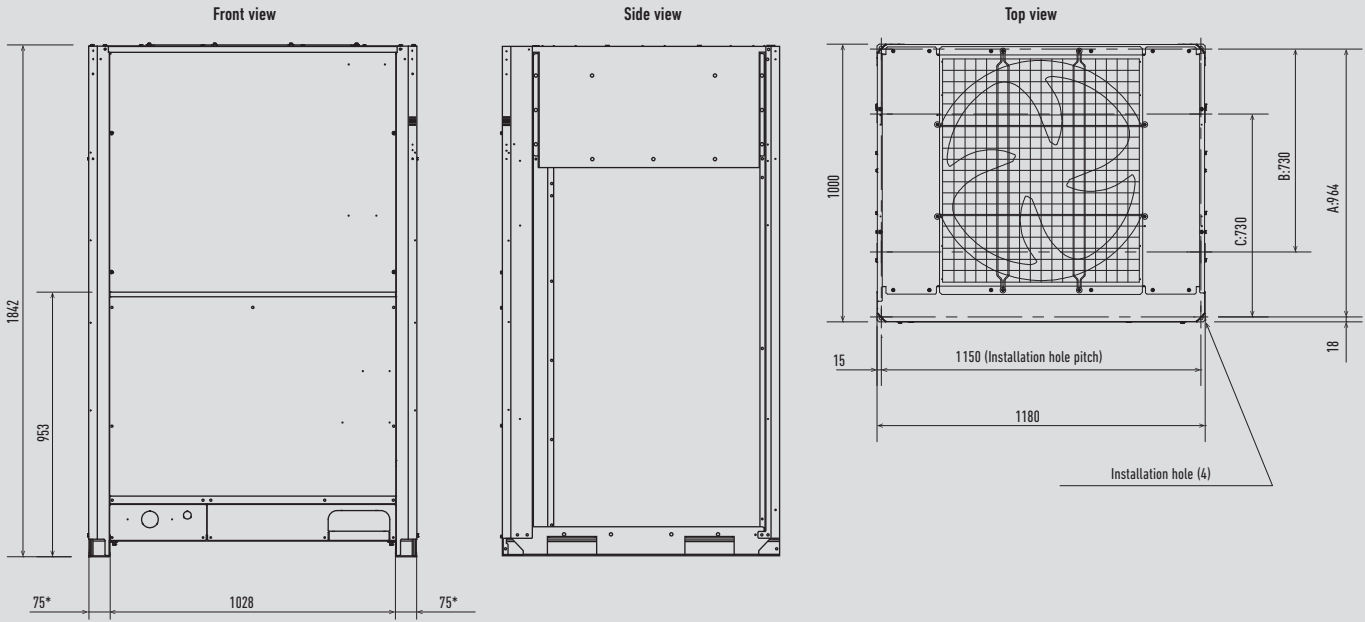

According to the installation site, you may choose the setting position in the depth direction of the anchor bolt from A, B or C.

- A: 964 (Installation hole pitch). The piping is routed out from the front.
- B: 730 (Installation hole pitch)*. The piping is routed out from the bottom.
- C: 730 (Installation hole pitch).

* Installation fixing bracket. Installation side.

Unit: mm

2-Pipe ECOi EX ME2 Series 18 and 20HP

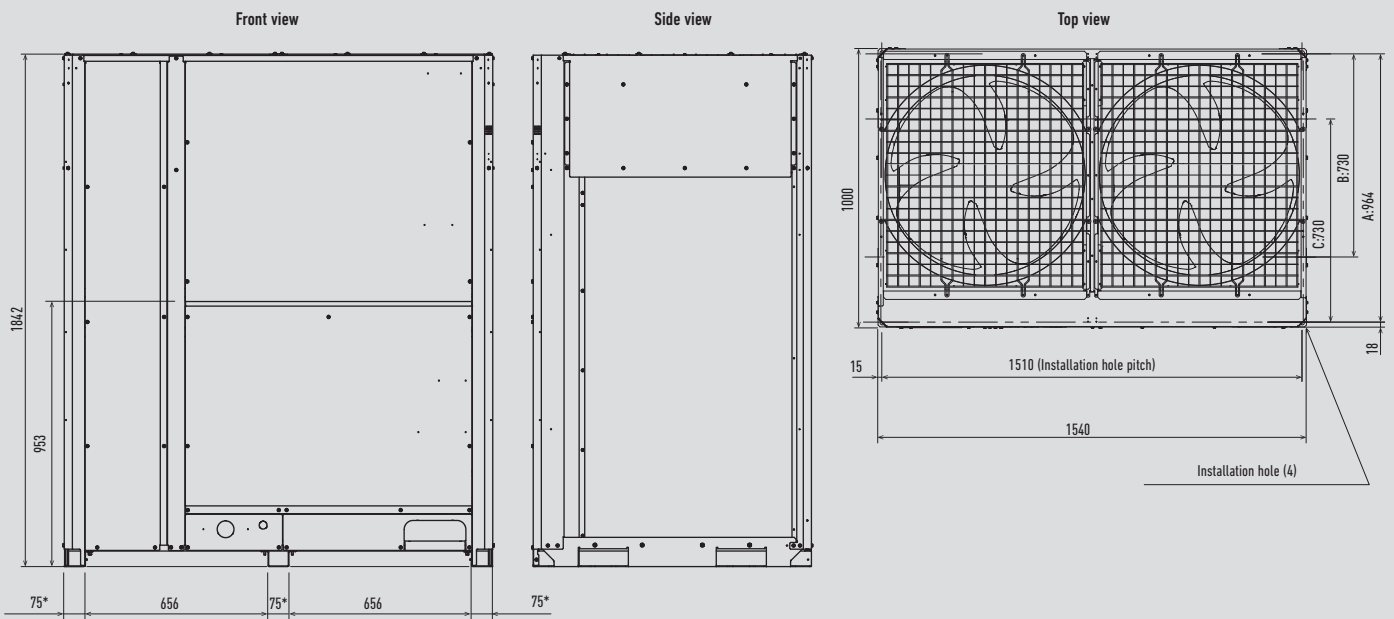

According to the installation site, you may choose the setting position in the depth direction of the anchor bolt from A, B or C.

- A: 964 (Installation hole pitch). The piping is routed out from the front.
- B: 730 (Installation hole pitch)*. The piping is routed out from the bottom.
- C: 730 (Installation hole pitch).

* Installation fixing bracket. Installation side.

Unit: mm

ECO G GE3 Series 16 and 20HP

Type	16HP	20HP
1 Refrigerant tubing (gas)	Ø28,58	
2 Refrigerant tubing (liquid)	Ø12,70 / Ø15,88	
3 Exhaust gas drain port	Hose outer diameter: Ø25 (accessory)	
4 Electrical power supply port	Ø28	
5 Inter-unit cable port	Ø28	
6 Fuel gas port	R3/4	
7 Condensation drain opening	Ø20	
8 Rain and condensation outlet		

9 Engine exhaust outlet	
10 Suspension holes 4-Ø20x30	
11 Anchor holes 4-22x30	
12 Segmented display	
13 Coolant intake (top)	
14 Air intake	
15 Coolant level	
16 Hot water inlet	Rp3/4
17 Hot water outlet	Rp3/4

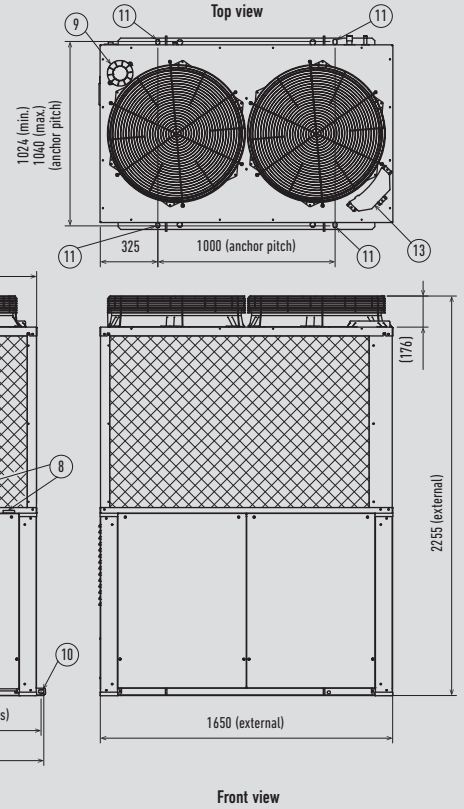

Unit: mm

ECO G GE3 Series 25 and 30HP

Type	25HP	30HP
1 Refrigerant tubing (gas)	Ø28,58	Ø31,75
2 Refrigerant tubing (liquid)	Ø15,88	Ø19,05
3 Exhaust gas drain port	Hose outer diameter: Ø25 (accessory)	
4 Electrical power supply port	Ø28	
5 Inter-unit cable port	Ø28	
6 Fuel gas port	R3/4	
7 Condensation drain opening	Ø20	
8 Rain and condensation outlet		

9 Engine exhaust outlet	
10 Suspension holes 4-Ø20x30	
11 Anchor holes 4-22x30	
12 Segmented display	
13 Coolant intake (top)	
14 Air intake	
15 Coolant level	
16 Hot water inlet	Rp3/4
17 Hot water outlet	Rp3/4

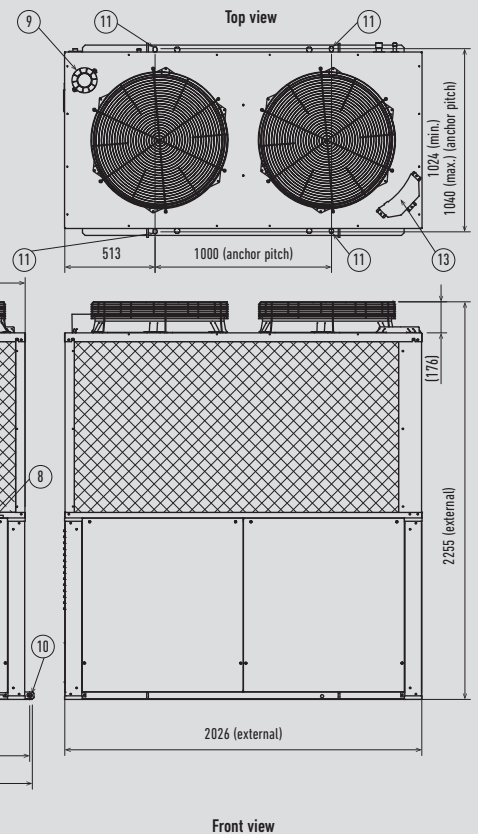

Unit: mm

ECO G GF3 Series 16 and 20HP

Type	16HP	20HP
1 Suction refrigerant tubing (gas)		Ø28,58
2 Discharge refrigerant tubing (gas)	Ø22,22	Ø25,40
3 Refrigerant tubing (liquid)		Ø19,05
4 Exhaust gas drain port	Hose outer diameter: Ø25 (accessory)	
5 Electrical power supply port		Ø28
6 Inter-unit cable port		Ø28
7 Fuel gas port		R3/4
8 Condensation drain opening		Ø20

9 Rain and condensation outlet	
10 Engine exhaust outlet	
11 Suspension holes 4-Ø20x30	
12 Anchor holes 4-22x30	
13 Segmented display	
14 Coolant intake (top)	
15 Air intake	
16 Coolant level	
17 Hot water inlet	Rp3/4
18 Hot water outlet	Rp3/4

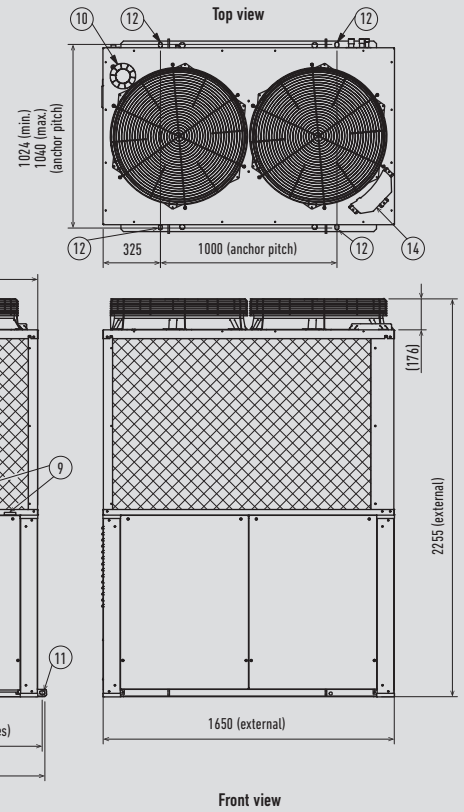

Unit: mm

ECO G GF3 Series 25HP

1 Suction Refrigerant tubing (gas)	Ø28,58
2 Discharge Refrigerant tubing (gas)	Ø25,40
3 Refrigerant tubing (liquid)	Ø19,05
4 Exhaust gas drain port	Hose outer diameter: Ø25 (accessory)
5 Electrical power supply port	Ø28
6 Inter-unit cable port	Ø28
7 Fuel gas port	R3/4
8 Condensation drain opening	Ø20
9 Rain and condensation outlet	

10 Engine exhaust outlet	
11 Suspension holes 4-Ø20x30	
12 Anchor holes 4-22x30	
13 Segmented display	
14 Coolant intake (top)	
15 Air intake	
16 Coolant level	
17 Hot water inlet	Rp3/4
18 Hot water outlet	Rp3/4

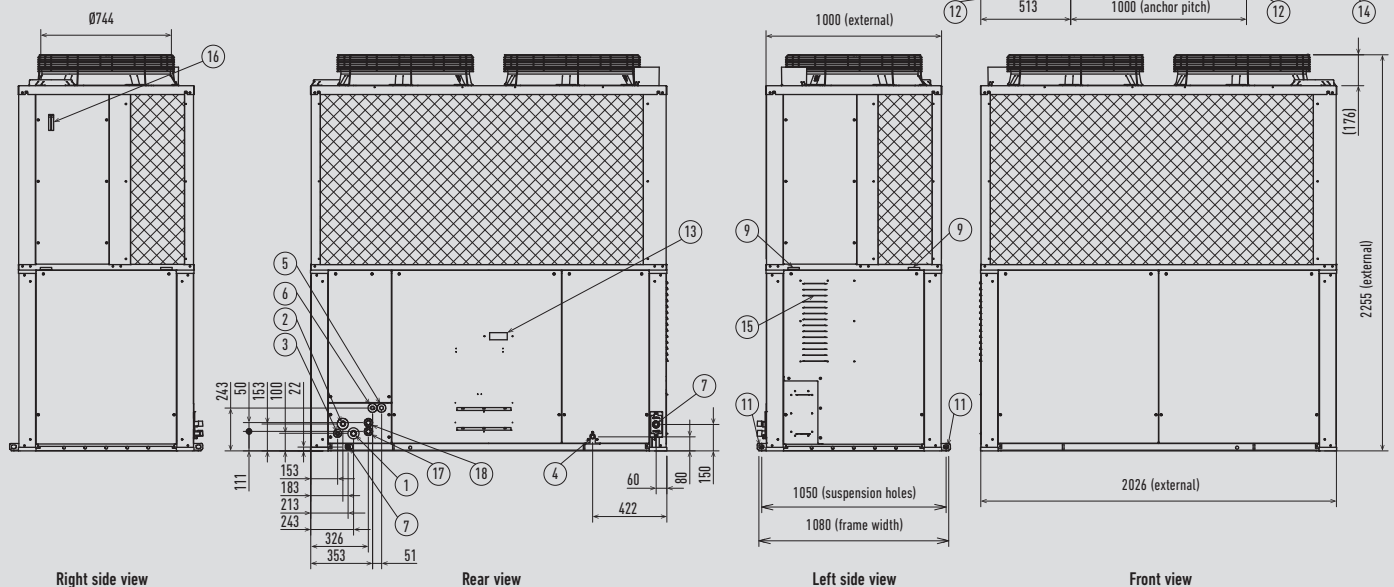

Unit: mm

3-Pipe Control Box Kit / Multiple connection type

Heat Recovery Box Dimensions

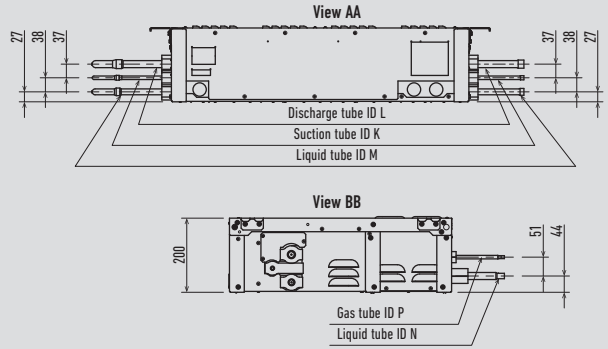
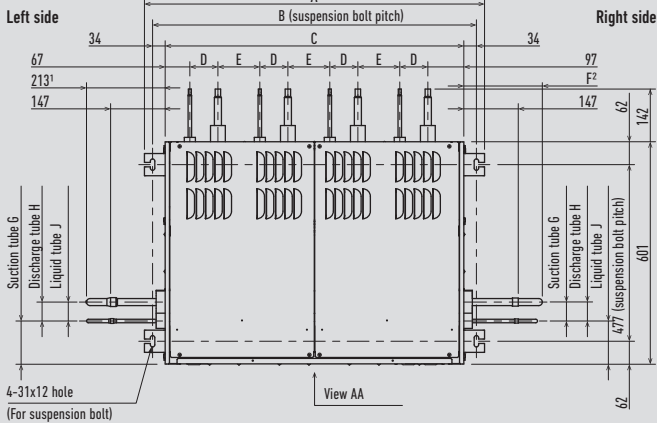

	A	B	C	D	E	F	G	H	J	K	L	M	N	P
Type 456	919	874	807	67	113	213	51	51	117	Ø19,05	Ø15,88	Ø9,52	Ø6,35	Ø12,70
Type 4160	919	874	807	67	113	207	55	54	113	Ø9,52	Ø15,88	Ø28,58	Ø25,40	Ø15,88
Type 656	1297	1253	1185	67	113	213	54	55	115	Ø25,40	Ø19,05	Ø12,70	Ø6,35	Ø12,70
Type 856	1675	1631	1563	67	113	213	53	53	115	Ø28,58	Ø22,22	Ø12,70	Ø6,35	Ø12,70

- 1) In case of right side connection.
- 2) Including the protection tubes when connecting to the left side.

Valve Dimensions

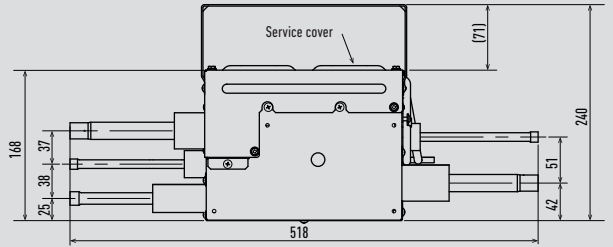
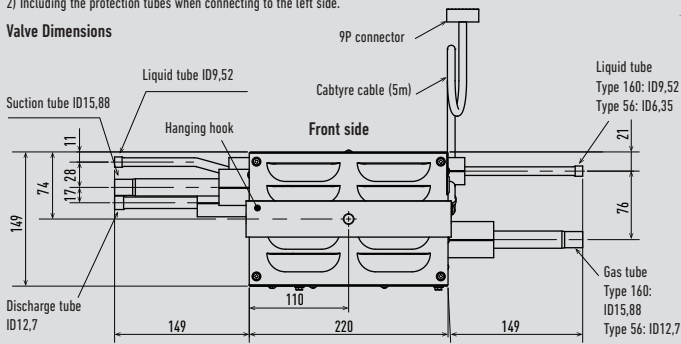

Unit: mm

Water Heat Exchanger for chilled and hot water production

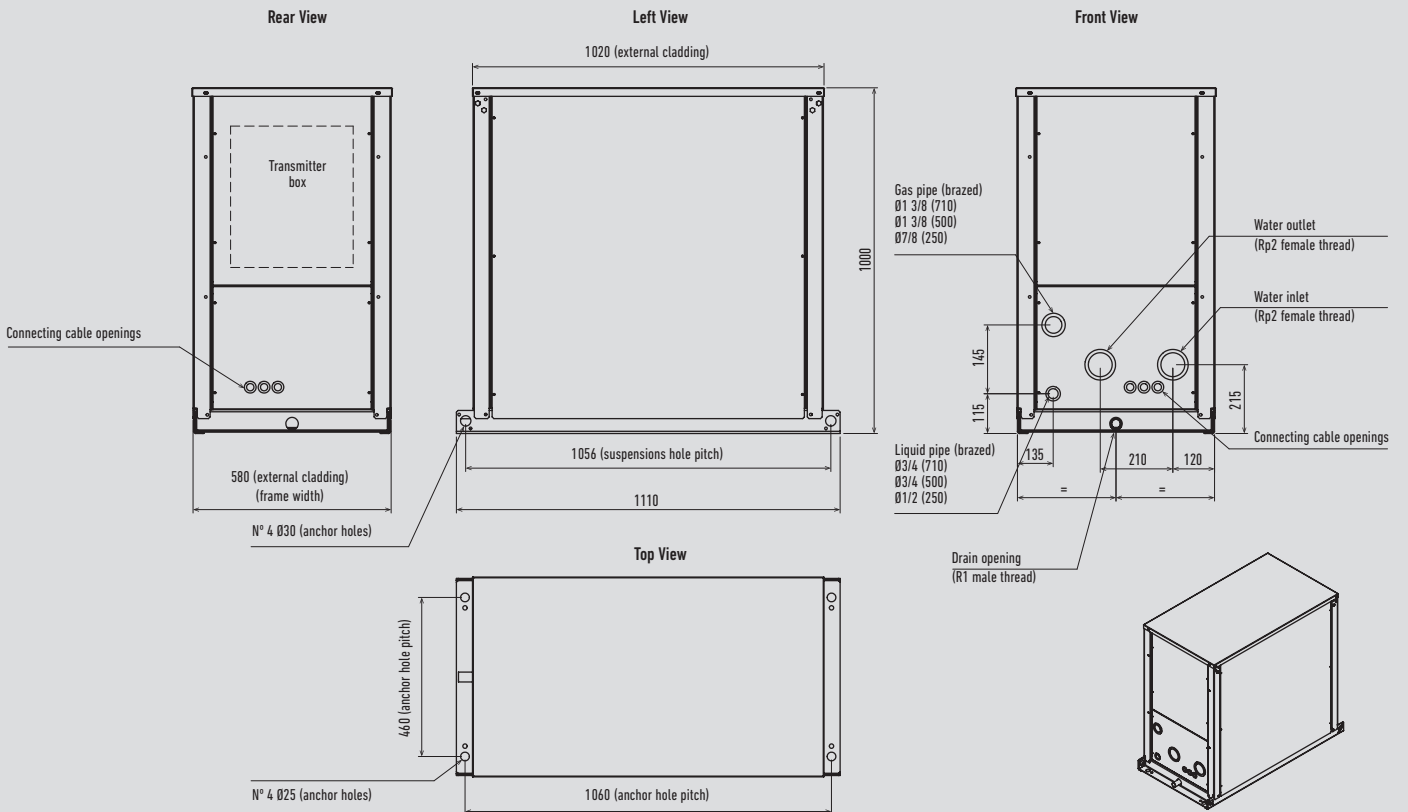

Unit: mm

U2 Type 4 Way 90x90 Cassette

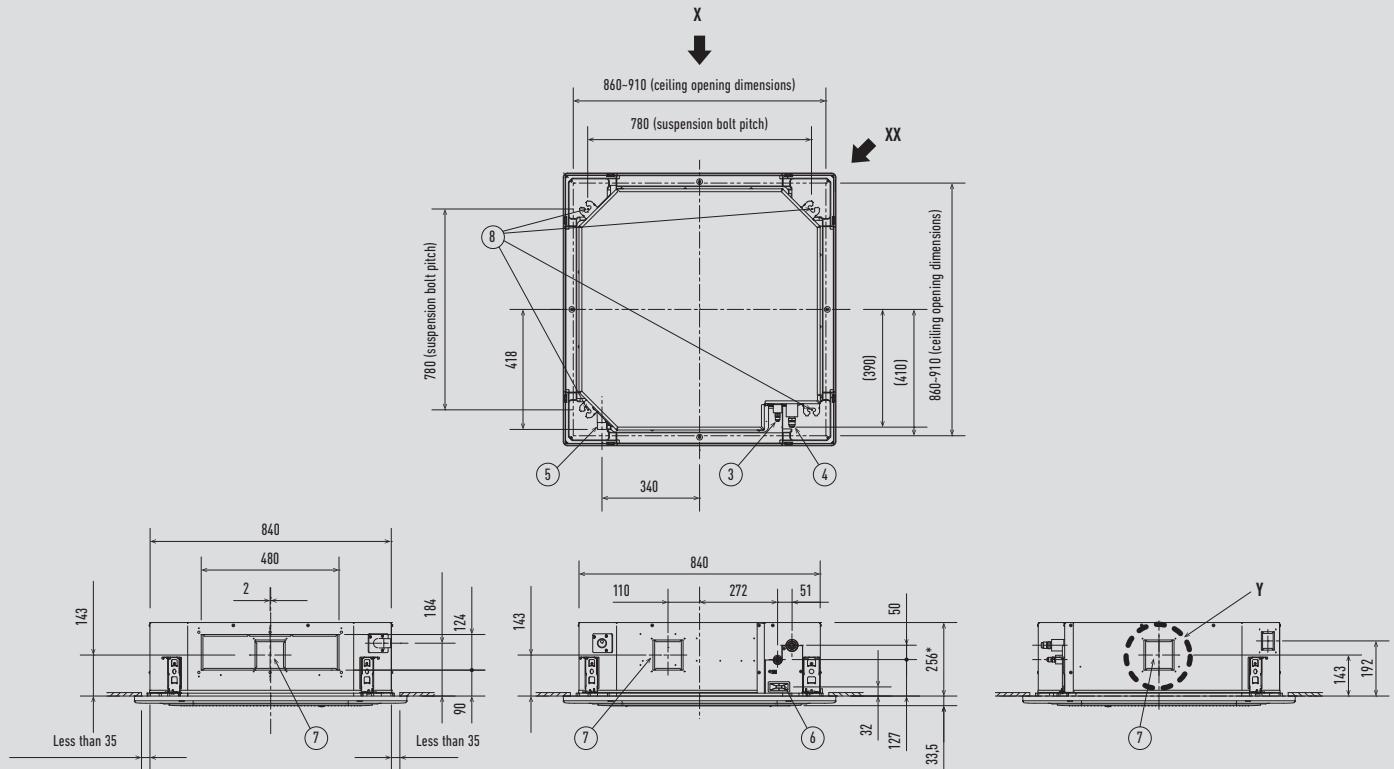

Raise dimension of drain tube

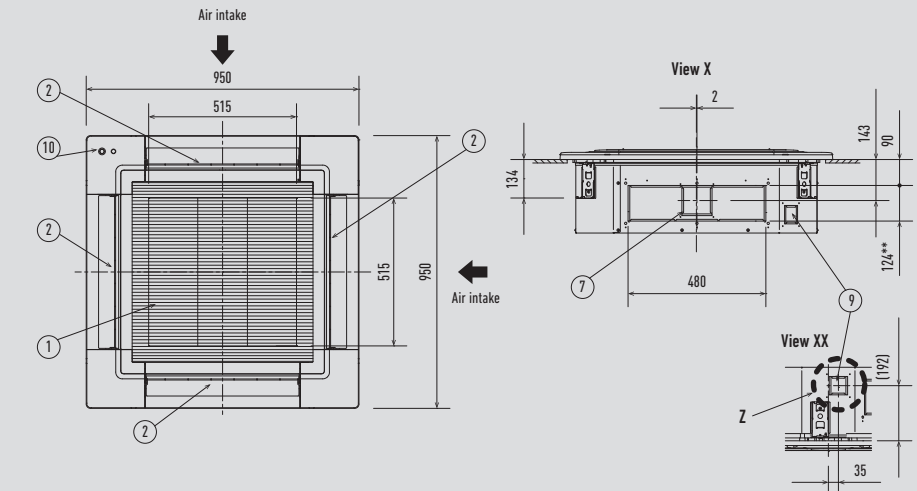
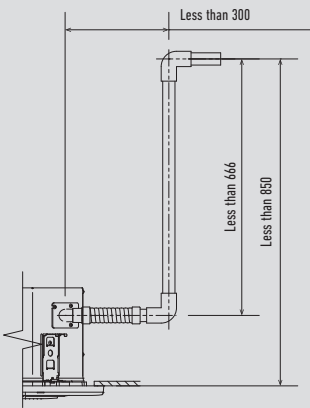

The length of the suspension bolts should be selected so that there is a gap of 30mm or more below the lower surface of the ceiling (18mm or more below the lower surface of the main unit), as shown in the figure at right. If the suspension bolt is too long, it will contact the ceiling panel and the unit cannot be installed.

Filter dimension: 520 x 520 x 15mm.

* 319mm for S-106MU2ESA / S-140MU2ESA / S-160MU2ESA.
** 187mm for S-106MU2ESA / S-140MU2ESA / S-160MU2ESA.

Type	22-56	60-160
1 Air intake		
2 Discharge outlet		
3 Refrigerant tubing (liquid)	Ø6,35 (flared)	Ø9,52 (flared)
4 Refrigerant tubing (gas)	Ø12,70 (flared)	Ø15,88 (flared)
5 Drain tube connection port VP25	Outer diameter Ø32	
6 Power supply port		
7 Suspension bolt hole	4-12x30 elongated hole	
8 Fresh air intake duct connection port	Ø100 ¹⁾	
9 Suspension bolt hole	4-12x30 elongated hole	
10 Econavi sensor (Only CZ-KPU3A)		

1) Necessary to attach duct connecting flange(field supplied).

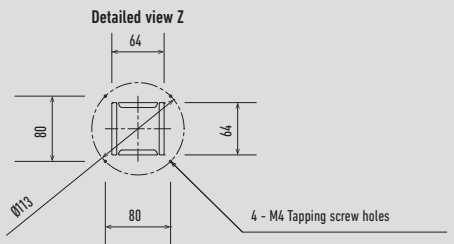
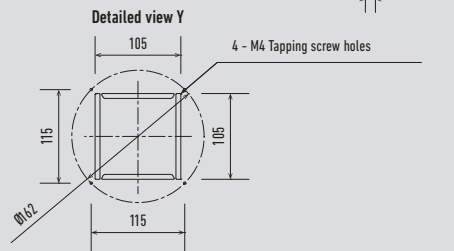

Y2 Type 4 Way 60x60 Cassette

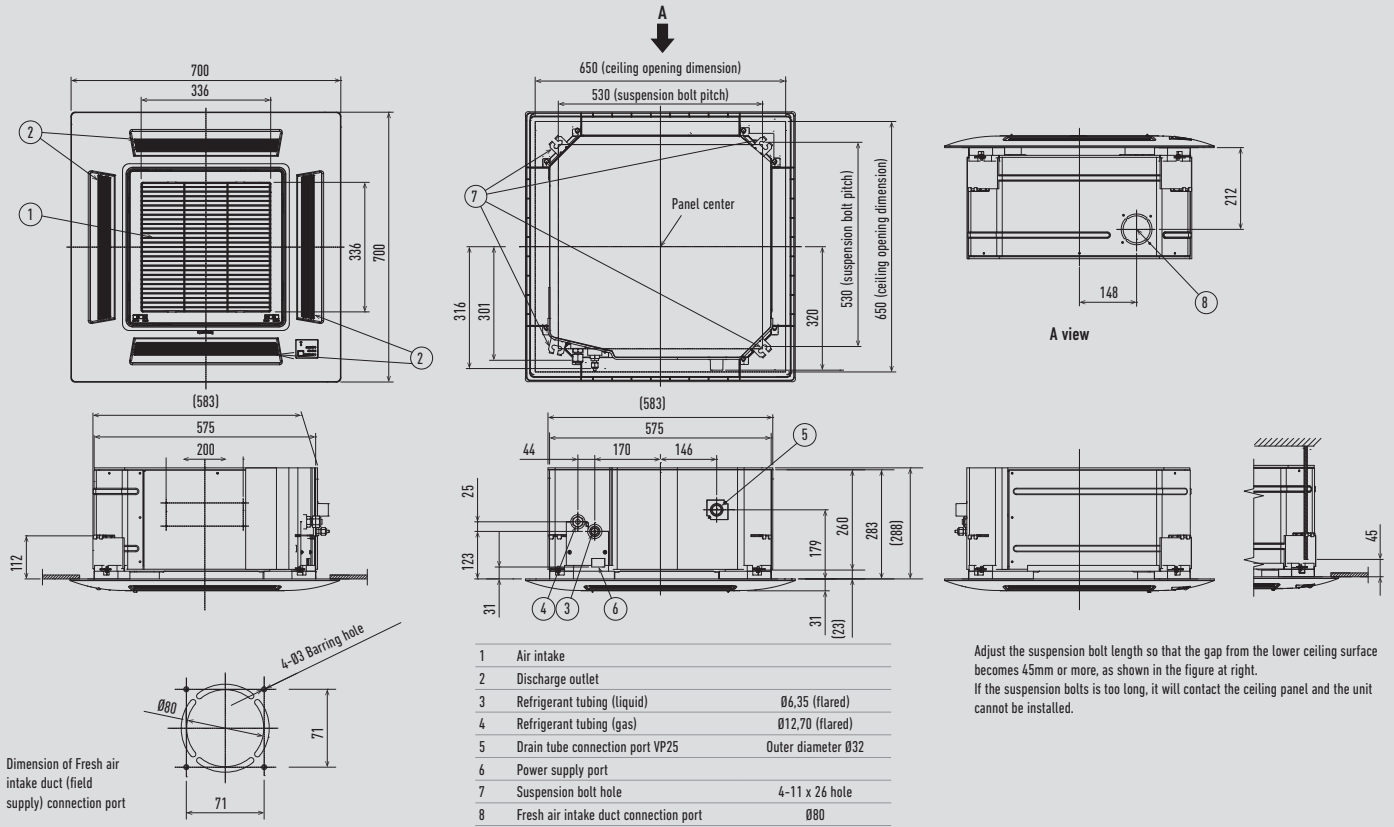

Unit: mm

L1 Type 2 Way Cassette

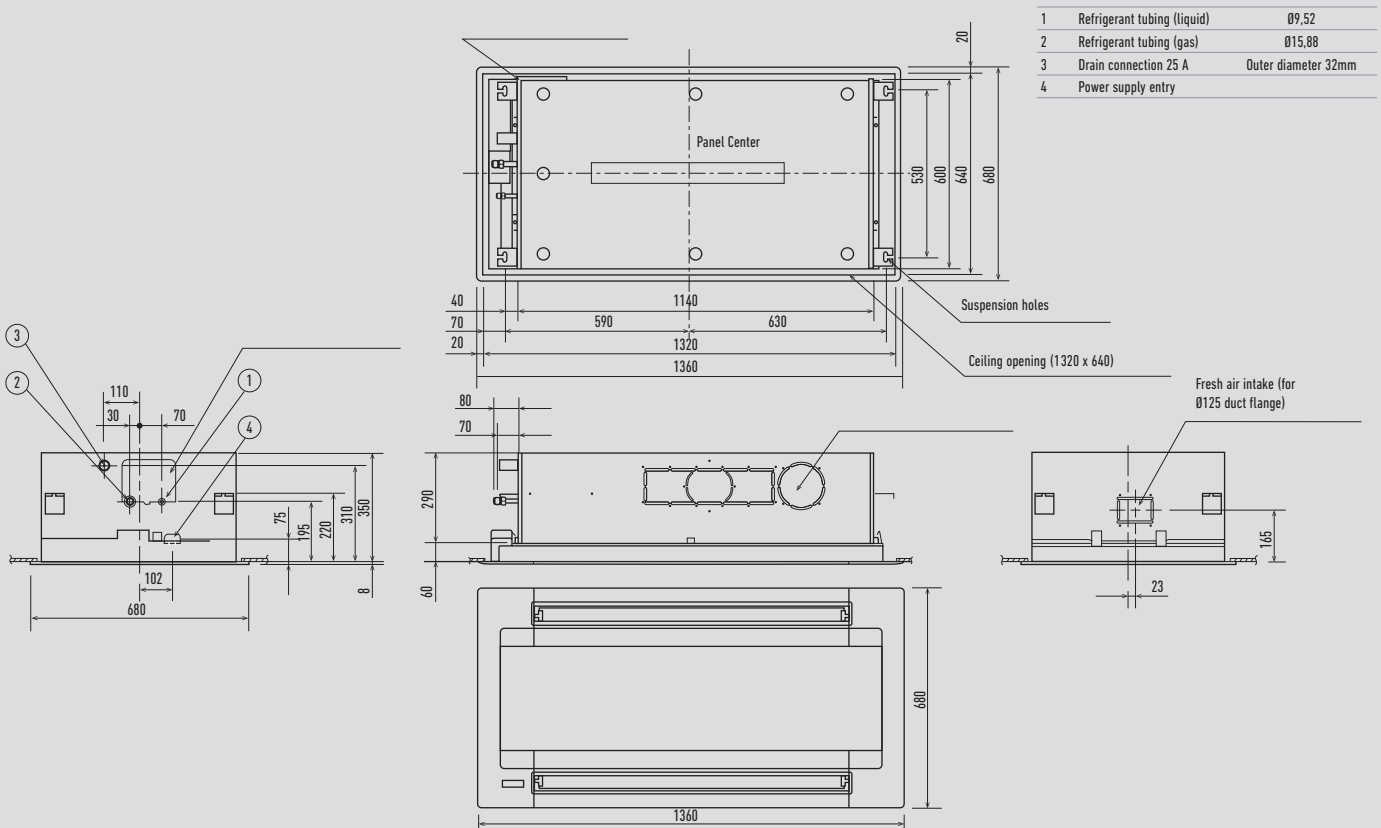

Unit: mm

D1 Type 1 Way Cassette

	28-56	73
1	Air intake grille	
2	Discharge outlet	
3	Ø6,35 (flared)	Ø9,52 (flared)
4	Ø12,70 (flared)	Ø15,88 (flared)
5	Drain tube connection port VP25 Outer diameter32	
6	Power supply entry	
7	Discharge duct connection port (for descending ceiling)	
8	Fresh air intake duct connection port Ø100	
9	Installation port for wireless remote controller receiver	
10	Suspension bolt hole 4-12 x 30mm	

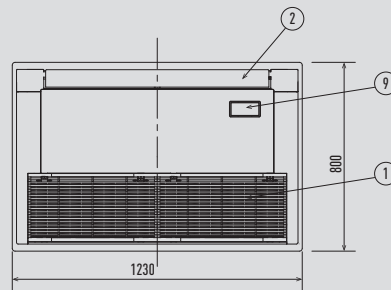
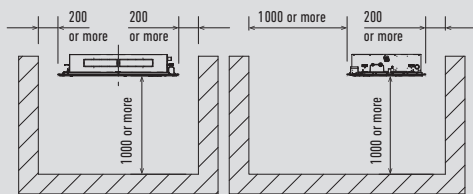
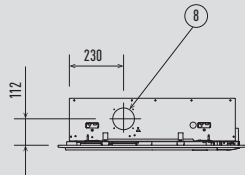
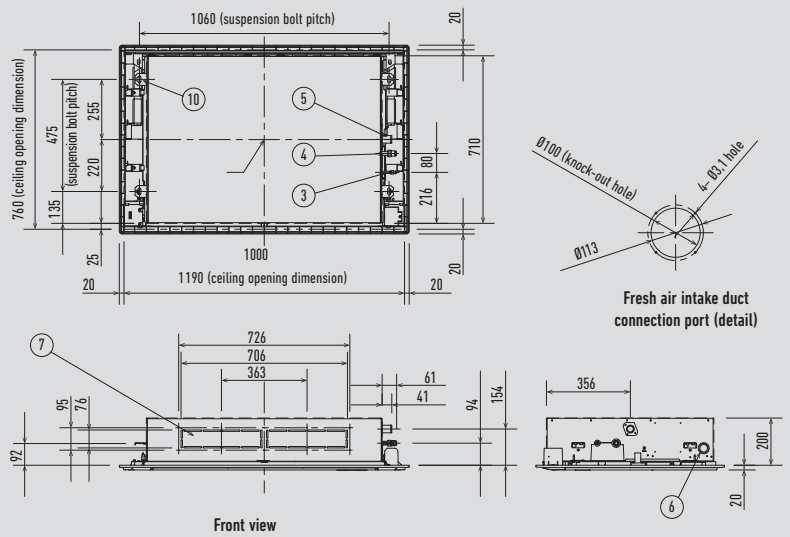

Unit: mm

M1 Type Slim Variable Static Pressure Hide Away

1	Refrigerant piping (narrow tube)	
2	Refrigerant piping (wide tube)	
3	Upper and bottom drain port Outer diameter 26mm	
4	Suspension lug	
5	Power supply outlet 2-Ø30	
6	Flange for air intake duct	
7	PL cover	
8	Electrical component box	
9	Frame filter	
10	Signal output board ACC-SG-AGB: optional	

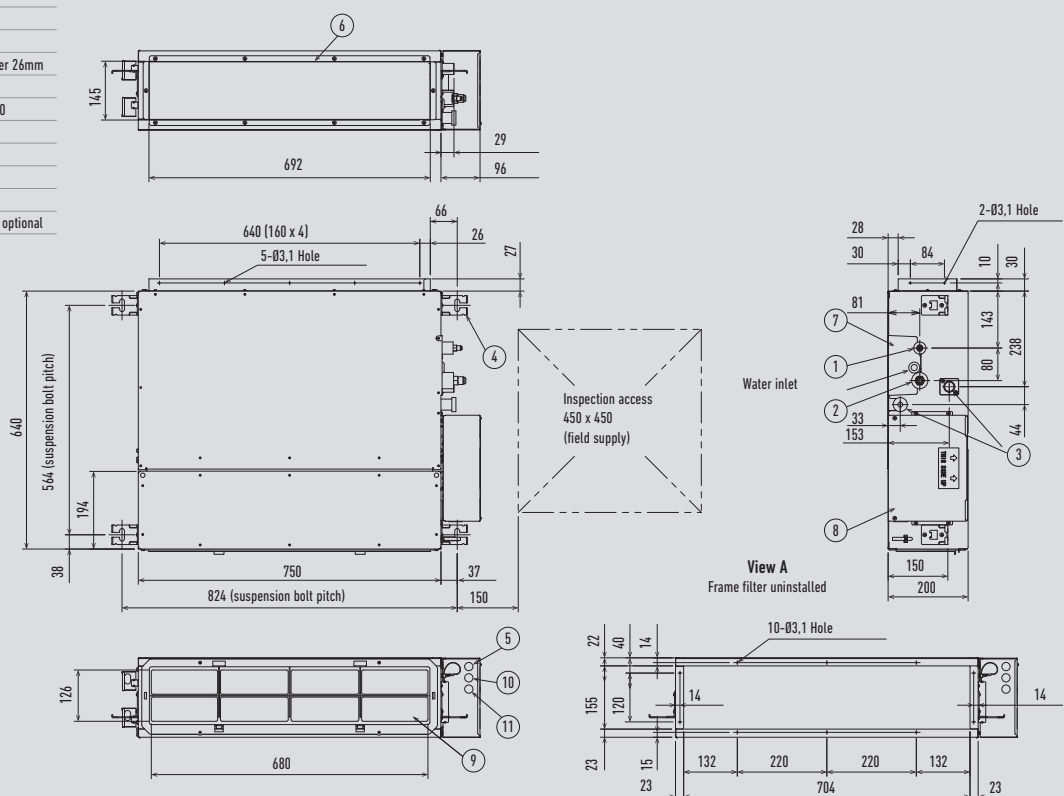

Unit: mm

F2 Type Variable Static Pressure Hide Away

S-15MF2E5A / S-22MF2E5A / S-28MF2E5A / S-36MF2E5A / S-45MF2E5A / S-56MF2E5A

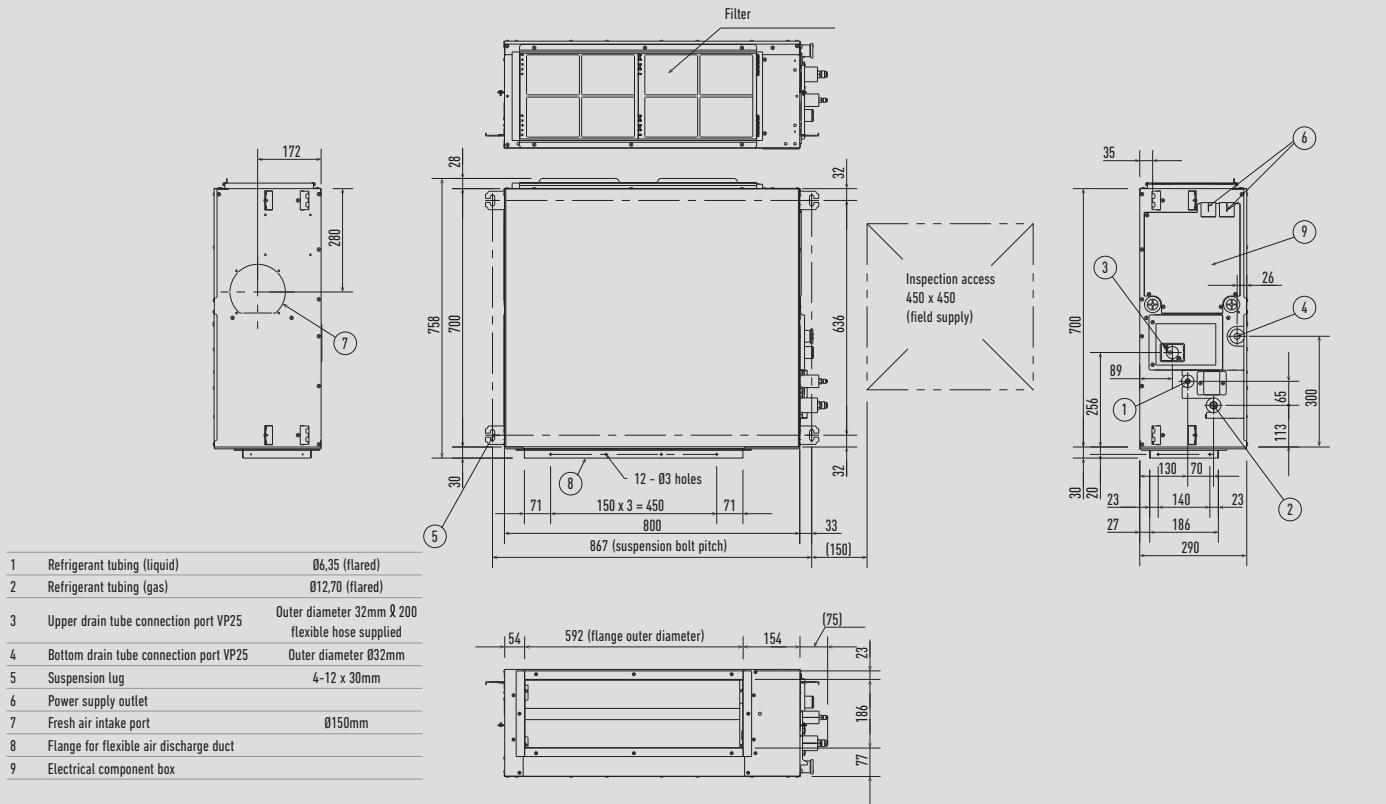

S-60MF2E5A / S-73MF2E5A / S-90MF2E5A

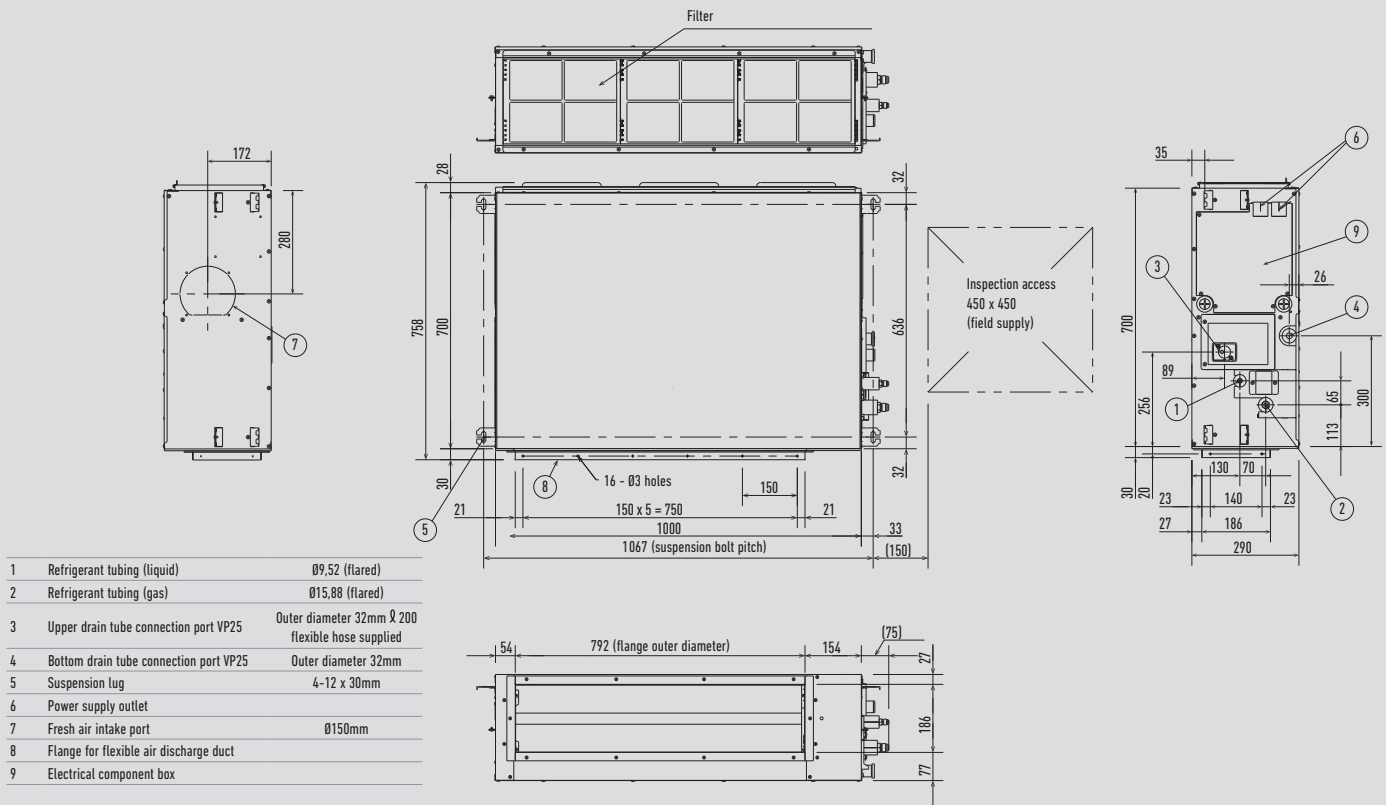

F2 Type Variable Static Pressure Hide Away

S-106MF2E5A / S-140MF2E5A / S-160MF2E5A

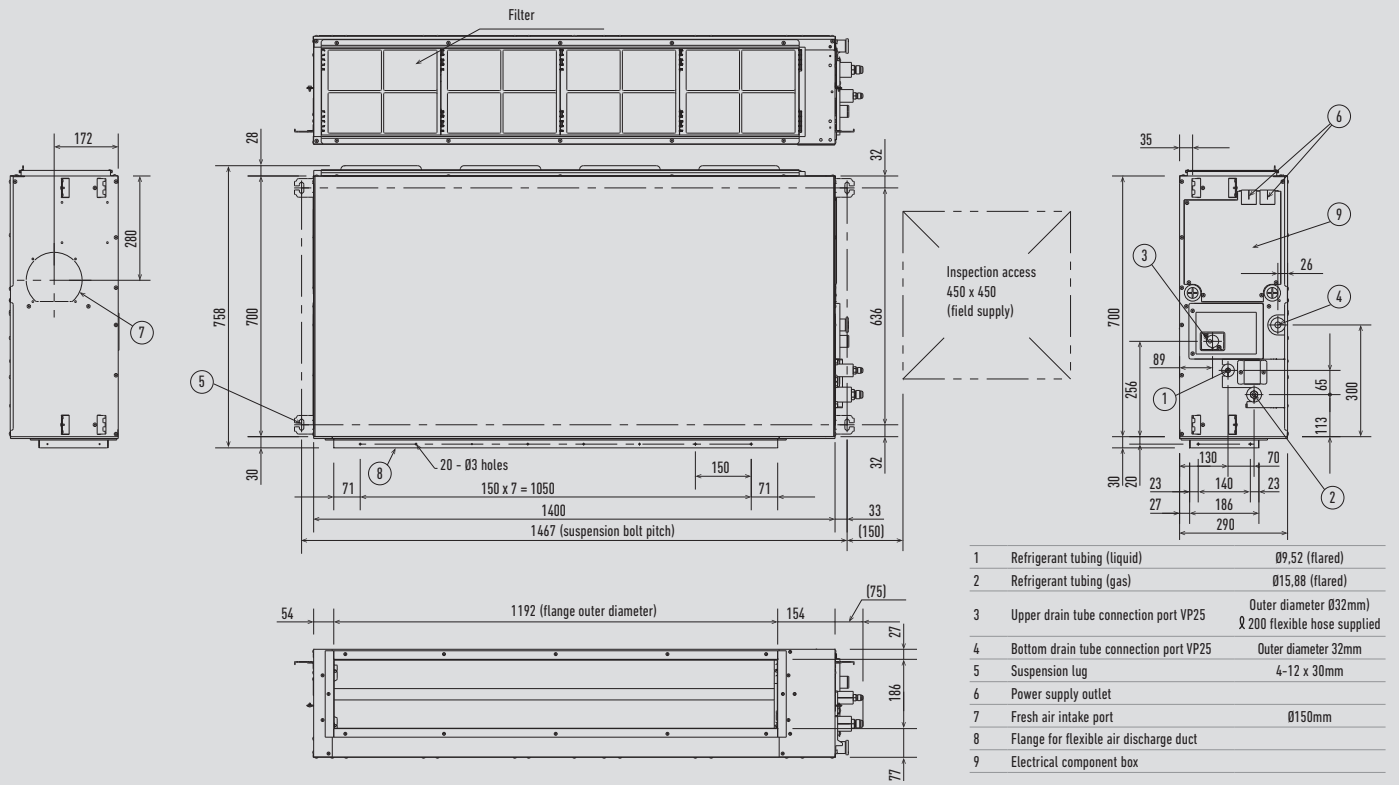

Unit: mm

E2 Type High Static Pressure Hide Away

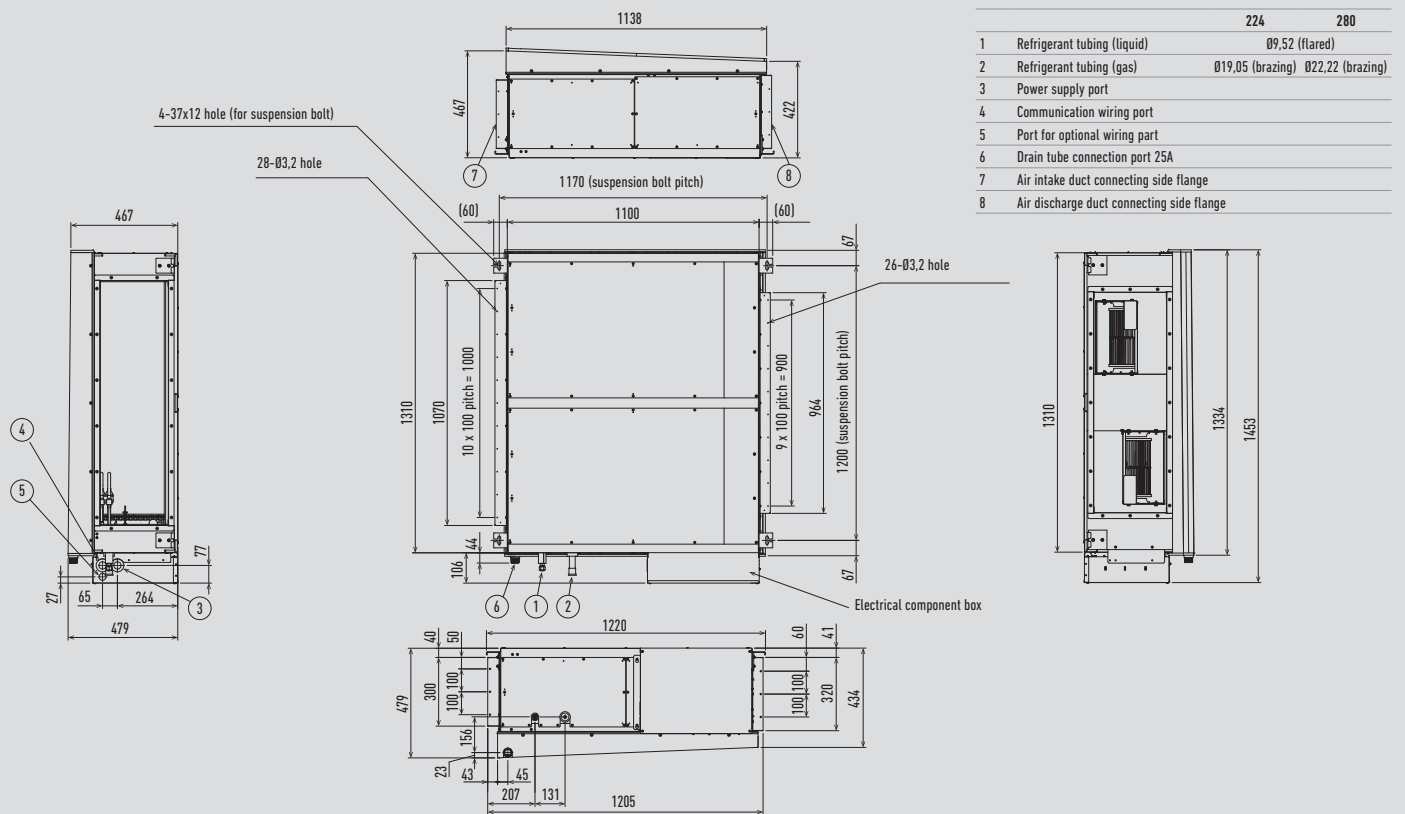

Unit: mm

T2 Type Ceiling

S-36MT2E5A / S-45MT2E5A / S-56MT2E5A

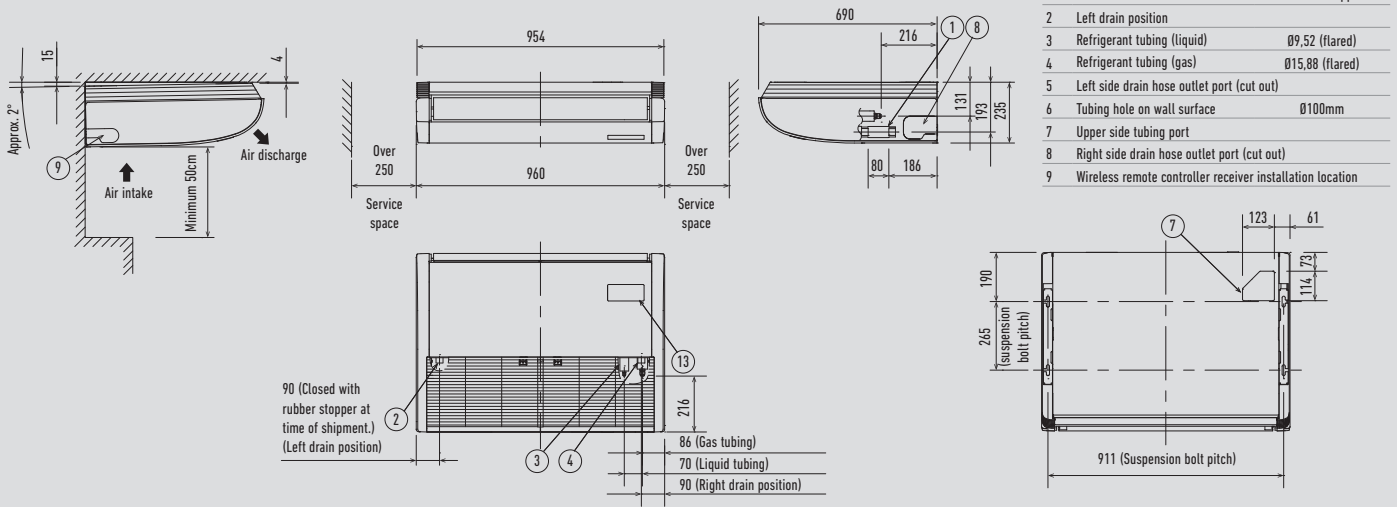

S-73MT2E5A

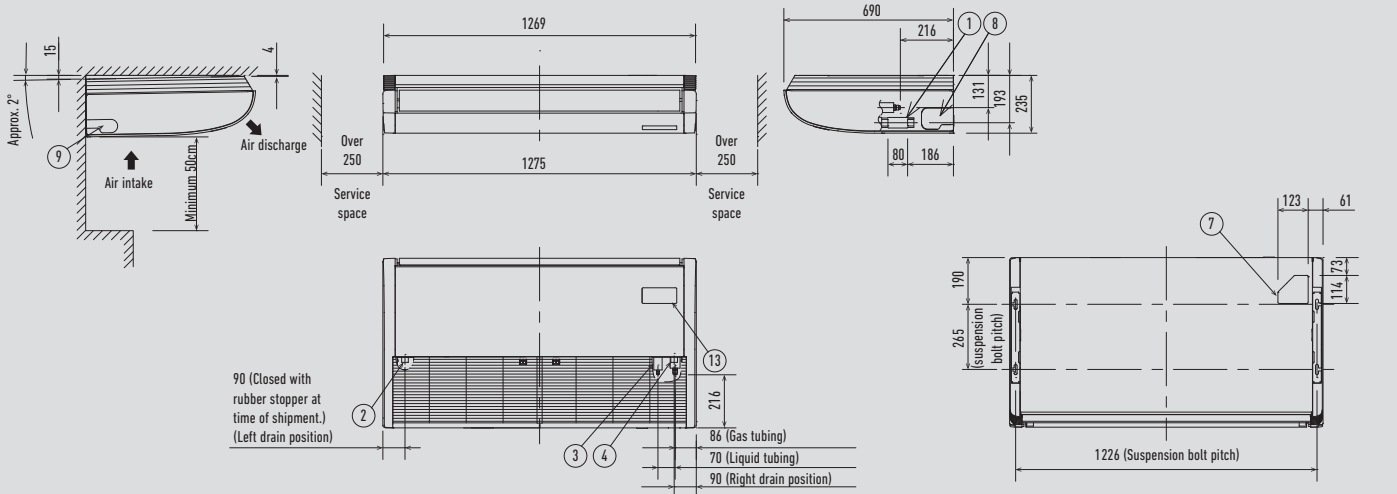

S-106MT2E5A / S-140MT2E5A

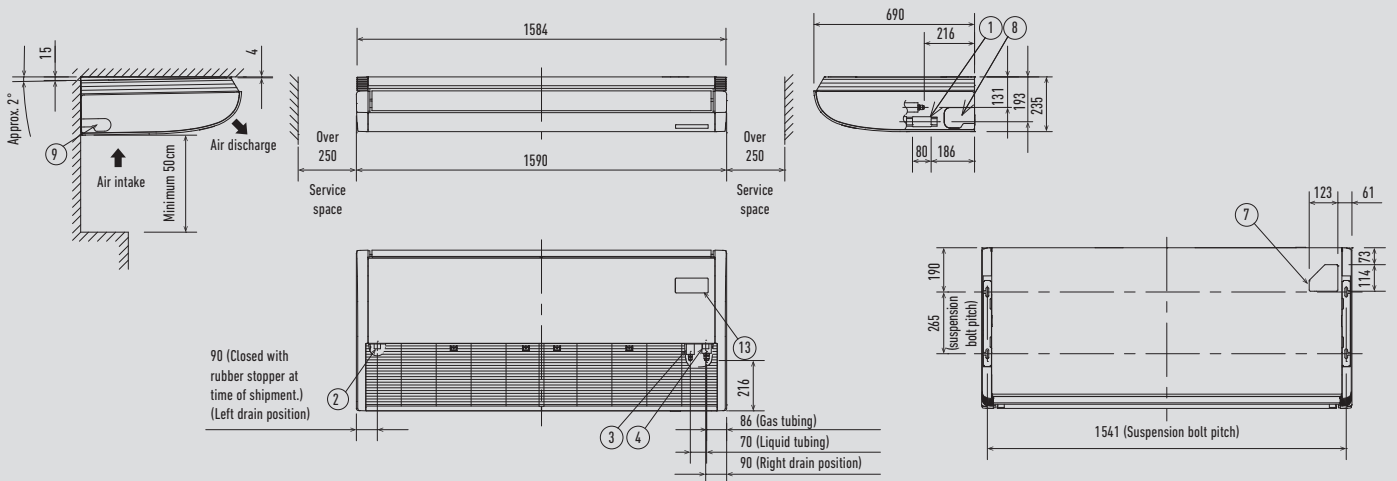

G1 Type Floor Console

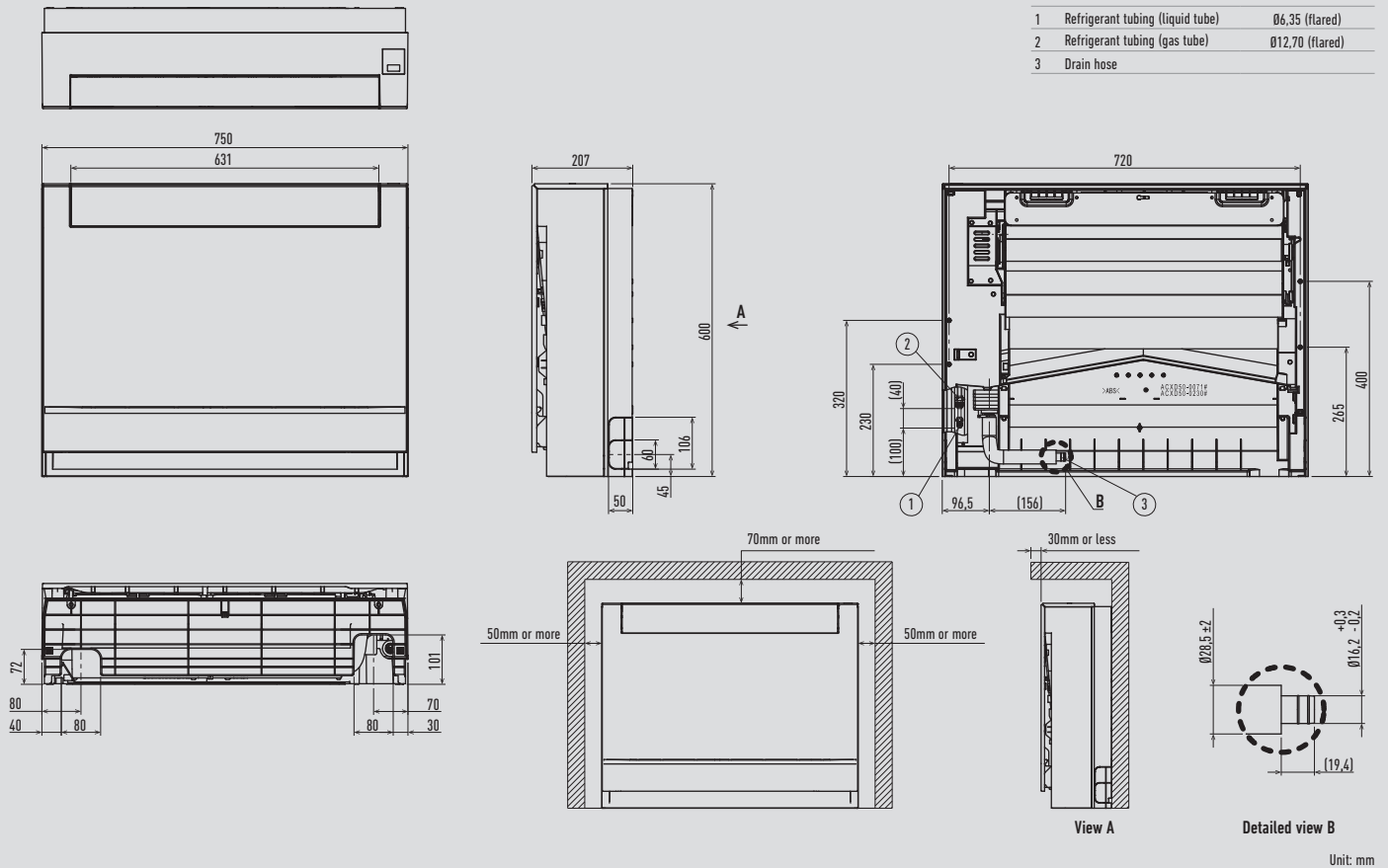

P1 Type Floor Standing

- 1 4- $\varnothing 12$ hole (for fastening the indoor unit to the floor with screws)
- 2 Air filter
- 3 Refrigerant tubing (liquid)
- 4 Refrigerant tubing (gas)
- 5 Level adjusting bolt
- 6 Drain tube connection port (20 A)
- 7 Power cord outlet (downward, rear)
- 8 Refrigerant piping outlet (downward, rear)
- 9 Location for mounting the remote controller (remote controller can be attached within the room)

	A	B	C	Liquid pipes	Gas pipes
22-36	1065	665	632		
45				$\varnothing 6,35$	$\varnothing 12,70$
56	1380	980	947		
71				$\varnothing 9,52$	$\varnothing 15,88$

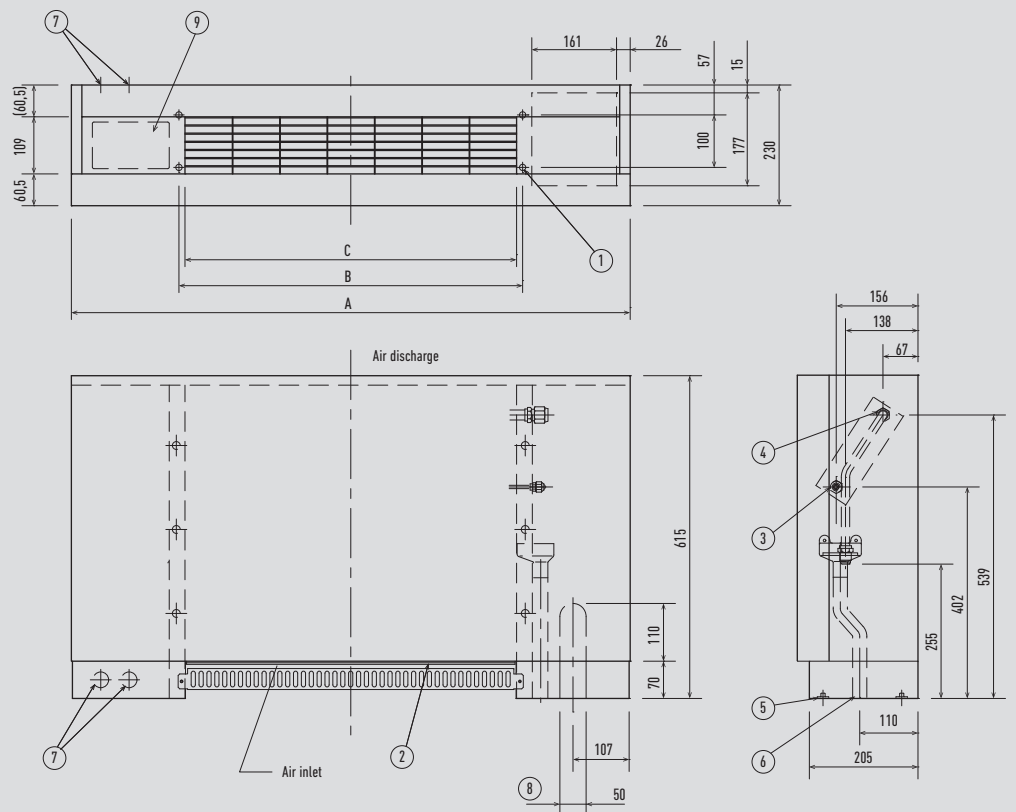

Unit: mm

K2 Type Wall Mounted

S-15MK2E5A / S-22MK2E5A / S-28MK2E5A / S-36MK2E5A

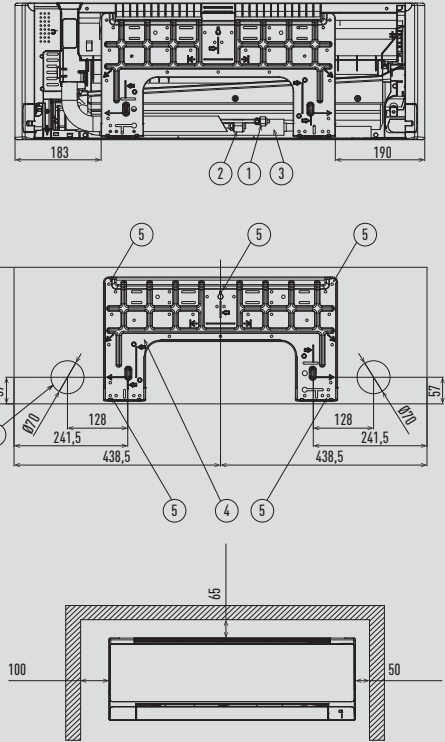
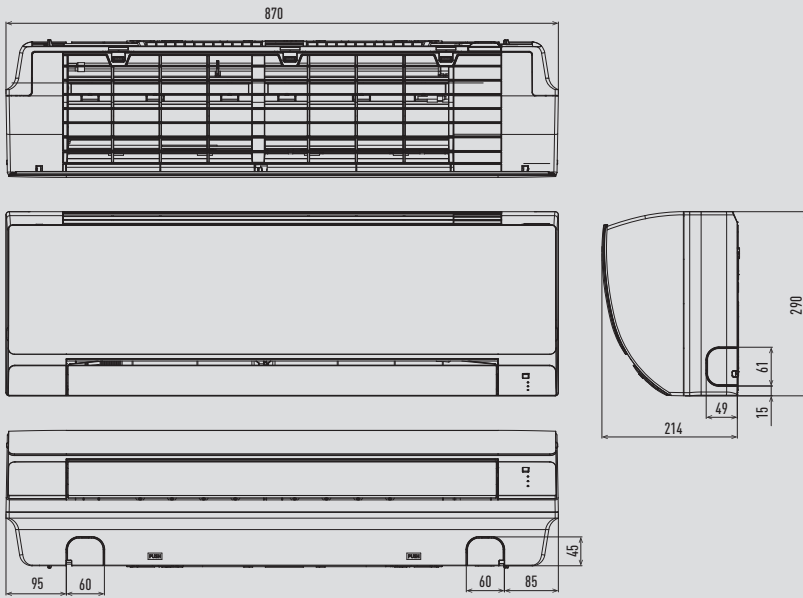

1	Refrigerant tubing (liquid)	Ø6,35 (flared)
2	Drain hose	Outer diameter 16mm
3	Rear panel	PL Back
4	Refrigerant tubing (gas)	Ø12,70 (flared)
5	Rear panel fixing holes	
6	Piping and wiring holes	Ø70

S-45MK2E5A / S-56MK2E5A / S-73MK2E5A / S-106MK2E5A

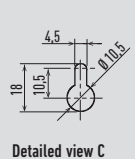
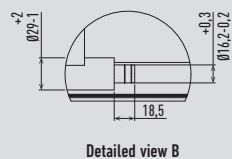
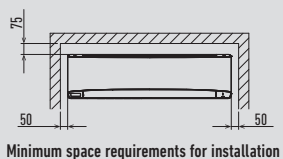
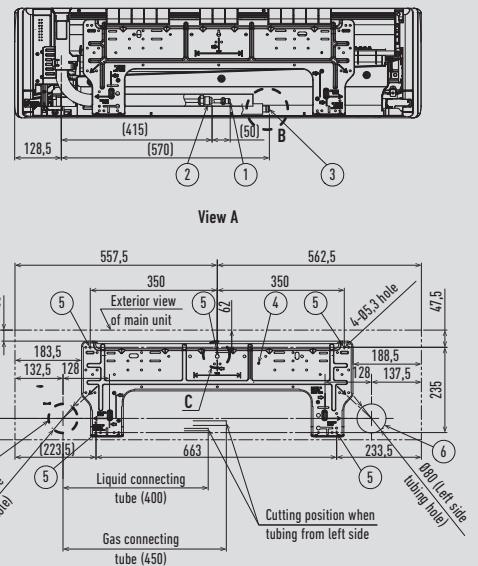
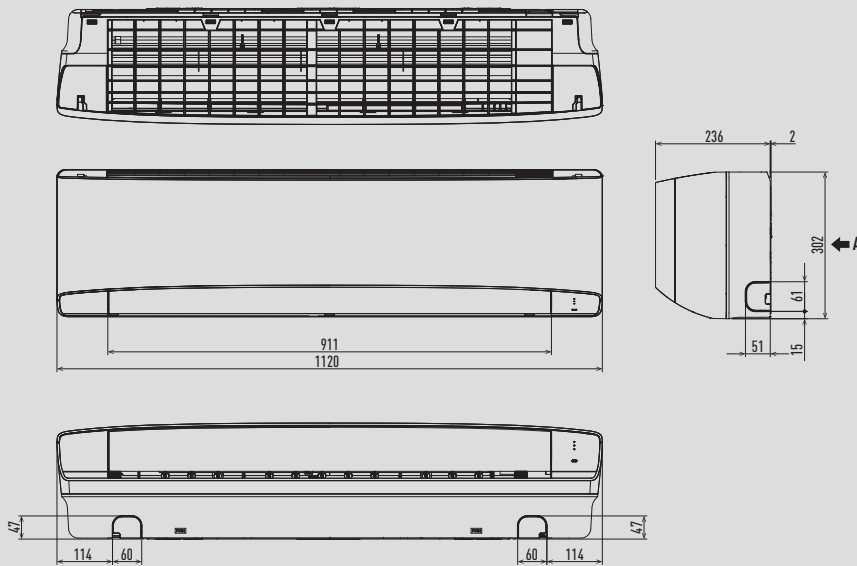

Type	45-56	73-106
1	Refrigerant tubing (liquid)	Ø6,35 (flared)
2	Refrigerant tubing (gas)	Ø12,70 (flared)
3	Drain hose	
4	Rear panel	
5	Rear panel fixing holes (Ø5,3 holes or as shown in figure "C")	
6	Tubing and wiring holes (Ø80)	

R1 Type Concealed Floor Standing

- 1 4-Ø12 hole (for fastening the indoor unit to the floor with screws)
- 2 Air filter
- 3 Refrigerant tubing (liquid)
- 4 Refrigerant tubing (gas)
- 5 Level adjusting bolt
- 6 Drain tube connection port (20 A)
- 7 Flange for the air-outlet duct

	A	B	C	D	E	F	Liquid pipes	Gas pipes
22-36	904	692	672	665	500	86	Ø6,35	Ø12,70
45								
56	1219	1007	1002	980	900	51		
71							Ø9,52	Ø15,88

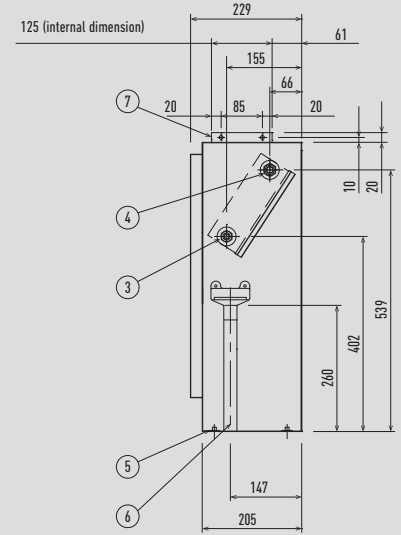
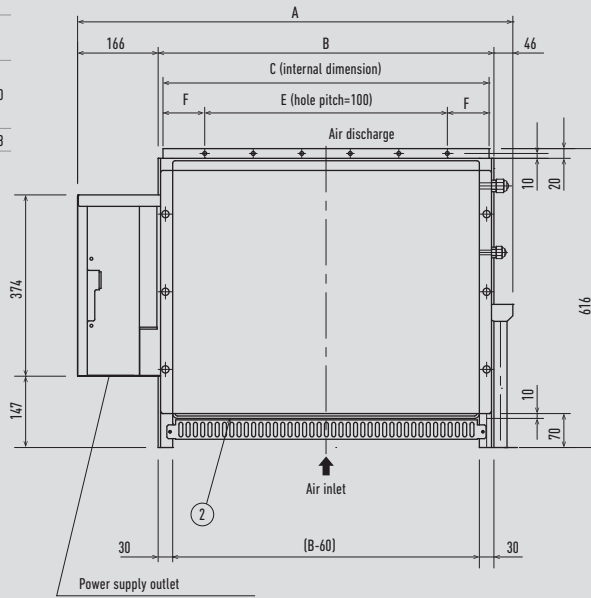
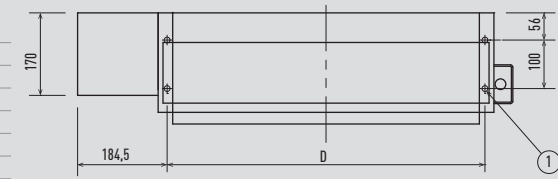

Unit: mm

Hydrokit for ECOi, water at 45°C

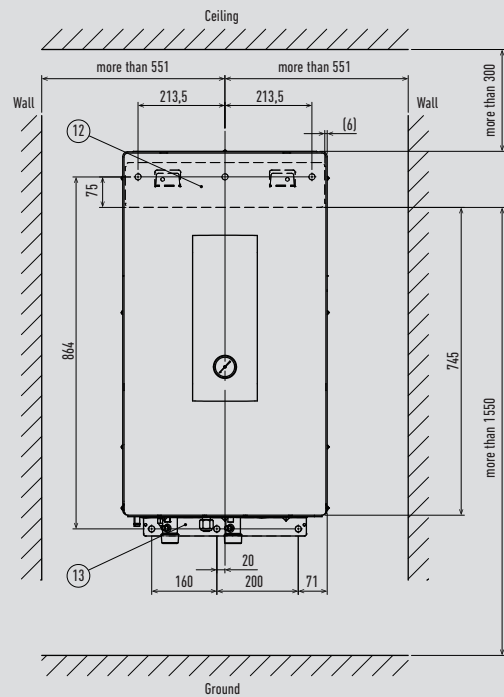
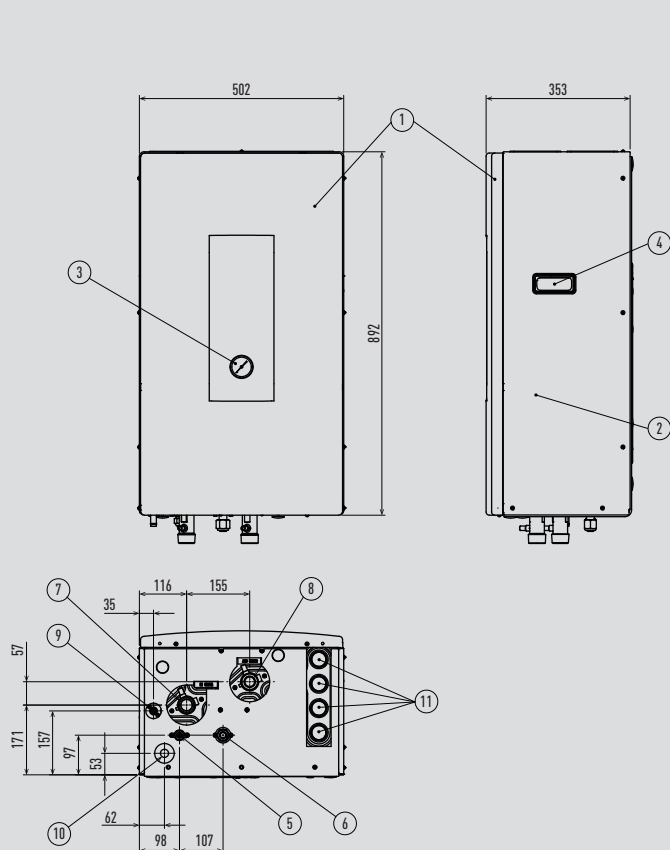

Unit: mm

AHU Connection Kit

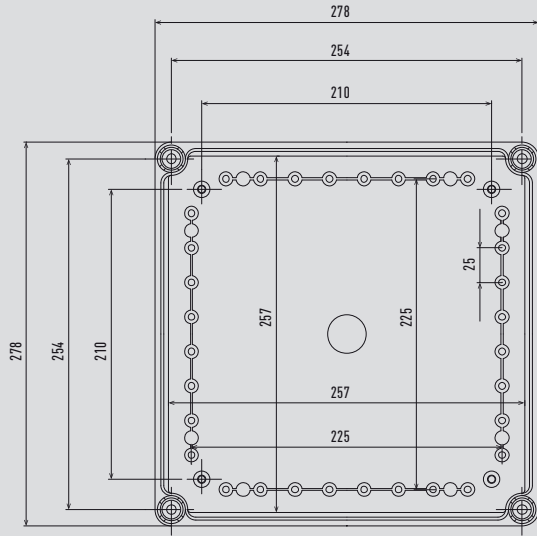

Front View (transparent cover removed)

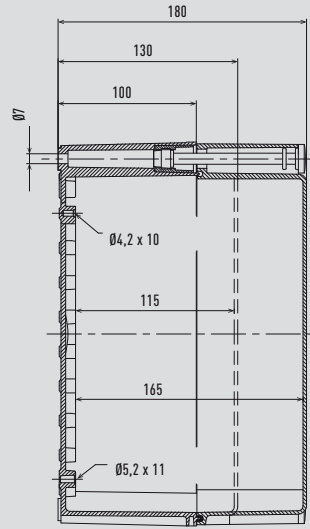

Side View

Unit: mm

Air Curtain with DX Coil

Top view

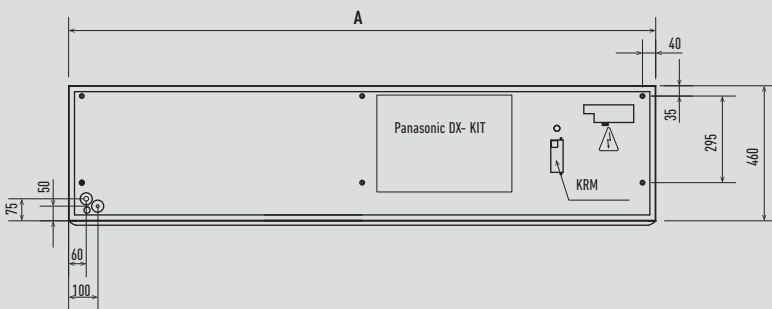

Side view

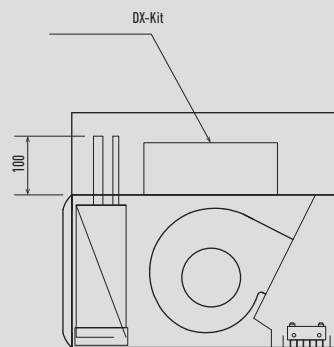

Front view

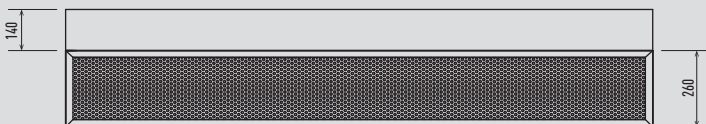

Bottom view

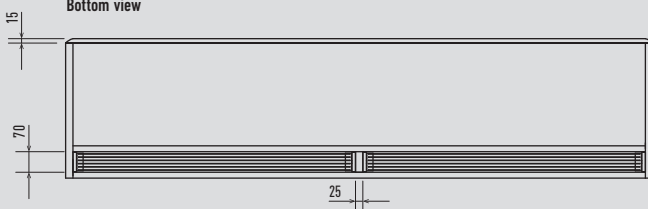

	PAW-10EAIRC-LS	PAW-15EAIRC-LS	PAW-20EAIRC-LS	PAW-25EAIRC-LS
	PAW-10EAIRC-HS	PAW-15EAIRC-HS	PAW-20EAIRC-HS	PAW-25EAIRC-HS
A	1,0m	1,5m	2,0m	2,5m

Unit: mm

Energy Recovery Ventilation System

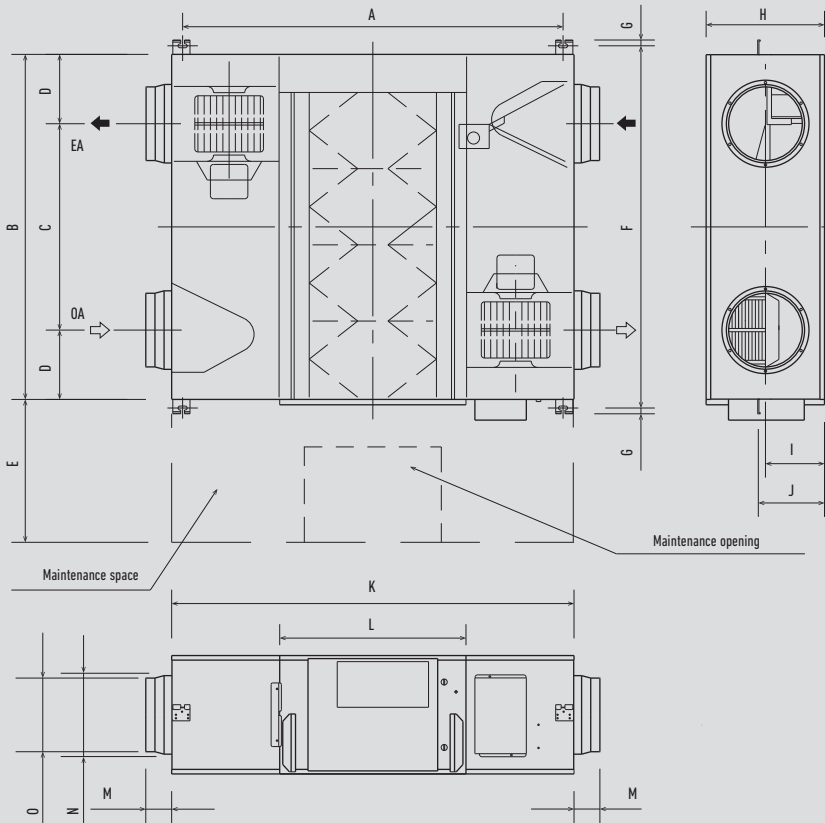

	FY-250ZDY8R	FY-350ZDY8R	FY-500ZDY8R	FY-800ZDY8R	FY-01KZDY8R
A	810	978	1018	1250	1250
B	599	804	904	884	1134
C	315	580	640	428	678
D	142	112	132	228	228
E	600	600	600	600	600
F	655	860	960	940	1190
G	19	19	19	19	19
H	270	317	317	388	388
I	135	159	159	194	194
J	159	182	182	218	218
K	882	1050	1090	1322	1322
L	414	470	470	612	612
M	95	70	70	85	85
N	164	164	210	258	258
O	144	144	194	242	242

Unit: mm

Heat Recovery with DX Coil

	A	A1	A2	B	B1	B2	C	D	D1	Ød	E	Net weight
PAW-500ZDX3N	1822	1752	1986	882	936	994	390	431	431	250	169	81
PAW-800ZDX3N	1822	1752	1986	1132	1186	1244	390	431	431	250	169	87
PAW-01KZDX3N	1822	1752	1986	1132	1186	1244	390	681	532	250	169	87

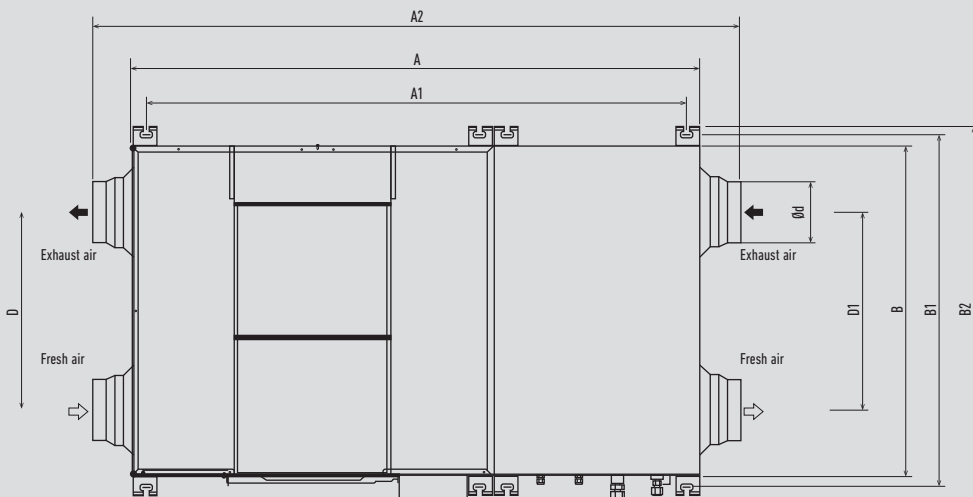
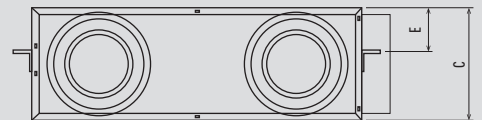
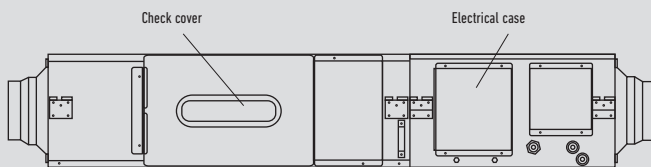

Unit: mm

Condensing units VF Series 4,00kW

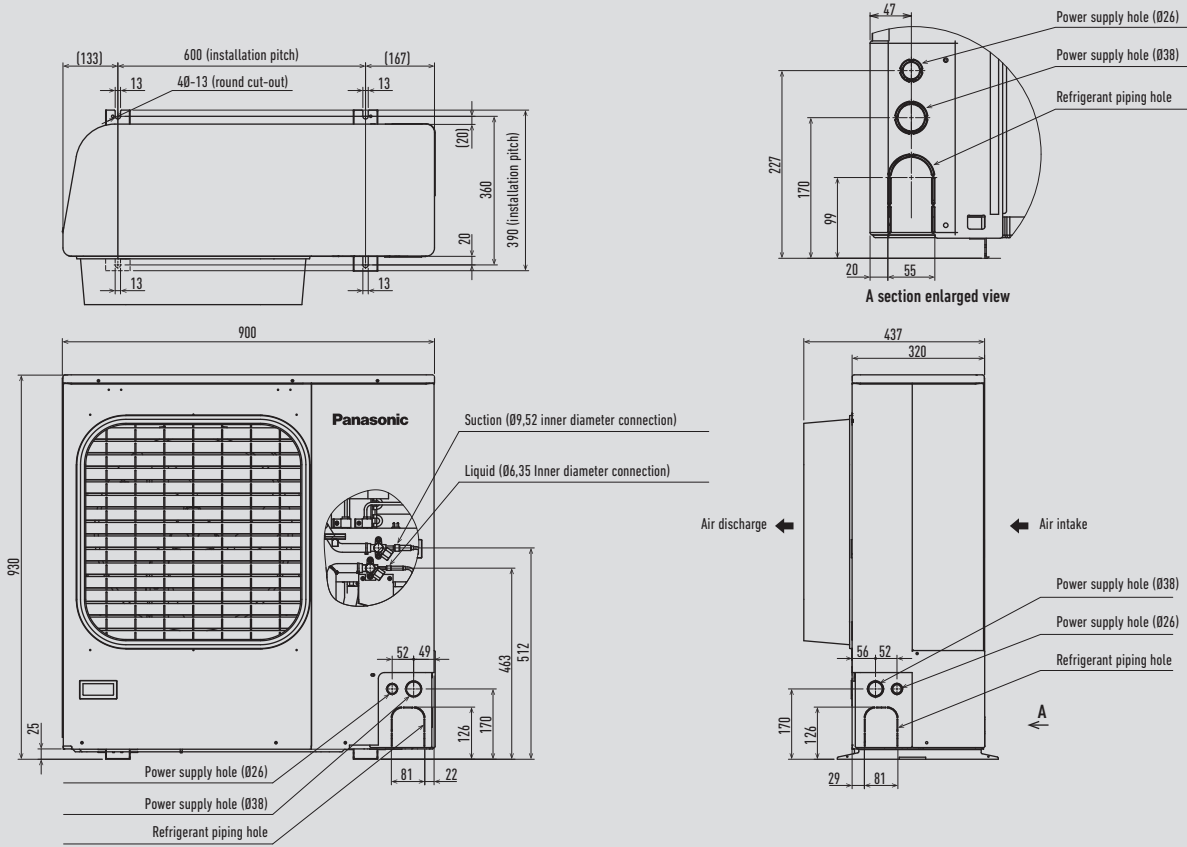

Unit: mm

Condensing units VF Series 15,00 and 14,00kW

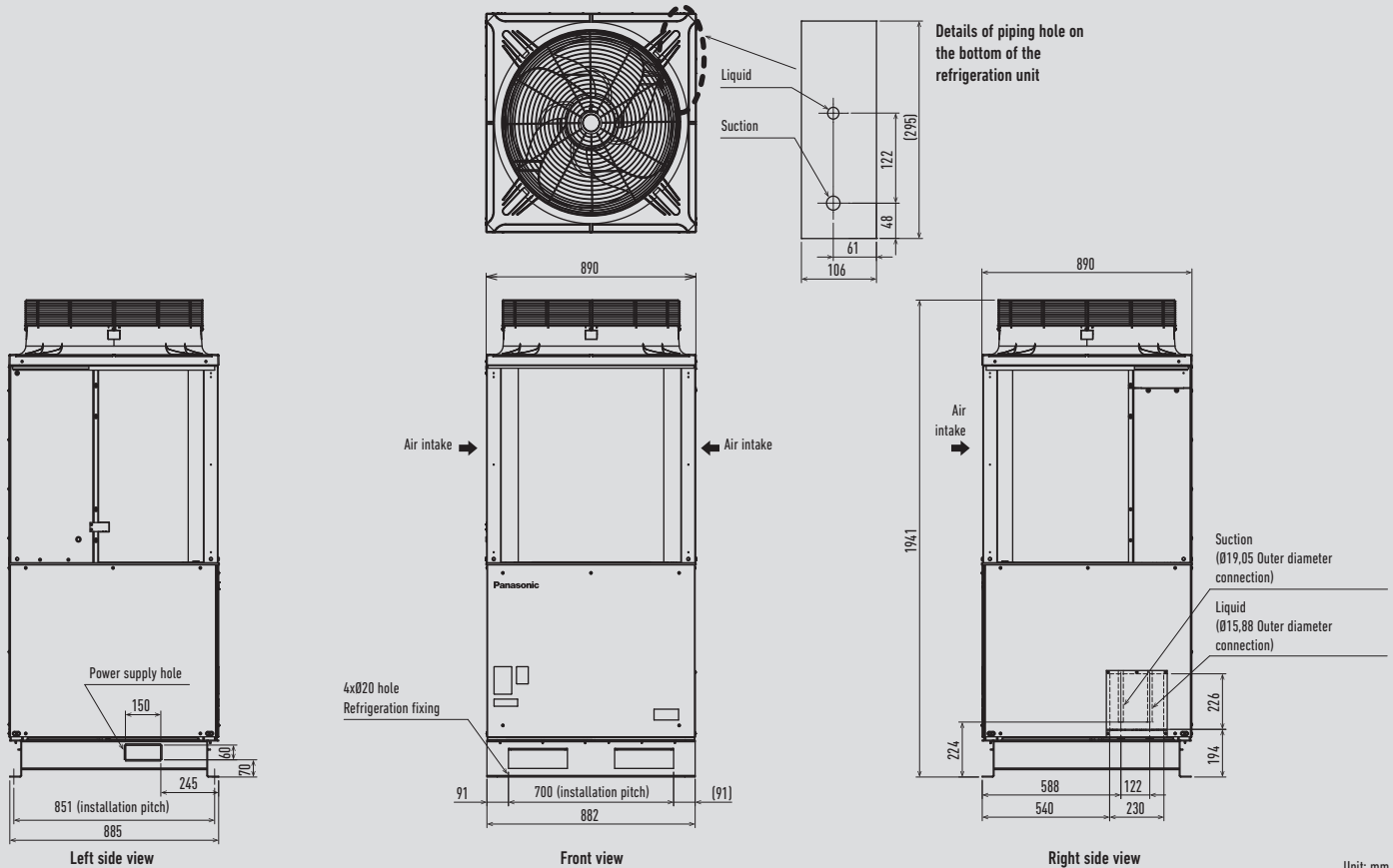

Unit: mm

Room controller for SE8000

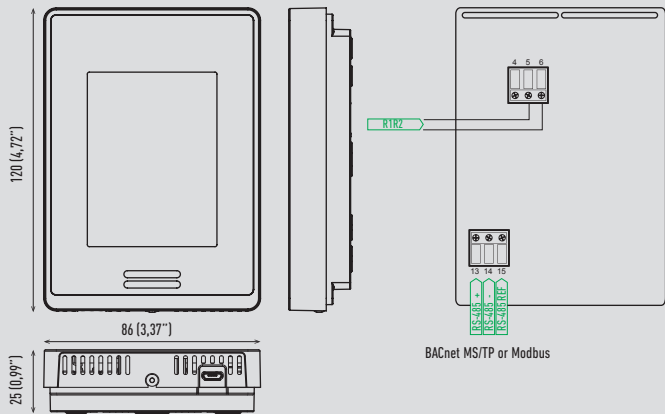

Check with your local government for instruction on disposal of these products.

THIS PRODUCT FOR COMMERCIAL USE ONLY.



Dimensions:

Height: 12cm/4.72in.
Width: 8.6cm/3.39in.
Depth: 2.7cm/1.06in.

Power requirements:

16 Vdc from Panasonic R-R IDU connectors.
50/60 Hz, 4VA, Class 2 Supply.

Range from indoor unit:

Recommended 500ft (150 m).

Operating conditions:

0 °C to 50°C (32°F to 122°F).
0% to 95% R.H. non-condensing.

Storage conditions:

-30°C to 50°C (-22°F to 122°F).
0% to 95% R.H. non-condensing.

Temperature sensor:

Local 10 K NTC type 2 thermistor.

Temperature sensor resolution:

± 0,1°C (± 0,2°F).

Temperature sensor accuracy:

± 0,5°C (± 0,9°F) @ 21°C (70°F) typical calibrated.

Humidity sensor and calibration:

Single point calibrated bulk polymer type sensor.

Humidity sensor precision:

Reading range from 10% to 90 % R.H. non-condensing.
10% to 20% precision: 10%.
20% to 80% precision: 5%.
80% to 90% precision: 10%.

Humidity sensor stability:

Less than 1,0% yearly (typical drift).

Wiring:

Maximum wire length between last indoor unit to SER8150Rx81194 equals 490ft (150m) with AWG #18 wire (0,82mm²).
Refer to Panasonic VRF guidelines "Wiring system diagram for remote controller" for this limitation.

Approximate shipping weight:

0,34kg (0,75lb)

Unit: mm

Wall/ceiling wireless sensor SED-MTH-G-5045

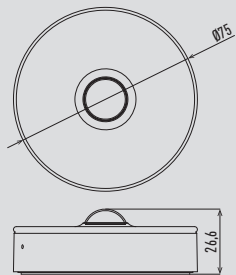

Dimensions:
70mm diameter x 26,6mm.

Colour:
White.

Weight:
59g.

Communication:
ZigBee 3,0 HA.

Detection range:
Ceiling: Ø4m (installation height 2,5m).
Wall: R5m (installation height 1,2m).

Battery voltage:
3V.

Battery cell:
LR03 AAA (2 pcs).

Battery life:
Up to 5 years.

Ambient temperature:
-10°C - +50°C.



Check with your local government for instruction on disposal of these products.

Door/window wireless sensor SED-WDC-G-5045

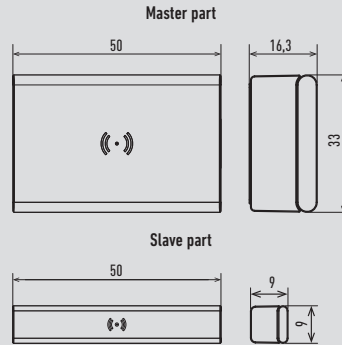

Dimensions:
Master part: 50 x 33 x 16,3mm.
Slave part: 50 x 9 x 9mm.

Colour:
White / transparent.

Weight:
30g

Communication:
ZigBee 3,0 HA.

Detection range:
Trigger 'close': wood 30mm, metal 18mm.
Trigger 'open': wood 32mm, metal 20mm.

Battery voltage:
3V.

Battery cell:
CR2450.

Battery life:
Up to 5 years.

Ambient temperature:
-10°C - +50°C.



Check with your local government for instruction on disposal of these products.

Unit: mm

CO₂ sensor SED-CO2-G-5045

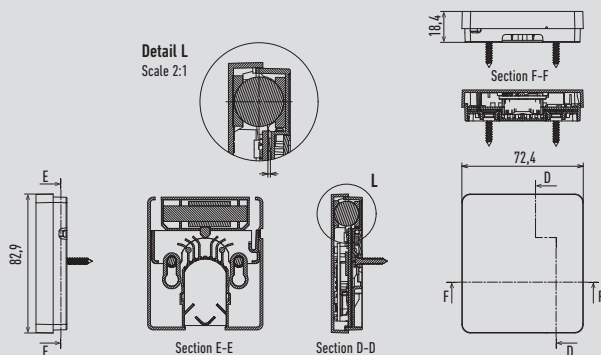

Dimensions:
3,26 x 2,85 x 0,72 inches.
82,9 x 72,4 x 18,4mm.

Operating temperature:
0°C to 50°C (32°F to 122°F).

Temperature accuracy:
±0,3°C (0,54 °F) typical within operating range.

Humidity range:
0% to 100%.

Humidity accuracy:
± 3% RH (typical within 0% to 80% RH).

Measurement range:
0 to 5000ppm.

Measurement/Transmission intervals:
2,5 minutes (day), 10 minutes (evening).
Note: Battery life will be reduced should interval be shortened (i.e. using remote temperature/humidity functions).

CO₂ accuracy at NTP:
±60ppm +3% of reading (400 - 2,000ppm range).

Communication:
Zigbee 3,0 Green Power (encrypted, bi-directional).

Battery voltage:
3,6V.

Battery cell:
AA Lithium ion.

Battery life:
10+ years (non-replaceable).
Note: Battery life can be reduced when sensor is operated at temperatures approaching the operating limits.

Ambient temperature:
-30°C to 70°C.



Check with your local government for instruction on disposal of these products.

Unit: mm

Relay pack TE2

ZigBee Pro (optional pink striped antenna for 2,4GHz)

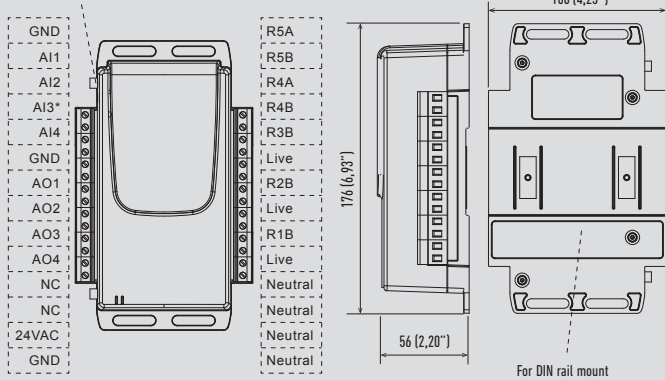

* AI3 can be used for pulse counting when ZigBee is paired directly to MPM.

Dimensions:

6,93 x 4,25 inches.
176 x 108mm.

Voltage:

24VAC; ± 15%; 50/60Hz; Class 2.
24VDC ± 10%.
115VAC/230VAC.

Typical consumption:

10VA (115/230VAC).
5VA (24V).

Inputs:

Pulse input: Support for one fast pulse input counting (up to 1000Hz / 1ms) – AI3.

Outputs:

Analog (x4): 0-12V, nominal 50mA maximum each, 12-bit resolution.
Relay (x5) (optional): Maximum 230VAC, 5A per relay.
First three relays (R1, R2 and R3) or based on input power voltage (24V, 115VAC or 230VAC).
Two relays (R4 and R5) are independent of the input power voltage.
Analog (x1): 24VAC, 2VA (115 VAC and 230 VAC Voltage only models, one additional output).
(*20VAC if used with 110V 50Hz).

ZigBee Pro range:

Frequency: 2400 to 2483.5MHz, 16RF channels.
Non line of sight to MPM: 50ft/17m.
Line of sight to MPM: 100ft/30m.

* Power supply is not included.

Certification



Check with your local government for instruction on disposal of these products.

Hotel room controller (HRC)

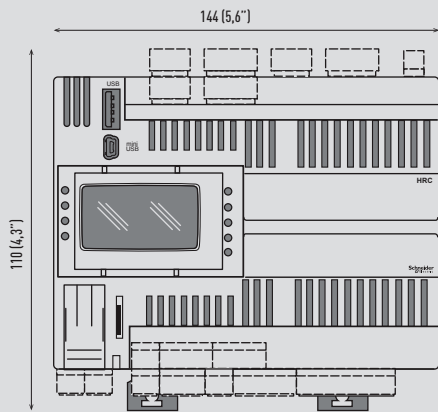

Dimensions:

5,6 x 4,3 x 2,4 inches.
144 x 110 x 60,5mm.

Digital inputs:

12.

High voltage relay digital outputs:

10 x 3 A SPST +250 VAC relays.

Analog inputs:

2 x configurable analog inputs.
DI: voltage free DI, 10 kΩ input impedance.
0-20mA: range 0,1000, < 150 Ω impedance.
0-10V: range 0,1000 > 10 kΩ impedance.

Analog outputs:

6 x 0-10V outputs, Load impedance > 700 Ω.

Supply voltage:

24VAC + 10% NOT ISOLATED.
+20...38Vdc NOT ISOLATED.

Supply frequency:

50 / 60Hz.

Power cycle:

35VA / 15W.

Operating temperature:

-20 to 60°C (-4 to 140°F) conforming to UL 60730-1.

Storage temperature:

-30 to 70°C (-22 to 158°F).

* Power supply is not included.

Certification



Check with your local government for instruction on disposal of these products.

BEMS Gateway MPM

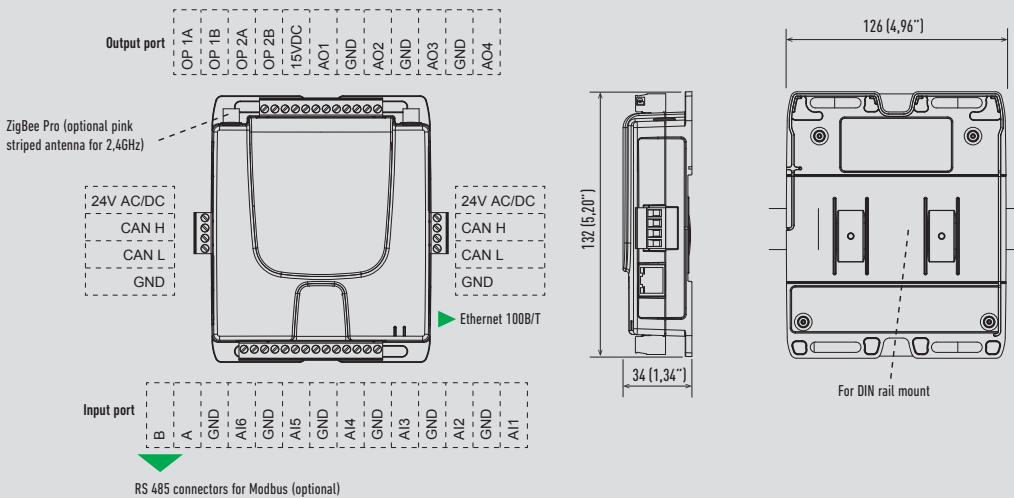

Dimensions:

5,20 x 4,96 inches.
132 x 126mm.

Voltage:

24VAC; ± 15%; 50/60Hz.
24VDC ± 10%.

Typical consumption communication:

5VA + Output (VAC), 1,6W + Output (VDC).
ZigBee Pro, EnOcean, BACnet.
CANbus (125-500Kbps).
Ethernet (10/100Mbps).

Analog inputs:

Current: 4-20mA with 249 external resistor.
Voltage: 0-10V.

Outputs:

Analog (x4): 0-12V, nominal 50mA max each, 12-bit resolution.
Relay (x2): 24V, 1,1 Amp per relay.

RS485 (optional):

Supported protocols: Modbus.

ZigBee Pro (optional):

Frequency: 868MHz, 902MHz.

Certification



Check with your local government for instruction on disposal of these products.

PAW-RE2C3 Hotel Controller

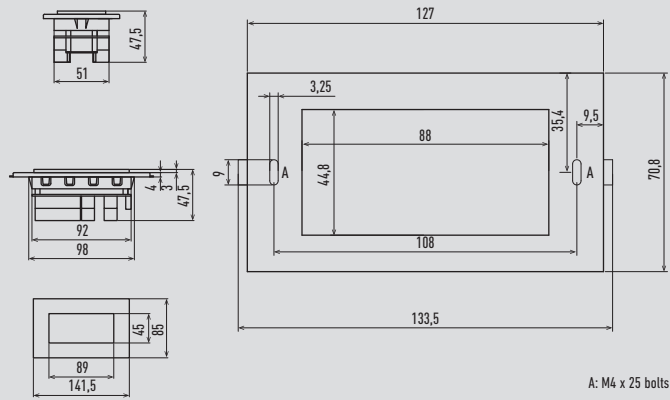

CZ-RTC5B Design wired remote controller

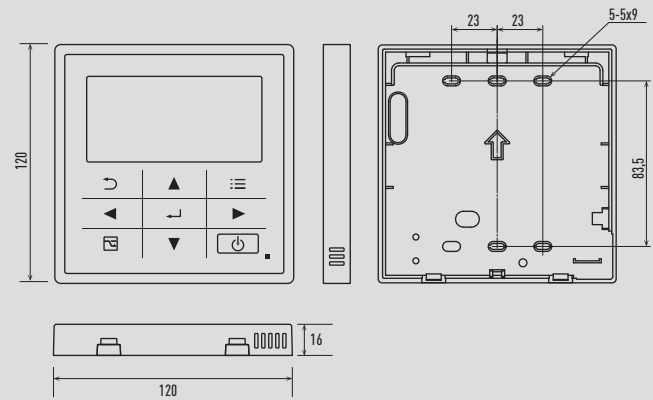

CZ-RTC2 Wired remote controller. Normal operation

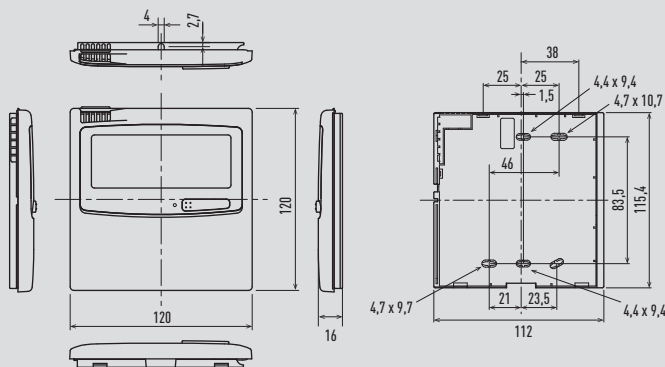

CZ-RWS3 Wireless remote control

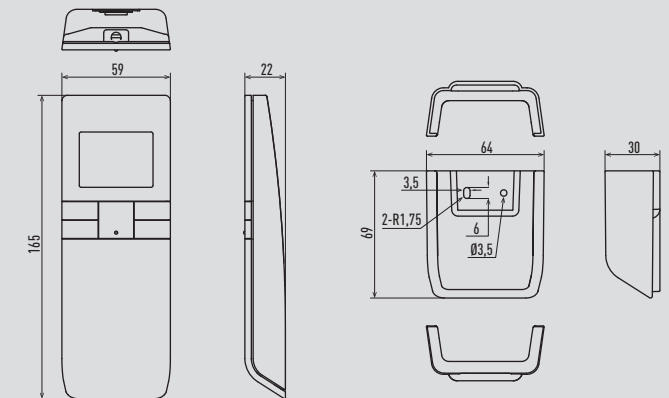

CZ-RE2C2 Simplified remote controller

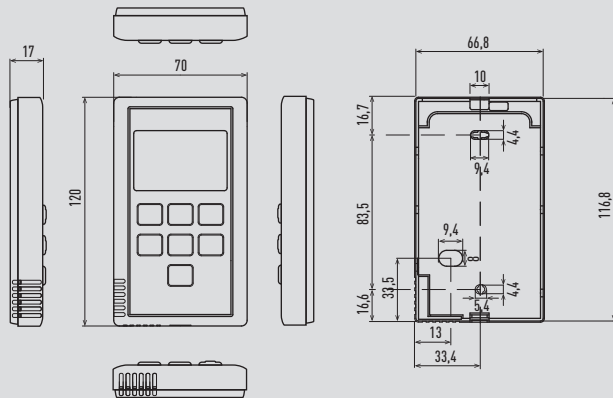

CZ-64ESMC3 System Controller with Schedule timer

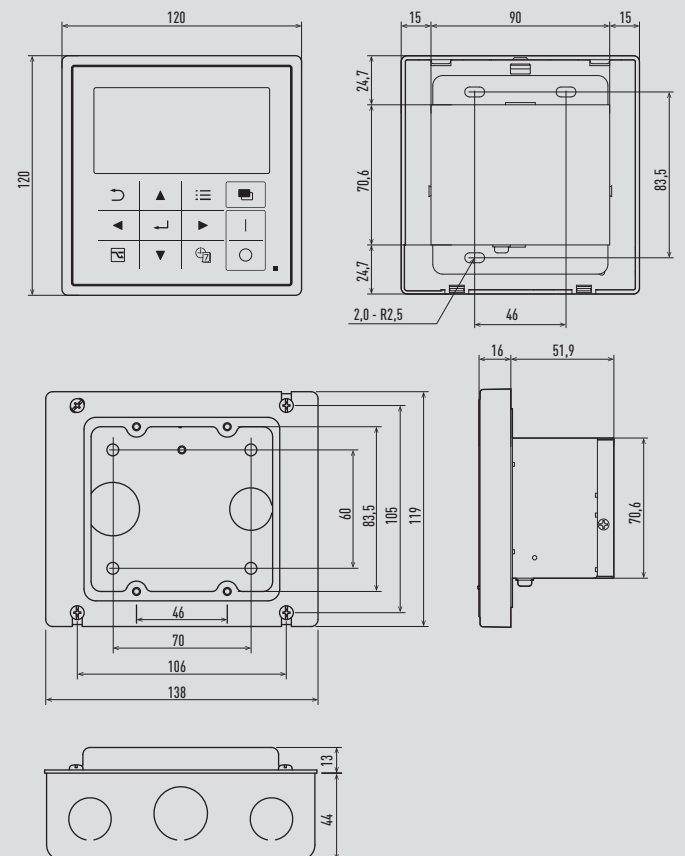

CZ-CSRC3 Remote sensor

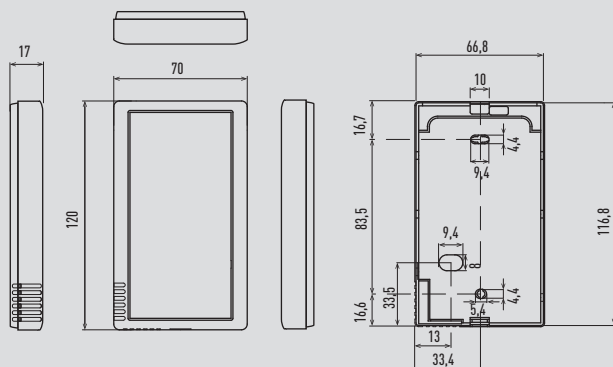

CZ-ANC3 ON/OFF Controller

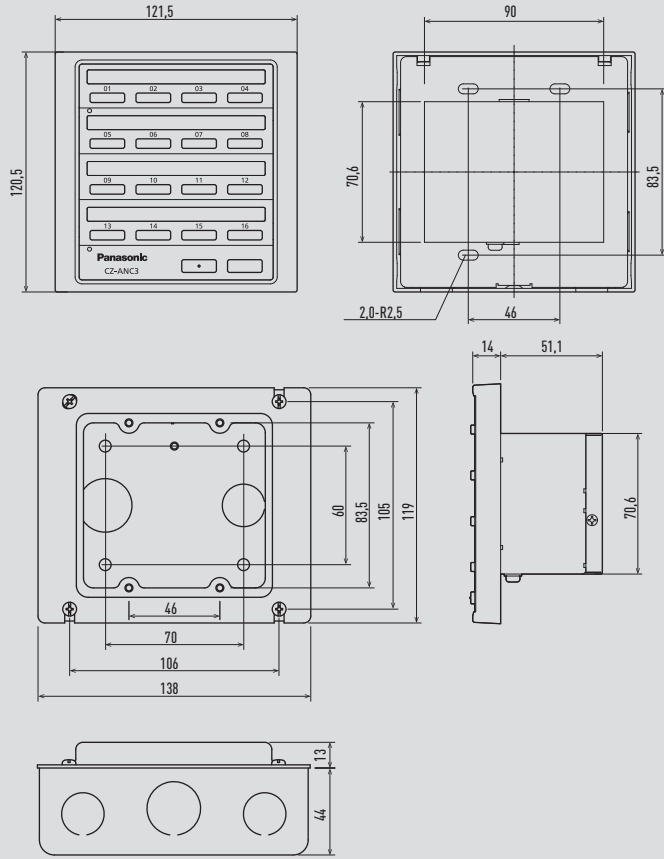

CZ-256ESM3 Intelligent Controller (Touch screen panel)

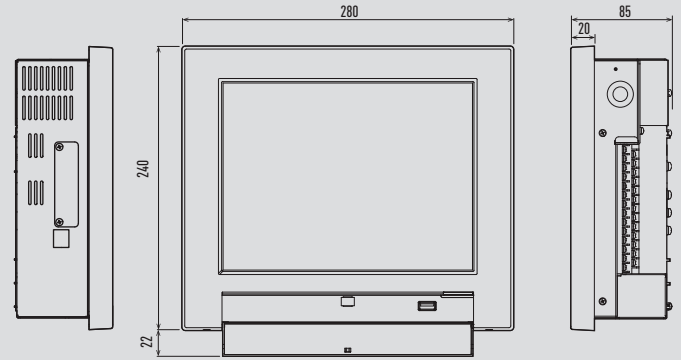

CZ-CAPDC2 Seri-Para I/O unit for outdoor unit

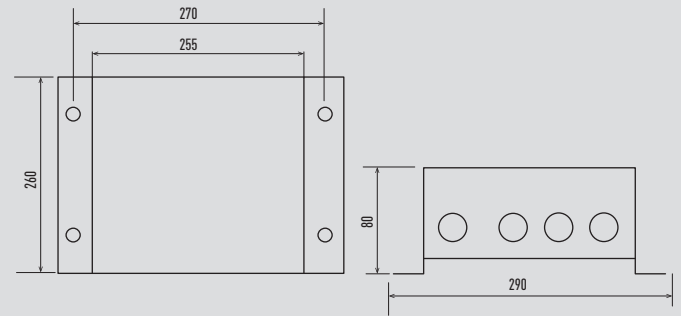

CZ-CAPC3 Local adaptor for ON/OFF control

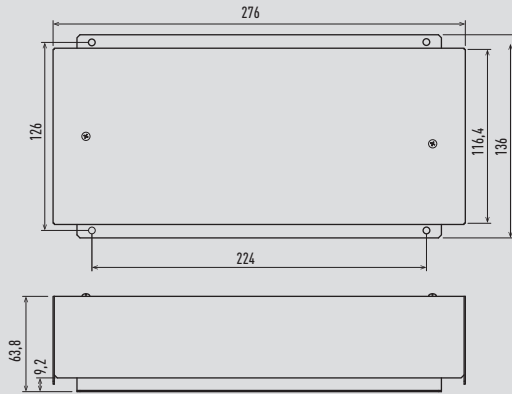

CZ-CAPBC2 Mini Seri-Para I/O Unit 0 -10V

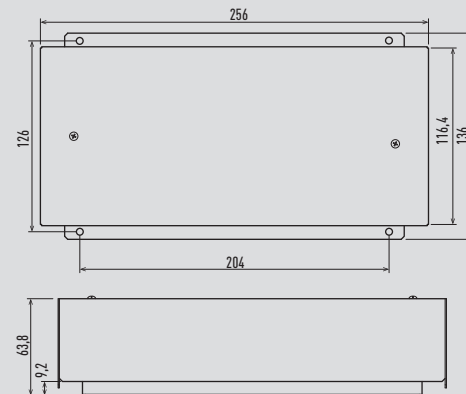

CZ-CFUNC2 Communication Adaptor

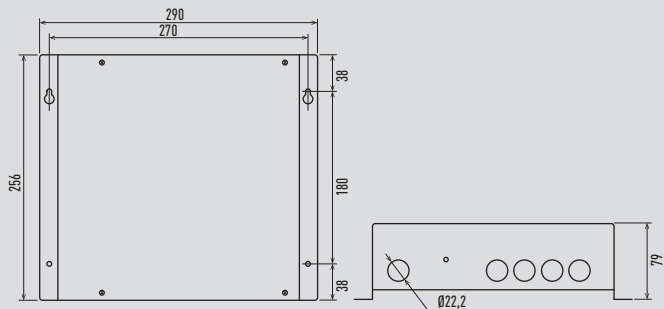

CZ-CAPWFC1 Commercial WLAN adapter

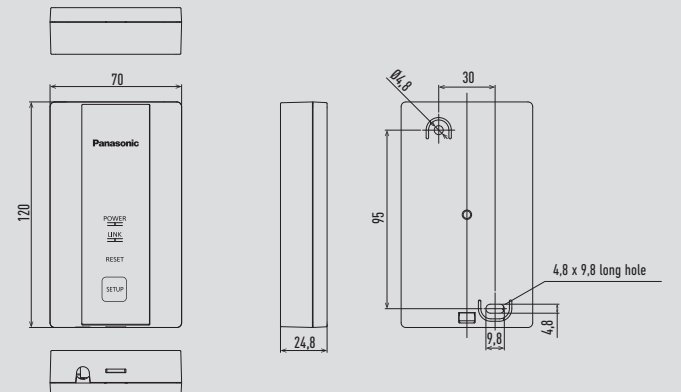





www.aircon.panasonic.eu

heating & cooling solutions

Due to the ongoing innovation of our products, the specifications of this catalogue are valid for the typographic errors, and may be subject to minor modifications by the manufacturer without prior warning in order to improve the product. The total or partial reproduction of this catalogue is prohibited without the express authorisation of Panasonic Marketing Europe GmbH.

Panasonic[®]

To find out how Panasonic cares for you, log on to: www.aircon.panasonic.eu

Panasonic Marketing Europe GmbH.
South-East Europe Branch Office
1117 Budapest, Aliz utca 4. – Office Garden III.



Do not add or replace refrigerant other than the specified type. Manufacturer is not responsible for the damage and deterioration in safety due to usage of the other refrigerant.
The outdoor units in this catalogue contains fluorinated greenhouse gases with a GWP higher than 150.

