

Panasonic

NEW AQUAREA RANGE

HIGH-EFFICIENCY HEAT PUMP TECHNOLOGY

2015 — 2016

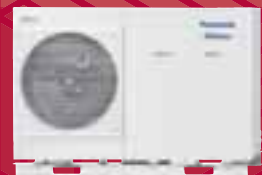

NEW AQUAREA AIR TO WATER HEAT PUMP 2015 - 2016

AQUAREA

heating & cooling solutions

NEW 2015 / 2016

AQUAREA AIR TO WATER HEAT PUMP

Summary

PANASONIC, THE AIR OF YOUR LIFE	4	AQUAREA HIGH PERFORMANCE BI-BLOC SINGLE PHASE HEATING ONLY - SDF / HEATING AND COOLING - SDC 3 AND 5KW	44
RELIABILITY FACTS	6	AQUAREA HIGH PERFORMANCE BI-BLOC SINGLE PHASE / THREE PHASE HEATING AND COOLING - SDC	45
PANASONIC NO. 1	8	AQUAREA T-CAP BI-BLOC SINGLE PHASE / THREE PHASE HEATING AND COOLING - SXC	46
PANASONIC – LEADING THE WAY IN HEATING AND COOLING	10	AQUAREA HT BI-BLOC SINGLE PHASE / THREE PHASE HEATING ONLY - SHF	47
PRO CLUB	12	AQUAREA HIGH PERFORMANCE MONO-BLOC SINGLE PHASE / THREE PHASE HEATING ONLY - MDF / HEATING AND COOLING - MDC	48
WELCOME TO AQUAREA AIR TO WATER HEAT PUMP	14	AQUAREA G GENERATION HIGH PERFORMANCE MONO-BLOC SINGLE PHASE HEATING AND COOLING - MDC	49
HIGHLIGHTED FEATURES	16	AQUAREA T-CAP MONO-BLOC SINGLE PHASE / THREE PHASE HEATING ONLY - MXF / HEATING AND COOLING - MXC	50
AQUAREA, A CLASS WATER PUMP	18	AQUAREA G GENERATION T-CAP MONO-BLOC SINGLE PHASE / THREE PHASE HEATING AND COOLING - MXC	51
AQUAREA COMPLETELY NEW LINE-UP	20	AQUAREA HT MONO-BLOC SINGLE PHASE / THREE PHASE HEATING ONLY - MHF	52
NEW AQUAREA HIGH PERFORMANCE	22	AQUAREA G GENERATION HT MONO-BLOC SINGLE PHASE / THREE PHASE HEATING ONLY - MHF	53
NEW AQUAREA T-CAP	24	AQUAREA HIGH PERFORMANCE MONO-BLOC SINGLE PHASE HEATING ONLY - MDF / HEATING AND COOLING - MDC	54
NEW AQUAREA HT	26	SANITARY TANKS	55
AQUAREA COMMERCIAL	28	AQUAREA AIR RADIATORS	56
NEW AQUAREA ALL IN ONE	30	ACCESSORIES	58
CONTROL & CONNECTIVITY	32	CONTROL	58
INTERNET CONTROL	34	EXAMPLES OF INSTALLATIONS WITH AQUAREA MANAGER	59
CONNECTIVITY. CONTROL BY BMS	35	NEW AQUAREA DHW	60
PV PANELS + HEAT PUMP MANAGER	36	A TYPICAL EXAMPLE OF SAVINGS AND EFFICIENCIES THAT AQUAREA CAN OFFER TO YOU	62
AQUAREA DESIGNER	38	HEATING CAPACITY TABLE BASED ON OUTLET TEMPERATURE AND OUTSIDE TEMPERATURE	64
AQUAREA HEAT PUMPS LINE-UP	40	ERROR CODES	73
AQUAREA ALL IN ONE HIGH PERFORMANCE BI-BLOC SINGLE PHASE HEATING AND COOLING	42	DIMENSIONS	74
AQUAREA ALL IN ONE T-CAP BI-BLOC SINGLE PHASE / THREE PHASE HEATING AND COOLING	43		



Quality Management System Certificate



Certified to ISO 9001: 2008
Panasonic Appliances Air-Conditioning
Malaysia. Sdn.Bhd.
Cert. No.: MY-AR 1010



Certified to ISO 9001: 2008
Panasonic Appliances Air-Conditioning
(GuangZhou) Co., Ltd.
Registration Number: 01209Q20645R5L

Environmental Management System Certificate



Certified to ISO 14001: 2004
Panasonic Appliances Air-Conditioning
Malaysia Sdn.Bhd.
Cert. No.: MY-ER0112



Certified to ISO 14001: 2004
Panasonic Appliances Air-Conditioning
(GuangZhou) Co., Ltd.
Registration Number: 02110E10562R4L

Aquarea Range Highlights

All in One

New All in One solution from 3 to 16kW with 200l tank, A class pump and small foot print. Ideal for new and retrofit homes.



A class water pump

HIGH EFFICIENCY



New Mono-Bloc generation

With A class water pump and the new remote controller to improve performance, enhance comfort and deliver maximum savings.



A class water pump

HIGH EFFICIENCY



New T-CAP Bi-Bloc 16kW

New 16kW T-CAP Bi-Bloc, ideal for retrofit and commercial applications.



A class water pump

HIGH EFFICIENCY



Featured Remote Control

Ease of use and advanced features for install, maintenance and user with the new generation control. Built in F generation Bi-Bloc and new G Generation Mono-Bloc.



Aquarea DHW

New Panasonic Aquarea DHW tank with built-in heat pump. Range from 80 to 285L.



AQUAREA
DHW

Control and connectivity

Integrate Aquarea system to any protocol: KNX, Modbus, BACnet, EnOcean... Or integrate other heating system with Aquarea HPM control and/or control Aquarea from anywhere with Wifi adapter.



Modbus®





Panasonic,
the Air of your Life
Since 1958

Panasonic, the Air of your Life

Panasonic Air Conditioners have been with us since 1958. In many homes they are part of the family and are, in part, responsible for the air that each member breathes.

Many things happen in your home, and Panasonic makes sure that those moments have the best climate. Panasonic Air Conditioners were the first to produce Healthy Air, and also worry about being super-efficient and quiet. Which is why they have been among us for so long.



1958

First room air conditioner launched for domestic installation.



1973

Panasonic launches the first highly efficient air-to-water heat pump in Japan.



1975

Panasonic becomes the first Japanese air conditioner manufacturer in Europe.



2008

Etherea new concept of air conditioning systems: high efficiency and high performances with a great design.



No.1
in Japan

40 years
in Europe

History of Air Conditioning Group

Panasonic starts with a desire to create things of value. As hard work and dedication results in one innovative product after another, the fledgling company takes its first steps towards becoming the electronics giant of today.



2010

New Aquarea. Panasonic has created Aquarea, an innovative new, low-energy system.



2011

The new Panasonic ECOi VRF solution for big buildings is the most efficient in the industry in more than 74% of combinations.



2012

New GHP units. Panasonic's gas-driven VRF systems are ideal for projects where power restrictions apply.



Looking ahead

By creating, storing, managing and saving energy, Panasonic aims to realize a lifestyle with virtually zero CO₂ emissions throughout the entire home.



Reliability facts

Reliable comfort comes from reliable technologies

Today, Panasonic air conditioners have earned widespread acclaim throughout the world. A rugged design ensures that the air conditioner will continue to keep the room comfortable, and operate trouble-free for many years. Panasonic believes this is the true value of an air conditioner. And this is why we subject them to a wide range of stringent tests.

Durability. Long Time Continuous Operation Simulation.



Long-term Durability Test

The air conditioner's main mission is to provide a level of durability that allows it to operate stably for years. In order to achieve this, we conduct an accelerated test for 10,000 hours of continuous operation. The results of this test, which is conducted under conditions that are much more severe than actual operating conditions, prove the rugged strength of Panasonic air conditioners.



Compressor Disassembly Test

After a test with 10,000 hours of continuous operation, we remove the compressor from a randomly selected outdoor unit, disassemble it, then examine the internal mechanisms and parts for possible failure. Panasonic air conditioners continue to provide their designed performance for many years even after prolonged operation under harsh conditions.



Operating Test in Harsh Conditions

In addition to normal operating conditions, an operating durability test is conducted in a high-temperature, high humidity test chamber at a temperature of 55°C. For use in cold climates, the test is also conducted in a low temperature test chamber at -20°C. This test assures that the oil inside the compressor will not freeze during use and interrupt operation.



Checking the oil inside the compressor under extremely cold conditions.



Waterproof Test

The outdoor unit, which is subject to rain and wind, is provided with IPX4 waterproof compliance. Contact sections on printed circuit boards are also resin-potted to prevent adverse effects caused by an unlikely exposure to droplets of water.



A resin-potted circuit board.



Shock Resistance

Panasonic simulates impacts, vibrations and other environmental conditions that air conditioners might be subjected to during transport. We promise that the quality and performance at the time of the final product inspection are unchanged when the product reaches the user's home.

No Breaking. When Dropped onto Sides or Corners.



Drop Test

Even with the large impacts that may occur due to improper handling during transportation, the product packaging has been strengthened to prevent it from being damaged. In addition to conventional vertical dropping, more severe conditions in which the sides or corners hit the floor first are carefully tested to ensure that the product's rigidity and shock-absorbing materials work to prevent problems.



Vibration Test

Preventing damage that would hinder the product's performance due to vibration during transport is a major role of the packaging. Panasonic confirms that the product operates properly even after applying vibrations in both horizontal and vertical directions.



Warehouse Storage Test

During distribution, products may be subjected to extended warehouse storage under unfavourable conditions. To simulate these conditions, we place a weight equal to a stack of five product packages on top of the test package, and leave it in that condition in a room at a temperature of 27°C and a humidity level of 85%. Then, the product is checked for proper operation.



Comfort

Air conditioners should keep each person in the room comfortable without making their presence known. They should work totally in the background, using their strength to create and maintain a relaxing environment. We build this hidden strength into our air conditioners, and test them repeatedly from this viewpoint.

Silence. That Does Not Disturb You.



Noise Test

The operating noise of the indoor and outdoor units is measured in an echo-free chamber. The noise test verifies that the operating noise is low enough so that the product operation will not disturb daily activities including conversations and sleep.



Amenity Test

An actual air conditioner is operated in a test room that simulates an ordinary living room. Conditions such as the amount of sunlight entering the room from outside are changed while measuring a variety of parameters, such as cooling speed, cooling efficiency, and temperature and humidity differences throughout the room. This makes it possible to confirm whether the air conditioner is operating at its designed performance level under ordinary conditions.



EMC (Electromagnetic Compatibility) Test

This test determines whether electromagnetic waves emitted during operation are sufficiently low to prevent adverse effects, i.e., electrical noise, on signals such as TV and radio broadcasts.



Remote Control Dropping Test

Because the remote control is the main interface between people and the air conditioner, it is naturally subjected to frequent impacts - such as drops and bumps - when it is passed from person to person during normal operation. Panasonic drops the remote control from a height of 1.5 metres at various angles to ensure that no problems in basic performance will result from accidental dropping.

Quality. Is at the Core of All Our Manufacturing.



World Standard Quality

Over the years, Panasonic air conditioners have continued to offer the highest possible quality with the lowest environmental impact worldwide. Naturally, the fundamental production principles that are common to all Panasonic products apply to air conditioners as well. The fact that these principles actively support every product, rather than simply serving as slogans, is the result of the endless repetition of challenges and trial-and-error efforts that are conducted at our production bases all over the world.



Reliable Parts with Major Standards Approval

Panasonic air conditioners comply with all of the major standards that maintain high reliability in the countries and regions where they are marketed. To ensure this, we conduct a variety of tests to examine the quality of materials used in parts.

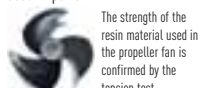

The strength of the resin material used in the propeller fan is confirmed by the tension test.



RoHS/REACH Compliant Parts

All parts and materials comply with RoHS/REACH, Europe's world-leading environmental regulations. Stringent inspections of more than 100 materials are conducted to ensure that no hazardous substances are included during parts development.



Sophisticated Production Process

The air conditioner production line uses advanced, state-of-the-art factory automation technologies to produce products with higher reliability. Products are efficiently manufactured with high and uniform quality.



Eco Activities

Panasonic has set up eco ideas factories around the globe. While developing and manufacturing energy-saving products based on original environmental technologies, these factories reduce CO2 emissions from manufacturing processes and conduct regional-based environmental communication activities to contribute to both the global environment and the local communities that they serve.



BEST
GLOBAL
GREEN
BRANDS
2014

Interbrand | 

Panasonic No. 1

Interbrand Ranks Panasonic No. 1 in the Electronics Sector for the “Best Global Green Brands 2014”

Interbrand, the US brand consulting company, announced on June 24, 2014, that Panasonic ranks No. 5 in its Best Global Green Brands 2014. Although a rank lower than last year, the company has come out top in the electronics sector.

2014 marks the fourth year for this global ranking of “green brands.” An Excellent Green Brand is defined as achieving a good balance between Green Perception (consumers’ image of an eco-brand) and Green Performance (a company’s environmental management practices). The top 50 companies are ranked based on these two elements.

Evaluation Points

Panasonic’s Green Performance was evaluated as being especially high, with excellent marks going to “Products and Services,” “Governance,” and “Transportation and Logistics.”

Interbrand also noted the following points in its evaluation

Energy Star Award Recognitions: Panasonic has received more Energy Star awards than any other consumer electronics manufacturer.

Achieved a Recycling Rate of 99.3%: Taking steps toward zero waste, Panasonic achieved a factory waste recycling rate of 99.3% in 2013.

Improved Water Usage: In 2013, water usage at factories per basic unit of production improved by 0.7% compared with 2012.

Econavi Function: In 2009, Panasonic launched home appliances with the Econavi function, which automatically controls power and water consumption to cut losses by using sensor and other energy efficient technologies.

We aim to realize a lifestyle with virtually zero CO₂ emissions throughout the entire home

By creating, storing, managing and saving energy, Panasonic aims to realise a lifestyle with virtually zero CO₂ emissions throughout the entire home.

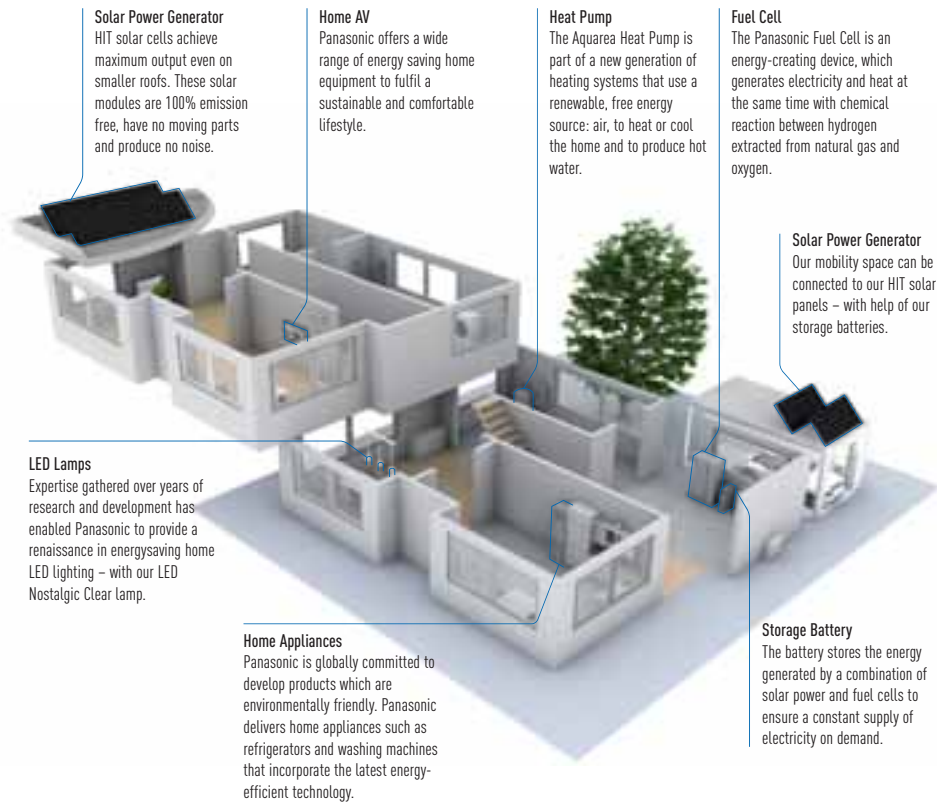

Exemplary sustainable projects

What is Smart Electric Lyon?

Smart Electric Lyon is a project that looks at electricity consumption as a key part of the building energy solutions of tomorrow. This experiment, will be conducted for four years in more than 25,000 homes, businesses and communities of Grand Lyon. Panasonic will provide the project with a variety of its energy efficient heating and cooling products, including the Aquarena Air Source Heat Pump. These heat pumps are especially equipped with connectivity solutions from Panasonic to ensure the systems are easy to use, and collect the vital, accurate data. This project is particularly apt for Panasonic, as heating and hot water occupy a prominent place in household energy consumption. The company has involved for the project a dedicated and experienced R&D team from Panasonic’s European technical centre in Frankfurt.



Fujisawa Sustainable Smart Town Goes Into Full-Scale Operation Near Tokyo

Fujisawa SST Council, a consortium led by Panasonic Corporation spearheading the development of the Fujisawa Sustainable Smart Town (Fujisawa SST). With its core facility supporting sustainable development of the town and its community now coming into operation, the Fujisawa SST is moving from the construction stage into a new stage where the town is nurtured to grow in full-scale into an eco and smart town that puts a high priority on the residents’ lifestyles. The Fujisawa SST Management Company is the town management company located in the SQUARE. Together with partner companies, the

company provides five essential services in the town: energy, security, mobility, healthcare and community. The company will also collect and manage information pertaining to the town’s overall environment, energy, security and safety to support an eco and smart life in the town. As a fresh development in the town, the Fujisawa SST has set a detached housing zone for non car owners for the second phase of sales. By using the town’s eco-car sharing and rent-a-car services, residents in the zone can enjoy their lifestyles without the need to own a car while reducing economic burden and making effective use of the lot. Preparations are also underway for a new base to provide environmentally-friendly logistic services to the residents.





heating & cooling solutions



Panasonic – leading the way in Heating and Cooling

With more than 30 years of experience, selling to more than 120 countries around the world, Panasonic is unquestionably one of the leaders in the heating and cooling sector. With a diverse network of production and R&D facilities, Panasonic delivers innovative products incorporating cutting-edge technologies that set the standard for air conditioners worldwide. Expanding globally, Panasonic provides superior international products transcending borders.

100% Panasonic: we control the process

The company is also a world leader in innovation as it has filed more than 91,539 patents to improve its customers' lives. Moreover, Panasonic is determined to remain at the forefront of its market. In all, the company has produced more than 200 million compressors and its products are manufactured in 294 plants which are located all over the world. You can be assured of the extremely high quality of Panasonic's heat pumps.

This wish to excel has made Panasonic the international leader in heating and turn-key air conditioning solutions. These offer maximum effectiveness, comply with the strictest environmental standards and meet the most avant-garde construction requirements of our time.

Projects & Case Studies of Panasonic Heating and Cooling Solutions



Call centre retrofit. Woodhouse Environmental Services Ltd. Bourmemouth, UK. **VRF**



New residential building. 84 apartments. Barcelona, Spain. **Aquarea**



New condominium. Bergås Terrasse complex. Drammen, Norway. **ECOi / Aquarea**



Hotel refurbishment. Hotel Claris 5 * Barcelona, Spain. **ECOi**



New residential building. 176 flats Xàtiva, Spain. **ECO G**



French Winery. Boutiers-Saint-Trojan, France. **ECO G**



Le Centurie Centro Commerciale. 40,000 m² with 40 commercial spaces. Padua, Italy. **ECOi**



Europa-Park is the second most popular theme park resort. 300 rooms. Germany. **ECOi**



The National Grid's. Call Center refurbishment. Hinkley, UK. **ECO G**



The exclusive Sunprime Atlantic View resort, owned by Thomas Cook. 220 rooms. Canary Islands. Spain. **ECO G**



Montcenis Nursing Home. Over 6100 m² and 85 rooms. Saône et Loire, France. **ECO-G**



Smart House. Ariake, Tokyo. **HVAC and the combination of solar power generation, fuel cells and storage batteries.**



Technopark of Nobosibirsk Academgorodok. Novosibirsk, Russia. **ECOi**



Shippensburg University. Pennsylvania, United States. **ECOi**



Urban residential Mosaic Panama Pacifico. Republic of Panama. **Mini ECOi**



Patra Jasa Bandung Hotel. Bandung, Indonesia. **ECOi**

To find out more: www.aircon.panasonic.eu



PRO Club

the professional website of Panasonic

Panasonic has an impressive range of support services for designers, specifiers, engineers and distributors working in the heating and cooling markets.

Panasonic PRO Club (www.panasonicproclub.com) is the online tool which makes your life easier! You just have to register and a lot of functionalities are freely available to you, where ever you are, from your computer or smart phone!

- **Print catalogues with your logo and your address**
- **Download the latest Aquarea designer to define your system and select the good Aquarea Heat pump.**
- **Calculate the specs of the Aquarea Air fan coil based on the parameters of your system**
- **Get Documents of conformity and all other documents you may need**
- **Download all the service manuals, end user manuals and installation manuals**
- **Know what to do with error codes**
- **Find out about the latest news first**
- **Register for training**

Highlighted Features

- Extensive library of resources
- Tools & Apps for end users. Check availability in your country:
 - My Home: sizing wizard for domestic and A2W range
 - My Project: Contact form to Panasonic team
 - iFinder: Lists of installers displayed by postcode
- Special offers & promotions
- Training PRO Academy
- Catalogues (Commercial documentation)
- Marketing (Images in high resolution, advertisements, deco guidelines)
- Tools (Professional software, sizing tools...)

NEW Highlighted Features

- **NEW!** Installers customize leaflets in PDF format with their logo & contact details
- **NEW!** Energy label generator. Download energy labels of any device in PDF format
- **NEW!** Heating calculator demand
- **NEW!** Noise calculator for outdoor unit
- **NEW!** Aquarea Radiator calculator
- **NEW!** Error Code Search by error code or unit ref. Compatible with smartphone and tablet computer
- **NEW!** Revit / CAD Images / Spec texts
- **NEW!** Access to Pananet, online library of technical documentation
- **NEW!** Download Documents of Conformity and other Certifications
- **NEW!** Commissioning online



NEW! Easy download Panasonic service documentation and brochures



NEW! Customize leaflets with your logo & contact details. Save and print the PDF



NEW! Energy label generator. Download Energy labels of any device in PDF format



NEW! Error Code on your smartphone and your PC: Search by error code or model reference. Online version + downloadable version for offline use



Panasonic PRO Club is fully compatible with tablet computer and smartphone



The Panasonic PRO Academy

Panasonic takes its responsibility to its distributors, specifiers and installers seriously and has developed a comprehensive Training Programme. The Panasonic Pro-Academy encompasses the traditional hands-on approach.

New training courses cover three levels. Design, installation, and commissioning & trouble-shooting. Training courses include:

- Domestic applications Air to Air
- Aquarea air source heat pumps
- VRF ECOi

The courses are offered on site at Panasonic's premises across Europe as well as via the Panasonic ProClub eLearning site. The Training Centres display Panasonic's latest product range and give delegates an opportunity to get hands-on experience with the latest controllers, indoor and outdoor units from the VRF ECOi, Etheera, GHP and Aquarea ranges.



PRO Club

www.panasonicproclub.com

or connect simply with your smartphone to the PRO Club using this QR



ErP
ready
2015



AQUAREA



* Not all products certified. As the certification process is on-going and the list of certified products constantly changing, please check for latest details on the official websites.



WELCOME TO AQUAREA AIR TO WATER HEAT PUMP

Aquarea's new Air to Water Heat Pump for residential and commercial applications

Offering capacities from 3kW all the way through to 16kW, the Aquarea Heat Pump Range is the widest on the market, ensuring a system is available, whatever your heating and cooling needs. Suitable for new build and refurbishment projects, the systems are cost-effective and environmentally friendly.



Highlighted Features

Panasonic's Aquarea range of heat pumps deliver major energy savings thanks to its incredible efficiency even at -20°C

Aquarea is part of a new generation of heating systems that use a renewable, free energy source (the air) to heat or cool the home and to produce hot water:

- Extremely high efficiency (COP of 5,08 for new 5kW Mono-Bloc unit)
- Line up developed for low consumption homes (starting at 3kW)
- T-CAP solution is ideal for cold areas, as it maintains the nominal capacity up to -15°C
- Easy to control with your smart phone (using an optional interface)
- Large range of efficient tanks for domestic hot water storage

The Panasonic Aquarea Heat Pumps are designed and produced by Panasonic and not by other companies.



ENERGY SAVING

ErP ready
2015

ErP ready 2015 applies to European directive for energy related products. Our products are ErP ready based on preliminary data.

A class water pump
HIGH EFFICIENCY

Aquarea Bi-Bloc F Generation and normal G Generation are built-in with A class water pump.

High efficiency heating
INVERTER+

The A Inverter+ system provides energy savings of up to 30% compared to non Inverter models. Both you, and nature, wins!

Environmentally friendly refrigerant
R410A / R407C

Refrigerant R410A / R407C offers optimal performance and involves no environmental cost since it does not harm the ozone layer.

Down to -20 °C in heating mode
OUTDOOR TEMPERATURE

Down to -20 °C in heating mode. The Heat Pumps work in heat pump mode with an outdoor temperature as low as -20 °C.

5,08 COP high efficiency
AQUAREA HIGH PERFORMANCE

Aquarea High Performance for low consumption houses. From 3 to 16 kW. For a house with low temperature radiators or under-floor heating, our high performance Aquarea HP is a good solution.

100% capacity at -15 °C
AQUAREA T-CAP

Aquarea T-CAP for extremely low temperatures. From 9 to 16 kW. If the most important aspect is to maintain nominal heating capacities even at temperatures as low as -7 °C or -15 °C, select the Aquarea T-CAP.

Output water 65 °C
HIGH TEMP HEAT PUMP

Aquarea HT ideal for retrofit. From 9 to 12 kW. For a house with traditional high-temperature radiators, the Aquarea HT Solution is the most appropriate as the Aquarea HT can work in output water temperatures of 65 °C even at outdoor temperatures as low as -20 °C.

Internet Control Ready
INTERNET CONTROL

Internet Control is a next generation system providing a user-friendly remote control of air conditioning or heat pump units from everywhere, using a simple Android or iOS smartphone, tablet or PC via internet.



Thanks to Aquarea HPM, Aquarea range (Bi-Bloc and Mono-Bloc) is holding the SG Ready Label (Smart Grid Ready Label), given by Bundesverband Wärmepumpe (German Heat Pump Association). This Label shows the real capacity of Aquarea to be connected in an intelligent grid control.

HIGH CONNECTIVITY

Boiler connection
RETROFIT

Renovation. Our Aquarea heat pumps can be connected to an existing or new boiler for optimum comfort even at very low outdoor temperatures.

Solar panels connection
SOLAR KIT

Solar Kit. For even greater efficiency, our Aquarea heat pumps can be connected to photovoltaic solar panels with an optional kit.

Domestic hot water
DHW

DHW. With Aquarea you can also heat your domestic hot water at a very low cost with the optional hot water cylinder.

Easy control by BMS
CONNECTIVITY

Connectivity. The communication port is integrated into the indoor unit and provides easy connection to, and control of, your Panasonic heat pump to your home or building management system.

5 year compressor warranty

5 Years Warranty. We guarantee the compressors in the entire range for five years.

~~AQUAREA~~



A class
water pump

HIGH EFFICIENCY

Aquarea, A class water pump

Panasonic's new Aquarea air to water system can work in outdoor temperature even at -20°C

Panasonic's new Aquarea system, based on high-efficiency heat pump technology, not only heats your home and hot water, but also cools your home in summer with incredible operating performance. This creates perfect comfort whatever the weather conditions, even at outdoor temperatures as low as -20°C. Panasonic new heat pumps are designed in response to the new demand for low consumption housing, with high efficiency and low running costs.

Impressive Energy Savings: Panasonic's Aquarea Heat Pump provides savings of up to 80% on heating expenses compared to electrical heaters.

Why air source heat pumps?

- Reduced heating bills and maintenance costs
- Savings of up to Euro 1,000 a year are possible. 30%-40% reduction in annual energy bills
- Reduce your carbon footprint
- Simple to integrate into most heating systems
- Energy efficient alternative to oil, LPG and electric systems
- Highly compatible with other energy efficient energy sources eg solar panels
- Provides sustainable heating, cooling and hot water for your home
- Ideal for properties without access to mains gas
- Externally positioned saving valuable internal living space
- Proven technology from Panasonic and already well established in other EU countries



Up to 80% energy savings*

At the forefront of energy innovation, Aquarea is resolutely positioned as a “green” heating and air-conditioning system. Aquarea is part of a new generation of heating and air-conditioning systems that use a renewable, free energy source – the air – to heat or cool the home and to produce hot water. The Aquarea heat pump is a much more flexible and cost-effective alternative to a traditional fossil fuel boiler.

“Green” High-efficiency heating with Panasonic’s new Air to Water Heat Pump Systems

Panasonic’s Aquarea Heat Pump provides savings of up to 80% on heating expenses compared to electrical heaters. For example, the Aquarea 5kW system has a COP of 5,08. This is 4,08 more than a conventional electrical heating system which has a maximum COP of 1. This is equivalent to an 80%* saving. Consumption can be further reduced by connecting photovoltaic solar panels to the Aquarea system.

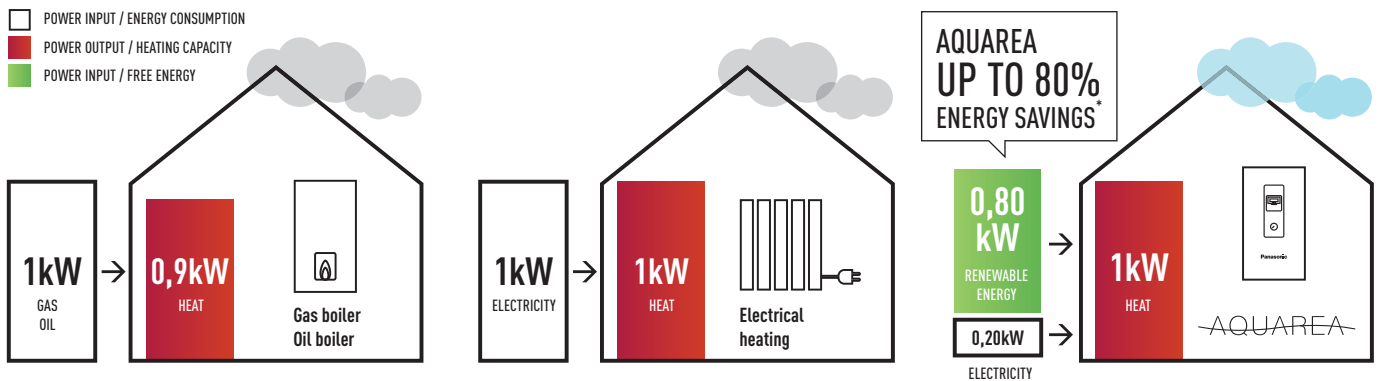

* Up to 80% of the heat produced by a heat pump is free, since it comes from the outdoor air. Rating conditions: Heating: Inside air temperature: 20°C Dry Bulb / Outside air temperature: 7°C Dry Bulb / 6°C Wet Bulb. Conditions : Water input temperature: 30°C Water output temperature: 35°C

Inverter+ compressor for even greater efficiency

Panasonic has clearly demonstrated its status as leaders in this field with over 200 million compressors supplied and the excellent quality and reliability of its heat pumps. With a Panasonic Inverter+ compressor, you can save up to 30% energy compared to a traditional system with no inverter. With a Panasonic Inverter compressor, the heat pump is always producing heat with the maximum of efficiency and adapting the capacity to the element.

The advantages of inverter heat pumps. Comparing Inverter and non-Inverter heat pumps.

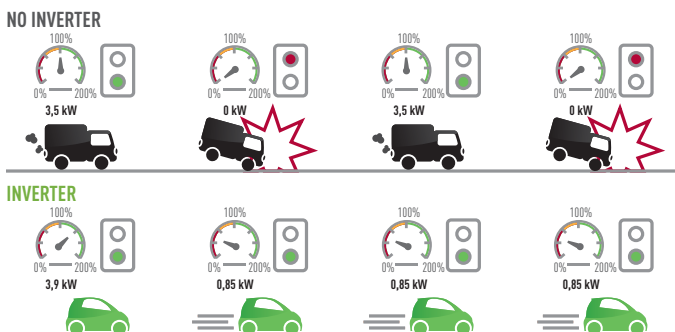

NO INVERTER Slow to start. Takes longer to reach the temperature set point. The temperature oscillates between the two extremes and never stabilises. The temperature falls and then rises quickly, leading to a consumption peak.
INVERTER Rapidly reaches the desired temperature. Adjusts the temperature: more comfort and greater savings. Keeps the temperature comfortable all the time.

“We expect to save around 1,000 € a year on fuel costs and we’ve been able to get rid of a large ugly oil tank in the garden thanks to the new Aquarea.”

Aquarea Customer, Surrey¹



1) Information provided by Aquarea customer, August 2012.

5,08 COP
high efficiency
AQUAREA
HIGH PERFORMANCE



100%
capacity
at -15 °C
AQUAREA T-CAP

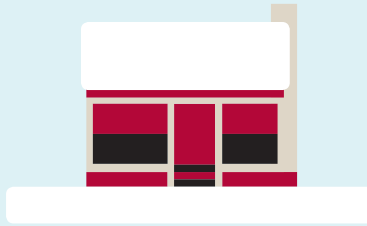

Output water
65 °C
HIGH TEMP
HEAT PUMP



Aquarea completely new line-up

Panasonic has designed a completely new line-up to offer the best to our customers.

There are several types of heat pump available:

- The Mono-Bloc system: This only has an outdoor unit. The installation doesn't require a refrigerated connection and is only connected to the heating and/or hot water.
- The Bi-Bloc system: The system, separate indoor and outdoor units, connects to the heating and/or hot water system.
- New All in One: Hydromodule + 200l tank. Panasonic has developed a highly efficient solution, easy to install.

A wide range from 3 to 16kW, Single and Three Phase, Mono-Bloc and Bi-Bloc. 3 Versions:

Aquarea High Performance for low consumption houses. From 3 to 16kW

For a house with low temperature radiators or under-floor heating, our high performance Aquarea HP is a good solution. This solution can work as a stand-alone unit or can be combined with an existing gas- or oil-fired heating system depending on requirements. This new solution is ideal for low consumption homes.

Aquarea T-CAP. From 9 to 16kW

If the most important aspect is to maintain nominal heating capacities even at temperatures as low as -7°C or -15°C, select the Aquarea T-CAP. This ensures that there is always enough capacity to heat the house without help from an external boiler – even at extremely low temperatures. Aquarea T-CAP always has high efficiency and high heating capacity even at extremely low temperatures. With Aquarea T-CAP, you can always enjoy high savings.

Aquarea HT. From 9 to 12kW

For a house with traditional high-temperature radiators (such as cast iron radiators), the Aquarea HT Solution is the most appropriate as the Aquarea HT can work in output water temperatures of 65°C even at outdoor temperatures as low as -20°C. Aquarea HT is able to deliver hot water to 65°C with the Heat Pump alone.



KNX
Modbus

Aquarea outdoor air source heat pumps
Panasonic has developed an extensive range of air-to-water heat pumps designed to efficiently convert free air into sustainable heating and hot water. Fitted externally to your home and designed to operate in all year round weather conditions (-20°C), it's the smart alternative to oil, LPG and electric heating systems.

Aquarea Heat Pump Manager (Optional)
This new generation of smart controllers for eco-efficient heating, features our versatile stand-alone controller not only for our heat pump systems, but also your gas, oil boiler and all other devices installed on your heating system.

Heating control App for smart phone, tablet or computer (Optional)
The heating control App allows you to control the heating and hot water system via your smart phone, tablet or computer with ease, whether at home or away.
The heat pump can be also connected to house management system using KNX or Modbus interfaces.



Super High Efficiency: PAW-TE20/30/50E3HI (Optional)

- High efficient tank solution: specially designed to improve the efficiency of the sanitary hot water production.
- HI lineup:
 - low energy losses
 - high exchange surface for high efficiency and short time to heat up the water



High efficient radiators for heating and cooling (Optional)

- High efficient radiators working with water at 35°C.
- No need for two kits if both floor heating and radiators are required.
- As the product is efficient, it opens the possibility to also provide cooling while still meeting construction requirements.

Panasonic offers a cooling mode within its heat pump range for low consumption homes



Heat Pump + HIT Photovoltaic solar panel (Optional)
Photovoltaic solar panels: the best solution for big savings. Combining photovoltaic solar panels with your heat pump can help to further reduce your electrical consumption and CO₂ emissions. Additionally, with the unique HIT photovoltaic solar panel technology from Panasonic, you can produce more electricity per square metre, helping you to increase your energy savings still further.

FOR NEW INSTALLATIONS AND LOW CONSUMPTION HOMES

5,08 COP
high efficiency
AQUAREA
HIGH PERFORMANCE

NEW AQUAREA ALL IN ONE



NEW AQUAREA 5KW MONO-BLOC



New Aquarea High Performance

For new installations and low consumption homes. Maximum savings, maximum efficiency, minimum CO₂ emissions, minimum of space.

Panasonic has designed the new Aquarea Bi-Bloc and Mono-Bloc heat pumps for homes which have high performance requirements.

Whatever the weather, Aquarea can work even at -20°C! The New Aquarea is easy to install on new or existing installations, in all types of properties.

High Performance helps you to meet strict building requirements and reduce building costs

The heating and production of hot water have a very important impact on the energy consumption of a house. Efficient Panasonic heat pumps can help to significantly reduce the energy consumption of the house.

Total energy consumption of a conventional house, compared to the energy consumption with Panasonic heat pumps

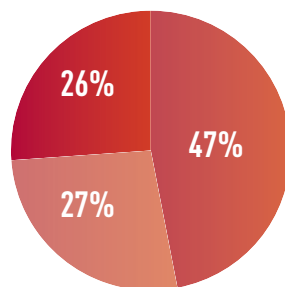

Total energy consumption of a conventional house¹

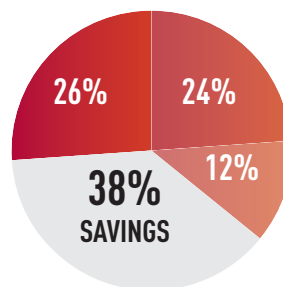

Energy consumption with Panasonic heat pumps²

- Heating
- Sanitary Hot Water
- Domestic Appliances³

1. Source: IDEA, European values 2010. Consumption of a conventional house of 80 kWh/(m².year).
 2. Source: Panasonic, RT2012 simulation, house of 50 kWh/(m².year) per year, equipped by Panasonic heat pump.
 3. Eg. Fridge telephone, oven,....

Key points of the line-up

- A Class water pump significantly reduces the energy consumption
- A Class water pump adapts water pressure according to demand, reducing energy consumption, noise on the valves, and makes installation easy.
- No Backup heater needed to maintain the capacity at -15°C, high efficiency guaranteed even at -15°C
- Many new remote control functions added:
Auto mode, holiday mode, show power consumption

High Performance Pumps are also Highly Efficient

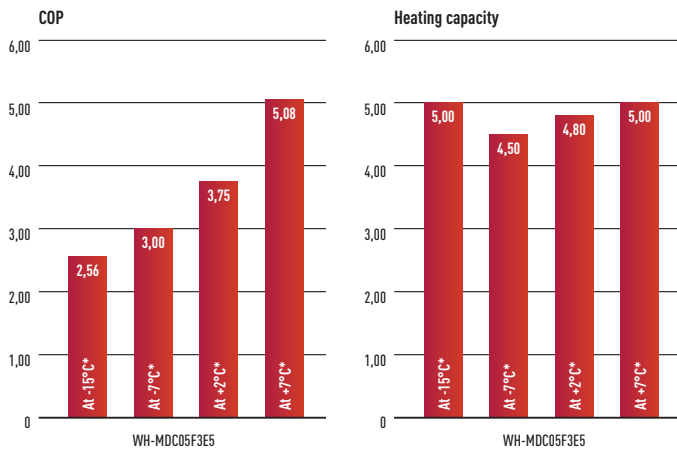

* Heating water at 35°C.

Comparison of energy consumption - Standard pumps vs A class water pump

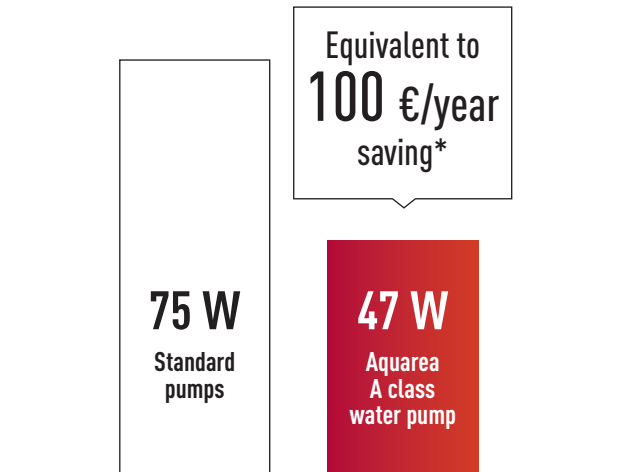

New A class water pump with Constant water flow (Dynamic pump control) for 5kW Mono-Block

* Based on German market: Assuming Standard pump may vary depending on consumption and energy cost.

With a Panasonic heat pump, there is no need to oversize the heat pump to reach the required capacity at low temperatures.

- Dedicated software for low consumption houses which allows the heat pump to produce hot water at 20°C. This is needed during the seasons, when a little heating is required
- No need for an additional expansion vessel, as the unit already has a 6l expansion vessel
- No buffer tank required as the Panasonic heat pump has an inverter compressor which can regulate the capacity. (Please check on the service manual the minimum volume of water needed on the circuit)
- 3kW electrical heater is included on the heat pump
- Panasonic heat pumps can work in outdoor temperatures as low as -20°C and guarantee the capacity without backup heating down to -15°C
- Panasonic heat pumps are very quiet and have a night mode program for even lower noise. See noise calculator on www.panasonicproclub.com

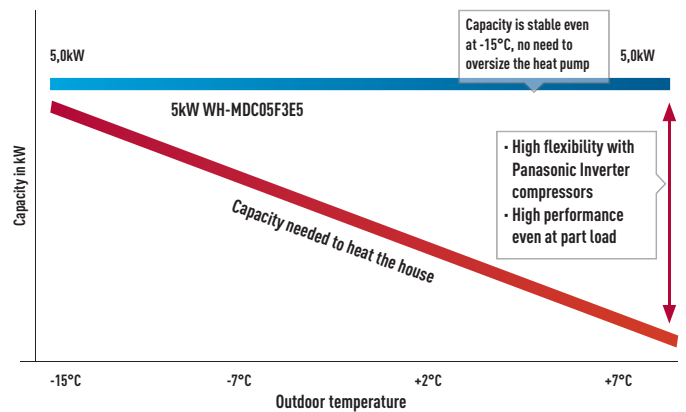

Special attention has been given to noise levels - Panasonic created a night mode to reduce the noise when it's needed.

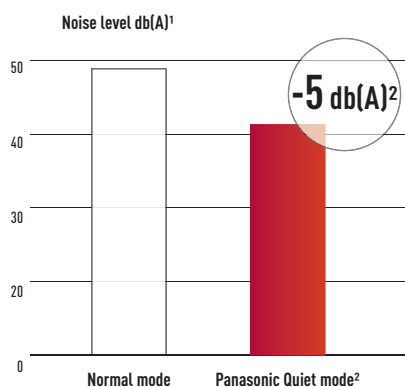

1. Sound pressure measured at 1 m from the outdoor unit and at 1,5 m height.
2. At standard condition working at heating capacity at +7°C (heating water at 35°C) for two fans outdoor units. For one fan outdoor units, night mode reduction is 3dB(A).

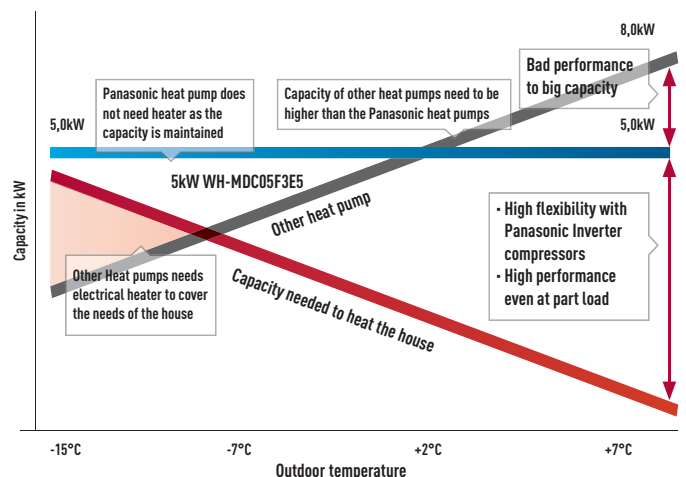

**NEW T-CAP FOR
EXTREMELY LOW
TEMPERATURES**



100%
capacity
at -15 °C
AQUAREA T-CAP

**NEW AQUAREA
ALL IN ONE**



**NEW AQUAREA
16kW BI-BLOC**



New Aquarea T-CAP

For extremely low temperatures. Install A class water pump: Industry top class energy-saving!

The whole T-CAP line-up can replace old gas or oil boilers, and in a new application with under floor heating, low temperature radiators or even fan-coil heaters. This range can also be connected to a solar kit in order to increase efficiency and minimize the impact on the ecosystem. Finally, it is possible to connect a thermostat for even better heating or cooling control and management.

- T-CAP stands for Total Capacity. This line-up is able to maintain the same nominal capacity even at -15°C without the help of an electrical booster heater.
- High heating capacity even at low ambient temperatures.
- Maintains capacity of 16 kW until -15°C outdoor temperature. Adding many new functions: Auto mode, Holiday mode, power consumption display.

The New T-CAP range has extended with the addition of the 16kW pump

The new 16kW maintains full capacity of 16kW even at outdoor temperatures down to -15°C. The 16kW fits perfectly to retrofit houses, as well as to commercial applications to heat and cool the applications and also to provide sanitary hot water.

New Aquarea T-CAP. High capacity improvement at low ambient & high efficiency

Enhance larger capacity (16kW)

More Energy saving with A class water pump.

Adding new functions

Auto mode, Holiday mode, Displays power consumption, New de-ice control, Concrete Dry mode, Lock cooling mode and Pump speed control.

Applications

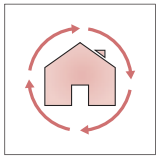

For retrofit houses

Replace easily expensive gas or oil boilers for high efficient 16kW T-CAP or manage bivalent installations (heat pump and existing gas or oil boiler) with the Heat Pump Manager.

Further information on: www.panasonicproclub.com

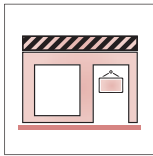

For commercial applications

Wide range of capacities now covered - from 9kW to 45kW with the Heat Pump Manager. Also you are able to connect up to five heat pumps on cascade with the Heat Pump Manager.

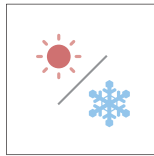

For heating and cooling mode

The 16kW model is able to heat the water at 55°C and can work even when the temperature is as low as -20°C. Cooling operation can be activated on the remote control to cool water up to +5°C.

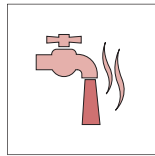

For heating and sanitary hot water

Efficient domestic hot water tanks allow large storage for high consumption of hot water (for example Jacuzzi or bathtub). All our tanks have an anti-legionella protection with a backup heater of 3kW.

Best efficiency compared to other heating efficiency systems

Panasonic heat pumps have a maximum COP of 4.85 at +7°C which makes them much more efficient than fossil fuel fired boilers, gas boilers and electrical heaters.

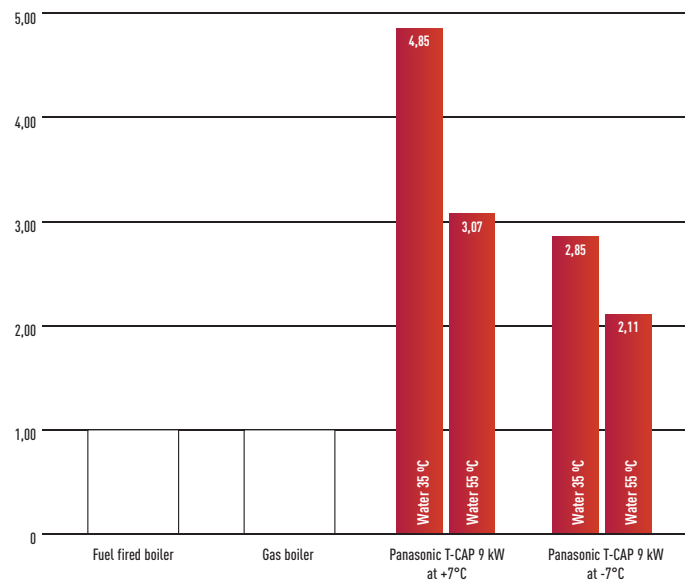

A class water pump. More Energy saving

Aquarea T-CAP maintains the nominal capacity until -15°C

The T-CAP line-up is able to maintain the same nominal capacity even at -15°C without the help of an electrical booster heater. T-CAP is also able to provide extremely high efficiencies, whatever the outside or the water temperature. Panasonic has now extended the range with the new three phase 16kW.

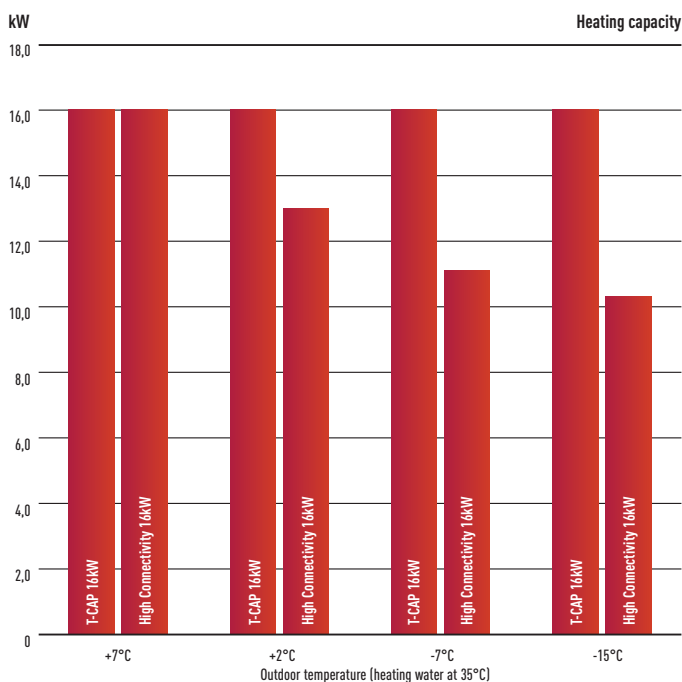

- Backup heater capacity can be selected (3/6/9kW)
- Cooling mode activation possible by software*

* This activation can only be done by service partner or installer

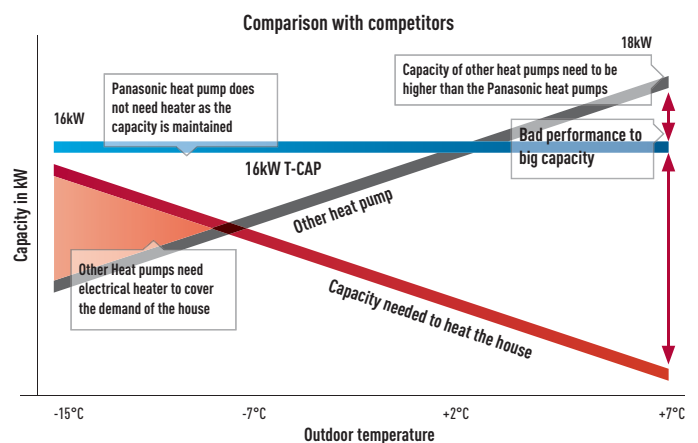
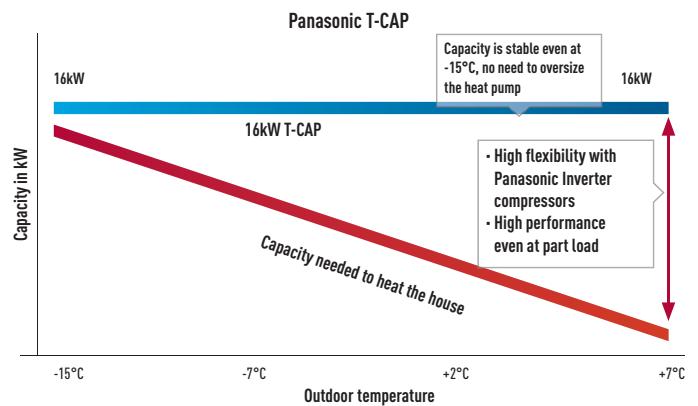



**AQUAREA HT
SOLUTION FOR
RETROFIT 65°C**

Output water
65 °C
HIGH TEMP
HEAT PUMP



New Aquarea HT

Ideal for retrofit: green energy source works with existing radiators

Replace a traditional heating source (such as oil or gas) with Aquarea HT, but keep existing old style radiators for minimum disruption to the home. From 9 to 12kW. For a house with traditional high-temperature radiators (such as cast iron radiators), the Aquarea HT Solution is the most appropriate as the Aquarea HT provides output water temperatures of 65°C even at outdoor temperatures as low as -15°C. Aquarea HT is able to deliver hot water to 65°C with the Heat Pump alone.

Panasonic Aquarea HT is super efficient even at low temperature.

Heating Capacity of a 9 kW HT (WH-SHF09F3E5)

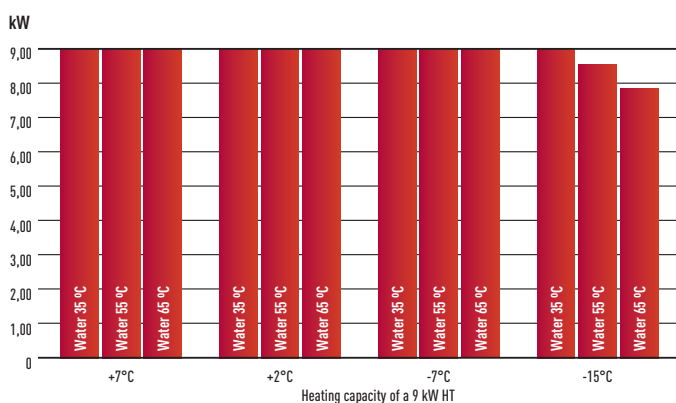

COP Coefficient of Performance

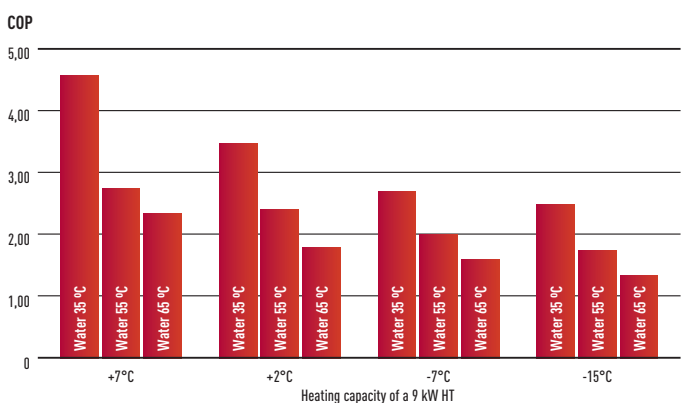



Panasonic Aquarea HT is super efficient even at low temperature

Aquarea HT: High savings and low CO₂

The results of replacing traditional heating systems with Aquarea HT are clear: lowest running cost and lowest CO₂ emissions. Panasonic heat pumps are much more efficient than gas boilers and help you to reach your house energy targets easier.

Yearly savings with Aquarea HT

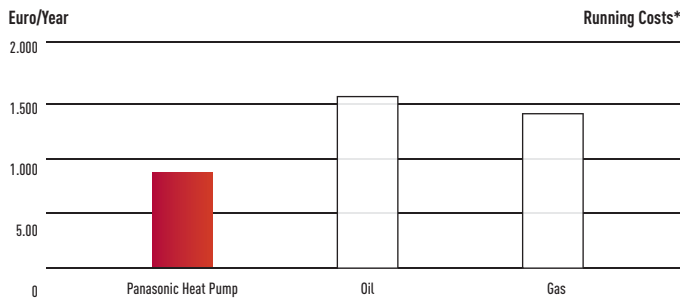

* For a 170 m² house and 40 W/m² energy losses in central Europe Conditions, outside minimum conditions -10°C.

Easy installation

Air source heat pumps are simple to install. They do not require a chimney, gas connection nor oil tank. All that is required is a standard power supply connection. Aquarea heat pumps are also quick to start up.

Smart Bivalent operation

Thanks to Aquarea HPM (Heat Pump Manager), it is possible to combine different heat sources and use the most appropriate source, depending on user's preferences. This smart control will decide which is the best source to use anytime.



Thus, if it is necessary to combine gas heater, oil with heat pump, Aquarea HPM is simply the best solution.

Heat Pump + Boiler Management with DHW with PAW-HPM12ZONELCD-U

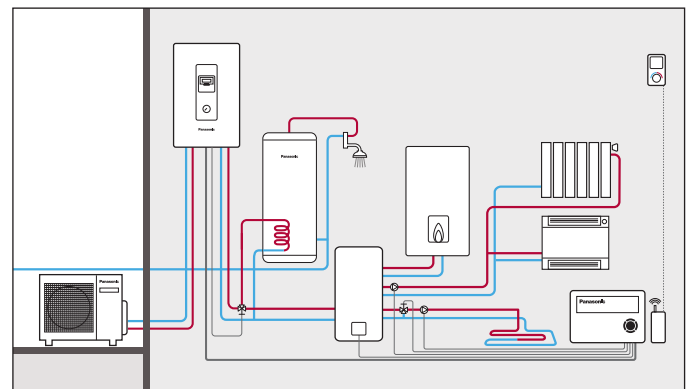

New Aquarea Tank. DHW Tank with buffer Tank

Designed for retrofit applications, the new DHW 200l tank with a 80l buffer tank is particularly suitable for fast integration on an existing installation. Panasonic has developed a New tank with 80l Buffer tank and 200l Sanitary hot water cylinder. This tank includes a 3-way valve and an A Class pump. Easy to install, nice looking, high efficiency for DHW production and for heating. PAW-TD20B8E3-NDS

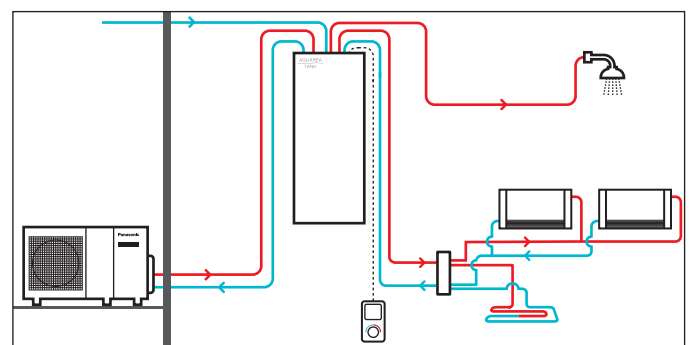



SOLUTION FOR
RETAIL
AND RESTAURANT
80 KW CAPACITY



NEW AQUAREA
16KW BI-BLOC

Aquarea commercial

Solutions for best savings

Efficient Panasonic heat pumps can help to significantly reduce the energy consumption of your business. Recent improvements to air source heat pump technology, including compact single unit systems, can provide an ideal housing and commercial solution. They offer space saving, energy-efficient heating and can be easily adapted for installation in flats, houses and commercial premises. And for businesses producing heat, such as restaurants, installing an Aquarea heat pump system can also use this wasted heat to improve energy efficiency further.

Case study: Carluccio's restaurant



Carluccio's restaurant wanted to install a system which would provide the desired volume of hot water, at the correct temperature while at the same time reduced energy costs.

Following a consultation with Carluccio's, it was decided that their new site in the Meadowhall shopping centre in Sheffield would be the ideal location as it had the correct attributes for the installation of an air to water heat pump system. Previous restaurants in the chain had been fitted with a more traditional 12kW boiler system.

FWP installed a 12kW Aquarea T-CAP mono bloc unit which would allow for the free air from the kitchen roof space to be transferred through condensing unit providing hot water at the optimum temperature. With a high coefficient of performance (COP), for every kW of electricity the system uses, it provides 4kW of energy. This makes the Aquarea far more cost effective than a conventional heating system.

When Carluccio's compared the Sheffield site to one of their existing restaurants of a similar size, the energy savings were considerable. To heat the water for their Leeds restaurant cost £3782 whilst at the Meadowhall site the comparable cost was just £951. These sizable savings mean the site will see a return on investment in about 2 years and has achieved a COP of about 3.91.

Restaurant with Aquarea

If you look for savings on your business, Aquarea is the right choice!

Ideal for heating, cooling and for production of big quantities of hot water at 65 degrees, Aquarea have a extremely quick return on investment and a low CO₂ footprint.

Key points

- Produce hot water efficiency
- Fast return of investment
- Easy control
- Cascade management for higher durability of the system

* 1 HPM can control 3 HP, on this case 2 HPM are needed

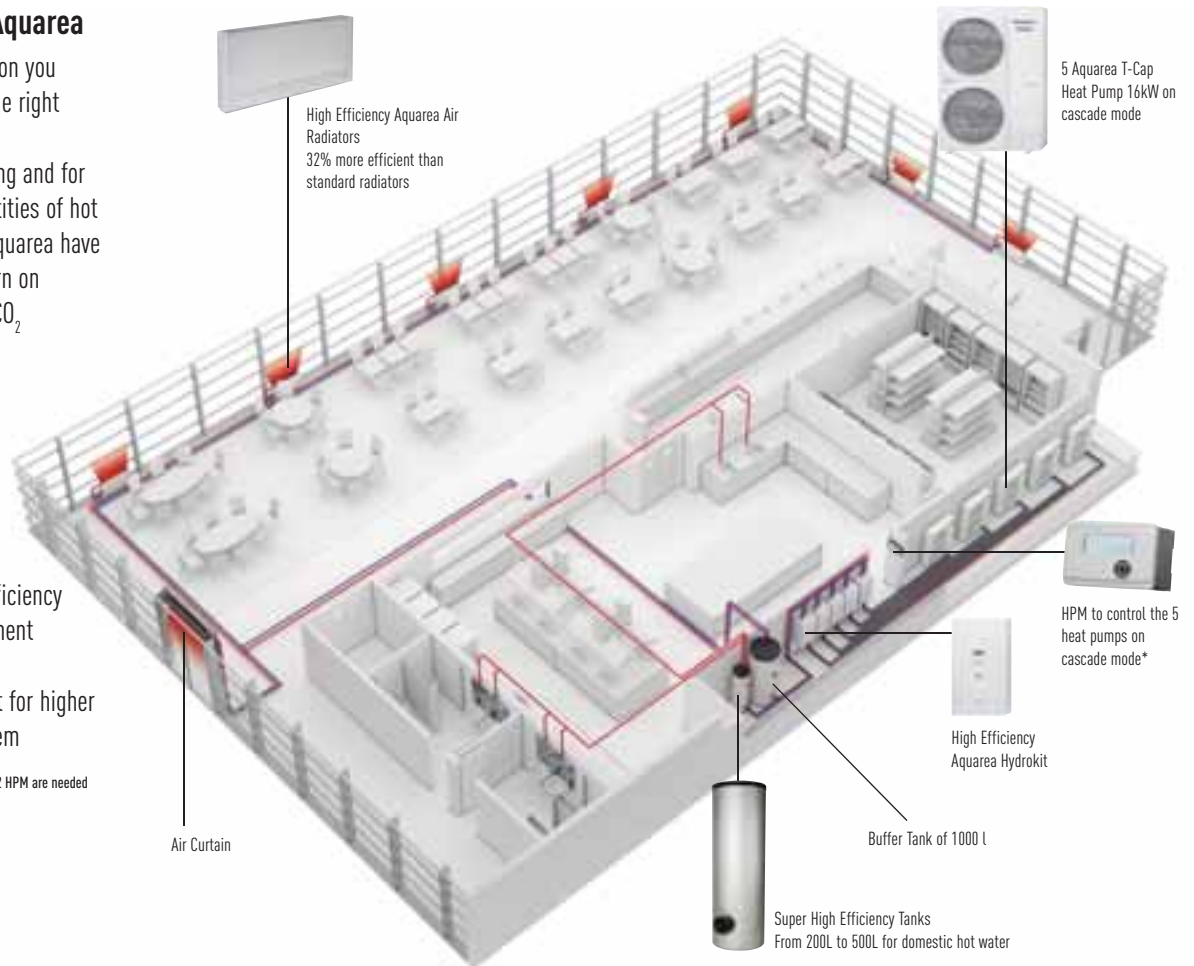

Supermarket with Aquarea

Heat pump technology is scalable, meaning that it can be installed in buildings of varying sizes, offering both small- and large-scale heating solutions. The technology is also environmentally friendly when compared to existing technologies, offering demonstrable energy-use and emissions savings and in most cases; will deliver operational cost savings when compared with fossil fuel alternatives.

By flexible with your water system

Easy connection to existing system

- Fan Coils
- Floor Heating
- 4 way and 2 way convectors
- Domestic hot water tanks
- High efficiency
- Very good part load management
- Cascade management for higher durability of the system

* 1 HPM can control 3 HP, on this case 2 HPM are needed

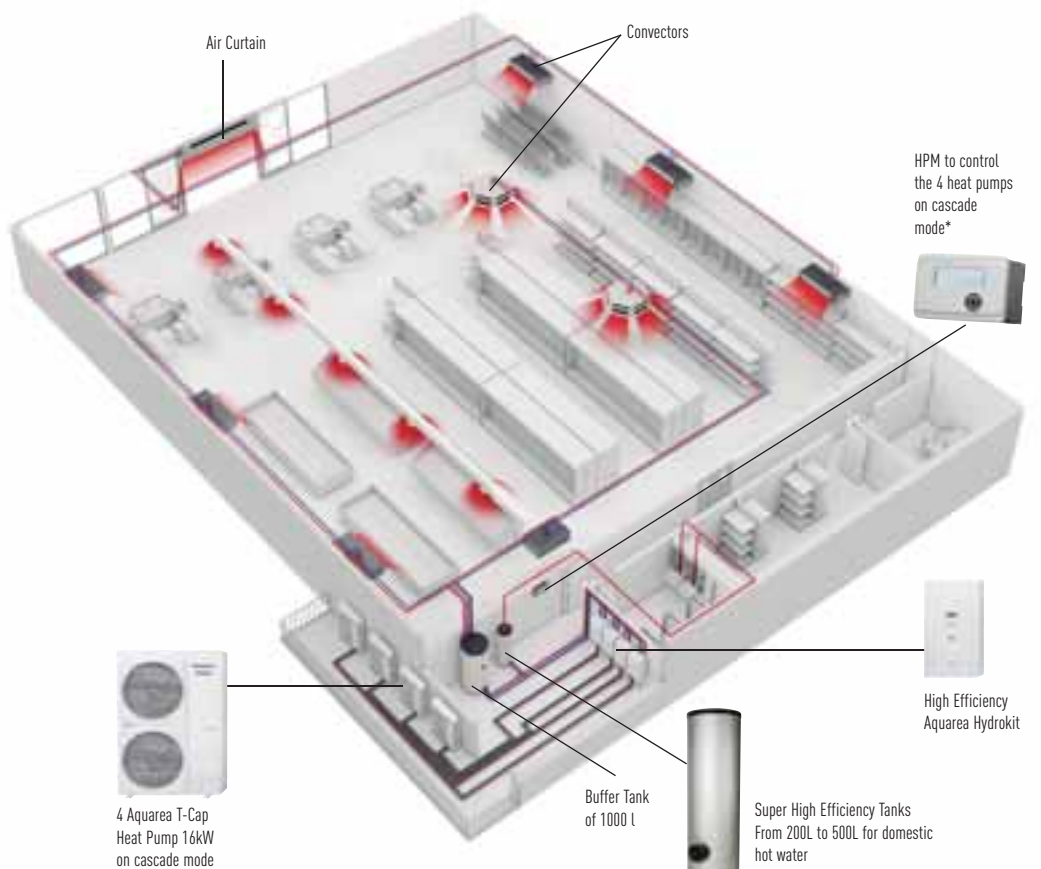



5,00 COP
high efficiency

AQUAREA
HIGH PERFORMANCE

100%
capacity
at -15 °C

AQUAREA T-CAP

**NEW ALL IN ONE
COMPACT AND
EASY TO INSTALL**

New Aquarea All in One

Hydromodule + 200l tank. From 3 to 16 kW.

Aquarea All in One is the new generation of Panasonic Heat Pumps for Heating, Cooling and Domestic Hot Water (DHW). This new range intelligently integrates the best Hydrokit technology with a premium quality stainless steel tank, which also comes with a 10 year warranty. In this way, Panasonic combines the finest product design with performance to achieve a market-leading COP.

This highly efficient solution is quick and easy to install. Thanks to piping being factory-fitted, savings of 50% are possible on installation time. Piping connections are intelligently sited on bottom of the unit further simplifying installation. All in One is also a space saving solution, perfect to install in the kitchen due to its stylish design. Furthermore, Panasonic has developed a range of controllers which allows the control of 2 heating zones, bivalent and cascade systems.

**INCLUDES
200L
STAINLESS
STEEL TANK**

- Highly efficient solution
- Quick and easy installation. Reduce installation costs. Piping on the bottom of the All in One
- A class water pump
- 200l stainless steel tank with 10 year warranty
- Easy integration of the HPM remote control
- Best stainless steel tank with high insulation to reduce energy losses
- High exchange surface to increase efficiency
- Space saving: 1.800H x 598W x 717D
- Best performing Aquarea hydraulic module to heat the water
- Maintenance from the front. Electrical connections on the front
- Built-in filters
- Max water temp output 55°C

Note: Cooling mode activation possible by software. This activation can only be done by service partner.

What makes Aquarea All in One unique?

Wide range

Up to 14 different combinations. From 3kW to 16kW.

- High Performance for new installations and low consumption homes.
- T-CAP for extremely low temperatures ensuring constant heating up to -15°C.



High performance	3kW (Single Phase)	5kW (Single Phase)	7kW (Single Phase)	9kW (Single, Three Phase)	12kW (Single, Three Phase)	16kW (Single, Three Phase)
T-CAP				9kW (Single, Three Phase)	12kW (Single, Three Phase)	16kW (Three Phase)

It's Panasonic

Panasonic is the world leading compressor manufacturer, the heart of any heat pump.

Intelligent Design

We listened to the installation specialists. As a result, piping connections are at the bottom of the unit, making installation easier, and as no piping works are visible, it makes the unit more aesthetically pleasing. Additional advantages are that space is available on top of the unit, and there is no need to keep an access point for maintenance.

New function for installer

- Floor heating concrete dry mode
- Cooling mode unlock facility
- Class A Pump management with 7 speeds

High Efficiency

Heating COP up to 5. DHW COP up to 2,5. A Class water pump.

Connectivity Possibilities

Three remote controls can be installed:

- New Remote control. New function for customer:
 - Auto Mode for Heating and Cooling
 - Shows Energy Consumption
 - Set Holiday Mode
- Heat Pump Manager for more than 600 possible installation configurations (as 2 zone control, Bivalent, etc.)
- Heat Pump Manager with touch screen LCD.



Warranty

- 5 year warranty on compressors
- 10 year warranty on All in One Tanks

Ideal for installation in new homes, Aquarea All in One is also particularly suited for retrofit projects, saving installation time and space.

Space Saving

Hydromodule and tank both in one self-contained enclosure.

Easy and fast installation

No installation work is needed between the indoor unit and the tank. Water filter included.

All in one accessories:

PAW-ADC-PREKIT: Piping connection kit.
PAW-ADC-CV150: Decorative magnetic side cover.
More information in accessories page.

- | | |
|------------------------|--------------------------|
| 1. Control Panel | 6. 03-Way Valve |
| 2. Water Pump | 7. Air Purge Valve |
| 3. Control Board Cover | 8. Pressure Relief Valve |
| 4. Expansion vessel | 9. Flow Switch |
| 5. Water Filter Set | 10. Water Pressure Gauge |

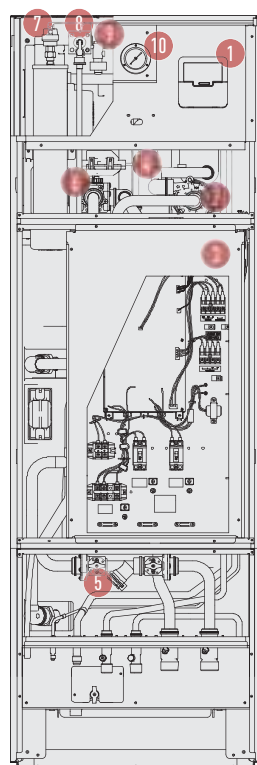

Pre Installation Kit PAW-ADC-PREKIT (optional)

Unique pre installation kit to realize easier & quicker installation.

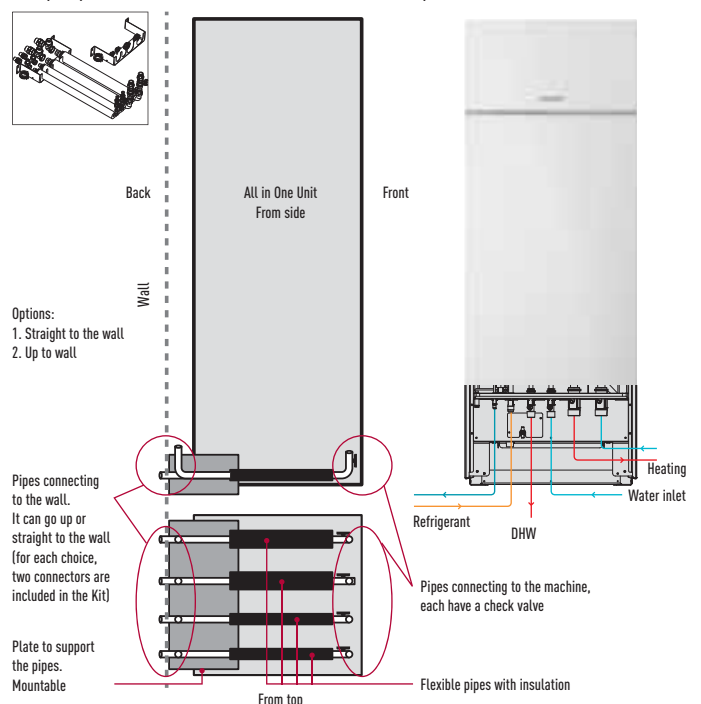

Control & connectivity

Aware of the importance of both control and connectivity in offering the best comfort at the lowest price, Panasonic offers its customers cutting-edge technology, specially designed to ensure our Aquarea heat pump systems deliver maximum performance. You can properly manage the heat pump and perform comprehensive monitoring and control, with all of the features the remote control provides at home, from anywhere in the world thanks to the internet applications Panasonic has created for you.

New remote control

Panasonic has introduced a new remote controller to improve performance, enhance comfort and deliver maximum savings.

New function for installer

- Floor heating concrete dry mode
- How to Lock Cool Mode
- Class A Pump management with 7 speeds

Floor heating concrete dry mode: Allows slow increase in temperature of floor heating via software.

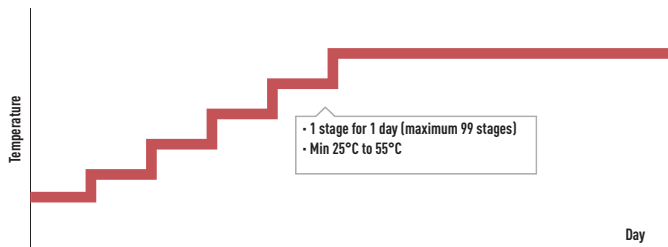

Heating and Cooling Mode: Authorized service partner or Authorized installer can enable the cooling mode through a special operation via the remote controller on site.

Pump with 7 speeds: Pump speed can be selected on the remote control.

New Remocon changing point

Better user interface:

1. Adding Holiday Mode
2. Adding Power Consumption

LCD display:

1. Expand LCD display to show mode on left and right side
2. Adding AUTO mode and remove defrost display (using heat blink)
3. Change not available into EXT SW OFF
4. Adding kWh and Hr

Button:

5. Adding holiday button
6. Change force and error reset position

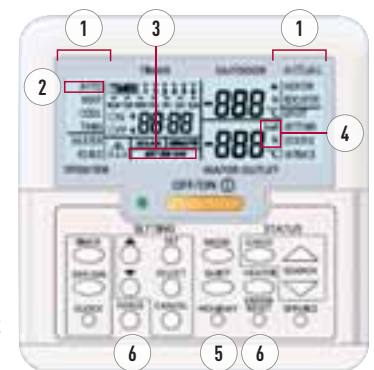

New function for end user

- Auto Mode for Heating and Cooling mode
- Show Energy Consumption
- Set Holiday Mode

Auto Mode: Automatically changes from heating to cooling depending on outdoor temperature.

Energy Consumption: Displays the heat pump's energy consumption, split by heating, cooling and domestic hot water, and shows total consumption figure.

Holiday Mode: Enables the system to resume at the preset temperature after your holiday.

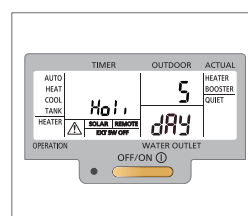
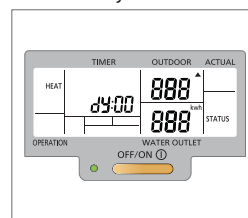



With or without built-in display



External touch display with the Heat Pump Manager

Optional

New Heat Pump Manager

Connected to a router, all information of the heating system controlled by the HPM is available from internet. Installers, service companies and end user can monitor the installation remotely. Panasonic has developed a new easy start up mode for the HPM. Start your bivalent system in just 10 minutes!



Easy Installation & Easy Configuration

Ready: Pre-programmed with up to 610 applications/system diagrams
 Steady: At start up - state the number of application/system diagram
 Go: The controller starts working according to selected diagram

The next generation of Aquarea Manager

This new generation of smart controllers for eco-efficient heating features our versatile stand-alone controller for heating and domestic hot water.



Panasonic offers:

Trends. Statistics. Consumption Energy Management-Optimization. Alarm. Handling + Maintenance. Complete documentation etc.

Key points

- Easy selection with the "ready to go" system
- Up to 610 preconfiguration installations available on www.panasonicproclub.com
- Cascade system possible for big installations.
- Bivalent control in order to also manage gas boilers
- Able to control 2 mixed heated zones
- Smart grid ready
- Solar panel mode in order to produce heat when the PV is generating electricity
- Online access with control of all parameters.
- Easy installation and needs less than 3 minutes to configure a complex system

Technical Specification

- New function: Smart Setup
- Control of 2 x Mixed Heating Circuits
- Floor screed dry program
- Cascade/bivalent controller
- Automatic switch from heating to cooling mode
- Night shift: - Internal Energy Manager
- Solar collector control
- Domestic hot water priority
- Easy to startup – easy to operate
- 7 output relays
- 0-10 V In/Output Signal
- 8 Sensor inputs (PT1000)
- USB interface (upload, service, remote control, trend)
- RS485 interface (com. with additional heat pump)
- RS485 interface (for external display)
- Built-in backlit text display

Easy mounting

Simple mounting without screws in the cabinet/door or on DIN-rail. Also possible to mount directly on to the wall.





Internet Control

Control your heat pump from wherever you are. Control your comfort and efficiency with the lowest energy consumption

What's Internet Control?

Internet Control is a next generation system providing user-friendly remote control of air conditioning or heat pump units from anywhere, using a simple Android or iOS smartphone, tablet or PC via internet with the optional Wired Room temperature sensor, the temperature be display (only with PA-AW-WIFI-1).

Simple Installation

Just connect the Internet Control device to the air conditioner or heat pump with the supplied wire and then link it to your WIFI Access point.

Internet Control. Easy to install. Maximum benefit

Internet Control is underlined with the slogan "Your home in the cloud", meaning a simple and easy to handle solution has been considered for every user to manage the device, not requiring any communication or computer skills.

No servers. No adaptors. No wires. Just a small box needs to be connected and placed close to the air conditioning indoor unit... and your smartphone, tablet or PC.

Your existing WiFi connection does the rest when you are at home. Start the App from your smartphone device, your tablet or your computer, and enjoy a new experience in comfort. And if you are out of home, just launch the App, and manage the air conditioning of your home from the cloud. An intuitive and user-friendly application on the screen of your smartphone or PC that lets you manage the air conditioning unit in the same way you do with the remote controller at home.

Internet Control can be downloaded in Apple's AppStore and Android's PlayStore.

Control your air conditioning with the smart internet control device via smartphones, tablet, PC and smart desktop phone via internet

Offering the same functions as if you were at home or office: start/stop, Mode Operation, Set Temperature, Room Temperature etc as well as the new, advanced functionality provided by Internet Control to achieve the best comfort and efficiency with the lowest energy consumption.

Take control from wherever you are!

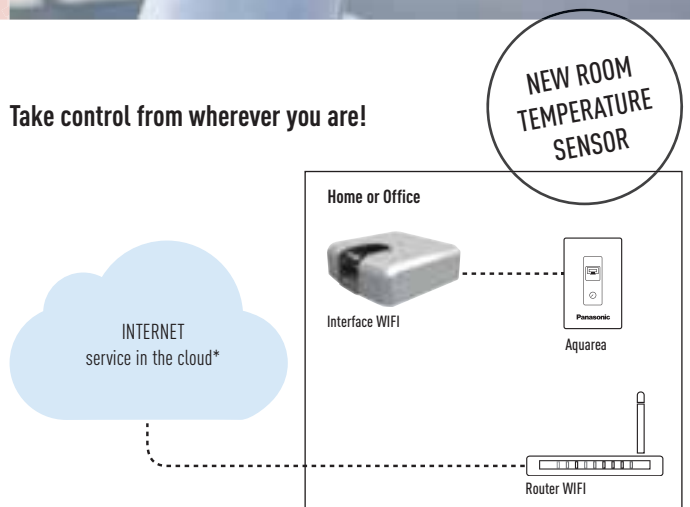

* Functionalities depend on the license. The information indicated above is subject to changes and updates.

PA-AW-WIFI-1 IntesisHome for web control. PA-AW-WIFI-1TE IntesisHome for web control with wired room temperature sensor to display the temperature of the room.



Case Study: Helen, Panasonic customer

"I was sick of heating my house in the mountains on the weekends when I couldn't go. It was a pointless and annoying expense. But now, with Internet Control, I've managed to put the rigidity of weekly programming behind me. If I go then I just put my Panasonic Aquarea heating system on. And if I don't go then I go to the cinema or the theatre with the money I've saved."

Easy control by BMS
CONNECTIVITY



Connectivity. Control by BMS

Great flexibility for integration into your KNX / ZigBee / Modbus projects allows fully bi-directional monitoring and control of all the functioning parameters



Interface to connect Aquarea to KNX

Reference: PAW-AW-KNX-1i

This new Aquarea-KNX interface allows full monitoring and control, bi-directionally, of all the functioning parameters of Aquarea control from KNX installations.

- Small dimensions. / Quick installation and possibility of hidden installation.
- External power not required.
- Direct connection to the unit.
- Fully KNX interoperable. Control and monitoring, from sensors or gateways, of the internal variables of the indoor unit and error codes and indication.
- Aquarea unit can be controlled simultaneously by the remote control of the Aquarea unit and by KNX devices.



KNX Any standard KNX device

Interface to connect Aquarea to Modbus

Reference: PAW-AW-MBS-1

This new Aquarea-Modbus RTU Slave interface allows monitoring and control, fully bi-directionally, all the functioning parameters of Aquarea control from Modbus installations.

- Small dimensions. / Quick installation and possibility of hidden installation.
- External power not required.
- Direct connection to the unit.
- Fully Modbus interoperable. Control and monitoring, from any BMS or PLC Modbus Master, of internal variables of the indoor unit and error codes and indication.
- Aquarea unit can be controlled simultaneously by the remote control of the Aquarea unit and by Modbus Master device.

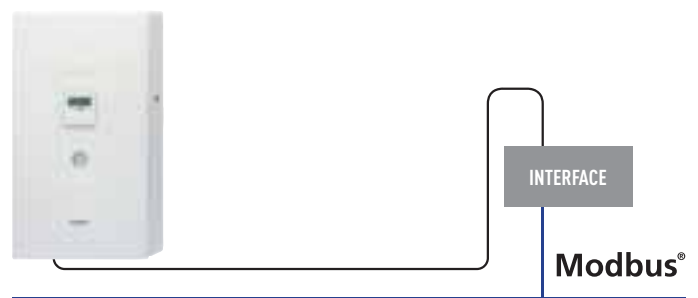

Model name	Interface
PAW-AW-KNX-1i	KNX Interface
PAW-AW-MBS-1	Modbus Interface
PA-AW-WIFI-1	Interface for Intesishome for Aquarea models
PA-AW-WIFI-1TE	Wired room temperature sensor (only for PA-AW-WIFI-1)

INCREASE BY 120%
THE USAGE OF FREE
ELECTRICITY*



+



HPM

PV panels + Heat Pump Manager

Heat and produce Domestic Hot Water for free

Panasonic has developed an innovative algorithm for its HPM (Heat Pump Manager) which drastically improves the Heat Pump's use of self-generated electricity from connected Photovoltaic panels. The Heat Pump will take the electricity generation by the solar system into consideration for the heating system and the domestic hot water production, without reducing comfort in the house.

The HPM (Heat Pump Manager) activates the heat pump based on:

- Energy produced by the photovoltaic system.
- The consumption requirement of the house, eg if a washing machine is working, the heat pump will not draw electricity from the photovoltaic system to avoid net increases on overall energy consumption and hence maximise efficiency.
- Heating demand of the house (in case of high electricity production, the house can be overheated by 1 or 2 degrees, or reduced by 1 or 2 degrees if low production of electricity).

As the production of domestic hot water is linked to the level of electricity generated by the solar system, if this was too low, the heat pump would start a normal process to maintain maximum comfort in the house for a given set time (defined by the user).

Key points

- Increases the amount of self-consumed electricity from the solar system up to 120%.
- Control the heat pump's energy consumption according to the output of electricity from the PV considering the electric energy consumption requirement of the house.
- Innovative algorithm balancing the consumption of the heat pump and the comfort in the house based on the outside temperature and the energy demand of the building.
- Easy configuration of the Heat Pump manager system with the PV system.

*Results of simulations for new housing (see next page)

Comparison on New housing Increase usage of self production by: 120%

The HPM could increase the energy consumption of the heat pump coming from the Photovoltaic from 352 kWh to 775 kWh a year. Results of simulations:

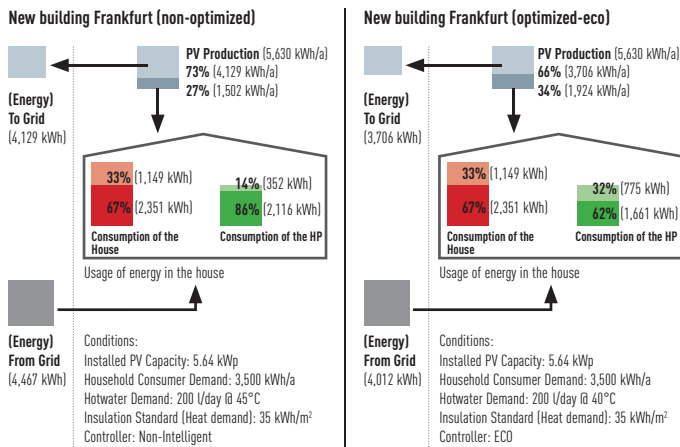

Comparison on Old housing Increase usage of self production by: 71%

The HPM could increase the energy consumption of the heat pump coming from the Photovoltaic from 526 kWh to 898 kWh a year. Results of simulations:

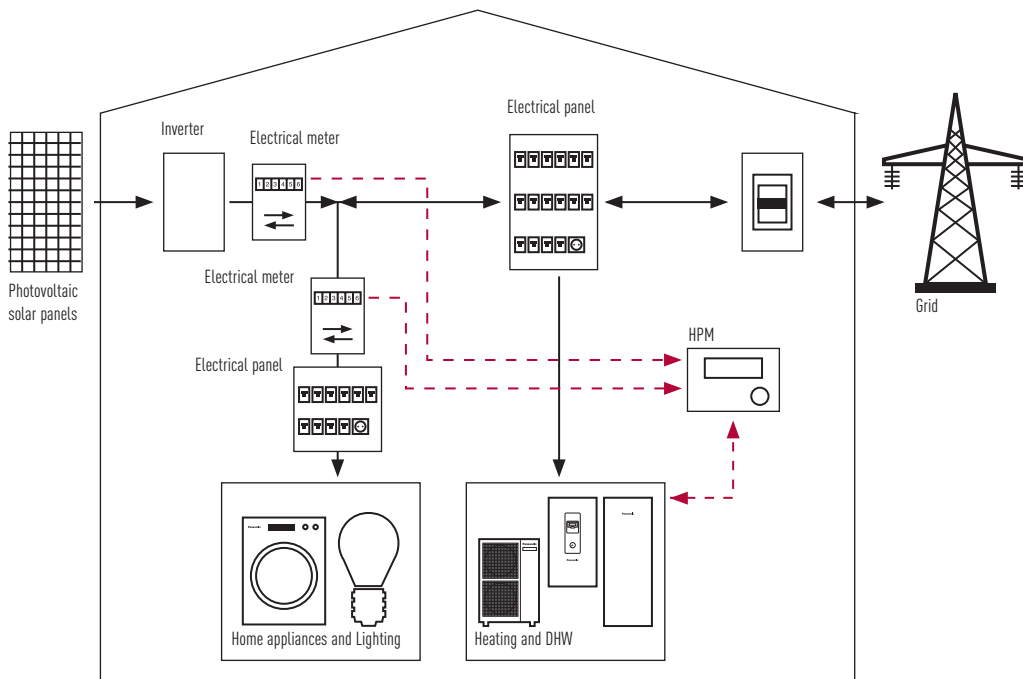
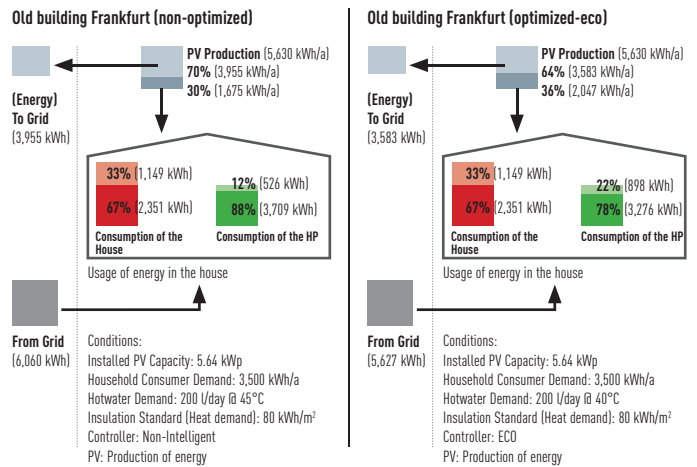

PV + HP control

How to create added value of the combination PV+HP?

- Optimize the HP considering the PV production
- When the PV is producing enough to cover the HP consumption, then Tank mode will be forced to heat up the DHW to 55 or 65 degrees
- If buffer tank on the installation, temperature on the buffer tank will increase 1- to 5 degrees or up to 55°C.

Standard combination PV+HP. Why the Panasonic HPM can increase by 120% the performance of the combination PV+HP

Typical Electricity consumption and production profile WITHOUT Panasonic HPM

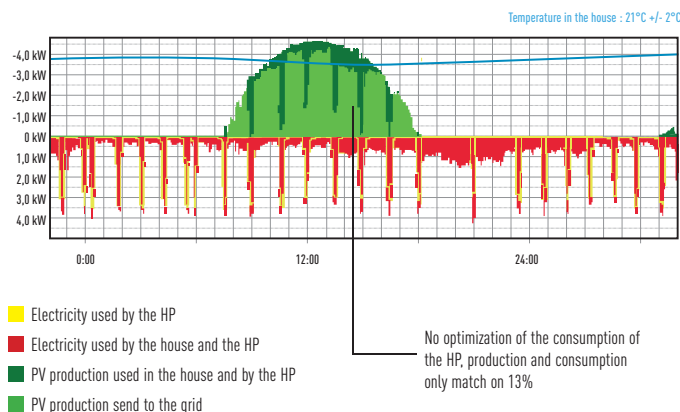

Typical Electricity consumption and production profile optimize by the Panasonic HPM

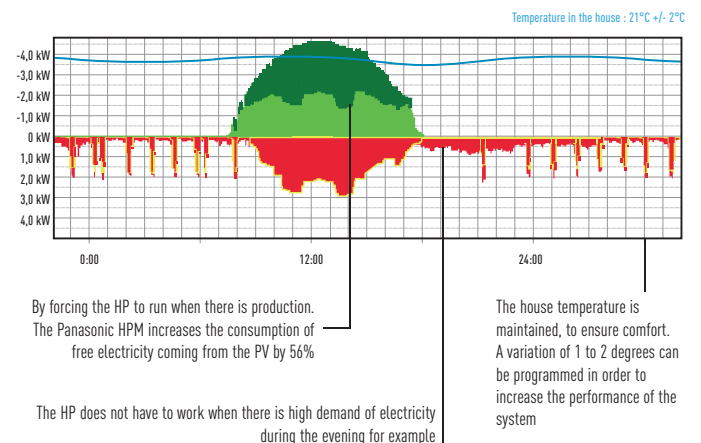



Aquarea Designer

Panasonic provides bespoke software helping system designers, installers and dealers to very quickly design and size systems, create wiring diagrams and issue bills of quantities at the push of a button.

This program allows HVAC designers, installers and distributors to identify the correct heat pump for a particular application from Panasonic's Aquarea range, calculate the savings compared to other heat sources and very quickly calculate CO₂ emissions.

Using Panasonic's Aquarea Designer, projects can be developed simply and easily, by either using the Quick Design or Expert Design options. Each allows the user to build up the project data in a simple step-by-step process and choose to output reports (in either Quick or Large formats) as HTML files or as print-outs. To create these useful reports, project data is input, including:

- Heated area
- Heating requirement
- Heating flow and return temperatures
- Climate data (from a simple drop-down menu) including outdoor temperature
- Type of hot water tank, storage capacity and hot water target temperature.



Aquarea Designer also means saving

Aquarea Designer will calculate the project's energy costs in terms of hot water, heating and pumping. It will show the equipment running times and calculate the COP (coefficient of performance). It then allows the designer to show clients a comparison with other equipment options such as heating by conventional gas-fired boilers, oil systems, wood, standard electric heating and electric night storage heaters. This compares running costs, initial investment costs and maintenance costs. The comparison can also be made for CO₂ emissions and savings.



PRO Club: the professional website of Panasonic

Panasonic announces a new initiative for all professionals involved in the heating and cooling business - the Panasonic PRO Club (www.panasonicproclub.com). This exciting new portal provides distributors, installers, engineers and specifiers with a direct communication channel with one of the industry's major manufacturers. The website contains a wealth of information from the latest versions of Panasonic's Aquarea and Etherea Design Software, to Technical Documentation, Catalogues and Images for the company's wide range of heating and cooling systems - all in an easy to navigate and use website. Also, registered users will be able to access news regarding special promotions and take advantage of these offers, as well as access helpful business advice such as ideas and guidelines for showroom decoration or van livery featuring Panasonic logos and display material.



Panasonic PRO Club is fully compatible with tablet computer and smartphone



PRO Club 

Download on www.panasonicproclub.com
or connect simply with your smartphone to the PRO Club using this QR

Aquarea Heat Pumps Line-Up





Aquarea All in One Bi-Bloc

						
	Figure 1 (F1)	Figure 2 (F2)	Figure 3 (F3)	Figure 4 (F4)	Figure 5 (F5)	Figure 6 (F6)
High performance	3kW (Single Phase)	5kW (Single Phase)	7kW (Single Phase)	9kW (Single, Three Phase)	12kW (Single, Three Phase)	16kW (Single, Three Phase)
T-CAP				9kW (Single, Three Phase)	12kW (Single, Three Phase)	16kW (Three Phase)









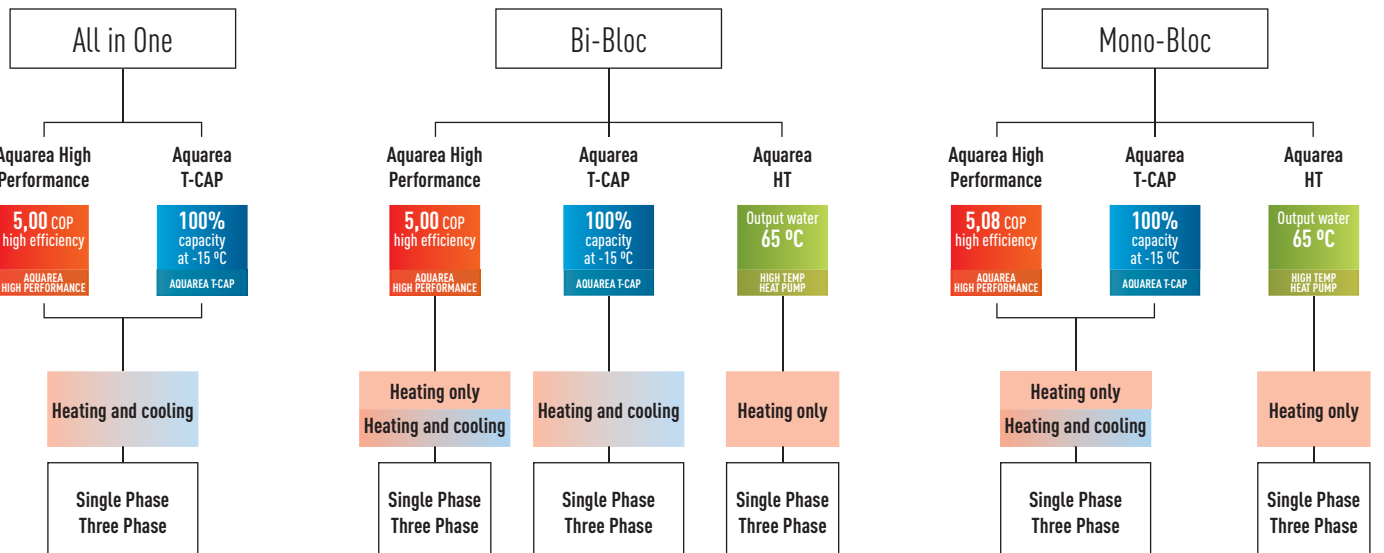













































Aquarea Bi-Bloc

						
	Figure 4 (F4)	Figure 5 (F5)	Figure 6 (F6)	Figure 7 (F7)	Figure 8 (F8)	Figure 9 (F9)
High Performance	3kW (Single Phase)	5kW (Single Phase)	7kW (Single Phase)	9kW (Single, Three Phase)	12kW (Single, Three Phase)	16kW (Single, Three Phase)
T-CAP				9kW (Single, Three Phase)	12kW (Single, Three Phase)	16kW (Three Phase)
Aquarea HT				9kW (Single, Three Phase)	12kW (Single, Three Phase)	

Aquarea Mono-Bloc

					
	Figure 7 (F7)	Figure 8 (F8)	Figure 9 (F9)	Figure 10 (F10)	Figure 11 (F11)
High performance	5kW (Single Phase)	6kW (Single Phase)	9kW (Single Phase)	12kW (Single, Three Phase)	16kW (Single, Three Phase)
T-CAP			9kW (Single, Three Phase)	12kW (Single, Three Phase)	
AQUAREA HT			9kW (Single, Three Phase)	12kW (Single, Three Phase)	



		3kW	5kW	6kW	7kW	9kW	12kW	16kW	
High Performance for well insulated houses	All in One	Single Phase	Heating and cooling WH-ADC0309G3E5 WH-UD03EE5 (F1) 	WH-ADC0309G3E5 WH-UD05EE5 (F1) 		WH-ADC0309G3E5 WH-UD07FE5 (F2) 	WH-ADC0309G3E5 WH-UD09FE5 (F2) 	WH-ADC1216G6E5 WH-UD12FE5 (F3) 	WH-ADC1216G6E5 WH-UD16FE5 (F3) 
		Three Phase					WH-ADC0916G9E8 WH-UD09FE8 (F3) 	WH-ADC0916G9E8 WH-UD12FE8 (F3) 	WH-ADC0916G9E8 WH-UD16FE8 (F3) 
	Bi-Bloc	Single Phase	Heating only WH-SDF03E3E5 WH-UD03EE5 (F4) 	WH-SDF05E3E5 WH-UD05EE5 (F4) 					
		Heating and cooling	WH-SDC03E3E5 WH-UD03EE5 (F4) 	WH-SDC05E3E5 WH-UD05EE5 (F4) 		WH-SDC07F3E5 WH-UD07FE5 (F5) 	WH-SDC09F3E5 WH-UD09FE5 (F5) 	WH-SDC12F6E5 WH-UD12FE5 (F6) 	WH-SDC16F6E5 WH-UD16FE5 (F6) 
	Mono-Bloc	Three Phase	Heating and cooling				WH-SDC09F3E8 WH-UD09FE8 (F6) 	WH-SDC12F9E8 WH-UD12FE8 (F6) 	WH-SDC16F9E8 WH-UD16FE8 (F6) 
		Single Phase	Heating only		WH-MDF06E3E5 (F7) 		WH-MDF09E3E5 (F7) 	WH-MDF12C6E5 (F8) 	WH-MDF16C6E5 (F8) 
Heating and cooling				WH-MDC05F3E5 (F7) 	WH-MDC06E3E5 (F7) 		WH-MDC09E3E5 WH-MDC09G3E5 (F7) 	WH-MDC12C6E5* WH-MDC12G6E5 (F8) 	WH-MDC16C6E5* WH-MDC16G6E5 (F8) 
Three Phase		Heating only				WH-MDF09C3E8 (F8) 	WH-MDF12C9E8 (F8) 	WH-MDF16C9E8 (F8) 	
T-CAP High Capacity for cold areas	All in One	Single Phase	Heating and cooling			WH-ADC1216G6E5 WH-UX09FE5 (F3) 	WH-ADC1216G6E5 WH-UX12FE5 (F3) 		
		Three Phase	Heating and cooling			WH-ADC0916G9E8 WH-UX09FE8 (F3) 	WH-ADC0916G9E8 WH-UX12FE8 (F3) 	WH-ADC0916G9E8 WH-UX16FE8 (F3) 	
	Bi-Bloc	Single Phase	Heating and cooling				WH-SXC09F3E5 WH-UX09FE5 (F6) 	WH-SXC12F6E5 WH-UX12FE5 (F6) 	
		Three Phase	Heating and cooling				WH-SXC09F3E8 WH-SXC09F9E8 WH-UX09FE8 (F6) 	WH-SXC12F9E8 WH-UX12FE8 (F6) 	WH-SXC16F9E8 WH-UX16FE8 (F6) 
	Mono-Bloc	Single Phase	Heating only				WH-MXF09D3E5 (F8) 	WH-MXF12D6E5 (F8) 	
		Three Phase	Heating and cooling				WH-MXC09D3E5* WH-MXC09G3E5 (F8) 	WH-MXC12D6E5* WH-MXC12G6E5 (F8) 	
HT for retrofit	Bi-Bloc	Single Phase	Heating only			WH-SHF09F3E5 WH-UH09FE5 (F6) 	WH-SHF12F6E5 WH-UH12FE5 (F6) 		
		Three Phase	Heating only			WH-SHF09F3E8 WH-UH09FE8 (F6) 	WH-SHF12F9E8 WH-UH12FE8 (F6) 		
	Mono-Bloc	Single Phase	Heating only			WH-MHF09D3E5* WH-MHF09G3E5 (F8) 	WH-MHF12D6E5* WH-MHF12G6E5 (F8) 		
		Three Phase	Heating only			WH-MHF09D3E8* WH-MHF09G3E8 (F8) 	WH-MHF12D9E8* WH-MHF12G9E8 (F8) 		

* No A class water pump.

AQUAREA ALL IN ONE HIGH PERFORMANCE BI-BLOC SINGLE PHASE HEATING AND COOLING



NEW

**AQUAREA
NEW REMOTE
CONTROL**

Panasonic has developed a highly efficient solution, easy to install.

Technical focus

- Space saving: 1.800 x 598 x 717 (H x W x D)
- Reduce installation costs
- Piping on the bottom of the All in One (easy to install)
- Reduce timing and minimize installation errors
- Easy remote control to set up
- Electrical connections on the front
- Reduce installation spaces
- All piping connections at bottom of the indoor unit
- Easier installation and maintenance
- New remote control functions

* Cooling mode activation possible by software. This activation can only be done by service partner.

Kit	Single Phase (Power to indoor)						Three Phase (Power to indoor)			
	KIT-ADC3GE5	KIT-ADC5GE5	KIT-ADC7GE5	KIT-ADC9GE5	KIT-ADC12GE5	KIT-ADC16GE5	KIT-ADC9GE8	KIT-ADC12GE8	KIT-ADC16GE8	
Indoor unit	WH-UDC0309G3E5						WH-ADC0916G9E8			
Outdoor unit	WH-UD03EE5		WH-UD05EE5		WH-UD07FE5		WH-UD12FE5		WH-UD16FE5	
Heating capacity at +7 °C (heating water at 35 °C)	kW		3,20		5,00		7,00		9,00	
COP at +7 °C (heating water at 35 °C)	W/W		5,00		4,63		4,46		4,13	
Heating capacity at +2 °C (heating water at 35 °C)	kW		3,20		4,20		6,55		6,70	
COP at +2 °C (heating water at 35 °C)	W/W		3,56		3,11		3,34		3,13	
Heating capacity at -7 °C (heating water at 35 °C)*	kW		3,20		4,20		5,15		5,90	
COP at -7 °C (heating water at 35 °C)	W/W		2,69		2,59		2,68		2,52	
Cooling capacity at 35 °C (cooling water at 7/12 °C)	kW		3,20		4,50		7,00		10,00	
EER at 35 °C (cooling water at 7/12 °C)	W/W		3,08		2,69		2,63		2,43	
Indoor unit										
Sound pressure level	Cooling / Heating	dB(A)	28 / 28		28 / 28		28 / 28		33 / 33	
Dimensions / Net Weight	H x W x D	mm / kg	1.800 x 598 x 717 / 135				1.800 x 598 x 717 / -		1.800 x 598 x 717 / 139	
Hydrokit in the indoor unit										
Water pipe connector		mm	R1 1/4		R1 1/4		R1 1/4		R1 1/4	
A class Pump	Number of speeds		7		7		7		7	
	Input power (Min / Max)	W	30 / 120		30 / 120		30 / 120		30 / 120	
Heating water flow [ΔT=5 K, 35 °C]		l/min	9,2		14,3		20,1		25,8	
Capacity of integrated electric heater		kW	3		3		6		9	
Input Power	Heating / Cooling	kW	0,64 / 1,04		1,08 / 1,67		1,59 / 2,30		2,20 / 2,90	
Running current	Heating / Cooling	A	3,00 / 4,8		5,00 / 7,6		7,30 / 10,40		10,10 / 13,10	
Current 1 / Current 2		A			21,0 / 26,0		22,9 / 26,0		24,0 / 26,0	
Recommended Fuse		A	15 / 15		15 / 15		30 / 15		30 / 30	
Recommended power cable section		mm ²	4,0 / 2,5		4,0 / 2,5		4,0 / 4,0		4,0 / 4,0	
Tank in the indoor unit										
Water volume		L	200		200		200		200	
Maximum water temperature		°C	65		65		65		65	
Material inside tank			Stainless steel		Stainless steel		Stainless steel		Stainless steel	
Exchange surface		m ²	2,1		2,1		2,1		2,1	
Warranty of the stainless steel tank			10 years		10 years		10 years		10 years	
Maintenance required on the tank			No		No		No		No	
Outdoor unit										
Sound pressure level	Cooling / Heating	dB(A)	47 / 47		48 / 48		48 / 48		50 / 49	
Sound power level	Cooling / Heating	dB	65		66		67		67	
Dimensions / Weight	H x W x D	mm / kg	622 x 824 x 298 / 39				795 x 900 x 320 / 66		1.340 x 900 x 320 / 101	
Refrigerant (R410A)		kg	1,20		1,20		1,45		1,45	
Pipe diameter	Liquid / Gas	mm (Inch)	6,35 (1/4) / 12,7 (1/2)				6,35 (1/4) / 15,88 (5/8)			
Refrigerant / Additional gas amount (R410A)		kg / g/m	1,20 / 20		1,20 / 20		1,45 / 30		1,45 / 30	
Pipe length range		m	3 / 15		3 / 15		3 / 30		3 / 30	
Pipe length for nominal capacity / additional gas		m	7 / 10		7 / 10		7 / 10		7 / 10	
Elevation difference (in/out)		m	5		5		20		20	
Operation range	Outdoor ambient	°C	-20 / +35		-20 / +35		-20 / +35		-20 / +35	
Water outlet	Cooling / Heating	°C	5 - 20 / 25 - 55		5 - 20 / 25 - 55		5 - 20 / 25 - 55		5 - 20 / 25 - 55	

COP classification is at 230 V only in accordance with EU directive 2003/32/EC. Sound pressure measured at 1 m from the outdoor unit and at 1,5 m height. Performance in agreement with EN14511. 1) Insulated tested under EN12897. * Tentative data.

ErP ready
2015

Internet Control Ready
INTERNET CONTROL

A class water pump
HIGH EFFICIENCY

5,00 COP high efficiency
AQUAREA HIGH PERFORMANCE

High efficiency heating
INVERTER+

Environmentally friendly refrigerant
R410A

Down to -20 °C in heating mode
OUTDOOR TEMPERATURE

Boiler connection
RETROFIT

Domestic hot water
DHW

Easy control by BMS
CONNECTIVITY

5 year compressor warranty

10 year warranty in the vessel tank

INTERNET CONTROL READY: Optional.

AQUAREA ALL IN ONE T-CAP BI-BLOC SINGLE PHASE / THREE PHASE HEATING AND COOLING

NEW



NEW AQUAREA AIR RADIATORS
32% MORE EFFICIENT THAN STANDARD RADIATORS
Optional

All the benefits of the T-CAP All in ONE unit!
Panasonic has developed a highly efficient solution, easy to install.

- Technical focus**
- Space saving: 1.800 x 598 x 717 (H x W x D)
 - Reduce installation costs
 - Piping on the bottom of the All in One (easy to install)
 - Reduce timing and minimize installation errors
 - Easy remote control to set up
 - Electrical connections on the front
 - Reduce installation spaces
 - All piping connections at bottom of the indoor unit
 - Easier installation and maintenance
 - 1 phase and 3 phase
 - New remote control functions

Kit	Single Phase (Power to indoor)		Three Phase (Power to indoor)			
	KIT-AXC9GE5	KIT-AXC12GE5	KIT-AXC9GE8	KIT-AXC12GE8	KIT-AXC16GE8	
Indoor unit	WH-ADC1216G6E5	WH-ADC1216G6E5	WH-ADC0916G9E8	WH-ADC0916G9E8	WH-ADC0916G9E8	
Outdoor unit	WH-UX09FE5	WH-UX12FE5	WH-UX09FE8	WH-UX12FE8	WH-UX16FE8	
Heating capacity at +7 °C (heating water at 35 °C)	kW	9,00	12,00	9,00	12,00	
COP at +7 °C (heating water at 35 °C)	W/W	4,84	4,74	4,84	4,74	
Heating capacity at +2 °C (heating water at 35 °C)	kW	9,00	12,00	9,00	12,00	
COP at +2 °C (heating water at 35 °C)	W/W	3,59	3,44	3,59	3,44	
Heating capacity at -7 °C (heating water at 35 °C)*	kW	9,00	12,00	9,00	12,00	
COP at -7 °C (heating water at 35 °C)	W/W	2,85	2,72	2,85	2,72	
Cooling capacity at 35 °C (cooling water at 7/12 °C)	kW	7,00	10,00	7,00	10,00	
EER at 35 °C (cooling water at 7/12 °C)	W/W	3,17	2,81	3,17	2,81	
Indoor unit						
Sound pressure level	Cooling / Heating	dB(A)	—	33 / 33	33 / 33	
Dimensions / Net Weight	H x W x D	mm / kg	1.800 x 598 x 717 / —	1.800 x 598 x 717 / 139	1.800 x 598 x 717 / 139	
Hydrokit in the indoor unit						
Water pipe connector		R 1 1/4	R 1 1/4	R 1 1/4	R 1 1/4	
A class Pump	Number of speeds	7	7	7	7	
	Input power (Min / Max)	W	36 / 152	36 / 152	36 / 152	36 / 152
Heating water flow (ΔT=5 K, 35 °C)	l/min	25,8	34,4	25,8	34,4	
Capacity of integrated electric heater	kW	6	6	9	9	
Input Power	Heating / Cooling	kW	1,90	2,57	1,90	2,57
	Heating / Cooling	A	8,8 (10,4)	11,9 (16,7)	2,9 (3,4)	3,9 (5,4)
Current 1 / Current 2	Heating / Cooling	A	25,0 / 26,0	29,0 / 26,0	14,7 / 13,0	11,9 / 13,0
	Heating / Cooling	A	30 / 30	30 / 30	16 / 16	16 / 16
Recommended Fuse	A	30 / 30	30 / 30	16 / 16	16 / 16	
Recommended power cable section	mm ²	4,0 / 4,0	4,0 / 4,0	2,5 / 2,5	2,5 / 2,5	
Tank in the indoor unit						
Water volume	L	200	200	200	200	
Maximum water temperature	°C	65	65	65	65	
Material inside tank		Stainless steel	Stainless steel	Stainless steel	Stainless steel	
Exchange surface	m ²	2,1	2,1	1,8	1,8	
Warranty of the Stainless steel tank		10 years	10 years	10 years	10 years	
Maintenance required on the tank		No	No	No	No	
Outdoor unit						
Sound pressure level	Cooling / Heating	dB(A)	49 / 49	50 / 50	49 / 49	
Sound power level	Cooling / Heating	dB	66	67	67 / 66	
Dimensions / Weight	H x W x D	mm / kg	1.340 x 900 x 320 / 101	1.340 x 900 x 320 / 101	1.340 x 900 x 320 / 109	
Refrigerant (R410A)	kg	1,45	2,55	2,85	2,85	
Pipe diameter	Liquid / Gas	mm (Inch)	9,52 (3/8) / 15,88 (5/8)	9,52 (3/8) / 15,88 (5/8)	9,52 (3/8) / 15,88 (5/8)	
Refrigerant / Additional gas amount (R410A)	kg / g/m	3,10 / 50	3,10 / 50	2,85 / 50	2,85 / 50	
Pipe length range	m	3 / 30	3 / 30	3 / 30	3 / 30	
Pipe length for nominal capacity / additional gas	m	7 / 10	7 / 10	7 / 10	7 / 10	
Elevation difference (in/out)	m	20	20	20	20	
Operation range	Outdoor ambient	°C	-20 / +35	-20 / +35	-20 / +35	
	Outdoor ambient	°C	-20 / +35	-20 / +35	-20 / +35	
Water outlet	Outdoor ambient	°C	5 - 20 / 25 - 55	5 - 20 / 25 - 55	5 - 20 / 25 - 55	
	Cooling / Heating	°C	5 - 20 / 25 - 55	5 - 20 / 25 - 55	5 - 20 / 25 - 55	

COP classification is at 230 V only in accordance with EU directive 2003/32/EC. Sound pressure measured at 1 m from the outdoor unit and at 1,5 m height. Performance in agreement with EN14511. 1) Insulated tested under EN12897.
* Tentative data.

ErP ready
2015

Internet Control Ready
INTERNET CONTROL

A class water pump
HIGH EFFICIENCY

4,85 COP high efficiency
AQUAREA HIGH PERFORMANCE

High efficiency heating
INVERTER+

Environmentally friendly refrigerant
R410A

Down to -20 °C in heating mode
OUTDOOR TEMPERATURE

Boiler connection
RETROFIT

Domestic hot water
DHW

Easy control by BMS
CONNECTIVITY

5 year compressor warranty

10 year warranty in the vessel tank

AQUAREA HIGH PERFORMANCE BI-BLOC SINGLE PHASE HEATING ONLY - SDF HEATING AND COOLING - SDC 3 AND 5KW

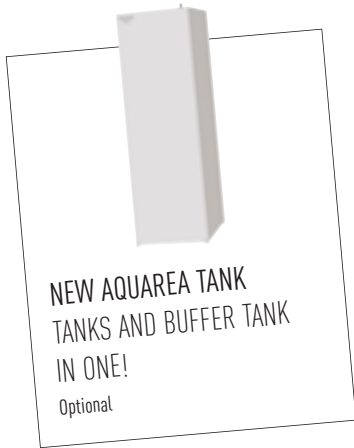

The 3 and 5kW is specially designed for low energy homes and achieves an impressive COP of 5 (on the 3,2kW).

Thanks to the system's high degree of technology and advanced control, it is able to maintain a high capacity and efficiency even at -7°C and -15°C. The Aquarea's software is optimised to the requirements of low consumption homes in order to maximise energy efficiency. Whatever the weather, Aquarea can work even at -20°C. The compact design of the outdoor unit makes installation very easy.

Technical focus

- Efficient control of room temperature based on the outdoor temperature, indoor temperature using the Aquarea Manager.
- Super efficient: COP of 5 in the 3,2kW!
- A Class Pump
- Special software for low consumption homes with minimum output temperature: 20°C
- Works down to -20°C
- Automatic Air purge valve
- Display of the compressor frequency

			Single Phase Heating Only		Single Phase Heating and Cooling	
Kit			KIT-WF03C3E5	KIT-WF05C3E5	KIT-WC03C3E5	KIT-WC05C3E5
Indoor unit			WH-SDF03E3E5	WH-SDF05E3E5	WH-SDC03E3E5	WH-SDC05E3E5
Outdoor unit			WH-UD03EE5	WH-UD05EE5	WH-UD03EE5	WH-UD05EE5
Heating capacity at +7°C	kW		3,20	5,00	3,20	5,00
COP at +7°C (heating water at 35°C)			5,00	4,63	5,00	4,63
Heating capacity at +2°C (heating water at 35°C)	kW		3,20	4,20	3,20	4,20
COP at +2°C (heating water at 35°C)			3,56	3,11	3,56	3,11
Heating capacity at -7°C	kW		3,20	4,20	3,20	4,20
COP at -7°C			2,69	2,59	2,69	2,59
Cooling capacity at 35°C	kW		—	—	3,20	4,50
EER at 35°C (cooling water at 7/12°C)			—	—	3,08	2,69
Indoor unit						
Sound pressure level	Heating / Cooling	dB(A)	30 / —	30 / —	30 / 30	30 / 30
Dimensions	H x W x D	mm	892 x 502 x 353	892 x 502 x 353	892 x 502 x 353	892 x 502 x 353
Weight		kg	43	43	44	44
Water pipe connector		mm	28	28	28	28
A class Pump	Number of speeds		Variable Speed	Variable Speed	Variable Speed	Variable Speed
	Input power (Min / Max)	W	30 / 100	33 / 106	30 / 100	33 / 106
Heating water flow [ΔT=5 K, 35°C]		l/min	9,2	14,3	9,2	14,3
Capacity of integrated electric heater		kW	3	3	3	3
Input Power	Heating / Cooling	kW	0,64 / 1,04	1,08 / 1,67	0,64 / 1,04	1,08 / 1,67
Running current		A	3,0	5,0	3,0	5,0
Starting current		A	4,8	7,6	4,8	7,6
Current 1 / Current 2		A	11,0 / 26,0	12,0 / 26,0	11,0 / 26,0	12,0 / 26,0
Recommended Fuse		A	15 / 30	15 / 30	15 / 30	15 / 30
Recommended power cable section		mm ²	2,5 / 4,0	2,5 / 4,0	2,5 / 4,0	2,5 / 4,0
Outdoor unit						
Sound pressure level	Heating / Cooling	dB(A)	47 / —	48 / —	47 / 47	48 / 48
Sound power level		dB	65	66	65	66
Dimensions	H x W x D	mm	622 x 824 x 298	622 x 824 x 298	622 x 824 x 298	622 x 824 x 298
Weight		kg	39	39	39	39
Pipe diameter	Liquid	mm (Inch)	6,35 (1/4)	6,35 (1/4)	6,35 (1/4)	6,35 (1/4)
	Gas	mm (Inch)	12,7 (1/2)	12,7 (1/2)	12,7 (1/2)	12,7 (1/2)
Refrigerant (R410A)		kg	1,20	1,20	1,20	1,20
Pipe length range		m	3-15	3-15	3-15	3-15
Pipe length for nominal capacity		m	7	7	7	7
Pipe length for additional gas		m	10	10	10	10
Additional gas amount (R410A)		g/m	20	20	20	20
Elevation difference (in/out)		m	5	5	5	5
Operation range	Outdoor ambient	°C	-20 / +35	-20 / +35	-20 / +35	-20 / +35
Water outlet	Heating	°C	25 - 55 /	25 - 55	25 - 55	25 - 55
	Cooling	°C	—	—	5 - 20	5 - 20

COP classification is at 230 V only in accordance with EU directive 2003/32/EC. Sound pressure measured at 1 m from the outdoor unit and at 1,5 m height. Performance in agreement with EN14511.

ErP ready 2015	Internet Control Ready INTERNET CONTROL	A class water pump HIGH EFFICIENCY	5,00 COP high efficiency AQUAREA HIGH PERFORMANCE	High efficiency heating INVERTER+	Environmentally friendly refrigerant R410A	Down to -20 °C in heating mode OUTDOOR TEMPERATURE	Boiler connection RETROFIT	Solar panels connection SOLAR KIT	Domestic hot water DHW	Easy control by BMS CONNECTIVITY	5 year compressor warranty
--------------------------	---	--	---	---	--	--	--------------------------------------	---	----------------------------------	--	-----------------------------------

INTERNET CONTROL READY: Optional.

AQUAREA HIGH PERFORMANCE BI-BLOC SINGLE PHASE / THREE PHASE HEATING AND COOLING - SDC

SG Ready
Smart Grid Ready

**PV PANELS + HEAT PUMP
MANAGER INCREASE BY
120% THE USAGE OF FREE
ELECTRICITY**
Optional



The Aquarea SDC range adapts well in an existing install with a boiler backup, and in a new application with underfloor heating, low temperature radiators or even fan-coil heaters.

This range can also be connected to a solar kit in order to increase efficiency and minimize the impact on the ecosystem. Finally, it is possible to connect a thermostat for better heating and cooling control and management.

Technical focus

- New remote control functions
- Efficient control of room temperature based on the outdoor temperature, indoor temperature using the Aquarea Manager.
- Optional Smartphone control
- Range from 7 to 16kW, Single and Three Phase
- Maximum hydraulic module output temperature: 55°C
- Works down to -20°C
- Maximum 30 m rise between the outdoor unit and the hydraulic module
- Cooling temperature range 5-20°C

Kit	Single Phase (Power to indoor)				Three Phase (Power to indoor)		
	KIT-WC07F3E5	KIT-WC09F3E5	KIT-WC12F6E5	KIT-WC16F6E5	KIT-WC09F3E8	KIT-WC12F9E8	KIT-WC16F9E8
Indoor unit	WH-SDC07F3E5	WH-SDC09F3E5	WH-SDC12F6E5	WH-SDC16F6E5	WH-SDC09F3E8	WH-SDC12F9E8	WH-SDC16F9E8
Outdoor unit	WH-UD07FE5	WH-UD09FE5	WH-UD12FE5	WH-UD16FE5	WH-UD09FE8	WH-UD12FE8	WH-UD16FE8
Heating capacity at +7°C	kW	7,00	9,00	12,0	16,00	12,00	16,00
COP at +7°C (heating water at 35°C)		4,46	4,13	4,74	4,28	4,84	4,28
Heating capacity at +2°C	kW	6,55	6,70	11,40	13,00	9,00	11,40
COP at +2°C (heating water at 35°C)		3,34	3,13	3,44	3,28	3,59	3,44
Heating capacity at -7°C	kW	5,15	5,90	10,00	11,40	9,00	10,00
COP at -7°C (heating water at 35°C)		2,68	2,52	2,73	2,57	2,85	2,23
Cooling capacity at 35°C (cooling water at 7°C)	kW	6,00	7,00	10,00	12,20	7,00	10,00
EER at 35°C (cooling water at 7°C)		2,63	2,43	2,81	2,56	3,17	2,85
Indoor unit							
Sound pressure level	Heating / Cooling	dB(A)	33 / 33	33 / 33	33 / 33	33 / 33	33 / 33
Dimensions	H x W x D	mm	892 x 502 x 353	892 x 502 x 353	892 x 502 x 353	892 x 502 x 353	892 x 502 x 353
Weight		kg	43	43	45	46	46
Water pipe connector			R1 1/4	R1 1/4	R1 1/4	R1 1/4	R1 1/4
Pump	Number of speeds		7	7	7	7	7
	Input power (Min / Max)	W	34 / 114	40 / 120	34 / 110	30 / 105	32 / 102
Heating water flow (ΔT=5 K, 35°C)		l/min	20,1	25,8	34,4	45,9	25,8
Capacity of integrated electric heater		kW	3	3	6	6	3
Input Power	Heating / Cooling	kW	1,59 / 2,30	2,20 / 2,90	2,53 / 3,56	3,74 / 4,76	1,86 / 2,21
Running current		A	7,30	10,10	11,50	16,90	2,90
Starting current		A	10,40	13,10	16,00	21,30	3,40
Current 1 / Current 2		A	21,0 / 26,0	22,9 / 26,0	24,0 / 26,0	26,0 / 26,0	11,8 / 13,0
Recommended Fuse		A	30 / 30	30 / 30	30 / 30	30 / 30	16 / 16
Recommended power cable section		mm²	4,0 / 4,0	4,0 / 4,0	4,0 / 4,0	4,0 / 4,0	2,5 / 2,5
Outdoor unit							
Sound pressure level		dB(A)	48	49	50	53	49
Sound power level		dB	66	67	67	70	66
Dimensions	H x W x D	mm	795 x 900 x 320	795 x 900 x 320	1.340 x 900 x 320	1.340 x 900 x 320	1.340 x 900 x 320
Weight		kg	66	66	101	101	108
Pipe diameter	Liquid	mm (Inch)	6,35 (1/4)	6,35 (1/4)	9,52 (3/8)	9,52 (3/8)	9,52 (3/8)
	Gas	mm (Inch)	15,88 (5/8)	15,88 (5/8)	15,88 (5/8)	15,88 (5/8)	15,88 (5/8)
Refrigerant (R410A)		kg	1,45	1,45	2,55	2,55	2,55
Pipe length range		m	3 - 30	3 - 30	3 - 30	3 - 30	3 - 30
Pipe length for nominal capacity		m	7	7	7	7	7
Pipe length for additional gas		m	10	10	10	10	10
Additional gas amount (R410A)		g/m	30	30	50	50	50
Elevation difference (in/out)		m	20	20	20	20	20
Operation range	Outdoor ambient	°C	-20 / +35	-20 / +35	-20 / +35	-20 / +35	-20 / +35
Water outlet	Heating	°C	25 - 55	25 - 55	25 - 55	25 - 55	25 - 55
	Cooling	°C	5 - 20	5 - 20	5 - 20	5 - 20	5 - 20

COP classification is at 230 V only in accordance with EU directive 2003/32/EC. Sound pressure measured at 1 m from the outdoor unit and at 1,5 m height. Performance in agreement with EN14511.

ErP ready 2015	Internet Control Ready INTERNET CONTROL	A class water pump HIGH EFFICIENCY	4,84 COP high efficiency AQUAREA HIGH PERFORMANCE	High efficiency heating INVERTER+	Environmentally friendly refrigerant R410A	Down to -20°C in heating mode OUTDOOR TEMPERATURE	Boiler connection RETROFIT	Solar panels connection SOLAR KIT	Domestic hot water DHW	Easy control by BMS CONNECTIVITY	5 year compressor warranty	INTERNET CONTROL READY: Optional.
--------------------------	---	--	---	---	--	---	--------------------------------------	---	----------------------------------	--	-----------------------------------	-----------------------------------

AQUAREA T-CAP BI-BLOC SINGLE PHASE / THREE PHASE HEATING AND COOLING - SXC

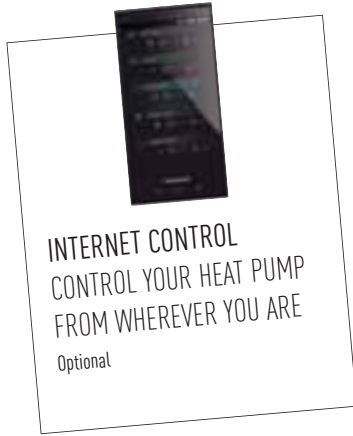

INTERNET CONTROL
CONTROL YOUR HEAT PUMP
FROM WHEREVER YOU ARE
Optional



The new SXC is ideal for residential properties which don't have an external boiler and require a maintained capacity level.

T-CAP stands for Total Capacity. This new line-up is able to maintain the same nominal capacity even at -15°C without the help of an electrical booster heater. T-CAP is also able to provide extremely high efficiency, whatever the outside temperature or the water temperature. The SXC adapts well in an existing install with a boiler backup, and in a new application with underfloor heating, low temperature radiators or even fan-coil heaters. This Range can also be connected to a solar kit in order to increase efficiency and minimize the impact on the ecosystem. Finally, it is possible to connect a thermostat for even better heating or cooling control and management.

Technical focus

- 16kW Model: Maintains 16kW capacity at outdoor temperatures down to -15°C
- New remote control functions
- Efficient control of room temperature based on the outdoor temperature, indoor temperature using the Aquarea Manager.
- Optional Smartphone control
- Range from 9 to 16kW, Single and Three Phase
- Maximum hydraulic module output temperature: 55°C
- Works down to -20°C (Cooling temperature range 5-20°C)
- Constant capacity at outdoor temperatures down to -15°C
- Maximum 20 m rise between the outdoor unit and the hydraulic module

Kit	Single Phase (Power to indoor)			Three Phase (Power to indoor)		
	KIT-WXC09F3E5	KIT-WXC12F6E5	KIT-WXC09F3E8	KIT-WXC09F9E8	KIT-WXC12F9E8	KIT-WXC16F9E8
Indoor unit	WH-SXC09F3E5	WH-SXC12F6E5	WH-SXC09F3E8	WH-SXC09F9E8	WH-SXC12F9E8	WH-SXC16F9E8
Outdoor unit	WH-UX09FE5	WH-UX12FE5	WH-UX09FE8	WH-UX09FE8	WH-UX12FE8	WH-UX16FE8
Heating capacity at +7°C (heating water at 35°C)	kW	12,00	9,00	9,00	12,00	16,00
COP at +7°C (heating water at 35°C)	W/W	4,84	4,74	4,84	4,84	4,28
Heating capacity at +2°C (heating water at 35°C)	kW	9,00	12,00	9,00	9,00	16,00
COP at +2°C (heating water at 35°C)	W/W	3,59	3,44	3,59	3,59	3,10
Heating capacity at -7°C (heating water at 35°C)	kW	9,00	12,00	9,00	9,00	16,00
COP at -7°C (heating water at 35°C)	W/W	2,85	2,72	2,85	2,85	2,49
Cooling capacity at 35°C (cooling water at 7°C)	kW	7,00	10,00	7,00	7,00	12,20
EER at 35°C (cooling water at 7°C)	W/W	3,17	2,81	3,17	3,17	2,57
Indoor unit						
Sound pressure level	Heating / Cooling	dB(A)	33 / 33	33 / 33	33 / 33	33 / 33
Dimensions	H x W x D	mm	892 x 502 x 353	892 x 502 x 353	892 x 502 x 353	892 x 502 x 353
Weight		kg	44	45	45	52
Water pipe connector			R 1 1/4	R 1 1/4	R 1 1/4	R 1 1/4
Pump	Number of speeds		7	7	7	7
	Input power (Min / Max)	W	32 / 102	34 / 110	32 / 102	34 / 110
Heating water flow [ΔT=5 K, 35°C]		l/min	25,8	34,4	25,8	34,4
Capacity of integrated electric heater		kW	3	6	3	9
Input Power		kW	1,86	2,53	1,86	2,53
Starting Current		A	10,2	16,5	3,4	5,4
Current 1 / Current 2		A	25,0 / 26,0	29,0 / 26,0	14,7 / 13,0	14,7 / 13,0
Recommended Fuse		A	30 / 30	30 / 30	16 / 16	16 / 16
Recommended power cable section		mm²	4,0 / 4,0	4,0 / 4,0	2,5 / 2,5	2,5 / 2,5
Outdoor unit						
Sound pressure level	Heating / Cooling	dB(A)	49 / 49	50 / 50	49 / 49	50 / 50
Sound power level		dB	66	67	66	70
Dimensions	H x W x D	mm	1.340 x 900 x 320	1.340 x 900 x 320	1.340 x 900 x 320	1.340 x 900 x 320
Weight		kg	101	101	109	119
Pipe diameter	Liquid	mm (Inch)	9,52 (3/8)	9,52 (3/8)	9,52 (3/8)	9,52 (3/8)
	Gas	mm (Inch)	15,88 (5/8)	15,88 (5/8)	15,88 (5/8)	15,88 (5/8)
Refrigerant (R410A)		kg	2,85	2,85	2,85	2,90
Pipe length range		m	3 - 30	3 - 30	3 - 30	3 - 30
Pipe length for nominal capacity		m	7	7	7	7
Pipe length for additional gas		m	10	10	10	10
Additional gas amount (R410A)		g/m	50	50	50	50
Elevation difference (in/out)		m	20	20	20	20
Operation range	Outdoor ambient	°C	-20 / +35	-20 / +35	-20 / +35	-20 / +35
Water outlet	Heating	°C	25 - 55	25 - 55	25 - 55	25 - 55
	Cooling	°C	5 - 20	5 - 20	5 - 20	5 - 20

COP classification is at 230 V only in accordance with EU directive 2003/32/EC. Sound pressure measured at 1 m from the outdoor unit and at 1,5 m height. Performance in agreement with EN14511.

ErP ready 2015	Internet Control Ready INTERNET CONTROL	A class water pump HIGH EFFICIENCY	100% capacity at -15 °C AQUAREA T-CAP	High efficiency heating INVERTER+	Environmentally friendly refrigerant R410A	Down to -20 °C in heating mode OUTDOOR TEMPERATURE	Boiler connection RETROFIT	Solar panels connection SOLAR KIT	Domestic hot water DHW	Easy control by BMS CONNECTIVITY	5 year compressor warranty
--------------------------	---	--	---	---	--	--	--------------------------------------	---	----------------------------------	--	-----------------------------------

INTERNET CONTROL READY: Optional.

AQUAREA HT BI-BLOC SINGLE PHASE / THREE PHASE HEATING ONLY - SHF



Aquarea HT is able to deliver water heated to 65°C with the Heat Pump alone.

For a house with high temperature radiators (for example, cast iron radiators), the Aquarea High Temperature Solution is most suited as it provides output water temperatures of 65°C even at -20°C.

Technical focus

- New remote control functions
- Efficient control of room temperature based on the outdoor temperature, indoor temperature using the Aquarea Manager.
- Optional Smartphone control
- Range from 9 to 12kW, Single and Three Phase
- Maximum hydraulic module output temperature: 65°C
- Works down to -20°C
- Maximum 20 m rise between the outdoor unit and the hydraulic module

Kit	Single Phase (Power to indoor)		Three Phase (Power to indoor)	
	KIT-WHF09F3E5	KIT-WHF12F6E5	KIT-WHF09F3E8	KIT-WHF12F9E8
Indoor unit	WH-SHF09F3E5		WH-SHF12F6E5	
Outdoor unit	WH-UH09FE5		WH-UH12FE5	
Heating capacity at +7°C (heating water at 35°C)	kW	9,00	12,00	9,00
COP at +7°C (heating water at 35°C)	W/W	4,64	4,46	4,64
Heating capacity at +2°C (heating water at 35°C)	kW	9,00	12,00	9,00
COP at +2°C (heating water at 35°C)	W/W	3,45	3,26	3,45
Heating capacity at -7°C (heating water at 35°C)	kW	9,00	12,00	9,00
COP at -7°C (heating water at 35°C)	W/W	2,74	2,52	2,74
Heating capacity at +7°C (heating water at 65°C)	kW	9,00	12,00	9,00
COP at +7°C (heating water at 65°C)	W/W	2,25	2,20	2,25
Heating capacity at +2°C (heating water at 65°C)	kW	9,00	10,30	9,00
COP at +2°C (heating water at 65°C)	W/W	1,88	1,83	1,88
Heating capacity at -7°C (heating water at 65°C)	kW	8,90	9,60	8,90
COP at -7°C (heating water at 65°C)	W/W	1,64	1,61	1,64
Indoor unit				
Sound pressure level	dB(A)	33	33	33
Dimensions	H x W x D	mm 892 x 502 x 353	mm 892 x 502 x 353	mm 892 x 502 x 353
Weight	kg	46	47	48
Water pipe connector		R 1 ¼	R 1 ¼	R 1 ¼
Pump	Number of speeds	7	7	7
	Input power (Min / Max)	W 38 / 100	W 40 / 106	W 38 / 100
Heating water flow (ΔT=5 K, 35°C)	l/min	25,8	34,4	25,8
Capacity of integrated electric heater	kW	3	6	3
Input Power	kW	1,94	2,69	1,94
Running and Starting current	A	9,3	12,9	3,0
Current 1 / Current 2	A	28,5 / 26,0	29,0 / 26,0	14,7 / 13,0
Recommended Fuse	A	30 / 30	30 / 30	30 / 16
Recommended power cable section	mm²	4,0 / 4,0	4,0 / 4,0	4,0 / 2,5
Outdoor unit				
Sound pressure level	dB(A)	49	50	49
Sound power level	dB	66	67	66
Dimensions	H x W x D	mm 1.340 x 900 x 320	mm 1.340 x 900 x 320	mm 1.340 x 900 x 320
Weight	kg	104	104	110
Pipe diameter	Liquid	mm (Inch) 9,52 (3/8)	mm (Inch) 9,52 (3/8)	mm (Inch) 9,52 (3/8)
	Gas	mm (Inch) 15,88 (5/8)	mm (Inch) 15,88 (5/8)	mm (Inch) 15,88 (5/8)
Refrigerant (R407C)	kg	2,90	2,90	2,90
Pipe length range	m	3 - 30	3 - 30	3 - 30
Pipe length for nominal capacity	m	7	7	7
Pipe length for additional gas	m	10	10	10
Additional gas amount (R407C)	g/m	70	70	70
Elevation difference (in/out)	m	20	20	20
Operation range	Outdoor ambient	°C -20 / +35	°C -20 / +35	°C -20 / +35
Water outlet	°C	25 - 65	25 - 65	25 - 65

COP classification is at 230 V only in accordance with EU directive 2003/32/EC. Sound pressure measured at 1 m from the outdoor unit and at 1,5 m height. Performance in agreement with EN14511.

ErP ready
2015

Internet Control Ready
INTERNET CONTROL

A class water pump
HIGH EFFICIENCY

Output water 65 °C
HIGH TEMP HEAT PUMP

High efficiency heating
INVERTER +

Environmentally friendly refrigerant
R407C

Down to -20 °C in heating mode
OUTDOOR TEMPERATURE

Boiler connection
RETROFIT

Solar panels connection
SOLAR KIT

Domestic hot water
DHW

Easy control by BMS
CONNECTIVITY

5 year compressor warranty

INTERNET CONTROL READY: Optional.

AQUAREA HIGH PERFORMANCE MONO-BLOC SINGLE PHASE / THREE PHASE HEATING ONLY - MDF HEATING AND COOLING - MDC



KNX
Modbus[®]

CONNECTABLE TO HOUSE
MANAGEMENT SYSTEM
USING KNX OR MODBUS
INTERFACES

Optional

The Aquarea MDF / MDC range adapts well in an existing installation with a boiler backup, and in a new application with underfloor heating, low temperature radiators or even fan-coil heaters.

This range can also be connected to a solar kit in order to increase efficiency and minimize the impact on the ecosystem. Finally, it is possible to connect a thermostat for even better heating (MDF) or better heating and cooling control (MDC) control and management.

Technical focus

- Efficient control of room temperature based on the outdoor temperature, indoor temperature using the Aquarea Manager.
- Optional Smartphone control
- Range from 9 to 16kW, Single and Three Phase
- Maximum hydraulic module output temperature: 55°C
- Works down to -20°C
- Cooling temperature range 5-20°C (MDC)

		Single Phase		Three Phase		
Outdoor unit Heating Only		WH-MDF12C6E5	WH-MDF16C6E5	WH-MDF09C3E8	WH-MDF12C9E8	WH-MDF16C9E8
Outdoor unit Heating and Cooling		WH-MDC12C6E5	WH-MDC16C6E5	WH-MDC09C3E8	WH-MDC12C9E8	WH-MDC16C9E8
Heating capacity at +7°C (heating water at 35°C)	kW	12,00	16,00	9,00	12,00	16,00
COP at +7°C (heating water at 35°C)		4,67	4,23	4,74	4,67	4,23
Heating capacity at +2°C (heating water at 35°C)	kW	11,40	13,00	9,00	11,40	13,00
COP at +2°C (heating water at 35°C)		3,41	3,25	3,53	3,41	3,25
Heating capacity at -7°C (heating water at 35°C)	kW	10,00	11,40	9,00	10,00	11,40
COP at -7°C (heating water at 35°C)		2,70	2,65	2,81	2,70	2,65
Cooling capacity at 35°C (cooling water at 7°C) ¹	kW	10,00	12,20	7,00	10,00	12,20
EER at 35°C (cooling water at 7°C) ¹		2,78	2,54	3,11	2,78	2,54
Sound pressure level	Heating / Cooling ¹	dB(A)	50 / 50	49 / 49	50 / 50	53 / 54
Sound power level	Heating / Cooling ¹	dB	67 / 68	70 / 72	66 / 67	67 / 68
Dimensions	H x W x D	mm	1.410 x 1.283 x 320	1.410 x 1.283 x 320	1.410 x 1.283 x 320	1.410 x 1.283 x 320
Weight		kg	153	157	157	157
Refrigerant (R410A)		kg	2,30	2,30	2,30	2,30
Water pipe connector			R 1 1/4	R 1 1/4	R 1 1/4	R 1 1/4
Pump	Number of speeds		3	3	3	3
	Input power (Min - Max)	W	34 / 110	38 / 120	32 / 102	34 / 110
Heating water flow (ΔT=5 K, 35°C)		l/min	34,4	45,9	25,8	34,4
Capacity of integrated electric heater		kW	6	6	3	9
Input Power	Heating	kW	2,57	3,78	1,90	2,57
	Cooling ¹	kW	3,60	4,80	2,25	3,60
Running and Starting current	Heating	A	11,6	17,1	2,9	3,9
	Cooling ¹	A	16,1	21,5	3,4	5,3
Current 1		A	24,0	26,0	11,8	8,8
Current 2		A	26,0	26,0	13,0	13,0
Current 3		A	13,0	13,0	13,0	13,0
Recommended Fuse		A	30 / 30 / 16	30 / 30 / 16	16 / 16	16 / 16 / 16
Recommended power cable section		mm ²	4,0 / 4,0 / 2,5	4,0 / 4,0 / 2,5	2,5 / 2,5	2,5 / 2,5 / 2,5
Operation range	Outdoor ambient	°C	-20 / +35	-20 / +35	-20 / +35	-20 / +35
Water outlet	Heating	°C	25 - 55	25 - 55	25 - 55	25 - 55
	Cooling ¹	°C	5 - 20	5 - 20	5 - 20	5 - 20

COP classification is at 230 V only in accordance with EU directive 2003/32/EC. Sound pressure measured at 1 m from the outdoor unit and at 1.5 m height. Performance in agreement with EN14511.

1. Specifications for Heating and Cooling models.

Available in June 2015

ErP ready 2015	Internet Control Ready INTERNET CONTROL	4,74 COP high efficiency AQUAREA HIGH PERFORMANCE	High efficiency heating INVERTER+	Environmentally friendly refrigerant R410A	Down to -20 °C in heating mode OUTDOOR TEMPERATURE	Boiler connection RETROFIT	Solar panels connection SOLAR KIT	Domestic hot water DHW	Easy control by BMS CONNECTIVITY
--------------------------	---	--	---	--	--	--------------------------------------	---	----------------------------------	--

5 year
compressor
warranty

INTERNET CONTROL READY: Optional.

AQUAREA G GENERATION HIGH PERFORMANCE MONO-BLOC SINGLE PHASE HEATING AND COOLING - MDC



OPTIONAL CONTROLLERS

- HPM WITH LCD
PAW-HPM1
- HPM TOUCH SCREEN
PAW-HPMED FOR HPM

The Aquarea MDC range adapts well in an existing installation with a boiler backup, and in a new application with underfloor heating, low temperature radiators or even fan-coil heaters.

This range can also be connected to a solar kit in order to increase efficiency and minimize the impact on the ecosystem. Finally, it is possible to connect a thermostat for even better heating and cooling control and management.

Technical focus

- New remote control functions
- Efficient control of room temperature based on the outdoor temperature, indoor temperature using the Aquarea Manager.
- Optional Smartphone control
- Range from 12 to 16kW, Single Phase
- Maximum hydraulic module output temperature: 55°C
- Works down to -20°C
- Cooling temperature range 5-20°C

		Single Phase		
Outdoor unit Heating and Cooling		WH-MDC09G3E5*	WH-MDC12G6E5**	WH-MDC16G6E5**
Heating capacity at +7°C (heating water at 35°C)	kW	9,00	12,00	16,00
COP at +7°C (heating water at 35°C)		4,15	4,74	4,28
Heating capacity at +2°C (heating water at 35°C)	kW	7,45	11,40	13,00
COP at +2°C (heating water at 35°C)		3,14	3,44	3,28
Heating capacity at -7°C (heating water at 35°C)	kW	7,70	10,00	11,40
COP at -7°C (heating water at 35°C)		2,12	2,73	2,68
Cooling capacity at 35°C (cooling water at 7°C)	kW	7,00	10,00	12,20
EER at 35°C (cooling water at 7°C)		2,44	2,81	2,57
Sound pressure level	Heating / Cooling	dB(A)	50 / 50	53 / 54
Sound power level	Heating / Cooling	dB	67 / 67	70 / 72
Dimensions	H x W x D	mm	865 x 1.283 x 320	1.410 x 1.283 x 320
Weight		kg	112	153
Water pipe connector			R 1 1/4	R 1 1/4
Pump	Number of speeds		Variable Speed	7
	Input power (Min - Max)	W	40 / 120	34 / 110
Heating water flow (ΔT=5 K, 35°C)		l/min	25,8	34,4
Capacity of integrated electric heater		kW	3	6
Input Power	Heating	kW	2,17	2,53
	Cooling	kW		3,56
Running and Starting current	Heating	A	9,9	11,6
	Cooling	A		16,1
Current 1		A		24,0
Current 2		A		26,0
Recommended Fuse		A	30 / 16	30 / 30
Recommended power cable section		mm²	4,0 / 2,5	4,0 / 4,0
Operation range	Outdoor ambient	°C	-20 / +35	-20 / +35
Water outlet	Heating	°C	20 - 55	25 - 55
	Cooling	°C		5 - 20

COP classification is at 230 V only in accordance with EU directive 2003/32/EC. Sound pressure measured at 1 m from the outdoor unit and at 1.5 m height. Performance in agreement with EN14511.
* Tentative data. Available in September 2015. ** Available in June 2015.

ErP ready 2015	Internet Control Ready INTERNET CONTROL	A class water pump HIGH EFFICIENCY	4,74 COP high efficiency AQUAREA HIGH PERFORMANCE	High efficiency heating INVERTER+	Environmentally friendly refrigerant R410A	Down to -20°C in heating mode OUTDOOR TEMPERATURE	Boiler connection RETROFIT	Solar panels connection SOLAR KIT	Domestic hot water DHW	Easy control by BMS CONNECTIVITY	5 year compressor warranty	INTERNET CONTROL READY: Optional.
--------------------------	---	--	---	---	--	---	--------------------------------------	---	----------------------------------	--	-----------------------------------	-----------------------------------

AQUAREA T-CAP MONO-BLOC SINGLE PHASE / THREE PHASE HEATING ONLY - MXF HEATING AND COOLING - MXC



The MXC is ideal for residential properties which don't have an external boiler and require a maintained capacity level.

T-CAP stands for Total Capacity. This new line-up is able to maintain the same nominal capacity even at -15°C without the help of an electrical booster heater. T-CAP is also able to provide extremely high efficiency, whatever the outside temperature or the water temperature. The MXC adapts well in an existing install with a boiler backup, and in a new application with underfloor heating, low temperature radiators or even fan-coil heaters. This range can also be connected to a solar kit in order to increase efficiency and minimize the impact on the ecosystem. Finally, it is possible to connect a thermostat for even better heating or cooling control and management.

Technical focus

- Efficient control of room temperature based on the outdoor temperature, indoor temperature using the Aquarea Manager.
- Optional Smartphone control
- Range from 9 to 12 kW, Single and Three Phase
- Maximum hydraulic module output temperature: 55°C
- Works down to -20°C
- Cooling temperature range 5-20°C (MXC)

		Single Phase		Three Phase	
Outdoor unit Heating Only		WH-MXF09D3E5	WH-MXF12D6E5	WH-MXF09D3E8	WH-MXF12D9E8
Outdoor unit Heating and Cooling		WH-MXC09D3E5	WH-MXC12D6E5	WH-MXC09D3E8	WH-MXC12D9E8
Heating capacity at +7°C (heating water at 35°C)	kW	9,00	12,00	9,00	12,00
COP at +7°C (heating water at 35°C)		4,74	4,67	4,74	4,67
Heating capacity at +2°C (heating water at 35°C)	kW	9,00	12,00	9,00	12,00
COP at +2°C (heating water at 35°C)		3,53	3,40	3,53	3,40
Heating capacity at -7°C (heating water at 35°C)	kW	9,00	12,00	9,00	12,00
COP at -7°C (heating water at 35°C)		2,81	2,70	2,81	2,70
Cooling capacity at 35°C (cooling water at 7°C)	kW	7,00	10,00	7,00	10,00
EER at 35°C (cooling water at 7°C)		3,11	2,78	3,11	2,78
Sound pressure level	Heating / Cooling ¹	dB(A) 49 / 49	50 / 50	49 / 49	50 / 50
Sound power level		dB 66	67	66	67
Dimensions	H x W x D	mm 1.410 x 1.283 x 320	1.410 x 1.283 x 320	1.410 x 1.283 x 320	1.410 x 1.283 x 320
Weight		kg 155	155	158	158
Refrigerant (R410A)		kg 2,30	2,30	2,30	2,30
Water pipe connector		R 1 1/4	R 1 1/4	R 1 1/4	R 1 1/4
Pump	Number of speeds	3	3	3	3
	Input power (Min - Max)	W 32 / 102	34 / 110	32 / 102	34 / 110
Heating water flow [ΔT=5 K, 35°C]	l/min	25,8	34,4	25,8	34,4
Capacity of integrated electric heater	kW	3	6	3	9
Input Power	kW	1,90	2,57	1,90	2,57
Starting Current	A	10,4	16,7	2,9	3,9
Current 1	A	25,0	29,0	14,7	11,9
Current 2	A	26,0	26,0	13,0	13,0
Current 3	A		13,0		13,0
Recommended Fuse	A	30 / 30	30 / 30 / 16	16 / 16	16 / 16 / 16
Recommended power cable section	mm ²	4,0 / 4,0	4,0 / 4,0 / 2,5	2,5 / 2,5	2,5 / 2,5 / 2,5
Operation range	Outdoor ambient	°C -20 / +35	-20 / +35	-20 / +35	-20 / +35
Water outlet	Heating	°C 25 - 55	25 - 55	25 - 55	25 - 55
	Cooling ¹	°C 5 - 20	5 - 20	5 - 20	5 - 20

COP classification is at 230 V only in accordance with EU directive 2003/32/EC. Sound pressure measured at 1 m from the outdoor unit and at 1.5 m height. Performance in agreement with EN14511.
1. Specifications for Heating and Cooling models.

ErP ready 2015	Internet Control Ready INTERNET CONTROL	100% capacity at -15°C AQUAREA T-CAP	High efficiency heating INVERTER+	Environmentally friendly refrigerant R410A	Down to -20°C in heating mode OUTDOOR TEMPERATURE	Boiler connection RETROFIT	Solar panels connection SOLAR KIT	Domestic hot water DHW	Easy control by BMS CONNECTIVITY
--------------------------	---	--	---	--	---	--------------------------------------	---	----------------------------------	--

5 year compressor warranty

INTERNET CONTROL READY: Optional.

AQUAREA G GENERATION T-CAP MONO-BLOC SINGLE PHASE / THREE PHASE HEATING AND COOLING - MXC

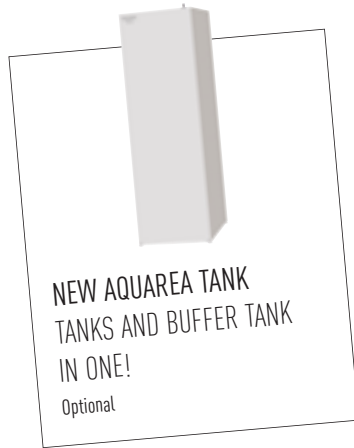

NEW



The MXC is ideal for residential properties which don't have an external boiler and require a maintained capacity level.

T-CAP stands for Total Capacity. This new line-up is able to maintain the same nominal capacity even at -15°C without the help of an electrical booster heater. T-CAP is also able to provide extremely high efficiency, whatever the outside temperature or the water temperature. The MXC adapts well in an existing install with a boiler backup, and in a new application with underfloor heating, low temperature radiators or even fan-coil heaters. This range can also be connected to a solar kit in order to increase efficiency and minimize the impact on the ecosystem. Finally, it is possible to connect a thermostat for even better heating or cooling control and management.

Technical focus

- New remote control functions
- Efficient control of room temperature based on the outdoor temperature, indoor temperature using the Aquarea Manager.
- Optional Smartphone control
- Range from 9 to 16 kW, Single and Three Phase
- Maximum hydraulic module output temperature: 55°C
- Works down to -20°C
- Cooling temperature range 5-20°C

		Single Phase		Three Phase		
		WH-MXC09G3E5	WH-MXC12G6E5	WH-MXC09G3E8	WH-MXC12G9E8	WH-MXC16G9E8 ¹
Outdoor unit Heating and Cooling						
Heating capacity at +7°C (heating water at 35°C)	kW	9,00	12,00	9,00	12,00	16,00
COP at +7°C (heating water at 35°C)		4,84	4,74	4,84	4,74	4,28
Heating capacity at +2°C (heating water at 35°C)	kW	9,00	12,00	9,00	12,00	16,00
COP at +2°C (heating water at 35°C)		3,59	3,44	3,59	3,44	3,10
Heating capacity at -7°C (heating water at 35°C)	kW	9,00	12,00	9,00	12,00	16,00
COP at -7°C (heating water at 35°C)		2,85	2,72	2,85	2,72	2,49
Cooling capacity at 35°C (cooling water at 7°C)	kW	7,00	10,00	7,00	10,00	12,20
EER at 35°C (cooling water at 7°C)		3,17	2,81	3,17	2,81	2,57
Sound pressure level	Cooling / Heating	dB(A)	49 / 49	50 / 50	49 / 49	54 / 53
Sound power level		dB	66	67	66	70
Dimensions	H x W x D	mm	1.410 x 1.283 x 320	1.410 x 1.283 x 320	1.410 x 1.283 x 320	1.410 x 1.283 x 320
Weight		kg	148	148	155	161
Refrigerant (R410A)		kg	2,30	2,30	2,30	
Water pipe connector			R 1 ¼	R 1 ¼	R 1 ¼	R 1 ¼
Pump	Number of speeds		7	7	7	7
	Input power (Min - Max)	W	32 / 102	34 / 110	32 / 102	38 / 120
Heating water flow (ΔT=5 K, 35°C)		l/min	25,8	34,4	25,8	34,4
Capacity of integrated electric heater		kW	3	6	3	9
Input Power		kW	1,90	2,57	1,90	2,57
Starting Current		A	10,4	16,7	2,9	3,9
Current 1		A	25,0	29,0	14,7	11,9
Current 2		A	26,0	26,0	13,0	13,0
Current 3		A		13,0		13,0
Recommended Fuse		A	30 / 30	30 / 30	16 / 16	16 / 16
Recommended power cable section		mm²	4,0 / 4,0	4,0 / 4,0	2,5 / 2,5	2,5 / 2,5
Operation range	Outdoor ambient	°C	-20 / +35	-20 / +35	-20 / +35	-20 / +35
Water outlet	Heating	°C	25 - 55	25 - 55	25 - 55	25 - 55
	Cooling	°C	5 - 20	5 - 20	5 - 20	5 - 20

COP classification is at 230 V only in accordance with EU directive 2003/32/EC. Sound pressure measured at 1 m from the outdoor unit and at 1.5 m height. Performance in agreement with EN14511.

1. Tentative data.

WH-MXC09G3E5 and WH-MXC12G6E5 available in May 2015. WH-MXC09G3E8 and WH-MXC12G9E8 available in March 2015. WH-MXC16G9E8 available in July 2015.

ErP ready 2015	Internet Control Ready INTERNET CONTROL	A class water pump HIGH EFFICIENCY	100% capacity at -15°C AQUAREA T-CAP	High efficiency heating INVERTER+	Environmentally friendly refrigerant R410A	Down to -20°C in heating mode OUTDOOR TEMPERATURE	Boiler connection RETROFIT	Solar panels connection SOLAR KIT	Domestic hot water DHW	Easy control by BMS CONNECTIVITY	5 year compressor warranty	INTERNET CONTROL READY: Optional.
--------------------------	---	--	--	---	--	---	--------------------------------------	---	----------------------------------	--	-----------------------------------	-----------------------------------

AQUAREA HT MONO-BLOC SINGLE PHASE / THREE PHASE HEATING ONLY - MHF



**PV PANELS + HEAT PUMP
MANAGER INCREASE BY
120% THE USAGE OF FREE
ELECTRICITY**
Optional

Aquarea HT is able to deliver 65°C with the Heat Pump alone.

For a house with high temperature radiators (for example, cast iron radiators), the Aquarea High Temperature Solution is most suited as it provides output water temperatures of 65°C even at -20°C.

Technical focus

- Efficient control of room temperature based on the outdoor temperature, indoor temperature using the Aquarea Manager.
- Optional Smartphone control
- Range from 9 to 12kW, Single and Three Phase
- Maximum hydraulic module output temperature: 65°C
- Works down to -20°C

		Single Phase		Three Phase	
		WH-MHF09D3E5	WH-MHF12D6E5	WH-MHF09D3E8	WH-MHF12D9E8
Heating capacity at +7°C (heating water at 35°C)	kW	9,00	12,00	9,00	12,00
COP at +7°C (heating water at 35°C)		4,55	4,40	4,55	4,40
Heating capacity at +2°C (heating water at 35°C)	kW	9,00	12,00	9,00	12,00
COP at +2°C (heating water at 35°C)		3,40	3,23	3,40	3,23
Heating capacity at -7°C (heating water at 35°C)	kW	9,00	12,00	9,00	12,00
COP at -7°C (heating water at 35°C)		2,70	2,50	2,70	2,50
Heating capacity at +7°C (heating water at 65°C)	kW	9,00	12,00	9,00	12,00
COP at +7°C (heating water at 65°C)		2,25	2,20	2,25	2,20
Heating capacity at +2°C (heating water at 65°C)	kW	9,00	10,30	9,00	10,30
COP at +2°C (heating water at 65°C)		1,88	1,83	1,88	1,83
Heating capacity at -7°C (heating water at 65°C)	kW	8,90	9,60	8,90	9,60
COP at -7°C (heating water at 65°C)		1,62	1,61	1,62	1,61
Sound pressure level	dB(A)	49	50	49	50
Sound power level	dB	66	67	66	67
Dimensions	H x W x D	mm 1.410 x 1.283 x 320	1.410 x 1.283 x 320	1.410 x 1.283 x 320	1.410 x 1.283 x 320
Weight	kg	155	155	158	158
Refrigerant (R407C)	kg	2,22	2,22	2,22	2,22
Water pipe connector		R 1 1/4	R 1 1/4	R 1 1/4	R 1 1/4
Pump	Number of speeds	3	3	3	3
	Input Power (Min - Max)	W 38 / 100	40 / 106	38 / 100	40 / 106
Heating water flow (ΔT=5 K, 35°C)	l/min	25,8	34,4	25,8	34,4
Capacity of integrated electric heater	kW	3	6	3	9
Input Power	kW	1,98	2,73	1,98	2,73
Running and Starting current	A	9,5	12,8	9,5	12,8
Current 1	A	28,5	29,0	14,7	11,9
Current 2	A	26,0	26,0	13,0	13,0
Current 3	A		13,0		13,0
Recommended Fuse	A	30 / 30	30 / 30	-16 / 16	16 / 16
Recommended power cable section	mm ²	4,0 / 4,0	4,0 / 4,0	2,5 / 2,5	2,5 / 2,5
Operation range	Outdoor ambient	°C -20 / +35	-20 / +35	-20 / +35	-20 / +35
Water outlet	°C	25 - 65	25 - 65	25 - 65	25 - 65

COP classification is at 230 V only in accordance with EU directive 2003/32/EC. Sound pressure measured at 1 m from the outdoor unit and at 1.5 m height. Performance in agreement with EN14511.

ErP ready 2015	Internet Control Ready INTERNET CONTROL	Output water 65°C HIGH TEMP HEAT PUMP	High efficiency heating INVERTER+	Environmentally friendly refrigerant R407C	Down to -20°C in heating mode OUTDOOR TEMPERATURE	Boiler connection RETROFIT	Solar panels connection SOLAR KIT	Domestic hot water DHW	Easy control by BMS CONNECTIVITY
--------------------------	---	---	---	--	---	--------------------------------------	---	----------------------------------	--

5 year compressor warranty

INTERNET CONTROL READY: Optional.

AQUAREA G GENERATION HT MONO-BLOC SINGLE PHASE / THREE PHASE HEATING ONLY - MHF



**INTERNET CONTROL
CONTROL YOUR HEAT PUMP
FROM WHEREVER YOU ARE**
Optional

Aquaarea HT is able to deliver 65°C with the Heat Pump alone.

For a house with high temperature radiators (for example, cast iron radiators), the Aquaarea High Temperature Solution is most suited as it provides output water temperatures of 65°C even at -20°C.

Technical focus

- New remote control functions
- Efficient control of room temperature based on the outdoor temperature, indoor temperature using the Aquaarea Manager.
- Optional Smartphone control
- Range from 9 to 12kW, Single and Three Phase
- Maximum hydraulic module output temperature: 65°C
- Works down to -20°C

		Single Phase		Three Phase	
		WH-MHF09G3E5	WH-MHF12G6E5	WH-MHF09G3E8	WH-MHF12G9E8
Heating capacity at +7°C (heating water at 35°C)	kW	9,00	12,00	9,00	12,00
COP at +7°C (heating water at 35°C)		4,64	4,46	4,64	4,46
Heating capacity at +2°C (heating water at 35°C)	kW	9,00	12,00	9,00	12,00
COP at +2°C (heating water at 35°C)		3,45	3,27	3,45	3,26
Heating capacity at -7°C (heating water at 35°C)	kW	9,00	12,00	—	—
COP at -7°C (heating water at 35°C)		2,74	2,52	—	—
Heating capacity at +7°C (heating water at 65°C)	kW	9,00	12,00	—	—
COP at +7°C (heating water at 65°C)		2,27	2,22	—	—
Heating capacity at +2°C (heating water at 65°C)	kW	9,00	10,30	—	—
COP at +2°C (heating water at 65°C)		1,90	1,84	—	—
Heating capacity at -7°C (heating water at 65°C)	kW	8,90	9,60	—	—
COP at -7°C (heating water at 65°C)		1,63	1,62	—	—
Sound pressure level	dB(A)	49	50	49	50
Dimensions	H x W x D	mm	1.410 x 1.283 x 320	1.410 x 1.283 x 320	1.410 x 1.283 x 320
Weight		kg	155	155	162
Water pipe connector			R 1 1/4	R 1 1/4	R 1 1/4
Pump	Number of speeds		7	7	7
	Input Power (Min - Max)	W	—	—	—
Heating water flow (ΔT=5 K, 35°C)		l/min	25,8	34,4	25,8
Capacity of integrated electric heater		kW	3	6	3
Recommended Fuse		A	30 / 30	30 / 30	16 / 16
Recommended power cable section		mm ²	4,0 / 4,0	4,0 / 4,0	2,5 / 2,5
Operation range	Outdoor ambient	°C	-20 / +35	-20 / +35	-20 / +35
		°C	25 - 65	25 - 65	25 - 65

COP classification is at 230 V only in accordance with EU directive 2003/32/EC. Sound pressure measured at 1 m from the outdoor unit and at 1.5 m height. Performance in agreement with EN14511. WH-MHF09G3E5 and WH-MHF12G6E5 available in July 2015. WH-MHF09G3E8 and WH-MHF12G9E8 available in April 2015.

ErP ready 2015	Internet Control Ready INTERNET CONTROL	A class water pump HIGH EFFICIENCY	Output water 65°C HIGH TEMP HEAT PUMP	High efficiency heating INVERTER+	Environmentally friendly refrigerant R407C	Down to -20°C in heating mode OUTDOOR TEMPERATURE	Boiler connection RETROFIT	Solar panels connection SOLAR KIT	Domestic hot water DHW	Easy control by BMS CONNECTIVITY	5 year compressor warranty	INTERNET CONTROL READY: Optional.
--------------------------	---	--	---	---	--	---	--------------------------------------	---	----------------------------------	--	-----------------------------------	-----------------------------------

AQUAREA HIGH PERFORMANCE MONO-BLOC SINGLE PHASE HEATING ONLY - MDF HEATING AND COOLING - MDC



Panasonic has designed the new Aquarea Mono-Bloc heat pump for houses which have high performance requirements but limited space to install the outdoor unit.

Whatever the weather, Aquarea can work even at -20°C. The Mono-Bloc is easy to install in new and existing residential properties.

Technical focus

- New remote control functions
- Efficient control of room temperature based on the outdoor temperature, indoor temperature using the Aquarea Manager.
- Optional Smartphone control
- Range from 6 to 9kW, Single Phase
- Maximum hydraulic module output temperature: 55°C
- Works down to -20°C
- Plug and play system

	Single Phase Heating Only		Single Phase Heating and Cooling			
	WH-MDF06E3E5	WH-MDF09E3E5	WH-MDC05F3E5	WH-MDC06E3E5	WH-MDC09E3E5	
Heating capacity at +7°C (heating water at 35°C)	kW	6,00	9,00	5,00	6,00	9,00
COP at +7°C (heating water at 35°C)		4,48	4,15	5,08	4,48	4,15
Heating capacity at +2°C (heating water at 35°C)	kW	5,00	7,45	4,80	5,00	7,45
COP at +2°C (heating water at 35°C)		3,45	3,14	3,75	3,45	3,14
Heating capacity at -7°C (heating water at 35°C)	kW	5,15	7,70	4,50	5,15	7,70
COP at -7°C (heating water at 35°C)		2,68	2,12	2,98	2,68	2,12
Cooling capacity at 35°C (cooling water at 7°C) ¹	kW	—	—	4,50	5,50	7,00
EER at 35°C (cooling water at 7°C) ¹		—	—	3,33	2,74	2,44
Sound pressure level	Cooling / Heating	dB(A)	— / 47	47 / 47	47 / 47	49 / 49
Sound power level	Cooling / Heating	dB	— / 65	— / 67	65 / 65	67 / 67
Dimensions	H x W x D	mm	865 x 1.283 x 320	865 x 1.283 x 320	865 x 1.283 x 320	865 x 1.283 x 320
Weight		kg	112	112	112	112
Refrigerant (R410A)		kg	1,45	1,45	1,42	1,45
Water pipe connector			R 1 ¼	R 1 ¼	R 1 ¼	R 1 ¼
Pump	Number of speeds		Variable Speed	Variable Speed	7	Variable Speed
	Input power (Min - Max)	W	33 / 110	40 / 120	33 / 106	40 / 120
Water Flow (ΔT=5 K, 35°C)		l/min	17,2	25,8	9,2	17,2
Capacity of integrated electric heater		kW	3	3	3	3
Input Power at +7°C		kW	1,34	2,17	0,985	1,34
Running and Starting current at +7°C		A	6,1	9,9	3	6,1
Recommended Fuse		A	30 / 16	30 / 16	30 / 15	30 / 16
Recommended power cable section		mm ²	4,0 / 2,5	4,0 / 2,5	4,0 / 2,5	4,0 / 2,5
Operation range	Outdoor ambient	°C	-20 / +35	-20 / +35	-20 / +35	-20 / +35
Water outlet		°C	20 - 55	20 - 55	20 - 55	20 - 55

COP classification is at 230 V only in accordance with EU directive 2003/32/EC. Sound pressure measured at 1 m from the outdoor unit and at 1.5 m height. Performance in agreement with EN14511.

1. Specifications for Heating and Cooling models.

Tentative. Authorized service partner or Authorized installer can enable the cooling mode through a special operation via the remote controller on site.

SANITARY TANKS

AQUAREA TANK



Aquarea Tank. Tanks and buffer tank in one!			PAW-TD20B8E3-NDS
Water volume	L		185 (for DHW tank) / 80 (for buffer tank)
Maximum water temperature	°C		100
Dimension	H x W x D	mm	1.810 x 600 x 632
Weight	kg		150
Electric heater	kW		3
Power supply	V		230 - 2p
Material inside tank			Stainless steel
Exchange surface	m²		2,3
Energy loss at 65°C¹	kWh/24h		1,3
A class pump	Number of speed		Stepless (800-4250 rpm)
	Pressure drop (Min / Max)	kPa	5 / 6
	Input power (Min / Max)	W	3 / 45
3 Way valve included			Yes
Safety thermostat with contact for failure part of E-Heating			Yes
Location of the electrical heater			Mid
Electrical backup heater on the buffer tank			Optional



Tanks	Stainless Steel Tank		Enamelled Tank			Enamelled high efficiency Tank		Enamelled 2 coils Tank (for bivalent Solar + HP)	
	Model	WH-TD20E3E5	WH-TD30E3E5-1*	PAW-TG20C1E3STD	PAW-TG30C1E3STD	PAW-TG40C1E3STD	PAW-TG20C1E3HI		PAW-TG30C1E3HI
Water volume	L	200	300	185	285	410	190	290	290
Maximum water temperature	°C	75	75	95	95	95	95	95	95
Dimensions Hight / Diameter	mm	1.150 / 580	1.600 / 580	1.507 / 580	1.565 / 680	1.888 / 760	1.648 / 680	1.417 / 760	1.417 / 760
Weight	kg	49	65	90	131	230	107	157	161
Electric heater	kW	3	3	3	3	3	3	3	3
Power supply	V	230	230	230	230	230	230	230	230
Material inside tank		Stainless steel	Stainless steel	Enamelled	Enamelled	Enamelled	Enamelled	Enamelled	Enamelled
Exchange surface	m²	1,4	1,8	2	2,5	6,1	2,3	3,4	2,4 (for HP) +1,0 (for solar or boiler)
Energy loss at 65°C¹	kWh/24h	1,9	2,3	1,7	2,1	2,6	1,4	1,9	1,9
3 Way valve included		Yes	Yes	Yes	Yes	Yes	Yes	Yes	Yes
20 m temperature sensor cable included		Yes	Yes	Yes	Yes	Yes	Yes	Yes	Yes
Heat up time	Valuation	★★★★	★★★★	★★★*	★★★*	★★★*	★★★★	★★★★	★★★*
Energy losses	Valuation	★★★★	★★★★	★★★*	★★★*	★★★*	★★★★	★★★★	★★★*
Efficiency of the tank	Valuation	★★★★	★★★★	★★★*	★★★*	★★★*	★★★★	★★★★	★★★*
Warranty		10 years	10 years	2 years	2 years	2 years	2 years	2 years	2 years
Maintenance required		No	No	Yearly	Yearly	Yearly	Yearly	Yearly	Yearly



High efficiency water tanks with a large exchange surface and high levels of insulation to minimise energy losses.

1) Insulated tested under EN12897.

Includes proportional 3-way valve and control thermostat.

* Pictures are tentative.



32% MORE
EFFICIENT THAN
STANDARD
RADIATORS

AQUAREA
AIR

Aquarea Air Radiators

The slimline Panasonic Aquarea Air radiators deliver high efficiency climate control. With a depth of just under 13 cm they are at the cutting edge of the market. Blending easily into the home, Aquarea Air's elegant design and product refinements are clear to see in every detail.

The Aquarea Air's slimline profile has been achieved thanks to the innovative layout of the ventilation unit and the heat exchanger. The fan is tangential with asymmetric blades and the large surface heat exchanger enables high airflows to be achieved with low pressure loss and low noise levels. Exceptional ventilation efficiency means the motor uses considerably less energy (low wattage). The fan speed is continuously modulated by the temperature controller with proportional integral logic, with undoubted advantages for regulating the temperature and humidity in summer mode. All temperature curves and capacity are available on www.panasonicproclub.com.

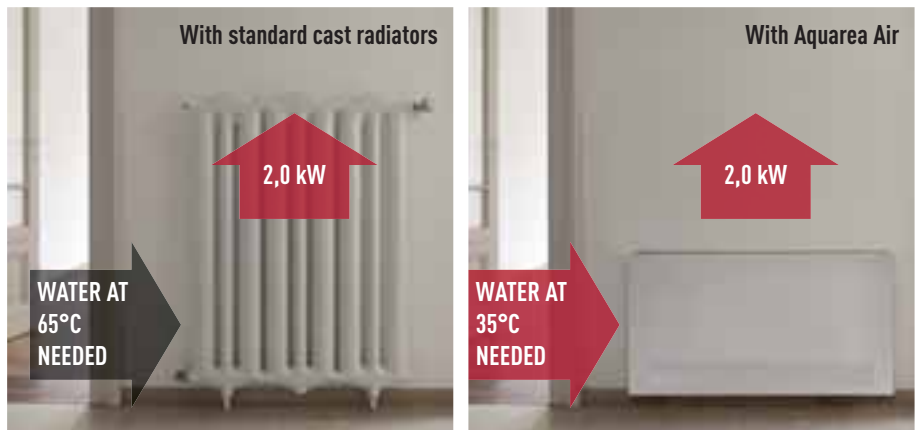

New line up of Super low temperature radiators for Heat Pump application:

Aquarea Air 200/700/900 with radiating effect

Major Benefit

- On the water installation
 - Only 1 water temperature on the water circuit (35°C)
 - No expansive 2 zone kits
 - No overflow valve (as Aquarea Air has a 3-way valve)
 - Very easy to install
- On the efficiency
 - COP with water at 35°C is 32% higher than efficiency with water at 45°C! (case MDF06, at +7°C)

Main features

- Front panel heating with radiant effect
- High heating capacity (without main fan running)
- 4 fan speeds and capacities
- Exclusive design
- Extremely compact (only 12,9 cm deep)
- Cooling and dehumidification functions possible (drain is needed)
- 3-way valve included (no overflow valve needed on the installation if more than 3 radiators installed)
- Touch screen thermostat



During winter, the operating principle is based on micro fans of very low power consumption and minimum noise that send hot air, coming from the heat exchanger, to the inside of the front panel of the device and therefore heat it effectively. With this principle, the terminal also provides significant power while heating, without running the main fan. Comfort temperatures are therefore maintained, without air movements and in silence. In summer mode, the airflow generated by the micro fans is stopped to avoid any dew formation on the terminal's front surface.

Operating on heating mode with radiator using only radiant effect

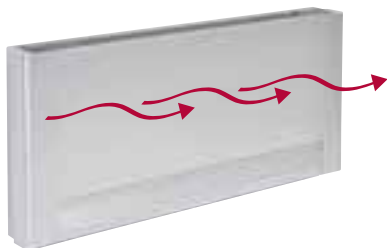

Operating on heating mode with radiant effect and fan mode

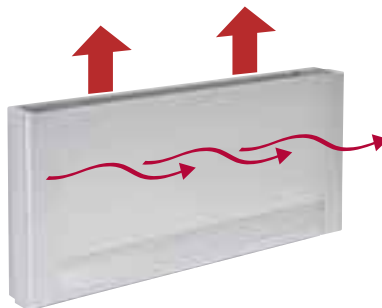

Operating on cooling mode with fan



PAW-AAIR-200
PAW-AAIR-700



PAW-AAIR-900

Fan Coils for Heat Pump application	PAW-AAIR-200					PAW-AAIR-700					PAW-AAIR-900								
	Without radiant heating					Without radiant heating					Without radiant heating								
Total heating capacity	W	138	160	217	470	570	223	360	708	1.032	1.188	273	475	886	1.420	1.703			
Water flow	kg/h	23,7	27,5	37,3	80,8	98,0	38,4	61,9	121,8	177,5	204,3	47,0	81,7	152,4	244,2	292,9			
Water pressure drop	kPa	0,1	0,2	0,4	2,0	2,9	0,1	0,1	0,3	0,8	1,0	0,1	0,2	0,5	1,6	2,2			
Air flow	m³/h	28	37	55	113	162	44	84	155	252	320	54	110	248	367	461			
	Speed	Main	Fan Off	Super	Min	Med	Max	Main	Fan Off	Super	Min	Med	Max	Main	Fan Off	Super	Min	Med	Max
Maximum input power	W	2	5	7	9	13	3	9	14	18	22	3	11	16	20	24			
Sound pressure level	dB(A)	17,6	18,8	24,7	33,2	39,4	18,4	19,6	25,8	34,1	40,2	18,4	22,3	26,2	34,4	42,2			
Inlet water temperature	°C	35	35	35	35	35	35	35	35	35	35	35	35	35	35	35			
Outlet water temperature	°C	30	30	30	30	30	30	30	30	30	30	30	30	30	30	30			
Inlet air temperature	°C	19	19	19	19	19	19	19	19	19	19	19	19	19	19	19			
Outlet air temperature	°C	34,5	32,6	38,9	32,0	30,0	34,9	32,4	33,3	31,8	30,6	34,8	32,5	30,2	31,1	30,6			
Dimensions (H x W x D)	mm	735 x 579 x 129					935 x 579 x 129					1.135 x 579 x 129							
Weight	kg	17					20					23							
3 ways valve included		Yes					Yes					Yes							
Touch screen thermostat		Yes					Yes					Yes							

* Includes 3-way valve, booster heater and sensor.

Accessories for Aquarea Air	PAW-AAIR-LEGS-1	Kits of 2 legs to support the Aquarea Air on the floor and to protect the water pipings
-----------------------------	-----------------	---

Accessories



CZ-NS1P // CZ-NS3P // CZ-NS2P

CZ-NE1P

Solar Kit Accessories	
CZ-NS1P	PCB for solar connection kit for split systems
CZ-NS2P	PCB for solar connection kit for Mono-Bloc systems
CZ-NS3P	PCB for solar connection kit for Mono-Bloc systems 6 & 9 kW
Deice Accessories	
CZ-NE1P	Base pan heater (for all old Bi-Bloc and Mono-Bloc, not for the 3 and 5 kW)
CZ-NE2P	Base pan heater (for 3 and 5 kW)
CZ-NE3P	Base pan heater (for all new F generation products: F3, F6, F9)



CZ-TK1

PAW-TS1 / PAW-TS2

Sanitary Tank Accessories	
CZ-TK1	Temperature sensor kit for third party tank (with copper pocket and 6 m length sensor cable)
PAW-TS1	Tank sensor with 6 m cable length
PAW-TS2	Tank sensor with 20 m cable length
PAW-TS4	Tank sensor with 6 m cable length and only 6 mm diameter
Buffer Tanks	
PAW-BTANK50L	50 l buffer tank (available from June 2015)

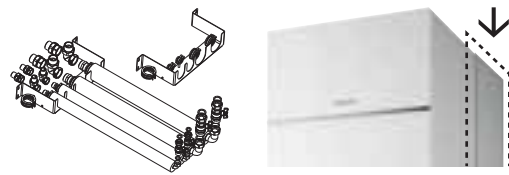

PAW-ADC-PREKIT

PAW-ADC-CV150

Accessories For All In One	
PAW-ADC-PREKIT	Flexible pipings and wall mounting plate for all in one
PAW-ADC-CV150	Decorative magnetic side cover
Accessories for Aquarea Air	
PAW-AAIR-LEGS-1	Kits of 2 legs to support the Aquarea Air on the floor and to protect the water pipings
Accessories for Aquarea DHW	
PAW-DHWE2C	2 kW optional electrical heater for floor standing
PAW-DHWE3C	3 kW optional electrical heater for floor standing



PAW-GRDBSE20

PAW-WTRAY

PAW-GRDSTD40

Special outdoor supports	
PAW-GRDBSE20	Outdoor base ground support for noise and vibration absorption (600 x 95 x 130, 500 kg)
PAW-WTRAY	Tray for condenser water compatible with base ground support
PAW-GRDSTD40	Outdoor elevation platform

Control



PAW-HPM1

PAW-HPM2

PAW-HPMED / PAW-HPMLCD

Aquarea Manager Kits	
PAW-HPM12ZONE-U	HPM with room sensor and setpoint adaption for Bi-Bloc + sensors
PAW-HPM12ZONE-M	HPM with room sensor and setpoint adaption for Mono-Bloc + sensors
PAW-HPM12ZONE-UF	HPM with room sensor and setpoint adaption for F generation Bi-Bloc and Mono-Bloc
PAW-HPM12ZONE-MF	HPM with room sensor and setpoint adaption for F generation Bi-Bloc and Mono-Bloc
PAW-HPM12ZONELCD-U	HPM with LCD wireless room thermostat for Bi-Bloc + sensors
PAW-HPM12ZONELCD-M	HPM with LCD wireless room thermostat for Mono-Bloc + sensors
PAW-HPM12ZONELCD-UF	HPM with LCD wireless room thermostat for F generation Bi-Bloc and Mono-Bloc
PAW-HPM12ZONELCD-MF	HPM with LCD wireless room thermostat for F generation Bi-Bloc and Mono-Bloc
PAW-HPM12ZONELCD-U	HPM with LCD wireless room thermostat for Bi-Bloc + sensors
PAW-HPM12ZONELCD-M	HPM with LCD wireless room thermostat for Mono-Bloc + sensors

Aquarea Manager Accessories	
PAW-HPM1	Aquarea Manager with LCD
PAW-HPM2	Aquarea Manager without LCD
PAW-HPMINT-U	Interface to connect Aquarea Manager to Heat pump Aquarea Bi-Bloc (HPM can control all parametres from HP)
PAW-HPMINT-M	Interface to connect Aquarea Manager to Heat pump Aquarea Mono-Bloc (HPM can control all parametres from HP)
PAW-HPMINT-F	Interface to connect Aquarea Manager to Heat pump Aquarea Mono-Bloc and Bi-Bloc F type (HPM can control all parametres from HP)
PAW-HPMB1	Buffer tank sensor
PAW-HPMDHW	Buffer tank sensor with well
PAW-HPMSOL1	Buffer tank sensor solar (with higher temperature range)
PAW-HPM-CASE	Casing for HPM Manager
PAW-HPMAH1	Water flow pipe sensor for heating circuit
PAW-HPMR4	Room sensor + set point adaption
PAW-HPMED	Touch screen
PAW-HPMLCD	LCD Display HPM Manager
PAW-LANCABLE	Network cable
PAW-AZWSWITCH	Network switch
PAW-HPM-CASE	HPM casing with Premounted cables NEW!
PAW-DEWPOINTSSENSOR	Dew point sensor
PAW-HPMUH	Outdoor temperature sensor



PAW-A2W-RTWIRED

PAW-A2W-RTWIRESLESS

Room Thermostats	
PAW-A2W-RTWIRED	Wired LCD room thermostat with weekly timer
PAW-A2W-RTWIRESLESS	Wireless LCD room thermostat with weekly timer

Hydraulic Accessories	
PAW-2PMP2ZONE	2 zone kit, hydraulic switch, manifold, 2 A-class pumps, 1 mixture valve
PAW-FILTER	2 check valves + filter with 1"
PAW-FILTER-ONLY	Filter with 1"
PAW-A2WFILTERFLOW	Filter and water flow meter

Controller	
PAW-A2W-BIV	NEW: Bivalent controller, available in March 2015

Connectivity Solutions	
PAW-AW-KNX-1i	KNX Interface
PAW-AW-MBS-1	Modbus Interface
PA-AW-WIFI-1	IntesisHome Interface
PA-AW-WIFI-1TE	Wired room temperature sensor (only for PA-AW-WIFI-1)

Examples of installations with Aquarea Manager

Temperature control in the 2 zones with PAW-HPM12ZONE-U

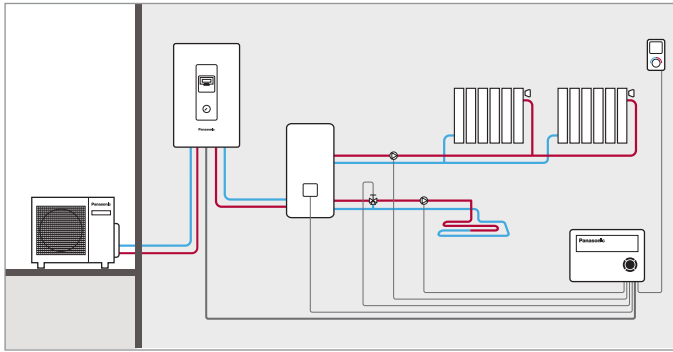

Temperature control in zones 2 + ECS with PAW-HPM12ZONE-U

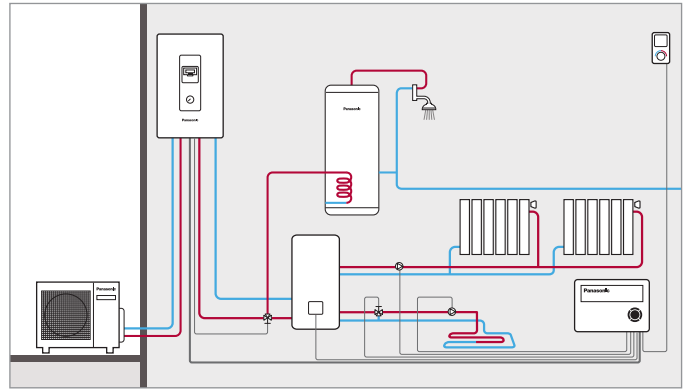

2 heat pumps in cascade with the PAW-HPM12ZONELCD-U

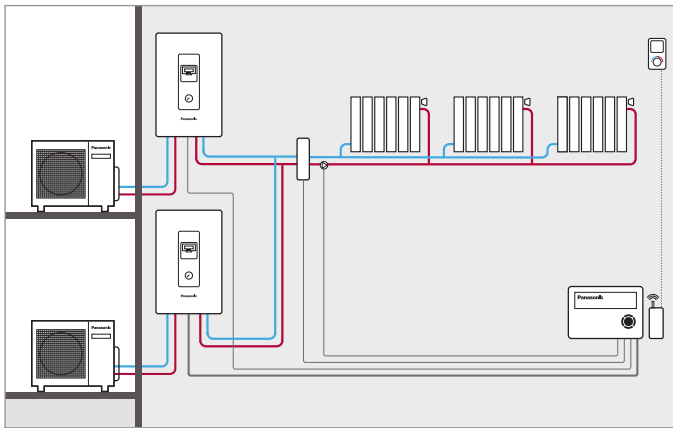

Management of heat pump + boiler and DHW with PAW-HPM12ZONELCD-U

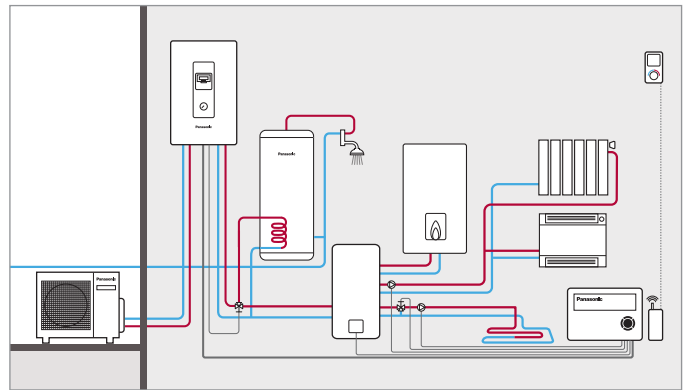

2 heat pump + boiler with PAW-HPM12ZONE-U

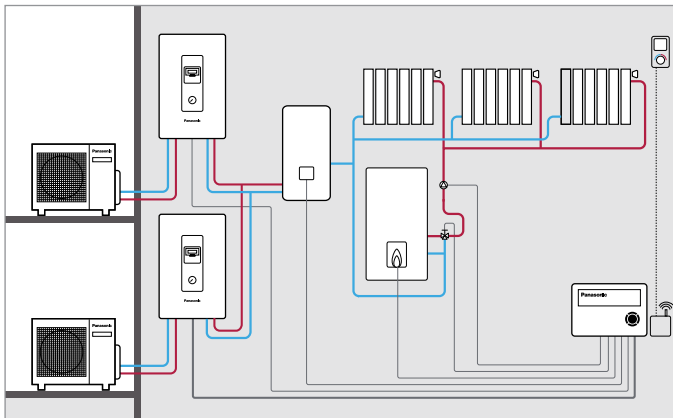

3 heat pumps in cascade with PAW-HPM12ZONELCD-U

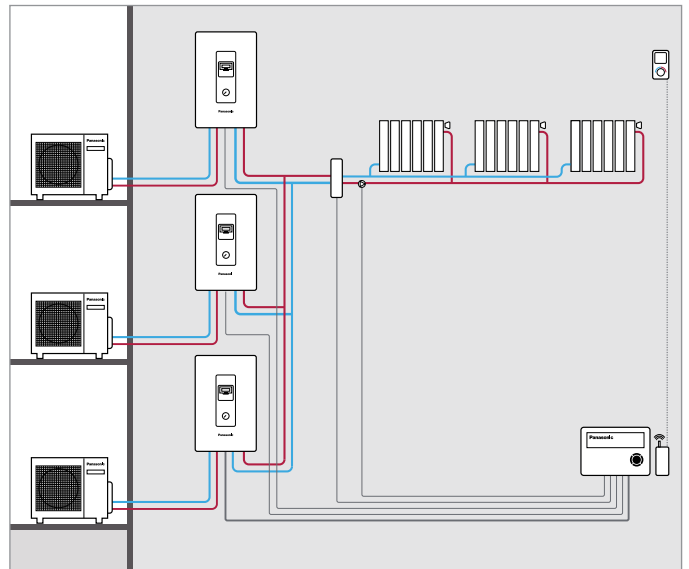

**NEW
AQUAREA DHW
UP TO
75% ENERGY
SAVINGS**



AQUAREA
DHW

New Aquarea DHW

DHW tank with built-in Heat Pump

The Heat Pump is one of the most energy efficient and cost effective methods of water heating. The pump is mounted on the storage tank and draws energy from the ambient air, using that extra energy source to heat the water up to 55°C.

New Aquarea DHW Advantages

- High-technology rotational compressor ensures higher energy efficiency and a higher coefficient of performance, which means major energy savings – up to 75 percent.
- Wrapped around the inside of the outer cover of the tank, it prevents the build-up of limescale, extends the useful life of the equipment and improves safety.
- The dimensions and heating capability of a medium volume Aquarea DHW tank can easily replace an existing electric water heater. Its small size allows it to be installed in spaces where previously a conventional electric water heater would be installed.
- Impressive tank protection is provided through the use of superior super-clean enamel and a large magnesium element. These ensure durability even in the harshest operating conditions without harmful additives in the water.

Bathroom examples.
The wall-mounted unit takes up warm, moist air, cools it down and pumps it outside the bathroom.



Floor standing at -7 °C Aquarea DHW

High capacity: 200/273L. The new designed DHW is ready to achieve levels of high efficiency even at temperatures as low as -7 °C. With 200l and 273l volumes of hot water capacity, with this range it is possible to connect additional heat source such as solar energy. The heat pump cools and de-humidifies the air pumped either from outdoors or from within the building. By choosing the point of air capture and exhaust, you can ventilate and de-humidify some rooms, while extracting the cooled air either into the environment or into another room that you wish to cool.

- Energy efficiency A class
- 119,1 % Energy efficiency η_{wh}^1
- 1.204,2 kWh AEC annual electricity consumption¹
- 6,57 kWh Daily electricity consumption Qelec²
- 55 °C Thermostat temperature settings
- 0 Value of smart

1) EU Regulation 812/2013 ; EN 16147:2010. 2) EN 16147:2010.



PAW-DHWM200A // PAW-DHWM300A



PAW-DHWM200C // PAW-DHWM300C // PAW-DHWM300ZE



PAW-DHWM80ZNT // PAW-DHWM100ZNT // PAW-DHWM120ZNT



Model	Floor standing at -7 °C*			Floor standing			Wall mounted			
	Reference	PAW-DHWM200A	PAW-DHWM300A	PAW-DHWM200C	PAW-DHWM300C	PAW-DHWM300ZE	PAW-DHWM80ZNT	PAW-DHWM100ZNT	PAW-DHWM120ZNT	
Volume	l	285	270	200	285	280	80	100	120	
Volume V (1 / 2 heat exchanger)	l		267 / 270							
Dimensions of Connections										
Height / with air ducts	mm	1930 x 670 x 670			1.540 / 1.680	1.940 / 2.080	1.940 / 2.080	1.197 x 506 x 533	1.342 x 506 x 533	1.497 x 506 x 533
Diameter	mm				660	660	660			
Connections to the water supply network		G 1			G 1	G 1	G 1	G 1/2	G 1/2	G 1/2
Dimensions of air ducts	mm/m	Ø160 / Ø150			Ø150/10	Ø150/10	Ø150/10	Ø125 (150 x 70) /10	Ø125 (150 x 70) /10	Ø125 (150 x 70) /10
Net weight / with water	kg	164 / 172 / 444			120 / 320	149 / 434	166 / 446	58 / 138	62 / 162	68 / 188
Heat Pump										
Nominal electrical power	W	490			620	620	620	250	250	250
Heating up period A7 / W10-55 ¹		10:55 h			7:22 h	11:10 h	11:10 h	5:20 h	6:50 h	8:41 h
Heating up period A15 / W10-55 ²		08:41 h			—	—	—	4:40 h	5:40 h	6:40 h
Energy consumption in heating up period A7 / W10-55 ¹	kWh	4,39			3,25	4,76	4,76	1,12	1,43	1,78
Energy consumption in heating up period A15 / W10-55 ²	kWh	—			—	—	—	0,99	1,19	1,41
Reference tapping cycle		XL			L	XL	XL	M	M	M
Energy consumption by chosen cycle A7 / W10-55 ¹	kWh	6,71			4,90	7,26	7,26	2,45	2,35	2,51
Energy consumption by chosen cycle A15 / W10-55 ²	kWh	6,11			—	—	—	2,04	2,05	2,08
COP DHW (A7 / W10-55) EN 16147 ¹		2,91			2,60	2,80	2,80	2,65	2,63	2,61
COP DHW (A15 / W10-55) EN 16147 ²		3,18			—	—	—	3,10	3,10	3,10
COP EN 255-3		—			4,20	4,20	4,20	4,20	4,20	4,20
Maximum amount of usable water (minimum 40°C) ¹	l	375,20			252,08	345,76	345,76	90	130	142
Standby power input according to EN16147	W	30			47	40	40	19	20	27
Sound power / Sound Pressure on 1m	dB / dB(A)	— / 57,0			56,7 / 44,0	56,7 / 44,0	56,7 / 44,0	51,0 / 39,5	51,0 / 39,5	51,0 / 39,5
Refrigerant		R134a			R134a	R134a	R134a	R134a	R134a	R134a
Quantity of refrigerant	g	1.150			780	780	780	540	540	540
Operating range - air temperature	°C	-7 / +35			+7 / +35	+7 / +35	+7 / +35	-7 / +35	-7 / +35	-7 / +35
Nominal air flow rate (Maximum)	m³/h	300 - 500			480	480	480	100 - 230	100 - 230	100 - 230
Pressure drop by 150 m³/h (60%/80%) ⁴ (Maximum)	Pa	80 (by 350m³/h (60%))			90	90	90	70 (90)	70 (90)	70 (90)
Maximum temperature / Anti legionella program	°C	—			55 / 65	55 / 65	55 / 65	—	—	—
Voltage / Frequency	V / Hz	230 / 50			230 / 50	230 / 50	230 / 50	—	—	—
Maximum power consumption	W	2.490			620	620	620	—	—	—
Storage Tank										
Enamelled steel tank / Protective magnesium anode		+ / +			+ / +	+ / +	+ / +	+ / +	+ / +	+ / +
Average insulation thickness	mm	67			57	57	57	40 - 85	40 - 85	40 - 85
Degree of protection		IP 24			IP 21	IP 21	IP 21	IP24	IP24	IP24
Heat Exchanger - Bottom / Top										
Connection					G 1 / —	G 1 / —	G 1 / G 1			
Exchanger area	m²	1,45 + 0,9			1,05 / —	1,60 / —	1,60 / 1,09			
Heat Exchanger one exchanger version	m²	2,7								
Volume	l				6,6 / —	10,0 / —	10,0 / 6,8			
Heating Power ³	kW				25,8 / —	42,7 / —	42,7 / 26,9			
Electrical Specifications										
Maximum power consumption	W	2.490						2.350	2.350	2.350
Number of electrical heaters x power	W	2 x 1.000						2 x 1.000	2 x 1.000	2 x 1.000
Voltage / Frequency	V / Hz	230 / 50						230 / 50	230 / 50	230 / 50
Electric protection	A	16						16	16	16
Working pressure (Storage tank / Heat Exchanger)	Mpa (bar)	0,6 (6) / 0,9 (9)			1,0 (10) / 1,2 (12)	1,0 (10) / 1,2 (12)	1,0 (10) / 1,2 (12)	1,0 (10)	1,0 (10)	1,0 (10)
Maximum Temperature										
Storage tank / Heat Exchanger	°C	95 / 95			85 / 85	85 / 85	85 / 85			
Heating with heat pump	°C	55						55	55	55
Heating with electrical heater	°C	75						75	75	75
Option										
Installation of an electrical heater to the connecting bushing G 6/4					+	+	+			
Transport Data										
Packaging dimensions	mm	750 x 750 x 2.100			750 x 750 x 1.700	750 x 750 x 2.100	750 x 750 x 2.100	575 x 600 x 1.365	575 x 600 x 1.510	575 x 600 x 1.665

1) Heating of sanitary water up to 55°C with inlet air temperature at 7°C, humidity at 89% and inlet water temperature at 10°C. According to EN16147. 2) Heating of sanitary water up to 55°C with inlet air temperature at 15°C, humidity at 74% and inlet water temperature at 10°C. According to EN16147. 3) Heating of Sanitary water from 10°C up to 45°C with the inlet temperature of heating medium at 80°C and with flow rate 3000 U/h. 4) Normal fan speed 60%, higher fan speed - special setting on 80%.

* When connected as pressurised, use of safety valve is mandatory. Available from June 2015. Tentative data.





A typical example of savings and efficiencies that Aquarea can offer to you

A 125m² house in Reims

The example below shows a typical 3 bedroom French home and highlights the potential savings that can be achieved with Panasonic's Aquarea heat pump.*

Building data	
Address	Reims (French)
Building area	125 m ²
Standard heating requirement	11,3 kW
Internal gains	5.625 kWh/year
Solar gains (windows)	4.500 kWh/year
Indoor design temperature	20°C
Outdoor temperature limit for heating 'ON'	15°C
Heat distribution	Underfloor heating by 100 % Radiator heating by -- % Wall heating by -- %
Maximum flow water temperature	55°C
Maximum return water temperature	50°C
Solar collector area	-- m ²

Service hot water	
Type of service	Hot water with heat pump
Tank volume	300 Litre
Average daily need	200 Litre
Cold water inlet temperature	10°C
Target tank temperature	50°C
Exchange loss	5 K
Electrical auxiliary heating necessary	No

Used Panasonic heat pump	
Description	WH-SXF12D6E5
Sanitary tank	WH-TD30E3E5
Heat pump type	Air / Water
Wattage at 2/35	Heat: 11,7 kW, Electric: 3,4 kW
Recommended flow-through of air	4800,0 m ³ /h
Max. flow temperature	55°C
Mode of operation	Monovalent
Design/Bivalent temperature	-5,0°C
Number of heat pumps used	1
Wattage of fan (included in heat pump performance data: yes)	60 W
Wattage of heat circulation pump(s)	180 W

* Calculations were carried using Panasonic's Aquarea Designer software, available from the PRO Club website (www.panasonicproclub.com).

Rate data		
Description	French (Panasonic)	
Shut off times total	0,0 h/day	
Weekends with shut off times	Yes	
Daytime rate of heat pump	Time for daytime rate	
	5-19 o'clock	14,0 pence/kWh
Nighttime rate of heat pump	Time for nighttime rate	
	19-5 o'clock	14,0 pence/kWh
Heat circulation pump(s)	Like heat pump: yes	-- pence/kWh
Heating element for monoenergetic operation	Like heat pump: yes	-- pence/kWh
Heating element for post heating of hot water	Like heat pump: yes	-- pence/kWh

Climatic data				
Climatic location	Reims (FR)			
Monthly average temperatures in °C	Jan	3,4	Jul	16,0
	Feb	3,6	Aug	15,9
	Mar	5,7	Sep	13,7
	Apr	8,0	Oct	10,4
	May	11,2	Nov	6,7
	Jun	14,1	Dec	4,6

Calculation results

Monthly heat consumption in kWh

Annual energy costs	
Caused by heat producers	
Heat pump	1.600 €
Hot water heating rod	0 €
Caused by heat consumers	
Space heating	1.220 €
Service hot water	225 €
Heat circulation pump(s)	155 €
Total	1.600 €

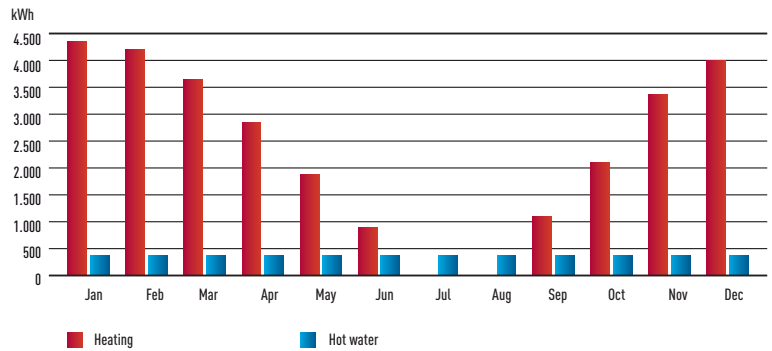

Aquarea energy coverage

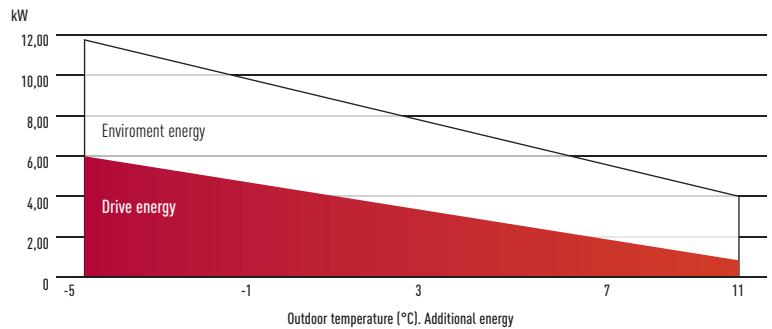

Comparison of running costs

Operational costs				
Type of heating	Price in pence/kWh	Efficiency (%)	Additional costs in €/year	Total costs in €/year
Heat pump	-	-	0	1.600
Oil	6,5	85	0	3.050
Gas	4,0	90	0	1.868
Wood heating	5,0	80	0	2.539
Electric night storage heater	12,0	100	0	4.455
Electric heating element	14,0	100	0	5.197

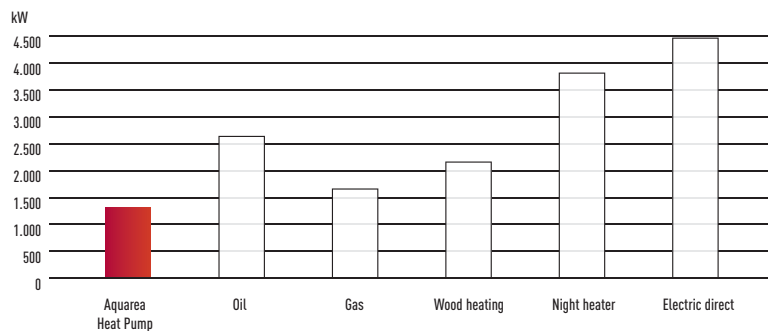

Comparison of CO₂ emissions

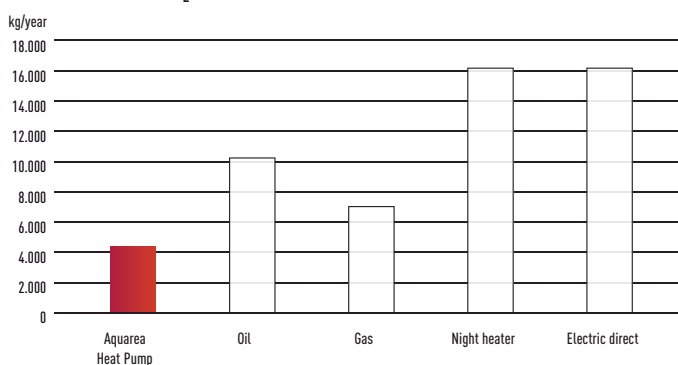

Comparison of CO₂ savings

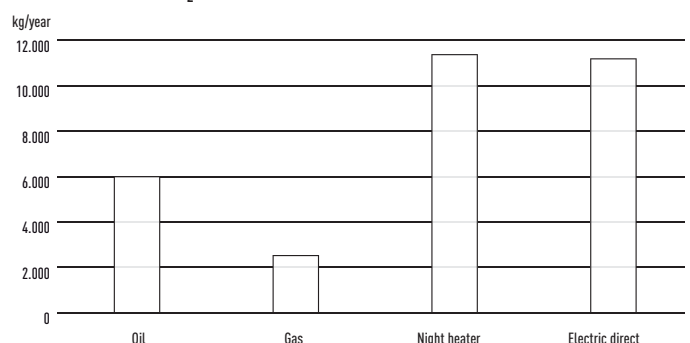

Heating capacity table based on outlet temperature and outside temperature

Heating capacity Curve

Aquarea. High Performance. Bi-Bloc Single Phase. Heating Only - SDF. Heating and Cooling - SDC. 3 and 5kW

WH-SDF03E3E5 / WH-SDC03E3E5

Tamb	HC	IP	COP	HC	IP	COP	HC	IP	COP	HC	IP	COP	HC	IP	COP	HC	IP	COP
LWC	30	30	30	35	35	35	40	40	40	45	45	45	50	50	50	55	55	55
-15	3,20	1,39	2,30	3,20	1,39	2,30	3,00	1,64	1,83	3,00	1,64	1,83	2,75	1,92	1,43	2,75	1,92	1,43
-7	3,20	1,19	2,69	3,20	1,19	2,69	3,20	1,48	2,16	3,20	1,48	2,16	3,20	1,86	1,72	3,20	1,86	1,72
2	3,20	0,90	3,56	3,20	0,90	3,56	3,20	1,16	2,76	3,20	1,16	2,76	3,20	1,49	2,15	3,20	1,49	2,15
7	3,20	0,64	5,00	3,20	0,64	5,00	3,20	0,89	3,60	3,20	0,89	3,60	3,20	1,20	2,67	3,20	1,20	2,67

WH-SDF05E3E5 / WH-SDC05E3E5

Tamb	HC	IP	COP	HC	IP	COP	HC	IP	COP	HC	IP	COP	HC	IP	COP	HC	IP	COP
LWC	30	30	30	35	35	35	40	40	40	45	45	45	50	50	50	55	55	55
-15	4,20	1,94	2,16	4,20	1,94	2,16	3,4	1,98	1,72	3,40	1,98	1,72	3,00	2,12	1,42	3,00	2,12	1,42
-7	4,20	1,62	2,59	4,20	1,62	2,59	3,8	1,82	2,09	3,80	1,82	2,09	3,55	2,08	1,71	3,55	2,08	1,71
2	4,20	1,35	3,11	4,20	1,35	3,11	4,2	1,65	2,55	4,20	1,65	2,55	4,10	2,07	1,98	4,10	2,07	1,98
7	5,00	1,08	4,63	5,00	1,08	4,63	5,00	1,48	3,38	5,00	1,48	3,38	5,00	1,89	2,65	5,00	1,89	2,65

Cooling Capacity Curve

Aquarea. High Performance. Bi-Bloc Single Phase. Heating and Cooling - SDC. 3 and 5kW

MODELS WH-SDC03E3E5

Tamb	CC	IP	CC	IP	CC	IP	CC	IP	CC	IP	CC	IP
LWC	7	7	14	14	18	18	7	7	14	14	18	18
18	2,40	0,42	4,40	0,73	3,70	0,49	4,50	0,89	5,00	0,90	5,70	0,90
25	3,20	0,73	4,10	0,86	3,50	0,59	5,00	1,43	6,30	1,50	5,40	1,06
35	3,20	1,04	3,90	1,07	3,30	0,74	4,50	1,67	5,50	1,68	5,00	1,33
43	2,90	1,20	3,50	1,20	3,00	0,88	3,30	1,53	4,10	1,52	4,40	1,53

Tamb: Ambient Temperature (°C). LWC: Leaving Water Condenser Temperature (°C). HC: Heating capacity (kW). CC: Cooling Capacity (kW). IP: Power Input (kW)
This data is measured by Panasonic in accordance with EN14511-2 standard. This data is for reference purpose only, and does not guarantee the performance.

Hydraulic Pump Performance. Constant Pressure Head Difference ($\Delta p-c$). 3 and 5kW

WH-SDF03E3E5 // WH-SDF05E3E5 // WH-SDC03E3E5 // WH-SDC05E3E5

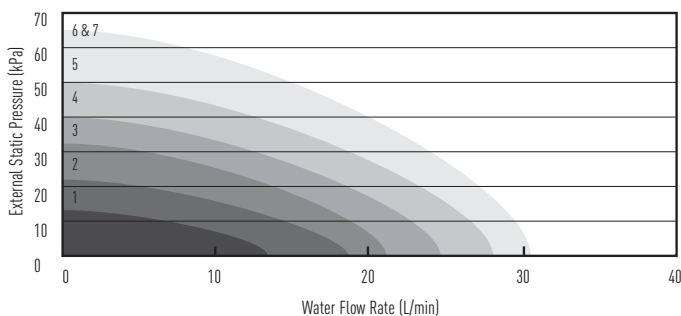

A $\Delta p-c$
When pressure loss of system increased, pump speed will be reduced for maintain constant pressure.

Hydraulic Pump Performance. Variable Pressure Head Difference ($\Delta p-v$). 3 and 5kW

WH-SDF03E3E5 // WH-SDF05E3E5 // WH-SDC03E3E5 // WH-SDC05E3E5

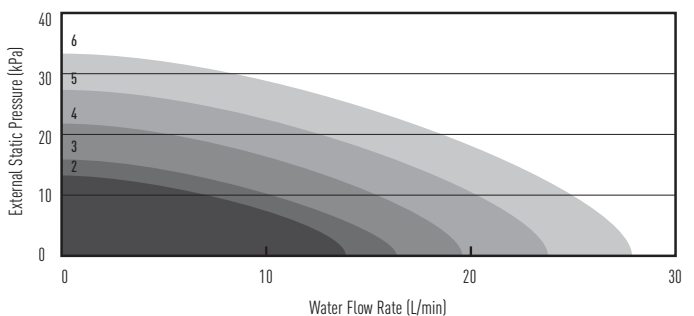

A $\Delta p-v$
When pressure loss of system increased, pump speed will be reduced for maintain pressure according to water flow rate.

Heating capacity Curve

Aquarea. High Performance. Mono-Bloc Single Phase. Heating Only - MDF. Heating and Cooling - MDC. 5, 6 and 9kW

WH-MDC05F3E5																			
Tamb	HC	IP	COP	HC	IP	COP	HC	IP	COP	HC	IP	COP	HC	IP	COP	HC	IP	COP	
LWC	30	30	30	35	35	35	40	40	40	45	45	45	50	50	50	55	55	55	
-15	5,00	1,82	2,75	5,00	1,95	2,56	5,00	2,20	2,27	5,00	2,45	2,04	5,00	2,70	1,85	5,00	2,95	1,69	
-7	4,50	1,44	3,13	4,50	1,51	2,98	4,50	1,64	2,74	4,50	1,78	2,53	4,50	1,94	2,32	4,30	2,12	2,03	
2	4,80	1,22	3,93	4,80	1,28	3,75	4,80	1,40	3,43	4,50	1,52	2,96	4,30	1,57	2,14	4,00	1,72	2,33	
7	5,00	0,91	5,49	5,00	0,99	5,08	5,00	1,13	4,42	5,00	1,26	3,97	5,00	1,44	3,47	5,00	1,63	3,07	
25	5,00	0,67	7,46	5,00	0,71	7,04	5,00	0,78	6,41	5,00	0,86	5,81	5,00	0,98	5,10	5,00	1,10	4,55	

WH-MDF06E3E5 / WH-MDC06E3E5																			
Tamb	HC	IP	COP	HC	IP	COP	HC	IP	COP	HC	IP	COP	HC	IP	COP	HC	IP	COP	
LWC	30	30	30	35	35	35	40	40	40	45	45	45	50	50	50	55	55	55	
-15	6,15	2,50	2,46	5,90	2,66	2,22	5,65	2,82	2,00	5,40	2,98	1,81	5,20	3,15	1,65	5,00	3,32	1,51	
-7	5,18	1,68	3,09	5,15	1,92	2,68	5,13	2,17	2,37	5,10	2,41	2,12	5,45	2,81	1,94	5,80	3,20	1,81	
2	5,00	1,23	4,08	5,00	1,45	3,45	5,00	1,68	2,99	5,00	1,90	2,63	5,00	2,19	2,28	5,00	2,48	2,02	
7	6,00	1,13	5,33	6,00	1,35	4,46	6,00	1,58	3,81	6,00	1,80	3,33	6,00	2,09	2,87	6,00	2,38	2,52	
25	7,30	0,78	9,42	7,10	0,93	7,63	6,90	1,09	6,36	6,70	1,24	5,40	6,50	1,41	4,61	6,30	1,58	3,99	

WH-MDF09E3E5 / WH-MDC09E3E5																			
Tamb	HC	IP	COP	HC	IP	COP	HC	IP	COP	HC	IP	COP	HC	IP	COP	HC	IP	COP	
LWC	30	30	30	35	35	35	40	40	40	45	45	45	50	50	50	55	55	55	
-15	7,90	3,62	2,19	7,60	3,77	2,02	7,30	3,93	1,86	7,00	4,08	1,72	6,45	4,06	1,59	5,90	4,03	1,46	
-7	7,80	3,38	2,31	7,70	3,63	2,12	7,60	3,88	1,96	7,50	4,13	1,82	7,55	4,59	1,64	7,60	5,05	1,50	
2	7,00	2,01	3,49	2,45	2,37	3,14	7,00	2,60	2,70	7,00	2,89	2,42	7,00	3,37	2,08	7,00	3,85	1,82	
7	9,00	1,87	4,83	9,00	2,17	4,16	9,00	2,48	3,64	9,00	2,78	3,24	8,95	3,31	2,70	8,90	3,84	2,32	
25	9,00	0,99	9,09	9,00	1,31	6,87	9,00	1,63	5,52	9,00	1,95	4,62	9,00	2,20	4,09	9,00	2,45	3,67	

Cooling Capacity Curve

Aquarea. High Performance. Mono-Bloc Single Phase. Heating and Cooling - MDC. 5, 6 and 9kW

MODELS	WH-MDC05F3E5						WH-MDC06E3E5						WH-MDC09E3E5						
	Tamb	CC	IP	CC	IP	CC	Tamb	CC	IP	CC	IP	CC	Tamb	CC	IP	CC	IP	CC	IP
LWC	7	7	14	14	18	18	7	7	14	14	18	18	7	7	14	14	18	18	18
18	1,95	0,45	2,20	0,45	2,45	0,50	4,64	0,91	5,83	0,99	6,74	0,94	5,36	1,05	6,12	1,08	7,02	1,08	1,08
25	5,00	1,25	6,30	1,20	6,30	0,80	5,85	1,43	9,55	1,73	9,81	1,68	6,44	1,85	10,50	2,51	11,16	2,52	2,52
35	4,50	1,35	5,10	1,50	5,00	1,00	5,50	2,03	6,70	2,06	7,30	2,05	7,00	2,90	8,40	2,95	9,00	3,00	3,00
43	3,75	1,75	4,50	1,80	4,25	1,20	4,56	2,34	6,31	2,47	7,14	2,45	5,32	3,18	6,34	2,48	6,78	2,46	2,46

Tamb: Ambient Temperature (°C). LWC: Leaving Water Condenser Temperature (°C). HC: Heating capacity (kW). CC: Cooling Capacity (kW). IP: Power Input (kW)
 This data is measured by Panasonic in accordance with EN14511-2 standard. This data is for reference purpose only, and does not guarantee the performance.

Hydraulic pump performance of the F type Heat Pumps: A class pump F (5 kW and 16 kW)

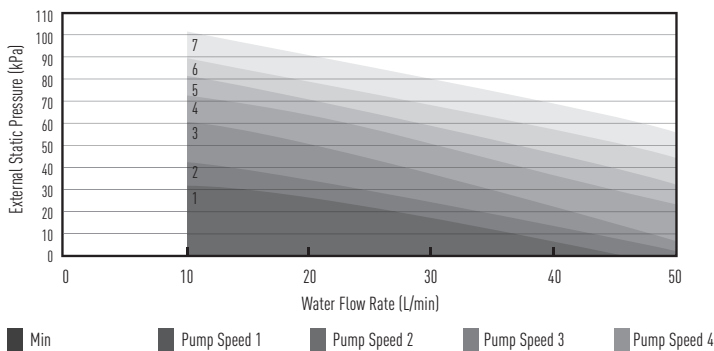

Hydraulic pump performance of the F type Heat Pumps: A class pump F (5 kW and 16 kW)

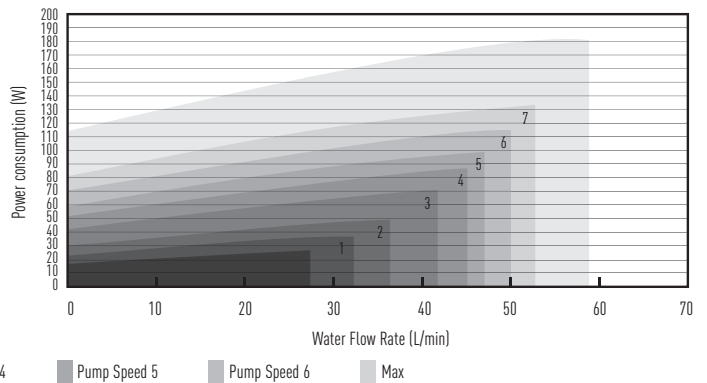

Hydraulic Pump Performance. Constant Pressure Head Difference (Δp-c)

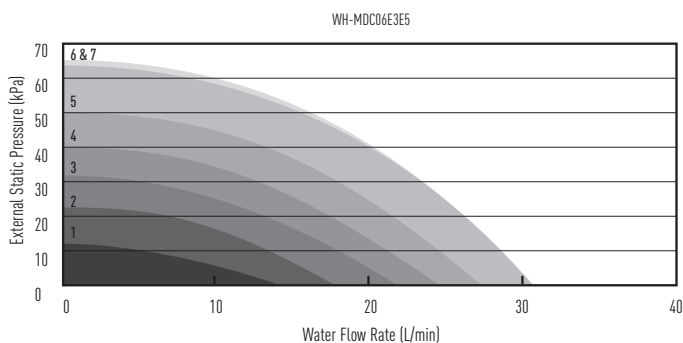

A Δp-c
 When pressure loss of system increased, pump speed will be reduced for maintain constant pressure.

Hydraulic Pump Performance. Variable Pressure Head Difference (Δp-c)

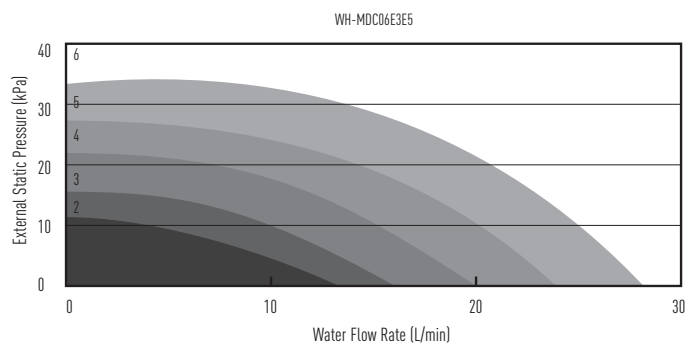

A Δp-c
 When pressure loss of system increased, pump speed will be reduced for maintain pressure according to water flow rate.

Heating capacity table based on outlet temperature and outside temperature

Heating capacity Curve

Aquarea. High Performance. Bi-Bloc Single Phase / Three Phase. Heating and Cooling. SDC

WH-SDC07F3E5																			
Tamb	HC	IP	COP	HC	IP	COP	HC	IP	COP	HC	IP	COP	HC	IP	COP	HC	IP	COP	
LWC	30	30	30	35	35	35	40	40	40	45	45	45	50	50	50	55	55	55	
-15	4,60	1,85	2,49	4,60	1,98	2,32	4,60	2,17	2,12	4,60	2,40	1,92	4,55	2,66	1,71	4,50	2,98	1,51	
-7	5,15	1,78	2,89	5,15	1,92	2,68	5,08	2,12	2,40	5,00	2,36	2,12	4,90	2,45	2,00	4,80	2,65	1,81	
2	6,70	1,81	3,70	6,55	1,96	3,34	6,58	2,27	2,90	6,60	2,62	2,52	6,30	2,88	2,19	6,00	3,14	1,91	
7	7,00	1,41	4,96	7,00	1,57	4,46	7,00	1,75	4,00	7,00	2,10	3,33	6,90	2,28	3,03	6,80	2,70	2,52	
25	7,00	0,77	9,09	7,00	0,91	7,69	6,40	1,01	6,34	6,10	1,15	5,30	5,90	1,31	4,50	5,70	1,47	3,88	

WH-SDC09F3E5																			
Tamb	HC	IP	COP	HC	IP	COP	HC	IP	COP	HC	IP	COP	HC	IP	COP	HC	IP	COP	
LWC	30	30	30	35	35	35	40	40	40	45	45	45	50	50	50	55	55	55	
-15	6,00	2,53	2,37	5,90	2,66	2,22	5,50	2,80	1,96	5,40	2,98	1,81	5,20	3,12	1,67	5,00	3,31	1,51	
-7	6,10	2,14	2,85	5,90	2,34	2,52	5,85	2,61	2,24	5,80	2,88	2,01	5,80	3,04	1,91	5,80	3,21	1,81	
2	6,80	1,85	3,68	6,70	2,14	3,13	6,70	2,36	2,84	6,60	2,62	2,52	6,30	2,88	2,19	6,00	3,14	1,91	
7	9,00	1,91	4,71	9,00	2,18	4,13	9,00	2,43	3,70	9,00	2,79	3,23	8,95	3,21	2,79	8,90	3,85	2,31	
25	9,00	1,05	8,57	9,00	1,25	7,20	8,40	1,38	6,09	8,00	1,57	5,10	7,80	1,79	4,36	7,50	2,01	3,73	

WH-SDC12F6E5																			
Tamb	HC	IP	COP	HC	IP	COP	HC	IP	COP	HC	IP	COP	HC	IP	COP	HC	IP	COP	
LWC	30	30	30	35	35	35	40	40	40	45	45	45	50	50	50	55	55	55	
-15	9,30	3,46	2,69	8,90	3,62	2,46	8,50	3,79	2,24	8,10	3,95	2,05	7,50	4,05	1,85	7,00	4,16	1,68	
-7	10,40	3,37	3,09	10,00	3,66	2,73	9,60	3,86	2,49	9,20	4,06	2,27	8,70	4,16	2,09	8,20	4,27	1,92	
2	11,80	3,10	3,81	11,40	3,31	3,44	11,00	3,53	3,12	10,60	3,74	2,83	9,80	3,94	2,49	9,10	4,14	2,20	
7	12,00	2,10	5,71	12,00	2,53	4,74	12,00	2,96	4,05	12,00	3,39	3,54	12,00	3,78	3,17	12,00	4,16	2,88	
25	12,00	1,38	8,70	12,00	1,66	7,23	11,80	1,94	6,08	11,70	2,23	5,25	11,50	2,49	4,62	11,40	2,74	4,16	

WH-SDC16F6E5																			
Tamb	HC	IP	COP	HC	IP	COP	HC	IP	COP	HC	IP	COP	HC	IP	COP	HC	IP	COP	
LWC	30	30	30	35	35	35	40	40	40	45	45	45	50	50	50	55	55	55	
-15	10,60	4,09	2,59	10,30	4,38	2,35	10,00	4,67	2,14	9,70	4,96	1,96	8,80	4,94	1,78	7,90	4,91	1,61	
-7	11,90	4,03	2,95	11,40	4,26	2,68	10,80	4,46	2,42	10,30	4,66	2,21	9,60	4,81	2,00	9,00	4,95	1,82	
2	13,50	3,74	3,61	13,00	3,96	3,28	12,40	4,18	2,97	11,90	4,40	2,70	10,80	4,46	2,42	9,80	4,51	2,17	
7	16,00	3,21	4,98	16,00	3,74	4,28	16,00	4,27	3,75	16,00	4,80	3,33	15,20	5,11	2,97	14,50	5,41	2,68	
25	16,00	2,31	6,93	16,00	2,69	5,95	16,00	3,07	5,21	16,00	3,45	4,64	16,00	3,67	4,36	15,90	3,89	4,09	

WH-SDC09F3E8																			
Tamb	HC	IP	COP	HC	IP	COP	HC	IP	COP	HC	IP	COP	HC	IP	COP	HC	IP	COP	
LWC	30	30	30	35	35	35	40	40	40	45	45	45	50	50	50	55	55	55	
-15	8,65	3,06	2,83	8,30	3,21	2,59	7,95	3,41	2,33	7,60	3,61	2,11	7,15	3,71	1,93	6,70	3,81	1,76	
-7	9,35	2,91	3,21	9,00	3,16	2,85	8,85	3,46	2,56	8,70	3,76	2,31	8,30	3,81	2,18	7,90	3,86	2,05	
2	9,31	2,35	3,96	9,00	2,51	3,59	9,00	2,78	3,24	9,00	3,05	2,95	8,90	3,49	2,55	8,80	3,94	2,23	
7	9,00	1,54	5,84	9,00	1,86	4,84	9,00	2,16	4,17	9,00	2,46	3,66	9,00	2,76	3,26	9,00	3,06	2,94	
25	9,00	1,05	8,57	9,00	1,24	7,26	8,73	1,44	6,06	8,46	1,64	5,16	8,28	1,82	4,55	8,10	2,00	4,05	

WH-SDC12F9E8																			
Tamb	HC	IP	COP	HC	IP	COP	HC	IP	COP	HC	IP	COP	HC	IP	COP	HC	IP	COP	
LWC	30	30	30	35	35	35	40	40	40	45	45	45	50	50	50	55	55	55	
-15	9,30	3,46	2,69	8,90	3,62	2,46	8,50	3,79	2,24	8,10	3,95	2,05	7,50	4,05	1,85	7,00	4,16	1,68	
-7	10,40	3,37	3,09	10,00	3,66	2,73	9,60	3,86	2,49	9,20	4,06	2,27	8,70	4,16	2,09	8,20	4,27	1,92	
2	11,80	3,10	3,81	11,40	3,31	3,44	11,00	3,53	3,12	10,60	3,74	2,83	9,80	3,94	2,49	9,10	4,14	2,20	
7	12,00	2,10	5,71	12,00	2,53	4,74	12,00	2,96	4,05	12,00	3,39	3,54	12,00	3,78	3,17	12,00	4,16	2,88	
25	12,00	1,38	8,70	12,00	1,66	7,23	11,80	1,94	6,08	11,70	2,23	5,25	11,50	2,49	4,62	11,40	2,74	4,16	

WH-SDC16F9E8																			
Tamb	HC	IP	COP	HC	IP	COP	HC	IP	COP	HC	IP	COP	HC	IP	COP	HC	IP	COP	
LWC	30	30	30	35	35	35	40	40	40	45	45	45	50	50	50	55	55	55	
-15	10,60	4,09	2,59	10,30	4,38	2,35	10,00	4,67	2,14	9,70	4,96	1,96	8,80	4,94	1,78	7,90	4,91	1,61	
-7	11,90	4,03	2,95	11,40	4,26	2,68	10,80	4,46	2,42	10,30	4,66	2,21	9,60	4,81	2,00	9,00	4,95	1,82	
2	13,50	3,74	3,61	13,00	3,96	3,28	12,40	4,18	2,97	11,90	4,40	2,70	10,80	4,46	2,42	9,80	4,51	2,17	
7	16,00	3,21	4,98	16,00	3,74	4,28	16,00	4,27	3,75	16,00	4,80	3,33	15,20	5,11	2,97	14,50	5,41	2,68	
25	16,00	2,31	6,93	16,00	2,69	5,95	16,00	3,07	5,21	16,00	3,45	4,64	16,00	3,67	4,36	15,90	3,89	4,09	

Cooling Capacity Curve

Aquarea. High Performance. Bi-Bloc Single Phase / Three Phase. Heating and Cooling. SDC

MODELS	WH-SDC07F3E5		WH-SDC09F3E5		WH-SDC12F6E5		WH-SDC16F6E5		WH-SDC09F3E8		WH-SDC12F9E8		WH-SDC16F9E8	
	CC	IP	CC	IP	CC	IP	CC	IP	CC	IP	CC	IP	CC	IP
LWC	7	7	7	7	7	7	7	7	7	7	7	7	7	7
16	5,09	0,86	5,93	1,05	7,65	1,26	9,62	1,59	5,90	0,97	7,65	1,26	9,62	1,59
25	6,58	1,73	7,79	2,23	9,20	2,26	10,51	2,81	7,45	1,55	9,20	2,26	10,51	2,81
35	6,00	2,28	7,00	2,88	10,00	3,56	12,20	4,76	7,00	2,21	10,00	3,56	12,20	4,76
43	5,14	2,67	6,20	3,26	7,60	3,91	10,08	5,43	5,80	2,55	7,60	3,91	10,08	5,43

Tamb: Ambient Temperature (°C). LWC: Leaving Water Condenser Temperature (°C). HC: Heating capacity (kW). CC: Cooling Capacity (kW). IP: Power Input (kW)
 This data is measured by Panasonic in accordance with EN14511-2 standard. This data is for reference purpose only, and does not guarantee the performance.

Hydraulic pump performance of the F type Heat Pumps: A class pump F (5 kW and 16 kW)

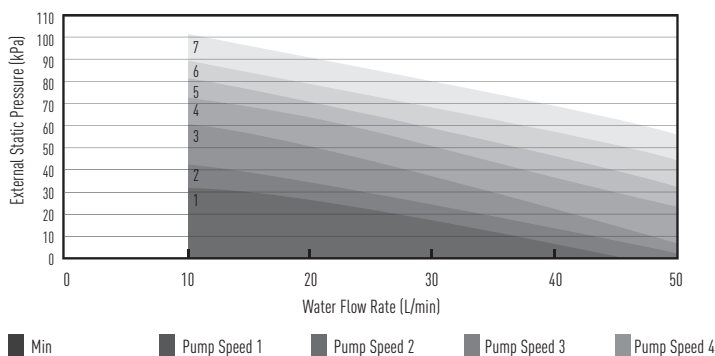

Hydraulic pump performance of the F type Heat Pumps: A class pump F (5 kW and 16 kW)

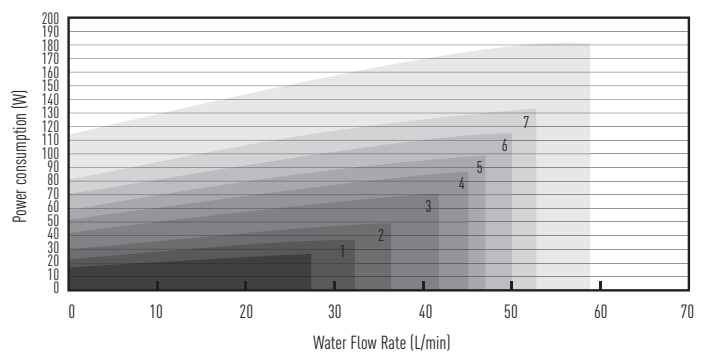

Heating capacity table based on outlet temperature and outside temperature

Heating capacity Curve

Aqueara High Performance. Mono-Bloc Single Phase / Three Phase Heating Only - MDF / Heating and Cooling - MDC

WH-MDF12C6E5 / WH-MDC12C6E5

Tamb	HC	IP	COP	HC	IP	COP	HC	IP	COP	HC	IP	COP	HC	IP	COP	HC	IP	COP
LWC	30	30	30	35	35	35	40	40	40	45	45	45	50	50	50	55	55	55
-15	9,30	3,50	2,66	8,90	3,66	2,43	8,50	3,83	2,22	8,10	3,99	2,03	7,50	4,09	1,83	7,00	4,20	1,67
-7	10,40	3,41	3,05	10,00	3,70	2,70	9,60	3,90	2,46	9,20	4,10	2,24	8,70	4,20	2,07	8,20	4,31	1,90
2	11,80	3,14	3,76	11,40	3,34	3,41	11,00	3,57	3,08	10,60	3,78	2,80	9,80	3,98	2,46	9,10	4,18	2,18
7	12,00	2,14	5,61	12,00	2,57	4,67	12,00	3,00	4,00	12,00	3,43	3,50	12,00	3,82	3,14	12,00	4,20	2,86
25	12,00	1,42	8,45	12,00	1,70	7,06	11,80	1,98	5,96	11,70	2,27	5,15	11,50	2,53	4,55	11,40	2,78	4,10

WH-MDF16C6E5 / WH-MDC16C6E5

Tamb	HC	IP	COP	HC	IP	COP	HC	IP	COP	HC	IP	COP	HC	IP	COP	HC	IP	COP
LWC	30	30	30	35	35	35	40	40	40	45	45	45	50	50	50	55	55	55
-15	10,60	4,13	2,57	10,30	4,42	2,33	10,00	4,71	2,12	9,70	5,00	1,94	8,80	4,98	1,77	7,90	4,95	1,60
-7	11,90	4,07	2,92	11,40	4,30	2,65	10,80	4,50	2,40	10,30	4,70	2,19	9,60	4,85	1,98	9,00	4,99	1,80
2	13,50	3,78	3,57	13,00	4,00	3,25	12,40	4,22	2,94	11,90	4,44	2,68	10,80	4,50	2,40	9,80	4,55	2,15
7	16,00	3,25	4,92	16,00	3,78	4,23	16,00	4,31	3,71	16,00	4,84	3,31	15,20	5,15	2,95	14,50	5,45	2,66
25	16,00	2,35	6,81	16,00	2,73	5,86	16,00	3,11	5,14	16,00	3,49	4,58	16,00	3,71	4,31	15,90	3,93	4,05

WH-MDF09C3E8 / WH-MDC09C3E8

Tamb	HC	IP	COP	HC	IP	COP	HC	IP	COP	HC	IP	COP	HC	IP	COP	HC	IP	COP
LWC	30	30	30	35	35	35	40	40	40	45	45	45	50	50	50	55	55	55
-15	8,65	3,10	2,79	8,30	3,25	2,55	7,95	3,45	2,30	7,60	3,65	2,08	7,15	3,75	1,91	6,70	3,85	1,74
-7	9,35	2,95	3,17	9,00	3,20	2,81	8,85	3,50	2,53	8,70	3,80	2,29	8,30	3,85	2,16	7,90	3,90	2,03
2	9,31	2,39	3,90	9,00	2,55	3,53	9,00	2,82	3,19	9,00	3,09	2,91	8,90	3,53	2,52	8,80	3,98	2,21
7	9,00	1,58	5,70	9,00	1,90	4,74	9,00	2,20	4,09	9,00	2,50	3,60	9,00	2,80	3,21	9,00	3,10	2,90
25	9,00	1,09	8,26	9,00	1,28	7,03	8,73	1,48	5,90	8,46	1,68	5,04	8,28	1,86	4,45	8,10	2,04	3,97

WH-MDF12C9E8 / WH-MDC12C9E8

Tamb	HC	IP	COP	HC	IP	COP	HC	IP	COP	HC	IP	COP	HC	IP	COP	HC	IP	COP
LWC	30	30	30	35	35	35	40	40	40	45	45	45	50	50	50	55	55	55
-15	9,30	3,50	2,66	8,90	3,66	2,43	8,50	3,83	2,22	8,10	3,99	2,03	7,50	4,09	1,83	7,00	4,20	1,67
-7	10,40	3,41	3,05	10,00	3,70	2,70	9,60	3,90	2,46	9,20	4,10	2,24	8,70	4,20	2,07	8,20	4,31	1,90
2	11,80	3,14	3,76	11,40	3,34	3,41	11,00	3,57	3,08	10,60	3,78	2,80	9,80	3,98	2,46	9,10	4,18	2,18
7	12,00	2,14	5,61	12,00	2,57	4,67	12,00	3,00	4,00	12,00	3,43	3,50	12,00	3,82	3,14	12,00	4,20	2,86
25	12,00	1,42	8,45	12,00	1,70	7,06	11,80	1,98	5,96	11,70	2,27	5,15	11,50	2,53	4,55	11,40	2,78	4,10

WH-MDF16C9E8 / WH-MDC16C9E8

Tamb	HC	IP	COP	HC	IP	COP	HC	IP	COP	HC	IP	COP	HC	IP	COP	HC	IP	COP
LWC	30	30	30	35	35	35	40	40	40	45	45	45	50	50	50	55	55	55
-15	10,60	4,13	2,57	10,30	4,42	2,33	10,00	4,71	2,12	9,70	5,00	1,94	8,80	4,98	1,77	7,90	4,95	1,60
-7	11,90	4,07	2,92	11,40	4,30	2,65	10,80	4,50	2,40	10,30	4,70	2,19	9,60	4,85	1,98	9,00	4,99	1,80
2	13,50	3,78	3,57	13,00	4,00	3,25	12,40	4,22	2,94	11,90	4,44	2,68	10,80	4,50	2,40	9,80	4,55	2,15
7	16,00	3,25	4,92	16,00	3,78	4,23	16,00	4,31	3,71	16,00	4,84	3,31	15,20	5,15	2,95	14,50	5,45	2,66
25	16,00	2,35	6,81	16,00	2,73	5,86	16,00	3,11	5,14	16,00	3,49	4,58	16,00	3,71	4,31	15,90	3,93	4,05

Cooling Capacity Curve

Aqueara High Performance. Mono-Bloc Single Phase / Three Phase Heating and Cooling - MDC

Models

Tamb	WH-MDC09			WH-MDC12			WH-MDC16		
	CC	IP	EER	CC	IP	EER	CC	IP	EER
16	5,90	1,01	5,84	7,65	1,30	5,88	9,62	1,63	5,90
25	7,45	1,59	4,69	9,20	2,30	4,00	10,51	2,85	3,69
35	7,00	2,25	3,11	10,00	3,60	2,78	12,20	4,80	2,54
43	5,80	2,59	2,24	7,60	3,95	1,92	10,08	5,47	1,84

Hydraulic Pump Performance. 9 kW single phase

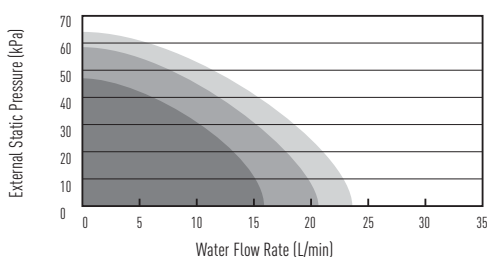

Low Speed (I) Medium Speed (II) High Speed (III)

Hydraulic Pump Performance. MDC 12 to MDC 16 single phase and all MDC three phase

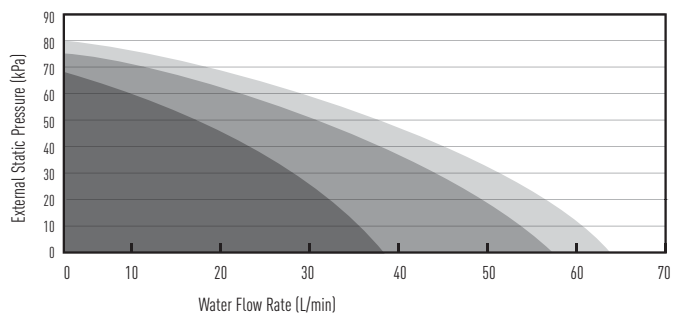

Pump Speed (I) Pump Speed (II) Pump Speed (III)

Heating Capacity Curve

Aquarea T-CAP. Mono-Bloc Single Phase / Three Phase Heating Only - MXF / Heating and Cooling - MXC

WH-MXF09D3E5 / WH-MXC09D3E5

Tamb	HC	IP	COP	HC	IP	COP	HC	IP	COP	HC	IP	COP	HC	IP	COP	HC	IP	COP
LWC	30	30	30	35	35	35	40	40	40	45	45	45	50	50	50	55	55	55
-15	9,00	3,28	2,74	9,00	3,55	2,54	9,00	3,95	2,28	9,00	4,34	2,07	9,00	4,77	1,89	9,00	5,20	1,73
-7	9,00	2,75	3,27	9,00	3,20	2,81	9,00	3,66	2,46	9,00	4,11	2,19	9,00	4,31	2,09	9,00	4,50	2,00
2	9,00	2,40	3,75	9,00	2,55	3,53	9,00	2,82	3,19	9,00	3,09	2,91	9,00	3,60	2,50	9,00	4,11	2,19
7	9,00	1,68	5,36	9,00	1,90	4,74	9,00	2,20	4,09	9,00	2,50	3,60	9,00	2,80	3,21	9,00	3,10	2,90
25	13,60	1,54	8,83	13,60	1,75	7,77	13,20	1,97	6,70	12,80	2,18	5,87	12,00	2,45	4,90	11,20	2,71	4,13

WH-MXF12D6E5 / WH-MXC12D6E5

Tamb	HC	IP	COP	HC	IP	COP	HC	IP	COP	HC	IP	COP	HC	IP	COP	HC	IP	COP
LWC	30	30	30	35	35	35	40	40	40	45	45	45	50	50	50	55	55	55
-15	12,00	4,79	2,51	12,00	5,00	2,40	11,50	5,21	2,21	11,00	5,42	2,03	10,70	5,86	1,83	10,50	6,30	1,67
-7	12,00	3,89	3,08	12,00	4,45	2,70	12,00	5,02	2,39	12,00	5,58	2,15	12,00	5,94	2,02	12,00	6,30	1,90
2	12,00	3,23	3,72	12,00	3,53	3,40	12,00	3,91	3,07	12,00	4,29	2,80	12,00	4,90	2,45	12,00	5,51	2,18
7	12,00	2,22	5,41	12,00	2,57	4,67	12,00	3,00	4,00	12,00	3,43	3,50	12,00	3,82	3,14	12,00	4,20	2,86
25	13,60	1,59	8,55	13,60	1,80	7,56	13,40	2,14	6,26	13,20	2,47	5,34	12,60	2,70	4,67	12,00	2,93	4,10

WH-MXF09D3E8 / WH-MXC09D3E8

Tamb	HC	IP	COP	HC	IP	COP	HC	IP	COP	HC	IP	COP	HC	IP	COP	HC	IP	COP
LWC	30	30	30	35	35	35	40	40	40	45	45	45	50	50	50	55	55	55
-15	9,00	3,28	2,74	9,00	3,55	2,54	9,00	3,95	2,28	9,00	4,34	2,07	9,00	4,77	1,89	9,00	5,20	1,73
-7	9,00	2,75	3,27	9,00	3,20	2,81	9,00	3,66	2,46	9,00	4,11	2,19	9,00	4,31	2,09	9,00	4,50	2,00
2	9,00	2,40	3,75	9,00	2,55	3,53	9,00	2,82	3,19	9,00	3,09	2,91	9,00	3,60	2,50	9,00	4,11	2,19
7	9,00	1,68	5,36	9,00	1,90	4,74	9,00	2,20	4,09	9,00	2,50	3,60	9,00	2,80	3,21	9,00	3,10	2,90
25	13,60	1,54	8,83	13,60	1,75	7,77	13,20	1,97	6,70	12,80	2,18	5,87	12,00	2,45	4,90	11,20	2,71	4,13

WH-MXF12D9E8 / WH-MXC12D9E8

Tamb	HC	IP	COP	HC	IP	COP	HC	IP	COP	HC	IP	COP	HC	IP	COP	HC	IP	COP
LWC	30	30	30	35	35	35	40	40	40	45	45	45	50	50	50	55	55	55
-15	12,00	4,79	2,51	12,00	5,00	2,40	12,00	5,45	2,20	12,00	5,90	2,03	11,50	6,28	1,83	11,10	6,66	1,67
-7	12,00	3,89	3,08	12,00	4,45	2,70	12,00	5,02	2,39	12,00	5,58	2,15	12,00	5,94	2,02	12,00	6,30	1,90
2	12,00	3,23	3,72	12,00	3,53	3,40	12,00	3,91	3,07	12,00	4,29	2,80	12,00	4,90	2,45	12,00	5,51	2,18
7	12,00	2,22	5,41	12,00	2,57	4,67	12,00	3,00	4,00	12,00	3,43	3,50	12,00	3,82	3,14	12,00	4,20	2,86
25	13,60	1,59	8,55	13,60	1,80	7,56	13,40	2,14	6,26	13,20	2,47	5,34	12,60	2,70	4,67	12,00	2,93	4,10

Cooling Capacity Curve

Aquarea T-CAP. Mono-Bloc Single Phase / Three Phase Heating and Cooling - MXC

MODELS WH-MXC09

Tamb	CC	IP	EER	CC	IP	EER
16	7,00	1,40	5,00	7,50	1,45	5,17
25	7,65	1,95	3,92	8,90	2,20	4,05
35	7,00	2,25	3,11	10,00	3,60	2,78
43	6,25	2,70	2,31	8,00	3,05	2,62

Tamb: Ambient Temperature (°C). LWC: Leaving Water Condenser Temperature (°C). HC: Heating capacity (kW). CC: Cooling Capacity (kW). IP: Power Input (kW)
 This data is measured by Panasonic in accordance with EN14511-2 standard. This data is for reference purpose only, and does not guarantee the performance.

Hydraulic Pump Performance. MXC 12 to MXC 16 single phase and all MXC three phase

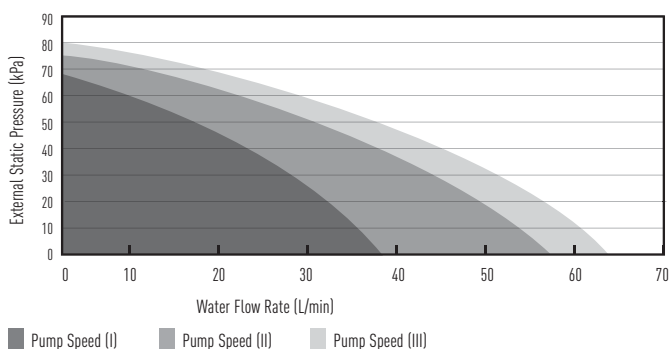

Heating capacity table based on outlet temperature and outside temperature

Heating Capacity Curve

Aquarea T-CAP. Bi-Bloc Single Phase / Three Phase. Heating and Cooling. SXC

WH-SXC09F3E5

Tamb	HC	IP	COP	HC	IP	COP	HC	IP	COP	HC	IP	COP	HC	IP	COP	HC	IP	COP
LWC	30	30	30	35	35	35	40	40	40	45	45	45	50	50	50	55	55	55
-15	9,00	3,24	2,78	9,00	3,51	2,56	9,00	3,91	2,30	9,00	4,30	2,09	9,00	4,73	1,90	9,00	5,16	1,74
-7	9,00	2,71	3,32	9,00	3,16	2,85	9,00	3,62	2,49	9,00	4,07	2,21	9,00	4,27	2,11	9,00	4,46	2,02
2	9,00	2,36	3,81	9,00	2,51	3,59	9,00	2,78	3,24	9,00	3,05	2,95	9,00	3,56	2,53	9,00	4,07	2,21
7	9,00	1,64	5,49	9,00	1,86	4,84	9,00	2,16	4,17	9,00	2,46	3,66	9,00	2,76	3,26	9,00	3,06	2,94
25	13,60	1,50	9,07	13,60	1,71	7,95	13,20	1,93	6,84	12,80	2,14	5,98	12,00	2,41	4,98	11,20	2,67	4,19

WH-SXC12F6E5

Tamb	HC	IP	COP	HC	IP	COP	HC	IP	COP	HC	IP	COP	HC	IP	COP	HC	IP	COP
LWC	30	30	30	35	35	35	40	40	40	45	45	45	50	50	50	55	55	55
-15	12,00	4,75	2,53	12,00	4,96	2,42	11,50	5,17	2,22	11,00	5,38	2,04	10,70	5,82	1,84	10,50	6,26	1,68
-7	12,00	3,85	3,12	12,00	4,41	2,72	12,00	4,98	2,41	12,00	5,54	2,17	12,00	5,90	2,03	12,00	6,26	1,92
2	12,00	3,19	3,76	12,00	3,49	3,44	12,00	3,87	3,10	12,00	4,25	2,82	12,00	4,86	2,47	12,00	5,47	2,19
7	12,00	2,18	5,50	12,00	2,53	4,74	12,00	2,96	4,05	12,00	3,39	3,54	12,00	3,78	3,17	12,00	4,16	2,88
25	13,60	1,55	8,77	13,60	1,76	7,73	13,40	2,10	6,38	13,20	2,43	5,43	12,60	2,66	4,74	12,00	2,89	4,15

WH-SXC09F3E8 / WH-SXC09F9E8

Tamb	HC	IP	COP	HC	IP	COP	HC	IP	COP	HC	IP	COP	HC	IP	COP	HC	IP	COP
LWC	30	30	30	35	35	35	40	40	40	45	45	45	50	50	50	55	55	55
-15	9,00	3,24	2,78	9,00	3,51	2,56	9,00	3,91	2,30	9,00	4,30	2,09	9,00	4,73	1,90	9,00	5,16	1,74
-7	9,00	2,71	3,32	9,00	3,16	2,85	9,00	3,62	2,49	9,00	4,07	2,21	9,00	4,27	2,11	9,00	4,46	2,02
2	9,00	2,36	3,81	9,00	2,51	3,59	9,00	2,78	3,24	9,00	3,05	2,95	9,00	3,56	2,53	9,00	4,07	2,21
7	9,00	1,64	5,49	9,00	1,86	4,84	9,00	2,16	4,17	9,00	2,46	3,66	9,00	2,76	3,26	9,00	3,06	2,94
25	13,60	1,50	9,07	13,60	1,71	7,95	13,20	1,93	6,84	12,80	2,14	5,98	12,00	2,41	4,98	11,20	2,67	4,19

WH-SXC12F9E8

Tamb	HC	IP	COP	HC	IP	COP	HC	IP	COP	HC	IP	COP	HC	IP	COP	HC	IP	COP
LWC	30	30	30	35	35	35	40	40	40	45	45	45	50	50	50	55	55	55
-15	12,00	4,75	2,53	12,00	4,96	2,42	12,00	5,41	2,22	12,00	5,86	2,05	11,50	6,24	1,84	11,10	6,62	1,68
-7	12,00	3,85	3,12	12,00	4,41	2,72	12,00	4,98	2,41	12,00	5,54	2,17	12,00	5,90	2,03	12,00	6,26	1,92
2	12,00	3,19	3,76	12,00	3,49	3,44	12,00	3,87	3,10	12,00	4,25	2,82	12,00	4,86	2,47	12,00	5,47	2,19
7	12,00	2,18	5,50	12,00	2,53	4,74	12,00	2,96	4,05	12,00	3,39	3,54	12,00	3,78	3,17	12,00	4,16	2,88
25	13,60	1,55	8,77	13,60	1,76	7,73	13,40	2,10	6,38	13,20	2,43	5,43	12,60	2,66	4,74	12,00	2,89	4,15

WH-SXC16F9E8

Tamb	HC	IP	COP	HC	IP	COP	HC	IP	COP	HC	IP	COP	HC	IP	COP	HC	IP	COP
LWC	30	30	30	35	35	35	40	40	40	45	45	45	50	50	50	55	55	55
-15	16,00	6,50	2,46	16,00	6,89	2,32	16,00	7,50	2,13	16,00	8,10	1,98	15,60	8,76	1,78	15,20	9,41	1,62
-7	16,00	5,85	2,74	16,00	6,42	2,49	16,00	7,00	2,29	16,00	7,57	2,11	16,00	8,31	1,93	16,00	9,05	1,77
2	16,00	4,59	3,49	16,00	5,16	3,10	16,00	5,74	2,79	16,00	6,31	2,54	16,00	7,10	2,26	16,00	7,88	2,03
7	16,00	3,21	4,98	16,00	3,74	4,28	16,00	4,27	3,75	16,00	4,80	3,33	16,00	5,51	2,91	16,00	6,21	2,58
25	16,00	1,90	8,42	16,00	2,40	6,67	16,00	2,90	5,52	16,00	3,40	4,71	16,00	3,86	4,15	16,00	4,31	3,71

Cooling Capacity Curve

Aquarea T-CAP. Bi-Bloc Single Phase / Three Phase. Cooling. SXC

Models

Tamb	WH-SXC09			WH-SXC12			WH-SXC16		
	CC	IP	EER	CC	IP	EER	CC	IP	EER
16	7,00	1,36	5,15	7,50	1,41	5,32	9,62	1,59	6,05
25	7,65	1,91	4,01	8,90	2,16	4,12	10,51	2,81	3,74
35	7,00	2,21	3,17	10,00	3,56	2,81	12,20	4,76	2,56
43	6,25	2,66	2,35	8,00	3,01	2,66	10,08	5,43	1,86

Tamb: Ambient Temperature (°C). LWC: Leaving Water Condenser Temperature (°C). HC: Heating capacity (kW). CC: Cooling Capacity (kW). IP: Power Input (kW)
This data is measured by Panasonic in accordance with EN14511-2 standard. This data is for reference purpose only, and does not guarantee the performance.

Hydraulic pump performance of the F type Heat Pumps: A class pump F (5 kW and 16 kW)

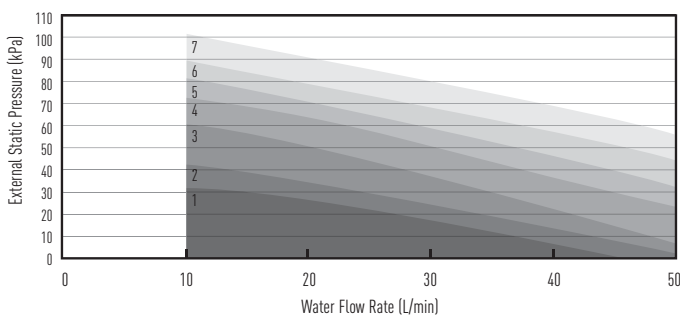

Min Pump Speed 1 Pump Speed 2 Pump Speed 3 Pump Speed 4 Pump Speed 5 Pump Speed 6 Max

Hydraulic pump performance of the F type Heat Pumps: A class pump F (5 kW and 16 kW)

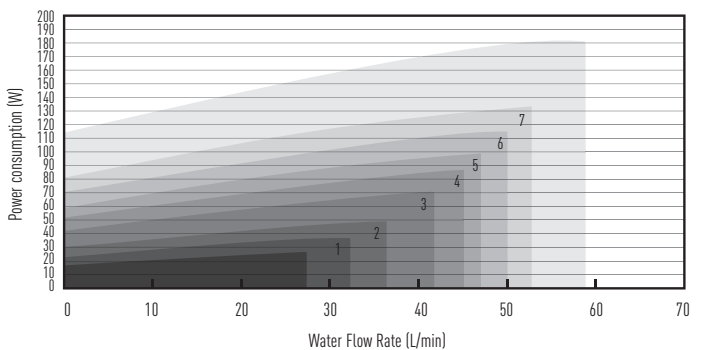

Heating Capacity Curve

Aquarea HT. Bi-Bloc Single Phase / Three Phase. Heating Only - SHF

WH-SHF09F3E5

Tamb	HC	IP	COP	HC	IP	COP	HC	IP	COP	HC	IP	COP	HC	IP	COP	HC	IP	COP	HC	IP	COP	HC	IP	COP
LWC	30	30	30	35	35	35	40	40	40	45	45	45	50	50	50	55	55	55	60	60	60	65	65	65
-15	9,00	3,46	2,60	9,00	3,71	2,43	8,90	4,01	2,22	8,80	4,26	2,07	8,60	4,61	1,87	8,50	4,91	1,73	8,00	5,06	1,58	7,80	5,86	1,33
-7	9,00	3,06	2,94	9,00	3,29	2,74	9,00	3,56	2,53	8,90	3,83	2,32	8,90	4,11	2,17	8,90	4,46	2,00	8,90	4,96	1,79	8,90	5,46	1,63
2	9,00	2,43	3,70	9,00	2,61	3,45	9,00	2,91	3,09	9,00	3,21	2,80	9,00	3,55	2,54	9,00	3,88	2,32	9,00	4,35	2,07	9,00	4,76	1,89
7	9,00	1,82	4,95	9,00	1,94	4,64	9,00	2,21	4,07	9,00	2,46	3,66	9,00	2,76	3,26	9,00	3,12	2,88	9,00	3,46	2,60	9,00	3,96	2,27
25	12,00	1,66	7,23	12,00	1,76	6,82	12,00	2,01	5,97	12,00	2,14	5,05	12,00	2,46	4,31	12,00	2,66	3,83	12,00	2,91	3,44	9,80	3,31	2,96

WH-SHF12F6E5

Tamb	HC	IP	COP	HC	IP	COP	HC	IP	COP	HC	IP	COP	HC	IP	COP	HC	IP	COP	HC	IP	COP	HC	IP	COP
LWC	30	30	30	35	35	35	40	40	40	45	45	45	50	50	50	55	55	55	60	60	60	65	65	65
-15	12,00	5,16	2,33	12,00	5,53	2,17	11,00	5,51	2,00	10,80	5,49	1,97	10,30	5,63	1,83	9,70	5,76	1,68	9,00	6,01	1,50	8,00	6,11	1,31
-7	12,00	4,43	2,71	12,00	4,76	2,52	11,50	4,91	2,34	11,20	5,06	2,21	10,80	5,16	2,09	10,10	5,28	1,91	9,85	5,66	1,74	9,60	5,91	1,62
2	12,00	3,42	3,51	12,00	3,68	3,26	11,50	3,86	2,98	11,30	4,14	2,73	11,00	4,51	2,44	10,80	4,86	2,22	10,65	5,31	2,01	10,30	5,59	1,84
7	12,00	2,52	4,76	12,00	2,69	4,46	12,00	3,06	3,92	12,00	3,44	3,49	12,00	3,81	3,15	12,00	4,28	2,80	12,00	4,86	2,47	12,00	5,41	2,22
25	12,00	1,66	7,23	12,00	1,76	6,82	12,00	2,01	5,97	12,00	2,41	4,98	12,00	2,64	4,55	12,00	2,96	4,05	12,00	3,41	3,52	12,00	3,86	3,11

WH-SHF09F3E8

Tamb	HC	IP	COP	HC	IP	COP	HC	IP	COP	HC	IP	COP	HC	IP	COP	HC	IP	COP	HC	IP	COP	HC	IP	COP
LWC	30	30	30	35	35	35	40	40	40	45	45	45	50	50	50	55	55	55	60	60	60	65	65	65
-15	9,00	3,46	2,60	9,00	3,71	2,43	8,90	4,01	2,22	8,80	4,26	2,07	8,60	4,61	1,87	8,50	4,91	1,73	8,00	5,06	1,58	7,80	5,86	1,33
-7	9,00	3,06	2,94	9,00	3,29	2,74	9,00	3,56	2,53	8,90	3,83	2,32	8,90	4,11	2,17	8,90	4,46	2,00	8,90	4,96	1,79	8,90	5,46	1,63
2	9,00	2,43	3,70	9,00	2,61	3,45	9,00	2,91	3,09	9,00	3,21	2,80	9,00	3,55	2,54	9,00	3,88	2,32	9,00	4,35	2,07	9,00	4,76	1,89
7	9,00	1,82	4,95	9,00	1,94	4,64	9,00	2,21	4,07	9,00	2,46	3,66	9,00	2,76	3,26	9,00	3,12	2,88	9,00	3,46	2,60	9,00	3,96	2,27
25	12,00	1,66	7,23	12,00	1,76	6,82	12,00	2,01	5,97	12,00	2,14	5,05	12,00	2,46	4,31	12,00	2,66	3,83	12,00	2,91	3,44	9,80	3,31	2,96

WH-SHF12F9E8

Tamb	HC	IP	COP	HC	IP	COP	HC	IP	COP	HC	IP	COP	HC	IP	COP	HC	IP	COP	HC	IP	COP	HC	IP	COP
LWC	30	30	30	35	35	35	40	40	40	45	45	45	50	50	50	55	55	55	60	60	60	65	65	65
-15	12,00	5,16	2,33	12,00	5,53	2,17	11,00	5,51	2,00	10,80	5,49	1,97	10,30	5,63	1,83	9,70	5,76	1,68	9,00	6,01	1,50	8,00	6,11	1,31
-7	12,00	4,43	2,71	12,00	4,76	2,52	11,50	4,91	2,34	11,20	5,06	2,21	10,80	5,16	2,09	10,10	5,28	1,91	9,85	5,66	1,74	9,60	5,91	1,62
2	12,00	3,42	3,51	12,00	3,68	3,26	11,50	3,86	2,98	11,30	4,14	2,73	11,00	4,51	2,44	10,80	4,86	2,22	10,65	5,31	2,01	10,30	5,59	1,84
7	12,00	2,52	4,76	12,00	2,69	4,46	12,00	3,06	3,92	12,00	3,44	3,49	12,00	3,81	3,15	12,00	4,28	2,80	12,00	4,86	2,47	12,00	5,41	2,22
25	12,00	1,66	7,23	12,00	1,76	6,82	12,00	2,01	5,97	12,00	2,41	4,98	12,00	2,64	4,55	12,00	2,96	4,05	12,00	3,41	3,52	12,00	3,86	3,11

Tamb: Ambient Temperature (°C). LWC: Leaving Water Condenser Temperature (°C). HC: Heating capacity (kW). IP: Power Input (kW)

This data is measured by Panasonic in accordance with EN14511-2 standard. This data is for reference purpose only, and does not guarantee the performance.

Hydraulic pump performance of the F type Heat Pumps: A class pump F (5 kW and 16 kW)

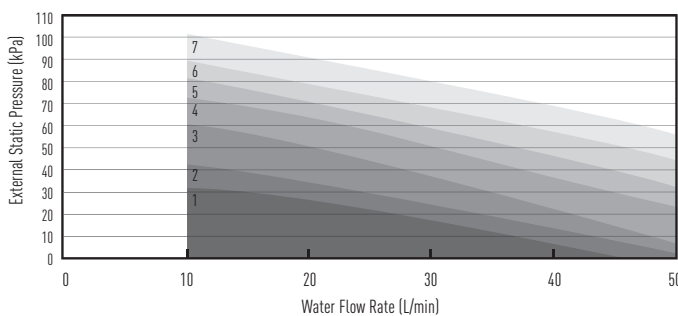

Min Pump Speed 1 Pump Speed 2 Pump Speed 3 Pump Speed 4 Pump Speed 5 Pump Speed 6 Max

Hydraulic pump performance of the F type Heat Pumps: A class pump F (5 kW and 16 kW)

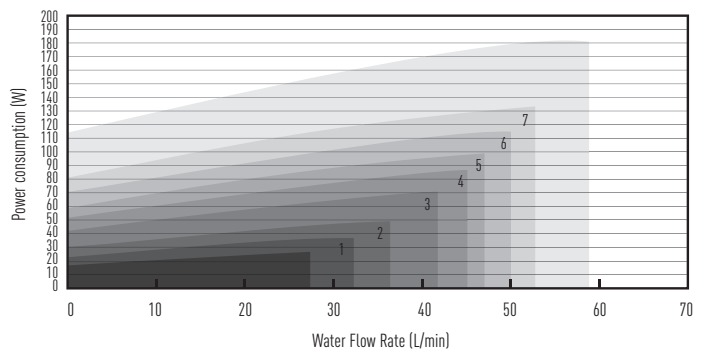

Heating capacity table based on outlet temperature and outside temperature

Heating Capacity Curve

Aquarea Ht. Mono-Bloc Single Phase / Three Phase. Heating Only - MHF

WH-MHF09D3E5

Tamb	HC	IP	COP	HC	IP	COP	HC	IP	COP	HC	IP	COP	HC	IP	COP	HC	IP	COP	HC	IP	COP	HC	IP	COP
LWC	30	30	30	35	35	35	40	40	40	45	45	45	50	50	50	55	55	55	60	60	60	65	65	65
-15	9,00	3,50	2,57	9,00	3,75	2,40	8,90	4,05	2,20	8,80	4,30	2,05	8,60	4,65	1,85	8,50	4,95	1,72	8,00	5,10	1,57	7,80	5,90	1,32
-7	9,00	3,10	2,90	9,00	3,33	2,70	9,00	3,60	2,50	8,90	3,87	2,30	8,90	4,15	2,14	8,90	4,50	1,98	8,90	5,00	1,78	8,90	5,50	1,62
2	9,00	2,47	3,64	9,00	2,65	3,40	9,00	2,95	3,05	9,00	3,25	2,77	9,00	3,59	2,51	9,00	3,92	2,30	9,00	4,39	2,05	9,00	4,80	1,88
7	9,00	1,86	4,84	9,00	1,98	4,55	9,00	2,25	4,00	9,00	2,50	3,60	9,00	2,80	3,21	9,00	3,16	2,85	9,00	3,50	2,57	9,00	4,00	2,25
25	12,00	1,70	7,06	12,00	1,80	6,67	12,00	2,05	5,85	10,80	2,18	4,95	10,60	2,50	4,24	10,20	2,70	3,78	10,00	2,95	3,39	9,80	3,35	2,93

WH-MHF12D6E5

Tamb	HC	IP	COP	HC	IP	COP	HC	IP	COP	HC	IP	COP	HC	IP	COP	HC	IP	COP	HC	IP	COP	HC	IP	COP
LWC	30	30	30	35	35	35	40	40	40	45	45	45	50	50	50	55	55	55	60	60	60	65	65	65
-15	12,00	5,20	2,31	12,00	5,57	2,15	11,00	5,55	1,98	10,80	5,53	1,95	10,30	5,67	1,82	9,70	5,80	1,67	9,00	6,05	1,49	8,00	6,15	1,30
-7	12,00	4,47	2,68	12,00	4,80	2,50	11,50	4,95	2,32	11,20	5,10	2,20	10,80	5,20	2,08	10,10	5,32	1,90	9,85	5,70	1,73	9,60	5,95	1,61
2	12,00	3,46	3,47	12,00	3,72	3,23	11,50	3,90	2,95	11,30	4,18	2,70	11,00	4,55	2,42	10,80	4,90	2,20	10,65	5,35	1,99	10,30	5,63	1,83
7	12,00	2,56	4,69	12,00	2,73	4,40	12,00	3,10	3,87	12,00	3,48	3,45	12,00	3,85	3,12	12,00	4,32	2,78	12,00	4,90	2,45	12,00	5,45	2,20
25	12,00	1,70	7,06	12,00	1,80	6,67	12,00	2,05	5,85	12,00	2,45	4,90	12,00	2,68	4,48	12,00	3,00	4,00	12,00	3,45	3,48	12,00	3,90	3,08

WH-MHF09D3E8

Tamb	HC	IP	COP	HC	IP	COP	HC	IP	COP	HC	IP	COP	HC	IP	COP	HC	IP	COP	HC	IP	COP	HC	IP	COP
LWC	35	35	35	35	35	35	40	40	40	45	45	45	50	50	50	55	55	55	60	60	60	65	65	65
-15	9,00	3,50	2,57	9,00	3,75	2,40	8,90	4,05	2,20	8,80	4,30	2,05	8,60	4,65	1,85	8,50	4,95	1,72	8,00	5,10	1,57	7,80	5,90	1,32
-7	9,00	3,10	2,90	9,00	3,33	2,70	9,00	3,60	2,50	8,90	3,87	2,30	8,90	4,15	2,14	8,90	4,50	1,98	8,90	5,00	1,78	8,90	5,50	1,62
2	9,00	2,47	3,64	9,00	2,65	3,40	9,00	2,95	3,05	9,00	3,25	2,77	9,00	3,59	2,51	9,00	3,92	2,30	9,00	4,39	2,05	9,00	4,80	1,88
7	9,00	1,86	4,84	9,00	1,98	4,55	9,00	2,25	4,00	9,00	2,50	3,60	9,00	2,80	3,21	9,00	3,16	2,85	9,00	3,50	2,57	9,00	4,00	2,25
25	12,00	1,70	7,06	12,00	1,80	6,67	12,00	2,05	5,85	10,80	2,18	4,95	10,60	2,50	4,24	10,20	2,70	3,78	10,00	2,95	3,39	9,80	3,35	2,93

WH-MHF12D9E8

Tamb	HC	IP	COP	HC	IP	COP	HC	IP	COP	HC	IP	COP	HC	IP	COP	HC	IP	COP	HC	IP	COP	HC	IP	COP
LWC	35	35	35	35	35	35	40	40	40	45	45	45	50	50	50	55	55	55	60	60	60	65	65	65
-15	12,00	5,20	2,31	12,00	5,57	2,15	11,00	5,55	1,98	10,80	5,53	1,95	10,30	5,67	1,82	9,70	5,80	1,67	9,00	6,05	1,49	8,00	6,15	1,30
-7	12,00	4,47	2,68	12,00	4,80	2,50	11,50	4,95	2,32	11,20	5,10	2,20	10,80	5,20	2,08	10,10	5,32	1,90	9,85	5,70	1,73	9,60	5,95	1,61
2	12,00	3,46	3,47	12,00	3,72	3,23	11,50	3,90	2,95	11,30	4,18	2,70	11,00	4,55	2,42	10,80	4,90	2,20	10,65	5,35	1,99	10,30	5,63	1,83
7	12,00	2,56	4,69	12,00	2,73	4,40	12,00	3,10	3,87	12,00	3,48	3,45	12,00	3,85	3,12	12,00	4,32	2,78	12,00	4,90	2,45	12,00	5,45	2,20
25	12,00	1,70	7,06	12,00	1,80	6,67	12,00	2,05	5,85	12,00	2,45	4,90	12,00	2,68	4,48	12,00	3,00	4,00	12,00	3,45	3,48	12,00	3,90	3,08

Tamb: Ambient Temperature (°C). LWC: Leaving Water Condenser Temperature (°C). HC: Heating capacity (kW). IP: Power Input (kW)
 This data is measured by Panasonic in accordance with EN14511-2 standard. This data is for reference purpose only, and does not guarantee the performance.

Hydraulic Pump Performance

WH-MHF09D3E5 // WH-MHF12D6E5 // WH-MHF09D3E8 // WH-MHF12D9E8

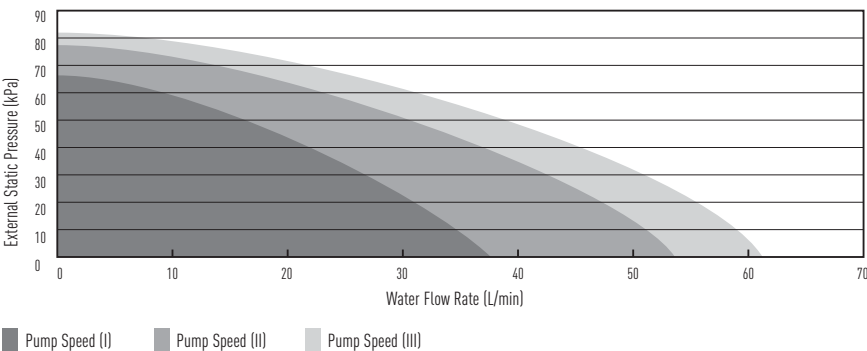

Error Codes

The operation led blinks and an error code appears on the control panel display.

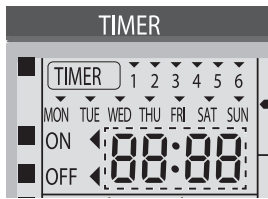

- Turn the unit off and inform the authorised dealer of the error code.
- The timer operation is cancelled when an error code occurs.

Force Heater mode button

- The backup heater also serves as backup in case of malfunctioning of the outdoor unit.
- Press  to stop the force heater operation.
- During Force Heater mode, all other operations are not allowed.

Error Code List

Diagnosis display	Abnormality / Protection control	Abnormality Judgement	Primary location to verify
H00	No abnormality detected	—	—
H12	Indoor/Outdoor capacity unmatched	90s after power supply	<ul style="list-style-type: none"> • Indoor/outdoor connection wire • Indoor/outdoor PCB • Specification and combination table in catalogue
H15	Outdoor compressor temperature sensor abnormality	Continue for 5 sec.	<ul style="list-style-type: none"> • Compressor temperature sensor (defective or disconnected)
H23	Indoor refrigerant liquid temperature sensor abnormality	Continue for 5 sec.	<ul style="list-style-type: none"> • Refrigerant liquid temperature sensor (defective or disconnected)
H38	Indoor/Outdoor mismatch	—	<ul style="list-style-type: none"> • Indoor/Outdoor PCB
H42	Compressor low pressure abnormality	—	<ul style="list-style-type: none"> • Outdoor pipe temperature sensor • Clogged expansion valve or strainer • Insufficient refrigerant • Outdoor PCB • Compressor
H62	Water flow switch abnormality	Continue for 1 min.	<ul style="list-style-type: none"> • Water flow switch
H64	Refrigerant high pressure abnormality	Continue for 5 sec.	<ul style="list-style-type: none"> • Outdoor high pressure sensor (defective or disconnected)
H70	Back-up heater OLP abnormality	Continue for 60 sec.	<ul style="list-style-type: none"> • Back-up heater OLP (Disconnection or activated)
H72	Tank sensor abnormal	Continue for 5 sec.	<ul style="list-style-type: none"> • Tank sensor
H76	Indoor - control panel communication abnormality	—	<ul style="list-style-type: none"> • Indoor - control panel (defective or disconnected)
H90	Indoor / outdoor abnormal communication	> 1 min after starting operation	<ul style="list-style-type: none"> • Internal / external cable connections • Indoor / Outdoor PCB
H91	Tank heater OLP abnormality	Continue for 60 sec.	<ul style="list-style-type: none"> • Tank heater OLP (Disconnection or activated)
H95	Indoor/Outdoor wrong connection	—	<ul style="list-style-type: none"> • Indoor/Outdoor supply voltage
H98	Outdoor high pressure overload protection	—	<ul style="list-style-type: none"> • Outdoor high pressure sensor • Water pump or water leakage • Clogged expansion valve or strainer • Excess refrigerant • Outdoor PCB
H99	Indoor heat exchanger freeze prevention	—	<ul style="list-style-type: none"> • Indoor heat exchanger • Refrigerant shortage
F12	Pressure switch activate	4 times occurrence within 20 minutes	<ul style="list-style-type: none"> • Pressure switch
F14	Outdoor compressor abnormal revolution	4 times occurrence within 20 minutes	<ul style="list-style-type: none"> • Outdoor compressor
F15	Outdoor fan motor lock abnormality	2 times occurrence within 30 minutes	<ul style="list-style-type: none"> • Outdoor PCB • Outdoor fan motor
F16	Total running current protection	3 times occurrence within 20 minutes	<ul style="list-style-type: none"> • Excess refrigerant • Outdoor PCB
F20	Outdoor compressor overheating protection	4 times occurrence within 30 minutes	<ul style="list-style-type: none"> • Compressor tank temperature sensor • Clogged expansion valve or strainer • Insufficient refrigerant • Outdoor PCB • Compressor
F22	IPM (power transistor) overheating protection	3 times occurrence within 30 minutes	<ul style="list-style-type: none"> • Improper heat exchange • IPM (Power transistor)
F23	Outdoor Direct Current (DC) peak detection	7 times occurrence continuously	<ul style="list-style-type: none"> • Outdoor PCB • Compressor
F24	Refrigeration cycle abnormality	2 times occurrence within 20 minutes	<ul style="list-style-type: none"> • Insufficient refrigerant • Outdoor PCB • Compressor low compression
F25	Cooling / Heating cycle changeover abnormality	4 times occurrence within 30 minutes	<ul style="list-style-type: none"> • 4-way valve • V-coil
F27	Pressure switch abnormality	Continue for 1 min.	<ul style="list-style-type: none"> • Pressure switch
F36	Outdoor air temperature sensor abnormality	Continue for 5 sec.	<ul style="list-style-type: none"> • Outdoor air temperature sensor (defective or disconnected)
F37	Indoor water inlet temperature sensor abnormality	Continue for 5 sec.	<ul style="list-style-type: none"> • Water inlet temperature sensor (defective or disconnected)
F40	Outdoor discharge pipe temperature sensor abnormality	Continue for 5 sec.	<ul style="list-style-type: none"> • Outdoor discharge pipe temperature sensor (defective or disconnected)
F41	PFC control	4 times occurrence within 10 minutes	<ul style="list-style-type: none"> • Voltage at PFC
F42	Outdoor heat exchanger temperature sensor abnormality	Continue for 5 sec.	<ul style="list-style-type: none"> • Outdoor heat exchanger temperature sensor (defective or disconnected)
F43	Outdoor defrost sensor abnormality	Continue for 5 sec.	<ul style="list-style-type: none"> • Outdoor defrost sensor (defective or disconnected)
F45	Indoor water outlet temperature sensor abnormality	Continue for 5 sec.	<ul style="list-style-type: none"> • Water outlet temperature sensor (defective or disconnected)
F46	Outdoor Current Transformer open circuit	—	<ul style="list-style-type: none"> • Insufficient refrigerant • Outdoor PCB • Compressor low
F95	Cooling high pressure overload protection	—	<ul style="list-style-type: none"> • Outdoor high pressure sensor • Water pump or water leakage • Clogged expansion valve or strainer • Excess refrigerant • Outdoor PCB
F48	Outdoor EVA outlet temperature sensor abnormality	Continue for 5 sec.	<ul style="list-style-type: none"> • Outdoor EVA outlet temperature sensor (defective or disconnected)
F49	Out bypass outlet temperature sensor abnormality	Continue for 5 sec.	<ul style="list-style-type: none"> • Outdoor bypass outlet temperature sensor (defective or disconnected)

Dimensions

All in One

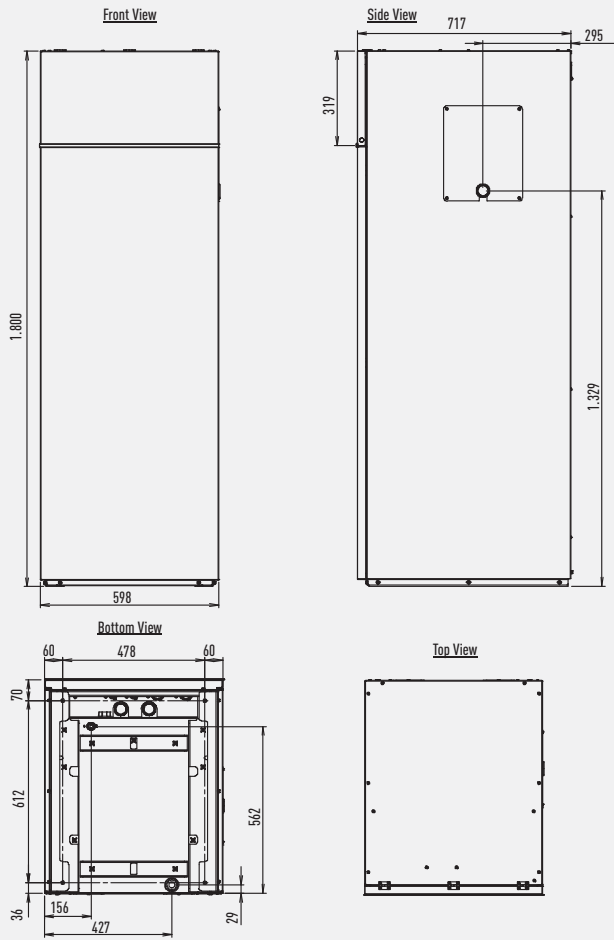

Hydraulic Module for all models

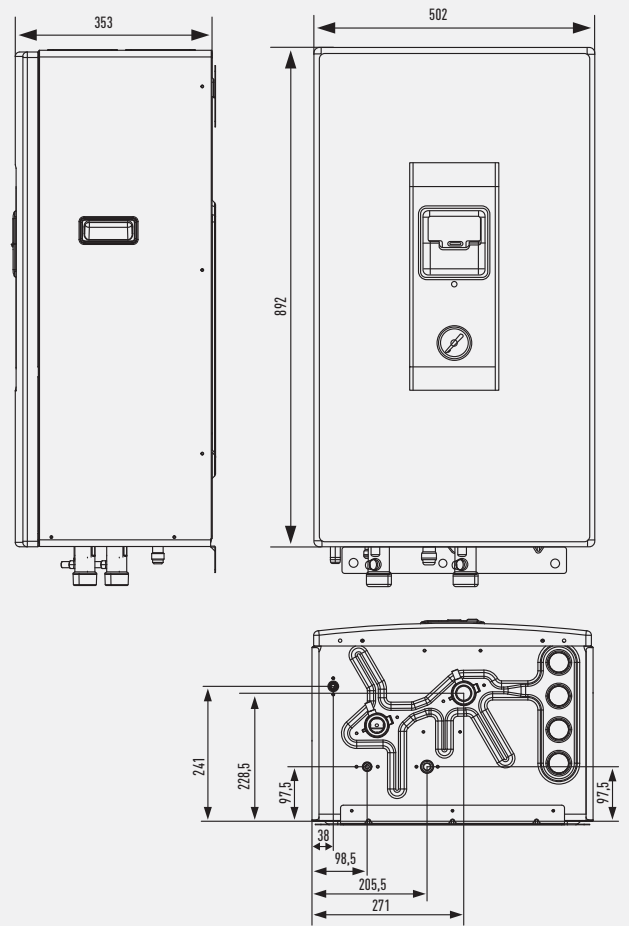

One fan outdoor unit

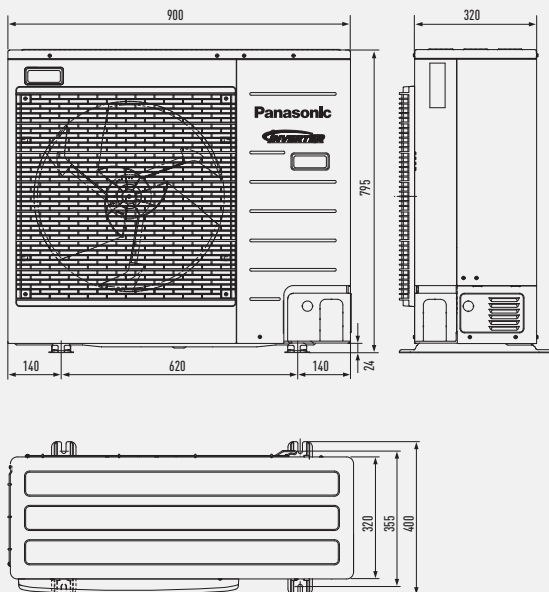

Two fans outdoor unit

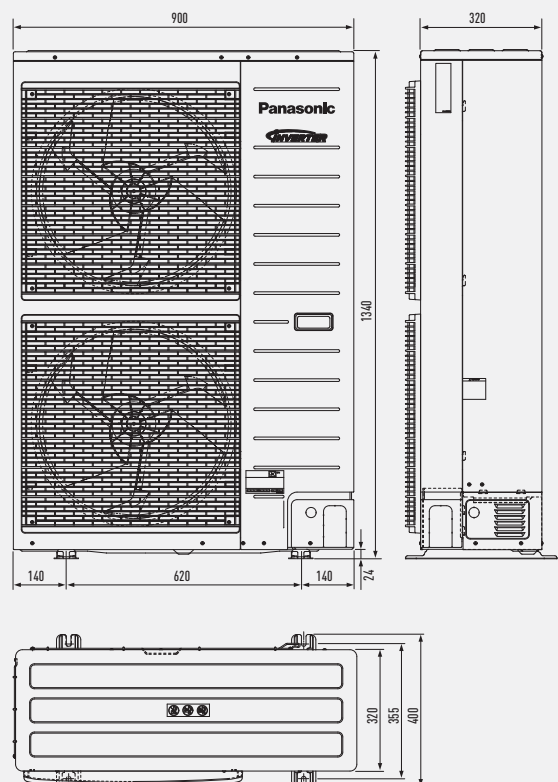

Bi-Bloc 3 and 5kW

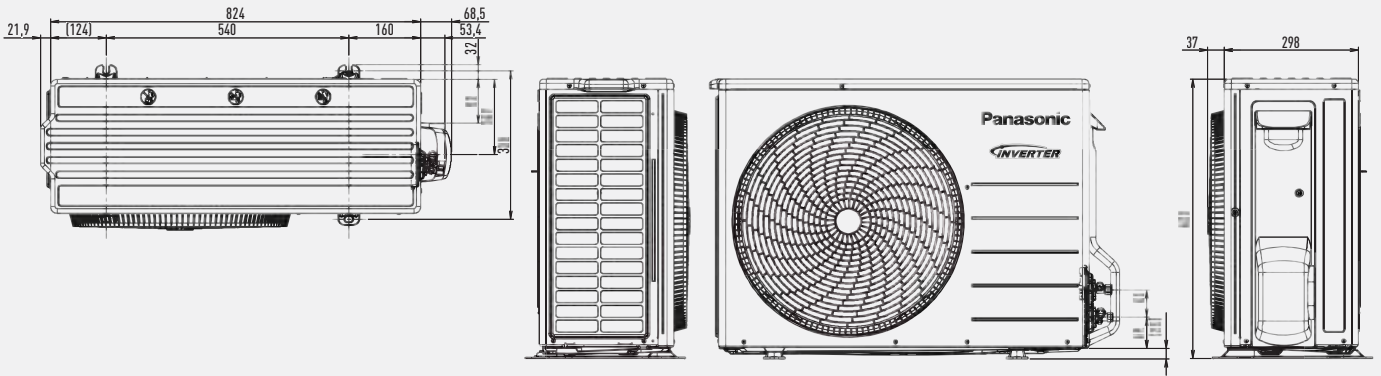

Mono-Bloc 6 and 9kW

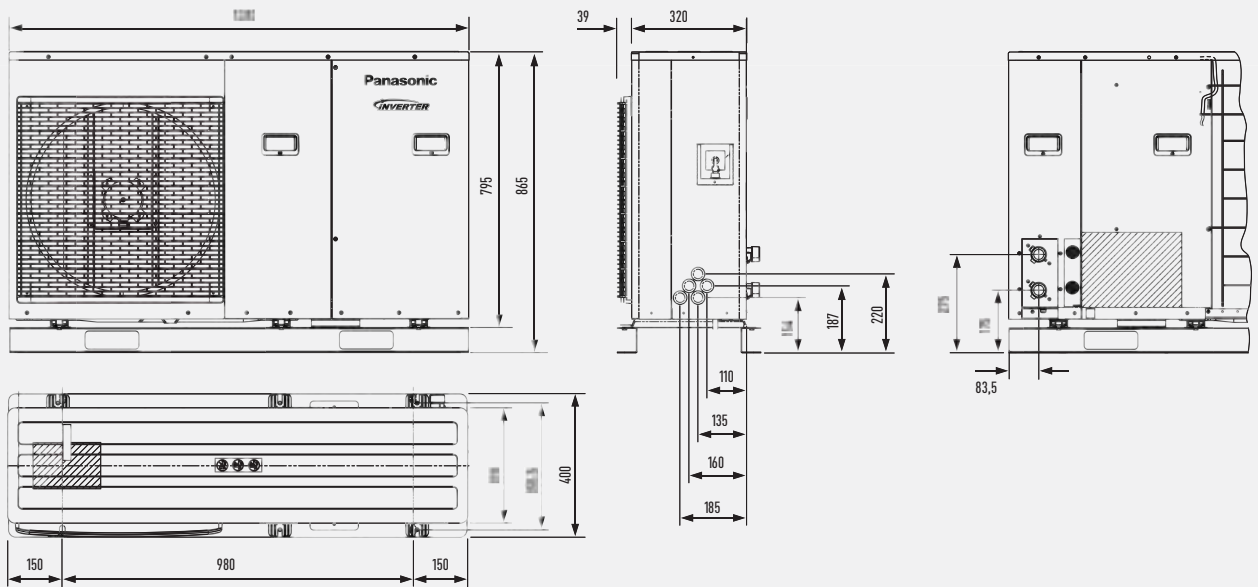

Mono-Bloc 9 to 16kW

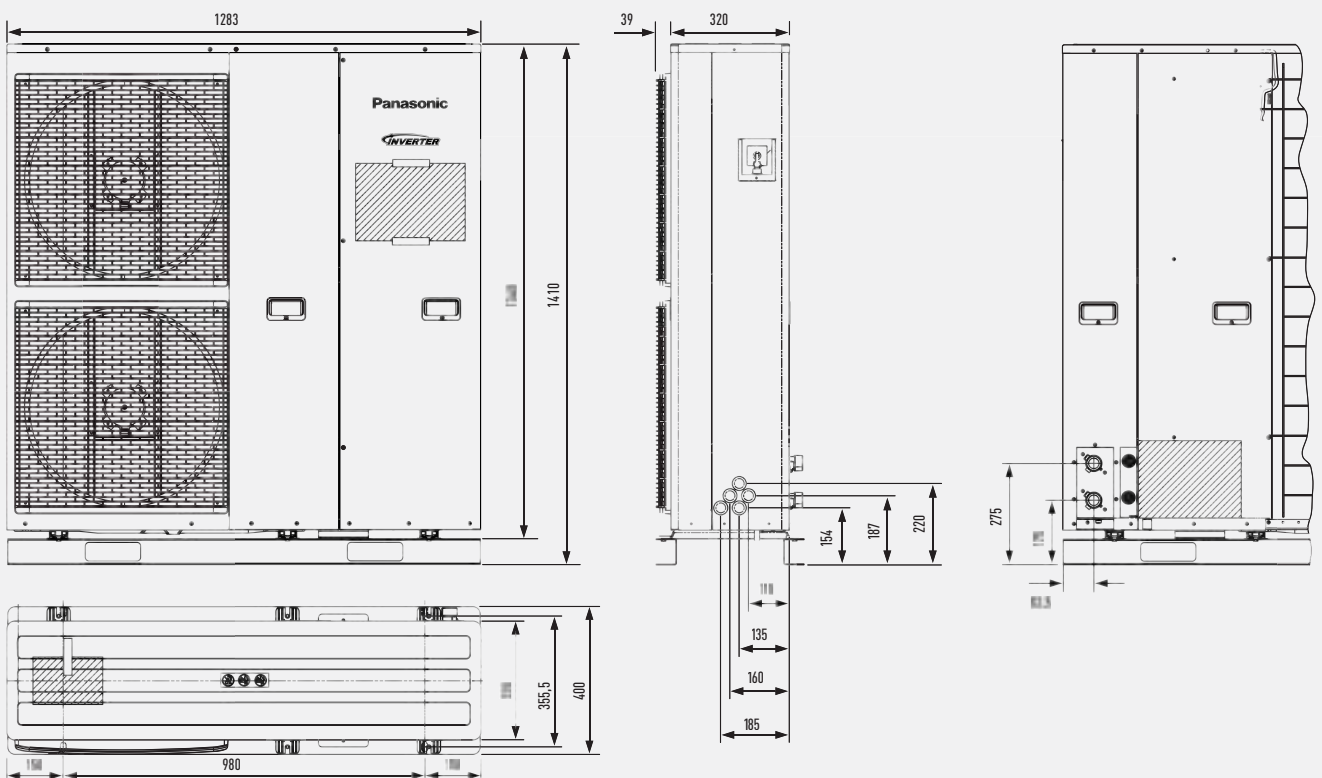





Panasonic

www.aircon.panasonic.eu

heating & cooling solutions

Due to the ongoing innovation of our products, the specifications of this catalogue are valid barring typographic errors, and may be subject to minor modifications by the manufacturer without prior warning in order to improve the product. The total or partial reproduction of this catalogue is prohibited without the express authorisation of Panasonic Marketing Europe GmbH.

Panasonic®

To find out how Panasonic cares for you,
log on to: www.aircon.panasonic.eu

Panasonic Marketing Europe GmbH
Panasonic Air Conditioning
Hagenauer Strasse 43, 65203 Wiesbaden, Germany



Do not add or replace refrigerant other than the specified type. Manufacturer is not responsible for the damage and deterioration in safety due to usage of the other refrigerant.
The outdoor units in this catalogue contains fluorinated greenhouse gases with a GWP higher than 150.

