

## TECHNICAL DATA

### Gas Heat Pump Air Conditioner 2-WAY Multi 2-WAY W Multi 3-WAY Multi

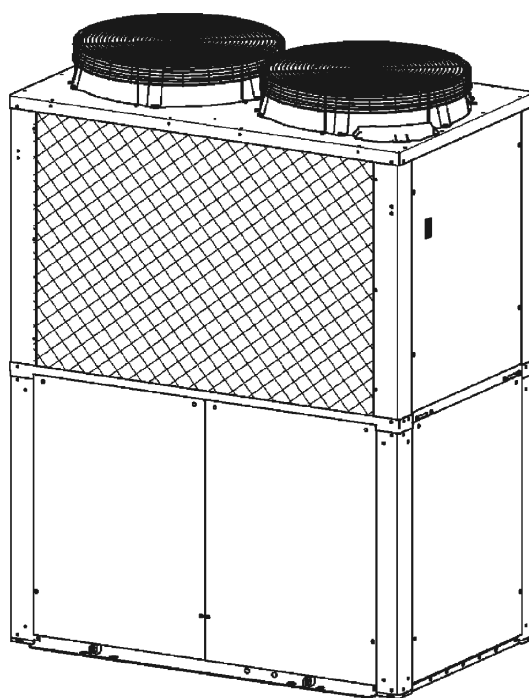

OUTDOOR MODEL No.	PRODUCT CODE No.
U-16GE2E5	182680168
U-20GE2E5	182680169
U-25GE2E5	182680170
U-16GEP2E5	182680171
U-20GEP2E5	182680172
U-25GEP2E5	182680173
U-30GE2E5	182680166
U-16GF2E5	182680174
U-20GF2E5	182680175
U-25GF2E5	182680176



# Contents

- System Configuration.....A-1
- Outdoor Unit.....B-1
- Control-Related.....C-1
- System Design .....D-1
- Installation Work.....E-1
- Separately Sold Parts .....F-1
- Periodic Inspection .....G-1





# Contents

- 1. Type Configuration
  - (1) Outdoor unit ..... A-2

### (1) Outdoor Unit

- 2-WAY Multi (30 Horsepower)
- 2-WAY W Multi (16, 20 and 25 Horsepower)
- 3-WAY Multi (16, 20 and 25 Horsepower)

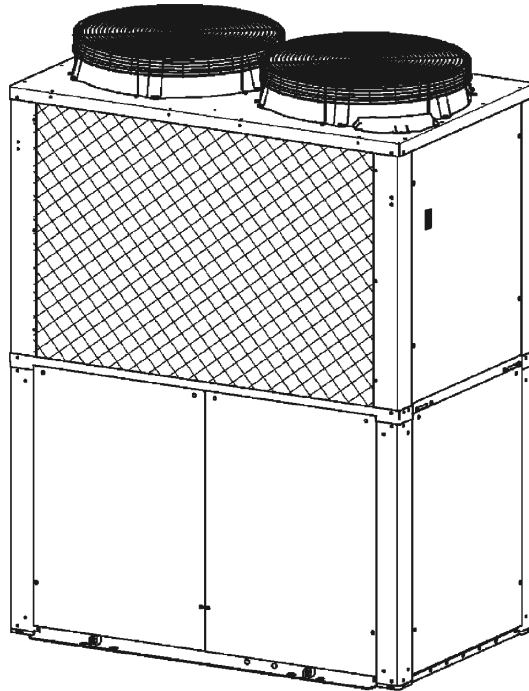

- U-16GE2E5
- U-20GE2E5
- U-25GE2E5
- U-16GEP2E5
- U-20GEP2E5
- U-25GEP2E5
- U-30GE2E5
- U-16GF2E5
- U-20GF2E5
- U-25GF2E5

# Contents

- 1. Gas Usage Conditions
  - (1) Usable Gas ..... B-2
  - (2) Gas Supply Pressure ..... B-2
  - (3) Applicable Gas Type..... B-2
  - (4) Gas Maximum Flow Volume..... B-2
  - (5) When using Propane ..... B-3
  
- 2. Specifications.....B-4
  
- 3. External Dimensions.....B-14
  
- 4. Wiring Diagram.....B-17
  
- 5. Performance Characteristics.....B-18
  
- 6. Operating Sound Level Characteristics
  - (1) Standard Mode ..... B-28
  - (2) Quiet Mode ..... B-32
  
- 7. Vibration Force
  - (1) Measurement Points ..... B-36
  - (2) Vibration Force..... B-36

### (1) Usable Gas

- 1) Depending upon the calorific value of the natural gas, the setting for the gas fuel flow rate adjustment nozzle will differ.

### (2) Gas Supply Pressure

Units: mbar

Gas Type	Maximum	Standard	Minimum
P	45	37	25
H, L, E	25	20	17

### (3) Applicable Gas Type

Group		P	H	L	E
Gas composition Standard gas Calorific value (MJ/m <sup>3</sup> N)		C <sub>3</sub> H <sub>8</sub> 100% G31 95.65	CH <sub>4</sub> 100% G20 37.78	CH <sub>4</sub> 86% N <sub>2</sub> 14% G25 32.49	CH <sub>4</sub> 100% G20 37.78
Model Name	45.0 kW Type	○	◎	○	○
	56.0 kW Type	○	◎	○	○
	71.0 kW Type	○	◎	○	○
	85.0 kW Type	○	◎	○	○

Applicability ◎ : Standard setting when shipped from the factory  
○ : Necessary to change the gas type setting on site

### (4) Gas Maximum Flow Volume

Outdoor unit type	Gas Maximum Flow Volume (kW)
45.0 kW	57
56.0 kW	69
71.0 kW	80
85.0 kW	90

The gas maximum flow volume is the quantity of gas consumed after start up and operating at full capacity, with the gas at 40 °C and at standard pressure.

(5) When using Propane

\* **When using Propane as the gas fuel, it is necessary to adjust the fuel adjustment valve and the gas type setting.**

(1) Fuel valve setting

● **With the power supply breaker for the outdoor unit OFF**

- 1) Move the lever of the P/N switch that is attached to the mixer part of the engine to the position shown in the diagram. Turn it 180 degrees in the clockwise direction (there is a stopper provided). Do not apply unnecessary force to turn it any further.
- 2) In the electrical equipment box, fix the "Gas type setting/Adjustment Completed" label to the prescribed position for the PL NAME.

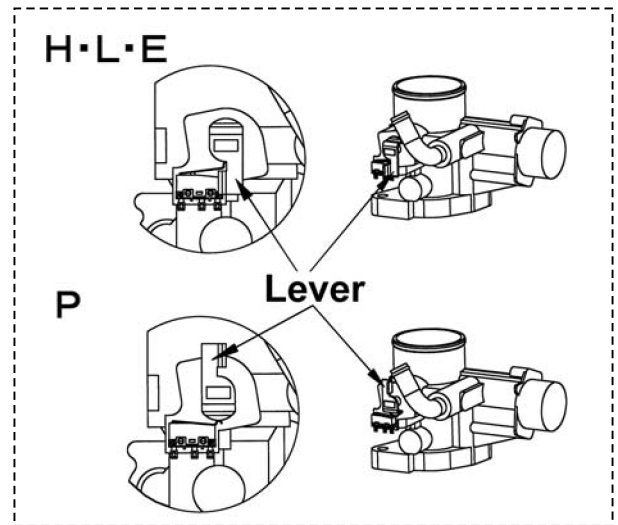

(2) Fuel Gas Type Setting

● **Check that the fuel adjustment valve setting has been set before operating the outdoor control board.**

- 1) Press the home key (S004) for longer than one second and the menu item number will be displayed.
- 2) Next, press the up (S005)/down (S006) key to set the menu item number to .
- 3) After displaying ,  is displayed. When  is displayed press the set (S007) key. The green LED (D053) lights up, and the system address setting is displayed.  
 (For example: )
- 4) Next operate the down (S006)/up (S005) key, to display the gas type setting. When the gas type setting is displayed, press the set (S007) key for longer than one second.  
 Note: When setting the gas type, \*\* is displayed.(for \*\* enter 00-05)
- 5) A red LED (D052) lights up, indicating that a forced setting is being carried out. In this condition, press the down (S006)/up (S005) key, and select the gas type.

The relationship between display and gas type is as shown in the following table.

	Status/setting display	Type of gas	Status/setting display	Type of gas
↑ DOWN ↓ UP	<input type="text" value="000000"/>	Band P (LPG)	<input type="text" value="000000"/>	No Use
	<input type="text" value="000001"/>	No Use	<input type="text" value="000009"/>	No Use
	<input type="text" value="000002"/>	Band H (Natural Gas)	<input type="text" value="00000A"/>	No Use
	<input type="text" value="000003"/>	Band H (Natural Gas)	<input type="text" value="00000B"/>	No Use
	<input type="text" value="000004"/>	Band (Natural Gas)	<input type="text" value="00000C"/>	No Use
	<input type="text" value="000005"/>	No Use	<input type="text" value="00000D"/>	No Use
	<input type="text" value="000006"/>	No Use	<input type="text" value="00000E"/>	Band LNG (Natural Gas)
	<input type="text" value="000007"/>	No Use	<input type="text" value="00000F"/>	No Use

\* When the H/L/E gas type is selected, the oil replacement time warning is not displayed.

- 6) After completing selection of gas type, press the set (S007) key for longer than 1 second. The red LED (D052) will be extinguished.
- 7) Press the home (S004) key to complete the setting.

Note: When using propane, change the setting in accordance with the above procedure to

Model No.	U-16GE2E5	
External dimensions (mm)		
Height	2,273	
Width	1,650	
Depth	1,000 (+80)	
Weight (kg)	755	
Performance (kW)		
Cooling capacity	45.0	
Heating capacity (Standard)	50.0	
Heating capacity (low temp.)	53.0	
Hot Water (Cooling mode)	15.0 (@75°C outlet) <sup>(Note 7)</sup>	
Generate electricity power source	220 to 240 V, 50 Hz, Single-phase	
Electrical rating		
Cooling	Running amperes (A)	3.36
	Power input (kW)	0.71
	Power factor (%)	92
Heating	Running amperes (A)	2.87
	Power input (kW)	0.60
	Power factor (%)	91
Starting amperes (A)	30	
Gas Type		
Gas Band	P	Propane gas (G31)
	H	Natural gas (G20)
	L	Natural gas (G25)
	E	Natural gas (G20)
Gas consumption (kW)		
Cooling	29.7	
Heating (Standard)	32.5	
Compressor		
Cooling oil (L) (type)	7.5 (HP-9)	
Crankcase heater (W)	30	
Paint color (Munsell code)	Silky Shade (1Y8.5/0.5)	

Engine		
Displacement (L)		2.488
Rated output (kW)		10.0
Oil	Type	Panasonic Genuine 43
	Quantity (L)	
Starter motor		12 V DC, 2.0 kW
Starter type		AC/DC conversion type DC starter
Engine cooling water		
Quantity (L)		21
Concentration, Freezing temperature		50 V/V%, -35°C
Cooling water pump rated output (kW)		0.16
Refrigerant type, Quantity (kg)		HFC [R410A] , 10.5
Air intakes		Front and Rear
Air outlet		Top
Piping		
Refrigerant gas (mm)		ø28.58(brazed) (ø31.75) (Note 4)
Refrigerant liquid (mm)		ø12.7(brazed) (ø15.88) (Note 4)
Fuel gas		R3/4 (Bolt, thread)
Exhaust drain (mm)		ø25 .Rubber hose (length: 350)
Hot water supply in/out		Rp3/4 (Nut, thread)
Operating noise level dB(A)		57
Ventilation System		
Type		Propeller fans (x2)
Air flow rate (m³/min)		380
Rated output (kW)		0.70x2
Drain heater (W)		40

### Notes

- Cooling and heating capacities in the tables are determined under the test conditions of JIS B 8627.

Operating condition	Cooling	Heating (standard)	Heating (low temp.)
Indoor air intake temp.	27°CDB/19°CWB	20°CDB	20°CDB/15°CWB or less
Outdoor air intake temp.	35°CDB	7°CDB/6°CWB	2°CDB/1°CWB

- Effective heating requires that the outdoor air intake temperature be at least -20°CDB or -21°CWB.

- Gas consumption is the total (high) calorific value standard.
- Outdoor unit operating sound is measured 1 meter from the front and 1.5 meters above the floor (in an anechoic environment). Actual installations may have larger values due to ambient noise and reflections.
- Values in parentheses ( ) for refrigerant gas and liquid types are those when the maximum piping length exceeds 90 meters (equivalent length). (Reducers are available locally.)
- Specifications are subject to change without notice.
- Hot water heating capacity is applicable during cooling operation as in Note 1.
- The maximum water temperature that can be obtained is 75°C. Water heating performance and temperature vary with the air conditioning load.

Because the hot water heating system uses waste heat from the engine, which runs the air conditioning, its ability to heat water is not guaranteed.

Model No.	U-20GE2E5	
External dimensions (mm)		
Height	2,273	
Width	1,650	
Depth	1,000 (+80)	
Weight (kg)	780	
Performance (kW)		
Cooling capacity	56.0	
Heating capacity (Standard)	63.0	
Heating capacity (low temp.)	67.0	
Hot Water (Cooling mode)	20.0 (@ 75°C outlet) <sup>(Note 7)</sup>	
Generate electricity power source	220 to 240 V, 50 Hz, Single-phase	
Electrical rating		
Cooling	Running amperes (A)	4.87
	Power input (kW)	1.02
	Power factor (%)	91
Heating	Running amperes (A)	3.02
	Power input (kW)	0.64
	Power factor (%)	92
Starting amperes (A)	30	
Gas Type		
Gas Band	P	Propane gas (G31)
	H	Natural gas (G20)
	L	Natural gas (G25)
	E	Natural gas (G20)
Gas consumption (kW)		
Cooling	39.1	
Heating (Standard)	42.5	
Compressor		
Cooling oil (L) (type)	7.5 (HP-9)	
Crankcase heater (W)	30	
Paint color (Munsell code)	Silky Shade (1Y8.5/0.5)	

Engine		
Displacement (L)		2.488
Rated output (kW)		12.4
Oil	Type	Panasonic Genuine
	Quantity (L)	43
Starter motor		12 V DC, 2.0 kW
Starter type		AC/DC conversion type DC starter
Engine cooling water		
Quantity (L)		24
Concentration, Freezing temperature		50 V/V%, -35°C
Cooling water pump rated output (kW)		0.16
Refrigerant type, Quantity (kg)		HFC [R410A] , 11.5
Air intakes		Front and Rear
Air outlet		Top
Piping		
Refrigerant gas (mm)		ø28.58(brazed) (ø31.75) (Note 4)
Refrigerant liquid (mm)		ø15.88(brazed) (ø19.05) (Note 4)
Fuel gas		R3/4 (Bolt, thread)
Exhaust drain (mm)		ø25 .Rubber hose (length: 350)
Hot water supply in/out		Rp3/4 (Nut, thread)
Operating noise level dB(A)		58
Ventilation System		
Type		Propeller fans (x2)
Air flow rate (m³/min)		380
Rated output (kW)		0.70x2
Drain heater (W)		40

### Notes

- Cooling and heating capacities in the tables are determined under the test conditions of JIS B 8627.

Operating condition	Cooling	Heating (standard)	Heating (low temp.)
Indoor air intake temp.	27°CDB/19°CWB	20°CDB	20°CDB/15°CWB or less
Outdoor air intake temp.	35°CDB	7°CDB/6°CWB	2°CDB/1°CWB

- Effective heating requires that the outdoor air intake temperature be at least -20°CDB or -21°CWB.

- Gas consumption is the total (high) calorific value standard.
- Outdoor unit operating sound is measured 1 meter from the front and 1.5 meters above the floor (in an anechoic environment). Actual installations may have larger values due to ambient noise and reflections.
- Values in parentheses ( ) for refrigerant gas and liquid types are those when the maximum piping length exceeds 90 meters (equivalent length). (Reducers are available locally.)
- Specifications are subject to change without notice.
- Hot water heating capacity is applicable during cooling operation as in Note 1.
- The maximum water temperature that can be obtained is 75°C. Water heating performance and temperature vary with the air conditioning load.

Because the hot water heating system uses waste heat from the engine, which runs the air conditioning, its ability to heat water is not guaranteed.

Model No.	U-25GE2E5	
External dimensions (mm)		
Height	2,273	
Width	1,650	
Depth	1,000 (+80)	
Weight (kg)	810	
Performance (kW)		
Cooling capacity	71.0	
Heating capacity (Standard)	80.0	
Heating capacity (low temp.)	75.0	
Hot Water (Cooling mode)	30.0 (@ 75°C outlet) <sup>(Note 7)</sup>	
Generate electricity power source	220 to 240 V, 50 Hz, Single-phase	
Electrical rating		
Cooling	Running amperes (A)	6.22
	Power input (kW)	1.33
	Power factor (%)	93
Heating	Running amperes (A)	3.92
	Power input (kW)	0.83
	Power factor (%)	92
Starting amperes (A)	30	
Gas Type		
Gas Band	P	Propane gas (G31)
	H	Natural gas (G20)
	L	Natural gas (G25)
	E	Natural gas (G20)
Gas consumption (kW)		
Cooling	60.4	
Heating (Standard)	53.2	
Compressor		
Cooling oil (L) (type)	7.5 (HP-9)	
Crankcase heater (W)	30	
Paint color (Munsell code)	Silky Shade (1Y8.5/0.5)	

Engine		
Displacement (L)		2.488
Rated output (kW)		15.7
Oil	Type	Panasonic Genuine 43
	Quantity (L)	
Starter motor		12 V DC, 2.0 kW
Starter type		AC/DC conversion type DC starter
Engine cooling water		
Quantity (L)		25
Concentration, Freezing temperature		50 V/V%, -35°C
Cooling water pump rated output (kW)		0.16
Refrigerant type, Quantity (kg)		HFC [R410A] , 11.5
Air intakes		Front and Rear
Air outlet		Top
Piping		
Refrigerant gas (mm)		ø28.58(brazed) (ø31.75) (Note 4)
Refrigerant liquid (mm)		ø15.88(brazed) (ø19.05) (Note 4)
Fuel gas		R3/4 (Bolt, thread)
Exhaust drain (mm)		ø25 .Rubber hose (length: 350) Rp3/4 (Nut, thread)
Hot water supply in/out		
Operating noise level dB(A)		62
Ventilation System		
Type		Propeller fans (x2)
Air flow rate (m³/min)		380
Rated output (kW)		0.70x2
Drain heater (W)		40

### Notes

- Cooling and heating capacities in the tables are determined under the test conditions of JIS B 8627.

Operating condition	Cooling	Heating (standard)	Heating (low temp.)
Indoor air intake temp.	27°CDB/19°CWB	20°CDB	20°CDB/15°CWB or less
Outdoor air intake temp.	35°CDB	7°CDB/6°CWB	2°CDB/1°CWB

- Effective heating requires that the outdoor air intake temperature be at least -20°CDB or -21°CWB.

- Gas consumption is the total (high) calorific value standard.
- Outdoor unit operating sound is measured 1 meter from the front and 1.5 meters above the floor (in an anechoic environment). Actual installations may have larger values due to ambient noise and reflections.
- Values in parentheses ( ) for refrigerant gas and liquid types are those when the maximum piping length exceeds 90 meters (equivalent length). (Reducers are available locally.)
- Specifications are subject to change without notice.
- Hot water heating capacity is applicable during cooling operation as in Note 1.
- The maximum water temperature that can be obtained is 75°C. Water heating performance and temperature vary with the air conditioning load.

Because the hot water heating system uses waste heat from the engine, which runs the air conditioning, its ability to heat water is not guaranteed.



Model No.	U-16GEP2E5	
External dimensions (mm)		
Height	2,273	
Width	1,650	
Depth	1,000 (+80)	
Weight (kg)	770	
Performance (kW)		
Cooling capacity	45.0	
Heating capacity (Standard)	50.0	
Heating capacity (low temp.)	53.0	
Hot Water (Cooling mode)	15.0 (@75°C outlet) <sup>(Note 7)</sup>	
Generate electricity power source	220 to 240 V, 50 Hz, Single-phase	
Electrical rating		
Cooling	Running amperes (A)	0.52
	Power input (kW)	0.1
	Power factor (%)	84
Heating	Running amperes (A)	0.52
	Power input (kW)	0.1
	Power factor (%)	84
Starting amperes (A)	30	
Gas Type		
Gas Band	P	Propane gas (G31)
	H	Natural gas (G20)
	L	Natural gas (G25)
	E	Natural gas (G20)
Gas consumption (kW)		
Cooling	31.3	
Heating (Standard)	33.8	
Compressor		
Cooling oil (L) (type)	7.5 (HP-9)	
Crankcase heater (W)	30	
Paint color (Munsell code)	Silky Shade (1Y8.5/0.5)	

Engine		
Displacement (L)		2.488
Rated output (kW)		10.0
Oil	Type	Panasonic Genuine 43
	Quantity (L)	
Starter motor		12 V DC, 2.0 kW
Starter type		AC/DC conversion type DC starter
Engine cooling water		
Quantity (L)		21
Concentration, Freezing temperature		50 V/V%, -35°C
Cooling water pump rated output (kW)		0.16
Refrigerant type, Quantity (kg)		HFC [R410A] , 10.5
Air intakes		Front and Rear
Air outlet		Top
Piping		
Refrigerant gas (mm)		ø28.58(brazed) (ø31.75) (Note 4)
Refrigerant liquid (mm)		ø12.7(brazed) (ø15.88) (Note 4)
Fuel gas		R3/4 (Bolt, thread)
Exhaust drain (mm)		ø25 .Rubber hose (length: 350)
Hot water supply in/out		Rp3/4 (Nut, thread)
Operating noise level dB(A)		57
Ventilation System		
Type		Propeller fans (x2)
Air flow rate (m³/min)		380
Rated output (kW)		0.70x2
Drain heater (W)		40

### Notes

- Cooling and heating capacities in the tables are determined under the test conditions of JIS B 8627.

Operating condition	Cooling	Heating (standard)	Heating (low temp.)
Indoor air intake temp.	27°CDB/19°CWB	20°CDB	20°CDB/15°CWB or less
Outdoor air intake temp.	35°CDB	7°CDB/6°CWB	2°CDB/1°CWB

- Effective heating requires that the outdoor air intake temperature be at least -20°CDB or -21°CWB.

- Gas consumption is the total (high) calorific value standard.
- Outdoor unit operating sound is measured 1 meter from the front and 1.5 meters above the floor (in an anechoic environment). Actual installations may have larger values due to ambient noise and reflections.
- Values in parentheses ( ) for refrigerant gas and liquid types are those when the maximum piping length exceeds 90 meters (equivalent length). (Reducers are available locally.)
- Specifications are subject to change without notice.
- Hot water heating capacity is applicable during cooling operation as in Note 1.
- The maximum water temperature that can be obtained is 75°C. Water heating performance and temperature vary with the air conditioning load.

Because the hot water heating system uses waste heat from the engine, which runs the air conditioning, its ability to heat water is not guaranteed.

Model No.	U-20GEP2E5	
External dimensions (mm)		
Height	2,273	
Width	1,650	
Depth	1,000 (+80)	
Weight (kg)	795	
Performance (kW)		
Cooling capacity	56.0	
Heating capacity (Standard)	63.0	
Heating capacity (low temp.)	67.0	
Hot Water (Cooling mode)	20.0 (@ 75°C outlet) <sup>(Note 7)</sup>	
Generate electricity power source	220 to 240 V, 50 Hz, Single-phase	
Electrical rating		
Cooling	Running amperes (A)	0.52
	Power input (kW)	0.1
	Power factor (%)	84
Heating	Running amperes (A)	0.52
	Power input (kW)	0.1
	Power factor (%)	84
Starting amperes (A)	30	
Gas Type		
Gas Band	P	Propane gas (G31)
	H	Natural gas (G20)
	L	Natural gas (G25)
	E	Natural gas (G20)
Gas consumption (kW)		
Cooling	41.4	
Heating (Standard)	43.9	
Compressor		
Cooling oil (L) (type)	7.5 (HP-9)	
Crankcase heater (W)	30	
Paint color (Munsell code)	Silky Shade (1Y8.5/0.5)	

Engine		
Displacement (L)		2.488
Rated output (kW)		12.4
Oil	Type	Panasonic Genuine
	Quantity (L)	43
Starter motor		12 V DC, 2.0 kW
Starter type		AC/DC conversion type DC starter
Engine cooling water		
Quantity (L)		24
Concentration, Freezing temperature		50 V/V%, -35°C
Cooling water pump rated output (kW)		0.16
Refrigerant type, Quantity (kg)		HFC [R410A] , 11.5
Air intakes		Front and Rear
Air outlet		Top
Piping		
Refrigerant gas (mm)		ø28.58(brazed) ø31.75) (Note 4)
Refrigerant liquid (mm)		ø15.88(brazed) ø19.05) (Note 4)
Fuel gas		R3/4 (Bolt, thread)
Exhaust drain (mm)		ø25 .Rubber hose (length: 350)
Hot water supply in/out		Rp3/4 (Nut, thread)
Operating noise level dB(A)		58
Ventilation System		
Type		Propeller fans (x2)
Air flow rate (m³/min)		380
Rated output (kW)		0.70x2
Drain heater (W)		40

### Notes

- Cooling and heating capacities in the tables are determined under the test conditions of JIS B 8627.

Operating condition	Cooling	Heating (standard)	Heating (low temp.)
Indoor air intake temp.	27°CDB/19°CWB	20°CDB	20°CDB/15°CWB or less
Outdoor air intake temp.	35°CDB	7°CDB/6°CWB	2°CDB/1°CWB

- Effective heating requires that the outdoor air intake temperature be at least -20°CDB or -21°CWB.
- Gas consumption is the total (high) calorific value standard.
  - Outdoor unit operating sound is measured 1 meter from the front and 1.5 meters above the floor (in an anechoic environment). Actual installations may have larger values due to ambient noise and reflections.
  - Values in parentheses ( ) for refrigerant gas and liquid types are those when the maximum piping length exceeds 90 meters (equivalent length). (Reducers are available locally.)
  - Specifications are subject to change without notice.
  - Hot water heating capacity is applicable during cooling operation as in Note 1.
  - The maximum water temperature that can be obtained is 75°C. Water heating performance and temperature vary with the air conditioning load.

Because the hot water heating system uses waste heat from the engine, which runs the air conditioning, its ability to heat water is not guaranteed.

Model No.	U-25GEP2E5	
External dimensions (mm)		
Height	2,273	
Width	1,650	
Depth	1,000 (+80)	
Weight (kg)	825	
Performance (kW)		
Cooling capacity	71.0	
Heating capacity (Standard)	80.0	
Heating capacity (low temp.)	78.0	
Hot Water (Cooling mode)	30.0 (@ 75°C outlet) <sup>(Note 7)</sup>	
Generate electricity power source	220 to 240 V, 50 Hz, Single-phase	
Electrical rating		
Cooling	Running amperes (A)	0.52
	Power input (kW)	0.1
	Power factor (%)	84
Heating	Running amperes (A)	0.52
	Power input (kW)	0.1
	Power factor (%)	84
Starting amperes (A)	30	
Gas Type		
Gas Band	P	Propane gas (G31)
	H	Natural gas (G20)
	L	Natural gas (G25)
	E	Natural gas (G20)
Gas consumption (kW)		
Cooling	63.5	
Heating (Standard)	55.1	
Compressor		
Cooling oil (L) (type)	7.5 (HP-9)	
Crankcase heater (W)	30	
Paint color (Munsell code)	Silky Shade (1Y8.5/0.5)	

Engine		
Displacement (L)		2.488
Rated output (kW)		15.7
Oil	Type	Panasonic Genuine 43
	Quantity (L)	
Starter motor		12 V DC, 2.0 kW
Starter type		AC/DC conversion type DC starter
Engine cooling water		
Quantity (L)		25
Concentration, Freezing temperature		50 V/V%, -35°C
Cooling water pump rated output (kW)		0.16
Refrigerant type, Quantity (kg)		HFC [R410A] , 11.5
Air intakes		Front and Rear
Air outlet		Top
Piping		
Refrigerant gas (mm)		ø28.58(brazed) ø31.75) (Note 4)
Refrigerant liquid (mm)		ø15.88(brazed) ø19.05) (Note 4)
Fuel gas		R3/4 (Bolt, thread)
Exhaust drain (mm)		ø25 .Rubber hose (length: 350)
Hot water supply in/out		Rp3/4 (Nut, thread)
Operating noise level dB(A)		62
Ventilation System		
Type		Propeller fans (x2)
Air flow rate (m³/min)		380
Rated output (kW)		0.70x2
Drain heater (W)		40

### Notes

- Cooling and heating capacities in the tables are determined under the test conditions of JIS B 8627.

Operating condition	Cooling	Heating (standard)	Heating (low temp.)
Indoor air intake temp.	27°CDB/19°CWB	20°CDB	20°CDB/15°CWB or less
Outdoor air intake temp.	35°CDB	7°CDB/6°CWB	2°CDB/1°CWB

- Effective heating requires that the outdoor air intake temperature be at least -20°CDB or -21°CWB.

- Gas consumption is the total (high) calorific value standard.
- Outdoor unit operating sound is measured 1 meter from the front and 1.5 meters above the floor (in an anechoic environment). Actual installations may have larger values due to ambient noise and reflections.
- Values in parentheses ( ) for refrigerant gas and liquid types are those when the maximum piping length exceeds 90 meters (equivalent length). (Reducers are available locally.)
- Specifications are subject to change without notice.
- Hot water heating capacity is applicable during cooling operation as in Note 1.
- The maximum water temperature that can be obtained is 75°C. Water heating performance and temperature vary with the air conditioning load.

Because the hot water heating system uses waste heat from the engine, which runs the air conditioning, its ability to heat water is not guaranteed.

Model No.	U-30GE2E5	
External dimensions (mm)		
Height	2,273	
Width	2,026	
Depth	1,000 (+80)	
Weight (kg)	840	
Performance (kW)		
Cooling capacity	85.0	
Heating capacity (Standard)	95.0	
Heating capacity (low temp.)	90.0	
Hot Water (Cooling mode)	30.0 (@ 75°C outlet) <sup>(Note 7)</sup>	
Generate electricity power source	220 to 240 V, 50 Hz, Single-phase	
Electrical rating		
Cooling	Running amperes (A)	8.03
	Power input (kW)	1.7
	Power factor (%)	92
Heating	Running amperes (A)	6.93
	Power input (kW)	1.45
	Power factor (%)	91
Starting amperes (A)	30	
Gas Type		
Gas Band	P	Propane gas (G31)
	H	Natural gas (G20)
	L	Natural gas (G25)
	E	Natural gas (G20)
Gas consumption (kW)		
Cooling	67.9	
Heating (Standard)	68.1	
Compressor		
Cooling oil (L) (type)	5.5 (HP-9)	
Crankcase heater (W)	30	
Paint color (Munsell code)	Silky Shade (1Y8.5/0.5)	

Engine		
Displacement (L)		2.488
Rated output (kW)		18.8
Oil	Type	Panasonic Genuine 50
	Quantity (L)	
Starter motor		12 V DC, 2.0 kW
Starter type		AC/DC conversion type DC starter
Engine cooling water		
Quantity (L)		26
Concentration, Freezing temperature		50 V/V%, -35°C
Cooling water pump rated output (kW)		0.16
Refrigerant type, Quantity (kg)		HFC [R410A] , 11.5
Air intakes		Front and Rear
Air outlet		Top
Piping		
Refrigerant gas (mm)		ø31.75(brazed) (ø38.1) (Note 4)
Refrigerant liquid (mm)		ø19.05(brazed) (ø22.22) (Note 4)
Fuel gas		R3/4 (Bolt, thread)
Exhaust drain (mm)		ø25 .Rubber hose (length: 350)
Hot water supply in/out		Rp3/4 (Nut, thread)
Operating noise level dB(A)		63
Ventilation System		
Type		Propeller fans (x2)
Air flow rate (m³/min)		440
Rated output (kW)		0.70x2
Drain heater (W)		40

### Notes

- Cooling and heating capacities in the tables are determined under the test conditions of JIS B 8627.

Operating condition	Cooling	Heating (standard)	Heating (low temp.)
Indoor air intake temp.	27°CDB/19°CWB	20°CDB	20°CDB/15°CWB or less
Outdoor air intake temp.	35°CDB	7°CDB/6°CWB	2°CDB/1°CWB

- Effective heating requires that the outdoor air intake temperature be at least -20°CDB or -21°CWB.

- Gas consumption is the total (high) calorific value standard.
- Outdoor unit operating sound is measured 1 meter from the front and 1.5 meters above the floor (in an anechoic environment). Actual installations may have larger values due to ambient noise and reflections.
- Values in parentheses ( ) for refrigerant gas and liquid types are those when the maximum piping length exceeds 90 meters (equivalent length). (Reducers are available locally.)
- Specifications are subject to change without notice.
- Hot water heating capacity is applicable during cooling operation as in Note 1.
- The maximum water temperature that can be obtained is 75°C. Water heating performance and temperature vary with the air conditioning load.

Because the hot water heating system uses waste heat from the engine, which runs the air conditioning, its ability to heat water is not guaranteed.

Model No.	U-16GF2E5	
External dimensions (mm)		
Height	2,273	
Width	1,650	
Depth	1,000 (+80)	
Weight (kg)	775	
Performance (kW)		
Cooling capacity	45.0	
Heating capacity (Standard)	50.0	
Heating capacity (low temp.)	53.0	
Generate electricity power source	220 to 240 V, 50 Hz, Single-phase	
Electrical rating		
Cooling	Running amperes (A)	3.36
	Power input (kW)	0.71
	Power factor (%)	92
Heating	Running amperes (A)	2.87
	Power input (kW)	0.6
	Power factor (%)	91
Starting amperes (A)	30	
Gas Type		
Gas Band	P	Propane gas (G31)
	H	Natural gas (G20)
	L	Natural gas (G25)
	E	Natural gas (G20)
Gas consumption (kW)		
Cooling	29.7	
Heating (Standard)	32.5	
Compressor		
Cooling oil (L) (type)	7.5 (HP-9)	
Crankcase heater (W)	30	
Paint color (Munsell code)	Silky Shade (1Y8.5/0.5)	

Engine		
Displacement (L)		2.488
Rated output (kW)		10.0
Oil	Type	Panasonic Genuine
	Quantity (L)	43
Starter motor		12 V DC, 2.0 kW
Starter type		AC/DC conversion type DC starter
Engine cooling water		
Quantity (L)		24
Concentration, Freezing temperature		50 V/V%, -35°C
Cooling water pump rated output (kW)		0.16
Refrigerant type, Quantity (kg)		HFC [R410A] , 10.5
Air intakes		Front and Rear
Air outlet		Top
Piping		
Refrigerant discharge	ø22.22(brazed) (ø25.4) (Note 4)	
Refrigerant gas (mm)	ø28.58(brazed) (ø31.75) (Note 4)	
Refrigerant liquid (mm)	ø19.05(brazed) (ø22.22) (Note 4)	
Fuel gas	R3/4 (Bolt, thread)	
Exhaust drain (mm)	ø25 .Rubber hose (length: 350)	
Hot water supply in/out	Rp3/4 (Nut, thread)	
Operating noise level dB(A)	57	
Ventilation System		
Type	Propeller fans (x2)	
Air flow rate (m³/min)	380	
Rated output (kW)	0.70x2	
Drain heater (W)	40	

### Notes

- Cooling and heating capacities in the tables are determined under the test conditions of JIS B 8627.

Operating condition	Cooling	Heating (standard)	Heating (low temp.)
Indoor air intake temp.	27°CDB/19°CWB	20°CDB	20°CDB/15°CWB or less
Outdoor air intake temp.	35°CDB	7°CDB/6°CWB	2°CDB/1°CWB

- Effective heating requires that the outdoor air intake temperature be at least -20°CDB or -21°CWB.
- Gas consumption is the total (high) calorific value standard.
  - Outdoor unit operating sound is measured 1 meter from the front and 1.5 meters above the floor (in an anechoic environment). Actual installations may have larger values due to ambient noise and reflections.
  - Values in parentheses ( ) for refrigerant gas and liquid types are those when the maximum piping length exceeds 90 meters (equivalent length). (Reducers are available locally.)
  - Specifications are subject to change without notice.
  - Hot water heating capacity is applicable during cooling operation as in Note 1.

Model No.	U-20GF2E5	
External dimensions (mm)		
Height	2,273	
Width	1,650	
Depth	1,000 (+80)	
Weight (kg)	775	
Performance (kW)		
Cooling capacity	56.0	
Heating capacity (Standard)	63.0	
Heating capacity (low temp.)	67.0	
Generate electricity power source	220 to 240 V, 50 Hz, Single-phase	
Electrical rating		
Cooling	Running amperes (A)	4.87
	Power input (kW)	1.02
	Power factor (%)	91
Heating	Running amperes (A)	3.02
	Power input (kW)	0.64
	Power factor (%)	92
Starting amperes (A)	30	
Gas Type		
Gas Band	P	Propane gas (G31)
	H	Natural gas (G20)
	L	Natural gas (G25)
	E	Natural gas (G20)
Gas consumption (kW)		
Cooling	39.1	
Heating (Standard)	42.5	
Compressor		
Cooling oil (L) (type)	7.5 (HP-9)	
Crankcase heater (W)	30	
Paint color (Munsell code)	Silky Shade (1Y8.5/0.5)	

Engine		
Displacement (L)		2.488
Rated output (kW)		12.4
Oil	Type	Panasonic Genuine
	Quantity (L)	43
Starter motor		12 V DC, 2.0 kW
Starter type		AC/DC conversion type DC starter
Engine cooling water		
Quantity (L)		24
Concentration, Freezing temperature		50 V/V%, -35°C
Cooling water pump rated output (kW)		0.16
Refrigerant type, Quantity (kg)		HFC [R410A] , 11.5
Air intakes		Front and Rear
Air outlet		Top
Piping		
Refrigerant discharge	ø25.4(brazed) (ø28.58) (Note 4)	
Refrigerant gas (mm)	ø28.58(brazed) (ø31.75) (Note 4)	
Refrigerant liquid (mm)	ø19.05(brazed) (ø22.22) (Note 4)	
Fuel gas	R3/4 (Bolt, thread)	
Exhaust drain (mm)	ø25 .Rubber hose (length: 350)	
Hot water supply in/out	Rp3/4 (Nut, thread)	
Operating noise level dB(A)		58
Ventilation System		
Type	Propeller fans (x2)	
Air flow rate (m³/min)	380	
Rated output (kW)	0.70x2	
Drain heater (W)		40

### Notes

- Cooling and heating capacities in the tables are determined under the test conditions of JIS B 8627.

Operating condition	Cooling	Heating (standard)	Heating (low temp.)
Indoor air intake temp.	27°CDB/19°CWB	20°CDB	20°CDB/15°CWB or less
Outdoor air intake temp.	35°CDB	7°CDB/6°CWB	2°CDB/1°CWB

- Effective heating requires that the outdoor air intake temperature be at least -20°CDB or -21°CWB.
- Gas consumption is the total (high) calorific value standard.
  - Outdoor unit operating sound is measured 1 meter from the front and 1.5 meters above the floor (in an anechoic environment). Actual installations may have larger values due to ambient noise and reflections.
  - Values in parentheses ( ) for refrigerant gas and liquid types are those when the maximum piping length exceeds 90 meters (equivalent length). (Reducers are available locally.)
  - Specifications are subject to change without notice.
  - Hot water heating capacity is applicable during cooling operation as in Note 1.



Model No.	U-25GF2E5	
External dimensions (mm)		
Height	2,273	
Width	1,650	
Depth	1,000 (+80)	
Weight (kg)	805	
Performance (kW)		
Cooling capacity	71.0	
Heating capacity (Standard)	80.0	
Heating capacity (low temp.)	78.0	
Generate electricity power source	220 to 240 V, 50 Hz, Single-phase	
Electrical rating		
Cooling	Running amperes (A)	6.22
	Power input (kW)	1.33
	Power factor (%)	93
Heating	Running amperes (A)	3.92
	Power input (kW)	0.83
	Power factor (%)	92
Starting amperes (A)	30	
Gas Type		
Gas Band	P	Propane gas (G31)
	H	Natural gas (G20)
	L	Natural gas (G25)
	E	Natural gas (G20)
Gas consumption (kW)		
Cooling	60.4	
Heating (Standard)	53.2	
Compressor		
Cooling oil (L) (type)	7.5 (HP-9)	
Crankcase heater (W)	30	
Paint color (Munsell code)	Silky Shade (1Y8.5/0.5)	

Engine		
Displacement (L)		2.488
Rated output (kW)		15.7
Oil	Type	Panasonic Genuine
	Quantity (L)	43
Starter motor		12 V DC, 2.0 kW
Starter type		AC/DC conversion type DC starter
Engine cooling water		
Quantity (L)		29
Concentration, Freezing temperature		50 V/V%, -35°C
Cooling water pump rated output (kW)		0.16
Refrigerant type, Quantity (kg)		HFC [R410A] , 11.5
Air intakes		Front and Rear
Air outlet		Top
Piping		
Refrigerant discharge	ø25.4(brazed) (ø28.58) (Note 4)	
Refrigerant gas (mm)	ø28.58(brazed) (ø31.75) (Note 4)	
Refrigerant liquid (mm)	ø19.05(brazed) (ø22.22) (Note 4)	
Fuel gas	R3/4 (Bolt, thread)	
Exhaust drain (mm)	ø25 .Rubber hose (length: 350)	
Hot water supply in/out	Rp3/4 (Nut, thread)	
Operating noise level dB(A)		62
Ventilation System		
Type	Propeller fans (x2)	
Air flow rate (m³/min)	380	
Rated output (kW)	0.70x2	
Drain heater (W)		40

### Notes

- Cooling and heating capacities in the tables are determined under the test conditions of JIS B 8627.

Operating condition	Cooling	Heating (standard)	Heating (low temp.)
Indoor air intake temp.	27°CDB/19°CWB	20°CDB	20°CDB/15°CWB or less
Outdoor air intake temp.	35°CDB	7°CDB/6°CWB	2°CDB/1°CWB

- Effective heating requires that the outdoor air intake temperature be at least -20°CDB or -21°CWB.
- Gas consumption is the total (high) calorific value standard.
  - Outdoor unit operating sound is measured 1 meter from the front and 1.5 meters above the floor (in an anechoic environment). Actual installations may have larger values due to ambient noise and reflections.
  - Values in parentheses ( ) for refrigerant gas and liquid types are those when the maximum piping length exceeds 90 meters (equivalent length). (Reducers are available locally.)
  - Specifications are subject to change without notice.
  - Hot water heating capacity is applicable during cooling operation as in Note 1.

### Service Clearances for Installation (Units:mm)

Type	Size (mm)
① Gas refrigerant pipe	45.0kW 56.0kW
② Liquid refrigerant pipe	71.0kW Ø28.58
③ Exhaust gas drain port	Ø12.7 [Ø15.88 HOSE OD:Ø25 (accessory)]
④ Electrical power supply port	Ø28
⑤ Inter-unit cable port	Ø28
⑥ Fuel gas port	R3/4
⑦ Condensation drain opening	Ø20
⑧ Rain and condensation outlet	
⑨ Engine exhaust outlet	
⑩ Suspension holes 4-Ø20x30	
⑪ Anchor holes 4-Ø22x30	
⑫ Segmented display	
⑬ Coolant intake (top)	
⑭ Vent	
⑮ Hot water intake	Rp3/4
⑯ Hot water outlet	Rp3/4

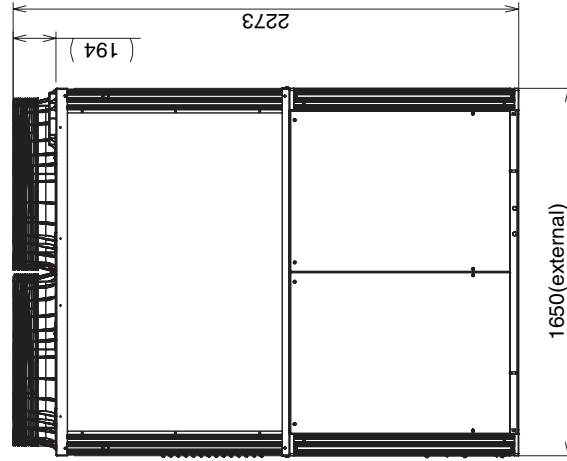
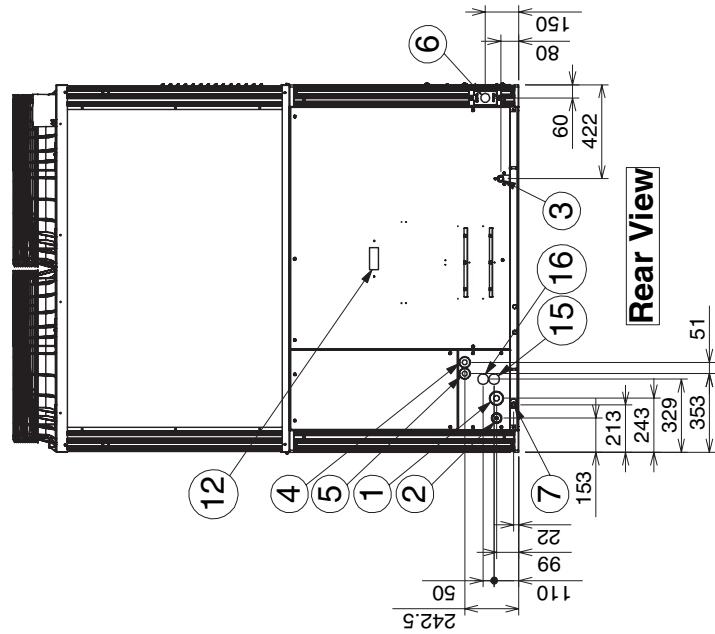
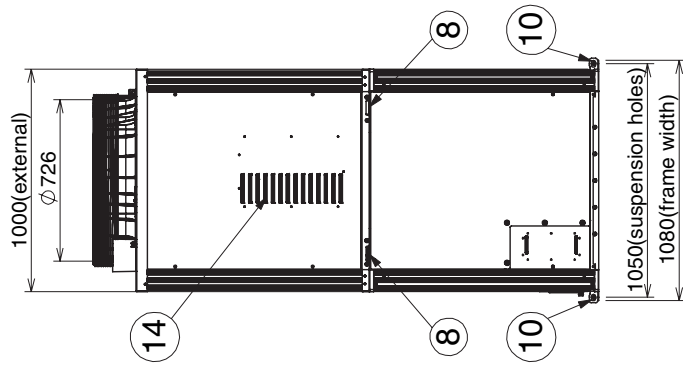
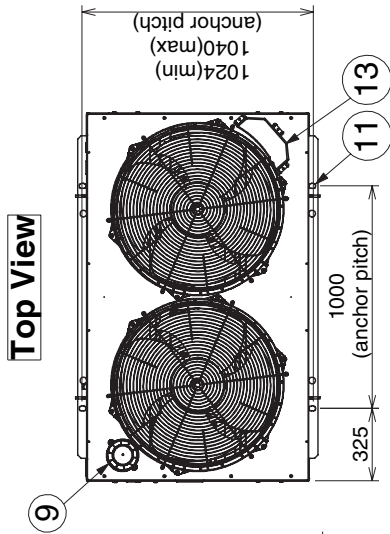
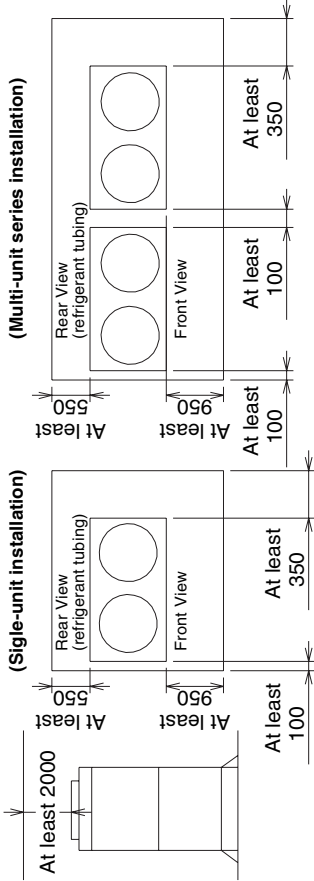

Model Name	U-16GE(P)2E5 U-20GE(P)2E5 U-25GE(P)2E5	External dimensions drawing	Scale	Free
------------	--	-----------------------------	-------	------



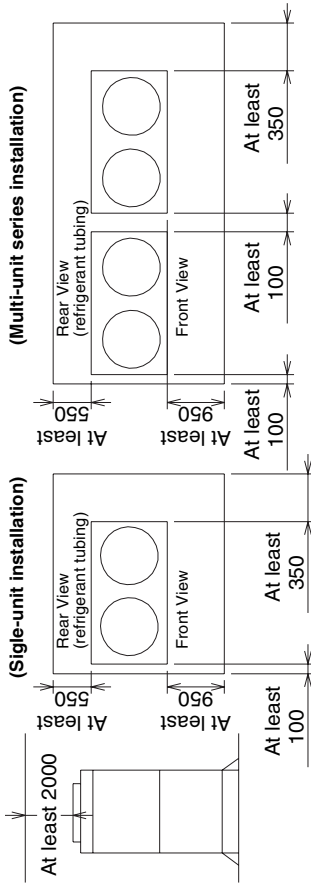
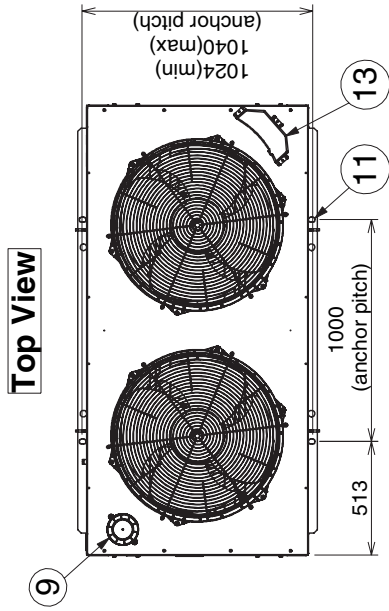

	Size (mm)
① Gas refrigerant pipe	Ø31.75
② Liquid refrigerant pipe	Ø19.05
③ Exhaust gas drain port (accessory)	HOSE OD:Ø25
④ Electrical power supply port	Ø28
⑤ Inter-unit cable port	Ø28
⑥ Fuel gas port	Rp3/4
⑦ Condensation drain opening	Ø20
⑧ Rain and condensation outlet	
⑨ Engine exhaust outlet	
⑩ Suspension holes 4-Ø20×30	
⑪ Anchor holes 4-Ø22×30	
⑫ Segmented display	
⑬ Coolant intake (top)	
⑭ Vent	
⑮ Hot water intake	Rp3/4
⑯ Hot water outlet	Rp3/4

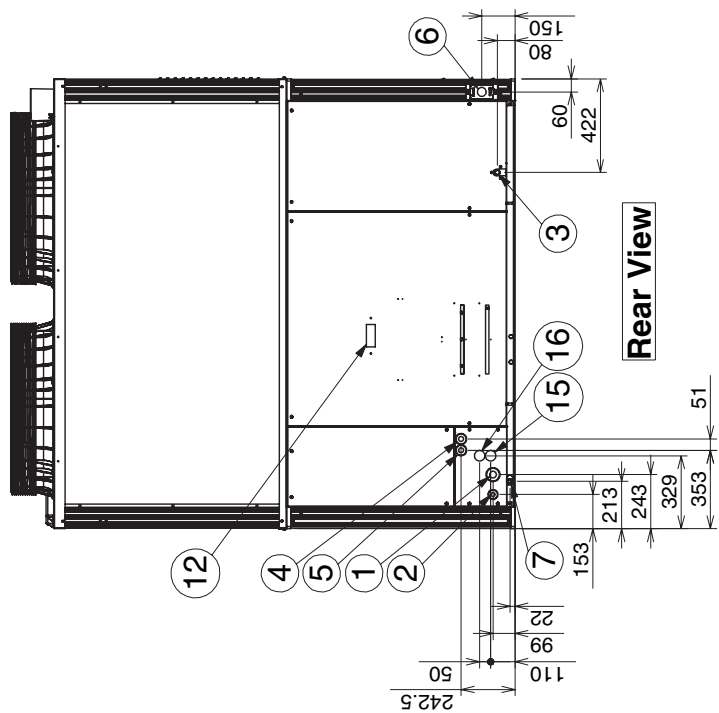
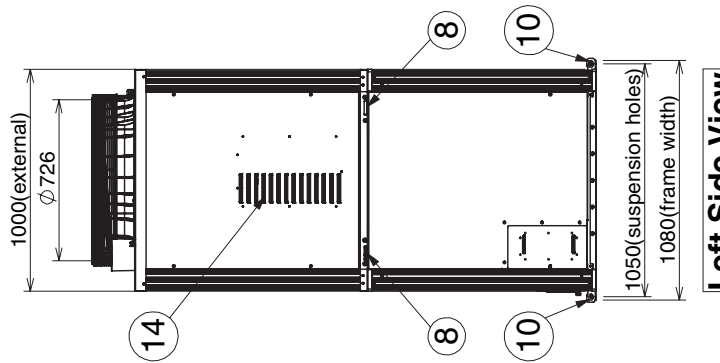
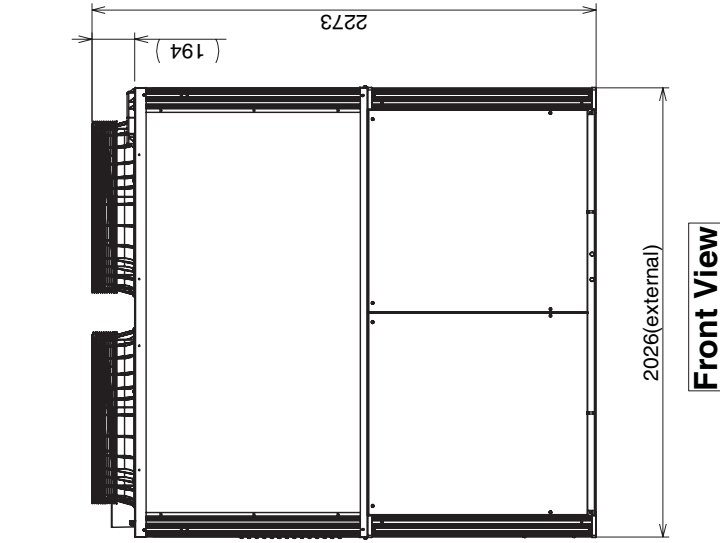

Model Name	U-30GE2E5	External dimensions drawing	Scale	Free
------------	-----------	-----------------------------	-------	------

### Service Clearances for Installation (Units:mm)

Type	Size (mm)
	45.0kW
	56.0kW
	71.0kW
① Suction refrigerant pipe	Ø28.58
② Discharge refrigerant pipe	Ø22.22 / Ø25.4
③ Liquid refrigerant pipe	Ø19.05
④ Exhaust gas drain port	HOSE OD:Ø25 (accessory)
⑤ Electrical power supply port	Ø28
⑥ Inter-unit cable port	Ø28
⑦ Fuel gas port	R3/4
⑧ Condensation drain opening	Ø20
⑨ Rain and condensation outlet	
⑩ Engine exhaust outlet	
⑪ Suspension holes 4-Ø20×30	
⑫ Anchor holes 4-Ø22×30	
⑬ Segmented display	
⑭ Coolant intake (top)	
⑮ Vent	

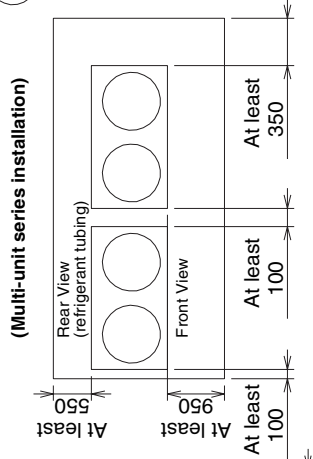
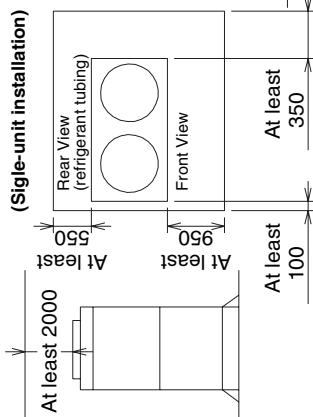

### Top View

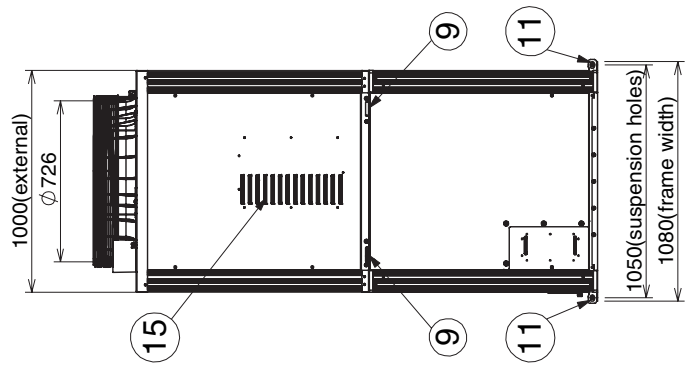
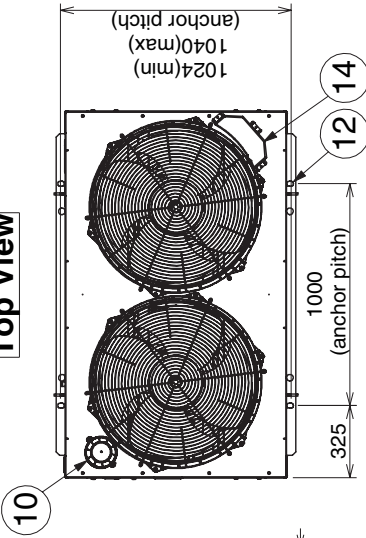

### Left Side View

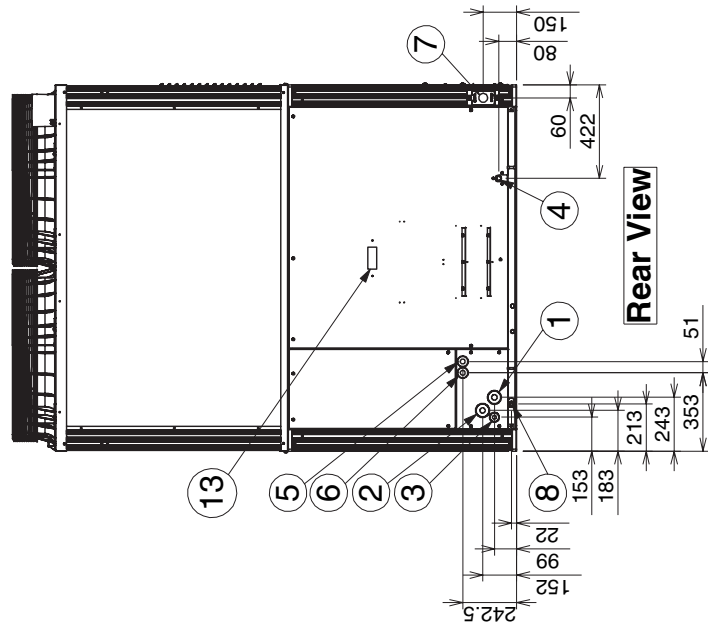

### Rear View

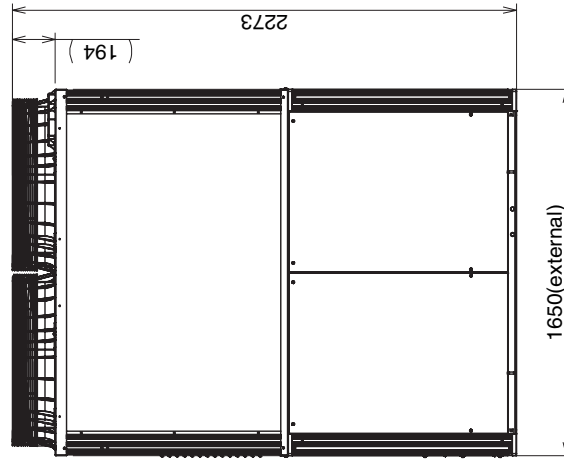

### Front View

Model Name	U-16GF2E5 U-20GF2E5 U-25GF2E5	External dimensions drawing	Scale	Free
------------	-------------------------------------	-----------------------------	-------	------

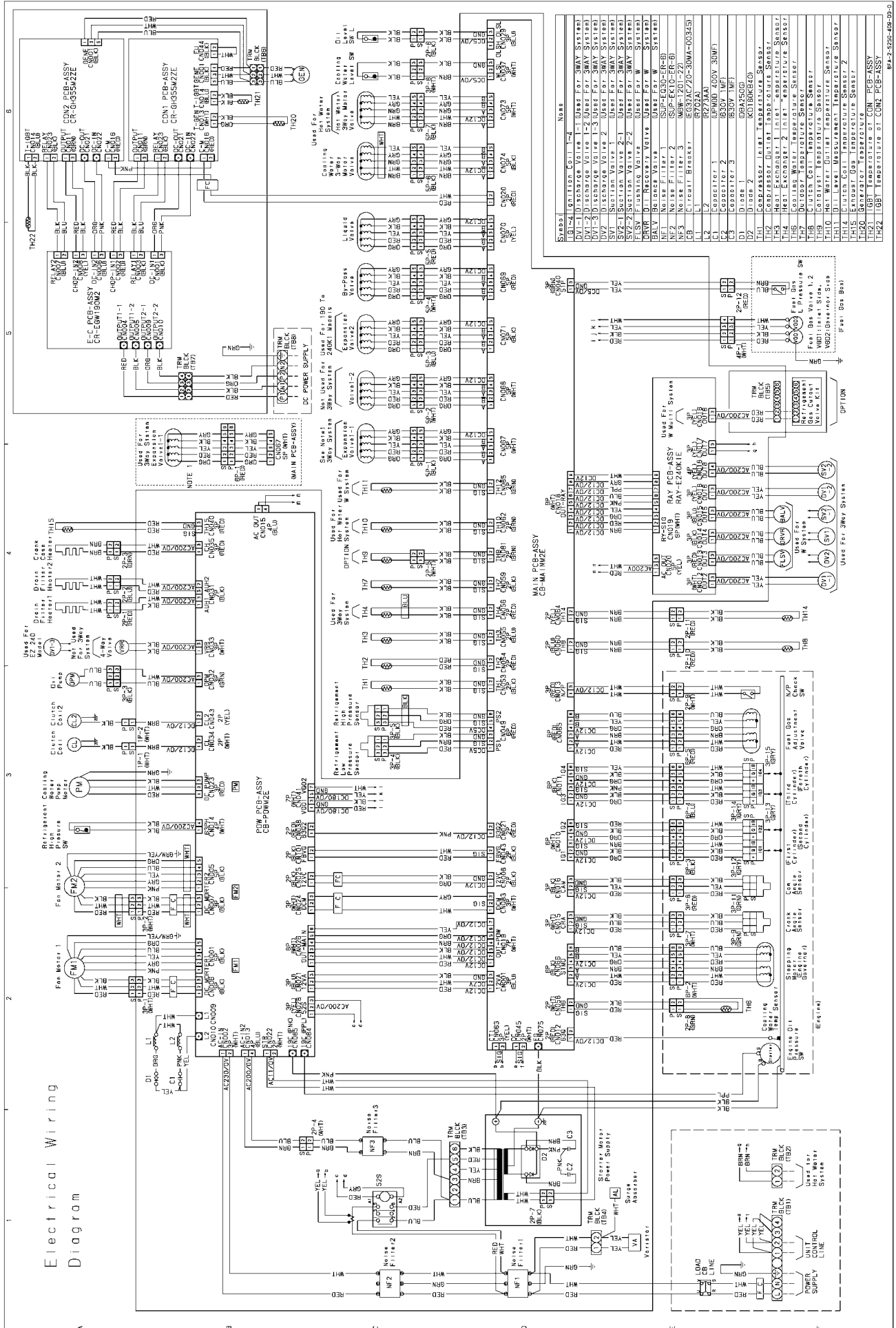

<Cooling>

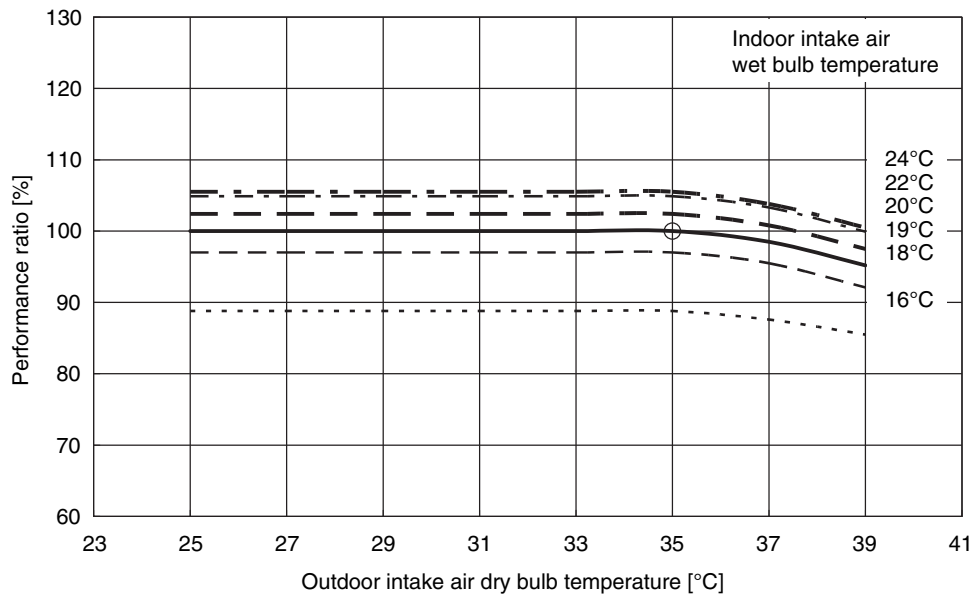

<Heating>

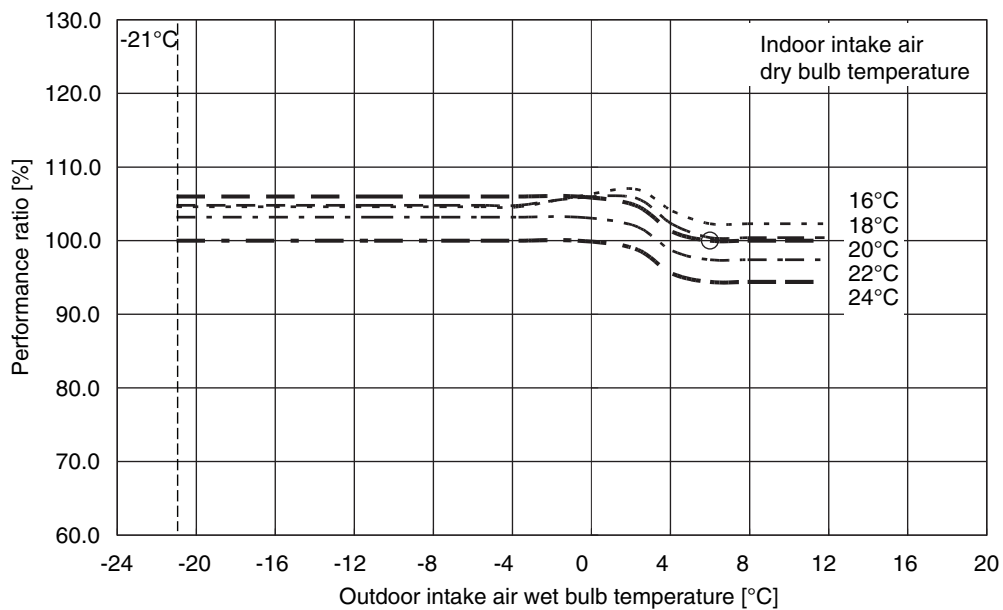

U-16GE2E5

<Cooling>

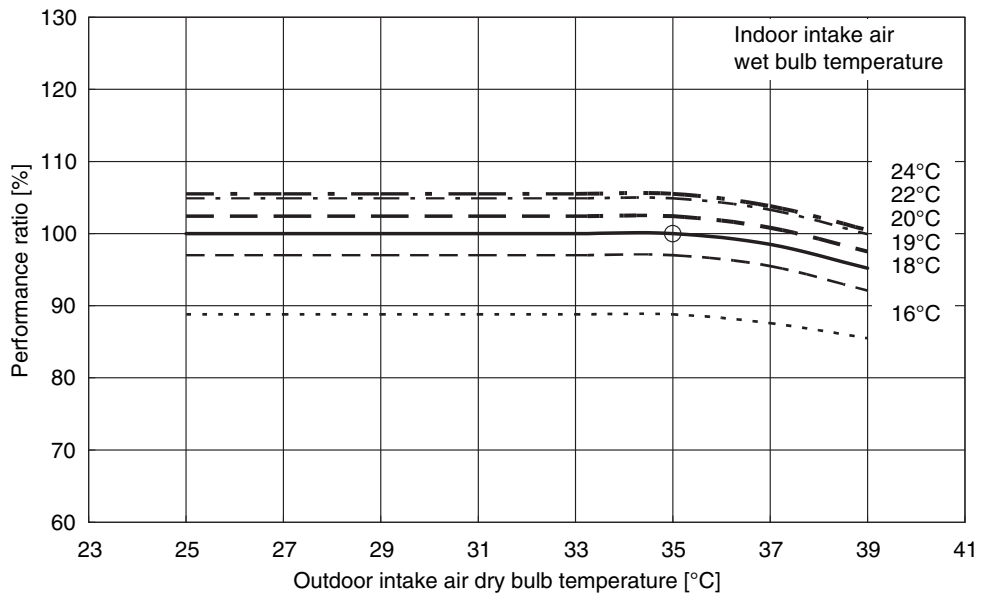

<Heating>

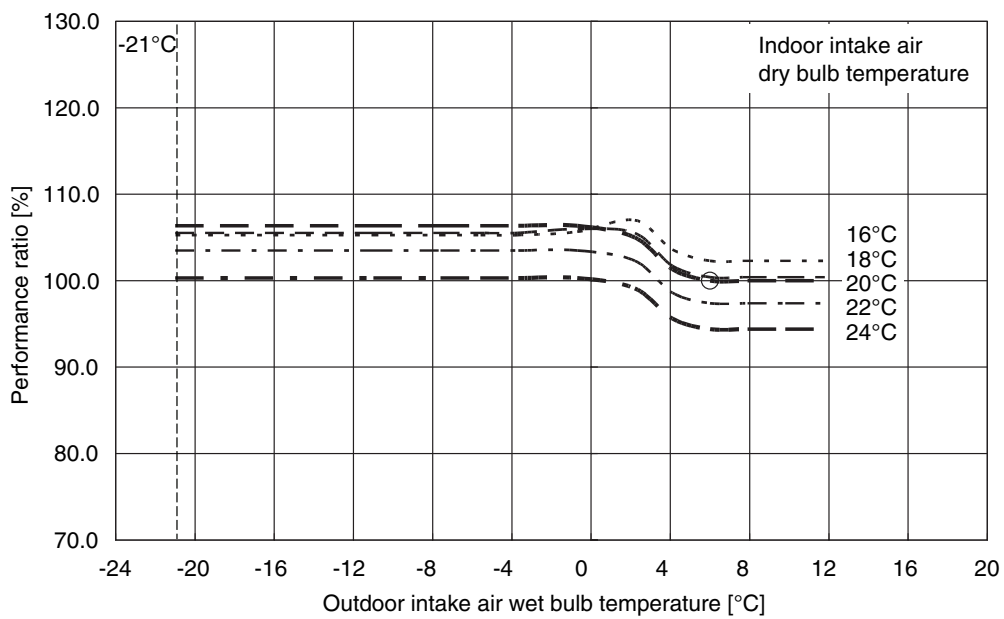

U-20GE2E5

### <Cooling>

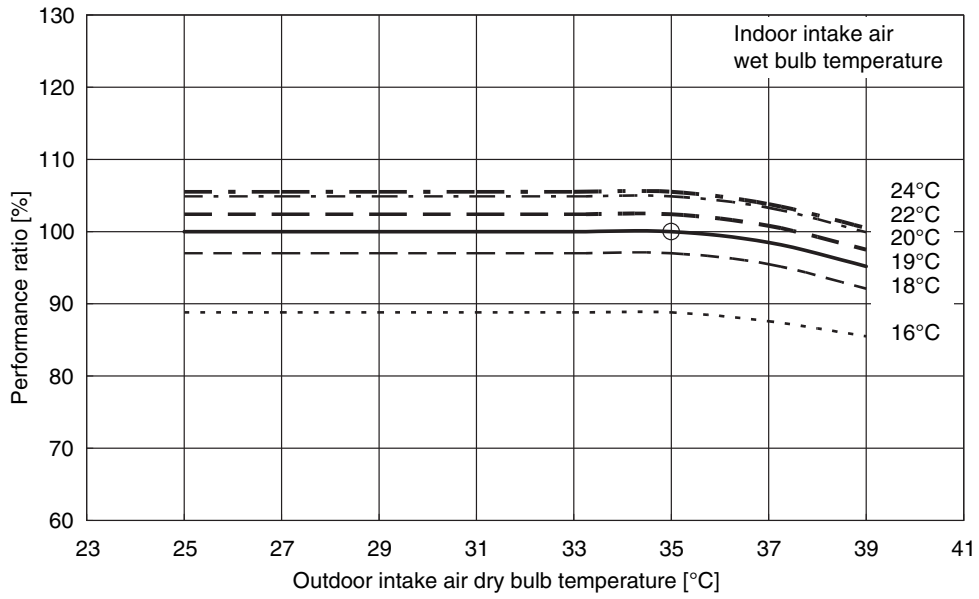

### <Heating>

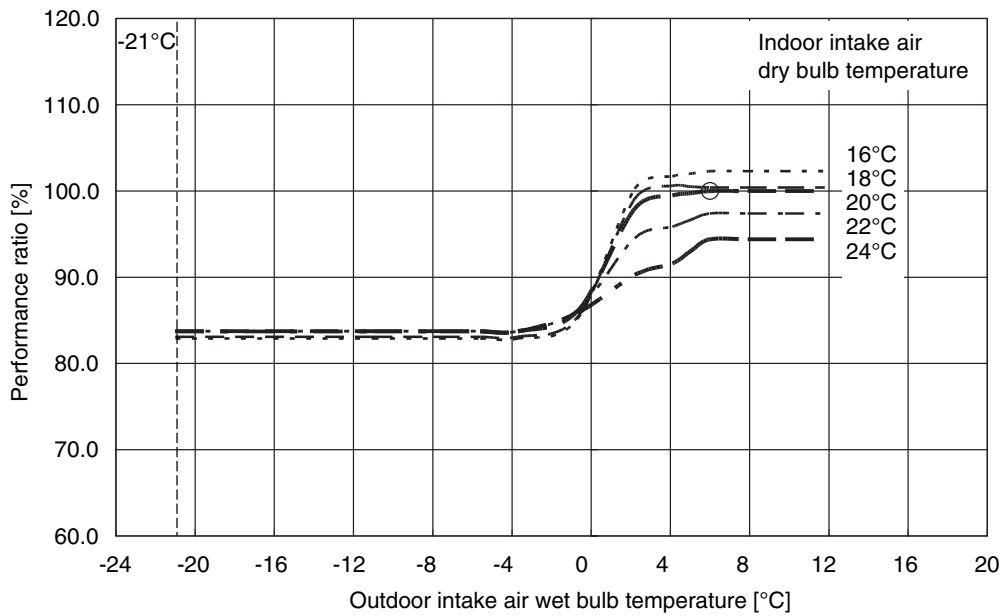

U-25GE2E5

### <Cooling>

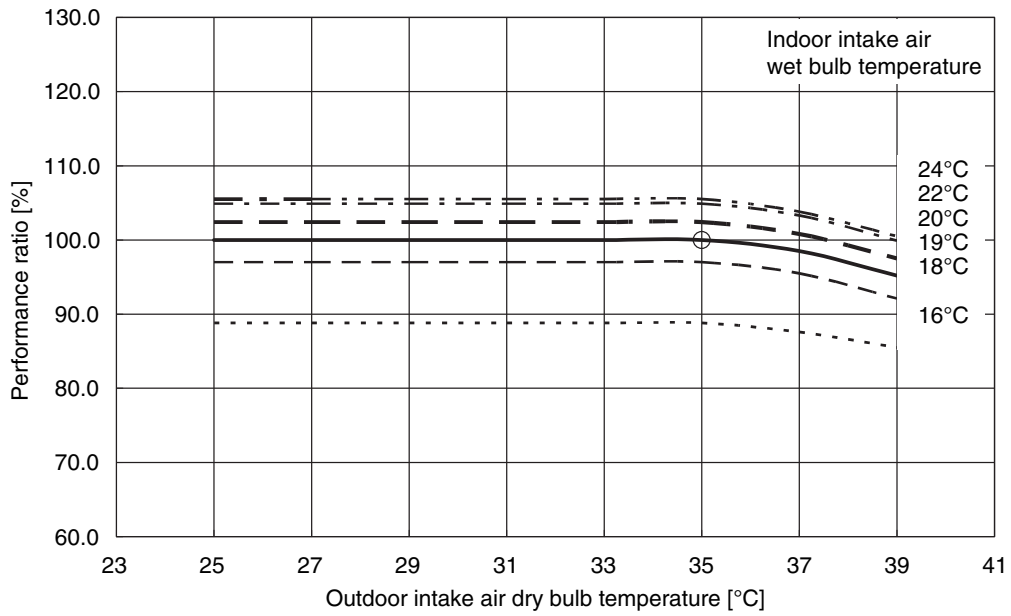

### <Heating>

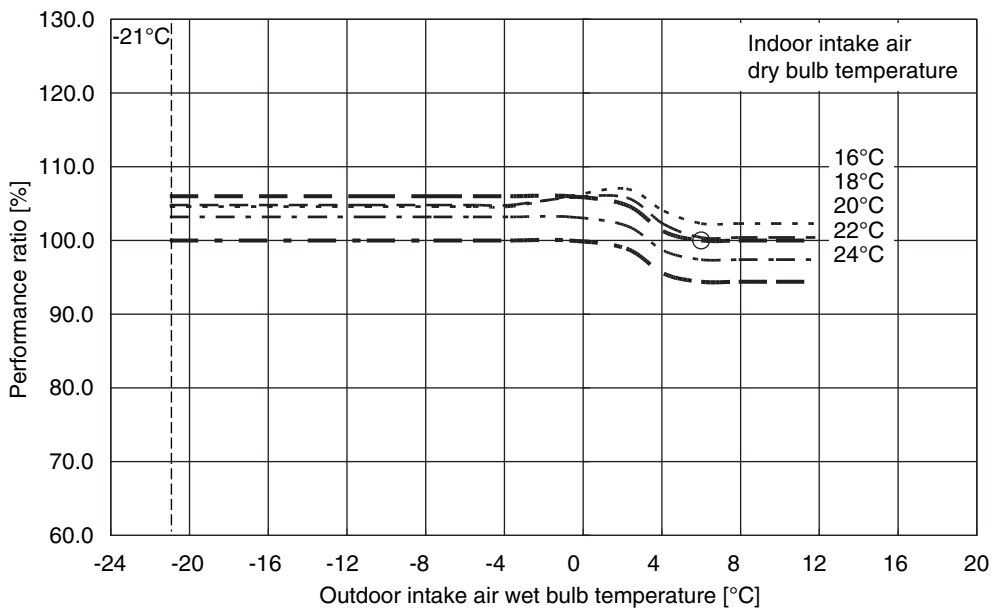

U-16GEP2E5

### <Cooling>

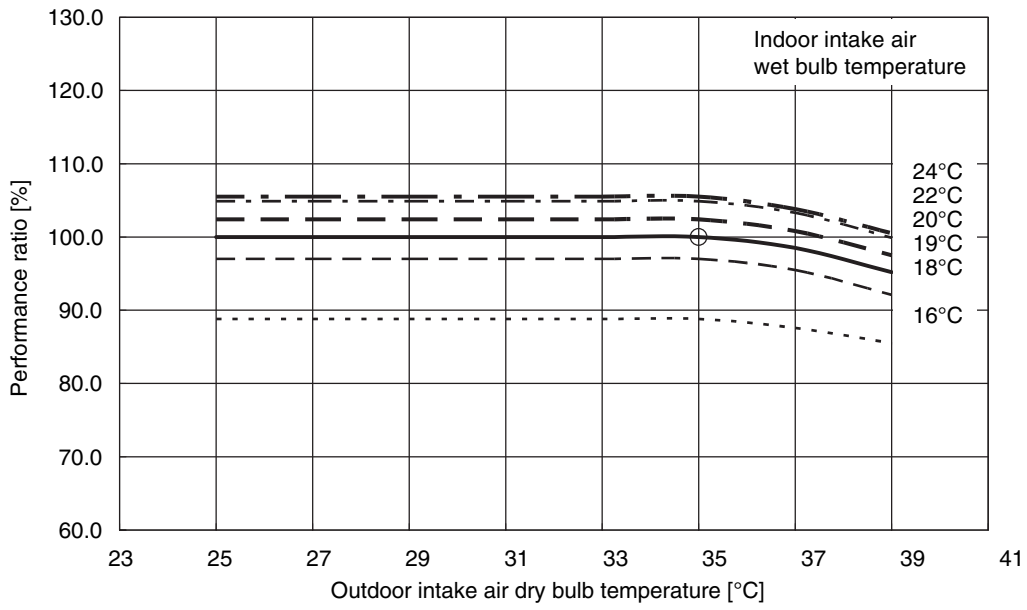

### <Heating>

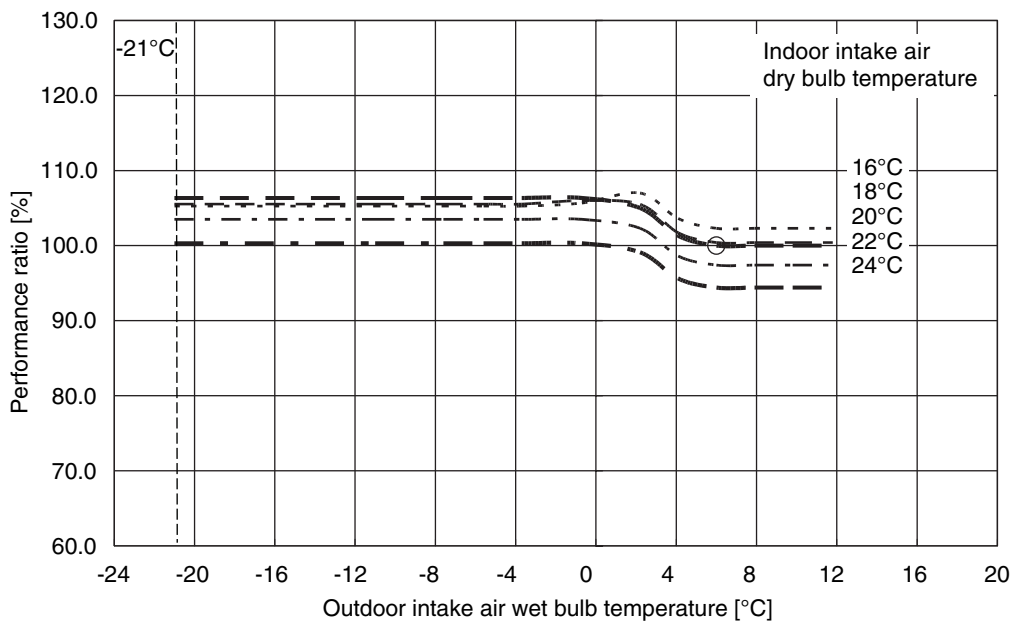

U-20GEP2E5



### <Cooling>

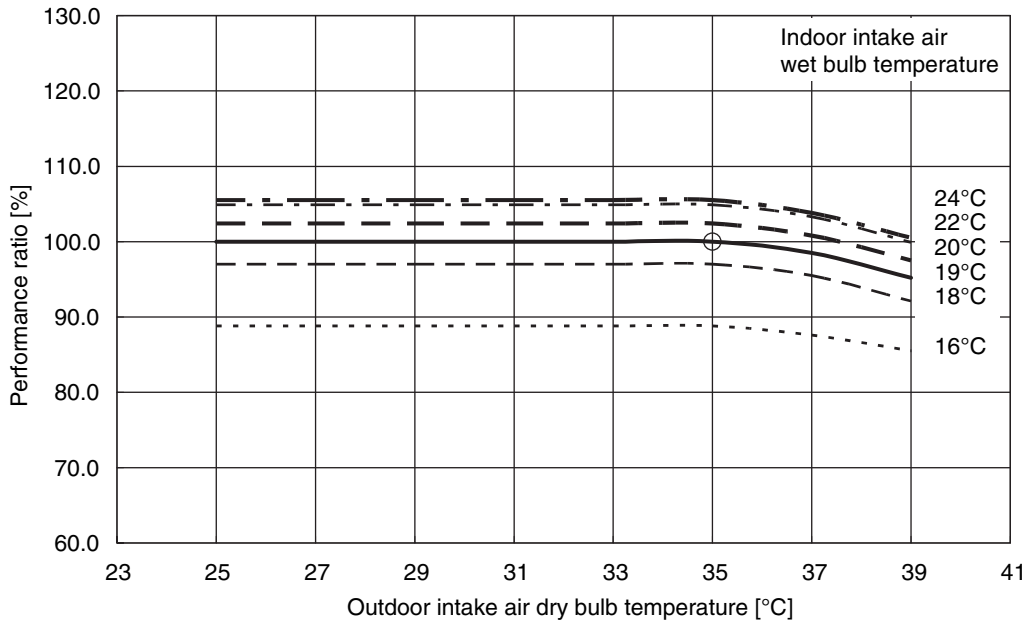

### <Heating>

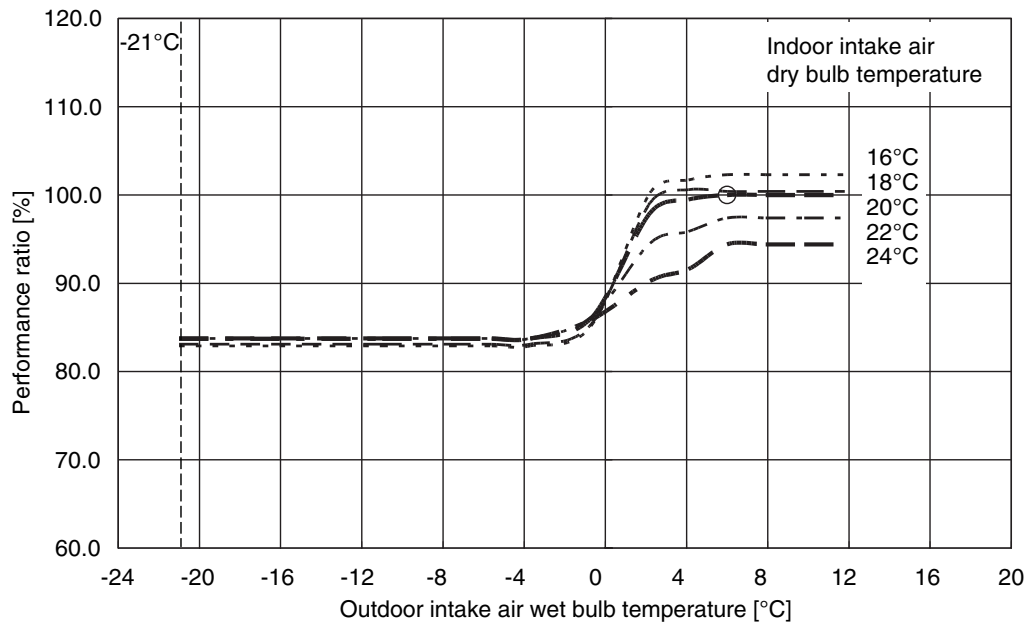

U-25GEP2E5

### <Cooling>

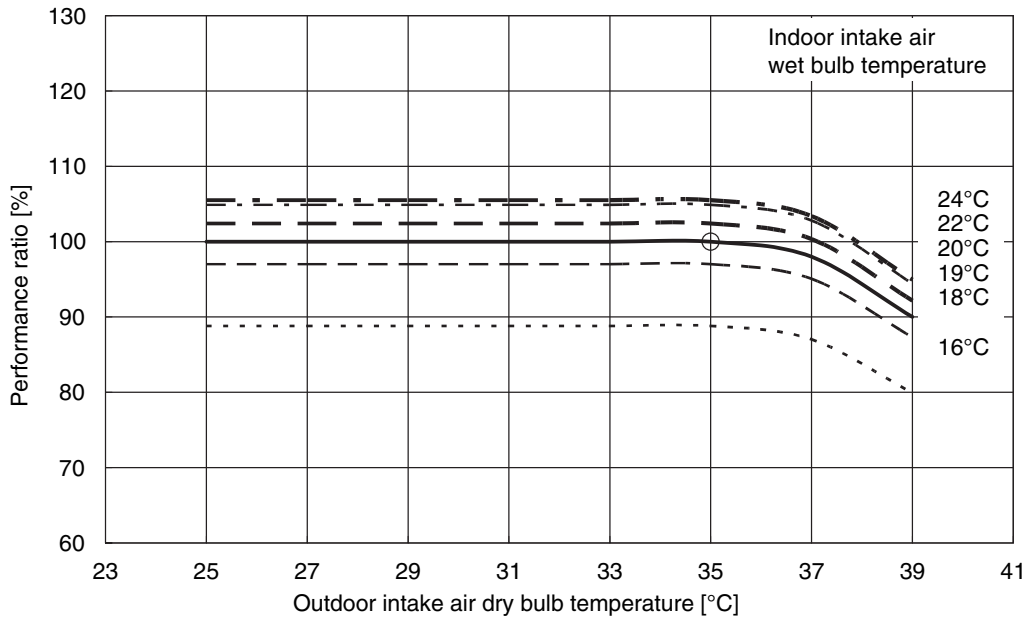

### <Heating>

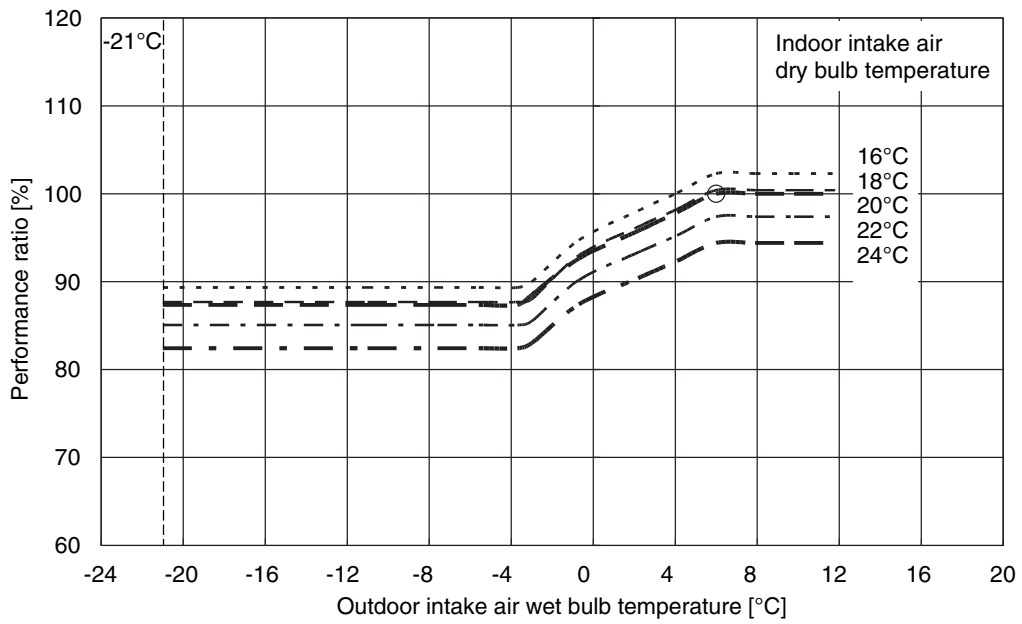

U-30GE2E5

<Cooling>

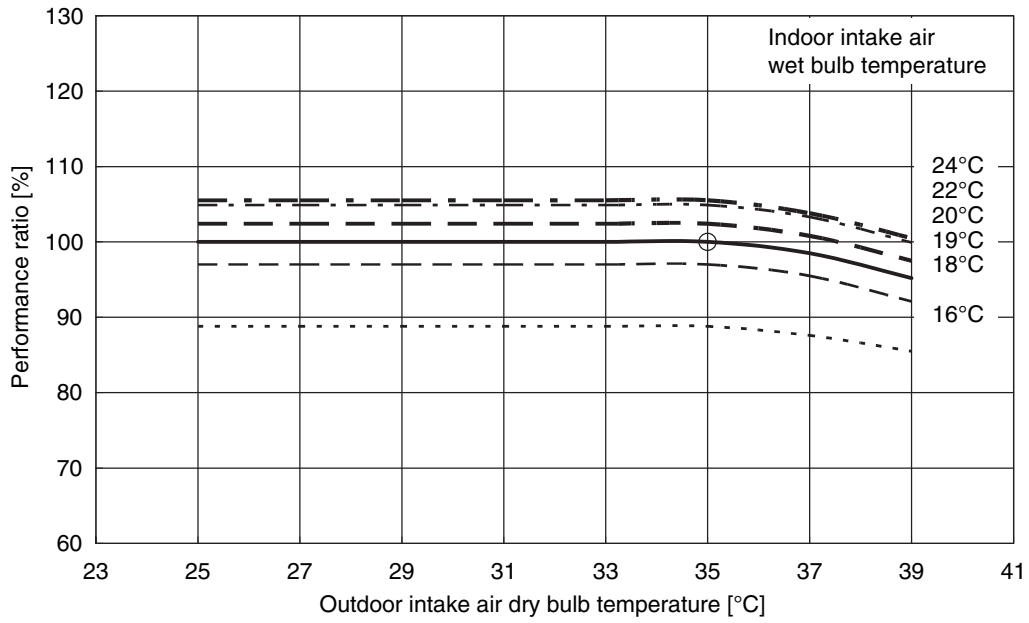

<Heating>

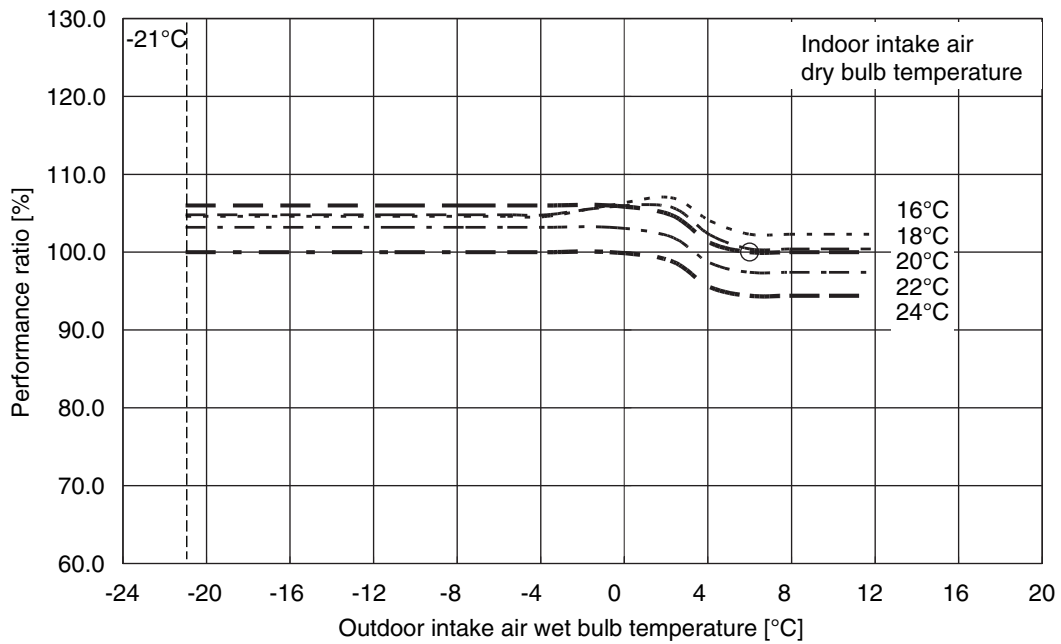

U-16GF2E5

### <Cooling>

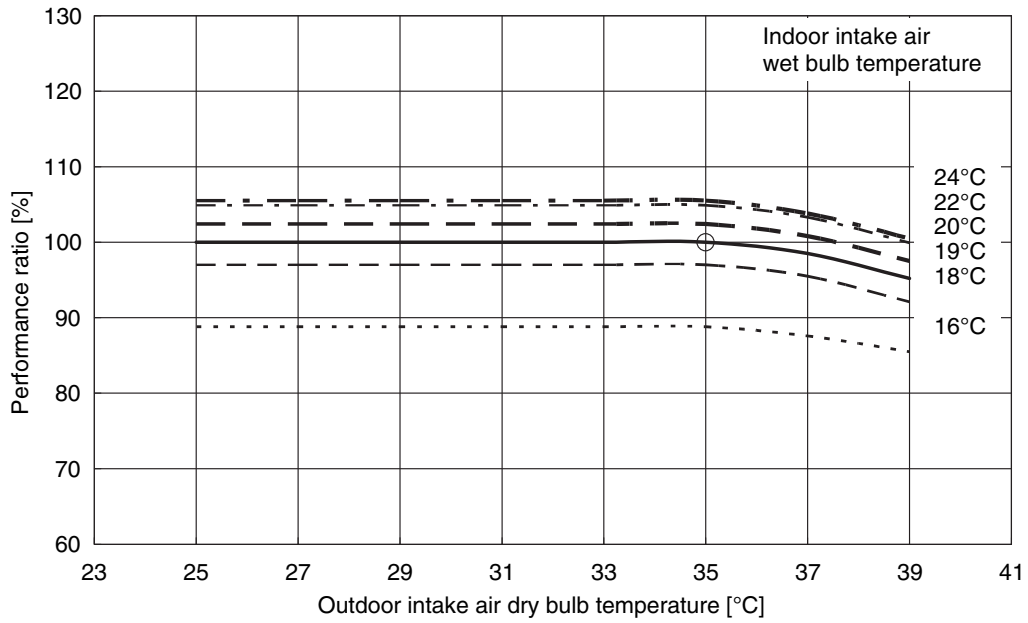

### <Heating>

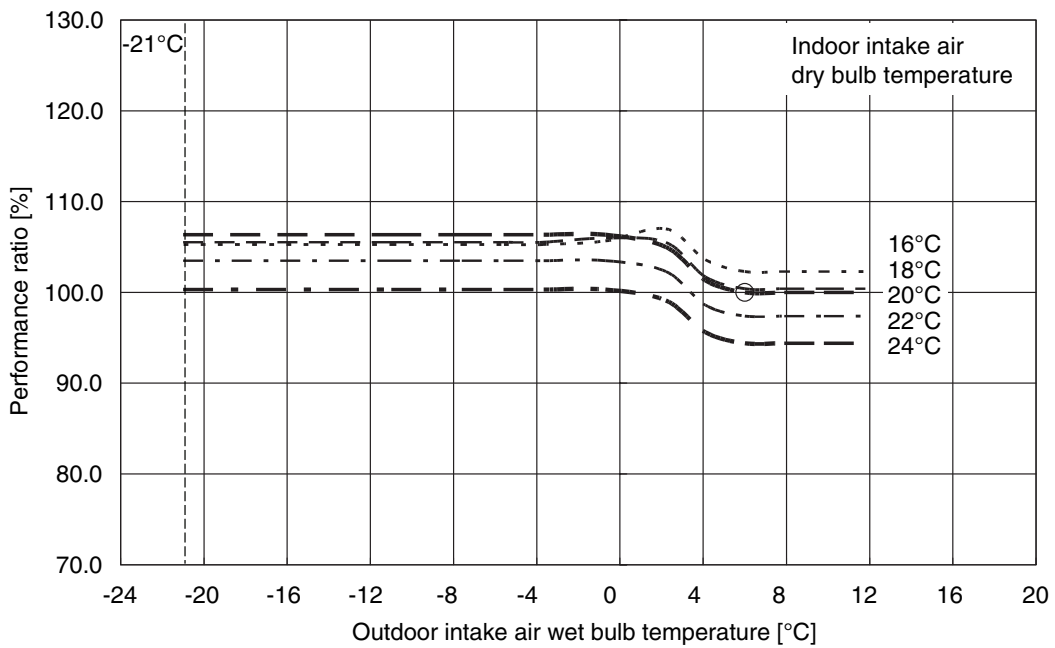

U-20GF2E5

### <Cooling>

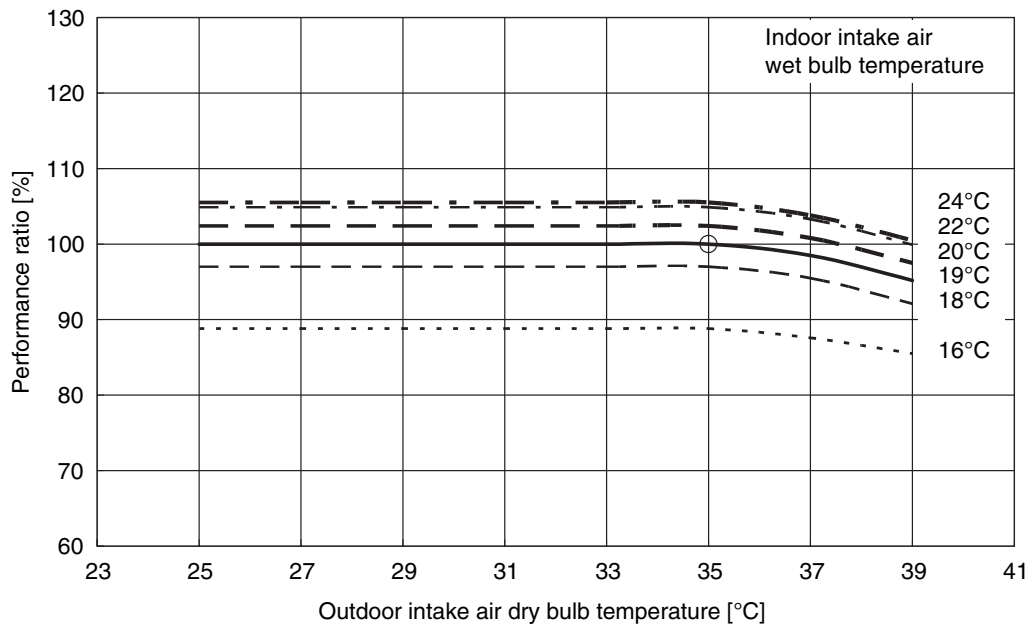

### <Heating>

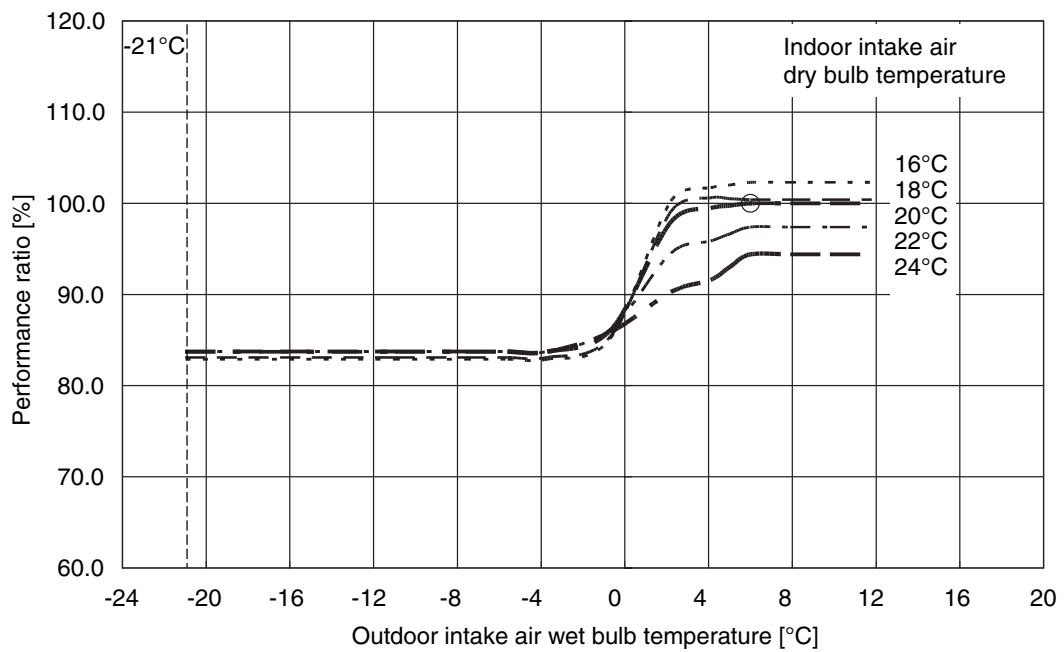

U-25GF2E5

(1) Standard Mode

Model name	45.0 kW Type
Operating sound level dB(A)	57
Measurement position	1m from front, 1.5m from bottom

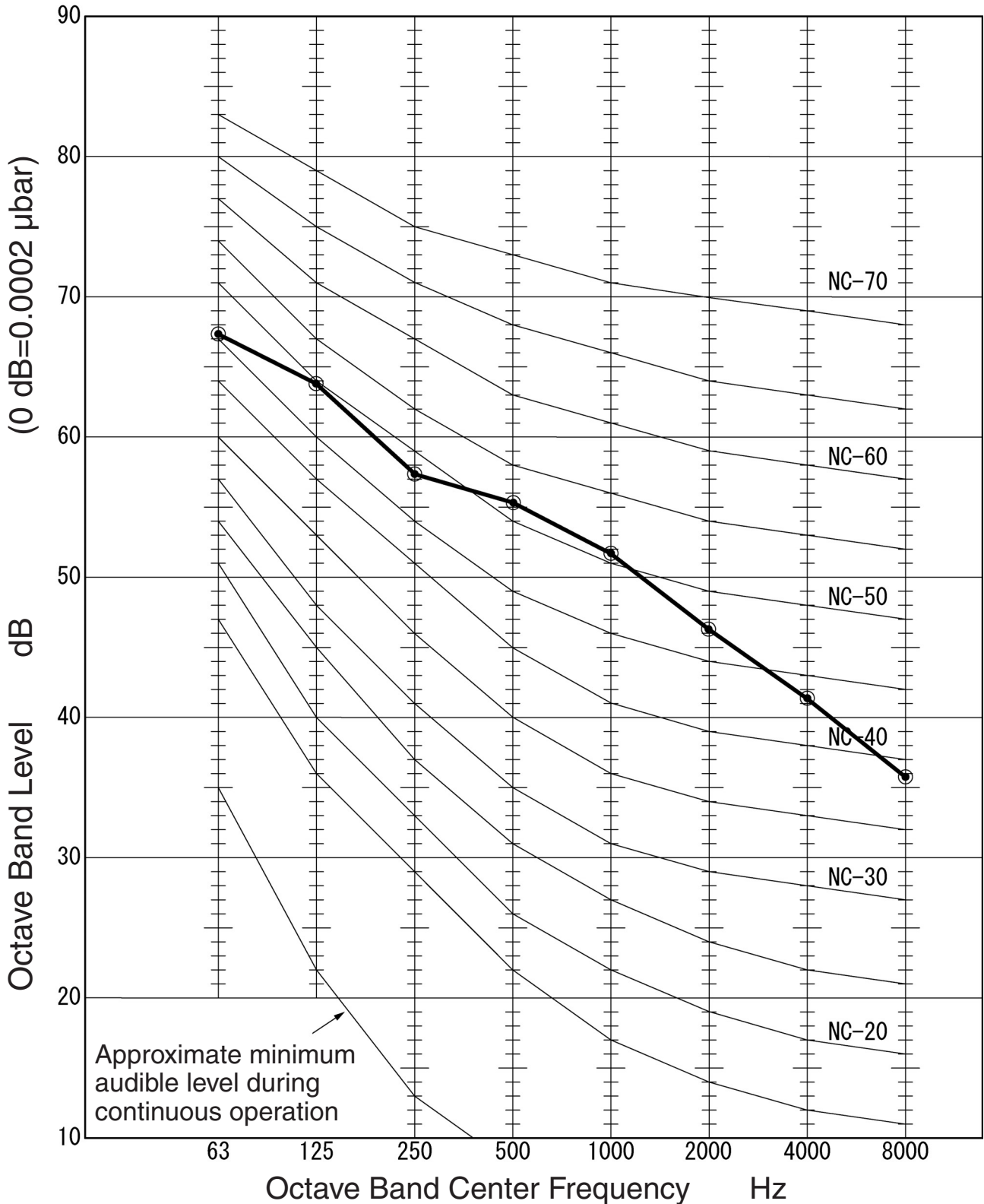

Model name	56.0 kW Type
Operating sound level dB(A)	58
Measurement position	1m from front, 1.5m from bottom

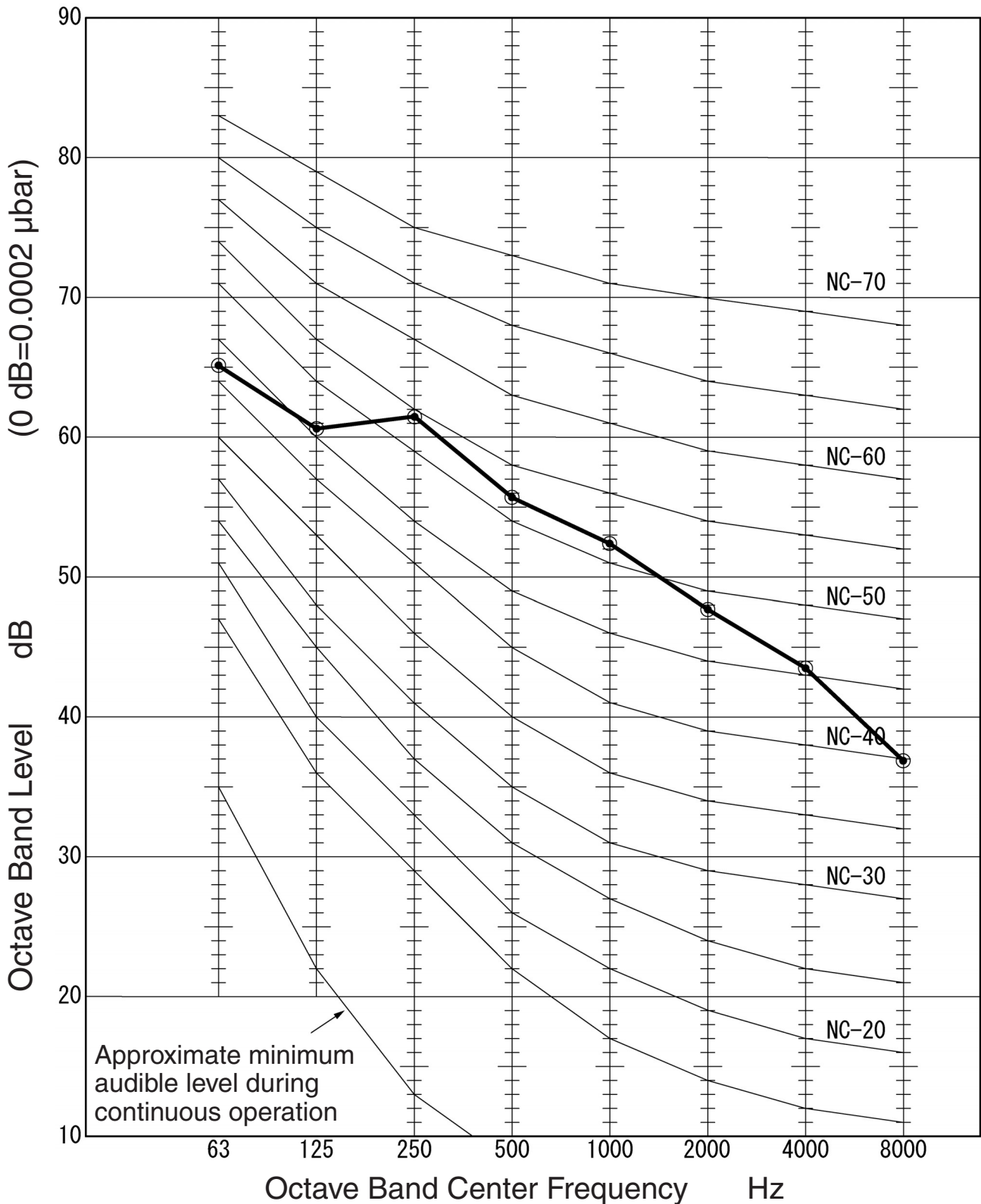

Model name	71.0 kW Type
Operating sound level dB(A)	62
Measurement position	1m from front, 1.5m from bottom

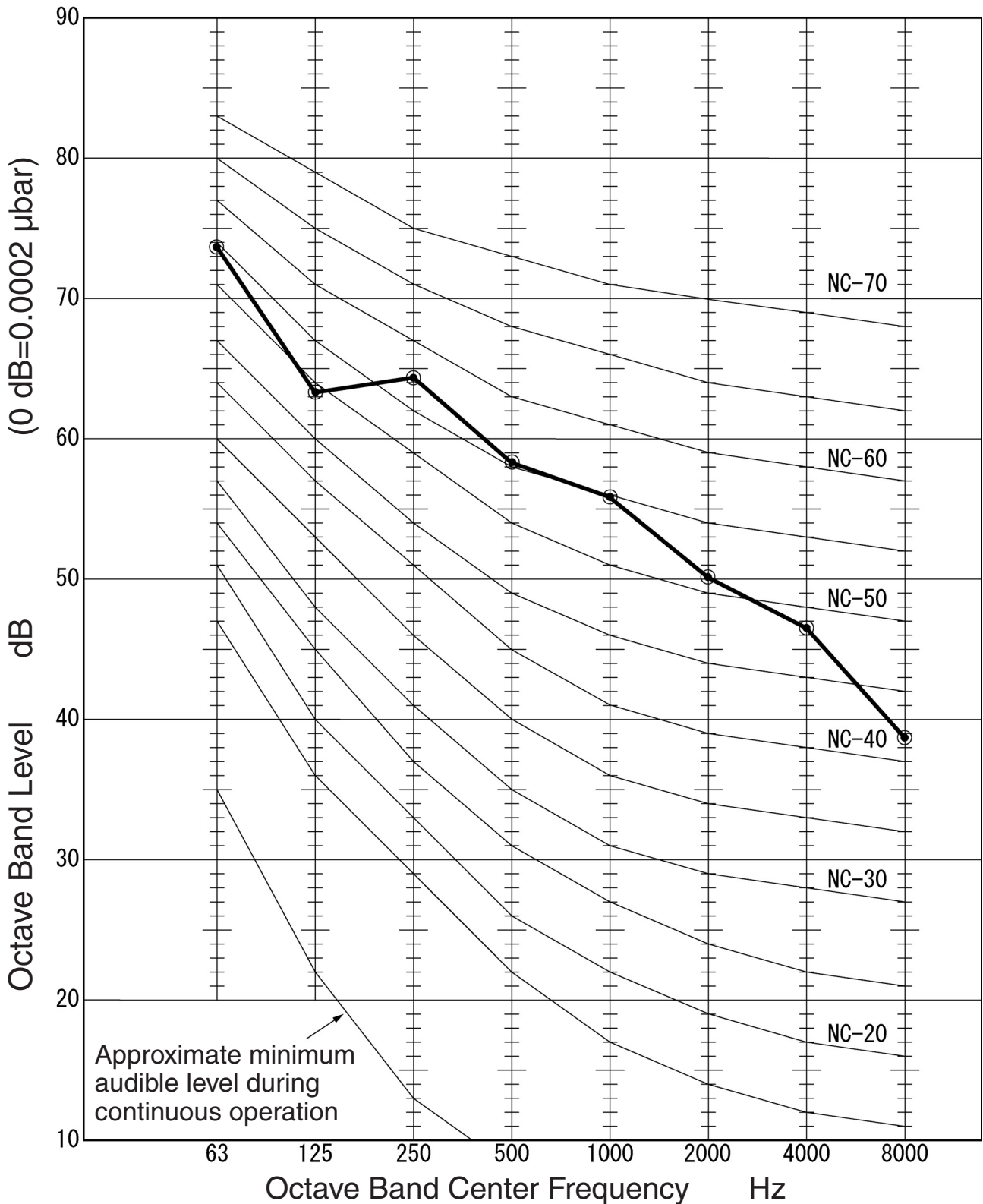



Model name	85.0 kW Type
Operating sound level dB(A)	63
Measurement position	1m from front, 1.5m from bottom

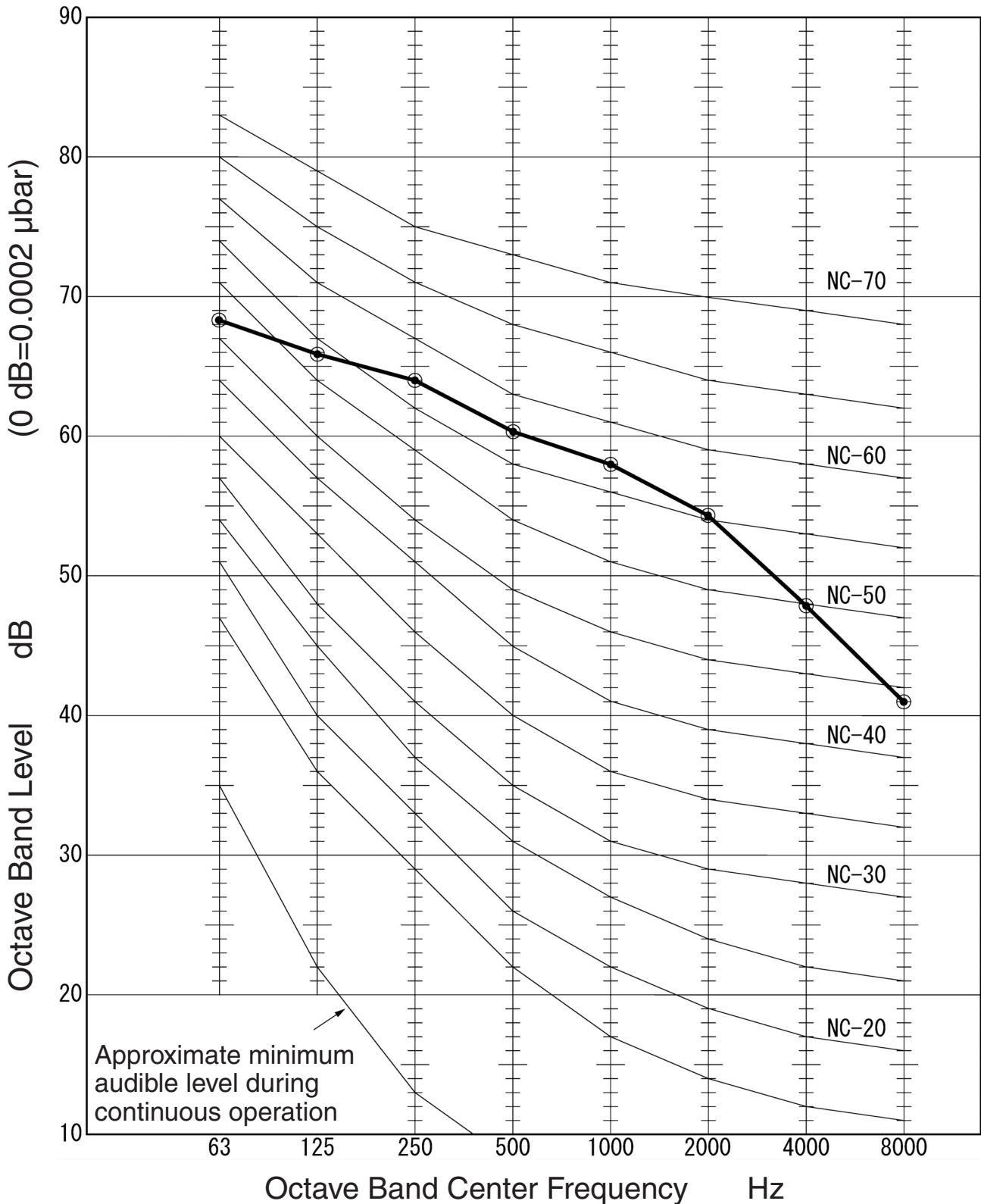

### (2) Quiet Mode

Model name	45.0 kW Type
Operating sound level dB(A)	55 (Quiet Mode)
Measurement position	1m from front, 1.5m from bottom

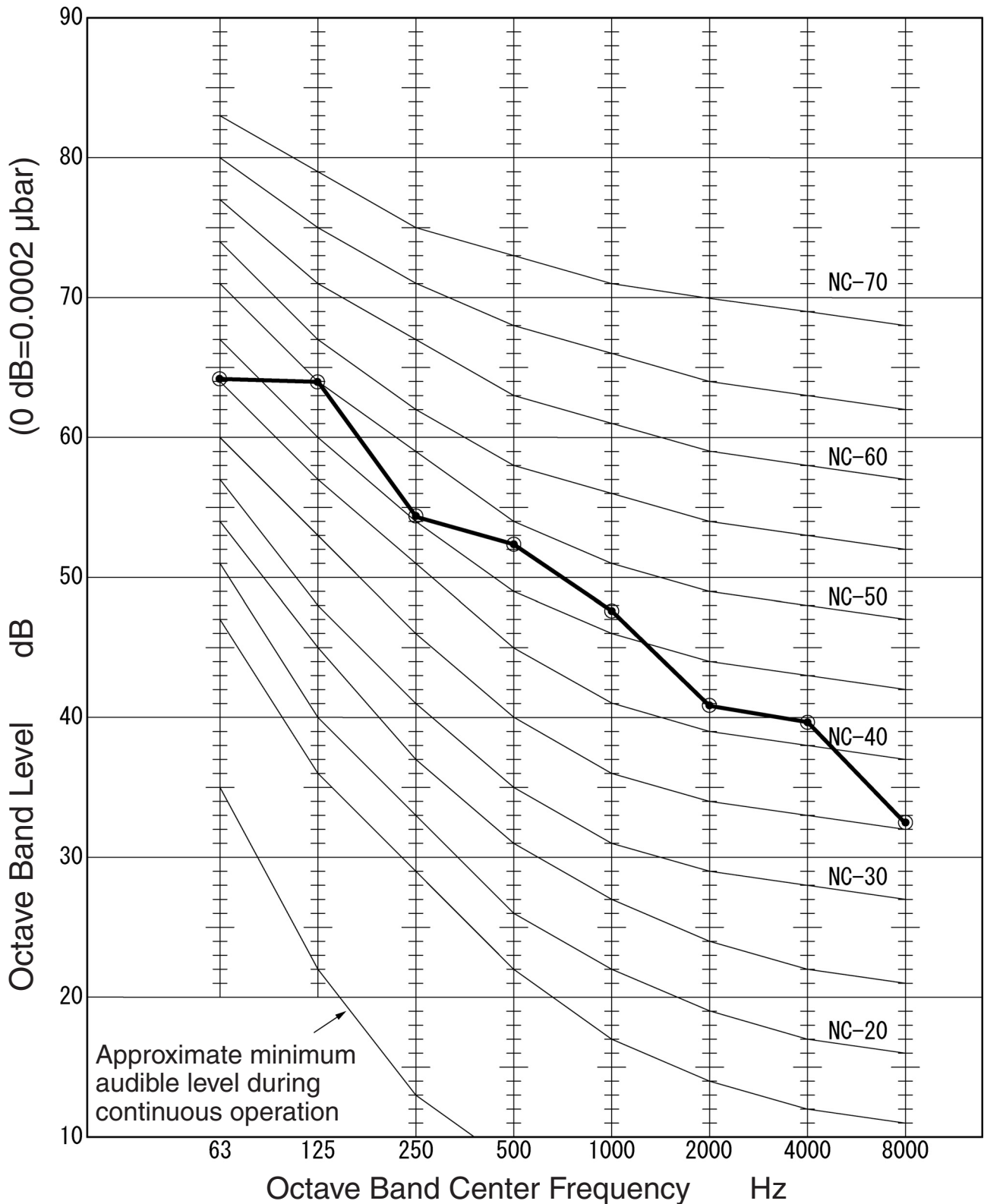

Model name	56.0 kW Type
Operating sound level dB(A)	56 (Quiet Mode)
Measurement position	1m from front, 1.5m from bottom

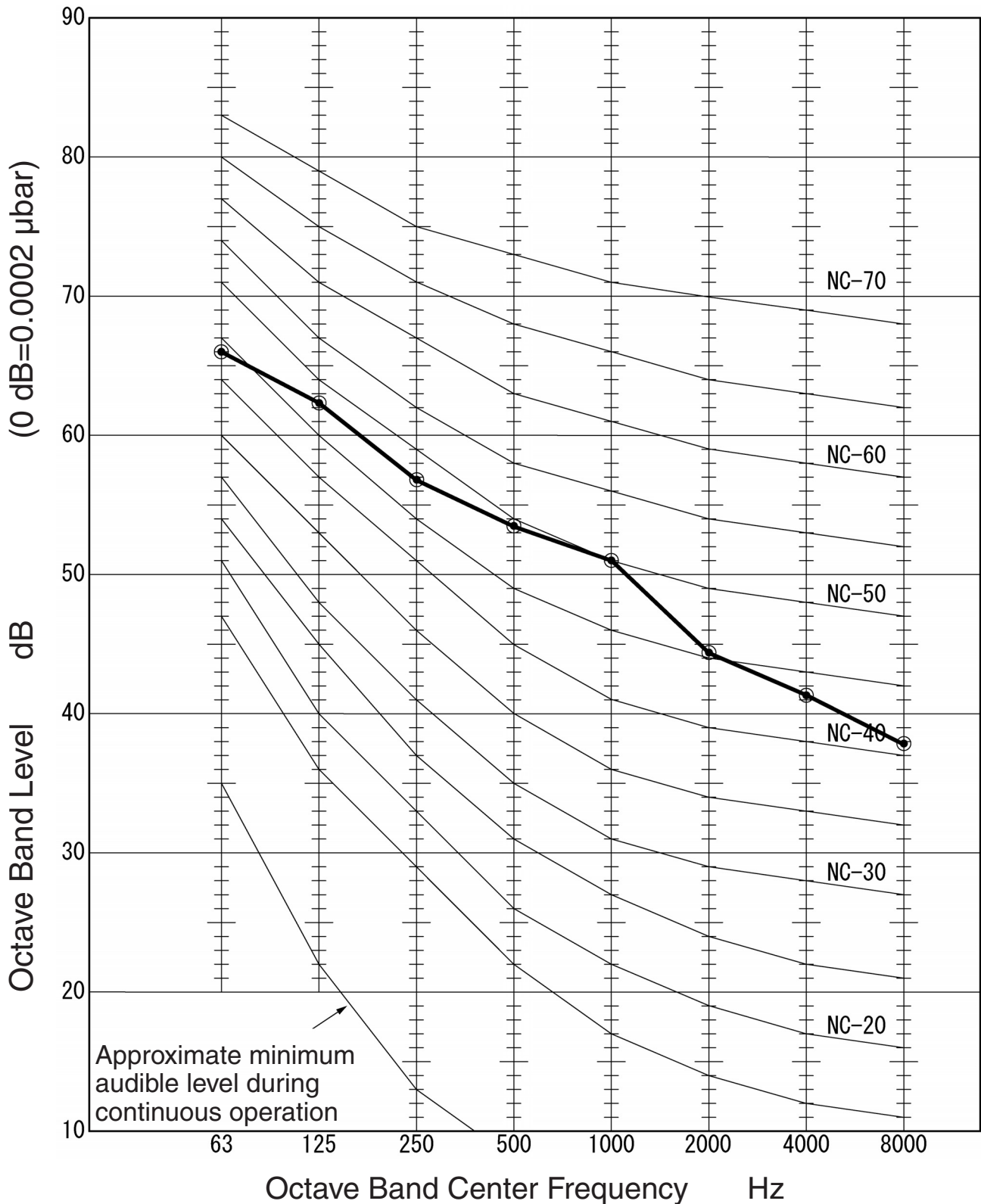

Model name	71.0 kW Type
Operating sound level dB(A)	60 (Quiet Mode)
Measurement position	1m from front, 1.5m from bottom

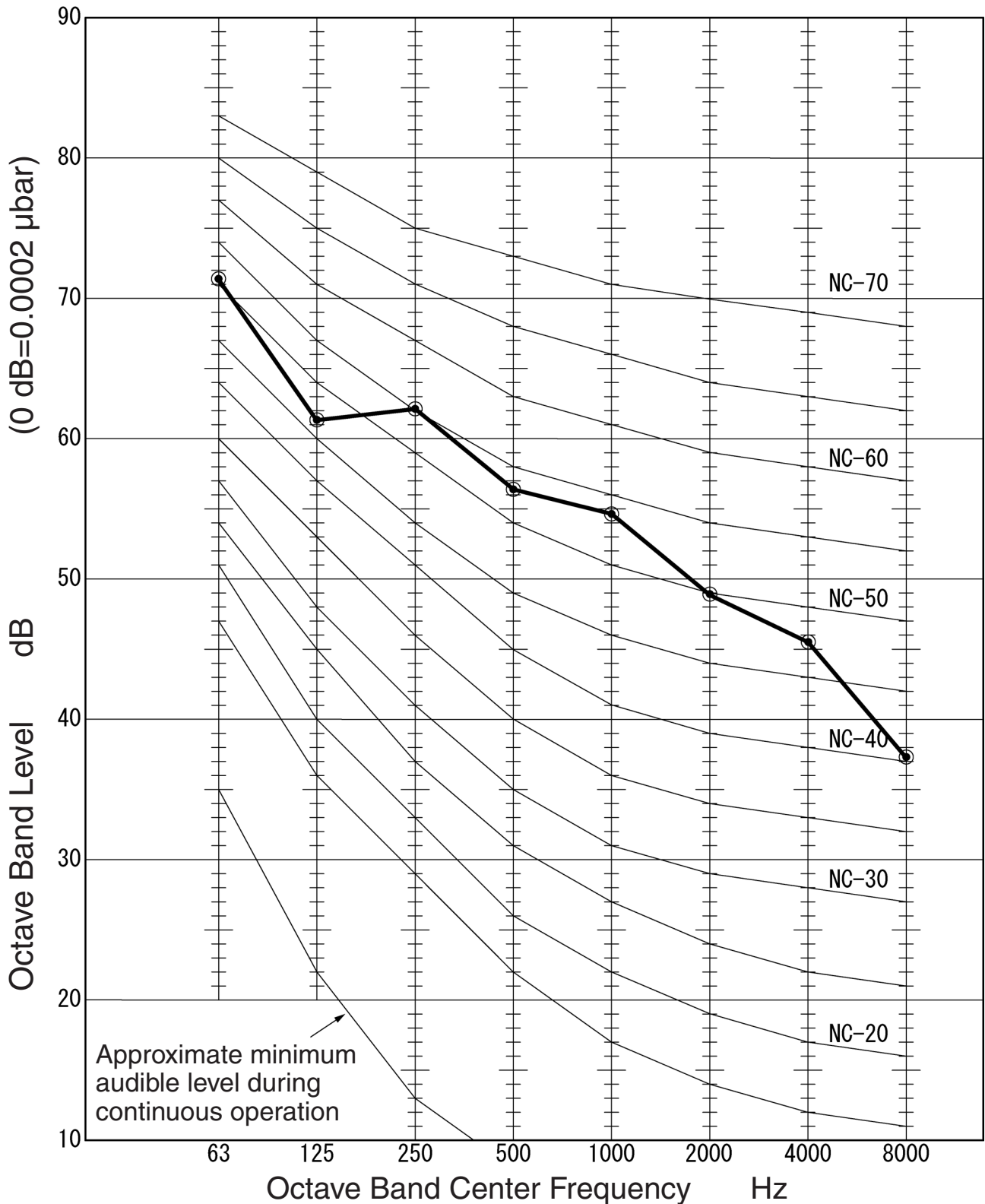

Model name	85.0 kW Type
Operating sound level dB(A)	60
Measurement position	1m from front, 1.5m from bottom

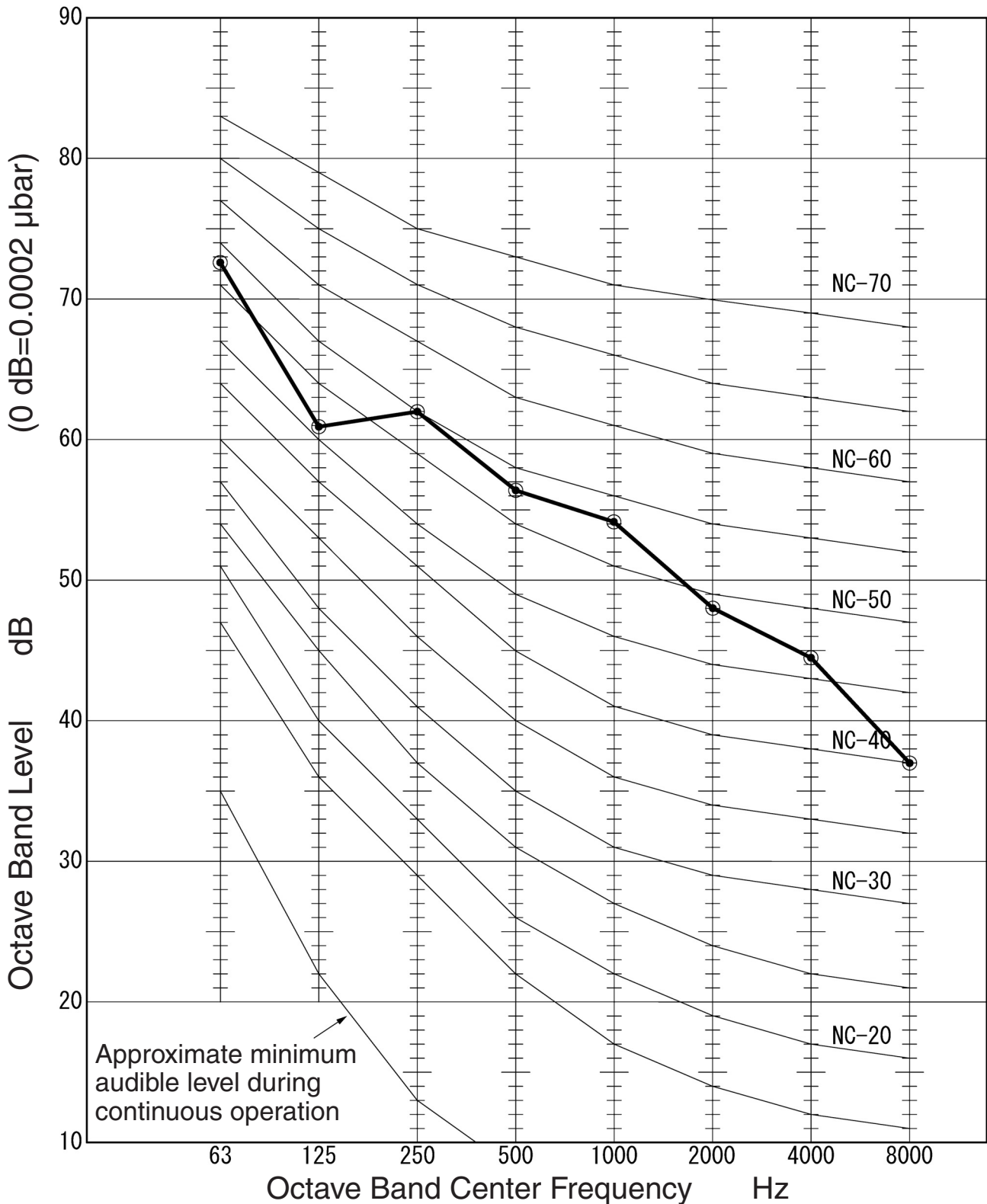

### (1) Measurement Points

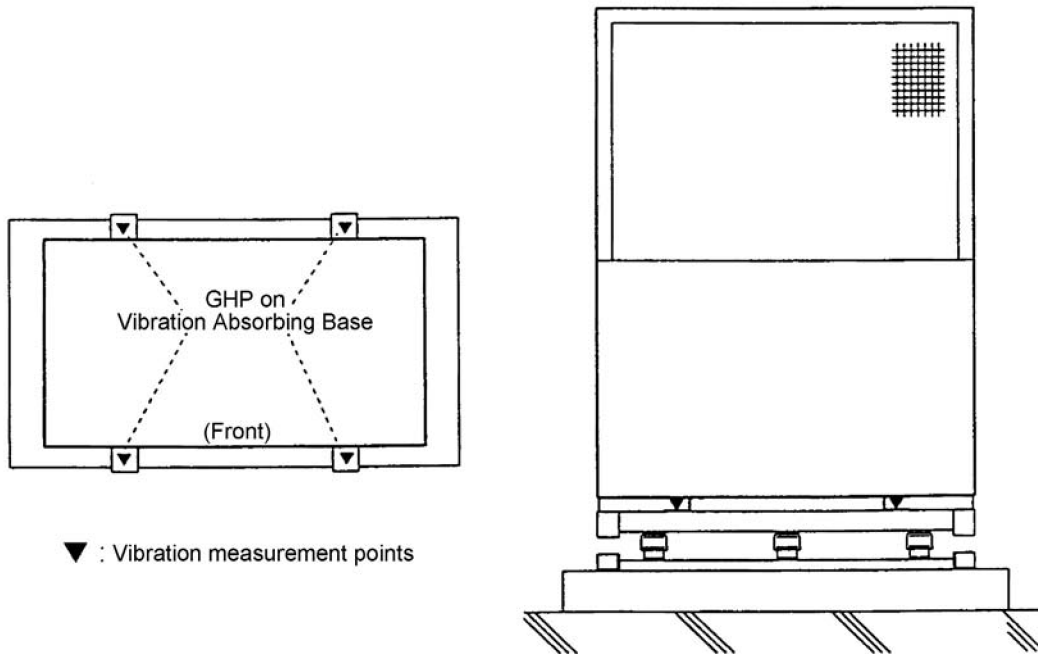

### (2) Vibration Force

Maximum vibration force at each frequency is measured over the whole range of engine rotation speeds and loads.

#### 1) Types 45.0 kW to 71.0 kW

Maximum values while changing rotation rate from 800 to 2200 r/min.

1/3<sup>rd</sup> octave

Frequency (Hz)	3.15	4	5	6.3	8	10	12.5	16	20	25
Vibration force F (N)	1.13	1.66	4.6	5.33	16.8	25.6	39.8	38.4	14.1	15.4
Vibration force level $20\log_{10} \frac{F}{F_0}$	1.06	4.38	13.3	14.5	24.5	28.2	32	31.7	23	23.8
Vibration acceleration (dB)	16.3	27.7	33	36.7	42.5	43.6	45.4	38.4	38.8	41.8

F: Vibration Force (N)  
F<sub>0</sub>: 1N

31.5	40	50	63	80	100	125	160	200	250	315	Compound Value
75.9	143	174	155	127	112	155	359	148	109	92.4	555.8
37.6	43.1	44.8	43.8	42.1	41	43.8	51.1	43.4	40.8	39.3	54.9
37.7	33.4	31.8	30.6	25.2	22.2	19.8	25.7	22.9	32.6	26	51.0



## Contents

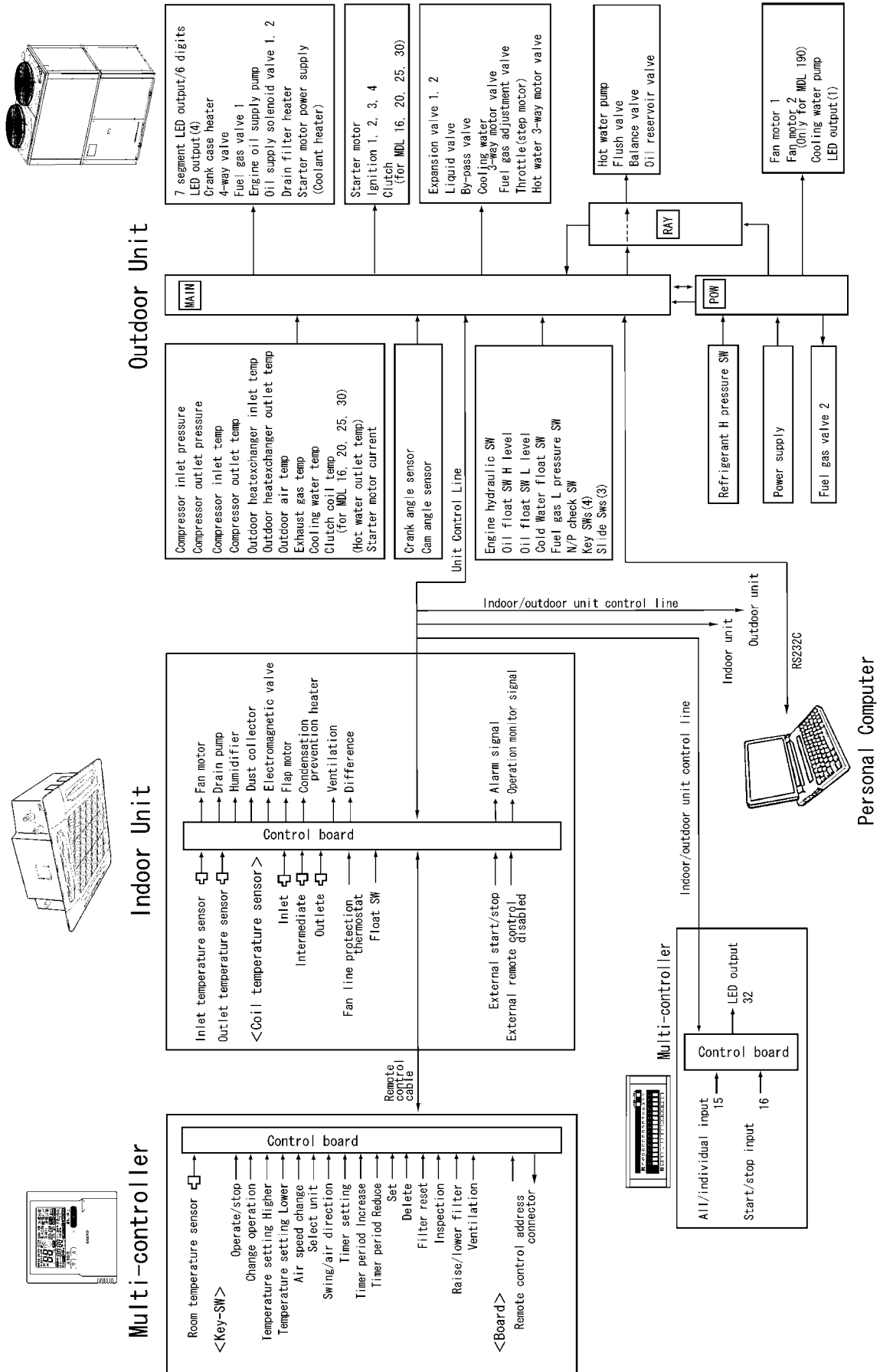











1. System Block Diagram .....	C-2
2. Remote Control Warning List	
(1) Remote Control Warning List (With Indoor Unit connected) .....	C-3





### (1) Remote Control Warning List (With Indoor Unit connected)

: Flashing     
 : Lit     
 : Off

Detection Item		Warning Display	Wireless Remote Control Lamp Display	Device Checked		
Engine protection device operation	Engine system faults	Engine oil pressure fault	A01	   Simult. flashing	Outdoor unit	
		Engine oil fault	A02			
		Engine over-rev fault	A03			
		Engine low-rev fault	A04			
		Ignition power fault	A05			
		Engine start failure	A06			
		Fuel gas valve fault	A07			
		Stalling	A08			
		High exhaust gas temperature	A10			
		Engine oil level fault	A11			
		Throttle failure	A12			
		Oil pressure switch fault	A14			
		Crank angle fault	A23			
		Cam angle fault	A24			
	Accidental fire fault	A26				
	Starter system faults	Starter power output short circuited	A15			
		Starter lock	A16			
		CT fault (bad starter current detected)	A17			
	Coolant system faults	Low coolant temperature	A19			
		High coolant temperature	A20			
Coolant level fault		A21				
Coolant pump overload		A22				
Clutch fault		A25				
Catalyzer temperature fault (for only model with catalyzer)		A27				
Generator fault (for only G-POWER and W multi models)		A28				
Converter fault (for only G-POWER and W multi models)		A29				
Fuel gas low pressure fault		A30				
Remote control unit detected an abnormal signal from an indoor unit	Faulty remote control reception	E01	  	Remote controller		
	Faulty remote control transmission	E02		Indoor unit		
	Faulty reception of (focused) remote control by indoor unit	E03		Remote controller		
Serial transmission faults, invalid settings	Invalid setting	Duplicate indoor unit address setting	E08	  	Indoor unit	
		Multiple parent remote control settings	E09		Remote controller	
	Faulty reception at indoor unit from signal output board		E11	Indoor unit		
	Automatic address setting is in progress; automatic address setting start is prohibited		E12	Outdoor unit		
	Faulty transmission from an indoor unit to remote control		E13	Indoor unit		
	Faulty group control wiring communication		E18	Indoor unit		
	Faulty reception by an indoor unit from an outdoor unit		E04	Indoor unit		
	Faulty transmission from an indoor unit to an outdoor unit		E05			
	Faulty reception by an outdoor unit from an indoor unit		E06			
	Faulty transmission from an outdoor unit to an indoor unit		E07			
	Automatic address warning	Too few units	E15		  	Outdoor unit
		Too many units	E16			
	No indoor unit		E20			
	Outdoor main controller board fault		E21			
	Outdoor main controller board sensor fault		E22			
Faulty communications between outdoor units (for only W multi model)		E24				
Wrong quantity of outdoor units (for only W multi model)		E26				
Outdoor unit wrong tubing connection (for only W multi model)		E28				
Abnormal transmission within a unit		E31				

When the water heat exchanger unit is connected in the table above, please replace indoor unit with water heat exchanger unit for the alarm.

Note: Some items are not indicated, depending in model type.

Detection Item		Warning Display	Wireless Remote Control Lamp Display	Device Checked	
Sensor faults	Indoor unit sensor faults	Indoor heat exchanger inlet temperature sensor fault (E1)	F01		Indoor unit
		Water heat exchanger refrigerant anti-icing sensor fault	F02		
		Indoor heat exchanger outlet temperature sensor fault (E3)	F03		
		Indoor unit intake temperature sensor fault	F10		
		Indoor unit blow out temperature sensor fault	F11		
	Outdoor unit sensor faults	Compressor outlet temperature sensor fault	F04		Outdoor unit
		Outdoor heat exchanger inlet temperature sensor fault	F06		
		Outdoor heat exchanger outlet temperature sensor fault	F07		
		External air temperature sensor fault	F08		
		Compressor inlet temperature sensor fault	F12		
		Coolant temperature sensor fault	F13		
		Compressor inlet/outlet pressure sensor fault	F16		
		Hot water outlet temperature sensor fault (for only hot water removal model)	F17		
		Exhaust gas temperature sensor fault	F18		
		Clutch coil temperature sensor fault	F20		
		Clutch-2 coil temperature sensor fault	F21		
		Oil level sensor fault (for only W multi model)	H08		
		Compressor oil empty (for only W multi model)	H07		
	Indoor nonvolatile memory (EEPROM) fault (*1)	F29		Indoor unit	
Clock function (RTC) fault	F30		Outdoor unit		
Outdoor nonvolatile memory (EEPROM) fault	F31				
Invalid or missing setting	Incompatible outdoor/indoor unit (non-GHP equipment connected)	L02		Indoor unit	
	Multiple parent devices set for group control	L03		Outdoor unit	
	Indoor unit priority settings duplicated	Indoor unit priority			L05
		Non-indoor unit priority		L06	
	Group control cable present for individual-control indoor unit	L07		Indoor unit	
	Indoor unit address not set	L08			
	Indoor unit capacity not set	L09		Outdoor unit	
	Duplicate system (outdoor unit) address setting	L04			
	Outdoor unit capacity not set	L10			
	Faulty indoor unit type setting	L13			
	Faulty indoor unit combination	L15			
Wrong gas type setting	L21				

When the water heat exchanger unit is connected in the table above, please replace indoor unit with water heat exchanger unit for the alarm.

Note: Some items are not indicated, depending in model type.

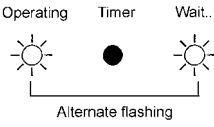
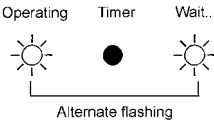
Detection Item		Warning Display	Wireless Remote Control Lamp Display	Device Checked	
Faulty connection at indoor unit ceiling panel connector		P09	Operating    Timer    Wait... 	Indoor unit	
Protection device operation	Indoor protection devices	Indoor blower fault/ Indoor blower rotation fault			P01
		Indoor unit float switch fault			P10
		Indoor DC fan fault			P12
Protection device operation	Outdoor protection devices	High compressor discharge temperature	P03	Operating    Timer    Wait... 	Outdoor unit
		Refrigerant high pressure switch action	P04		
		Power supply fault	P05		
		Water heat exchanger freeze fault (when the water heat exchanger unit is connected)	P11		
		Refrigerant circuit fault (for only W multi and 3-WAY multi)	P13		
		O <sub>2</sub> sensor signal	P14		
		All refrigerant gas lost	P15		
		Bypass valve fault	P18		
		4-Way valve lock fault (not detected 3-Way multi)	P19	Operating    Timer    Wait... 	
		High refrigerant pressure fault	P20		
		Outdoor blower fault	P22		
		Water heat exchanger unit interlock fault (for only water heat exchanger unit is connected)	P23		
		Clutch engagement fault	P26		
Sub unit of group control fault (System controller)		P30		System controller	
Group control fault (Warning)		P31		Indoor unit	
Oil replacement time (level) warning Outdoor display: oil		Oil check		Outdoor unit	
Automatic backup online (*2)		check			
Backup operating display without power generation when the converter is abnormal		GE			

When the water heat exchanger unit is connected in the table above, please replace indoor unit with water heat exchanger unit for the alarm.

Note: Some items are not indicated, depending in model type.

- \*1: If the indoor nonvolatile memory (EEPROM) is faulty when the power supply is turned on, warning code F29 is not indicated, but the power source LED on the indoor board starts to flicker.
- \*2: In this case, operation of the system is possible, but one of the outdoor units is detected to have stopped abnormally.
- Warning P30 (group controlled device fault) is sometimes displayed at the system controller.

## Contents

1. System Configuration	
(1) Procedure for selecting model type and calculating performance .....	D-2
(2) Calculation of actual performance.....	D-3
2. Operating temperature ranges for heating and cooling .....	D-5
3. Refrigerant piping design	
(1) System piping .....	D-7
(2) Selecting system header and branch piping sizes .....	D-8
(3) Selecting header piping .....	D-9
(4) Selecting branch and header piping.....	D-11
(5) Equivalent length of refrigerant piping.....	D-17
(6) Calculation of amount of additional refrigerant charge .....	D-18
(7) Checking the density limit .....	D-19
(8) Future system expansion .....	D-20
4. Effect of refrigerant pipe length on performance .....	D-21
5. Outdoor unit positioning requirements	
(1) Combined installation criteria.....	D-25
(2) Verandah installation criteria.....	D-32
6. Sound-proofing measures	
(1) Installation location and sound-proofing measures.....	D-33
(2) Attenuation of sound over distance .....	D-33
(3) Sound attenuation by a noise barrier .....	D-34
(4) Additional sound from reflections .....	D-35
(5) Combining sounds .....	D-35
(6) Converting from octave band levels to overall A weighting .....	D-36
(7) Designing sound-proofing countermeasures .....	D-36
(8) Sound-proofing calculation sheet (example).....	D-37
7. Center-of-gravity and earthquake resistance	
(1) Earthquake resistance calculations .....	D-38
(2) Verifying the strength of foundation bolts during an earthquake .....	D-38
(3) Installation position and center of gravity .....	D-47
(4) Example anchor bolt calculation .....	D-49

### (1) Procedure for selecting model type and calculating performance

Perform the following procedures to select a model type and calculate performance capabilities.

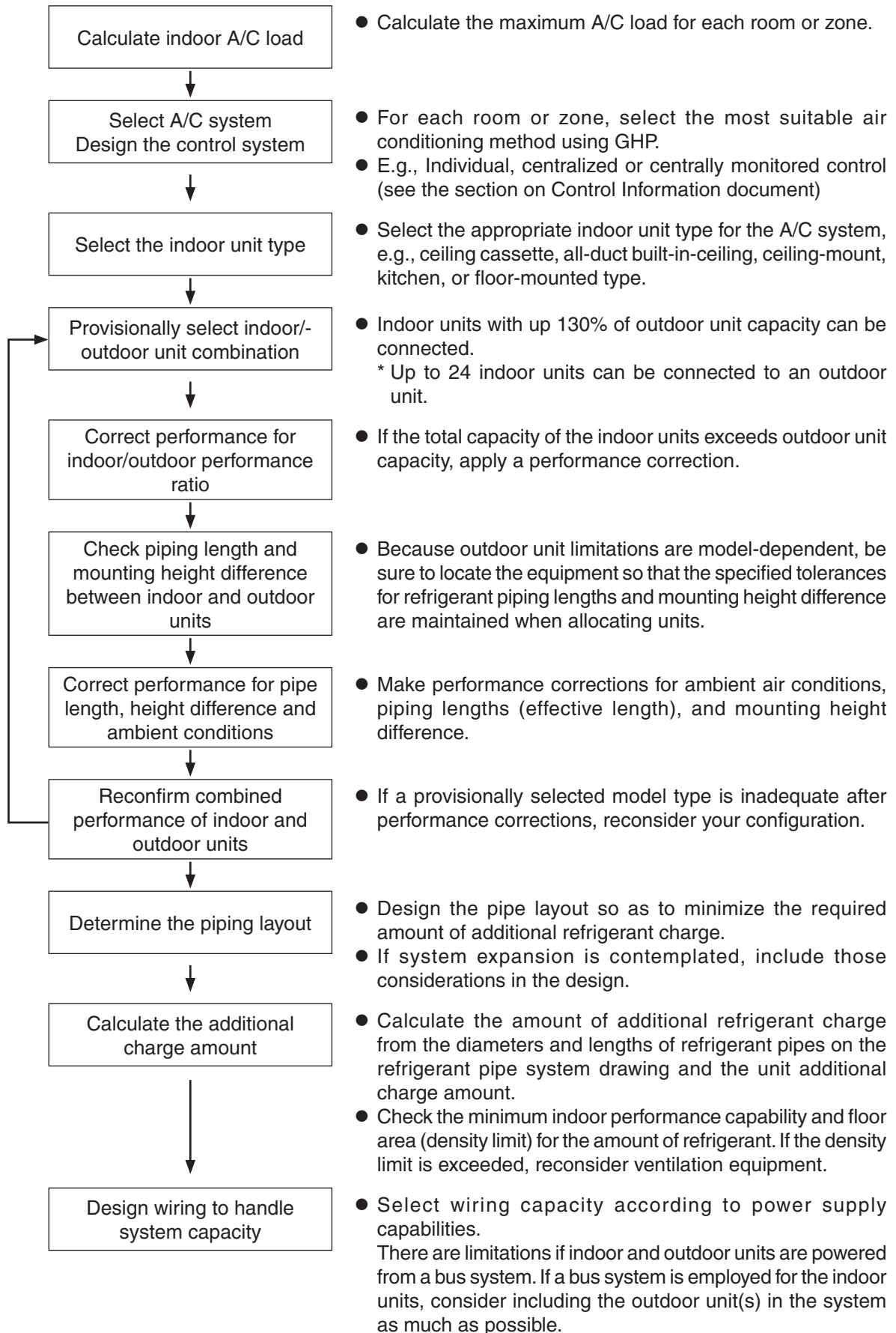

### (2) Calculation of actual performance

Indoor units with up to 130% of outdoor unit capacity can be connected.

\* Up to 24 indoor units can be connected to an outdoor unit.

Multi-unit air conditioning system performance depends on ambient temperature, piping lengths and mounting height differences, so each correction factor should be taken into account when selecting the model type.

#### (1) Dependence of multi-unit air conditioning system performance on installation conditions

##### 1) Indoor unit cooling capability =

$$\begin{aligned} & (\text{Outdoor unit rated cooling capacity})^{\text{Note 1}} \times (\text{Indoor unit rated cooling capacity})^{\text{Note 3}} \\ & \div (\text{Total rated cooling capacity of the indoor units})^{\text{Note 5}} \\ & \times (\text{Correction factor for temperature and connected capacity, from performance characteristics})^{\text{Note 7}} \\ & \times (\text{Correction factor for piping length})^{\text{Note 8}} \end{aligned}$$

##### 2) Indoor unit heating capability =

$$\begin{aligned} & (\text{Outdoor unit rated heating capacity})^{\text{Note 2}} \times (\text{Indoor unit rated heating capacity})^{\text{Note 4}} \\ & \div (\text{Total rated heating capacity of the indoor units})^{\text{Note 6}} \\ & \times (\text{Correction factor for temperature and connected capacity, from the performance characteristics})^{\text{Note 7}} \\ & \times (\text{Correction factor for piping length})^{\text{Note 8}} \end{aligned}$$

Note 1. Outdoor unit rated total cooling capacity (see the outdoor unit specification table) is the cooling capacity under JIS conditions (indoor side: 27°CDB, 19°CWB, outdoor side: 35°CDB, -°CWB)

Note 2. Outdoor unit rated total heating capacity (see the outdoor unit specification table) is the heating capacity under JIS conditions (indoor side: 20°CDB, -°CWB, outdoor side: 7°CDB, 6°CWB)

Note 3. Read the rated cooling capacity of the applicable indoor unit from the indoor unit specification table.

Note 4. Read the rated heating capacity of the applicable indoor unit from the indoor unit specification table.

Note 5. Read the rated cooling capacity of the applicable indoor unit from the indoor unit specification table, and obtain the total for all units..

Note 6. Read the rated heating capacity of the applicable indoor unit from the indoor unit specification table, and obtain the total for all units..

Note 7. Read the percentage data at the required temperature from the relevant capacity table in the "Model Basic Data Table" for the outdoor unit, and divide by 100. (Contact your Sanyo business representative for the Model Basic Data Table.)

\*In the case of two outdoor units, calculate as follows:

$$\text{System correction factor} = \frac{\sum (\text{Correction factor for outdoor unit} \times \text{rated capacity of outdoor unit})}{\sum (\text{Rated capacity of outdoor unit})}$$

Example) Connecting two units (A/C)

$\alpha_1$  = Correction factor of outdoor unit 1,  $W_1$  = Rated cooling capacity of outdoor unit 1

$\alpha_2$  = Correction factor of outdoor unit 2,  $W_2$  = Rated cooling capacity of outdoor unit 2

$$\text{System correction factor} = \frac{\alpha_1 \times W_1 + \alpha_2 \times W_2}{W_1 + W_2}$$

##### Note 8. Correction factor for piping length

Determine the effective length of refrigerant piping and the mounting height difference between outdoor and indoor units (positive when the outdoor unit is higher, and negative when the indoor unit is higher). Read the correction factor from the "Performance correction for refrigerant piping length" for the outdoor unit, and divide by 100 for percentage.

(2) Example of calculation of actual performance

[Example calculation conditions]

Indoor units: Six type 112 units, and four type 140 units

Outdoor units: Two type 560 W-Multi outdoor units

Indoor/outdoor temperatures: cooling (indoors 22°CWB, outdoors 33°CDB); heating (indoors 22°CWB, outdoors 3°CDB)

Height difference between indoor/outdoor units: Outdoor unit is higher by no more than 50m

Refrigerant effective piping length: 120m

1) Indoor unit cooling capability

Outdoor unit rated cooling capacity<sup>Note 1</sup> = 56.0 + 56.0 = 112.0 (kW)

Indoor unit rated cooling capacity<sup>Note 3</sup>

Type 112 = 11.2 kW, type 140 = 14.0 kW

Total rated cooling capacity of indoor units<sup>Note 5</sup> = 123.2 (kW)

$11.2 \times 6 + 14.0 \times 4 = 123.2$

From the performance table, the correction factor for temperatures and connected capacity<sup>Note 7</sup> = 1.08

The connected capacity of the indoor units as a percentage of the outdoor capacity is  $(123.2 \div 112.0) \times 100 = 110\%$ .

Next obtain the correction factor for each outdoor unit. From the 110% air conditioner capacity table for each outdoor unit, note the value at the crossover point of the indoor wet bulb temperature 22°CWB and the outdoor air temperature 33°CDB, and then divide the value by 100.

The correction factor for type 560 outdoor units is: 107.9% 1.079

$$\text{System correction factor} = \frac{1.079 \times 560 + 1.079 \times 560}{560 + 560} = 1.08$$

The correction factor for piping length<sup>Note 8</sup> = 0.86

From the "Performance correction for refrigerant piping length" table for the selected unit type, note the crossover point for the equivalent length of 120m and the height difference of 50m, which is 86%, and divide this by 100.

a) Cooling capacity of each indoor unit

$$\begin{aligned} \text{Indoor unit type 112 cooling capability} &= \text{Note 1} \times \text{Note 3} \div \text{Note 5} \times \text{Note 7} \times \text{Note 8} \\ &= 112.0 \times 11.2 \div 123.2 \times 1.08 \times 0.86 \\ &\cong 11.0 \text{ kW} \end{aligned}$$

Calculating the same way, Type 140 provides 13.7 kW.

b) Total cooling capability of the indoor units is therefore  $11.0 \times 6 + 13.7 \times 4 = 120.8$  kW.

2) Indoor unit heating capability

Outdoor unit rated heating capacity<sup>Note 1</sup> = 63.0 + 63.0 = 126.0 (kW)

Indoor unit rated heating capacity<sup>Note 3</sup>

Type 112 = 12.5 kW, type 140 = 16.0 kW

Total rated heating capacity of indoor units<sup>Note 5</sup> = 139.0 (kW)

$12.5 \times 6 + 16.0 \times 4 = 139.0$

From the performance table, the correction factor for temperatures and connected capacity<sup>Note 7</sup> = 1.025

Indoor unit selection was based upon cooling capacity, so the connected capacity of the indoor units as a percentage of the outdoor unit capacity is  $(123.2 \div 112.0) \times 100 = 130\%$

Next obtain the correction factor for each outdoor unit. Read the values for 22°CWB from the 110% heating capacity table for each outdoor unit, and the value in the table for outdoor temperature of 3°CDB, and divide by 100.

The correction factor for type 560 outdoor units is: 102.5% 1.025

$$\text{System correction factor} = \frac{1.025 \times 63.0 + 1.025 \times 63.0}{63.0 + 63.0} = 1.025$$

The correction factor for piping length<sup>Note 8</sup> = 0.954

From the "Performance correction for refrigerant piping length" table for the selected unit type, note the crossover point for the equivalent length of 120m and the height difference of 50m, which is 95.4%, and divide this by 100.

a) Heating capacity of each indoor unit

$$\begin{aligned} \text{Indoor unit type 112 heating capability} &= \text{Note 1} \times \text{Note 3} \div \text{Note 5} \times \text{Note 7} \times \text{Note 8} \\ &= 126.0 \times 12.5 \div 139.0 \times 1.025 \times 0.954 \\ &\cong 11.6 \text{ kW} \end{aligned}$$

Calculating the same way, type 140 provides 14.8 kW.

b) Total heating capability of the indoor units is therefore  $11.6 \times 6 + 14.8 \times 4 = 128.8$  kW.

- Cooling

(for 2-WAY W multi)

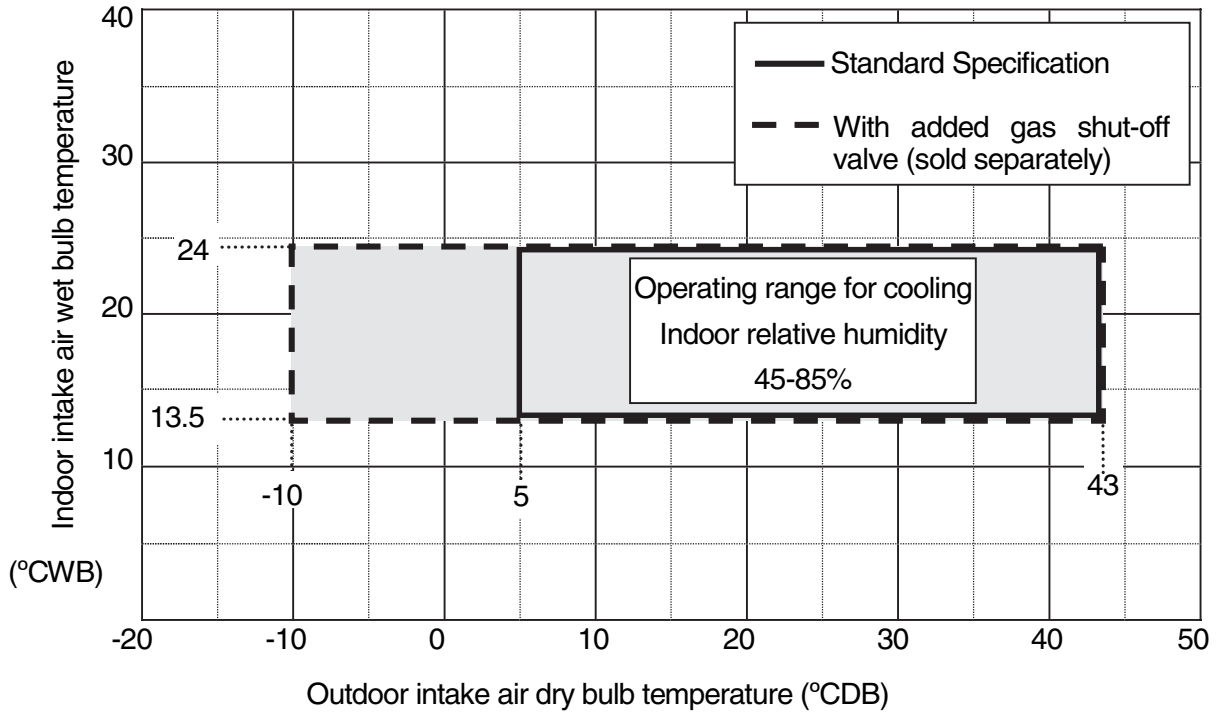

(for 2-WAY multi and 3-WAY multi)

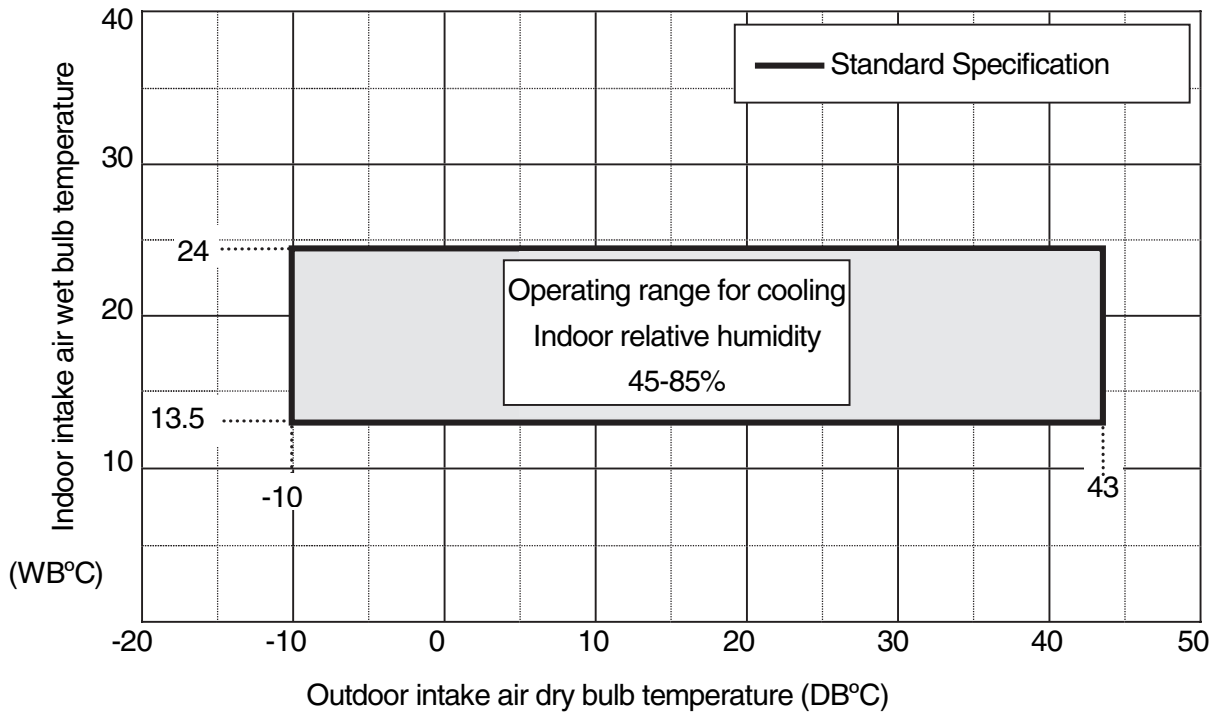



- Heating

(for 2-WAY W multi)

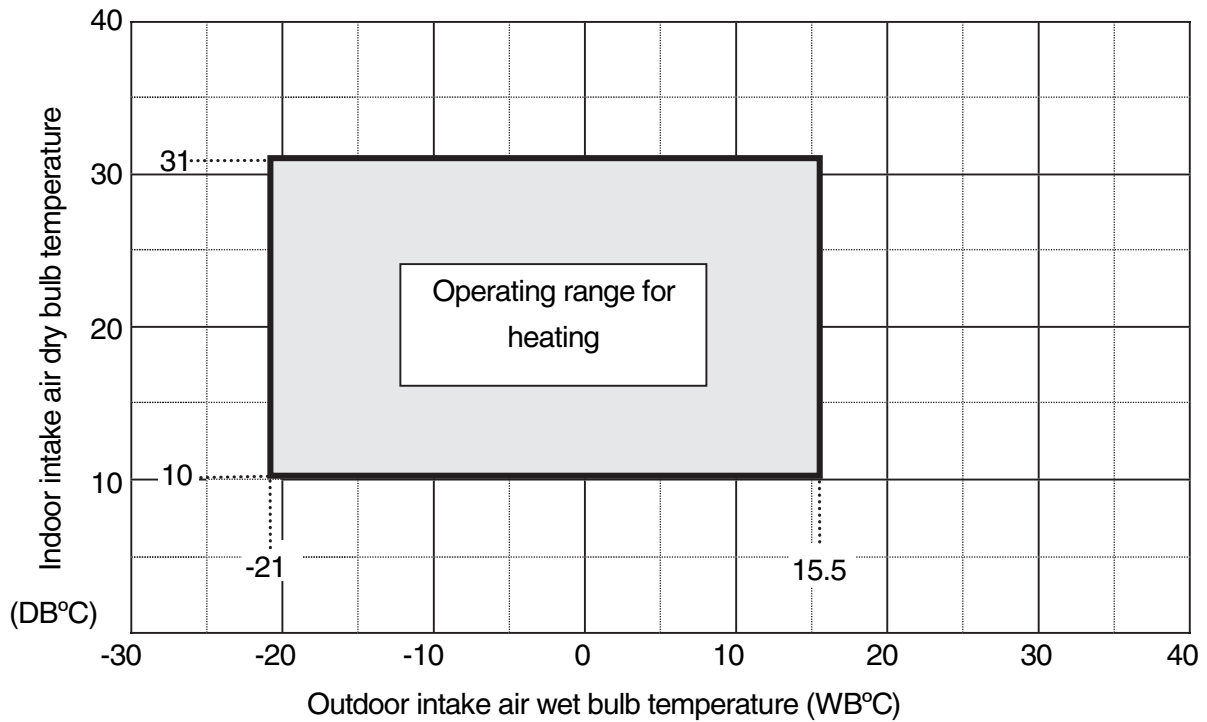

(for 2-WAY multi and 3-WAY multi)

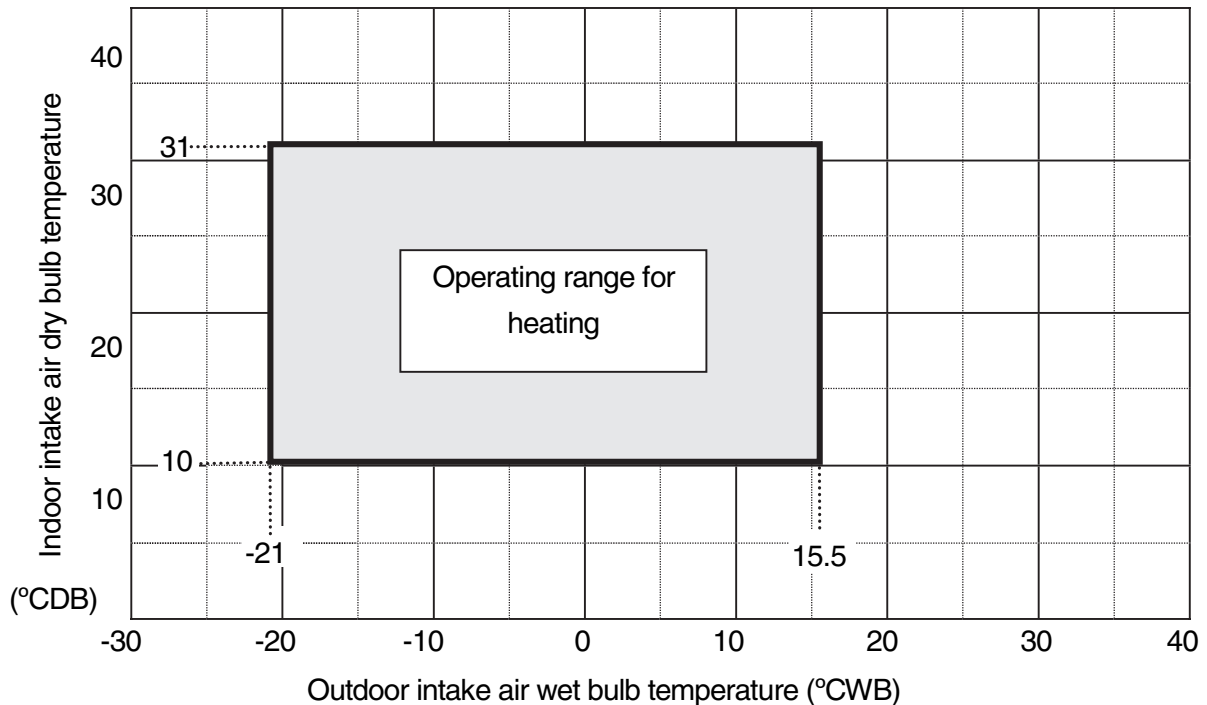

Note 1 : The remote control temperature setting range is as shown in the table below. This is slightly different from the system operating temperature range.

	Upper limit	Lower limit
Cooling	30	18
Heating	26	16

Note 2 : When heating starts (during warm-up), the system can operate even if the indoor temperature is below 10°C.

### (1) System piping

#### 1) Limitations on refrigerant piping length

1. — LM: Main tube with largest tubing diameter (includes LA and all post-branch main tubes that are identical in size to LA)  $\leq 120$  m.
2. — Select the sizes for post-branching main tubes after LM (LB, LC, ...) based on the post-branching capacity.
3. — The sizes for the indoor unit connection tubing ( $\ell 1$  to  $\ell 48$ ) depend on the tubing diameter for the indoor unit.

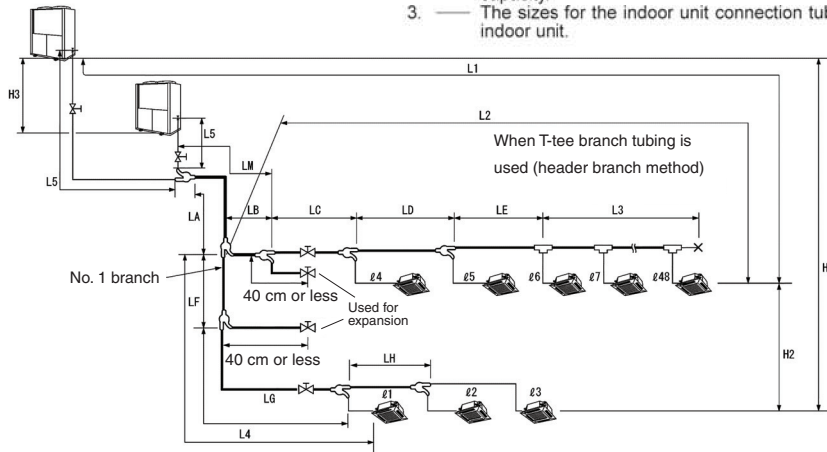

#### Symbols

- ↪ : Branch tube (APR purchased separately)
- ⊗ : Ball valve (purchased separately)
- ⊕ : T-tee (provided by installer)
- × : Closed (pinch) weld

\* Limit for height difference between indoor units after the final branch

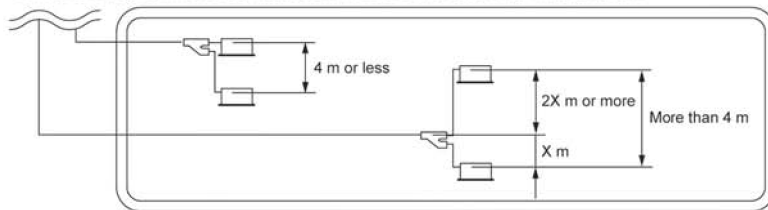

↪ : Branch tube (purchased separately)

### 2-Way Multi Models

Table 1-1 Ranges for Refrigerant Tubing Length and Installation Height Difference

	450	560	710	850	450×2	450+560	560×2	450+710	560+710	710×2
Equivalent Horsepower	16	20	25	30	32	36	40	41	45	50
Ratio of capacity for indoor unit to outdoor units	50 – 130%			50 – 170%	Min: Across the system, a minimum outdoor unit capacity of 50% Max: Total capacity of 130% with 2 outdoor units					
Minimum capacity of indoor units that can be connected	Type 22 or greater (equivalent to 0.8 horsepower)									
Maximum number of indoor units that can be connected (per system)	24		34	48 (A maximum of 24 indoor units can be connected per 1 outdoor unit)						

\* The number of indoor units that can be connected when a W-multi outdoor unit is installed by itself is 24 units or fewer.

#### 2) Ranges for Refrigerant Tubing Length and Installation Height Difference

Category	Symbol	Description	Tubing length (m)
Allowable tubing length	L1	Max. allowable tubing length	$\leq 170$ (equivalent length 200)
	$\Delta L = (L2 - L4)$	Difference between longest and shortest tubing lengths after the No. 1 branch (first branching point)	$\leq 70$
	LM	Max. length for main tube (tube with widest diameter)	$7 \leq LM \leq 120$
	$\ell 1, \ell 2 \dots \ell 48$	Max. length for each tube branch	$\leq 30$
	L5	Distance between outdoor units	$\leq 7$
Allowable height difference	H1	Max. height difference between indoor and outdoor units	If outdoor unit is above $\leq 50$ If outdoor unit is below $\leq 35$ <sup>(*)</sup>
	H2	Max. height difference between indoor units	$\leq \alpha$ <sup>(**)</sup>
	H3	Max. height difference between outdoor units	1
Allowable length for branched tubing (header branch)	L3	Max. length between first T-tee branch (provided by installer) and the closed tube end	$\leq 2$

(\*) If cooling mode is expected to be used when the external temperature is 10°C or below, the maximum length is 30 m.

(\*\*) The max/min permissible height between indoor units ( $\alpha$ ) is found by the difference ( $\Delta L$ ) between the maximum length and the minimum length from the first branch.

$$\alpha = 35 - \Delta L / 2 \text{ (however, } 0 \leq \alpha \leq 15)$$

### (2) Selecting system header and branch piping sizes

Outdoor and indoor units are connected together by a pair of headers.

If the maximum tubing length exceeds 90 m (effective length), increase the size of the main tubing for both liquid and gas by one size. Be careful when selecting tube sizes, as the wrong size may impair performance.

#### 1) Outdoor Tubing/Main Tube Size <sup>(\*)</sup><sup>(\*)</sup>

	Outdoor tubing				Main tubing					
	Outdoor unit (gross) capacity (kW)									
	45	56	71	85	90	101	112	116	127	142
Gas tube (mm)	Ø28.58 (Ø31.75)				Ø31.75 (Ø38.1)			Ø38.1		
Liquid tube (mm)	Ø12.7 (Ø15.88)	Ø15.88 (Ø19.05)			Ø19.05 (Ø22.22)					

(\*) If there are plans for future expansion, choose plumbing sizes according to the total capacity after such expansion. However, if tube size is stepped up 3 levels, expansion is not possible.

(\*) If the maximum tube length exceeds 90 m (or equivalent length), use the figure in parentheses ( ) to size the main tubing, along with those of the liquid and gas tubes.

However, size the gas tube only up to Ø38.1. (A reducer has to be fitted on-site)

#### 2) Size of main tubing after branch <sup>(\*)</sup><sup>(\*)</sup>

	When indoor unit(s) are connected				Main tube after branching						
	Post-branching indoor unit capacity (kW) <sup>*3</sup>										
	- 5.6	- 16.0	- 22.4	- 28.0	- 16.0	- 28.0	- 35.5	- 45.0	- 71.0	- 101.0	Over 101.0
Gas tube (mm)	Ø12.7	Ø15.88	Ø19.05	Ø22.22	Ø15.88 (Ø19.05)	Ø22.22 (Ø25.4)	Ø25.4 (Ø28.58)	Ø28.58 (Ø31.75)		Ø31.75 (Ø38.1)	Ø38.1
Liquid tube (mm)	Ø9.52				Ø9.52 (Ø12.7)		Ø12.7 (Ø15.88)		Ø15.88 (Ø19.05)	Ø19.05 (Ø22.22)	

(\*) Select a diameter for the main tubing after a branch that is no larger than that of the header.

(In cases where the main tubing after a branch would have to be larger than the header tubing, select tubing of the same size, and never exceed the header size.)

(\*) If the maximum tube length exceeds 90 m (or equivalent length), use the figure in parentheses ( ) to size the main tube after branching, along with those of the liquid and gas tubes.

However, size the gas tube only up to Ø38.1.

(\*) “- \* ” in the table above means “\*\* kW or less”.

#### 3) Branch/Header Tube Selection

Use the following branch tubing sets or tubing sets for branching the system’s main tube and indoor unit tubing.

Capacity after branch	Branch tube size <sup>(*)</sup>		Branch tube number		
	Gas tube (mm)	Liquid tube (mm)	Branch tubing		
			APR-P160BG	APR-P680BG	APR-P1350BG
Over 72.8 kW	Ø31.75	Ø19.05	—	—	•
Over 45.0 kW to 72.8 kW	Ø28.58	Ø15.88	—	•	•
Over 35.5 kW to 45.0 kW	Ø28.58	Ø12.7	—	•	•
Over 28.0 kW to 35.5 kW	Ø25.4	Ø12.7	—	•	•
Over 22.4 kW to 28.0 kW	Ø22.22	Ø9.52	—	•	•
Over 16.0 kW to 28.0 kW	Ø19.05	Ø9.52	•	•	•
Over 5.6 kW to 16.0 kW	Ø15.88	Ø9.52	•	• <sup>(*)</sup>	• <sup>(*)</sup>
5.6 kW or below	Ø12.7 <sup>(*)</sup>	Ø9.52	•	• <sup>(*)</sup>	• <sup>(*)</sup>

(\*) Make a selection so as not to exceed the main tubing size.

(\*) Even when 5.6 kW or below, make the gas tube diameter Ø15.88 if 2 or more indoor units are connected after branching.

(\*) As the tube diameter for the supplied reducer does not match, another reducer must be provided by the installer.

### 4) Selecting ball valves

Model Type No.	Valve connection tube diameter (mm) <sup>*1</sup>			Applicable outdoor unit	Applicable indoor unit Total indoor unit capacity through valve
	Gas	Liquid	Balance		
SGP-BV710K	Ø31.75	Ø19.05	-	Type 710 (over 90 m)	Over 72.8 kW to 101.0 kW
SGP-BV450K	Ø28.58	Ø19.05	-	-	Over 35.5 kW to 72.8 kW
SGP-BV355K	Ø28.58	Ø15.88	-	Type 710 or 560	Over 45.0 kW to 72.8 kW
SGP-BV450M	Ø28.58	Ø12.7	-	Type 450	Over 35.5 kW to 45.0 kW
BV-RXP335AGB	Ø25.4	Ø12.7	-	Type 355	Over 28.0 kW to 35.5 kW
BV-RXP280AGB	Ø22.22	Ø9.52	-	-	Over 22.4 kW to 28.0 kW
BV-RXP224AGB	Ø19.05	Ø9.52	-	-	Over 16.0 kW to 22.4 kW
BV-RXP160AGB	Ø15.88	Ø9.52	-	-	Over 5.6 kW to 16.0 kW
BU-RXP56AGB	Ø12.7 <sup>*2</sup>	Ø6.35	-	-	5.6 kW or less
BV-RP3GB			Ø9.52	For balance tube	

Note 1. The ID of these valves is about the same as that of the connecting copper tube, so no correction for pressure loss is necessary.

Note 2. Leakage pressure rating must be at least 4.15 MPa.

\*1. Select a size that does not exceed header size.

\*2. Even for 5.6 kW or less, if the indoor unit tubing branches, use 15.88 mm diameter gas tube.

### (3) Selecting header piping

Connect outdoor and indoor units together using a pair of header tubes.

#### 1) Pipe diameters

Header tube (LM) diameter (mm) <sup>*1</sup>	Gas tube	Liquid tube
		Ø31.75

Note: The balance tube (tube between outdoor units) is 9.52 mm dia.

\*1. If the maximum tubing length (L1) exceeds 90m (equivalent length), increase the size of the main piping for both liquid and gas by one size. However, gas tube diameter should not exceed 38.1 mm. (Reducers are available locally.)

#### [Anticipating additional indoor units]

##### 1) Ball valve installation position: Install on main piping after branching.

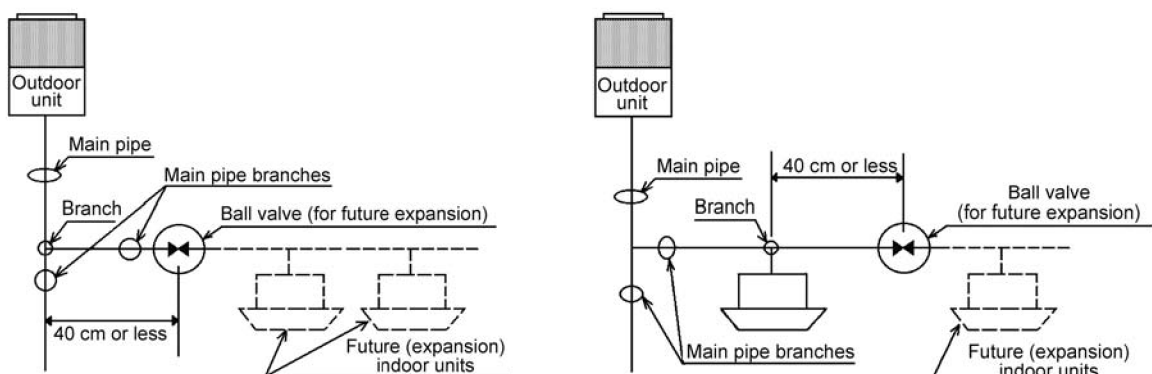

##### 2) Installation guidelines

- Slope main pipes after branches so as to prevent oil buildup.
- Locate ball valves as close as possible to (within 40 cm) of their branch points.
- If the pipe diameter at the ball valve is smaller than that of the main pipe after branching, install reducers only at the ball valve connections.
- Locate the equipment where it will be easy to operate and inspect in the future.

#### Caution

When installing indoor piping (including that for future indoor expansion) along a main pipe after a branch, be sure to position service ports to face in the direction of their units (see dashed lines in the example above).

### [Anticipating additional outdoor units]

- 1) Ball valve installation position: Install on main piping after branching.

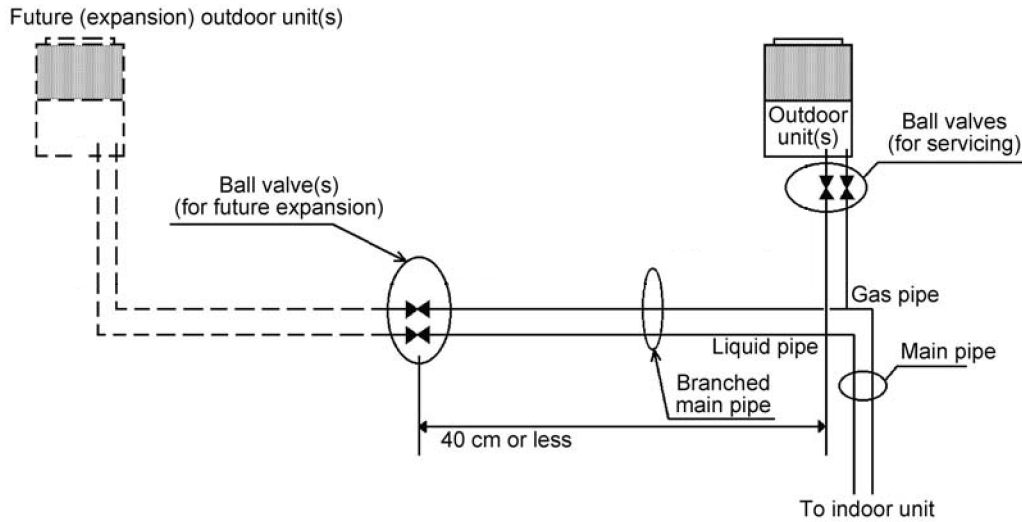

### 2) Installation guidelines

- Slope main pipes after branches so as to prevent oil buildup.
- Locate ball valves as close as possible to (within 40 cm) of their branch points.
- If the pipe diameter at the ball valve is smaller than that of the main pipe after branching, install reducers only at the ball valve connections.

### Caution

When installing outdoor piping (including that for future indoor expansion), be sure to position the valve service port to face in the direction of the outdoor unit (see dashed lines in the example above), and at least 50 cm from the outdoor unit.

### (4) Selecting branch and header piping

<for 2-WAY Multi Models>

#### 1) When a branch pipe set is used

Select the branch set from the following table.

\* For details, see the section on items sold separately.

	Total capacity				
Max. piping length	Up to 16 kW	16.1 – 22.4 kW	22.5 – 35.5 kW	35.6 – 45.0 kW	45.1+ kW
Up to 90m equivalent length	APR-P160BG		APR-P680BG		APR-P1350BG
Over 90m equivalent length	APR-P160BG	APR-P680B		APR-P1350BG	

#### 2) Header piping sets

Select the header piping set from the following table.

\* For details, see the section on items sold separately.

	Total capacity	
Max. piping length	45.0 kW Type	56.0 kW and 71.0 kW and 85.0 kW Type
Up to 90m equivalent length	SGP-HCH280K	SGP-HCH560K
Over 90m equivalent length	SGP-HCH560K	

\* When maximum piping length (L1) exceeds 90m (equivalent length), or if interior unit connected capacity exceeds 130% of outdoor unit capacity, increase the diameter of both liquid and gas pipes (LA) by one size.

Be careful when selecting pipe sizes, as the wrong size may impair performance.

### 3-WAY Multi Models

#### (1) Limitations on refrigerant piping length

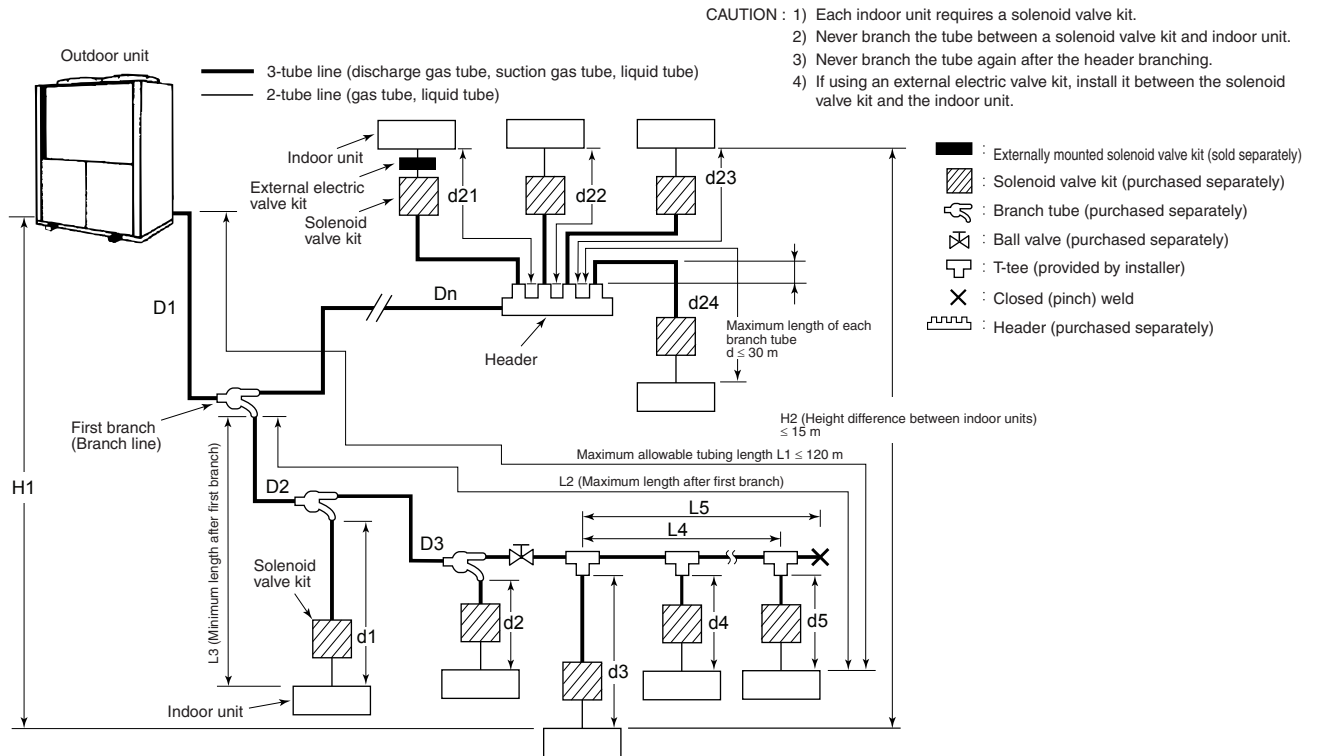

#### (2) Difference in height of Indoor units after last branch

Height difference between indoor units after the final branch must be less than 4 m.

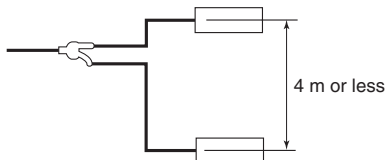

If height difference between indoor units after the final branch cannot be less than 4 m, divide the height difference between upper and lower units (2 to 1).

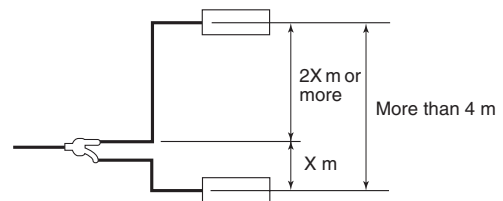

### (2) Selecting system header and branch piping sizes

<for 3-WAY Multi Models>

Table 1. Refrigerant tubing length and range of rise/fall

Indoor unit		45.0 kW	56.0 kW	71.0 kW
Capacity proportion of the indoor units to the outdoor unit		50 - 200 %		
Minimum capacity of indoor units that can be connected		≤ 22 type (equivalent to 0.8 horsepower)		
Maximum number of indoor units (systems) that can be connected		24		
Maximum allowable tubing length (L)	L <sub>1</sub>	≤ 120 m (equivalent length ≤ 145 m) <sup>(*)</sup>		
Difference between longest and shortest tubing lengths after the No. 1 branch (first branching point)	L <sub>2</sub> - L <sub>8</sub>	≤ 30 m		
Maximum length of each tube branch	ℓ <sub>1</sub> , ℓ <sub>2</sub> ...ℓ <sub>8</sub>	≤ 30 m		
Maximum allowable height difference between indoor and outdoor units	If outdoor unit is above	H <sub>1</sub>	≤ 50 m	
	If outdoor unit is below	H <sub>2</sub>	≤ 35 m <sup>(**)</sup>	
Maximum allowable height difference between indoor units	H <sub>3</sub>	≤ 15 m <sup>(***)</sup>		
Maximum length from the first T-tee to the last T-tee	L <sub>3</sub>	≤ 2 m		

(\*1) The minimum length of tubes between outdoor units and indoor units is 7 m.

(\*2) If cooling mode is expected to be used when the external temperature is 10°C or below, install so the maximum length is 30 m.

(\*3) Install so that the height difference between indoor units after the final branch is within the limits shown in Fig 3.

Table 2. Main Piping Diameter

Main Tubing Diameter								
Type 16			Type 20			Type 25		
Suction Tube	Discharge Tube	Liquid Tube	Suction Tube	Discharge Tube	Liquid Tube	Suction Tube	Discharge Tube	Liquid Tube
Ø28.58 (Ø31.75)	Ø22.22	Ø19.05	Ø28.58 (Ø31.75)	Ø25.4	Ø19.05	Ø28.58 (Ø31.75)	Ø25.4	Ø19.05

If the equivalent length of piping is 90m or more or if the total capacity for connected indoor units exceeds 130% use the suction tube size in ( ).

Table 3. Main tubing size after distribution (D2, D3, Dn)

Outdoor unit	Outdoor tubing (mm)		Post-branch main tubing				
			Total capacity for connected indoor units (kW)				
			35.6 to 142.0	28.1 to 35.5	16.1 to 28.0	9.0 to 16.0	Under 9.0
45.0 kW	Suction tube	Ø28.58 (Ø31.75)	Ø28.58 (Ø31.75)	Ø28.58	Ø25.4	Ø19.05	Ø15.88
	Discharge tube	Ø22.22	Ø22.22	Ø22.22	Ø19.05	Ø15.88	Ø12.7
	Liquid tube	Ø19.05	Ø15.88	Ø15.88	Ø12.7	Ø9.52	Ø9.52
56.0 kW	Suction tube	Ø28.58 (Ø31.75)	Ø28.58 (Ø31.75)	Ø28.58	Ø25.4	Ø19.05	Ø15.88
	Discharge tube	Ø25.4	Ø25.4	Ø22.22	Ø19.05	Ø15.88	Ø12.7
	Liquid tube	Ø19.05	Ø19.05	Ø15.88	Ø12.7	Ø9.52	Ø9.52
71.0 kW	Suction tube	Ø28.58 (Ø31.75)	Ø28.58 (Ø31.75)	Ø28.58	Ø25.4	Ø19.05	Ø15.88
	Discharge tube	Ø25.4	Ø25.4	Ø22.22	Ø19.05	Ø15.88	Ø12.7
	Liquid tube	Ø19.05	Ø19.05	Ø15.88	Ø12.7	Ø9.52	Ø9.52

\*1 If anticipating future expansion, select tube diameters according to total capacity after expansion.

\*2 If the maximum tubing length exceeds 90 m (equivalent length), increase the diameter of the main tubing to the size in ( ) for both liquid and gas tubes. However, gas tube diameter should not exceed 31.75 mm. (Reducers are available locally.)

\*3 “\_ \* \*\*” in the table above means “\*\* kW or less”



Table 4. Distribution ⇔ Solenoid valve kit connection piping (3-tube line) <for 3-WAY Multi Models>

Indoor unit	Type	22	28	36	45	56	71	80	90	112	140	160
	Equivalent HP		0.8	1	1.3	1.6	2	2.5	3	3.2	4	5
Tubing dia.	Suction tube	Ø15.88										
	Discharge tube	Ø12.7										
	Liquid tube	Ø9.52										

Table 5. Solenoid Valve Kit ⇔ Indoor unit connection piping (2-tube line)

Indoor unit	Type	22	28	36	45	56	71	80	90	112	140	160
	Equivalent HP		0.8	1	1.3	1.6	2	2.5	3	3.2	4	5
Tubing dia.	Suction tube	Ø12.7 <sup>(*)</sup>			Ø12.7			Ø15.88				
	Liquid tube	Ø6.35						Ø9.52				

\*1 The flare connection method is join Solenoid Valve Kit (option) and the indoor units. Please refer to the operation manual.

### (3) Branch Pipe and Ball Valve Selection

#### (1) Branch pipe selection

From the following branch and header pipe sets, select the applicable model for branches from the system main pipe and indoor unit piping.

Capacity after branch (kW)	Branch pipe model number			
	Branch pipe set			Header pipe set
	APR-RZP224BGB	APR-RZP680BGB	APR-RZP1350BGB	SGP-HCHZ560M
45.1 – 142.0	–	▲	●	●
35.6 – 45.0	–	▲	●	●
28.1 – 35.5	–	●	●	●
16.1 – 28.0	–	●	●	○
9.0 – 16.0	●	○	○	○
<9.0	●	○	○	○

▲ Not usable when the maximum piping length exceeds 90m (equivalent length) or the connected indoor capacity exceeds 130%.

○ Make arrangements locally if the pipe diameters do not match.

#### (2) Ball valve selection

Model No.	Valve connection pipe diameter <sup>*1</sup>			Applicable Outdoor Unit	Applicable Indoor Unit Total indoor unit capacity through valve
	Suction	Liquid	Discharge		
SGP-BV710K	Ø31.75	Ø19.05	–	–	Over 72.8 – 101.0 kW
SGP-BV450K	Ø28.58	Ø19.05	–	Type 450,560 or 710	Over 35.5 – 72.8 kW
SGP-BV355K	Ø28.58	Ø15.88	–	–	Over 45.0 – 72.8 kW
SGP-BV450M	Ø28.58	Ø12.7	–	–	Over 35.5 – 45.0 kW
BV-RXP335AGB	Ø25.4	Ø12.7	–	–	Over 28.0 – 35.5 kW
BV-RXP280AGB	Ø22.22	Ø9.52	–	–	Over 22.4 – 28.0 kW
BV-RXP224AGB	Ø19.05	Ø9.52	–	–	Over 16.0 – 22.4 kW
BV-RXP160AGB	Ø15.88	Ø9.52	–	–	Over 5.6 – 16.0 kW
BU-RXP56AGB	Ø12.7 <sup>*2</sup>	Ø6.35	–	–	5.6 kW or less
SGP-BVZ280K	–	–	Ø19.05	For discharge pipe	

Note 1. The inside diameter of these valves is about the same as that of the connecting copper pipe, so no correction for pressure loss is necessary.

Note 2. Leakage pressure rating must be at least 4.15 MPa.

\*1. Select a size that does not exceed header size.

\*2. Even for 5.6 kW or less, if the indoor unit piping branches, use 15.88 mm diameter gas pipe.

### [Anticipating additional indoor units]

<for 3-WAY Multi Models>

- 1) Ball valve installation position: Install on main piping after branching.

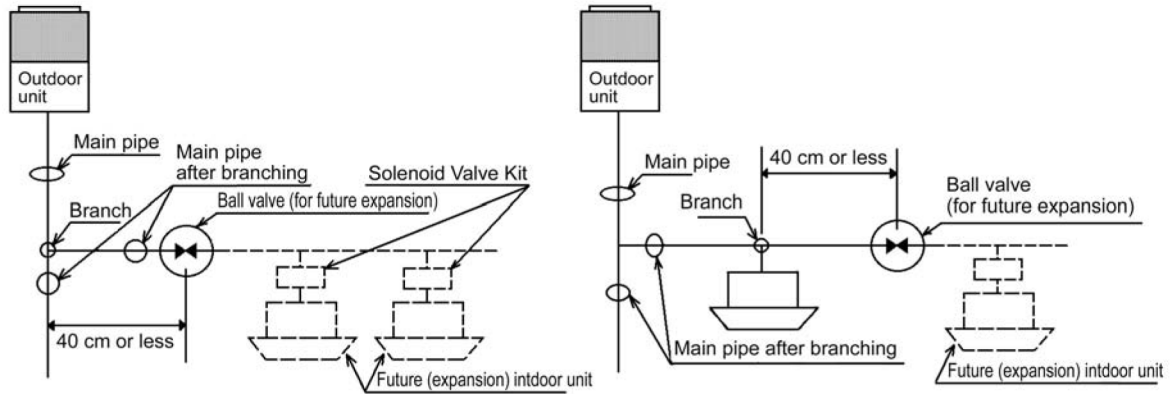

- 2) Installation guidelines

- \* Slope main pipes after branches to prevent oil buildup.
- \* Locate ball valves as close as possible to within 40 cm of their branch points. If the pipe diameter at the ball valve is smaller than that of the main pipe after branching, install reducers only at the ball valve connections.
- \* Locate the equipment where it will be easy to operate and inspect in the future.

### Caution

- \* When installing indoor piping (including that for future indoor expansion) along a main pipe after a branch, be sure to position service ports to face in the direction of their units (see dashed lines in the example above).
- \* Install a service port between the branch and solenoid valve kit, and with additional solenoid valve kits when expanding indoor units.

(3) Solenoid Valve Kits (sold separately)

<for 3-WAY Multi Models>

Model Name	Model No.	Compatible Indoor Units
Solenoid Valve Kit	CZ-P56HR2	Types 22 to 56
	CZ-P160HR2	Types 71 to 160

● Wiring Procedure

Connect the 9P connector coming from the solenoid valve kit through the power inlet of the indoor unit to the 9P connector (red) of the 3 WAY PCB (sold separately). (Fig. 1)

Accessory wire length is 5 m.

In case the wire is not long enough, cut the wire halfway and connect additional wire (field supply) as an extension using a terminal box (field supply) as shown in Fig. 2.

Anchor the cabtyre cable using the binding bands inside the unit.

Do not route the cabtyre cable through the same wiring conduit as the remote controller wiring or inter-unit control wiring.

**Note**

You must follow your local electrical codes.

The wire should be fixed with the clamp inside the indoor unit.

Do not route the wire through a tube together with the remote-control line and inter-unit operation line run.

● Recommended wire size

5-core cable, 0.75 mm<sup>2</sup> or more (300 V or more)

● Grounding should be done between the indoor unit and solenoid valve kit.

**If required wire length is less than 5 m**

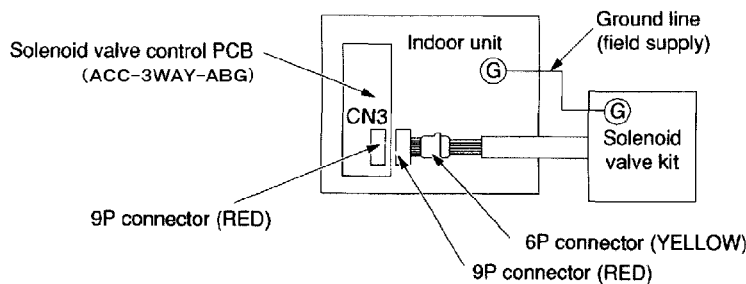

**Fig.1 Connection**

**If required wire length is 5 m or more**

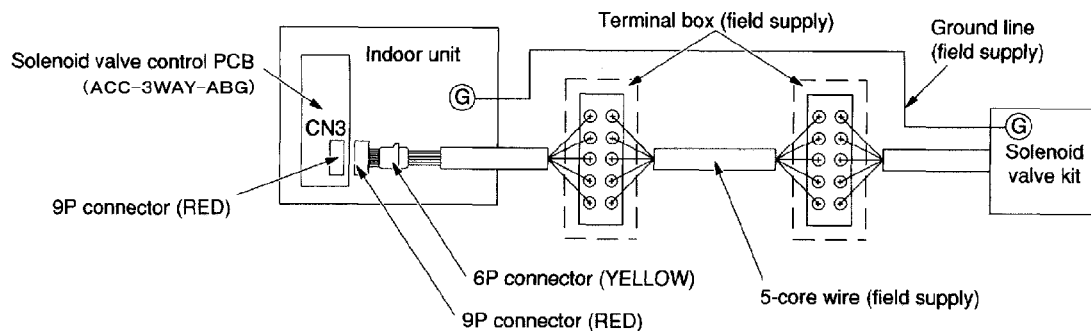

**Fig. 2 Connection**

### (5) Equivalent length of refrigerant piping

The following table shows the equivalent straight piping length of connectors that may be used in the piping system.

Table 3. Equivalent straight piping length of connectors

Inlet pipe or thick pipe (gas pipe)	Units (m)								
	Ø9.52	Ø12.7	Ø15.88	Ø19.05	Ø22.22	Ø25.4	Ø28.58	Ø31.75	Ø38.1
90° elbow	0.15	0.3	0.35	0.42	0.48	0.52	0.57	0.7	0.79
45° elbow	0.1	0.23	0.26	0.32	0.36	0.39	0.43	0.53	0.59
T-tee	0.2	0.5	0.5	0.6	–	0.8	0.9	0.9	–
Socket	0.05	0.1	0.11	0.12	–	0.14	0.16	0.18	–
U bend (R60 -100mm)	0.7	0.9	1.05	1.26	1.44	1.56	1.71	2.1	2.37
Trap bend	1.8	2.3	2.8	3.2	3.8	4.3	4.7	5.0	5.8
Branch pipe	0.5								
Header pipe	1								
Ball valve for service	Not applicable to equivalent length calculation								

Table 4. Equivalent straight piping length of bent pipe

$\frac{R}{d}$	Equivalent length		
	45° bend	90° bend	180° bend
0.5	25.0xd	40.0xd	53.5xd
1.0	12.0xd	18.5xd	25.8xd
1.5	7.8xd	12.2xd	16.4xd
2.0	6.4xd	10.0xd	13.4xd
2.5	5.9xd	9.2xd	12.3xd
3.0	5.7xd	9.0xd	12.0xd
3.5	5.9xd	9.2xd	12.2xd
4.0	6.4xd	10.0xd	13.4xd
4.5	7.1xd	11.0xd	14.8xd

Calculation example

$$d: \text{OD} \quad R: \text{Bend radius} \quad \frac{R}{d} = \frac{30}{19} = 1.57$$

Example:

For a 19 mm dia. Pipe bent 90° with 30 mm radius  
( $d=19 \cdot R=30$ )

From the table,

$$\text{Length} = 12.2 \times 19 = 231 \text{ mm}$$

The result is 0.23

### (6) Calculation of amount of additional refrigerant charge

- Table 2 shows the refrigerant charge at factory shipping time. Additional refrigerant must be added according to the size and length of the piping (calculated from the size and diameter of the liquid piping using the values in Table 1).

Table 1. Quantity of additional refrigerant charge

Liquid tube size (mm)	Additional charge quantity per meter (g/m)
Ø6.35	26
Ø9.52	56
Ø12.7	128
Ø15.88	185
Ø19.05	259
Ø22.22	366

Table 2.

Type	Quantity of refrigerant charge when shipped (kg)
45.0 kW	10.5
56.0 kW	11.5
71.0 kW	
85.0 kW	

Required additional refrigerant charge (g)

$$= 456 \times (A) + 366 \times (B) + 259 \times (C) + 185 \times (D) + 128 \times (E) + 56 \times (F) + 26 \times (G) + \text{Unit additional charge amount (H)}$$

- (A) = total length in meters of 25.4 mm diameter liquid tubing  
 (B) = total length in meters of 22.22 mm diameter liquid tubing  
 (C) = total length in meters of 19.05 mm diameter liquid tubing  
 (D) = total length in meters of 15.88 mm diameter liquid tubing  
 (E) = total length in meters of 12.7 mm diameter liquid tubing  
 (F) = total length in meters of 9.52 mm diameter liquid tubing  
 (G) = total length in meters of 6.35 mm diameter liquid tubing  
 (H) = Unit additional charge amount (Table 7)

Table 3.

Type	Unit additional charge amount (kg)
45.0 kW	–
56.0 kW	0.5
71.0 kW	2.5
85.0 kW	11.0 <sup>*1</sup>

\*1 When connecting a water heat exchange unit, the value is 10.0 kg.

- Be careful to charge accurately according to refrigerant weight.
- Charging procedure  
 Evacuate the system, close the gauge manifold at the gas pipe side to ensure that no refrigerant enters the gas pipe side, then charge the system with liquid refrigerant at the liquid pipe side. While charging, keep all valves fully closed.  
 The compressor can be damaged if liquid refrigerant is added at the gas pipe side.
- If the system does not accept the predetermined quantity of refrigerant, fully open all valves and run the system (either heating or cooling). While the system is running, gradually add refrigerant at the low pressure side by slightly opening the valve on the cylinder just enough so that the liquid refrigerant is gasified as it is sucked into the system. (This step is normally only needed when commissioning the system.)  
 All outdoor unit valves should be fully open.
- When charging is completed, fully open all valves.
- Avoid liquid back-flow when charging with R410A refrigerant by adding small amounts at a time.

#### Notes

- When charging with additional refrigerant, use liquid only.
- R410A cylinders are colored gray with a pink top.
- Check whether a siphon pipe is present (indicated on the label at the top of the cylinder).
- Depending on refrigerant and system pressure, conventional refrigerant (R22, R407A) equipment may or may not be compatible with R410A equipment, so care is needed. In particular, the gauge manifold used must be specifically designed for R410A.
- Be sure to check the limiting density.
- Refer to the section “Opening the closed valves” when the instructions call for fully opening all valves.

(7) Checking the density limit



**WARNING**

The refrigerant (R410A) used in a multi-unit air conditioning installation is in itself a safe refrigerant that is neither flammable nor poisonous, but just in case a leak in a small room should occur, steps need to be taken to prevent gas from exceeding the permissible concentration and causing asphyxiation. The Japan Refrigeration and Air Conditioning Association have stipulated a threshold concentration for refrigerants in its publication “Guidelines for Ensuring Safety in the Event of a Refrigerant Leak from a Multi-Unit Air Conditioning System” (JRA GL-13:2010).

Apart from the lowest level underground, the threshold concentration for the charge in a system has been set to

total refrigerant/living space capacity  $\leq 0.42 \text{ kg/m}^3$  (R410A models).

If this condition is not met, the system must either be equipped with two of the countermeasures (alarm, ventilation or safety shut-off valve) or be redesigned.

Please note, when the system is in the lowest level underground, depending on the type of refrigerant, the threshold concentration and number of countermeasures required may vary.

For further details, either refer to the technical document JRA-GL-13 or consult with your dealer.

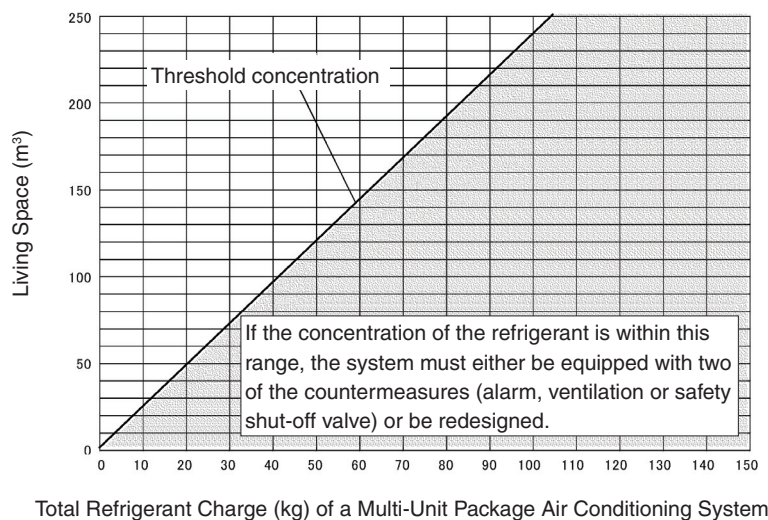

**Fig. 1 Permissible Refrigerant Charge for Specific Systems and their Required Countermeasures (R410A Refrigerant)**  
**<Not Including Lowest Level Underground>**

### (8) Future system expansion

<for W Multi Models>

#### (1) Conditions for adding indoor units

1) Up to 24 indoor units can be connected to an outdoor unit. (Up to two W-Multi outdoor units can be installed for up to 48 indoor units.)

2) Usable indoor unit capacity ranges are:

Minimum: 50% of the minimum capacity of the outdoor units

Maximum: 130% of the total capacity of the outdoor units

(2) Outdoor unit connection conditions (during initial installation, be sure to select piping sizes that will support the total horsepower after expansion).

The following table shows the possible combination for future expansion based on the pipe (main pipe) size.

Outdoor unit planned for current installation		16 HP	20 HP	25 HP
Outdoor unit considered for expansion (up to two units, or 50 HP)	16 HP	—		
	20 HP	—		
	25 HP	—		

1) Outdoor units other than those indicated above cannot be used for expansion. (Doing so may result in a failure.)

2) During initial system installation, be sure to consider the requirements for indoor unit piping after expansion.

(3) Select piping sizes according to requirements after expansion. [Refer to section 2, "System Piping."]

(4) If future system expansion is anticipated, install ball valves (sold separately) at the outdoor and indoor unit sides of the branch pipe. (Figure 1)

1) To prevent oil from being drawn inside, slope piping opposite to flow direction.

2) Locate ball valves as close as possible to the main piping (within 40 cm).

3) If the diameter of the ball valve is smaller than the main piping, install a reducer at the valve.

4) Locate the equipment where it will be easy to operate and inspect in the future.

5) Ball valves for expansion should be installed with their service ports facing the future units they will serve.

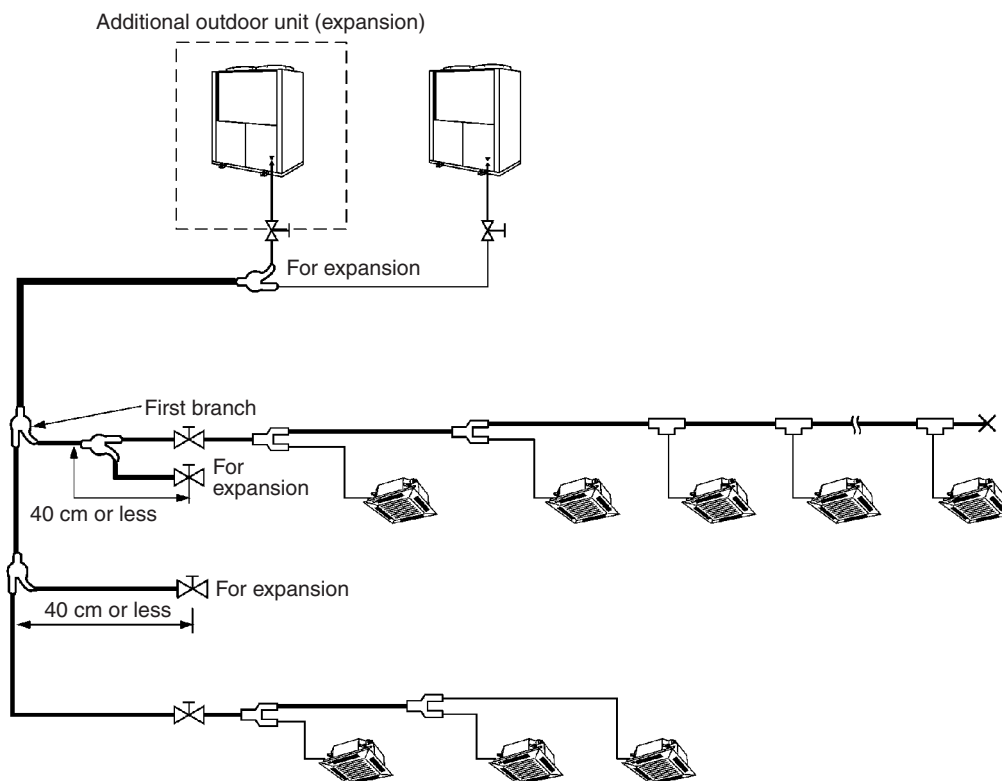
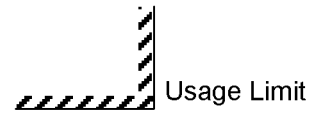

Figure 1



- For 2-WAY Multi (45.0 ~ 85.0 kW Type)  
Refrigerant piping length: 90m (equivalent length) or less



### <Cooling>

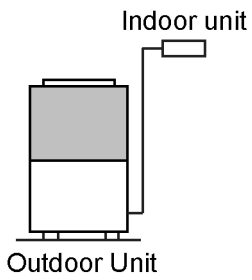
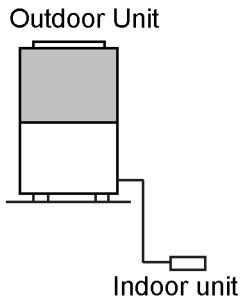
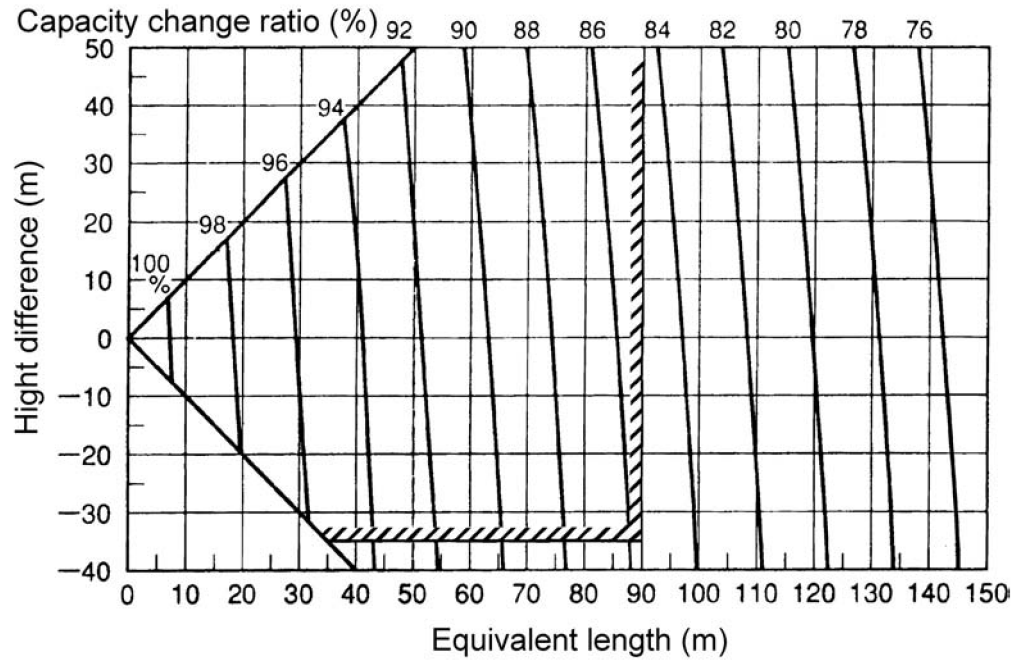

### <Heating>

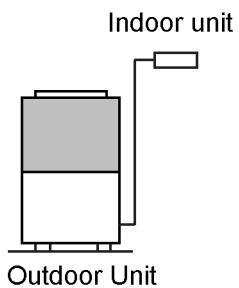
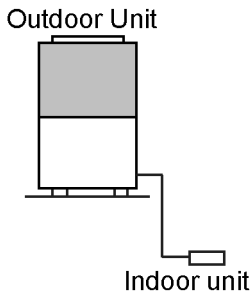
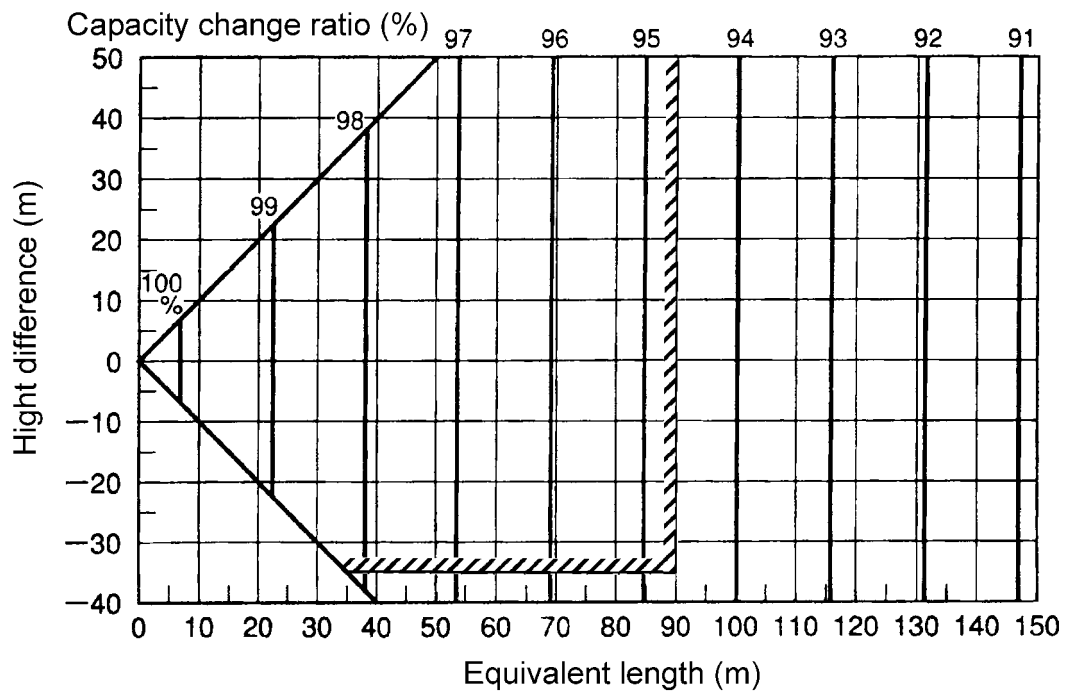



Refrigerant piping length: Over 90m (equivalent length)

### <Cooling>

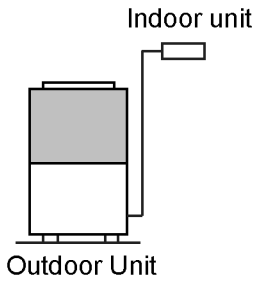
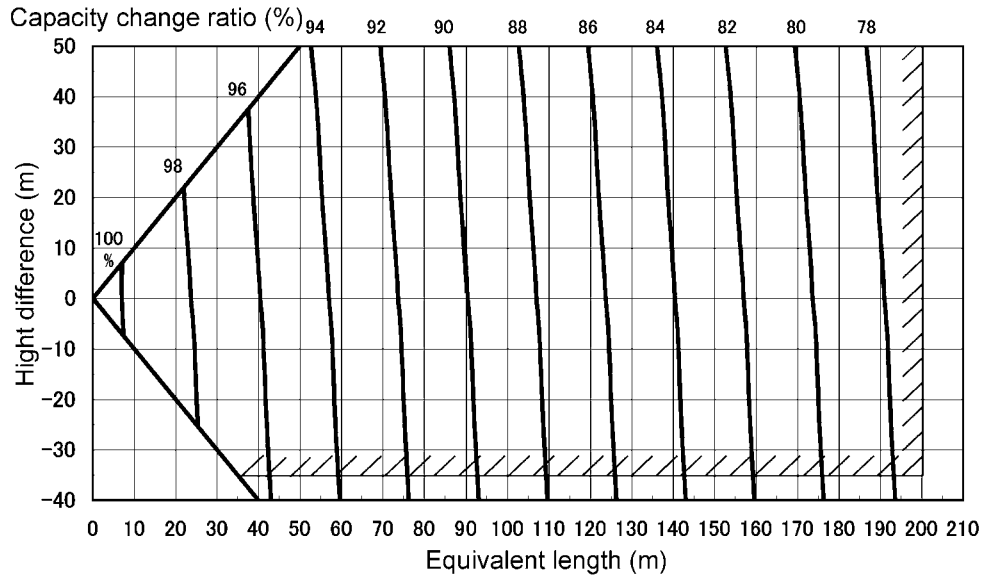
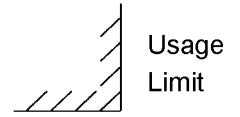
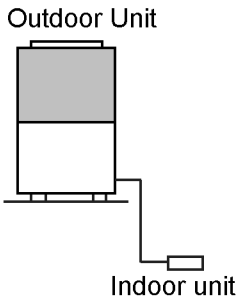

### <Heating>

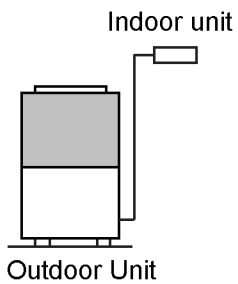
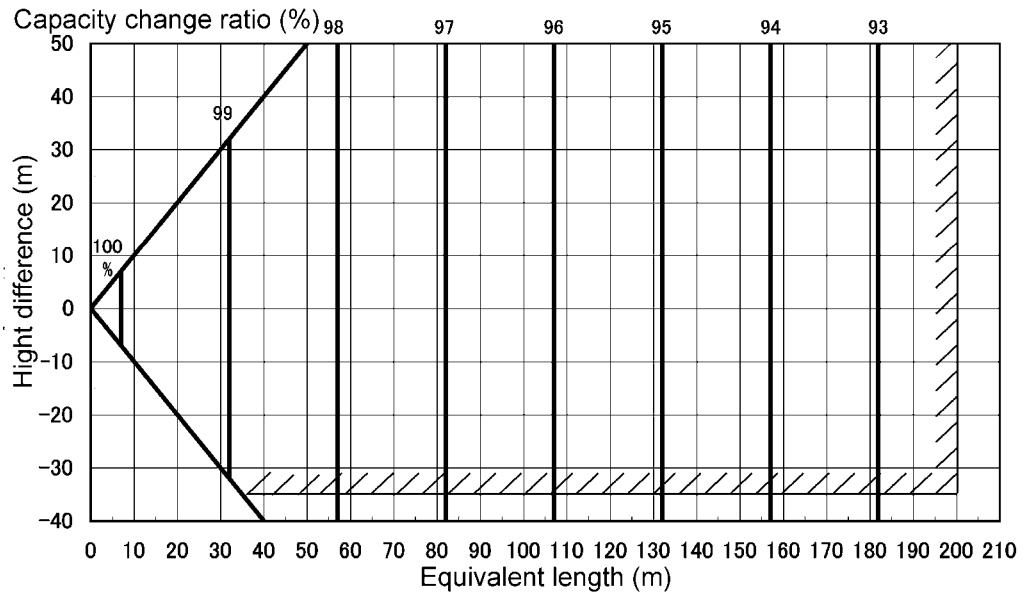
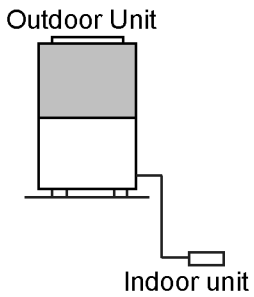

# System Design

## 4. Effect of refrigerant pipe length on performance

- For 3-WAY Multi  
Refrigerant piping length: 90m (equivalent length) or less

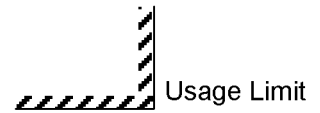

<Cooling>

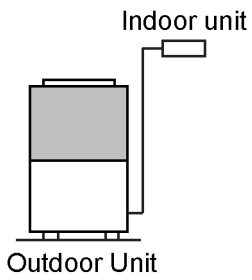
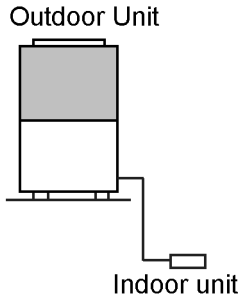
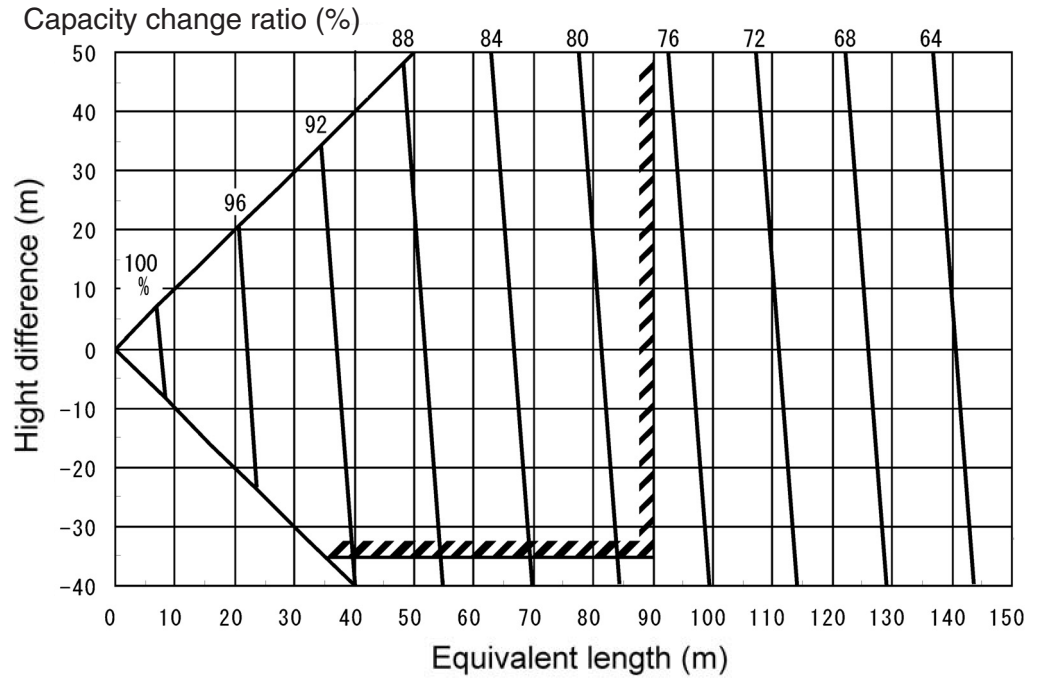

<Heating>

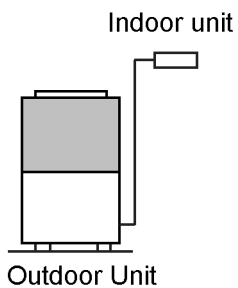
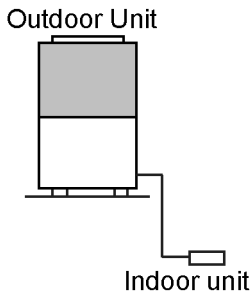
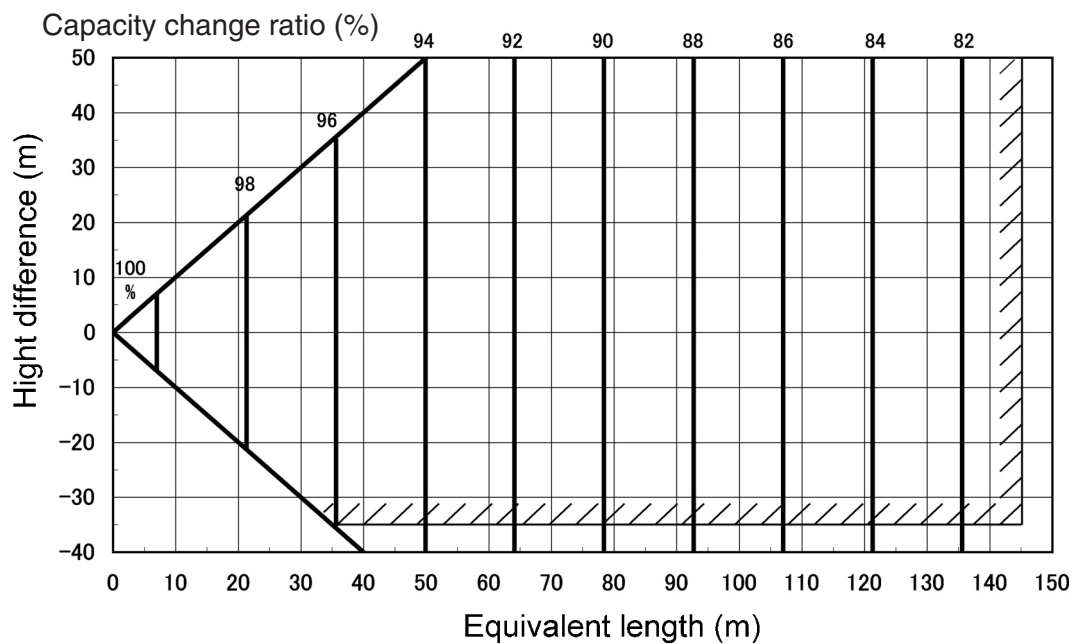

Refrigerant piping length: Over 90m (equivalent length)

### <Cooling>

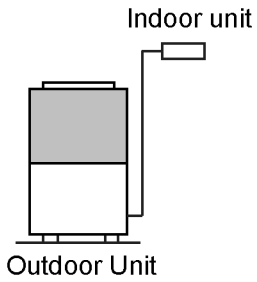
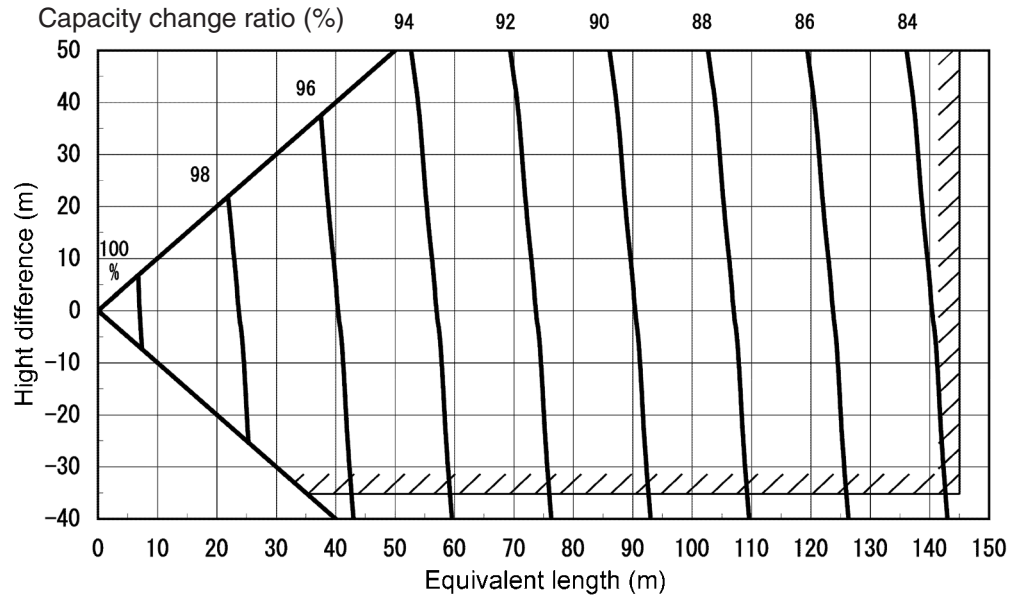
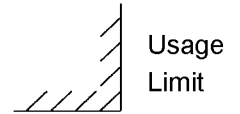
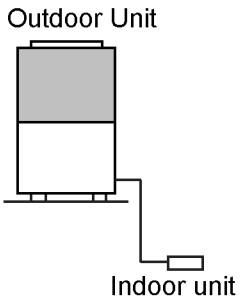

### <Heating>

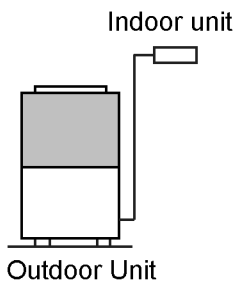
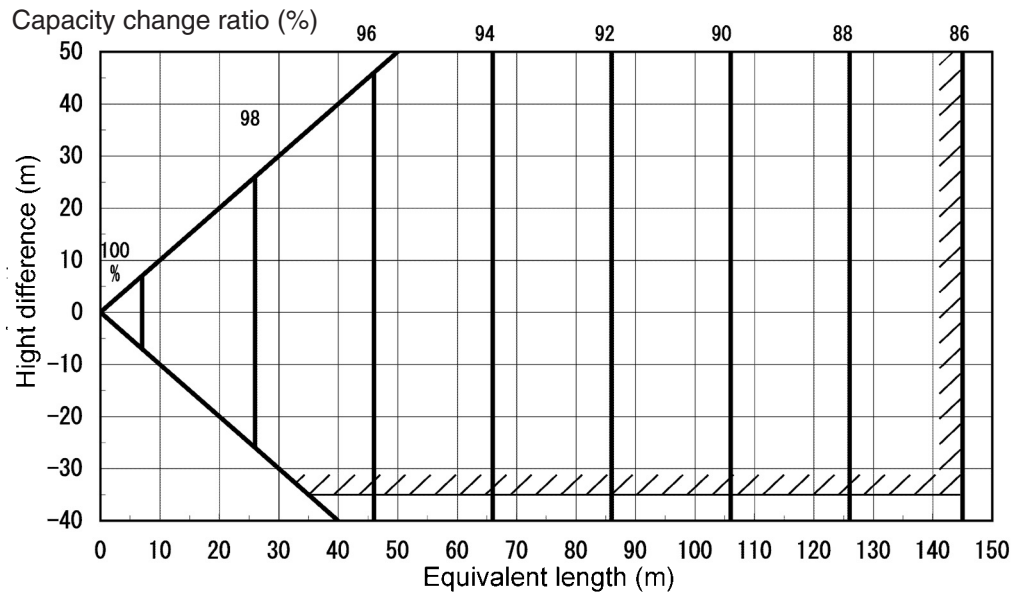
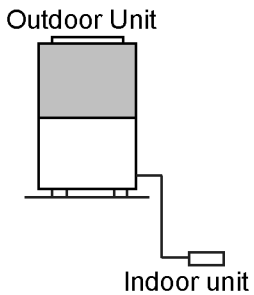

### (1) Combined installation criteria

If several outdoor units are installed on, for example, the roof of a building, the space required for normal operating airflow may be insufficient, causing exhaust air from one outdoor unit to be sucked into another, creating a kind of airflow short circuit. This can cause an increase in the effective ambient air temperature, impeding cooling capability or even forcing emergency shutdown.

Therefore, when installing multiple GHP units, follow the instruction criteria below to ensure sufficient airflow.

Compared with cooling, the effect on heating is slight, so there should be no problems if the installation criteria for cooling are satisfied.

Note: In unusual installation circumstances, give these criteria appropriate consideration when making installation decisions.

#### (1) Scope of applicability of criteria

These criteria apply to installations in either of the following situations:

- When eight or more outdoor units are installed in combination
- When seven or fewer outdoor units are installed where walls are present that may impede air circulation

#### (2) Conditions for combined installation

To ensure adequate airflow, the following conditions must be met in combined installations:

- Adequate spacing must be provided between each outdoor unit and between rows of units.
- Adequate clearance for airflow from the surroundings must be provided for the combined outdoor units.

#### (3) Parameters for combined installations

##### [1] Rows of outdoor units

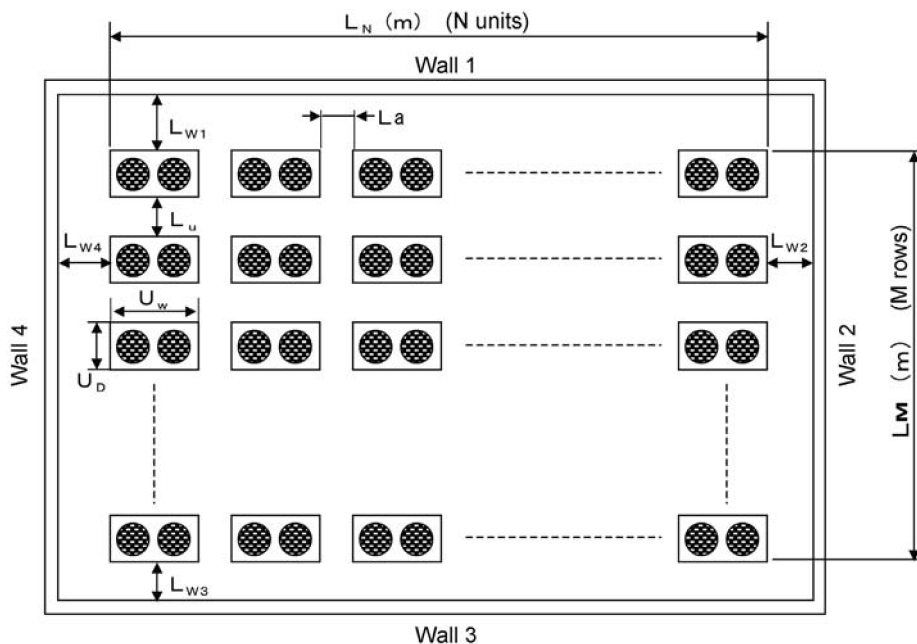

$L_a$  = Average distance between outdoor units (m)

- When the distance between outdoor units is unequal,  $L_a$  is the average.
- Locate no more than three outdoor units near each other.
- If there are six or more units in a row, leave a one-meter gap every three units.

$L_u$  = distance between rows (m)

- All distances  $L_u$  should be equal.

$L_N$  = Row length (m)

$L_M$  = Depth of outside of installation (m)

$L_W$  = Distance from wall to nearest outdoor unit (m)

- If no wall,  $L_W = 6$ .

$U_w$  = Width of outdoor unit (m)

$U_D$  = Depth of outdoor unit (m)

• Outdoor unit installation methods

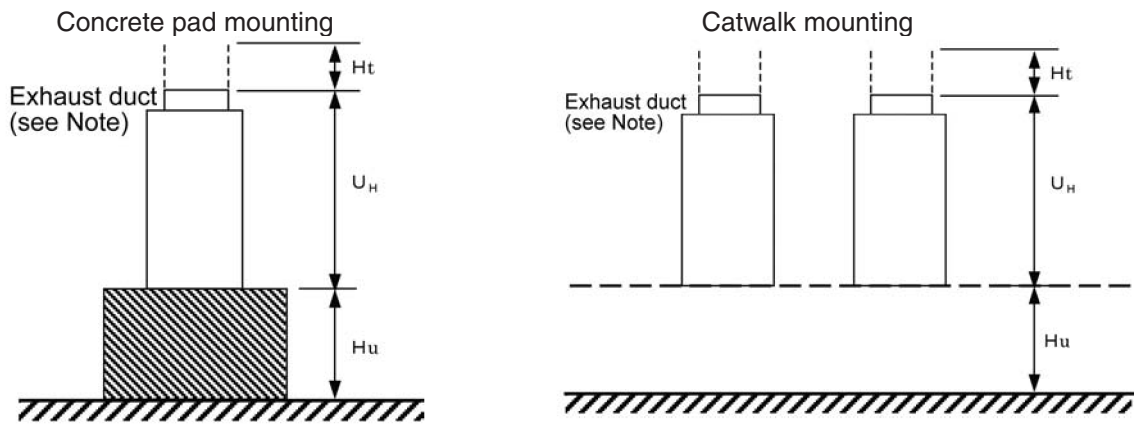

$U_H$  = Height of outdoor unit (m)  
 $H_t$  = Air exhaust duct height (m)  
 $H_u$ : Height of pad or catwalk (m)       $H = H_u + H_t$  (m)

Note: When an air exhaust duct is used, take steps to prevent engine exhaust gas from entering the heat exchanger, such as extending the exhaust pipe to the same height as the air exhaust duct.

(4) Outdoor unit array design flowchart

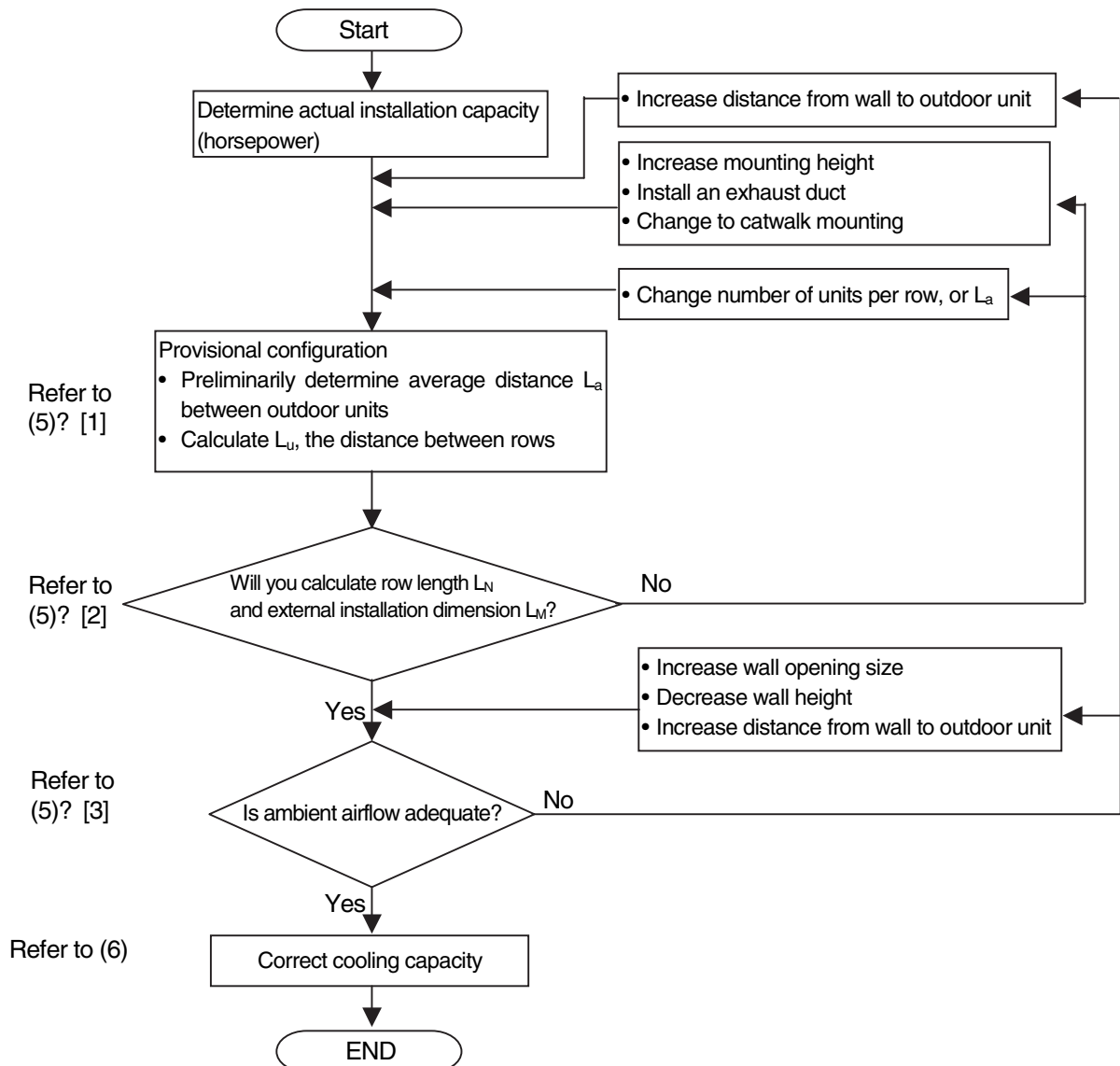

(5) Outdoor unit array design considerations

[1] Provisional design (calculation of distance between units and rows)

Consider the provisional arrangement of different model types (Table 1)

Table 1

Model Type	16 HP	20 HP	25 HP	30 HP
Outdoor unit type	45.0 kW	56.0 kW	71.0 kW	85.0 kW

1) Calculation parameters (Table 2)

Outdoor unit external dimensions

$U_H$  = Height (m)

$U_W$  = Width (m)

$U_D$  = Depth (m)

Outdoor unit airflow (Table 3)

$Q$  = Fan flow rate (m<sup>3</sup>/min)

Table 2

Model Type	$U_H$	$U_W$	$U_D$
16, 20 and 25 HP	2.27	1.65	1.0
30HP	2.27	2.06	1.0

Table 3

Model Type	$Q$
16, 20 and 25 HP	380
30 HP	440

Note: For installation parameters, see (3), "Combined installation parameters."

2) Calculate the average distance between units ( $L_a$ ) and the distance between rows ( $L_u$ )

Here, a provisional value for  $L_a$  is selected from Table 4, and  $L_u$  is then calculated.

If  $L_a$  is large,  $L_u$  is small, and if  $L_a$  is small,  $L_u$  is large..

Note: The minimum maintenance space between units and rows shown in Table 4 must be maintained.

Table 4

Model Type	16, 20, 25 and 30 HP
Minimum spacing between units	0.1m
Minimum spacing between rows	0.95m

a) Provisional determination of  $L_a$

[Pattern 1] Independent arrangement

Rows can be arranged in three patterns, as follows. (continuous groups of up to three units)

$L_a$  is determined respectively as follows.

For  $L \geq 0.35m$

$$L_a = L$$

For  $L < 0.35m$

Provide a space of at least 0.35m every three units. ( $L_2 \geq 0.35$ )

$L_a$  is the average distance between units.

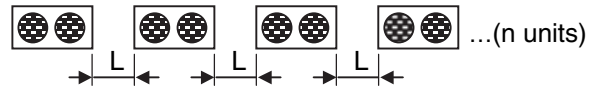

$$L_a = \frac{L + L + L_2 + L + \dots + \dots}{N-1}$$

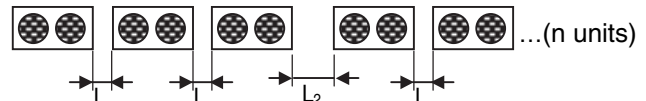

$L_1$  = Minimum distance between continuously spaced units (see Table 4)

[Pattern 2] Paired units

$L_2$  = Provide a larger space (at least 0.35m) between each pair. ( $L_2 \geq 0.35$ )

$L_a$  is the average distance between units.

$$L_a = \frac{L_1 + L_2 + L_1 + L_2 + L_1 \dots}{N-1}$$

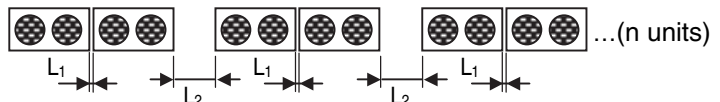

$L_1$  = Minimum distance between continuously spaced units (see Table 4)

[Pattern 3] 3-unit clusters

$L_2$  = Provide larger space (at least 0.35m) between each 3-unit cluster. ( $L_2 \geq 0.35$ )

If there are six or more units in a row, leave a one-meter gap every three units.

$L_a$  is the average distance between units.

$$L_a = \frac{L_1 + L_1 + L_2 + L_1 + L_1 \dots}{N-1}$$

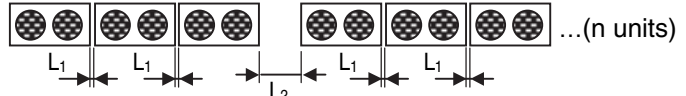

(1m)

b) Calculating  $L_U$

Calculating necessary passage area  $S$  ( $m^2$ )

(calculated on the basis that the airflow between units or rows is a standard 1.5 m/s)

$$S = \frac{Q_m \times N \times (M-1)}{90}$$

$$Q_m = \frac{\text{Total outdoor unit airflow (m}^3/\text{min)}}{\text{No. of outdoor units}}$$

Calculation of actual passage area  $S_a$  ( $m^2$ )

- For installations on concrete pads

$$S_a = [(U_H + H) \times L_a + 0.25L_a^2] \times 2(N - 1)$$

- For installations on catwalks

$$S_a = [(U_H + H) \times L_a + 0.25L_a^2] \times 2(N - 1) + 2N \times U_W \times H_U + 2M \times U_D \times H_U$$

In this example, airflow to the catwalk is obstructed by a wall

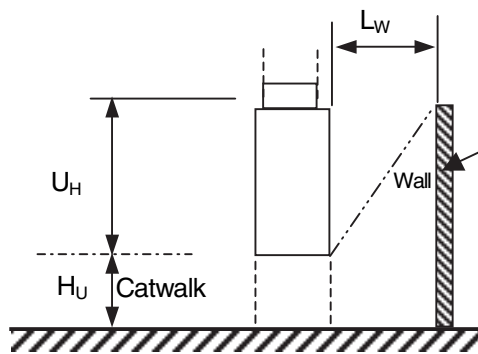

In the diagram at the left, if  $L_W \leq U_H + H_U$ , airflow to the catwalk is obstructed. Airflow from the wall side should be assumed to be zero.

In the above formula, the second parameter is obtained from the area of air inflow from Wall1 and Wall3 sides, and the third parameter is obtained from the air inflow area from the Wall2 and Wall4 sides.

When  $L_W > U_H + H_U$ , obtain  $S_a$  from the above formulae.

Calculation of  $L_U$ , the distance between rows

- For installations on concrete pads

$$L_U = \frac{- (U_H + H) + \sqrt{(U_H + H)^2 + (S - S_a) / [2(M - 1)]}}{0.5}$$

- For installations on catwalks

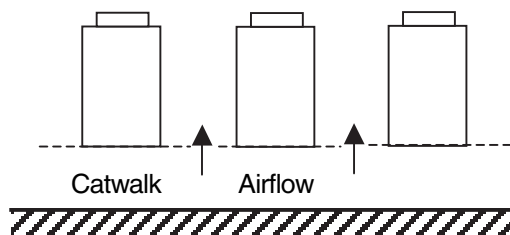

As shown in the diagram at the left, obtain  $L_U$  from the formula below by considering airflow from the bottom of the unit. However, if  $L_W \leq U_H + H_U$ ,  $L_U$  is the same as for concrete pads.

$$L_U = \frac{(S - S_a) + (U_W \times U_D \times N \times (M - 1))}{[U_W \times N + L_a \times (N - 1)] \times (M - 1)} - U_D$$

[2] Determining row length  $L_N$  and depth of outside of installation  $L_M$

1) Calculating row length  $L_N$

Obtain the row length from the following formula. (Refer to paragraph (5)-[1] for descriptions of parameters.)

$$L_N = U_W \times N + L_a \times (N - 1)$$

2) Calculating depth of outside of installation  $L_M$

$$L_M = U_D \times M + L_u \times (M - 1)$$

Note: If  $L_N$  and  $L_M$  are unsuitable, perform one or more of the following, and recalculate.

- Change the units per row or  $L_a$ , and rearrange
- Increase the height of pads or catwalks
- Install exhaust ducts
- Change from pads to catwalk mounts

→ Return to paragraph (5) -[1]

[3] Providing area for air inflow

Procedure:

1) Calculate necessary inflow area  $S_r$



2) Calculate the area of air inflow from surroundings

a) Calculate effective inflow height  $H_{we}$

1. Walls that permit air passage (incl. no wall)

2. Walls that block air passage

b) Calculate effective inflow length  $L_e$

c) Calculate effective inflow area  $S_e (= H_{we} \times L_e)$

3) Determine inflow area

1) Calculate necessary inflow area  $S_r$

Obtain the necessary air inflow area  $S_r$  ( $m^2$ ) to outdoor units in a combined installation from the following formula.

( $S_r$  is the minimum area necessary to avoid degrading system performance.)

$$S_r = (U_{S1} \times N_{T1})$$

where  $S_r$  = necessary inflow area ( $m^2$ )

$U_{S1}$  = necessary inflow area per outdoor unit ( $m^2$ ) (see table below)

$N_{T1}$  = total number of outdoor units installed

Necessary air inflow are per outdoor unit ( $U_{S1}$ ) [ $m^2$ ]			
16 HP	20 HP	25 HP	30 HP
12.7	12.7	12.7	14.6

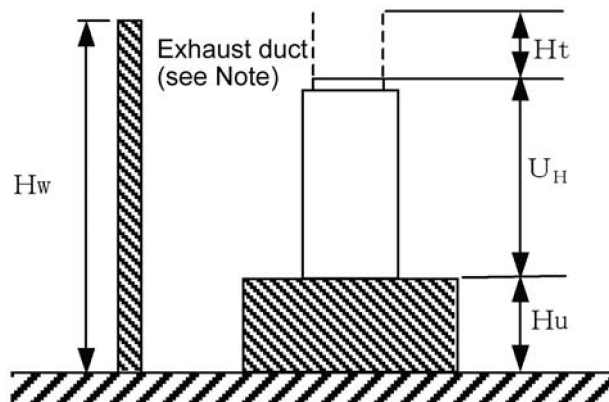

Note: When an air exhaust duct is used, take steps to prevent engine exhaust gas from entering the heat exchanger, such as extending the exhaust pipe to the same height as the air exhaust duct.



- 2) Calculate the area of air inflow from surroundings  
Calculate the effective inflow area, considering the effect of surrounding walls.

- a) Calculate effective inflow height  $H_{we}$

The calculation method depends on the type of wall. The two types to consider are louvers, which allow air to pass, and sound barrier walls, which do not.

- i). Walls that permit air passage (including the case of no wall)

- Use the following formula to calculate the height of inflow,

$H_{a1}$  to  $H_{a4}$  (m) for each wall.

$$H_a = L_w + H_u + 1.5H_t + U_H$$

where

$H_a$  = inflow height (m)

$L_w$  = Distance from wall to nearest outdoor unit (m)

However, when there is no wall,  $L_w = 6$ .

(Refer to item (5) -[1]-1) for details of  $U_H$ .)

- Calculate effective inflow height  $H_{we}$  (m) for each wall. Depending upon wall height and inflow height  $H_a$ , apply one of the following formulae.

For  $H_w \geq H_a$ ,  $H_{we} = (H_a - (H_u + H_H + H_t)) \times X_w + (H_u + H_H + H_t) \times X_w \times 2$

For  $H_w < H_a$ ,  $H_{we} = (H_a - H_w + [H_w - (H_u + H_H + H_t)] \times X_w + (H_u + H_H + H_t) \times X_w \times 2$

where  $H_w$  = Wall height (m)

$X_w$  = Wall opening fraction

- The wall height below the exhaust part ( $H_u + H_H + H_t$ ) has twice the weighting of other parts (inflow wind speed is doubled from 0.5 to 1 m/s).
- When there is no wall,  $H_{we} = H_a$ .

- ii). Walls that block air passage

- Use the following formula to calculate apparent heights  $H_{b1}$  to  $H_{b4}$  (m) for each wall.

$$H_b = H_w - H_u - 1.5H_t$$

where  $H_b$  = Apparent height (m) of wall

$H_w$  = Wall height (m)

- For each wall, use the diagram at the right to obtain the effective inflow heights  $H_{we1}$  to  $H_{we4}$  (m) for each wall.

- b) Calculate effective inflow length  $L_e$

From the effective inflow height  $H_{we}$  calculated for each wall, calculate effective inflow lengths  $L_{e1}$  to  $L_{e4}$ .

- Calculate the effective distance from each boundary surface (wall) to the nearest unit,  $L_{wei}$  (m).

With no wall:  $L_{wei} = 6$

If  $L_{wi} \geq 6m$ , then  $L_{wei} = 6$

If  $L_{wi} < 6m$ , then  $L_{wei} = L_{wi}$

- Calculate effective inflow lengths  $L_{e1}$  to  $L_{e4}$  (m) for each wall.

$$L_{e1} = L_N + L_{we4} + L_{we2}$$

$$L_{e2} = L_M + L_{we3} + L_{we1}$$

$$L_{e3} = L_{e1}$$

$$L_{e4} = L_{e2}$$

- c) Calculate effective inflow area

From effective inflow heights  $H_{we1}$  to  $H_{we4}$  and lengths  $L_{e1}$  to  $L_{e4}$ , calculate the effective inflow area for each wall.

- i) Calculate effective inflow area  $Se_1$  to  $Se_4$  (m) for each wall.

$$Se_1 = H_{we1} \times L_{e1}$$

$$Se_2 = H_{we2} \times L_{e2}$$

$$Se_3 = H_{we3} \times L_{e3}$$

$$Se_4 = H_{we4} \times L_{e4}$$

- ii) Calculate the overall effective inflow area,  $Set$  (m<sup>2</sup>).

$$Set = Se_1 + Se_2 + Se_3 + Se_4$$

- iii) Calculate the areas of adjoining surfaces.

$$Se_{12} = Se_1 + Se_2$$

$$Se_{23} = Se_2 + Se_3$$

$$Se_{34} = Se_3 + Se_4$$

$$Se_{41} = Se_4 + Se_1$$

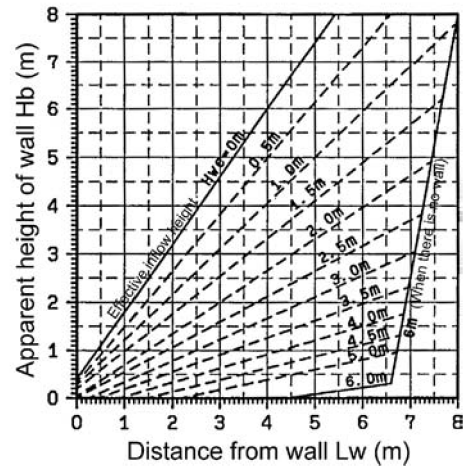

3) Judge the inflow area

From the required inflow area calculated in 1), and the effective inflow area calculated in 2)-C), satisfy the following two conditions.

- 1) Overall effective inflow area ( $S_e$ ) must be greater than required inflow area  $S_r$ .
- 2) In an array with three or more rows, the smallest value of inflow area of two adjoining walls ( $S_{e_{12}}$ ,  $S_{e_{23}}$ ,  $S_{e_{34}}$  or  $S_{e_{41}}$ ) must be greater than 25% of  $S_r$ :  $\text{Min}(S_{e_{12}}, S_{e_{23}}, S_{e_{34}} \text{ or } S_{e_{41}}) \geq 0.25 \times S_r$

If these conditions are not satisfied, apply the following measures, and recalculate.

- Increase mounting height
- Install exhaust ducts
- Change from pads to catwalk mounts

→ Return to paragraph (5) -[1]

- Increase wall opening size
- Lower the height of walls
- Increase the distance from walls to units

→ Return to paragraph (5)-[3]-2)

(6) Correction of cooling capability

By meeting these criteria, the temperature of the intake air in this combined installation is expected to rise by 3°C during cooling.

Obtain the reduction in cooling capability for each unit from the characteristics for that model type.

### (2) Verandah installation criteria

If outdoor units are installed on a verandah where they are surrounded (by walls and ceiling) on five sides, the design layout must take into account short-circuit airflow and maintenance space requirements. Evaluate the installation on each floor of a building in the same way.

#### (1) Design points

- 1) Do not allow the exhaust air from an outdoor unit to recirculate, as this would seriously degrade system performance.
- 2) Do not install a gallery on the exhaust outlet. (Installing a gallery reduces airflow by over 10%.)
- 3) Create an environment in which exhaust air from the outdoor unit will not cause any problems.
- 4) Comply with local regulations regarding operating noise from outdoor units.
- 5) Distance to the nearest building should be at least 10m.
- 6) Design external air conditions are based on ambient temperature of 35°CDB or less.
- 7) Make certain to provide adequate maintenance space.

#### (2) Necessary inflow area

- 1) For an installation like that of Figure 1, the shaded area indicates the inflow area.
- 2) The necessary inflow area for one 13- to 25-HP outdoor unit is 12.7m<sup>2</sup>, so the shaded area is the necessary inflow area

#### (3) Maintenance space

Provide maintenance space with the dimensions in Figures 1 and 2.

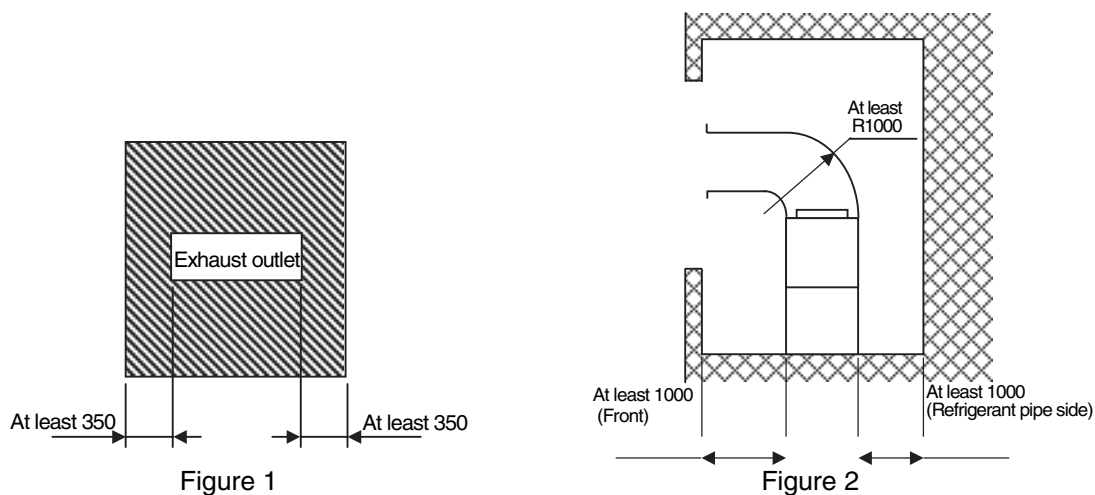

#### (4) Installations on each story

When installing on multiple stories, a horizontal separation of 5m should be provided as shown in Figure 3 to prevent intake of exhaust air from outdoor units on the floor below.

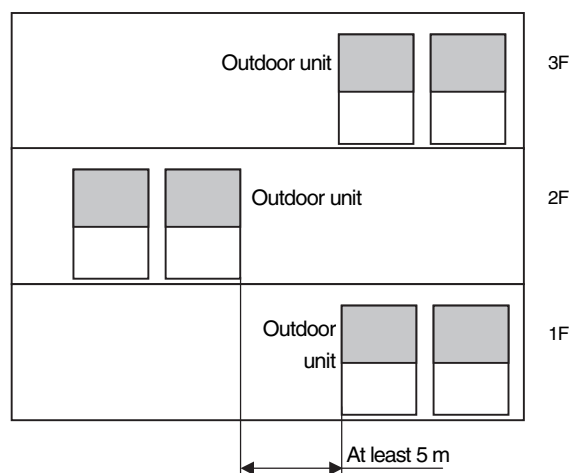

Figure 3.

### (1) Installation location and sound-proofing measures

If no suitable installation location is available and it is necessary to install in a confined location where there are houses, offices or other buildings nearby, it may be necessary to provide sound barrier walls, sound absorption chambers or other secondary sound-proofing measures.

Secondary sound-proofing measure include:

- Attenuation over distance
- Sound-proofing with noise barriers
- Sound-proofing using sound absorbing chambers
- Sound-proofing by vibration isolation (anti-vibration pads, flexible couplings, etc.)

The following criteria are from Tokyo Pollution Prevention Regulations.

Criteria for everyday sound levels

Condition  Area type		Ordinary standards								Special standards
		Morning		Daytime		Evening		Night		Near schools and hospitals (approx. 50m)
		Sound level (phon)	Time	Sound level (phon)	Time	Sound level (phon)	Time	Sound level (phon)	Time	
Type 1	Residential and school areas, etc.	40	6 AM to 8 AM	45	8 AM to 7 PM	40	7 PM to 11 PM	40	11 PM to 6 AM	Same as at left
Type 2	Residential and undesignated areas	45		50		45		45		
Type 3	Commercial, light industrial, industrial areas	55		60	8 AM to 8 PM	55	8 PM to 11 PM	50		At least 5 phon lower than at left
Type 4	Shopping areas and specially designated areas	60		70		60		55		

### (2) Attenuation of sound over distance

The figure at the right shows sound attenuation over distance. (Figure 1)

Operating sound is measured 1m from its source.

Example. For a type 280 outdoor unit, the sound level in the 50-Hz range at 3m distance is specified as 56 dB(A). In Figure 1, follow the 3m distance line downwards to where it crosses the slope (a), and then horizontally to point (b) at the left to find the attenuation of 6.8 dB(A). Therefore,  $56 - 6.8 = 49.2$  dB(A)

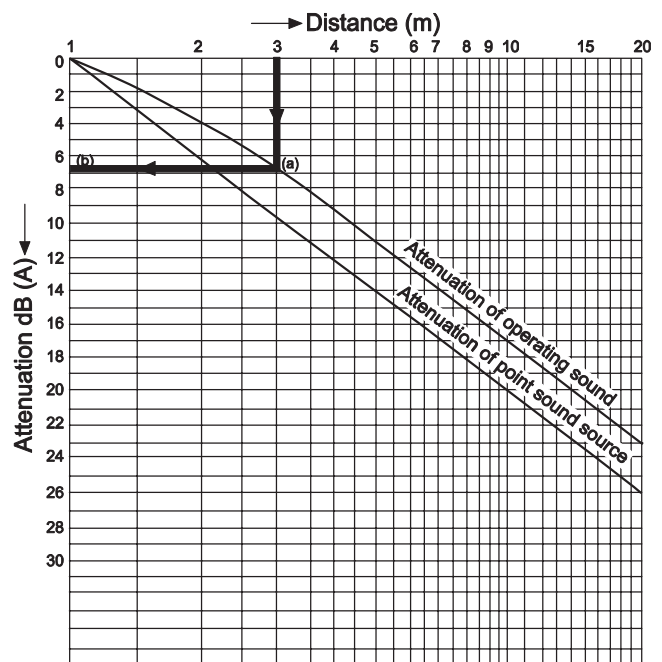

Note: Operating is measured in a location having few reflecting surfaces (bottom surface concrete)

Distance attenuation of operating sound

### (3) Sound attenuation by a noise barrier

Sound attenuation of an indoor unit at a reception point behind a noise barrier or building depends on the frequency and path length difference.

$$\delta = \text{path length difference}$$

$$\delta = (A+B) - d$$

Ex. 1

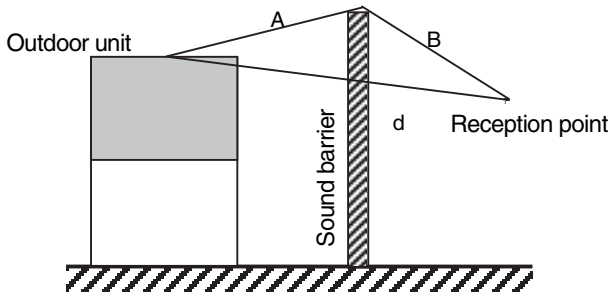

Ex. 3

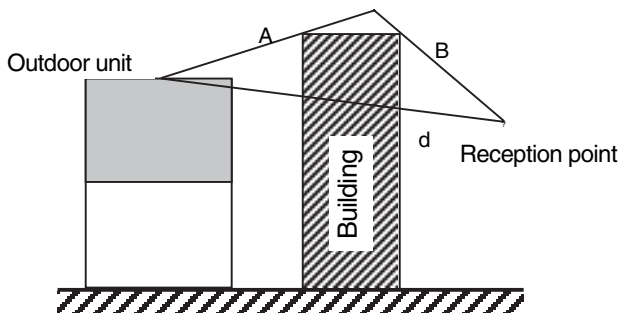

Ex. 2

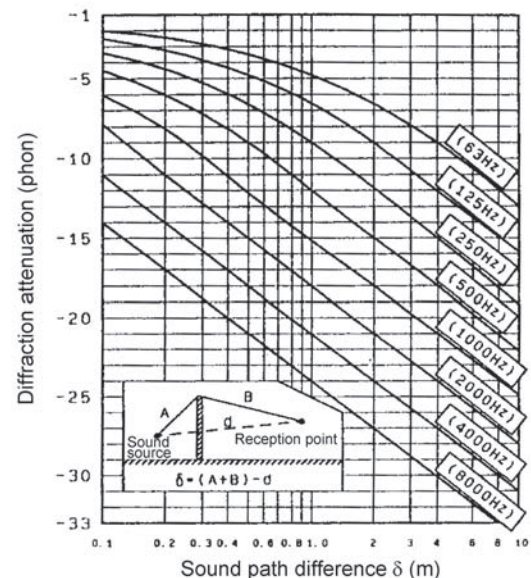
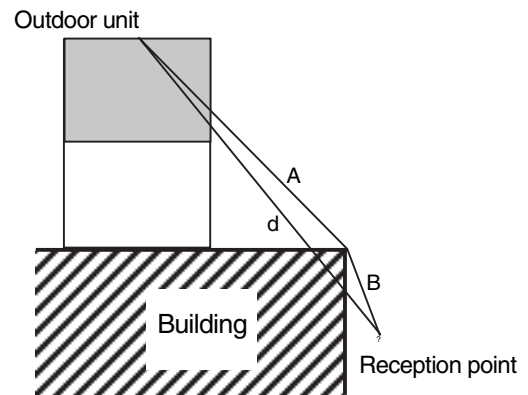
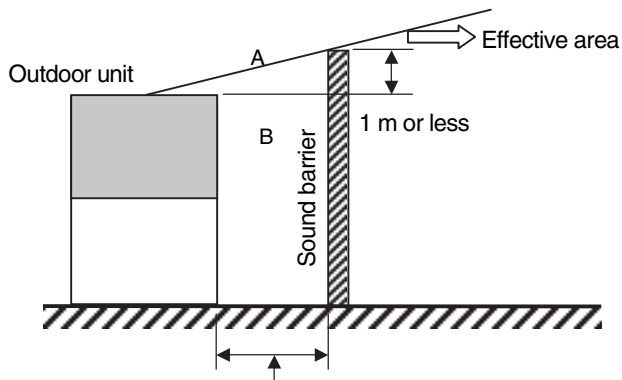

Figure 2. Diffraction attenuation

- The barrier should be located as close as possible to the outdoor unit (sound source). (Figure 3) (Be certain to preserve the required space for air intake and exhaust, service and maintenance.)
- The barrier should be sufficiently higher than the top of the outdoor unit. (Figure 3) (However, not more than 1m higher.)
- The width of the barrier should be at least several times the height, on both sides of the center. Where this is not possible, the barrier should bend around the unit as shown in Figure 4.



As close as possible (while maintaining minimum clearances required for intake, exhaust and servicing of each unit)

Figure 3. Sound barrier

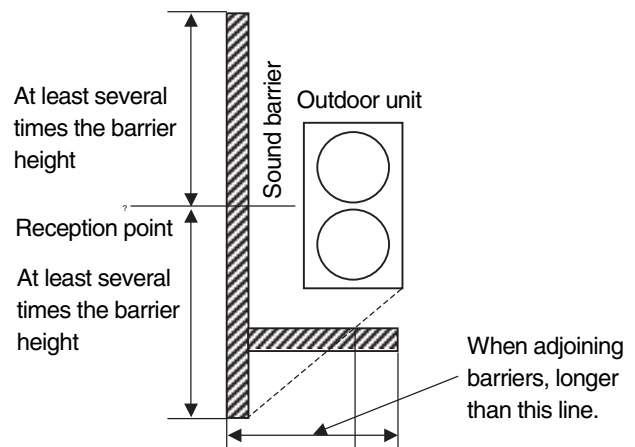

Figure 4. Sound barrier

### (4) Additional sound from reflections

- Operating sound from outdoor units reflects from the walls of building and ground surfaces. These reflections are received at the reception point, increasing the sound level of the system.
- The sound received at the reception point is the sum of the sound propagated directly from the source plus reflected sound.

The reflected sound level is obtained by establishing a virtual sound source (A'), and estimating the sound level at B from A' (subtract the distance attenuation over the path A'-B). See the next paragraph on combining sounds for a description of how to add direct and reflected sounds.

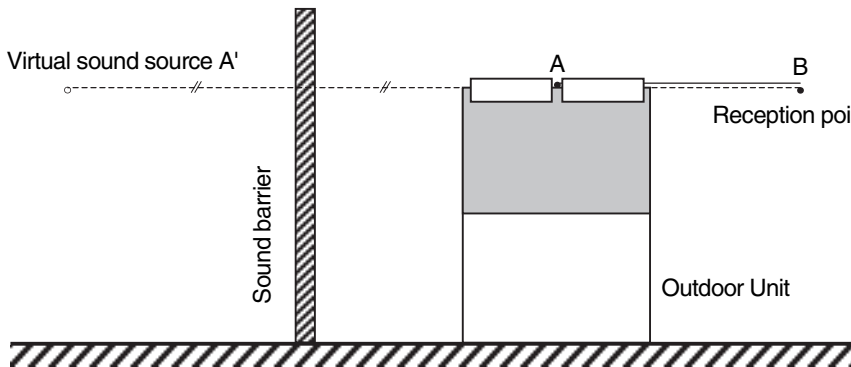

Figure 6. Adding reflected sound (wall surface)

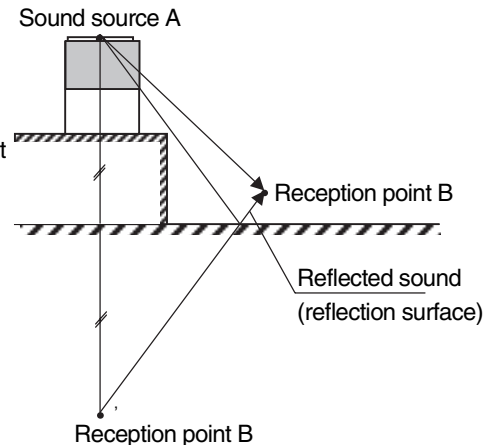

Figure 7. Adding reflected sound (ground surface)

### (5) Combining sounds

For multiple outdoor units, the sound level at the reception point is determined by combining the sounds from each unit.

The combined sound from  $n$  units  $L_1, L_2, \dots, L_n$  is expressed by the following formula.

If  $L$  = the combined sound level,

$$L = 10 \log_{10} \left( 10^{\frac{L_1}{10}} + 10^{\frac{L_2}{10}} + \dots + 10^{\frac{L_n}{10}} \right)$$

For example, adding 61 phones and 62 phones gives

$$L = 10 \log_{10} \left( 10^{\frac{61}{10}} + 10^{\frac{62}{10}} \right) = 64.5 \text{ dB}$$

This for of expression is applicable for any value of  $n$ .

Although sound level can be calculated this way, for simplicity, we have prepared graphs to use instead.

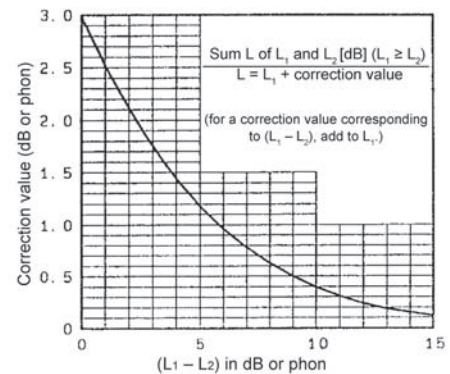

Figure 5. Combined sound correction values

<Calculation Example 1>

Calculate the combined sound level of  $L_1 = 62$  [dB] and  $L_2 = 61$  [dB].  $L_1 - L_2 = 62 - 61 = 1$  [dB], the correction value from Figure 5 is 2.5 [dB], and  $62 + 2.5 = 64.5$  [dB], so the combined sound level is 64.5 [dB].

<Calculation Example 2>

To combine sound levels of 60, 64, 63 and 65 dB, first sort the values in order of magnitude.

65, 64, 63 and 60 dB

Then combine 65 and 64 dB to obtain the difference,  $65 - 64 = 1$  dB, which has a correction value of 2.5 dB, and  $65 + 2.5 = 67.5$  dB.

Next, combine 67.5 and 63 dB for a difference of 4.5 dB, for which the correction value is 1.3 dB, and  $67.5 + 1.3 = 68.8$  dB.

In the same way, combine 68.8 and 60 dB for level difference of 8.8 dB, for which the correction value is 0.5 dB.

And finally,  $68.8 + 0.5 = 69.3$  dB, which is the combined level of the four sounds.

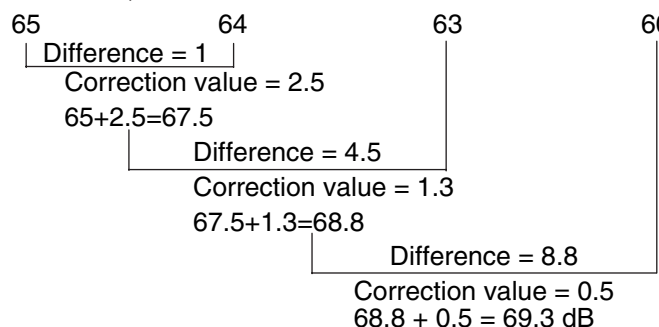



(6) Converting from octave band levels to overall A weighting

Table 1. Correction factor for converting from octave bands to A weighting

Octave band	Hz	63	125	250	500	1000	2000	4000	8000
Conversion factor	dB	-26	-16	-9	-3	0	+1	+1	-1

Using the above table, the A weighting is obtained by adjusting the calculated value for each band by its conversion factor. These values are then combined in order of magnitude, as shown in the following example, to obtain the overall A weighting.

<Calculation example>

The octave band levels (dB) are obtained from the frequency analysis table (the operating sound level at the center frequency of each octave band). These values are corrected with the A weighting correction factor to obtain the A weighting. The following calculation determines the operating sound level.

Octave band	Hz	63	125	250	500	1000	2000	4000	8000
Octave band level	dB	69	66	62	59	56	49.5	45	41.5
Conversion correction	dB	-26	-16	-9	-3	0	+1	+1	-1
A weighting	dB(A)	43	50	53	56	56	50.5	46	40.5

These A-weighting values are combined one-by-one in order of magnitude (in the same way as combining different operating sounds).

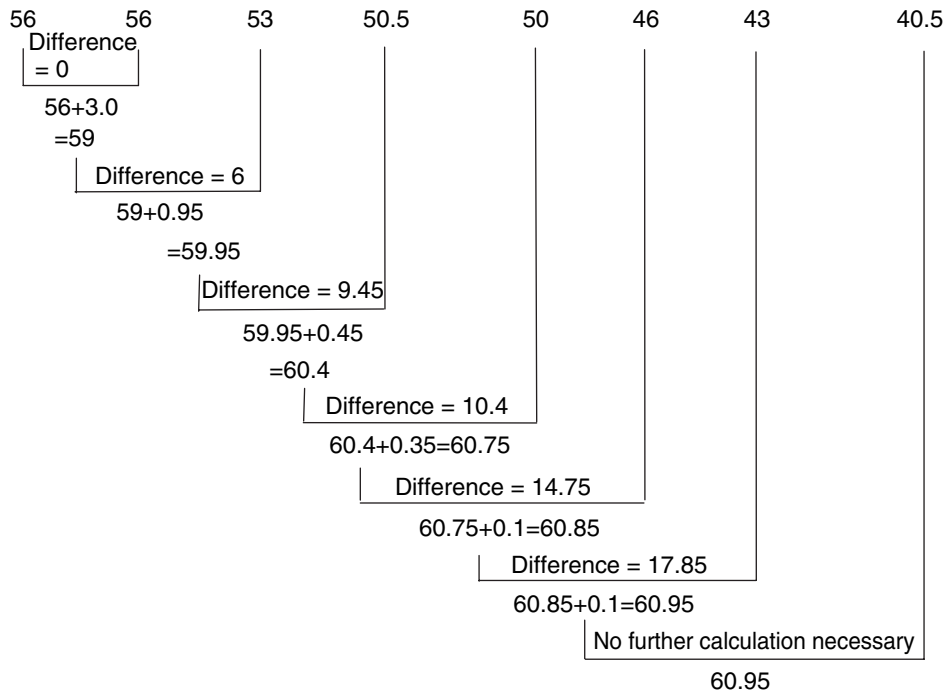

The overall A weighting is thus calculated to be 60.95 dB(A).

(7) Designing sound-proofing countermeasures

<Calculation example>

In the installation drawing at the right, a scheme to suppress operating sound at the reception point is required.

First, determine the operating sound level of the outdoor unit at each frequency. By applying this information to Table 1, the sound-proofing calculation sheet, sound attenuation and additions are calculated for the installation.

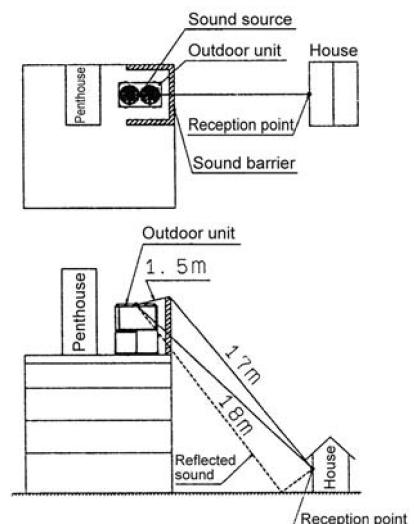

Table 1. Sound-proofing calculation sheet (filled-in example)

Frequency	Hz	63	125	250	500	1000	2000	4000	8000
1) Operating sound of outdoor unit	dB	From the operating sound characteristics diagram in the outdoor unit manual							
		69	66	62	59	56	49.5	45	41.5
2) Distance attenuation	dB	From distance attenuation							
		From Fig. 1, attenuation of unit operating sound = -22							
3) Refraction attenuation	dB	Fig. 2, Refraction attenuation, sound path difference $\delta = A + B - d = 0.5$							
		-3.5	-5	-6.5	-9	-12	-15	-18	-21
4) Additional sound from reflections (wall surface)	dB	Fig. 6, Additional sound due to reflections (wall)							
		By calculation or the simplified method, the maximum value of the two combined sounds is +3							
5) Additional sound from reflections (ground surface)	dB	Fig. 7, Addition sound due to reflection (ground surface)							
		By calculation or the simplified method, the maximum value of the two combined sounds is +3							
6) Subtotals	dB	49.5	45	39.5	34	28	18.5	11	4.5
7) Overall A-weighting correction factors	dB	Conversion factors for A weighting							
		-26	-16	-9	-3	0	+1	+1	-1
8) A weighting	dB(A)	23.5	29	30.5	31	28	19.5	12	3.5

When the calculations of Table 1 are completed, the overall A weighting can be calculated.

31	30.5	29	28	23.5
Difference = 0.5				
(31 + 2.7)				
33.7				
Difference = 4.7				
(33.7 + 1.2)				
34.9				
Difference = 6.9				
(34.9 + 0.8)				
35.7				
Difference = 12.2				
35.7 + 0.25 = 35.95 dB				

The overall A weighting at the reception point is calculated to be 35.95 dB(A).

If the ambient noise (when the unit is not operating) is 30.0 dB(A), the combining these levels gives 36.9 dB(A).

35.95	30.0
Difference = 5.95	
(35.95 + 0.95)	
= 36.9	

(8) Sound-proofing calculation sheet (example)

Frequency	Hz	63	125	250	500	1000	2000	4000	8000
1) Operating sound of outdoor unit	dB	From the operating sound characteristics diagram in the outdoor unit manual							
2) Distance attenuation	dB	Distance attenuation							
		Distance attenuation value = _____							
3) Refraction attenuation	dB	Refraction attenuation, sound path difference $\delta = A + B - d$ , $\delta =$ _____							
4) Additional sound from reflections (wall surface)	dB	Additional sound due to reflections (wall)							
		By calculation or the simplified method, the maximum value of the two combined sounds is +3							
5) Additional sound from reflections (ground surface)	dB	Fig. 7, Addition sound due to reflection (ground surface)							
		By calculation or the simplified method, the maximum value of the two combined sounds is +3							
6) Subtotals	dB								
7) Overall A-weighting correction factors	dB	Conversion factors for A weighting							
		-26	-16	-9	-3	0	+1	+1	-1
8) A weighting	dB(A)								

By completing the calculations in the above table, the overall A weighting at the reception point is obtained (calculate in order from the highest sound level).

Once the overall A weighting has been calculated, combine with the ambient noise level to obtain to total sound level at the reception point.



### (1) Earthquake resistance calculations

Several earthquake-resistance ranks are used for carrying out earthquake-resistance calculations, as shown in the following table. Gas heat pump air conditioners are considered to be common use equipment.

- Equipment earthquake-resistance ranks

Earthquake-resistance ranks and their meanings are as follows

		Maintenance of operation	Horiz. design force (Horizontal seismic coefficient)	Strength calculation	Earthquake-resistance evaluation
Equipment Earthquake Resistance	Earthquake resistant type	Can be operated after inspection	1.5 G	Design target value	Strength calculation or verification test (Note 2), and installation earthquake-resistance
	Common use type	Can be operated after small-scale repairs (Note 1)	1.0 G	As above	Installation earthquake-resistance evaluation (Note 3)
	Small equipment	As above	0.6 G	As above	As above

#### Notes

- 1) Small-scale repairs are those that require up to two days to complete.
- 2) Mainframe strength (static), fasteners for each component (bolts, etc.)
- 3) Mounting bolt calculations, etc.

\* The table is from “Earthquake-resistant equipment specification criteria for package air conditioners and water chillers” published by the Japan Refrigeration and Air Conditioning Industry Association.

The above criteria are applicable to normal air conditioning equipment installed in buildings subject to normal approval procedures under the Buildings Standard Law (e.g., less than 60m high)

### (2) Verifying the strength of foundation bolts during an earthquake

- Calculation formulae and table of allowable stresses

- Design earthquake force

1) The design earthquake force consists of a horizontal force and a vertical force, acting simultaneously on the equipment through the center of gravity.

2) The following formula gives the design earthquake force.

$$F_H = K_H \cdot W$$

$$F_V = \frac{1}{2} F_H$$

$F_H$  : Design horizontal force (N)

$W$  : Equipment operating weight (N)

$K_H$  : Design horizontal quake magnitude (Japanese scale)

$F_V$  : Design vertical force (N)

Equipment rank	Design horiz. Magnitude $K_H$ (Japanese scale)
Earthquake resistant	1.5 G
Common use type	1.0 G

#### Notes

- 1) “Earthquake resistant” refers to essential building services
- 2) “Common use type” refers to non-essential building services
- 3) Equipment with earthquake-resistant supports incorporates stoppers to prevent amplification of shaking due to resonance. In this case, shock-absorbent materials are placed between the stoppers and equipment so that the stoppers are not damaged or deformed by impact.

(Floor or pad mounting)

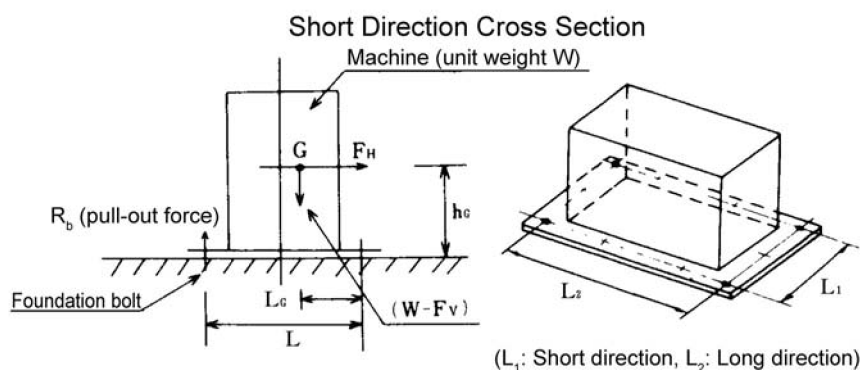

In the diagram above,

- G : Position of center-of-gravity of equipment
- W : Weight (N) of equipment alone
- R<sub>b</sub> : Pull-out force of one mounting bolt (N)
- n : Total no. of mounting bolts
- n<sub>t</sub> : No. of mounting bolts on one side subject to tension by toppling force (in the direction being considered)
- h<sub>G</sub> : Height of unit center-of-gravity above mounting surface (mm)
- L : Bolt span (mm) from direction of concern (L<sub>1</sub> : End-on direction, L<sub>2</sub> = Broadside direction)
- L<sub>G</sub> : Distance from center-of-bolt to center-of-gravity as viewed from direction of concern (but L<sub>G</sub> ≤ L/2 (mm))

Mounting bolt pull-out force

$$R_b = \frac{F_H \cdot h_G - (W - F_V) \cdot L_G}{L \cdot n_t}$$

Mounting bolt shear stress

$$\tau = \frac{F_H}{n \cdot A}$$

F<sub>H</sub> : Design horizontal force (N)

$$(F_H = K_H \cdot W)$$

F<sub>V</sub> : Design vertical force (N)

$$F_V = \frac{1}{2} F_H$$

A : Nominal cross-sectional area of one mounting bolt (mm<sup>2</sup>)

τ : Shear stress on bolt (N/ mm<sup>2</sup>)

f<sub>ts</sub> : Allowable tensile stress on a bolt with simultaneous shear stress (N/ mm<sup>2</sup>)

However, f<sub>ts</sub> ≤ f<sub>t</sub>

Mounting bolt tensile stress

$$\delta = \frac{R_b}{A}$$

Allowable tensile stress on a bolt with simultaneous shear stress

$$f_{ts} = 1.4f_t - 1.6\tau$$

Table of allowable stress on bolts

Units (N/ mm<sup>2</sup>)

Bolt material	Bolt diameter	Long-term allowable stress		Short-term allowable stress	
		Tension (f <sub>t</sub> )	Shear (f <sub>s</sub> )	Tension (f <sub>t</sub> )	Shear (f <sub>s</sub> )
SS400	40 mm or less	118	88	176	132
	More than 40 mm	108	80	162	121
SUS304	40 mm or less	137	103	206	154
	More than 40 mm	126	94	188	141

Notes

- 1) The values in the above table are derived from "Steel structure design criteria" published by the Architects Institute of Japan.
- 2) Use the value f<sub>t</sub> in the table if necessary to investigate bolt tensile stress.
- 3) Strength of a bolt subject to simultaneous tension and shear can be checked as follows.
  - a) τ f<sub>s</sub>
  - b) σ ≤ the smaller of f<sub>t</sub> or f<sub>ts</sub>, but f<sub>ts</sub> = 1.4f<sub>t</sub> - 1.6τ  
 where, τ : Shear stress on bolt  
 σ : Tensile stress on bolt (σ = R<sub>b</sub>/A)  
 f<sub>s</sub> : Allowable stress on bolt with shear stress only (value from above table)  
 f<sub>t</sub> : Allowable stress on bolt with tensile stress only (value from above table)  
 f<sub>ts</sub> : Allowable tensile stress on a bolt with simultaneous shear stress, but f<sub>ts</sub> ≤ f<sub>t</sub>
- 4) The allowable tensile stresses in the above table are evaluated using the cross-sectional area of the minor diameter of the screw thread. However, when calculating for selection purposes, the cross-sectional area based upon the nominal diameter may be used.
- 5) If the threaded portion is subject to shear, then if using the cross-sectional area based upon the nominal diameter, multiply the value of f<sub>s</sub> in the above table by 0.75.

(1) Allowable pull-out force of embedded J- and JA-type bolts

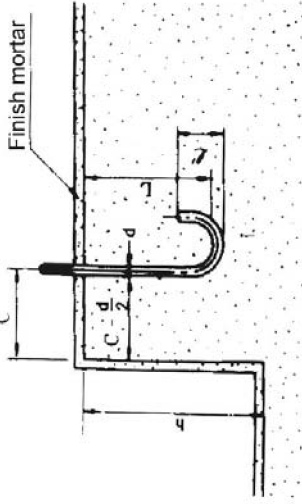
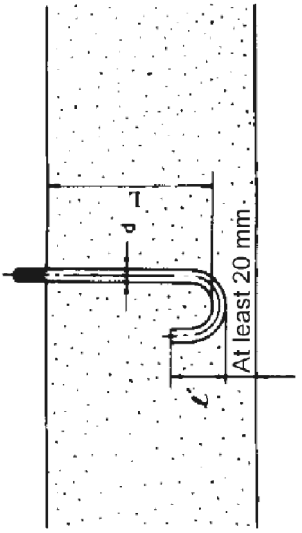
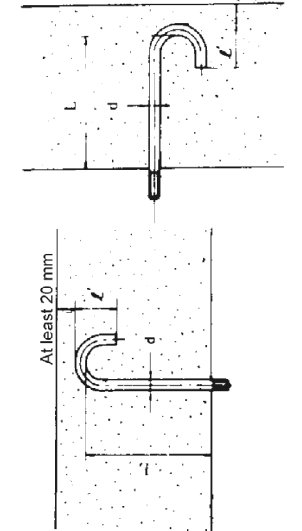
<p>Installation location: a) Solid foundation</p> 	<p>b) Upper surface of normal floor slab</p> 	<p>c) Bottom surface of normal ceiling slab, concrete wall surface</p> 																																																																																
<p>Short-term allowable pull-out load of a bolt is obtained with the following formulae. However, if the shear stress on the bolt exceeds 44.1 N/mm<sup>2</sup> (for SS400), bolt strength and assurance that allowable tensile stress is not exceeded must be verified.</p> $T_a = 6\pi \cdot L^2 \cdot p \quad \dots(a)$ <p>Where,</p> $T_a = \text{Anchor bolt allowable short-term pull-out load (N)}$ $L = \text{Embedded length of anchor bolt (mm)}$ <p>However, L must be between 60 and 300</p> $p = \text{Correction factor for concrete design strength is}$ $P = \frac{1}{6} \min \left( \frac{F_c}{30}, 0.49 + \frac{F_c}{100} \right)$ $F_c = \text{Concrete design characteristic strength (N/mm}^2\text{)}$ <p>(Normally, 17.6 N/mm<sup>2</sup> is used.)</p> <p>For bolts near a corner or edge of a foundation, if the distance from the center of the bolt to the edge is <math>C \leq L</math>, the allowable short-term pull-out load of the bolt is given by either formula (b) or (c) below.</p> <ol style="list-style-type: none"> <li>For <math>L \leq C + h</math>,  <math display="block">T_a = 6\pi \cdot C^2 \cdot p \quad \dots(b)</math> </li> <li>For <math>L &gt; C + h</math>,  <math display="block">T_a = 6\pi \cdot (L \cdot h)^2 \cdot p \quad \dots(c)</math> </li> </ol> <p>Where C = the distance from the edge of the foundation to the center of the bolt (mm)                      However, <math>L \geq C \geq 4d</math>, and  <math display="block">\frac{1}{2} C \geq 50 \text{ mm}</math>  <math display="block">h = \text{Foundation pad height (mm)}</math> </p> <p>Notes</p> <ol style="list-style-type: none"> <li>L should be <math>\geq 6d</math> (where d = nominal anchor bolt diameter).</li> <li>In the above diagram, is approx. 4.5 d for a JIS bolt.</li> <li>If type 1 or 2 lightweight concrete is used, allow 10% margin.</li> </ol>	<p>Short-term pull-out load (N)</p> <table border="1" data-bbox="592 860 842 1464"> <thead> <tr> <th>Bolt diameter d (nominal)</th> <th>120</th> <th>150</th> <th>180</th> <th>200</th> </tr> </thead> <tbody> <tr> <td>M 8</td> <td>8820</td> <td>8820</td> <td>8820</td> <td>8820</td> </tr> <tr> <td>M10</td> <td>11760</td> <td>11760</td> <td>11760</td> <td>11760</td> </tr> <tr> <td>M12</td> <td>11760</td> <td>11760</td> <td>11760</td> <td>11760</td> </tr> <tr> <td>M16</td> <td>-</td> <td>11760</td> <td>11760</td> <td>11760</td> </tr> <tr> <td>M20</td> <td>-</td> <td>-</td> <td>11760</td> <td>11760</td> </tr> <tr> <td>M24</td> <td>-</td> <td>-</td> <td>-</td> <td>11760</td> </tr> <tr> <td>Length of bolt embedded, L (mm)</td> <td>100-d</td> <td>130-d</td> <td>160-d</td> <td>180-d</td> </tr> </tbody> </table> <p>Notes</p> <ol style="list-style-type: none"> <li>These are short-term allowable pull-out loads for bolts embedded as shown in the diagram above.</li> <li>The concrete design characteristic strength is taken to be <math>F_c = 17.6 \text{ N/mm}^2</math>.</li> <li>When the dimensions differ from the above diagram, or if the concrete design characteristic strength differs, then the pull-out load can be calculated according with the formulae for bolts in a strong foundation, at the left. In any case, the allowable pull-out load on one bolt must not exceed 11,760 N.</li> <li>It is desirable that <math>L \geq 6d</math>. The conditions indicated by "-" in the above table should be avoided.</li> <li>In the above diagram, is approx. 4.5 d for a JIS bolt.</li> <li>If type 1 or 2 lightweight concrete is used, allow 10% margin.</li> </ol>	Bolt diameter d (nominal)	120	150	180	200	M 8	8820	8820	8820	8820	M10	11760	11760	11760	11760	M12	11760	11760	11760	11760	M16	-	11760	11760	11760	M20	-	-	11760	11760	M24	-	-	-	11760	Length of bolt embedded, L (mm)	100-d	130-d	160-d	180-d	<p>Long-term allowable pull-out load (N)</p> <table border="1" data-bbox="592 217 842 824"> <thead> <tr> <th>Bolt diameter d (nominal)</th> <th>120</th> <th>150</th> <th>180</th> <th>200</th> </tr> </thead> <tbody> <tr> <td>M 8</td> <td>5880</td> <td>5880</td> <td>5880</td> <td>5880</td> </tr> <tr> <td>M10</td> <td>7840</td> <td>7840</td> <td>7840</td> <td>7840</td> </tr> <tr> <td>M12</td> <td>7840</td> <td>7840</td> <td>7840</td> <td>7840</td> </tr> <tr> <td>M16</td> <td>-</td> <td>7840</td> <td>7840</td> <td>7840</td> </tr> <tr> <td>M20</td> <td>-</td> <td>-</td> <td>7840</td> <td>7840</td> </tr> <tr> <td>M24</td> <td>-</td> <td>-</td> <td>-</td> <td>7840</td> </tr> <tr> <td>Length of bolt embedded, L (mm)</td> <td>100-d</td> <td>130-d</td> <td>160-d</td> <td>180-d</td> </tr> </tbody> </table> <p>Notes</p> <ol style="list-style-type: none"> <li>These are short-term allowable pull-out loads for bolts embedded as shown in the diagram above.</li> <li>The concrete design characteristic strength is taken to be <math>F_c = 17.6 \text{ N/mm}^2</math>.</li> <li>When the dimensions differ from the above diagram, or if the concrete design characteristic strength differs, then the pull-out load can be calculated according with the formulae for bolts in a strong foundation, at the left, and divide the result by 1.5 to obtain the allowable pull-out load. In any case, the allowable pull-out load on one bolt must not exceed 7,840 N.</li> <li>It is desirable that <math>L \geq 6d</math>. The conditions indicated by "-" in the above table should be avoided.</li> <li>In the above diagram, l is approx. 4.5 d for a JIS bolt.</li> <li>It is necessary to investigate the short-term pull-out load of normal supports with regard to earthquakes when the supports are installed in the bottom of ceiling slabs and on concrete walls designed to support heavy objects. For this short-term pull-out load, see Item b, "Short-term pull-out loads."</li> <li>If type 1 or 2 lightweight concrete is used, allow 10% margin.</li> </ol>	Bolt diameter d (nominal)	120	150	180	200	M 8	5880	5880	5880	5880	M10	7840	7840	7840	7840	M12	7840	7840	7840	7840	M16	-	7840	7840	7840	M20	-	-	7840	7840	M24	-	-	-	7840	Length of bolt embedded, L (mm)	100-d	130-d	160-d	180-d
Bolt diameter d (nominal)	120	150	180	200																																																																														
M 8	8820	8820	8820	8820																																																																														
M10	11760	11760	11760	11760																																																																														
M12	11760	11760	11760	11760																																																																														
M16	-	11760	11760	11760																																																																														
M20	-	-	11760	11760																																																																														
M24	-	-	-	11760																																																																														
Length of bolt embedded, L (mm)	100-d	130-d	160-d	180-d																																																																														
Bolt diameter d (nominal)	120	150	180	200																																																																														
M 8	5880	5880	5880	5880																																																																														
M10	7840	7840	7840	7840																																																																														
M12	7840	7840	7840	7840																																																																														
M16	-	7840	7840	7840																																																																														
M20	-	-	7840	7840																																																																														
M24	-	-	-	7840																																																																														
Length of bolt embedded, L (mm)	100-d	130-d	160-d	180-d																																																																														

### (2) Allowable pull-out load of embedded L- and LA-type bolts

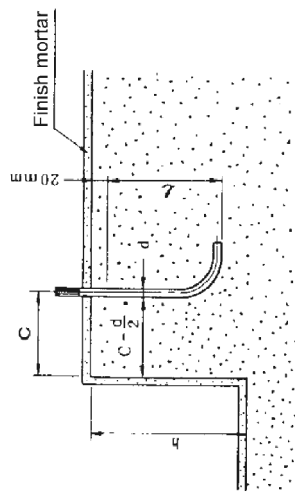
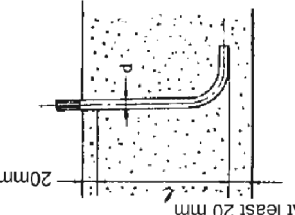
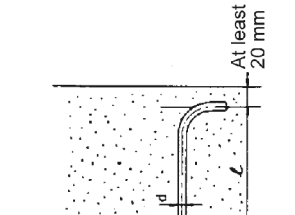
Installation location: a) Solid foundation 	b) Upper surface of normal floor slab 	c) Bottom surface of normal ceiling slab, concrete wall surface 																																																																														
<p>Short-term allowable pull-out load of a bolt is obtained with the following formulae. However, if the shear stress on the bolt exceeds 44.1 N/mm<sup>2</sup> (for SS400), bolt strength and assurance that allowable tensile stress is not exceeded must be verified.</p> $T_a = \pi \cdot d \cdot f_c \dots (a)$ <p>Where,</p> <p><math>T_a</math> = Anchor bolt allowable short-term pull-out load (N)  <math>d</math> = Anchor bolt nominal diameter (mm)  <math>f_c</math> = Embedded length of anchor bolt (mm)                      (the length from 20mm below the surface of the concrete foundation.)</p> <p><math>f_c</math> = short-term allowable bond stress in reinforced concrete</p> $f_c = \frac{9}{100} F_c$ <p>(from "Standard for RC structures design," published by the Architectural Institute of Japan)</p> <p><math>F_c</math> = Concrete design characteristic strength (N/mm<sup>2</sup>)                      (Normally, 17.6 N/mm<sup>2</sup> is used.)</p> <p>For anchor bolts positioned in the corner or near the edge of the foundation, the short-term allowable pull-out load shall be taken to be the minimum of the values from formulae (b) below, and (a).</p> $T_a = 6 \pi \cdot C^2 \cdot p \dots (b)$ <p>Where C = the distance from the edge of the foundation to the center of the bolt (mm)</p> <p>However, <math>C \geq 4d</math>, and <math>C - \frac{d}{2} \geq 50</math> mm</p> <p><math>p</math> = Correction factor for concrete design strength is</p> $P = \frac{1}{6} \text{Min} \left( \frac{F_c}{30}, 0.49 + \frac{F_c}{100} \right)$ <p>Notes</p> <ol style="list-style-type: none"> <li>1. L should be <math>\geq 6d</math> (where d = nominal anchor bolt diameter).</li> <li>2. If type 1 or 2 lightweight concrete is used, allow 10% margin.</li> </ol>	<p>Short-term pull-out load (N)</p> <table border="1" data-bbox="582 862 837 1467"> <thead> <tr> <th rowspan="2">Bolt diameter d (nominal)</th> <th colspan="3">Concrete thickness (mm)</th> </tr> <tr> <th>120</th> <th>150</th> <th>180</th> </tr> </thead> <tbody> <tr> <td>M 8</td> <td>3136</td> <td>4312</td> <td>5586</td> </tr> <tr> <td>M10</td> <td>3920</td> <td>5390</td> <td>6958</td> </tr> <tr> <td>M12</td> <td>4704</td> <td>6566</td> <td>8330</td> </tr> <tr> <td>M16</td> <td>-</td> <td>8722</td> <td>11172</td> </tr> <tr> <td>M20</td> <td>-</td> <td>-</td> <td>11760</td> </tr> <tr> <td>M24</td> <td>-</td> <td>-</td> <td>11760</td> </tr> <tr> <td>Effective embedded length (L) (mm)</td> <td>80</td> <td>110</td> <td>140</td> </tr> <tr> <td></td> <td></td> <td></td> <td>160</td> </tr> </tbody> </table> <p>Notes</p> <ol style="list-style-type: none"> <li>1. These are short-term allowable pull-out loads for bolts embedded as shown in the diagram above.</li> <li>2. The concrete design characteristic strength is taken to be <math>F_c = 17.6</math> N/mm<sup>2</sup>.</li> <li>3. When the dimensions differ from the above diagram, or if the concrete design characteristic strength differs, then the pull-out load can be calculated according with the formulae for bolts in a strong foundation, at the left. In any case, the allowable pull-out load on one bolt must not exceed 11,760 N.</li> <li>4. It is desirable that <math>L \geq 6d</math>. The conditions indicated by "." in the above table should be avoided.</li> <li>5. If type 1 or 2 lightweight concrete is used, allow 10% margin.</li> </ol>	Bolt diameter d (nominal)	Concrete thickness (mm)			120	150	180	M 8	3136	4312	5586	M10	3920	5390	6958	M12	4704	6566	8330	M16	-	8722	11172	M20	-	-	11760	M24	-	-	11760	Effective embedded length (L) (mm)	80	110	140				160	<p>Long-term allowable pull-out load (N)</p> <table border="1" data-bbox="582 212 837 817"> <thead> <tr> <th rowspan="2">Bolt diameter d (nominal)</th> <th colspan="3">Concrete thickness (mm)</th> </tr> <tr> <th>120</th> <th>150</th> <th>180</th> </tr> </thead> <tbody> <tr> <td>M 8</td> <td>2058</td> <td>2842</td> <td>3724</td> </tr> <tr> <td>M10</td> <td>2548</td> <td>3528</td> <td>4606</td> </tr> <tr> <td>M12</td> <td>3136</td> <td>4312</td> <td>5488</td> </tr> <tr> <td>M16</td> <td>-</td> <td>5782</td> <td>7448</td> </tr> <tr> <td>M20</td> <td>-</td> <td>-</td> <td>7840</td> </tr> <tr> <td>M24</td> <td>-</td> <td>-</td> <td>7840</td> </tr> <tr> <td>Effective embedded length (L) (mm)</td> <td>80</td> <td>110</td> <td>140</td> </tr> <tr> <td></td> <td></td> <td></td> <td>160</td> </tr> </tbody> </table> <p>Notes</p> <ol style="list-style-type: none"> <li>1. These are short-term allowable pull-out loads for bolts embedded as shown in the diagram above.</li> <li>2. The concrete design characteristic strength is taken to be <math>F_c = 17.6</math> N/mm<sup>2</sup>.</li> <li>3. When the dimensions differ from the above diagram, or if the concrete design characteristic strength differs, then the pull-out load can be calculated according with the formulae for bolts in a strong foundation, at the left, and divide the result by 1.5 to obtain the allowable pull-out load. In any case, the allowable pull-out load on one bolt must not exceed 7,840 N.</li> <li>4. It is desirable that <math>L \geq 6d</math>. The conditions indicated by "." in the above table should be avoided.</li> <li>5. It is necessary to investigate item b), the short-term pull-out load of normal supports with regard to earthquakes when the supports are installed in the bottom of ceiling slabs and on concrete walls designed to support heavy objects.</li> <li>6. If type 1 or 2 lightweight concrete is used, allow 10% margin.</li> </ol>	Bolt diameter d (nominal)	Concrete thickness (mm)			120	150	180	M 8	2058	2842	3724	M10	2548	3528	4606	M12	3136	4312	5488	M16	-	5782	7448	M20	-	-	7840	M24	-	-	7840	Effective embedded length (L) (mm)	80	110	140				160
Bolt diameter d (nominal)	Concrete thickness (mm)																																																																															
	120	150	180																																																																													
M 8	3136	4312	5586																																																																													
M10	3920	5390	6958																																																																													
M12	4704	6566	8330																																																																													
M16	-	8722	11172																																																																													
M20	-	-	11760																																																																													
M24	-	-	11760																																																																													
Effective embedded length (L) (mm)	80	110	140																																																																													
			160																																																																													
Bolt diameter d (nominal)	Concrete thickness (mm)																																																																															
	120	150	180																																																																													
M 8	2058	2842	3724																																																																													
M10	2548	3528	4606																																																																													
M12	3136	4312	5488																																																																													
M16	-	5782	7448																																																																													
M20	-	-	7840																																																																													
M24	-	-	7840																																																																													
Effective embedded length (L) (mm)	80	110	140																																																																													
			160																																																																													

### (3) Allowable pull-out load of embedded bolts with heads

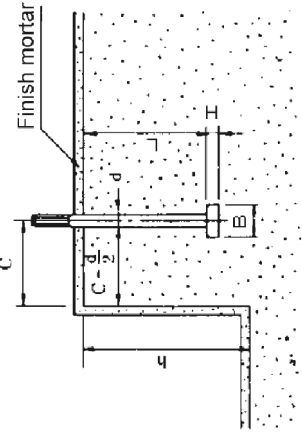
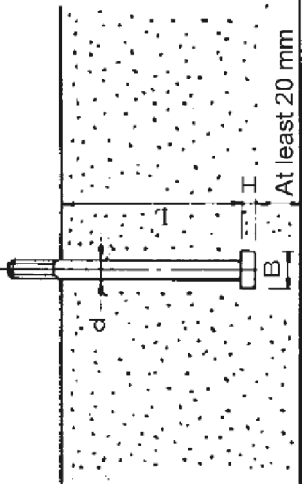
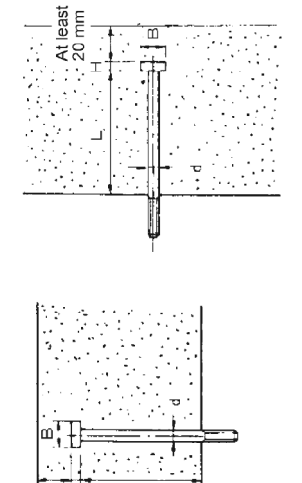
Installation location: a) Solid foundation 	b) Upper surface of normal floor slab 	c) Bottom surface of normal ceiling slab, concrete wall surface 																																																																																																										
<p>Short-term allowable pull-out load of a bolt is obtained with the following formulae. However, if the shear stress on the bolt exceeds 44.1 N/mm<sup>2</sup> (for SS400), bolt strength and assurance that allowable tensile stress is not exceeded must be verified.</p> $T_a = 6\pi \cdot L(L+B) \cdot p \quad \dots(a)$ <p>Where,</p> <p>T<sub>a</sub> = Anchor bolt allowable short-term pull-out load (N)                      d = Anchor bolt nominal diameter (mm)                      B = Minimum bolt head width (mm), (distance across flat sides of JIS standard hex bolt head)                      p = Correction factor for concrete design strength is</p> $p = \frac{1}{6} \min \left( \frac{F_c}{30}, \frac{0.49 + \frac{F_c}{100}}{100} \right)$ <p>F<sub>c</sub> = Concrete design characteristic strength (N/mm<sup>2</sup>)                      (Normally, 17.6 N/mm<sup>2</sup> is used.)</p> <p>For bolts near a corner or edge of a foundation, if the distance from the center of the bolt to the edge is C ≤ L + B, the allowable short-term pull-out load of the bolt is given by either formula (b) or (c) below.</p> <p>1) For L ≤ C + h,  <math display="block">T_a = 6\pi \cdot C^2 \cdot p \quad \dots(b)</math></p> <p>2) For L &gt; C + h,  <math display="block">T_a = 6\pi \cdot C^2 \cdot p \quad \dots(c)</math></p> <p>Where C = the distance from the edge of the foundation to the center of the bolt (mm)                      However, L + B ≥ C, and C - <math>\frac{d}{2}</math> ≥ 50 mm                      h = Foundation pad height (mm)</p> <p>Notes</p> <ol style="list-style-type: none"> <li>L should be ≥ 6d (where d = nominal anchor bolt diameter).</li> <li>Thickness H in the above diagram should be no less than that of a JIS standard hex bolt head.</li> <li>If type 1 or 2 lightweight concrete is used, allow 10% margin.</li> </ol>	<p>Short-term pull-out load (N)</p> <table border="1" data-bbox="582 851 861 1467"> <thead> <tr> <th rowspan="2">Bolt diameter d (nominal)</th> <th colspan="3">Concrete thickness (mm)</th> <th colspan="2">Bolt size</th> </tr> <tr> <th>120</th> <th>150</th> <th>180</th> <th>H (mm)</th> <th>B (mm)</th> </tr> </thead> <tbody> <tr> <td>M 8</td> <td>8820</td> <td>8820</td> <td>8820</td> <td>200</td> <td>55</td> </tr> <tr> <td>M10</td> <td>11760</td> <td>11760</td> <td>11760</td> <td>200</td> <td>7</td> </tr> <tr> <td>M12</td> <td>11760</td> <td>11760</td> <td>11760</td> <td>11760</td> <td>8</td> </tr> <tr> <td>M16</td> <td>-</td> <td>11760</td> <td>11760</td> <td>11760</td> <td>10</td> </tr> <tr> <td>M20</td> <td>-</td> <td>-</td> <td>11760</td> <td>11760</td> <td>13</td> </tr> <tr> <td>M24</td> <td>-</td> <td>-</td> <td>-</td> <td>11760</td> <td>15</td> </tr> <tr> <td>Length of bolt embedded, L (mm)</td> <td>100-H</td> <td>130-H</td> <td>160-H</td> <td>180-H</td> <td></td> </tr> </tbody> </table> <p>Notes</p> <ol style="list-style-type: none"> <li>The table shows the short-term pull-out load for bolts embedded in concrete of various thicknesses as shown in the above diagram.</li> <li>The concrete design characteristic strength is taken to be F<sub>c</sub> = 17.6 N/mm<sup>2</sup>.</li> <li>When the dimensions differ from the above diagram, or if the concrete design characteristic strength differs, then the pull-out load can be calculated according with the formulae for bolts in a strong foundation, at the left. In any case, the allowable pull-out load on one bolt must not exceed 11,760 N.</li> <li>It is desirable that L ≥ 6d. The conditions indicated by “-” in the above table should be avoided.</li> <li>Dimensions B and H in the above diagram are the distance across the flat sides of the head and the thickness of the head, respectively, for JIS standard hex bolt.</li> <li>If type 1 or 2 lightweight concrete is used, allow 10% margin.</li> </ol>	Bolt diameter d (nominal)	Concrete thickness (mm)			Bolt size		120	150	180	H (mm)	B (mm)	M 8	8820	8820	8820	200	55	M10	11760	11760	11760	200	7	M12	11760	11760	11760	11760	8	M16	-	11760	11760	11760	10	M20	-	-	11760	11760	13	M24	-	-	-	11760	15	Length of bolt embedded, L (mm)	100-H	130-H	160-H	180-H		<p>Long-term allowable pull-out load (N)</p> <table border="1" data-bbox="582 212 861 828"> <thead> <tr> <th rowspan="2">Bolt diameter d (nominal)</th> <th colspan="3">Concrete thickness (mm)</th> <th colspan="2">Bolt size</th> </tr> <tr> <th>120</th> <th>150</th> <th>180</th> <th>H (mm)</th> <th>B (mm)</th> </tr> </thead> <tbody> <tr> <td>M 8</td> <td>5880</td> <td>5880</td> <td>5880</td> <td>200</td> <td>55</td> </tr> <tr> <td>M10</td> <td>7840</td> <td>7840</td> <td>7840</td> <td>200</td> <td>7</td> </tr> <tr> <td>M12</td> <td>7840</td> <td>7840</td> <td>7840</td> <td>7840</td> <td>8</td> </tr> <tr> <td>M16</td> <td>-</td> <td>7840</td> <td>7840</td> <td>7840</td> <td>10</td> </tr> <tr> <td>M20</td> <td>-</td> <td>-</td> <td>7840</td> <td>7840</td> <td>13</td> </tr> <tr> <td>M24</td> <td>-</td> <td>-</td> <td>-</td> <td>7840</td> <td>15</td> </tr> <tr> <td>Length of bolt embedded, L (mm)</td> <td>100-H</td> <td>130-H</td> <td>160-H</td> <td>180-H</td> <td></td> </tr> </tbody> </table> <p>Notes</p> <ol style="list-style-type: none"> <li>These are short-term allowable pull-out loads for bolts embedded as shown in the diagram above.</li> <li>The concrete design characteristic strength is taken to be F<sub>c</sub> = 17.6 N/mm<sup>2</sup>.</li> <li>When the dimensions differ from the above diagram, or if the concrete design characteristic strength differs, then the pull-out load can be calculated according with the formulae for bolts in a strong foundation, at the left, and divide the result by 1.5 to obtain the allowable pull-out load. In any case, the allowable pull-out load on one bolt must not exceed 7,840 N.</li> <li>It is desirable that L ≥ 6d. The conditions indicated by “-” in the above table should be avoided.</li> <li>It is necessary to investigate the short-term pull-out load of normal supports with regard to earthquakes when the supports are installed in the bottom of ceiling slabs and on concrete walls designed to support heavy objects. For this short-term pull-out load, see Item b, “Short-term pull-out loads.”</li> <li>If type 1 or 2 lightweight concrete is used, allow 10% margin.</li> </ol>	Bolt diameter d (nominal)	Concrete thickness (mm)			Bolt size		120	150	180	H (mm)	B (mm)	M 8	5880	5880	5880	200	55	M10	7840	7840	7840	200	7	M12	7840	7840	7840	7840	8	M16	-	7840	7840	7840	10	M20	-	-	7840	7840	13	M24	-	-	-	7840	15	Length of bolt embedded, L (mm)	100-H	130-H	160-H	180-H	
Bolt diameter d (nominal)	Concrete thickness (mm)			Bolt size																																																																																																								
	120	150	180	H (mm)	B (mm)																																																																																																							
M 8	8820	8820	8820	200	55																																																																																																							
M10	11760	11760	11760	200	7																																																																																																							
M12	11760	11760	11760	11760	8																																																																																																							
M16	-	11760	11760	11760	10																																																																																																							
M20	-	-	11760	11760	13																																																																																																							
M24	-	-	-	11760	15																																																																																																							
Length of bolt embedded, L (mm)	100-H	130-H	160-H	180-H																																																																																																								
Bolt diameter d (nominal)	Concrete thickness (mm)			Bolt size																																																																																																								
	120	150	180	H (mm)	B (mm)																																																																																																							
M 8	5880	5880	5880	200	55																																																																																																							
M10	7840	7840	7840	200	7																																																																																																							
M12	7840	7840	7840	7840	8																																																																																																							
M16	-	7840	7840	7840	10																																																																																																							
M20	-	-	7840	7840	13																																																																																																							
M24	-	-	-	7840	15																																																																																																							
Length of bolt embedded, L (mm)	100-H	130-H	160-H	180-H																																																																																																								

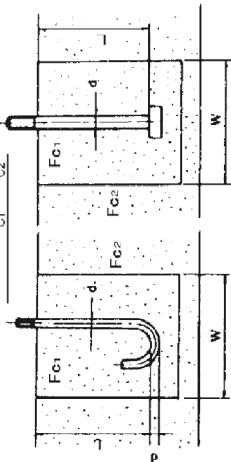
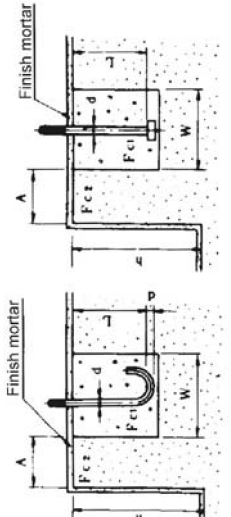

(4) Allowable pull-out load of J- and JA-type bolts and headed bolts in boxouts (Boxout techniques are not applicable to the underside of ceiling slabs or concrete wall surfaces)

Installation location: a) Solid foundation	b) Upper surface of normal floor slab When $F_{C1} > F_{C2}$	c) Bottom surface of normal ceiling slab, concrete wall surface																																																																														
<p>Short-term allowable pull-out load of a bolt is obtained with the following formulae. However, if the shear stress on the bolt exceeds 44.1 N/mm<sup>2</sup> (for SS400), bolt strength and assurance that allowable tensile stress is not exceeded must be verified.</p> <p>For <math>F_{C1} \leq F_{C2}</math></p> $T_a = \frac{F_{C1}}{80} \cdot \pi \cdot L \cdot W \quad \dots(a)$ <p>For <math>F_{C1} &gt; F_{C2}</math> (e.g., in non-shrink mortar)</p> $T_a = \frac{F_{C2}}{80} \cdot \pi \cdot L \cdot W \quad \dots(a)$ <p>Where,</p> <p>Ta = Anchor bolt allowable short-term pull-out load (N)  L = Embedded length of anchor bolt (mm)  F<sub>C1</sub> = Characteristic design strength of backfill mortar (N/mm<sup>2</sup>)  F<sub>C2</sub> = Characteristic design strength of surrounding concrete (N/mm<sup>2</sup>)  Normally, F<sub>C1</sub> = 11.8 N/mm<sup>2</sup> and F<sub>C2</sub> = 17.6 N/mm<sup>2</sup> are used.  W = Width of anchor bolt boxout (between 100mm and 150mm).  Use the smallest dimension for rectangular shapes. However, the internal surfaces of the box insert must be sufficiently roughened.</p> <p>For anchor bolts positioned in the corner or near the edge of the foundation, the short-term allowable pull-out load shall be taken to be either of the values from formulae (c) and (d) or (e) and (f) below.</p> <ol style="list-style-type: none"> <li>For <math>F_{C1} \leq F_{C2}</math> and <math>L \leq h</math>, <math display="block">T_a = \frac{F_{C1}}{80} \cdot \pi \cdot L \cdot W \cdot \frac{A}{10} \quad \dots(c)</math> </li> <li>For <math>F_{C1} \leq F_{C2}</math> and <math>L &gt; h</math>, <math display="block">T_a = \frac{F_{C1}}{80} \cdot \pi \cdot L \cdot W \cdot \left( L - h + \frac{A}{10} \right) \quad \dots(d)</math> </li> <li>For <math>F_{C1} &gt; F_{C2}</math> and <math>L \leq h</math>, <math display="block">T_a = \frac{F_{C2}}{80} \cdot \pi \cdot L \cdot W \cdot \frac{A}{10} \quad \dots(e)</math> </li> <li>For <math>F_{C1} &gt; F_{C2}</math> and <math>L &gt; h</math>, <math display="block">T_a = \frac{F_{C2}}{80} \cdot \pi \cdot L \cdot W \cdot \left( L - h + \frac{A}{10} \right) \quad \dots(f)</math> </li> </ol> <p>Where,  h = Foundation pad height (mm)  A = Distance from edge of anchor boxout to edge of foundation pad (mm)  Notes  1. L should be <math>\geq 6d</math> (where d = nominal anchor bolt diameter).  2. If type 1 or 2 lightweight concrete is used, allow 10% margin.</p>	 <p>Short-term pull-out load (N)</p> <table border="1" data-bbox="558 750 805 1254"> <thead> <tr> <th rowspan="2">Bolt diameter d (nominal)</th> <th colspan="3">Concrete thickness (mm)</th> </tr> <tr> <th>120</th> <th>180</th> <th>200</th> </tr> </thead> <tbody> <tr> <td>M 8</td> <td>3136</td> <td>4508</td> <td>5488</td> </tr> <tr> <td>M10</td> <td>3136</td> <td>4508</td> <td>6272</td> </tr> <tr> <td>M12</td> <td>-</td> <td>4508</td> <td>5488</td> </tr> <tr> <td>M16</td> <td>-</td> <td>5488</td> <td>6272</td> </tr> <tr> <td>M20</td> <td>-</td> <td>-</td> <td>5488</td> </tr> <tr> <td>M24</td> <td>-</td> <td>-</td> <td>-</td> </tr> <tr> <td>Length of bolt embedded, L (mm)</td> <td>80-d</td> <td>110-d</td> <td>140-d</td> </tr> <tr> <td></td> <td></td> <td></td> <td>160-d</td> </tr> </tbody> </table> <p>Notes  1. These are short-term allowable pull-out loads for bolts embedded as shown in the diagram above, with <math>F_{C1} = 11.8 \text{ N/mm}^2</math>, <math>F_{C2} = 17.6 \text{ N/mm}^2</math>, and <math>W = 100 \text{ mm}</math>.  2. When the dimensions differ from the above diagram, or if the concrete design characteristic strength differs, then the pull-out load can be calculated according with the formulae for bolts in a strong foundation, at the left.  In any case, the allowable pull-out load of one bolt must not exceed 11,760 N.  3. It is desirable that <math>L \geq 6d</math>. The conditions indicated by “.” in the above table should be avoided.  4. The above table can be used for boxout widths up to 150 mm.  5. If type 1 or 2 lightweight concrete is used, allow 10% margin.</p>	Bolt diameter d (nominal)	Concrete thickness (mm)			120	180	200	M 8	3136	4508	5488	M10	3136	4508	6272	M12	-	4508	5488	M16	-	5488	6272	M20	-	-	5488	M24	-	-	-	Length of bolt embedded, L (mm)	80-d	110-d	140-d				160-d	 <p>Long-term allowable pull-out load (N)</p> <table border="1" data-bbox="558 212 805 716"> <thead> <tr> <th rowspan="2">Bolt diameter d (nominal)</th> <th colspan="3">Concrete thickness (mm)</th> </tr> <tr> <th>120</th> <th>150</th> <th>180</th> </tr> </thead> <tbody> <tr> <td>M 8</td> <td>4802</td> <td>6762</td> <td>8232</td> </tr> <tr> <td>M10</td> <td>4802</td> <td>6762</td> <td>8232</td> </tr> <tr> <td>M12</td> <td>-</td> <td>6762</td> <td>8232</td> </tr> <tr> <td>M16</td> <td>-</td> <td>-</td> <td>8232</td> </tr> <tr> <td>M20</td> <td>-</td> <td>-</td> <td>8232</td> </tr> <tr> <td>M24</td> <td>-</td> <td>-</td> <td>-</td> </tr> <tr> <td>Length of bolt embedded, L (mm)</td> <td>80-d</td> <td>110-d</td> <td>140-d</td> </tr> <tr> <td></td> <td></td> <td></td> <td>160-d</td> </tr> </tbody> </table> <p>Notes  1. These are short-term allowable pull-out loads for bolts embedded as shown in the diagram above, with <math>F_{C1} = 20.6 \text{ N/mm}^2</math>, <math>F_{C2} = 17.6 \text{ N/mm}^2</math>, and <math>W = 100 \text{ mm}</math>.  2. When the dimensions differ from the above diagram, or if the concrete design characteristic strength differs, then the pull-out load can be calculated according with the formulae for bolts in a strong foundation, at the left.  In any case, the allowable pull-out load on one bolt must not exceed 11,760 N.  3. It is desirable that <math>L \geq 6d</math>. The conditions indicated by “.” in the above table should be avoided.  4. The above table can be used for boxout widths up to 150 mm.  5. If type 1 or 2 lightweight concrete is used, allow 10% margin.</p>	Bolt diameter d (nominal)	Concrete thickness (mm)			120	150	180	M 8	4802	6762	8232	M10	4802	6762	8232	M12	-	6762	8232	M16	-	-	8232	M20	-	-	8232	M24	-	-	-	Length of bolt embedded, L (mm)	80-d	110-d	140-d				160-d
Bolt diameter d (nominal)	Concrete thickness (mm)																																																																															
	120	180	200																																																																													
M 8	3136	4508	5488																																																																													
M10	3136	4508	6272																																																																													
M12	-	4508	5488																																																																													
M16	-	5488	6272																																																																													
M20	-	-	5488																																																																													
M24	-	-	-																																																																													
Length of bolt embedded, L (mm)	80-d	110-d	140-d																																																																													
			160-d																																																																													
Bolt diameter d (nominal)	Concrete thickness (mm)																																																																															
	120	150	180																																																																													
M 8	4802	6762	8232																																																																													
M10	4802	6762	8232																																																																													
M12	-	6762	8232																																																																													
M16	-	-	8232																																																																													
M20	-	-	8232																																																																													
M24	-	-	-																																																																													
Length of bolt embedded, L (mm)	80-d	110-d	140-d																																																																													
			160-d																																																																													

(5) Allowable pull-out load of embedded L- and LA-type bolts in boxouts (Boxout techniques are not applicable to the underside of ceiling slabs or concrete wall surfaces)

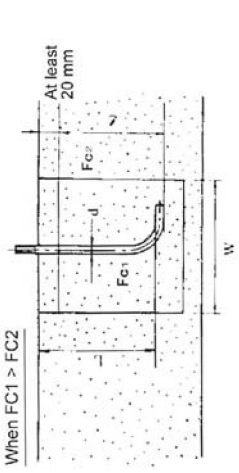
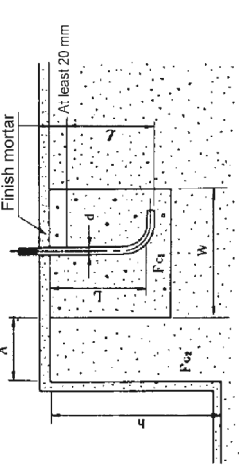
Installation location: a) Solid foundation	b) Upper surface of normal floor slab	c) Bottom surface of normal ceiling slab, concrete wall surface																																																																																						
<p>The short-term allowable pull-out load of a bolt is the smaller of the value obtained from formula (a) in item (2) or the following formulae. However, if the pull-out load on the bolt exceeds 14.7 N/mm<sup>2</sup> (for SS400), bolt strength and assurance that allowable tensile stress is not exceeded must be verified.</p> <p>For <math>F_{C1} \leq F_{C2}</math></p> $T_a = \frac{F_{C1}}{80} \cdot \pi \cdot L \cdot W \quad \dots (a)$ <p>For <math>F_{C1} &gt; F_{C2}</math> (e.g., in non-shrink mortar)</p> $T_a = \frac{F_{C2}}{80} \cdot \pi \cdot L \cdot W \quad \dots (b)$ <p>Where,</p> <p>Ta = Anchor bolt allowable short-term pull-out load (N)</p> <p>L = Embedded length of anchor bolt (mm)</p> <p>F<sub>C1</sub> = Characteristic design strength of backfill mortar (N/mm<sup>2</sup>)</p> <p>F<sub>C2</sub> = Characteristic design strength of surrounding concrete (N/mm<sup>2</sup>)</p> <p>Normally, F<sub>C1</sub> = 11.8 N/mm<sup>2</sup> and F<sub>C2</sub> = 17.6 N/mm<sup>2</sup> are used.</p> <p>W = Width of anchor bolt boxout (between 100mm and 150mm).</p> <p>Use the smallest dimension for rectangular shapes. However, the internal surfaces of the box insert must be sufficiently roughened.</p> <p>For anchor bolts positioned in the corner or near the edge of the foundation, the short-term allowable pull-out load shall be taken to be either of the values from formulae (a) in item (2), and (c) and (d) or (e) and (f) below.</p> <ol style="list-style-type: none"> <li>For <math>F_{C1} \leq F_{C2}</math> and <math>L \leq h</math>,             <math display="block">T_a = \frac{F_{C1}}{80} \cdot \pi \cdot L \cdot W \cdot \frac{A}{10} \quad \dots (c)</math> </li> <li>For <math>F_{C1} \leq F_{C2}</math> and <math>L &gt; h</math>,             <math display="block">T_a = \frac{F_{C1}}{80} \cdot \pi \cdot L \cdot W \cdot \left( L - h + \frac{A}{10} \right) \quad \dots (d)</math> </li> <li>For <math>F_{C1} &gt; F_{C2}</math> and <math>L \leq h</math>,             <math display="block">T_a = \frac{F_{C2}}{80} \cdot \pi \cdot L \cdot W \cdot \frac{A}{10} \quad \dots (e)</math> </li> <li>For <math>F_{C1} &gt; F_{C2}</math> and <math>L &gt; h</math>,             <math display="block">T_a = \frac{F_{C2}}{80} \cdot \pi \cdot L \cdot W \cdot \left( L - h + \frac{A}{10} \right) \quad \dots (f)</math> </li> </ol> <p>Where,</p> <p>h = Foundation pad height (mm)</p> <p>A : A = Distance from edge of anchor boxout to edge of foundation pad (mm), and A is greater than 100 mm, but not more than 150 mm</p> <p>Notes</p> <ol style="list-style-type: none"> <li>L should be <math>\geq 6d</math> (where d = nominal anchor bolt diameter).</li> <li>If type 1 or 2 lightweight concrete is used, allow 10% margin.</li> </ol>	 <p>When <math>F_{C1} &gt; F_{C2}</math></p> <table border="1" data-bbox="550 750 853 1220"> <thead> <tr> <th rowspan="2">Bolt diameter d (nominal)</th> <th colspan="3">Concrete thickness (mm)</th> </tr> <tr> <th>120</th> <th>150</th> <th>180</th> </tr> </thead> <tbody> <tr> <td>M 8</td> <td>1568</td> <td>2352</td> <td>3136</td> </tr> <tr> <td>M10</td> <td>1960</td> <td>2940</td> <td>3920</td> </tr> <tr> <td>M12</td> <td>-</td> <td>3528</td> <td>4704</td> </tr> <tr> <td>M16</td> <td>-</td> <td>-</td> <td>5488</td> </tr> <tr> <td>M20</td> <td>-</td> <td>-</td> <td>6272</td> </tr> <tr> <td>M24</td> <td>-</td> <td>-</td> <td>6272</td> </tr> <tr> <td>Length of bolt embedded, L (mm)</td> <td colspan="3">80-d</td> </tr> <tr> <td>Effective length of bolt embedded, (L) (mm)</td> <td>60</td> <td>90</td> <td>120</td> </tr> <tr> <td></td> <td></td> <td></td> <td>140</td> </tr> </tbody> </table> <p>Short-term pull-out load (N)</p> <p>Notes</p> <ol style="list-style-type: none"> <li>These are short-term allowable pull-out loads for bolts embedded as shown in the diagram above, with <math>F_{C1} = 11.8 \text{ N/mm}^2</math>, <math>F_{C2} = 17.6 \text{ N/mm}^2</math>, and <math>W = 100 \text{ mm}</math>.</li> <li>When the dimensions differ from the above diagram, or if the concrete design characteristic strength differs, then the pull-out load can be calculated according with the formulae for bolts in a strong foundation, at the left.</li> <li>In any case, the allowable pull-out load on one bolt must not exceed 11,760 N.</li> <li>It is desirable that <math>L \geq 6d</math>. The conditions indicated by “.” in the above table should be avoided.</li> <li>The above table can be used for boxout widths up to 150 mm.</li> <li>If type 1 or 2 lightweight concrete is used, allow 10% margin.</li> </ol>	Bolt diameter d (nominal)	Concrete thickness (mm)			120	150	180	M 8	1568	2352	3136	M10	1960	2940	3920	M12	-	3528	4704	M16	-	-	5488	M20	-	-	6272	M24	-	-	6272	Length of bolt embedded, L (mm)	80-d			Effective length of bolt embedded, (L) (mm)	60	90	120				140	 <table border="1" data-bbox="550 224 853 694"> <thead> <tr> <th rowspan="2">Bolt diameter d (nominal)</th> <th colspan="3">Concrete thickness (mm)</th> </tr> <tr> <th>120</th> <th>150</th> <th>180</th> </tr> </thead> <tbody> <tr> <td>M 8</td> <td>2352</td> <td>3528</td> <td>4704</td> </tr> <tr> <td>M10</td> <td>2940</td> <td>4410</td> <td>5978</td> </tr> <tr> <td>M12</td> <td>-</td> <td>5292</td> <td>7154</td> </tr> <tr> <td>M16</td> <td>-</td> <td>-</td> <td>8232</td> </tr> <tr> <td>M20</td> <td>-</td> <td>-</td> <td>8232</td> </tr> <tr> <td>M24</td> <td>-</td> <td>-</td> <td>9408</td> </tr> <tr> <td>Length of bolt embedded, L (mm)</td> <td colspan="3">80-d</td> </tr> <tr> <td>Effective length of bolt embedded, (L) (mm)</td> <td>60</td> <td>90</td> <td>120</td> </tr> <tr> <td></td> <td></td> <td></td> <td>140</td> </tr> </tbody> </table> <p>Long-term allowable pull-out load (N)</p> <p>Notes</p> <ol style="list-style-type: none"> <li>These are short-term allowable pull-out loads for bolts embedded as shown in the diagram above, with <math>F_{C1} = 20.6 \text{ N/mm}^2</math>, <math>F_{C2} = 17.6 \text{ N/mm}^2</math>, and <math>W = 100 \text{ mm}</math>.</li> <li>When the dimensions differ from the above diagram, or if the concrete design characteristic strength differs, then the pull-out load can be calculated according with the formulae for bolts in a strong foundation, at the left.</li> <li>In any case, the allowable pull-out load on one bolt must not exceed 11,760 N.</li> <li>It is desirable that <math>L \geq 6d</math>. The conditions indicated by “.” in the above table should be avoided.</li> <li>The above table can be used for boxout widths up to 150 mm.</li> <li>If type 1 or 2 lightweight concrete is used, allow 10% margin.</li> </ol>	Bolt diameter d (nominal)	Concrete thickness (mm)			120	150	180	M 8	2352	3528	4704	M10	2940	4410	5978	M12	-	5292	7154	M16	-	-	8232	M20	-	-	8232	M24	-	-	9408	Length of bolt embedded, L (mm)	80-d			Effective length of bolt embedded, (L) (mm)	60	90	120				140
Bolt diameter d (nominal)	Concrete thickness (mm)																																																																																							
	120	150	180																																																																																					
M 8	1568	2352	3136																																																																																					
M10	1960	2940	3920																																																																																					
M12	-	3528	4704																																																																																					
M16	-	-	5488																																																																																					
M20	-	-	6272																																																																																					
M24	-	-	6272																																																																																					
Length of bolt embedded, L (mm)	80-d																																																																																							
Effective length of bolt embedded, (L) (mm)	60	90	120																																																																																					
			140																																																																																					
Bolt diameter d (nominal)	Concrete thickness (mm)																																																																																							
	120	150	180																																																																																					
M 8	2352	3528	4704																																																																																					
M10	2940	4410	5978																																																																																					
M12	-	5292	7154																																																																																					
M16	-	-	8232																																																																																					
M20	-	-	8232																																																																																					
M24	-	-	9408																																																																																					
Length of bolt embedded, L (mm)	80-d																																																																																							
Effective length of bolt embedded, (L) (mm)	60	90	120																																																																																					
			140																																																																																					

### (6) Allowable pull-out load of post-drilled resin anchors

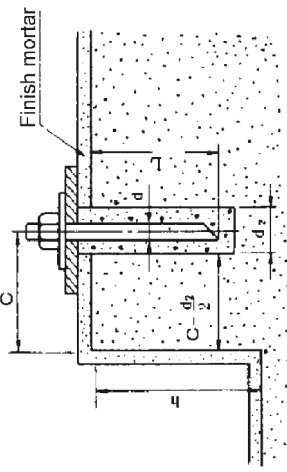
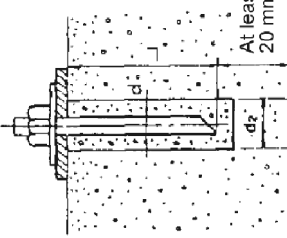
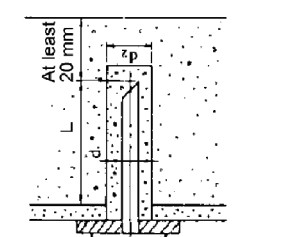
Installation location: a) Solid foundation 	b) Upper surface of normal floor slab 	c) Bottom surface of normal ceiling slab, concrete wall surface 																																																																														
<p>Short-term allowable pull-out load of a bolt is obtained with the following formulae. However, if the shear stress on the bolt exceeds 44.1 N/mm<sup>2</sup> (for SS400), bolt strength and assurance that allowable tensile stress is not exceeded must be verified.</p> $T_a = \frac{F_c}{8} \cdot \pi \cdot d_2 \cdot L \quad \dots(a)$ <p>Where,</p> <p>T<sub>a</sub> = Anchor bolt allowable short-term pull-out load (N)                      L = Embedded length of anchor bolt (mm)                      d<sub>2</sub> = Diameter of drilled hole in concrete (mm)                      F<sub>c</sub> = Concrete design characteristic strength (N/mm<sup>2</sup>)</p> <p>For foundation bolts positioned near a corner or edge of the foundation, the short-term allowable pull-out strength shall be taken to be the minimum of the values from formula (a) above, or formula (b) or (c) below.</p> <p>1) For L ≤ C + h,  <math>T_a = 6\pi \cdot C^2 \cdot p \quad \dots(b)</math></p> <p>2) For L &gt; C + h,  <math>T_a = 6\pi(L-h)^2 p \quad \dots(c)</math></p> <p>Where C = the distance from the edge of the foundation to the center of the bolt (mm)                      However, C ≥ 4d, and C - d/2 ≥ 50 mm</p> <p>p = Correction factor f or concrete design strength is</p> $P = \frac{1}{6} \text{Min} \left\{ \frac{F_c}{30}, 0.49 + \frac{F_c}{100} \right\}$ <p>Notes</p> <ol style="list-style-type: none"> <li>L should be ≥ 6d (where d = nominal anchor bolt diameter).</li> <li>If the concrete design characteristic strength F<sub>c</sub> exceeds 29.4 N/mm<sup>2</sup>, perform the calculation using 29.4 N/mm<sup>2</sup>.</li> <li>Diameter d<sub>2</sub> of the drilled hole in concrete should be that recommended by the resin anchor bolt manufacturer.</li> <li>If type 1 or 2 lightweight concrete is used, allow 10% margin.</li> </ol>	<p>Short-term pull-out load (N)</p> <table border="1"> <thead> <tr> <th rowspan="2">Bolt diameter d (nominal)</th> <th colspan="3">Concrete thickness (mm)</th> <th rowspan="2">Embedded length L (mm)</th> <th rowspan="2">Drilled hole dia. d<sub>2</sub> (mm)</th> </tr> <tr> <th>120</th> <th>150</th> <th>180</th> </tr> </thead> <tbody> <tr> <td>M10</td> <td>7448</td> <td>7448</td> <td>7448</td> <td>80</td> <td>13.5</td> </tr> <tr> <td>M12</td> <td>9016</td> <td>9016</td> <td>7448</td> <td>90</td> <td>14.5</td> </tr> <tr> <td>M16</td> <td>-</td> <td>11760</td> <td>9016</td> <td>110</td> <td>20</td> </tr> <tr> <td>M20</td> <td>-</td> <td>-</td> <td>11760</td> <td>120</td> <td>24</td> </tr> <tr> <td>Length limit of embedded bolt (mm)</td> <td>100</td> <td>130</td> <td>160</td> <td>180</td> <td></td> </tr> </tbody> </table> <p>Notes</p> <ol style="list-style-type: none"> <li>The table shows the short-term allowable pull-out load for resin anchor bolts embedded for the lengths shown in drilled holes with the indicated diameters.</li> <li>The concrete design characteristic strength is taken to be F<sub>c</sub> = 17.6 N/mm<sup>2</sup>.</li> <li>When the dimensions differ from the above diagram, or if the concrete design characteristic strength differs, then the pull-out load can be calculated according with the formulae for bolts in a strong foundation, at the left. In any case, the allowable pull-out load on one bolt must not exceed 11,760 N.</li> <li>It is desirable that L ≥ 6d. The conditions indicated by “.” in the above table should be avoided.</li> <li>If type 1 or 2 lightweight concrete is used, allow 10% margin.</li> </ol>	Bolt diameter d (nominal)	Concrete thickness (mm)			Embedded length L (mm)	Drilled hole dia. d <sub>2</sub> (mm)	120	150	180	M10	7448	7448	7448	80	13.5	M12	9016	9016	7448	90	14.5	M16	-	11760	9016	110	20	M20	-	-	11760	120	24	Length limit of embedded bolt (mm)	100	130	160	180		<p>Long-term allowable pull-out load (N)</p> <table border="1"> <thead> <tr> <th rowspan="2">Bolt diameter d (nominal)</th> <th colspan="3">Concrete thickness (mm)</th> <th rowspan="2">Embedded length L (mm)</th> <th rowspan="2">Drilled hole dia. d<sub>2</sub> (mm)</th> </tr> <tr> <th>120</th> <th>150</th> <th>180</th> </tr> </thead> <tbody> <tr> <td>M10</td> <td>4900</td> <td>4900</td> <td>4900</td> <td>80</td> <td>13.5</td> </tr> <tr> <td>M12</td> <td>5978</td> <td>5978</td> <td>5978</td> <td>90</td> <td>14.5</td> </tr> <tr> <td>M16</td> <td>-</td> <td>7840</td> <td>7840</td> <td>110</td> <td>20</td> </tr> <tr> <td>M20</td> <td>-</td> <td>-</td> <td>7840</td> <td>120</td> <td>24</td> </tr> <tr> <td>Length limit of embedded bolt (mm)</td> <td>100</td> <td>130</td> <td>160</td> <td>180</td> <td></td> </tr> </tbody> </table> <p>Notes</p> <ol style="list-style-type: none"> <li>The table shows the short-term allowable pull-out load for resin anchor bolts embedded for the lengths shown in drilled holes with the indicated diameters.</li> <li>The concrete design characteristic strength is taken to be F<sub>c</sub> = 17.6 N/mm<sup>2</sup>.</li> <li>When the dimensions differ from the above diagram, or if the concrete design characteristic strength differs, then the pull-out load can be calculated according with the formulae for bolts in a strong foundation, at the left, and divide the result by 1.5 to obtain the allowable pull-out load. In any case, the allowable pull-out load on one bolt must not exceed 7,840 N.</li> <li>It is desirable that L ≥ 6d. The conditions indicated by “.” in the above table should be avoided.</li> <li>It is necessary to investigate the short-term pull-out load of normal supports with regard to earthquakes when the supports are installed in the bottom of ceiling slabs and on concrete walls designed to support heavy objects. For this short-term pull-out load, see item b, “Short-term pull-out loads.”</li> <li>If type 1 or 2 lightweight concrete is used, allow 10% margin.</li> </ol>	Bolt diameter d (nominal)	Concrete thickness (mm)			Embedded length L (mm)	Drilled hole dia. d <sub>2</sub> (mm)	120	150	180	M10	4900	4900	4900	80	13.5	M12	5978	5978	5978	90	14.5	M16	-	7840	7840	110	20	M20	-	-	7840	120	24	Length limit of embedded bolt (mm)	100	130	160	180	
Bolt diameter d (nominal)	Concrete thickness (mm)			Embedded length L (mm)	Drilled hole dia. d <sub>2</sub> (mm)																																																																											
	120	150	180																																																																													
M10	7448	7448	7448	80	13.5																																																																											
M12	9016	9016	7448	90	14.5																																																																											
M16	-	11760	9016	110	20																																																																											
M20	-	-	11760	120	24																																																																											
Length limit of embedded bolt (mm)	100	130	160	180																																																																												
Bolt diameter d (nominal)	Concrete thickness (mm)			Embedded length L (mm)	Drilled hole dia. d <sub>2</sub> (mm)																																																																											
	120	150	180																																																																													
M10	4900	4900	4900	80	13.5																																																																											
M12	5978	5978	5978	90	14.5																																																																											
M16	-	7840	7840	110	20																																																																											
M20	-	-	7840	120	24																																																																											
Length limit of embedded bolt (mm)	100	130	160	180																																																																												

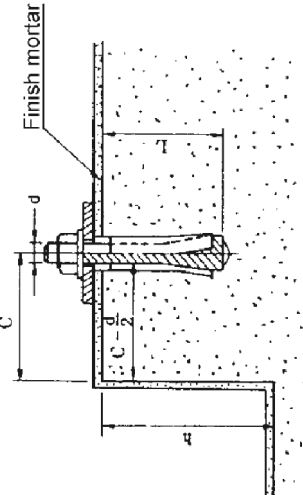
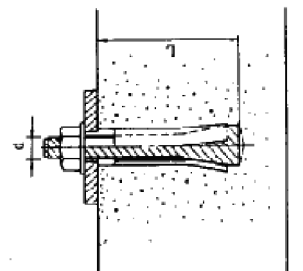
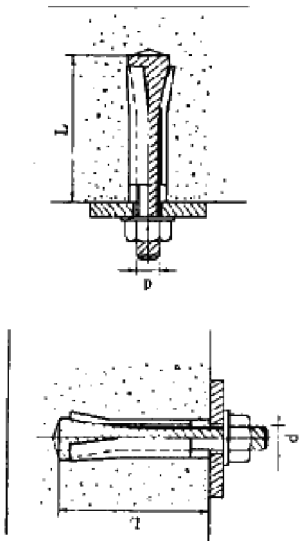

(7) Allowable pull-out load for post-installed screw-type mechanical anchor bolts

Installation location: a) Solid foundation	b) Upper surface of normal floor slab	c) Bottom surface of normal ceiling slab, concrete wall surface																																																																																						
 <p>Short-term allowable pull-out load of a bolt is obtained with the following formulae. However, if the shear stress on the bolt exceeds 44.1 N/mm<sup>2</sup> (for SS400), bolt strength and assurance that allowable tensile stress is not exceeded must be verified.</p> $T_a = 6\pi \cdot L^2 \cdot p \dots(a)$ <p>Where,</p> <p>T<sub>a</sub> = Anchor bolt allowable short-term pull-out load (N)</p> <p>L = Embedded length of anchor bolt (mm) (May be taken to be the depth of the drilled hole.)</p> <p>P = Correction factor for concrete design strength is</p> $P = \frac{1}{6} \text{Min} \left( \frac{F_c}{30}, 0.49 + \frac{F_c}{100} \right)$ <p>F<sub>c</sub> = Concrete design characteristic strength (N/mm<sup>2</sup>) (Normally, 17.6 N/mm<sup>2</sup> is used.)</p> <p>For bolts near a corner or edge of a foundation, if the distance from the center of the bolt to the edge is C ≤ L, the allowable short-term pull-out load of the bolt is given by formula (b) below.</p> $T_a = 6\pi \cdot C^2 \cdot p \dots(b)$ <p>Where C = the distance from the edge of the foundation to the center of the bolt (mm)</p> <p>However, C ≥ 4d, and C - <math>\frac{d}{2}</math> ≥ 50 mm</p> <p>Note 1. If type 1 or 2 lightweight concrete is used, allow 10% margin.</p>	 <table border="1" data-bbox="582 851 853 1467"> <thead> <tr> <th rowspan="2">Bolt diameter d (nominal)</th> <th colspan="3">Concrete thickness (mm)</th> <th rowspan="2">Embedded length L (mm)</th> </tr> <tr> <th>120</th> <th>150</th> <th>180</th> </tr> </thead> <tbody> <tr> <td>M8</td> <td>2940</td> <td>2940</td> <td>2940</td> <td>40</td> </tr> <tr> <td>M10</td> <td>3724</td> <td>3724</td> <td>3724</td> <td>45</td> </tr> <tr> <td>M12</td> <td>6566</td> <td>6566</td> <td>6566</td> <td>60</td> </tr> <tr> <td>M16</td> <td>9016</td> <td>9016</td> <td>9016</td> <td>70</td> </tr> <tr> <td>M20</td> <td>11760</td> <td>11760</td> <td>11760</td> <td>90</td> </tr> <tr> <td>M24</td> <td>11760</td> <td>11760</td> <td>11760</td> <td>100</td> </tr> <tr> <td>Length limit of embedded bolt (mm)</td> <td>100 or less</td> <td>120 or less</td> <td>160 or less</td> <td>180 or less</td> </tr> </tbody> </table> <p>Short-term pull-out load (N)</p> <p>Notes</p> <ol style="list-style-type: none"> <li>The above table shows the short-term allowable pull-out load for anchor bolts embedded for the lengths shown.</li> <li>The concrete design characteristic strength is taken to be F<sub>c</sub> = 17.6 N/mm<sup>2</sup>.</li> <li>When the dimensions differ from the above diagram, or if the concrete design characteristic strength differs, then the pull-out load can be calculated according with the formulae for bolts in a strong foundation, at the left. In any case, the allowable pull-out load on one bolt must not exceed 11,760 N.</li> <li>Do not use bolts with an embedded length less than that shown in the rightmost column.</li> <li>If type 1 or 2 lightweight concrete is used, allow 10% margin.</li> </ol>	Bolt diameter d (nominal)	Concrete thickness (mm)			Embedded length L (mm)	120	150	180	M8	2940	2940	2940	40	M10	3724	3724	3724	45	M12	6566	6566	6566	60	M16	9016	9016	9016	70	M20	11760	11760	11760	90	M24	11760	11760	11760	100	Length limit of embedded bolt (mm)	100 or less	120 or less	160 or less	180 or less	 <table border="1" data-bbox="582 212 853 828"> <thead> <tr> <th rowspan="2">Bolt diameter d (nominal)</th> <th colspan="3">Concrete thickness (mm)</th> <th rowspan="2">Embedded length L (mm)</th> </tr> <tr> <th>120</th> <th>150</th> <th>180</th> </tr> </thead> <tbody> <tr> <td>M8</td> <td>1960</td> <td>1960</td> <td>1960</td> <td>40</td> </tr> <tr> <td>M10</td> <td>2450</td> <td>2450</td> <td>2450</td> <td>45</td> </tr> <tr> <td>M12</td> <td>4410</td> <td>4410</td> <td>4410</td> <td>60</td> </tr> <tr> <td>M16</td> <td>5978</td> <td>5978</td> <td>5978</td> <td>70</td> </tr> <tr> <td>M20</td> <td>7840</td> <td>7840</td> <td>7840</td> <td>90</td> </tr> <tr> <td>M24</td> <td>7840</td> <td>7840</td> <td>7840</td> <td>100</td> </tr> <tr> <td>Length limit of embedded bolt (mm)</td> <td>100 or less</td> <td>120 or less</td> <td>160 or less</td> <td>180 or less</td> </tr> </tbody> </table> <p>Long-term allowable pull-out load (N)</p> <p>Notes</p> <ol style="list-style-type: none"> <li>The above table shows the short-term allowable pull-out load for anchor bolts embedded for the lengths shown.</li> <li>The concrete design characteristic strength is taken to be F<sub>c</sub> = 17.6 N/mm<sup>2</sup>.</li> <li>When the dimensions differ from the above diagram, or if the concrete design characteristic strength differs, then the pull-out load can be calculated according with the formulae for bolts in a strong foundation, at the left, and divide the result by 1.5 to obtain the allowable pull-out load. In any case, the allowable pull-out load on one bolt must not exceed 7,840 N.</li> <li>Do not use bolts with an embedded length less than that shown in the rightmost column.</li> <li>It is necessary to investigate the short-term pull-out load of normal supports with regard to earthquakes when the supports are installed in the bottom of ceiling slabs and on concrete walls designed to support heavy objects. For this short-term pull-out load, see item b, "Short-term pull-out loads."</li> <li>If type 1 or 2 lightweight concrete is used, allow 10% margin.</li> </ol>	Bolt diameter d (nominal)	Concrete thickness (mm)			Embedded length L (mm)	120	150	180	M8	1960	1960	1960	40	M10	2450	2450	2450	45	M12	4410	4410	4410	60	M16	5978	5978	5978	70	M20	7840	7840	7840	90	M24	7840	7840	7840	100	Length limit of embedded bolt (mm)	100 or less	120 or less	160 or less	180 or less
Bolt diameter d (nominal)	Concrete thickness (mm)			Embedded length L (mm)																																																																																				
	120	150	180																																																																																					
M8	2940	2940	2940	40																																																																																				
M10	3724	3724	3724	45																																																																																				
M12	6566	6566	6566	60																																																																																				
M16	9016	9016	9016	70																																																																																				
M20	11760	11760	11760	90																																																																																				
M24	11760	11760	11760	100																																																																																				
Length limit of embedded bolt (mm)	100 or less	120 or less	160 or less	180 or less																																																																																				
Bolt diameter d (nominal)	Concrete thickness (mm)			Embedded length L (mm)																																																																																				
	120	150	180																																																																																					
M8	1960	1960	1960	40																																																																																				
M10	2450	2450	2450	45																																																																																				
M12	4410	4410	4410	60																																																																																				
M16	5978	5978	5978	70																																																																																				
M20	7840	7840	7840	90																																																																																				
M24	7840	7840	7840	100																																																																																				
Length limit of embedded bolt (mm)	100 or less	120 or less	160 or less	180 or less																																																																																				

### (3) Installation position and center of gravity

For 2-WAY Type

#### ■ Outdoor Unit

##### 1) Position of center-of-gravity

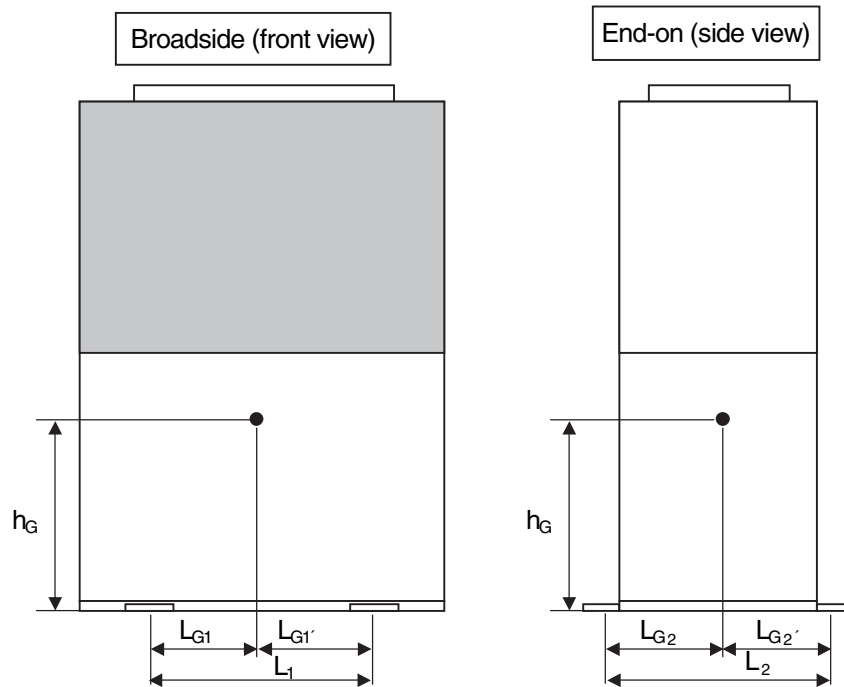

Outdoor unit type	Position of mounting points		Position of center-of-gravity				h <sub>G</sub>	Unit Weight (kg)
	L <sub>1</sub>	L <sub>2</sub>	L <sub>G1</sub>	L <sub>G1'</sub>	L <sub>G2</sub>	L <sub>G2'</sub>		
45.0 kW	1,000	1,040	515	485	508	532	760	755/770
56.0 kW	1,000	1,040	515	485	508	532	770	780/795
71.0 kW	1,000	1,040	515	485	510	530	860	810/825
85.0 kW	1,000	1,040	520	480	511	529	889	840

For earthquake-resistant design, compare L<sub>G1</sub> and L<sub>G1'</sub>, and L<sub>G2</sub> and L<sub>G2'</sub>, and use the smallest value.

##### 2) Mounting pad (foundation) size

Unit: mm

		A (mm)	B (mm)	C (mm)	
45.0/56.0/ 71.0 kW	Installation on ground	1,700 or more	1,170 or more	120 or more	
	Installation on roof	Without vibration-resistant frame	1,850 or more	2,000 or more	140 or more
		With vibration-resistant frame (interlocking type)	1,850		
85.0 kW	Installation on ground	1,700 or more	1,170 or more	120 or more	
	Installation on roof	Without vibration-resistant frame	1,850 or more	2,000 or more	140 or more
		With Vibration-resistant frame	2,000 or more		

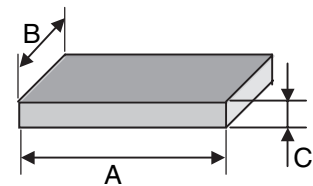

Note: The foundation is either a solid pad, or directly on the floor slab.

##### 3) Size and type of anchor bolts

i) All anchor bolts are M12.

ii) Use one of the following types of anchor bolts.

Embedded-type: L-type, LA-type, headed bolts, J-type, JA-type

Boxout-compatible: L, LA, headed, J or JA (however, base dimension C must be at least 180 mm), post-drilled resin anchors or post-installed male-threaded mechanical anchor bolts.

Female screw anchors provide insufficient pull-out strength, so cannot be used.

For 3-WAY Type

■ Outdoor Unit

1) Position of center-of-gravity

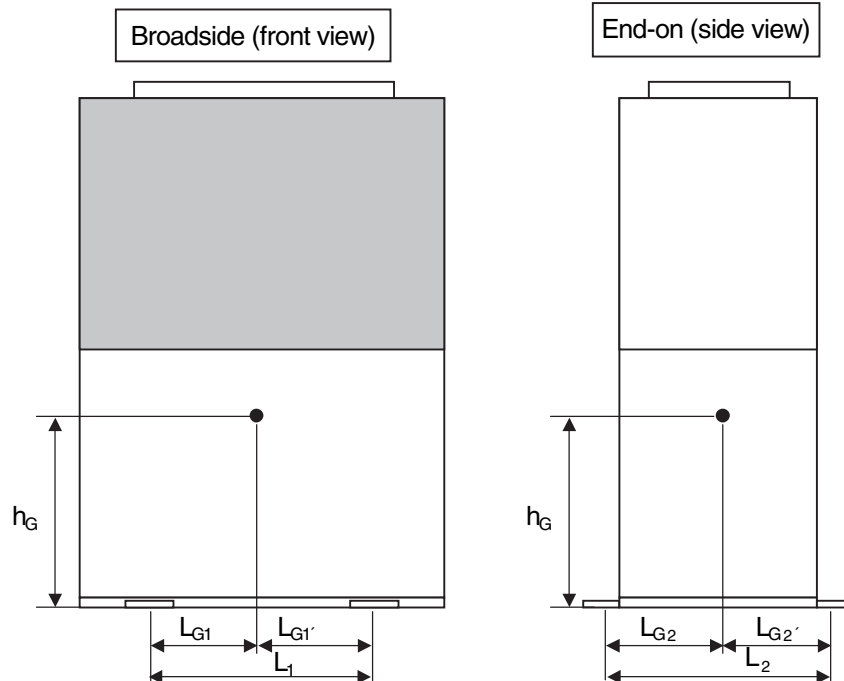

Outdoor unit type	Position of mounting points		Position of center-of-gravity					Unit Weight (kg)
	L <sub>1</sub>	L <sub>2</sub>	L <sub>G1</sub>	L <sub>G1'</sub>	L <sub>G2</sub>	L <sub>G2'</sub>	h <sub>G</sub>	
45.0 kW	1,000	1,040	513	487	507	533	770	775
56.0 kW	1,000	1,040	513	487	507	533	770	775
85.0 kW	1,000	1,040	524	476	508	532	820	805

For earthquake-resistant design, compare L<sub>G1</sub> and L<sub>G1'</sub>, and L<sub>G2</sub> and L<sub>G2'</sub>, and use the smallest value.

2) Mounting pad (foundation) size

Unit: mm

		A (mm)	B (mm)	C (mm)
Installation on ground		1,700 or more	1,170 or more	120 or more
Installation on roof	Without vibration-resistant frame	1,850 or more	2,000 or more	140 or more
	With Vibration-resistant frame	2,000 or more		

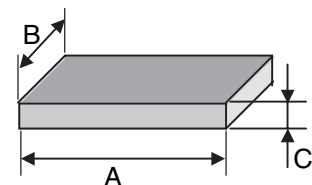

Note: The foundation is either a solid pad, or directly on the floor slab.

3) Size and type of anchor bolts

i) All anchor bolts are M12.

ii) Use one of the following types of anchor bolts.

Embedded-type: L-type, LA-type, headed bolts, J-type, JA-type

Boxout-compatible: L, LA, headed, J or JA (however, base dimension C must be at least 180 mm), post-drilled resin anchors or post-installed male-threaded mechanical anchor bolts.

Female screw anchors provide insufficient pull-out strength, so cannot be used.

### (4) Example anchor bolt calculation

Earthquake-resistance evaluation of Model U-25GE2E5

- 1) The earthquake-resistance type is “Common use,” so design horizontal earthquake factor  $K_H$  is 1.0 G. ( $K_H = 1.0$  for rooftop installations, and 0.4 for ground installations.)
- 2) Refer to paragraph (3) on the previous page for the equipment center-of-gravity position.
- 3) Anchor bolts  
 Number of bolts = 4  
 Bolt diameter M12 (12 mm)  
 Note: If calculations give unacceptable results, change conditions and recalculate.

Example of evaluation using calculations

#### (1) Anchor bolt conditions

- 1) Total no. of bolts (N)  $N = 4$  current models have four bolts
- 2) Bolt diameter (D)  $D = 12$  mm for M12 bolts
- 3) Bolt cross-sectional area (A)  $A = \pi D^2 / 4 = 113$  mm<sup>2</sup>
- 4) Bolts on one side (end-on direction,  $n_1$ )  $n_1 = 2$  current models have two bolts  
 (broadside direction,  $n_2$ )  $n_2 = 2$  current models have two bolts
- 5) The installation method is for “embedded J or JA type bolts,” on a 15-cm-thick slab  
 Anchor bolt allowable short-term tensile load ( $T_a$ )  $T_a = 11,760$  N  
 (The installation method may also be selected after completing calculations.)

#### (2) Calculation

- 1) Design horizontal seismic magnitude ( $K_H$ )  $K_H = 1.0$  Installation location:  $K_H$  roof : 1.0  
 ground : 0.4
- 2) Operating load (W)  
 (= operating mass  $\times$  9.8)  $W = 7,938$  N
- 3) Horizontal earthquake force ( $F_H$ )  $F_H = K_H \cdot W = 7,938$  N
- 4) Height of center-of-gravity ( $h_G$ )  $h_G = 860$  mm
- 5) Vertical earthquake force ( $F_V$ )  $F_V = F_H / 2 = 3,969$  N
- 6) Distance from center-of-gravity to bolt  
 End-on direction ( $L_{G1}$ )  $L_{G1} = 515$  mm  
 Broadside direction ( $L_{G2}$ )  $L_{G2} = 510$  mm

- 7) Bolt span  
 End-on direction ( $L_1$ )  $L_1 = 1,000$  mm  
 Broadside direction ( $L_2$ )  $L_2 = 1,040$  mm
- 8) Actual strength of anchor bolts  
 Short-term allowable tensile stress ( $f_t$ )  $f_t = 176$  N/mm<sup>2</sup> for SS400,  $f_t = 176$   
 Short-term allowable shear stress ( $f_s$ )  $f_s = 99$  N/mm<sup>2</sup> for SS400,  $f_s = 132 \times 0.75$
- 9) Pull-out load on one bolt  
 End-on direction ( $R_{b1}$ )  $R_{b1} = \frac{F_H \cdot h_G - (W - F_V) L_{G1}}{L_1 \cdot n_1} = 2,391$  N  
 Broadside direction ( $R_{b2}$ )  $R_{b2} = \frac{F_H \cdot h_G - (W - F_V) L_{G2}}{L_2 \cdot n_2} = 2,309$  N
- 10) Anchor bolt shear stress ( $\tau$ )  $\tau = \frac{F_H}{N \cdot A} = 17.6$  N/mm<sup>2</sup>
- 11) Mounting bolt tensile stress  
 End-on direction ( $\delta_1$ )  $\delta_1 = \frac{R_{b1}}{A} = 21.2$  N/mm<sup>2</sup>  
 Broadside direction ( $\delta_2$ )  $\delta_2 = \frac{R_{b2}}{A} = 20.4$  N/mm<sup>2</sup>
- 12) Allowable tensile stress on a bolt subject to both tensile and shear stresses ( $f_{ts}$ )  
 $f_{ts} = 1.4 \cdot f_t - 1.6\tau = 218.4$  N/mm<sup>2</sup>

### (3) Judgment

- 1) Tensile load  
 End-on direction, if  $R_{b1} < T_a$   OK  $R_{b1} = 2,391 < T_a = 11,760$   
 Broadside direction, if  $R_{b2} < T_a$   OK  $R_{b2} = 2,304 < T_a = 11,760$
- 2) Shear stress  
 if  $\tau < f_s$ ,  OK  $\tau = 17.6 < f_s = 99$
- 3) Tensile stress  
 End-on direction: if  $\delta_1 < f_t$   OK  $\delta_1 = 21.2 < f_t = 176$   
 $\delta_1 < f_{ts}$   $< f_{ts} = 218.4$   
 Broadside direction: if  $\delta_2 < f_t$   OK  $\delta_2 = 20.4 < f_t = 176$   
 $\delta_2 < f_{ts}$   $< f_{ts} = 218.4$

# Contents

- 1. Points regarding refrigerant pipe work
  - (1) Points regarding branch pipe work..... E-2
  - (2) Points regarding header pipe work ..... E-6
  - (3) Refrigerant pipe connection work ..... E-7
  - (4) Charging with additional refrigerant ..... E-9
  
- 2. Points regarding electrical work (outdoor unit)
  - (1) Wiring thickness and device capacity ..... E-13
  - (2) Electrical wiring system diagram..... E-14
  - (3) Precautions regarding electrical work ..... E-15
  
- 3. Outdoor unit installation work .....E-17

### (1) Points regarding branch pipe work

- CZ-P160BK2

#### 1. Accompanying Parts

Check the contents of your distribution joint kit.

#### 2. Distribution Joint Kits (with insulation)

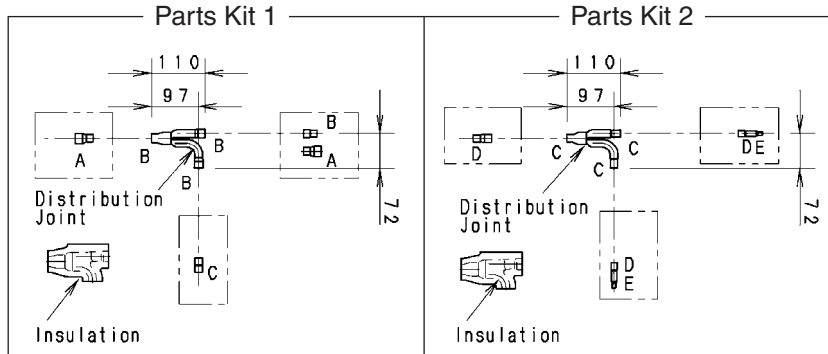

- Size of connection point on each part (Shown are inside diameters of tubing)

Size	Part A	Part B	Part C	Part D	Part E
mm	Ø19.05	Ø15.88	Ø12.7	Ø9.52	Ø6.35
Inch	3/4	5/8	1/2	3/8	1/4

#### 3. Making Branch Connections

- For branching tubes, install 150mm or larger (including reducer) straight tubing up to the point where the tube branches (or after the point where the tubes join together).
- Using a tube cutter, cut the joints at the diameter required to match the outside diameter of the tubing you are connecting. (This is usually done at the installation site.) The tube diameter depends on the total capacity of the indoor unit.

Note that you do not have to cut the joints if it already matches the tubing end size. For size selection of the tube diameter, refer to the installation instructions provided with the outdoor unit.

#### Note

Avoid forceful cutting that may harm the shape of the joints or tubing. (Inserting the tubing will not be possible if the tube shape is not proper.)

- Cut off as far away from stopper as possible.
- After cutting the joints, be sure to remove burrs on the inside of the joints. (If the joints have been squashed or dented badly, reshaped them using a tube spreader.)
- Make sure there is no dirt or other foreign substances inside the distribution joint.
- The distribution joint can be either horizontal or vertical. In the case of horizontal, the L-shaped tubing must be slanted slightly upward (15° to 30°).

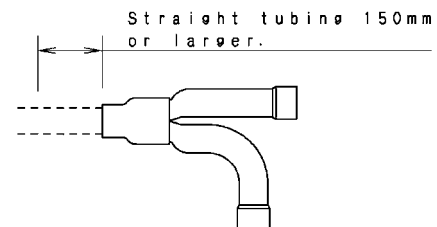

- When brazing a pipe E to the reducer of which middle pipe inner dimension is D as shown above chart, cut the middle pipe as long as possible as that the pipe E can be inserted.

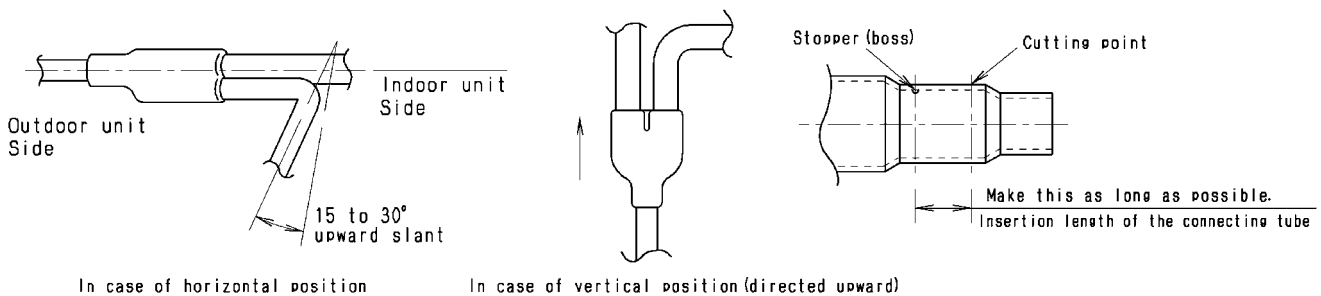

- When brazing, replace air inside the tube with nitrogen gas to prevent copper oxide from forming.
- To insulate the distribution joint, use the supplied tubing insulation. (If using insulation other than that supplied, make sure that its heat resistance is 120°C or higher.)
- For additional details, refer to the installation instructions provided with the outdoor unit.

• CZ-P680BK2

1. Accompanying Parts  
Check the contents of your distribution joint kit.
2. Distribution Joint Kits (with insulation)

Part Name	Parts Kit 1	Parts Kit 2
Distribution Joints	1	1
Insulations	1	1
Reducing Joints	5	3

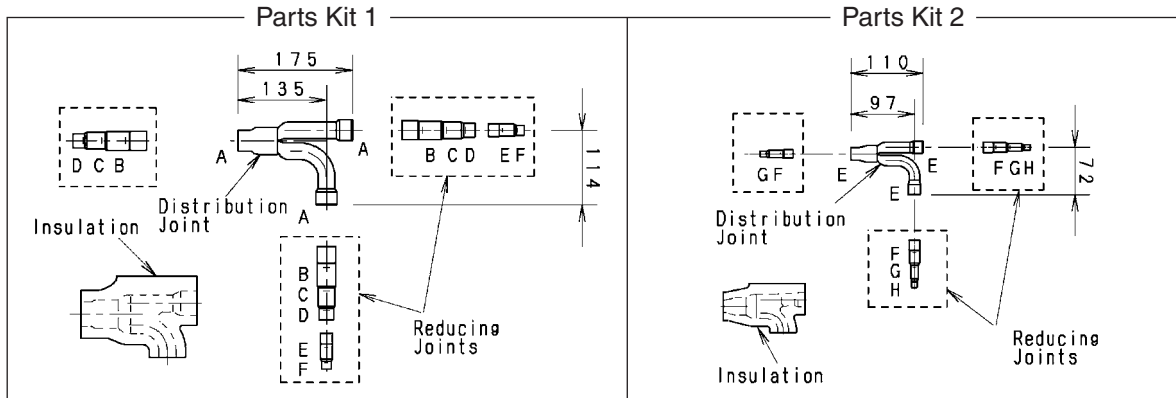

- Size of connection point on each part (Shown are inside diameters of tubing)

Size	Part A	Part B	Part C	Part D	Part E	Part F	Part G	Part H
mm	Ø28.58	Ø25.4	Ø22.22	Ø19.05	Ø15.88	Ø12.7	Ø9.52	Ø6.35
Inch	1-1/8	1	7/8	3/4	5/8	1/2	3/8	1/4

3. Making Branch Connections

- For branching tubes, install 150mm or larger (including reducer) straight tubing up to the point where the tube branches (or after the point where the tubes join together).
- Using a tube cutter, cut the joints at the diameter required to match the outside diameter of the tubing you are connecting. (This is usually done at the installation site.) The tube diameter depends on the total capacity of the indoor unit.

Note that you do not have to cut the joints if it already matches the tubing end size. For size selection of the tube diameter, refer to the installation instructions provided with the outdoor unit.

**Note**

Avoid forceful cutting that may harm the shape of the joints or tubing. (Inserting the tubing will not be possible if the tube shape is not proper.)

- Cut off as far away from stopper as possible.
- After cutting the joints, be sure to remove burrs on the inside of the joints. (If the joints have been squashed or dented badly, reshaped them using a tube spreader.)
- Make sure there is no dirt or other foreign substances inside the distribution joint.
- The distribution joint can be either horizontal or vertical. In the case of horizontal, the L-shaped tubing must be slanted slightly upward (15° to 30°).

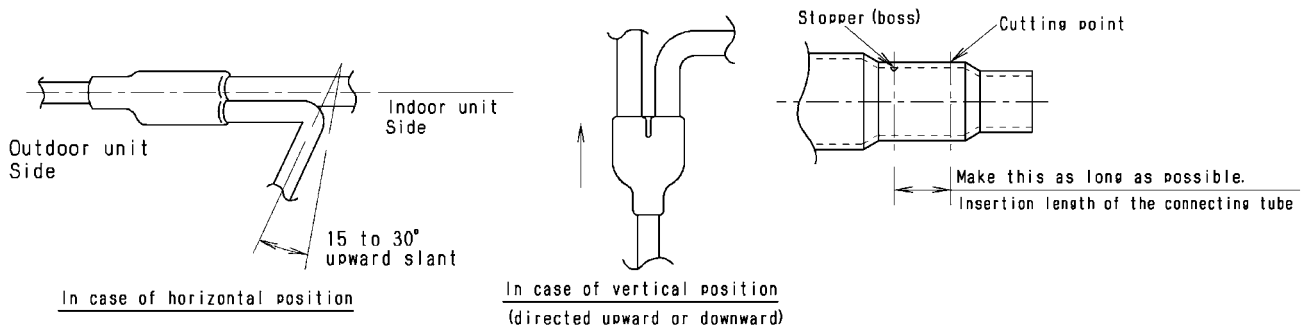
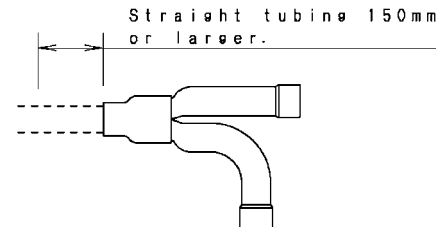

- When brazing, replace air inside the tube with nitrogen gas to prevent copper oxide from forming.
- To insulate the distribution joint, use the supplied tubing insulation. (If using insulation other than that supplied, make sure that its heat resistance is 120°C or higher.)
- For additional details, refer to the installation instructions provided with the outdoor unit.



• CZ-P1350BK2

1. Accompanying Parts  
Check the contents of your distribution joint kit.
2. Distribution Joint Kits (with insulation)

Part Name	Parts Kit 1	Parts Kit 2
Distribution Joints	1	1
Insulations	1	1
Reducing Joints	7	4

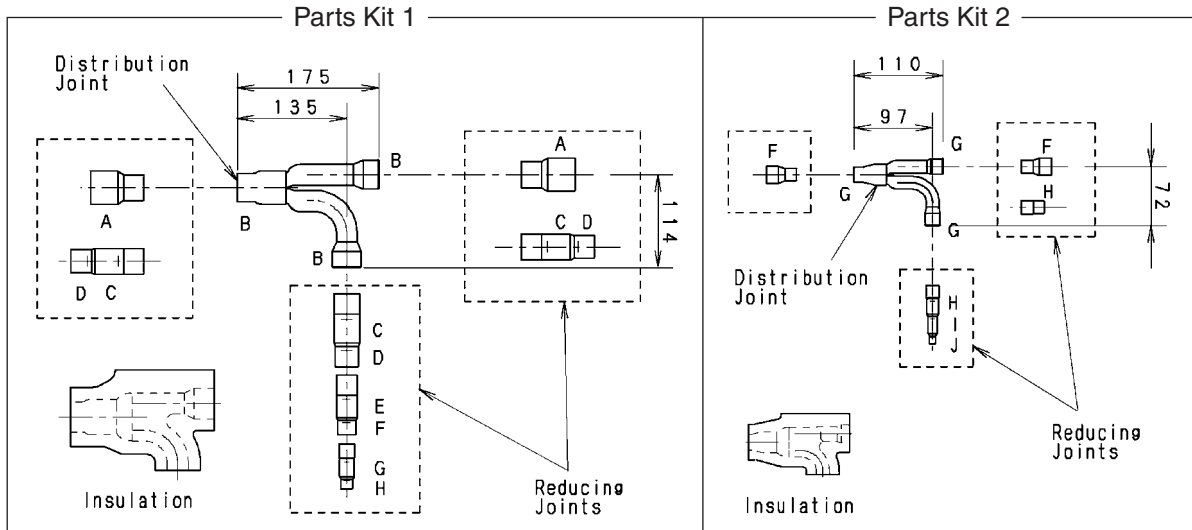

• Size of connection point on each part (Shown are inside diameters of tubing)

Size	Part A	Part B	Part C	Part D	Part E	Part F	Part G	Part H	Part I	Part J
mm	Ø38.1	Ø31.75	Ø28.58	Ø25.4	Ø22.22	Ø19.05	Ø15.88	Ø12.7	Ø9.52	Ø6.35
Inch	1-1/2	1-1/4	1-1/8	1	7/8	3/4	5/8	1/2	3/8	1/4

### 3. Making Branch Connections

- For branching tubes, install 150mm or larger (including reducer) straight tubing up to the point where the tube branches (or after the point where the tubes join together).
- Using a tube cutter, cut the joints at the diameter required to match the outside diameter of the tubing you are connecting. (This is usually done at the installation site.) The tube diameter depends on the total capacity of the indoor unit.

Note that you do not have to cut the joints if it already matches the tubing end size. For size selection of the tube diameter, refer to the installation instructions provided with the outdoor unit.

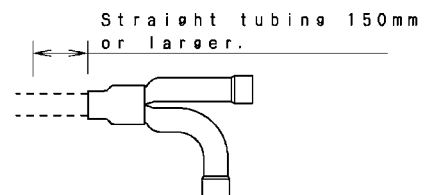

#### Note

Avoid forceful cutting that may harm the shape of the joints or tubing. (Inserting the tubing will not be possible if the tube shape is not proper.)

- Cut off as far away from stopper as possible.
- After cutting the joints, be sure to remove burrs on the inside of the joints. (If the joints have been squashed or dented badly, reshaped them using a tube spreader.)
- Make sure there is no dirt or other foreign substances inside the distribution joint.
- When brazing, replace air inside the tube with nitrogen gas to prevent copper oxide from forming.
- To insulate the distribution joint, use the supplied tubing insulation.  
(If using insulation other than that supplied, make sure that its heat resistance is 120°C or higher.)
- For additional details, refer to the installation instructions provided with the outdoor unit.

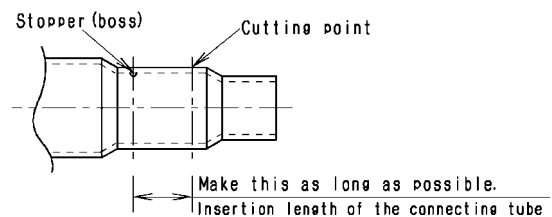

- CZ-P680PJ2
- CZ-P1350PJ2

Capacity	Parts Kit Combination	
135kW or less	Parts Kit 1	Parts Kit 3
68kW or less	Parts Kit 2	Parts Kit 3

1. Accompanying Parts  
Check the contents of your distribution joint kit.
2. Distribution Joint Kits (with insulation)

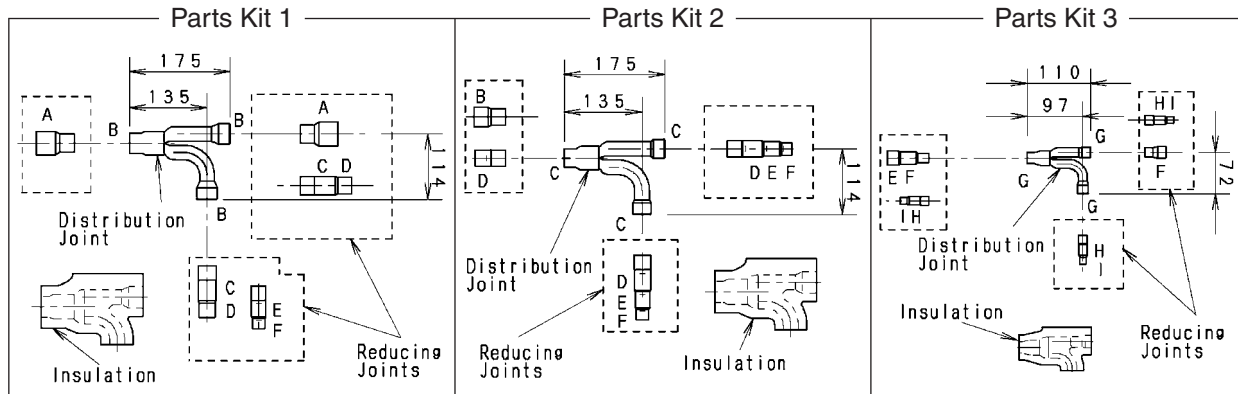

- Size of connection point on each part (Shown are inside diameters of tubing)

Size	Part A	Part B	Part C	Part D	Part E	Part F	Part G	Part H	Part I
mm	Ø38.1	Ø31.75	Ø28.58	Ø25.4	Ø22.22	Ø19.05	Ø15.88	Ø12.7	Ø9.52
Inch	1-1/2	1-1/4	1-1/8	1	7/8	3/4	5/8	1/2	3/8

### 3. Making Branch Connections

- For branching tubes, install 150mm or larger (including reducer) straight tubing up to the point where the tube branches (or after the point where the tubes join together).
- Using a tube cutter, cut the joints at the diameter required to match the outside diameter of the tubing you are connecting. (This is usually done at the installation site.) The tube diameter depends on the total capacity of the indoor unit.

Note that you do not have to cut the joints if it already matches the tubing end size. For size selection of the tube diameter, refer to the installation instructions provided with the outdoor unit.

#### Note

Avoid forceful cutting that may harm the shape of the joints or tubing. (Inserting the tubing will not be possible if the tube shape is not proper.)

- Cut off as far away from stopper as possible.
- After cutting the joints, be sure to remove burrs on the inside of the joints. (If the joints have been squashed or dented badly, reshaped them using a tube spreader.)
- Make sure there is no dirt or other foreign substances inside the distribution joint.
- The distribution joint can be either horizontal or vertical. In the case of horizontal, the L-shaped tubing must be slanted slightly upward (15° to 90°).

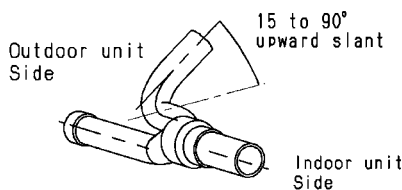
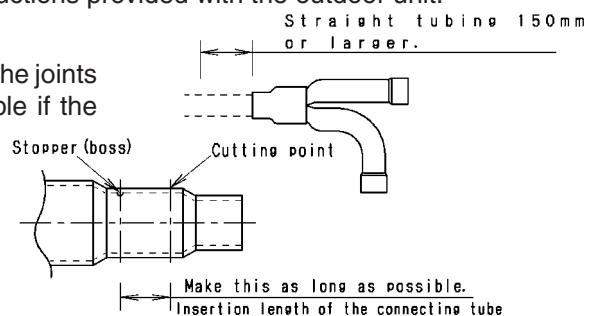

In case of horizontal position

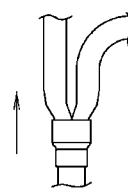

In case of vertical position (directed upward)

Direction of Distribution Joint

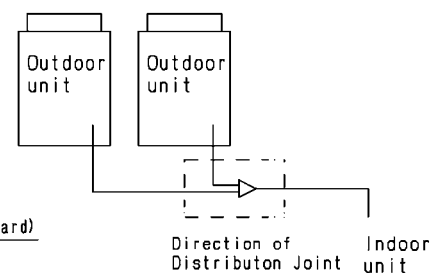

Direction of Distribution Joint Indoor unit

- When brazing, replace air inside the tube with nitrogen gas to prevent copper oxide from forming.
- To insulate the distribution joint, use the supplied tubing insulation. (If using insulation other than that supplied, make sure that its heat resistance is 120°C or higher.)
- For additional details, refer to the installation instructions provided with the outdoor unit.

### (2) Points regarding header pipe work

- Header pipes should be oriented as shown in the following figures. In particular, care should be taken when using them vertically.

<Horizontal use>

#### (1) Horizontal pointing to the side

- Slant at 15° to 30°.
- For the branch pipe on the indoor unit side, make sure you bring the pipe up as shown in the figure below and then lay it horizontally.

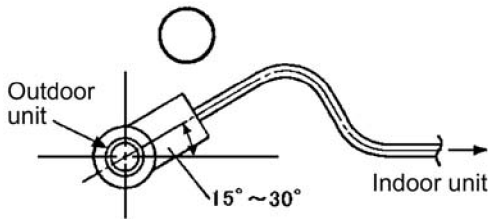

#### (2) Horizontal pointing up

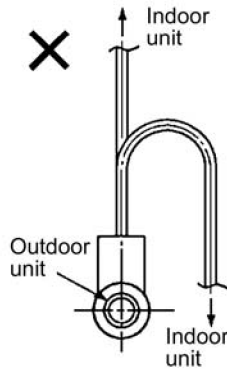

<Vertical use>

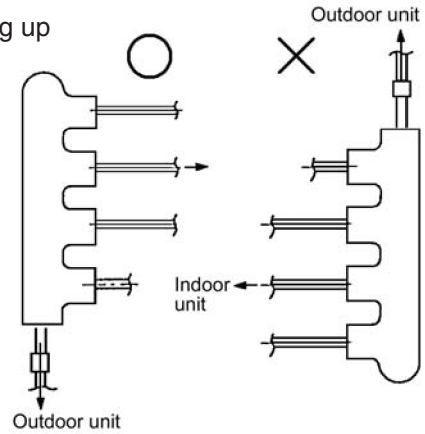

- Cut the branch pipe of the header to match the size of the refrigerant pipe on the indoor unit side.
- If three indoor units are to be used, cut and connect three branches to match the size of the refrigerant pipes on the indoor unit side. Positions that are not being used should be just left as they are.
- If 5 to 8 indoor units are to be used, connect and use two header pipes as shown in the figure below.

<Connection of header pipe>

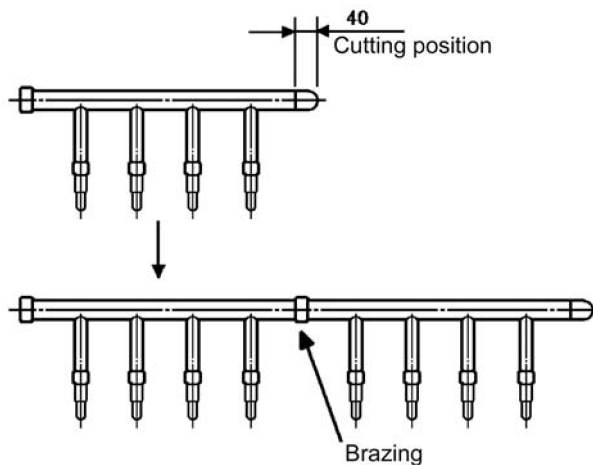

- For the cutting positions of the pipes, refer to the following figure.

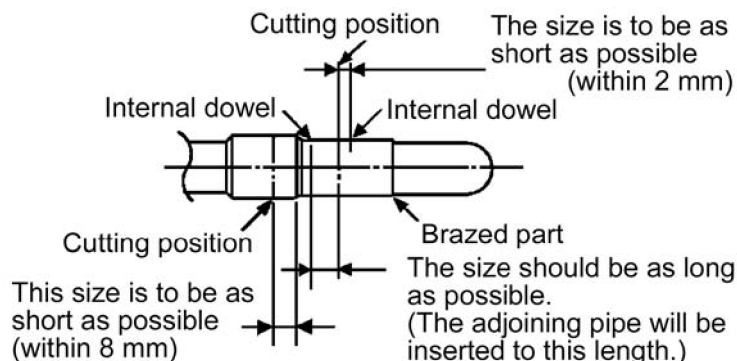

- For further details, refer to the installation work manual.

### (3) Refrigerant pipe connection work

<not detected 3-WAY multi>

#### (1) Preparing and installing the tubing

- Material: Phosphorous deoxidized copper seamless tubing (C1220T)
- Tube size: Use the correct size according to Table 1.

Table 1

Outer dia.	Tube size (mm)									
	Ø9.52 (C1220 O)	Ø12.7 (C1220 O)	Ø15.88 (C1220 O)	Ø19.05		Ø22.2 (C1220 1/2,H)	Ø25.4 (C1220 1/2,H)	Ø28.58 (C1220 1/2,H)	Ø31.75 (C1220 1/2,H)	Ø38.1 (C1220 1/2,H)
				(C1220 O)	(C1220 1/2,H)					
Thickness	T 0.8	T 0.8	T 1.0	T 1.2	T 1.0	T 1.0	T 1.0	T 1.0	T 1.1	T 1.35

#### (2) Precautions regarding piping work

⚠ Caution	
<ul style="list-style-type: none"> <li>• Apply thermal insulation to all tubing, including branch tubes. Make sure that there are no gaps or openings in the thermal insulation that may allow moisture to enter. Use thermal insulation that can withstand a minimum of 120°C for the gas side (wide tube system), and a minimum of 80°C for the liquid side (narrow tube system). Failure to do so can result in water leakage and dripping condensation, leading to wall discoloration, paddling, etc.</li> <li>• Use separate piping for the power cables and the control cables. If the cables are passed through the same pipes, the effects of electrical noise and induction can cause malfunctions.</li> </ul>	<p style="text-align: center;">Figure 1</p>

#### (3) Select the gas pipe, liquid pipe, branches (separately sold), and make the necessary preparations for installation.

- After cutting the tube, be sure to remove all burrs and finish tubing ends to the correct surface. (The same must be done for branch tubes (purchased separately).)
- When bending tubes, be sure the bend radius is at least 4 times the outer diameter of the tube.
- When cutting or bending tubes, be careful not to cause any pinching or blockage of the tube.

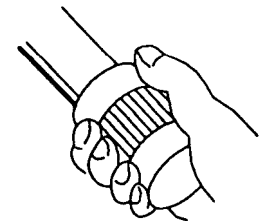

Figure 2

⚠ Caution
Prevent foreign substances such as dirt or water from entering the tube by sealing the end of the tubes with either a cap or with tape. Otherwise, this can damage the devices and result in malfunction.

(4) Connecting the refrigerant tubing

<not detected 3-WAY multi>

1. Remove the fastening rubber.
2. Connect the tubes and perform brazing.
3. Reattach the gas tube, liquid tube fastening panel, and fastening rubber as they were originally.

⚠ Caution

Be sure to perform the following before brazing.

- The rubber that fastens the tubes is damaged easily by heat. Be sure to remove it before brazing.
- Cool the tubes with wet clothes or other materials to prevent the value inside the machine from being damaged by the brazing heat.
- Do not use commercially available oxide film agents (antioxidants). They can adversely affect the refrigerant and the refrigeration oil, and can cause malfunctions.

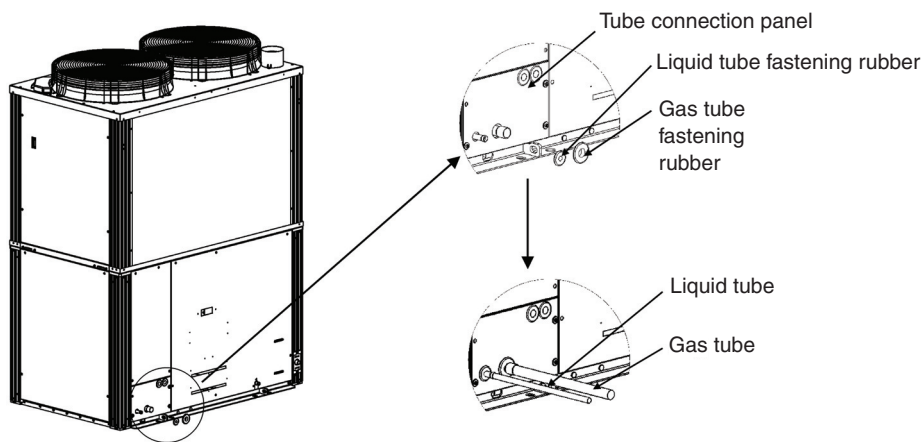

Figure 3

⚠ Caution

- Be sure to replace the contents of the tube with nitrogen to prevent the formation of an oxide film. (Oxygen, carbon dioxide or refrigerant may not be used)
- If using flare connections (for the indoor connectors or other part), apply refrigeration oil to the flared part.

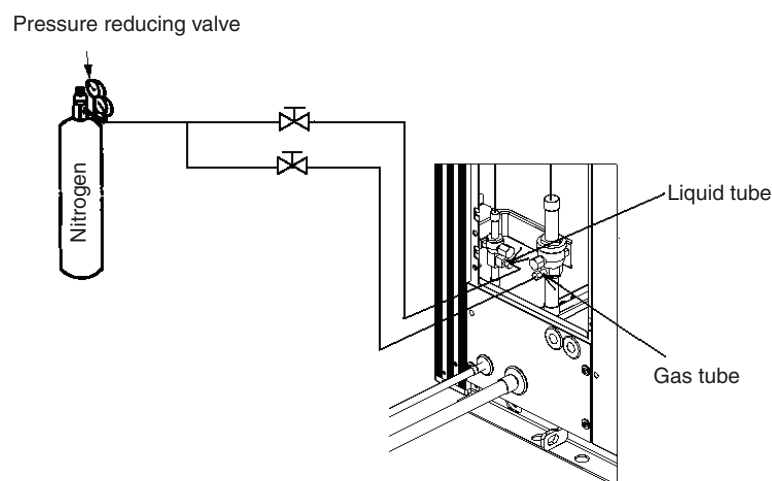

Figure 4

- (5) Tubing airtightness test and vacuum application <not detected 3-WAY multi>
- An airtightness test is required for gas heat pump A/C as part of industry installation guidelines. Follow the procedure below to perform the test and confirm there is no leakage from any connections.
  - Connect the manifold gauge to both service ports - on the wide tube side and narrow tube size. Then connect the nitrogen tank, vacuum pump, and other items as shown in Fig. 5.

### CAUTION

Connect an R410A control valve (Schrader valve) at the service port for the shut-off valve.  
If an R410A control valve (Schrader valve) is not connected, it may cause a frost burn due to refrigerant leaking when the charge hose is removed.

⚠ Caution
<ul style="list-style-type: none"> <li>• Use nitrogen to raise the pressure to the airtightness test pressure (4.15 MPaG) and confirm that there is no leakage. Refrigerant leakage can cause suffocation and injury to nearby persons.</li> </ul>

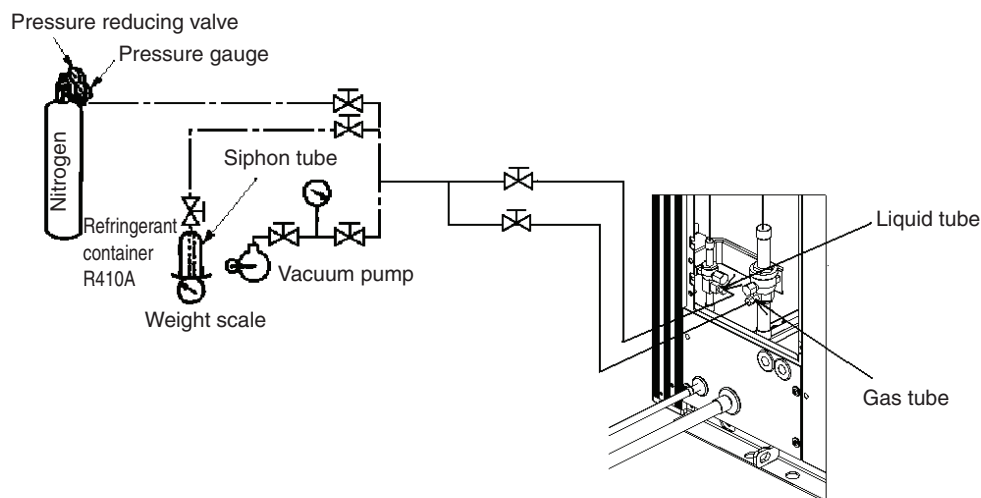

Figure 5

- When performing airtightness tests or creating vacuums, perform them for all service ports simultaneously. (All outdoor unit valves should remain closed.)  
Always use nitrogen for the airtightness test. (Do not use oxygen, carbon dioxide, other refrigerants, etc.)  
When performing the airtightness test for newly installed indoor/outdoor unit tubing, we recommend testing the tubes separately before connecting them to outdoor units.
- After the airtightness test is completed, apply vacuum of 667 Pa (-755 mmHg, 5 Torr) or below to the indoor unit and tubing.
- Do not leave for a long period of time after the vacuum state has been reached.

**CAUTION** The service ports are check valves.

### (4) Charging with additional refrigerant

The charge amount of refrigerant at the time of shipping from the factory is 11.5 kg. Add the necessary additional charge to the unit. The piping section has not been considered. Add additional refrigerant in accordance with the length of the piping.

For details on the charge amount of refrigerant, see the section "Calculation of the additional charge amount of refrigerant."

### (3) Refrigerant pipe connection work

<for 3-WAY multi>

#### (1) Preparing and installing the tubing

- Material: Phosphorous deoxidized copper seamless tubing (C1220T)
- Tube size: Use the correct size according to Table 1.

Table 1

Outer dia.	Tube size (mm)									
	Ø9.52 (C1220 O)	Ø12.7 (C1220 O)	Ø15.88 (C1220 O)	Ø19.05		Ø22.2 (C1220 1/2,H)	Ø25.4 (C1220 1/2,H)	Ø28.58 (C1220 1/2,H)	Ø31.75 (C1220 1/2,H)	Ø38.1 (C1220 1/2,H)
				(C1220 O)	(C1220 1/2,H)					
Thickness	T0.8	T 0.8	T 1.0	T 1.2	T 1.0	T 1.0	T 1.0	T 1.0	T 1.1	T 1.35

#### (2) Precautions regarding piping work

##### ⚠ Caution

- Apply thermal insulation to all tubing, including branch tubes. Make sure that there are no gaps or openings in the thermal insulation that may allow moisture to enter. Use thermal insulation that can withstand a minimum of 120°C for the gas side (wide tube system), and a minimum of 80°C for the liquid side (narrow tube system). Failure to do so can result in water leakage and dripping condensation, leading to wall discoloration, paddling, etc.
- Use separate piping for the power cables and the control cables. If the cables are passed through the same pipes, the effects of electrical noise and induction can cause malfunctions.

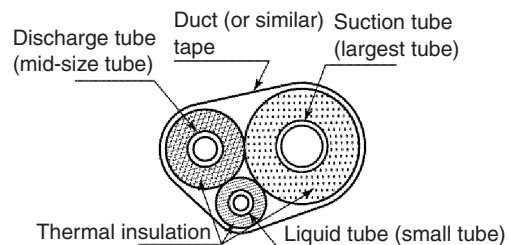

Figure 1

#### (3) Select the gas pipe, liquid pipe, branches (separately sold), and make the necessary preparations for installation.

- After cutting the tube, be sure to remove all burrs and finish tubing ends to the correct surface. (The same must be done for branch tubes (purchased separately).)
- When bending tubes, be sure the bend radius is at least 4 times the outer diameter of the tube.
- When cutting or bending tubes, be careful not to cause any pinching or blockage of the tube.

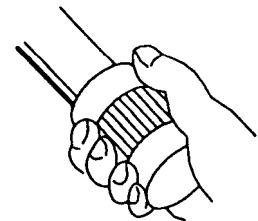

Figure 2

##### ⚠ Caution

Prevent foreign substances such as dirt or water from entering the tube by sealing the end of the tubes with either a cap or with tape. Otherwise, this can damage the devices and result in malfunction.



(4) Connecting the refrigerant tubing

<for 3-WAY multi>

1. Remove the fastening rubber.
2. Connect the tubes and perform brazing.
3. Reattach the gas tube, liquid tube fastening panel, and fastening rubber as they were originally.

**⚠ Caution**

Be sure to perform the following before brazing.

- The rubber that fastens the tubes is damaged easily by heat. Be sure to remove it before brazing.
- Cool the tubes with wet clothes or other materials to prevent the value inside the machine from being damaged by the brazing heat.
- Do not use commercially available oxide film agents (antioxidants). They can adversely affect the refrigerant and the refrigeration oil, and can cause malfunctions.

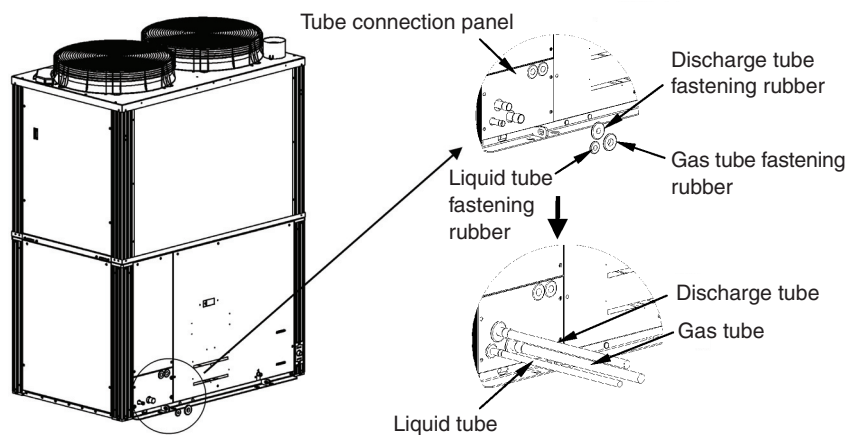

Figure 3

**⚠ Caution**

- Be sure to replace the contents of the tube with nitrogen to prevent the formation of an oxide film. (Oxygen, carbon dioxide or refrigerant may not be used)
- If using flare connections (for the indoor connectors or other part), apply refrigeration oil to the flared part.

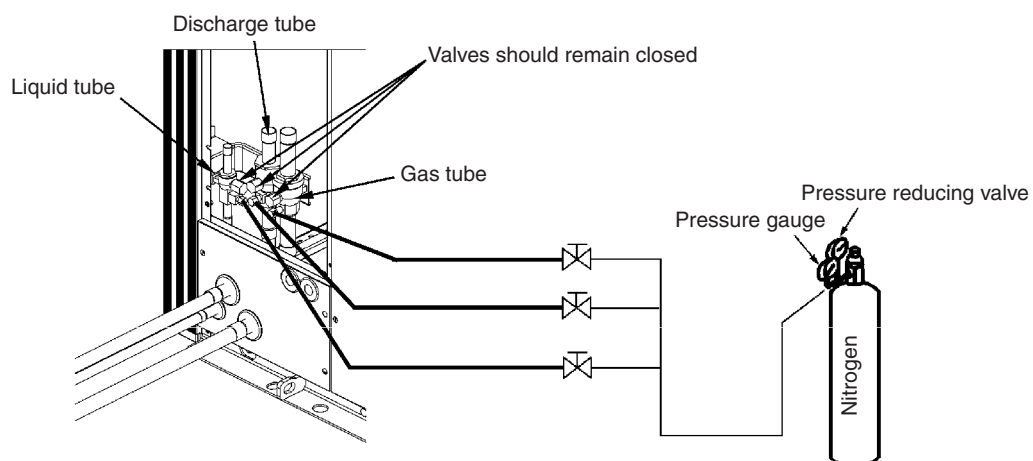

Figure 4



- (5) Tubing airtightness test and vacuum application <for 3-WAY multi>
- An airtightness test is required for gas heat pump A/C as part of industry installation guidelines. Follow the procedure below to perform the test and confirm there is no leakage from any connections.
  - Connect the manifold gauge to both service ports - on the wide tube side and narrow tube size. Then connect the nitrogen tank, vacuum pump, and other items as shown in Fig. 5.

### CAUTION

Connect an R410A control valve (Schrader valve) at the service port for the shut-off valve.  
If an R410A control valve (Schrader valve) is not connected, it may cause a frost burn due to refrigerant leaking when the charge hose is removed.

⚠ Caution
<ul style="list-style-type: none"> <li>• Use nitrogen to raise the pressure to the airtightness test pressure (4.15 MPaG) and confirm that there is no leakage. Refrigerant leakage can cause suffocation and injury to nearby persons.</li> </ul>

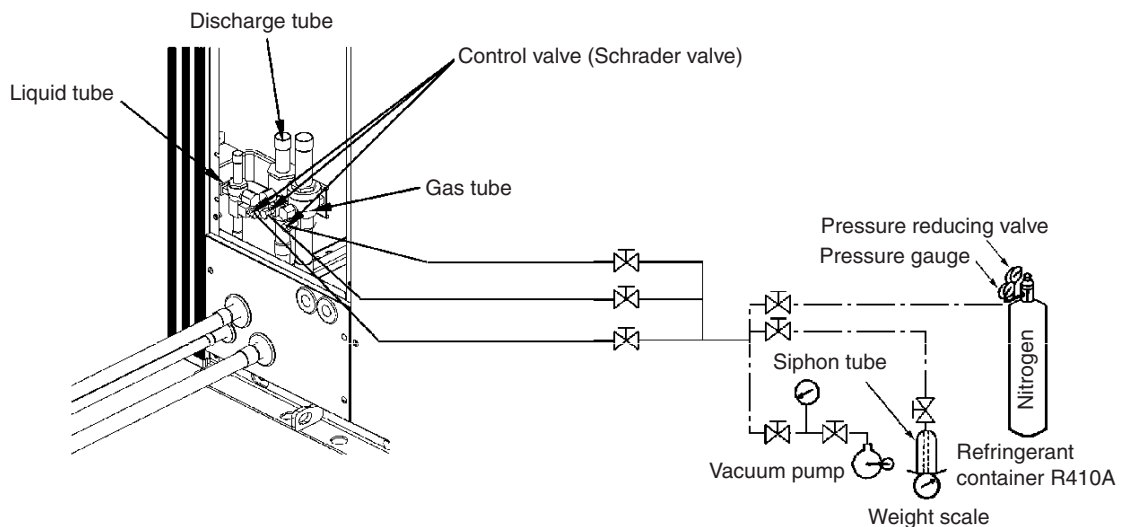

Figure 5

- When performing airtightness tests or creating vacuums, perform them for all service ports simultaneously. (All outdoor unit valves should remain closed.)  
Always use nitrogen for the airtightness test. (Do not use oxygen, carbon dioxide, other refrigerants, etc.)  
When performing the airtightness test for newly installed indoor/outdoor unit tubing, we recommend testing the tubes separately before connecting them to outdoor units.
- After the airtightness test is completed, apply vacuum of 667 Pa (-755 mmHg, 5 Torr) or below to the indoor unit and tubing.
- Do not leave for a long period of time after the vacuum state has been reached.

**CAUTION** The service ports are check valves.

### (4) Charging with additional refrigerant

The charge amount of refrigerant at the time of shipping from the factory is 11.5 kg. Add the necessary additional charge to the unit. The piping section has not been considered. Add additional refrigerant in accordance with the length of the piping.

For details on the charge amount of refrigerant, see the section "Calculation of the additional charge amount of refrigerant."

### (1) Wiring thickness and device capacity

- Wiring capacity (They must be provided by the installer.)

Unit area		Outdoor side	
		45.0 kW, 56.0 kW, 71.0 kW	85.0 kW
Contents		Single phase	Single phase
Switch capacity (A)		30	
Fuse capacity (A)		15	
Earth leakage circuit breaker	Capacity (A)	20	
	Leakage current (mA)	30	
	Operatin time (sec)	0.1	
Power cable (Metal piping, PVC piping)	Minimum power cable cross section area	2 mm <sup>2</sup> (17 m)	2 mm <sup>2</sup> (14 m)
	Length (Up to 25 m)	3.5 mm <sup>2</sup>	3.5 mm <sup>2</sup>
(Voltage drop standard: 2%)	(Up to 50 m)	8 mm <sup>2</sup>	8 mm <sup>2</sup>
	(Up to 75 m)	14 mm <sup>2</sup>	14 mm <sup>2</sup>
	(Up to 100 m)	14 mm <sup>2</sup>	14 mm <sup>2</sup>
Grounding wire cross section area		Equal or larger cross section of power cable	

### Control wiring

Inter-unit (between outdoor and indoor units) control wiring	Remote control wiring	Control wiring for group control
0.75 mm <sup>2</sup> (AWG #18) <b>Use shielded wiring</b>	0.75 mm <sup>2</sup> (AWG #18) <b>Use shielded wiring</b>	0.75 mm <sup>2</sup> (AWG #18) <b>Use shielded wiring</b>
Max. 1,000 m	Max. 500 m	Max. 500 m (Total)

- The value in parentheses beneath the minimum power cable thickness indicates the maximum cable length (m).
- The outdoor-side power cannot be wired across multiple units.
- The indoor-side wiring capacity is not included.  
Note that it is not possible to draw general power from the indoor side.
- When selecting an earth leakage circuit breaker for the power side, we recommend one that provides coordinated protection.
- The electrical installation shall comply with national and local wiring/installation requirements.
- This equipment complies with EN/IEC 61000-3-11 provided that the system impedance  $Z_{max}$  is less than or equal to the values corresponding to each model as shown in the table below at the interface point between the user's supply and the public system. Consult with the supply authority for the system impedance  $Z_{max}$ .

$Z_{max}$	0.33 $\Omega$
-----------	---------------

### (2) Electrical wiring system diagram

- For electrical wiring work, refer to the Electrical Wiring System Diagram (Fig. 1) and the electrical circuit diagram attached to the indoor unit. (2 WAY-type)

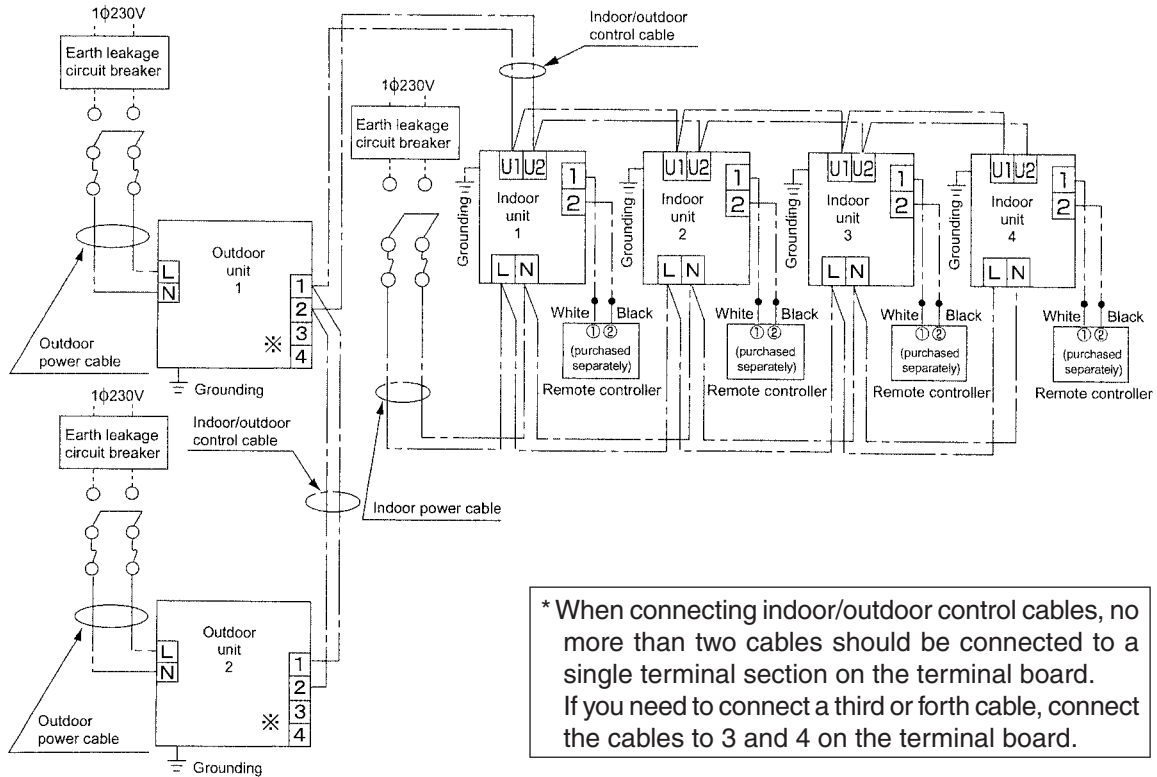

Fig. 1 Electrical Wiring System Diagram (2 WAY-Type)

### ● Operating power for the external hot water pump (2 WAY-type only)

The external pump is powered via screws 1 and 2 on the 2P terminal board of the outdoor unit's terminal box.

Output type: No-voltage A-contact (contact "closed" when external pump is operating and "open" when it is not operating)

Contact capacity: 220 V AC, 1A (cosθ=0.4)

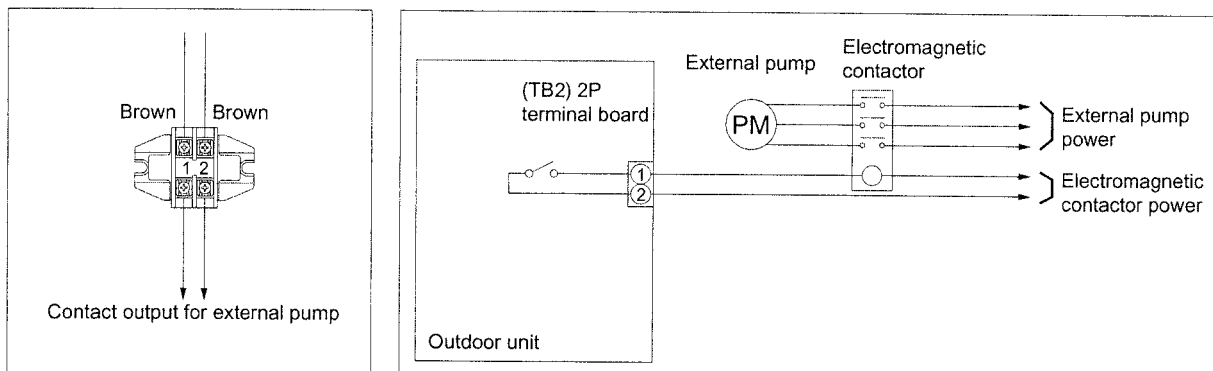

Fig. 2

(3) Precautions regarding electrical work

### Procedures and Technical Points for Electrical Wiring Work (Outdoors)

# Panasonic®

The following is instead for the installer responsible for outdoor electrical connections of this air conditioning system, and should be carefully read before beginning.

New Refrigerant R410A

- In addition, the following instruction manuals are attached for the indoor and outdoor units: “Procedures and Technical Points for Electrical Wiring Work (Indoors),” “Installation Instructions,” and “Test Run Procedures.” Be sure to refer to these manuals as necessary.

The Precautions given in this manual consist of specific “Warning” and “Cautions.” They provide important safety-related information and are important for your safety, the safety of others, and trouble-free operation of the system. Be sure to strictly observe all safety procedures. The labels and their meanings are as described below.



**WARNING**

This symbol refers to a hazard or unsafe practice which can result on severe personal injury or death.



**CAUTION**

This symbol refers to a hazard or unsafe practice which can result in personal injury or product or property damage.

### SAFETY PRECAUTIONS



**WARNING**

- Be sure to arrange installation from the dealer where the system was purchased or using a professional installer. Electric shock or fire may result if an inexperienced person performs any installation or warning procedures incorrectly.
- Only a qualified electrician shall connect this system, in accordance with the instructions given in “Engineering Standard Related to Electrical Equipment,” “Building Wiring Regulations,” and “Procedures and Technical Points for Electrical Wiring Work (Outdoors).” Electric shock or fire may result if electrical work is not correctly done.

### ELECTRICAL WIRING REQUIREMENTS

#### (a) Precautions regarding electrical wiring



**WARNING**

- Use a dedicated branch circuit for the power wiring. Do not share the branch circuit with any other electrical devices. Doing so may result in secondary damage occurring if the breaker is tripped.
- Use the specified power cables (type and wiring diameter) for the electrical connections, and connect the cables securely. Run and fasten the cables securely so that external forces or pressure placed on the cables will not be transmitted to their connection terminals. Overheating or fire may result if connections or attachment are not secure.



**CAUTION**

- For each device, install an overcurrent breaker of the designated capacity. If the wrong breaker is installed, there is danger of fire resulting from overheating or short circuit.
- For each device, install an earth leakage circuit breaker of the designated capacity. (Earth leakage circuit breaker rating: 30 mA, 0.1s or less)  
If an earth leakage circuit breaker is not installed, there is danger of electric shock or fire.
- Protective Earthing of the electrical installation shall comply with the national and local wiring/installation requirements.

- **This device includes an inverter. Use an earth leakage circuit breaker that is suitable for use with an inverter.**
- Fasten power cables and indoor/outdoor control cables inside the outdoor unit with wiring clamps. Be sure that they do not come in contact with any of the following:
  - (1) Engines, motors, fan blades, and other moving or high-temperature devices or fixtures
  - (2) Refrigerant tubing, pressure release tubes, or other parts of the refrigerant circuit
  - (3) Installation brackets or other sharp parts
- With the exception of single-phase models, if the external power phases are not correctly aligned, the system's reverse-phase detection function activates and causes the outdoor unit protection device to issue an alarm. ("P05" appears on the outdoor unit control panel.) If this occurs, reverse the two power source phases (polarity).
- Use signal cables for the communications cables (remote controller cables and indoor/outdoor control cables) which are identifiable as different from the power cables (AC230V). In addition, do not run the communications cables parallel to the power cables.
- Run the A/C power cables and communications cables at least 3 meters distant from any units, antennas, control cables, or power cables of televisions, radios, stereos, intercoms, computers, word processors, and similar devices.  
If they are less than 3 meters away, electrical noise interference may occur.

### Procedures and Technical Points for System Installation

# Panasonic®

The following is instead for the installer responsible for installation of this air conditioning system, and should be carefully read before beginning.

New Refrigerant R410A

- In addition, the following instruction documents are attached for the outdoor units: "Procedures and technical Points for Electrical Wiring Work (Outdoors)," and "Procedures and Technical Points for Test Run." Be sure to refer to these documents.

#### IMPORTANT!

#### Please Read Before Starting

This air conditioning system meets strict safety and operating standard. As the installer or service person, it is an important part of your job to install or service the system so it operates safely and efficiently.

#### For safe installation and trouble-free operation, you must:

- Carefully read this instruction booklet before beginning.
- Follow each installation or repair step exactly as shown.
- Observe all local, state, and national electrical codes.
- Pay close attention to all warning and caution notices given in this manual.



**WARNING**

This symbol refers to a hazard or unsafe practice which can result in severe personal injury or death.



**CAUTION**

This symbol refers to a hazard or unsafe practice which can result in personal injury or product or property damage.

#### If Necessary, Get Help

These instructions are all you need for most installation sites and maintenance conditions. If you require help for a special problem, contact our sales/service outlet or your certified dealer for additional instructions.

#### In Case of Improper Installation

The manufacturer shall in no way be responsible for improper installation or maintenance service, including failure to follow the instructions in this document.

#### SPECIAL PRECAUTIONS

##### **WARNING** When Wiring



**ELECTRICAL SHOCK CAN CAUSE SEVERE PERSONAL INJURY OR DEATH. ONLY A QUALIFIED, EXPERIENCED ELECTRICIAN SHOULD ATTEMPT TO WIRE THIS SYSTEM.**

- Do not supply power to the unit all wiring and tubing are completed or reconnected and checked.

- Highly dangerous electrical voltage are used in this system. Carefully refer to the wiring diagram and these instructions when wiring. Improper connections and inadequate grounding can cause **accidental injury or death**.
- **Ground the unit** following local electrical codes.
- Connect all wiring tightly. Loose wiring may cause overheating at connection points and a possible fire hazard.

#### When Transporting

Be careful when picking up and moving the indoor and outdoor units. Get a partner to help, and bend your knees when lifting to reduce strain on your back. Sharp edges or thin aluminum fins on the air conditioner can cut your fingers.

#### When Installing...

##### ...In a Ceiling or Wall

Make sure the ceiling/wall is strong enough to hold the unit's weight. It may be necessary to construct a strong wood or metal frame to provide added support.

##### ...In a Room

Property insulate any tubing run inside a room to prevent "sweating" that can cause dripping and water damage to walls and floors.

##### ...In Moist or Uneven Locations

Use a raised concrete pad or concrete blocks to provide a solid, level foundation for the outdoor unit. This prevents water damage and abnormal vibration.

##### ...In an Area with High Winds

Securely anchor the outdoor unit down with bolts and a metal frame. Provide a suitable air baffle.

##### ...In a Snowy Area (for Heat Pump-type Systems)

Install the outdoor unit on a raised platform that is higher than drifting snow. Provide snow vents.

#### When Connecting Refrigerant Tubing

- Use the frame method for connecting tubing.
- Apply refrigerant lubricant to the matching surfaces of the flare and union tubes before connecting them, then tighten the nut with a torque wrench for a leak-free connection.
- Check carefully for leaks before starting the test run.

### When Servicing

- Turn the power OFF at the main power box (mains) before opening the unit to check or repair electrical parts and wiring.
- Keep your fingers and clothing away from any moving parts.
- Clean up the site after you finish, remembering to check that no metal scraps or bits of wiring have been left inside the unit being serviced.

### Gas Supply Pressure

Gas Supply	Pressure(mbar)			Gas Supply	Pressure(mbar)		
G20, G25 (Natural Gas)	Min.	Normal	Max.	G31 (LPG)	Min.	Normal	Max.
	17	20	25		25	37	45

### Others



**CAUTION**

- Ventilate any enclosed areas when installing or testing the refrigeration system. Escaped refrigerant gas, on contact with fire or heat, can produce dangerously toxic gas.
- Confirm upon completing installation that no refrigerant gas is leaking. If escaped gas comes in contact with a stove, gas water heater, electric room heater or other heat source, it can produce dangerously toxic gas.

### NOTICE

- The English text is the original instructions. Other languages are translation of the original instructions.

## SAFETY PRECAUTIONS



**WARNING**

- Be sure to arrange installation from the dealer where the system was purchased or using a professional installer. If you attempt to perform the work yourself, and do so incorrectly, there is danger of poisoning caused by exhaust gases entering the building, as well as danger of water leakage, electric shock and fire.
- Installation work must be performed correctly, in accordance with the instructions listed here. Hazards from incorrect installation include dangerous exhaust gas buildup, water leakage, electric shock and fire.
- Check the type of engine fuel used. If the wrong type of gas is used, the engine can suffer combustion problems, and there is danger of poisoning caused by exhaust gases.
- Ventilate the area in case refrigerant gas leaks during installation work. If refrigerant gas comes into contact with frame during the tube brazing process, toxic gas will be produced.
- When installation work is completed, check that there is no refrigerant gas leakage. If refrigerant gas leaks into the room and contacts the frame of a fan heater, stove, burner, or other device, toxic gases will be produced.
- Never use (top up or replace) any refrigerant other than the specified refrigerant (noted on the nameplate). Doing so may cause a rupture in or breakdown of the device, or personal injury.
- When installing or moving the A/C unit, do not allow refrigerants other than the one specified (written on the label on the unit) or air to enter the unit's refrigeration cycle.
- Always use nitrogen for the airtightness test. (Do not use oxygen-based gases.)
- Never modify or repair the system yourself.



**CAUTION**

- When handling refrigerant gas, do not come in contact with the gas directly. Doing so may result in frostbite.
- Check that all provided parts are present.

### Provided documents:

- Remote power switch label
- Label showing the actual length of refrigerant tubing and amount of refrigerant charge
- Seal labels
- This manual ("Procedures and Technical Points for System Installation")
- "Procedures and Technical Points for Test Run"
- "Procedures and Technical Points for Electrical Wiring Work (Outdoors)"



### 1. SELECTING THE INSTALLATION LOCATION

- (1) Install the gas heat pump A/C so that it satisfies all local regulations and government safety codes, as well as installation standards and service guidelines for industrial gas devices.
- (2) Choose a suitable installation location (with adequate space for servicing), as below.



#### WARNING

- Install the outdoor unit in a location where exhaust gases will not enter the building's air intake or exhaust vents or windows, and will not enter the building through tubes or vents that lead inside the building. There is danger of poisoning if exhaust gases enter the building.
- Install the outdoor unit outdoors, in a location open to the air, so that there is no accumulation of exhaust gases. There is danger of the gases entering the building and causing poisoning.
- The exhaust gases must be open to the air in a location where they will not adversely affect the surroundings. There is danger of exhaust gases entering the building and causing poisoning. (Be certain not to allow exhaust gases to be discharged into a drainage basin, gutter, or similar location.)
- Install the outdoor unit securely in a location that can fully bear the weight of the unit. There is danger of gas leakage or injury if the outdoor unit tips over or falls.



#### CAUTION

- When installing outdoor units, bear in mind the need of space for maintenance. Check with Fig. 1 and make sure there is enough space.  
If you fail to ensure enough space, it may result in injury from falling while performing maintenance work.
  - If the outdoor unit is installed on a roof or other elevated location, install a permanent ladder, handrails, and other necessary items in the passageway leading up to the unit, and install a fence, handrails, or similar structure around the outdoor unit. If such protections are not installed, an injury from falling while working may result.
  - Be sure to stand on a stable surface when installing the outdoor unit on an elevated base or location, and avoid using stepladders.
  - Leave the distances shown in Fig. 2 between the outdoor unit and any flammable materials. There is danger of fire if these distances are insufficient.
  - Do not install the outdoor unit in a location where flammable gases may be generated, flow, accumulate or leak, or in a location where volatile substances are handled or stored. There may be danger of fire or explosion if the unit is installed in such a location.
  - Install the outdoor unit in a location where exhaust gases and fan air will not harm plants or animals. The exhaust gases and fan air may adversely affect plants and animals.
  - Avoid installation near locations such as parking lots and flowerbeds where damage from clinging dust and particles may occur. If installation in such locations is unavoidable, be sure to put a covering on the outdoor unit or take other measures to protect it.
- In addition to heeding the WARNING and CAUTION notes, avoid installation in locations where the unit will be exposed to the following:
    - excessive dust
    - excessively salty air, such as near the sea
    - sulfuric gases, such as near hot springs
    - excessive water, vapors, or oil fumes (ex: from machines)
    - fumes from organic solvents
    - high fluctuations in power voltage
    - electromagnetic interference from other devices
  - In order to improve heat exchange, install the outdoor unit in a location that is well ventilated. Provide maintenance space and separation from flammable materials as per Figs. 1 and 2.  
If installing in a poorly ventilated location, or if installing multiple outdoor units, ensure sufficient space to prevent short circuits.



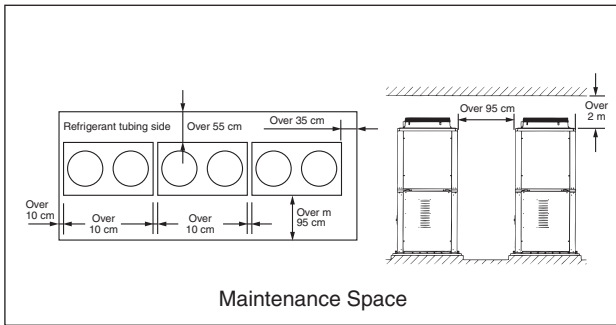

Fig. 1

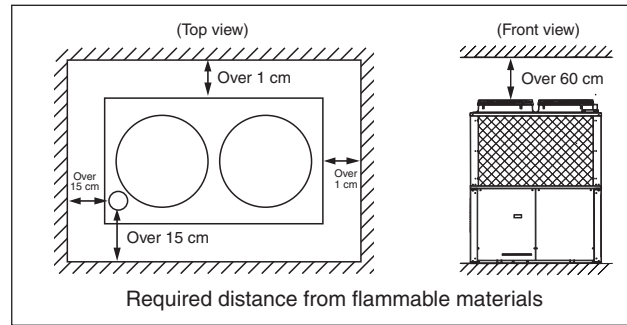

Fig. 2

- (3) In snowy regions, be sure to install a snow-protection hood and enclosure.  
Even in regions that do not have heavy snowfall, install a snow-protection roof (such as a snow hood) if the unit is installed in a location where snow may build up and fall from the building's roof or other surface onto the unit. (Install the hood so that the coolant supply opening at the top of the unit can be used.)
- (4) Take care that operating noise and exhaust do not disturb neighboring buildings or homes.  
In particular, install so that noise-related local environmental standards, if any, are satisfied at the border with a neighboring dwelling.
- (5) Because this gas heat pump A/C may affect other electrical devices with noise, give due consideration when installing AC units (both indoors and outdoors) at enough distance (at least 3 m) from the main unit of TVs, radios, stereos, intercoms, PCs, word processors, telephones, etc., as well as their antenna cables, signal wires, power cords, etc.
- (6) Select an installation location so that the length of refrigerant tubing is within the ranges shown in the table below.

Table 1 Ranges for Refrigerant Tubing Length and Installation Height Difference

Category	Symbol	Description	Tubing length (m)
Allowable tubing length	L1	Max. allowable tubing length	≤170 (equivalent length 200)
	$\Delta L=(L2-L4)$	Difference between longest and shortest tubing lengths after the No. 1 branch (first branching point)	≤70
	LM	Max. length for main tube (tube with widest diameter)	$7 \leq LM \leq 120$
	$\ell 1, \ell 2, \dots, \ell 48$	Max. length for each tube branch	≤30
	L5	Distance between outdoor units	≤7
Allowable height difference	H1	Max. height difference between indoor and outdoor units	If outdoor unit is above ≤50 If outdoor unit is below ≤35 <sup>(*1)</sup>
		H2	Max. height difference between indoor units
	H3	Max. height difference between outdoor units	1
Allowable length for branched tubing (header branch)	L3	Max. length between first T-tee branch (provided by installer) and the closed tube end	≤2

(\*1) If cooling mode is expected to be used when the external temperature is 10°C or below, the maximum length is 30 m.

(\*2) The max/min permissible height between indoor units ( $\alpha$ ) is found by the difference ( $\Delta L$ ) between the maximum length and the minimum length from the first branch.

$$\alpha = 35 - \Delta L / 2 \text{ (however, } 0 \leq \alpha \leq 15 \text{)}$$



- The grouping of tubes that connect the outdoor units to the indoor units is referred to as the “main tubing.”

When the maximum tubing length is more than 90 m (equivalent length), upgrade the tube size 1 rank for both the liquid and gas tubes of the main tubing.  
The prescribed performance cannot be guaranteed if the wrong size is selected.

**Table 1-2 Outdoor tubing/main tubing size** \*1, \*2

	Outdoor tubing				Main tubing					
	Outdoor unit (gross) capacity (kW)									
	45	56	71	85	90	101	112	116	127	142
Gas tube (mm)	Ø28.58 (Ø31.75)				Ø31.75 (Ø38.1)			Ø38.1		
Liquid tube (mm)	Ø12.7 (Ø15.88)	Ø15.88 (Ø19.05)			Ø19.05 (Ø22.22)					

- \*1 If there are plans for future expansion, choose plumbing sizes according to the total capacity after such expansion. However, if tube size is stepped up 3 levels, expansion is not possible.
- \*2 If the maximum tube length exceeds 90 m (or equivalent length), use the figure in parentheses ( ) to size the main tubing, along with those of the liquid and gas tubes.  
However, size the gas tube only up to Ø38.1. (A reducer has to be fitted on-site)

**Table 1-3 Main tube size after branching** \*1, \*2

	When indoor unit(s) are connected				Main tube after branching						
	Post-branching indoor unit capacity (kW)*3										
	- 5.6	- 16.0	- 22.4	- 28.0	- 16.0	- 28.0	- 35.5	- 45.0	- 71.0	- 101.0	Over 101.0
Gas tube (mm)	Ø12.7	Ø15.88	Ø19.05	Ø22.22	Ø15.88 (Ø19.05)	Ø22.22 (Ø25.4)	Ø25.4 (Ø28.58)	Ø28.58 (Ø31.75)		Ø31.75 (Ø38.1)	Ø38.1
Liquid tube (mm)	Ø9.52				Ø9.52 (Ø12.7)		Ø12.7 (Ø15.88)		Ø15.88 (Ø19.05)	Ø19.05 (Ø22.22)	

- \*1 Select a diameter for the main tubing after a branch that is no larger than that of the header. (In cases where the main tubing after a branch would have to be larger than the header tubing, select tubing of the same size, and never exceed the header size.)
- \*2 If the maximum tube length exceeds 90 m (or equivalent length), use the figure in parentheses ( ) to size the main tube after branching, along with those of the liquid and gas tubes.  
However, size the gas tube only up to Ø38.1.
- \*3 “- \* ” in the table above means “\*\* kW or less”.

**Table 4 Branch/Header Tube Selection**

Use the following branch tubing sets or tubing sets for branching the system's main tube and indoor unit tubing.

Capacity after branch	Branch tube size (*1)		Branch tube number		
	Gas tube (mm)	Liquid tube (mm)	Branch tubing		
			APR-P160BG	APR-P680BG	APR-P1350BG
Over 72.8 kW	Ø31.75	Ø19.05	—	—	•
Over 45.0 kW to 72.8 kW	Ø28.58	Ø15.88	—	•	•
Over 35.5 kW to 45.0 kW	Ø28.58	Ø12.7	—	•	•
Over 28.0 kW to 35.5 kW	Ø25.4	Ø12.7	—	•	•
Over 16.0 kW to 28.0 kW	Ø22.22	Ø9.52	—	•	•
Over 5.6 kW to 16.0 kW	Ø15.88	Ø9.52	•	•(*3)	•(*3)
5.6 kW or below	Ø12.7 (*2)	Ø9.52	•	•(*3)	•(*3)

(\*1) Make a selection so as not to exceed the main tubing size.

(\*2) Even when 5.6 kW or below, make the gas tube diameter Ø15.88 if 2 or more indoor units are connected after branching.

(\*3) As the tube diameter for the supplied reducer does not match, another reducer must be provided by the installer.

**Table 5 Tubes Connecting Outdoor Units and Indoor Units**

Outdoor Units

Tubing connecting to outdoor units (tA to tB)	Unit type	45.0 kW	56.0 kW	71.0 kW	81.0 kW
	Equivalent horsepower		16	20	25
Tube size	Gas tube (mm)	Ø28.58			Ø31.75
	Liquid tube (mm)	Ø12.7	Ø15.88		Ø19.05

Indoor Units

Tubing connecting to indoor units (tA to tB)	Unit type	22	28	36	45	56	71	80	90	112	140	160	224	280
	Equivalent horsepower		0.8	1	1.3	1.6	2	2.5	3	3.2	4	5	6	8
Tube size	Gas tube (mm)	Ø12.7						Ø15.88			Ø22.22	Ø25.4		
	Liquid tube (mm)	Ø6.35				Ø9.52				Ø12.7				

Note: Keep the maximum length between t1 to t48 within 30 m.

### Gas trip-valve kit (SGP-VK32K)

As shown in Fig. 6, install the gas trip-valve kit between the outdoor unit and refrigerant gas tube (wide) of the main tubing.

\* Refer to "7. USING A VIBRATION-RESISTANT FRAME" when using a vibration-resistant frame.

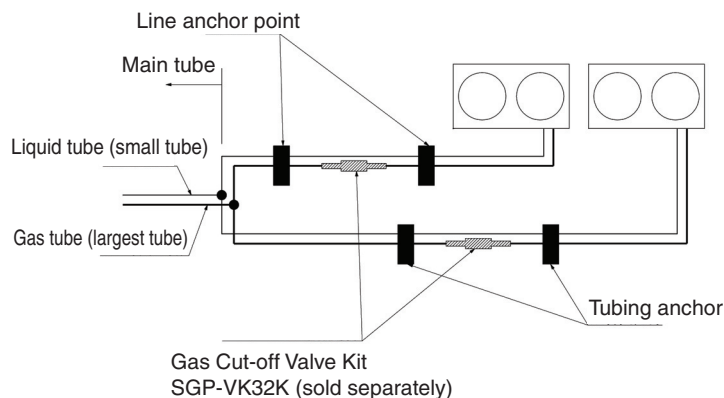

Fig. 6

(7) Check the room limit concentration



**WARNING**

The refrigerant (R410A) used in a multi-unit air conditioning installation is in itself a safe refrigerant that is neither flammable nor poisonous, but just in case a leak in a small room should occur, steps need to be taken to prevent gas from exceeding the permissible concentration and causing asphyxiation. The Japan Refrigeration and Air Conditioning Association have stipulated a threshold concentration for refrigerants in its publication “Guidelines for Ensuring Safety in the Event of a Refrigerant Leak from a Multi-Unit Air Conditioning System” (JRA GL-13:2010).

Apart from the lowest level underground, the threshold concentration for the charge in a system has been set to

total refrigerant/living space capacity  $\leq 0.42 \text{ kg/m}^3$  (R410A models).

If this condition is not met, the system must either be equipped with two of the countermeasures (alarm, ventilation or safety shut-off valve) or be redesigned.

Please note, when the system is in the lowest level underground, depending on the type of refrigerant, the threshold concentration and number of countermeasures required may vary.

For further details, either refer to the technical document JRA-GL-13 or consult with your dealer.

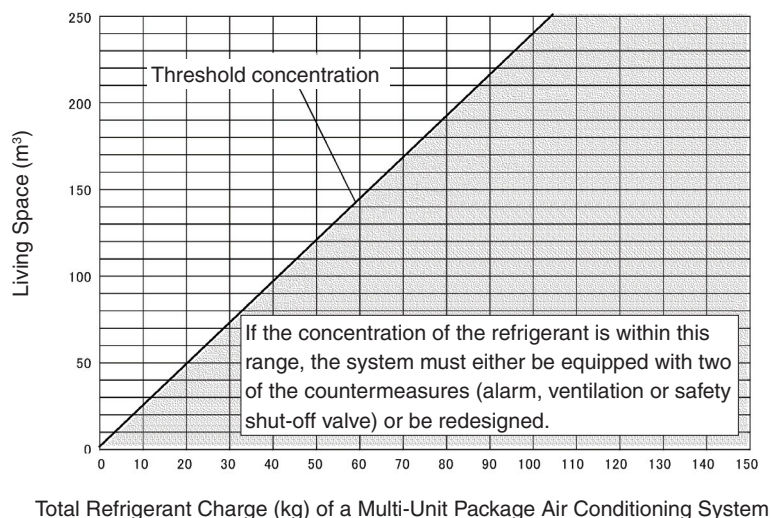

**Fig. 7 Permissible Refrigerant Charge for Specific Systems and their Required Countermeasures (R410A Refrigerant)**  
**<Not Including Lowest Level Underground>**

### 2. PRECAUTIONS FOR INSTALLATION WORK

#### (1) Foundation construction



**WARNING**

- The foundation for the outdoor A/C unit must be made of concrete or similar material, and must be sturdy and level, with good drainage. Imperfections may cause the outdoor unit to turn over, resulting in gas leakage and/or injury.
- Use a level to make sure the foundation is level. If level is not maintained, it may result in a breakdown.
- When installing the outdoor unit, be sure to use the specified size of anchor bolts (shown in Fig. 8) and anchor the unit security. Failure to do so may result in the outdoor unit tipping over, causing gas leakage and personal injury.
- Spread a vibration-resistant mat over the surface where the bottom of the outdoor unit contacts the ground, so that the load is applied evenly. Use rubber bushings and anchors in such a way does not diminish the vibration-resistant effects.

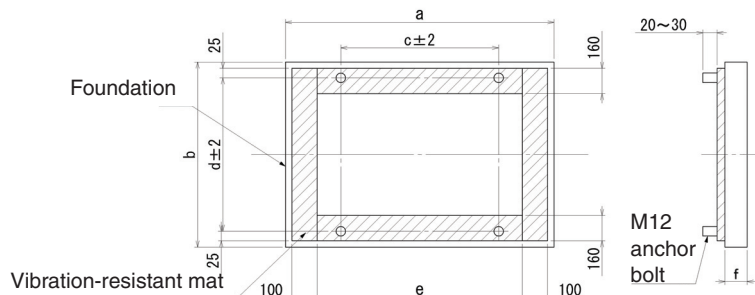

Unit: mm

Fig. 8 Foundation diagram (mat foundation)

Table 6

		a (mm)	b (mm)	c (mm)	d (mm)	e (mm)	f (mm)	
45.0/56.0/ 71.0 kW	Installation on ground	1,700 or more	1,170 or more	1,000	1,040	1,450	120 or more	
	Installation on roof	Without vibration-resistant frame	1,850 or more				2,000 or more	140 or more
		With vibration-resistant frame (single type)	2,000 or more					
	With vibration-resistant frame (interlocking type)	1,850						
85.0 kW	Installation on ground	1,700 or more	1,170 or more	1,000	1,040	1,450	120 or more	
	Installation on roof	Without vibration-resistant frame	1,850 or more				2,000 or more	140 or more
		With Vibration-resistant frame	2,000 or more					

Unit: mm

- Be sure to take the following steps to prevent shifting of the foundation.
  - A mat foundation that is simply placed on a floor slab (A-a type) must be of the dimensions shown in the Table 3 or larger in order to prevent shifting of the foundation in case of earthquake. If the mat foundation is smaller than these dimensions, take steps such as connecting the foundation and the building structure with reinforcing bars, in accordance with building utilities earthquake-resistant design and construction guidelines. Foundation types A-b, A-c, A-d, and A-e are provided as examples.
- Use one of the following types of anchors. Use bolts of size M12 or larger for all bolts.
  1. Embedded-type: L-type, LA-type, headed bolts, J-type, JA-type
  2. Blockout-type: L-type, LA-type, headed bolts, J-type, JA-type (Make dimension "f" of the foundation 180 mm or more.)
  3. Plastic anchor
  4. External-thread type mechanical anchor

**CAUTION: Do not use an internal-thread type mechanical anchor.**



- If you wish to reduce the foundation weight when installing on a roof, use a light-weight foundation that utilizes a suitable steel frame (for more information, please contact sales office)  
The light-weight foundation is in accordance with building utilities earthquake-resistant design and construction guidelines. For construction, follow the installation instructions from the manufacturer supplying the steel frame.

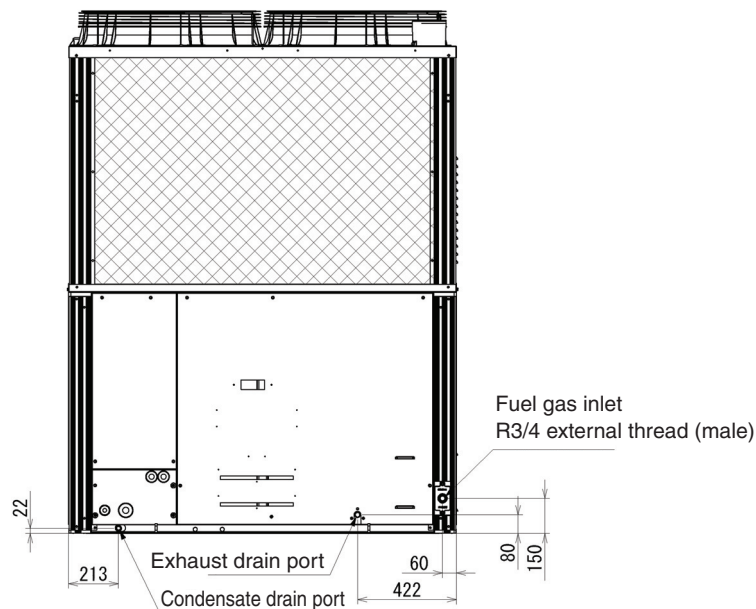

Unit: mm

Fig. 9

### (2) Fuel piping work

As needed, attach devices ②, ③ or ⑤ to the outdoor unit external fuel gas pipe. (Fig. 10)

① Flexible gas hose ② Pressure release tap ③ Strainer ④ Master valve ⑤ Pipe bracket

A main valve must be installed for servicing the fuel gas tube.



- Use a reinforced gas hose or a low-pressure gas hose with fuel gas joint bracket between the fuel gas pipe master valve and the outdoor unit. In addition, avoid excess pressure or shock to the outdoor unit's fuel gas inlet by taking measures such as making the pipe path leading up to the gas hose as short as possible. Otherwise, there is danger of fire resulting from fuel gas leakage.
- If necessary, install pipe brackets in the fuel gas pipe path to reduce the risk of pressure or shock to the pipe path. In particular, take sufficient precautions when installing near roads. There is a danger of fire or explosion resulting from fuel gas leakage.  
\* In regions with heavy snowfall, take precautions to protect the fuel gas pipe path from snow damage (Fig. 11).
- After installation work is completed, check that there is no gas leakage from the fuel gas pipe/hose path. There is danger of fire resulting from fuel gas leakage.
- To ensure safety in case of a gas leak, make sure that airflow surrounding the outdoor unit is sufficient and gas will not accumulate. Accumulation of gas may result in fire or explosion.

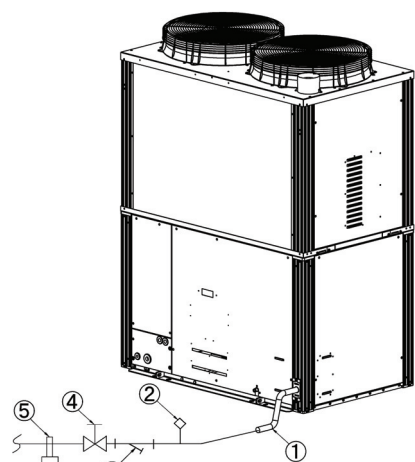

Fig. 10 Fuel Pipe Structure Diagram

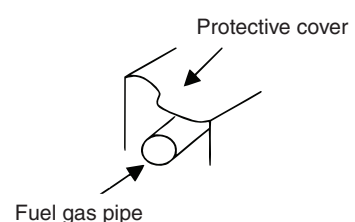

Fig. 11 Fuel pipe protection example

### (3) Exhaust drain pipe work



#### WARNING

- If connecting the outdoor unit's exhaust drain to a covered drainage basin or gutter, or draining multiple outdoor units to the same location, be sure to configure the pipes (as shown in Fig. 13) so that exhaust gases are discharged into open air. (Make sure that the opening in the receiving drain pipe is at least 50A in nominal diameter.) Exhaust gases flowing into the building or indoor/outdoor units may result in poisoning or corrosion of the unit.
- If a pipe is used for outdoor unit exhaust draining, do not use the same pipe for other purposes (condensate draining for outdoor units, indoor unit draining, etc.). Exhaust gases flowing into the building or indoor/outdoor units may result in poisoning or corrosion of the unit.



#### CAUTION

- If installing the outdoor unit on a roof, extend the exhaust drain pipe to the water drain (as shown in Fig. 13).  
**PROHIBITED: Do not install the drain pipes so they drain directly onto concrete surfaces, waterproof sheets, or metal roofing. Doing so may result in discoloring of concrete and metal surfaces, damage to waterproof sheets, holes, and other damage.**
- Fasten the exhaust drain hose (included) with a hose clamp.  
If the exhaust drain hose leaks, it may cause corrosion to the equipment.
- When installing the exhaust drain hose (included) and plumbing the exhaust drain water tube, take care that it is not blocked from bending/smashing the exhaust drain hose.  
If the exhaust drain hose is blocked, it will result in poor engine combustion and may lead to an equipment breakdown.
- Slope the drain pipe at a gradient of 1/50 or more, and do not taper the pipe diameter (Fig. 12, 13). In addition, do not create any traps or peaks in the pipe.
- If connecting multiple outdoor units to a single exhaust drain pipe, be sure to prevent exhaust gases from flowing backward by allowing the gases to discharge into open air where the drain hose enters the drain pipe (with the drain pipe opening at least 50A in nominal diameter). Exhaust gases flowing back into the outdoor units while they are stopped may result in starting failures, engine stalls, corrosion of the unit, and other problems. In addition, take measures to prevent drain water from splattering in locations where wind is strong.
- In cold regions where the exhaust drain pipe is likely to freeze, wrap heat tape or take other measures to prevent freezing.
- Use PVC or stainless steel tubing for the exhaust drain pipe.
- As condensed water drips from the unit, be sure to install it in a location with good drainage. (Tubing for the condensate drain port (Fig. 9) is not necessary, but follow the above precautions if tubing is installed.)  
\* Condensed water from the refrigerant tubing inside the unit is released through the condensate drain port. Condensed water from the heat exchanger and water that gets inside the unit is released through the drainage ports located at the center of either side panel.

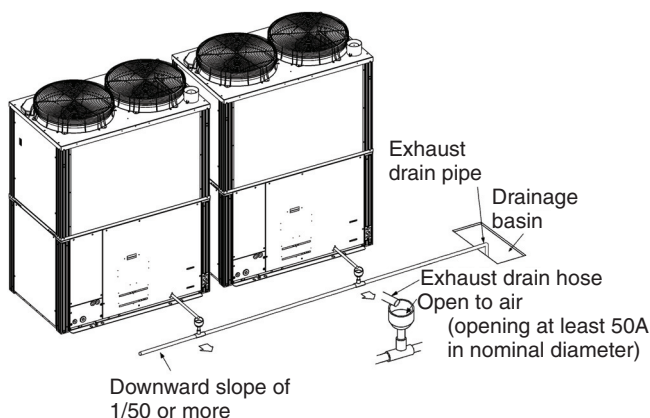

Fig. 12 Draining the exhaust into a drainage basin

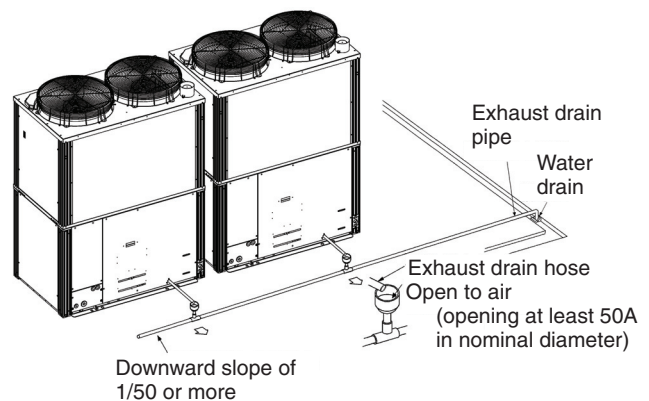

Fig. 13 Draining the exhaust into a water drain (roof)



### 3. INSTALLATION PROCEDURE

#### 3-1. Anchoring the outdoor unit

Transporting the outdoor unit by hoist:

- For hoisting, pass the rope over the hoisting brackets on the unit vase at 4 locations. (Fig. 14)
- Insert wood separators as protective shielding when using the hoist to prevent the outer casing from being scratched or deformed by the rope. Be sure not to touch or apply pressure on tube connectors. (Fig. 14)
- When hoisting with a crane, the crane hook position must be 1 m or more above the unit.

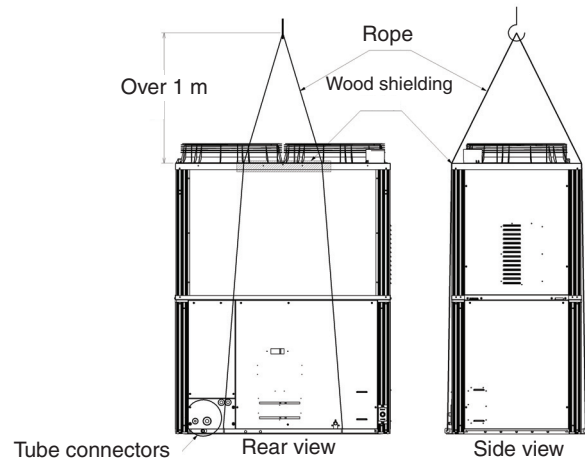

Fig. 14



**CAUTION**

- **Do not lay the outdoor unit on its side during transportation. This can damage the devices and result in malfunction.**

#### 3-2. Preparing and installing the tubing

- Material: Phosphorous deoxidized copper seamless tubing (C1220T)
- Tubing size: Choose tubing sizes according to tables 1-2, 1-3, 1-5, and 2-2 to 2-4.  
Use tube with thickness as per Table 7.

Table 7

Tubing size (mm)		
Exterior diameter	Wall thickness	Type
Ø9.52	T0.8	O
Ø12.7	T0.8	
Ø15.88	T1.0	
Ø19.05	T1.0	1/2 H or H
Ø22.22	T1.0	
Ø25.4	T1.0	
Ø28.58	T1.0	
Ø31.75	T1.1	
Ø38.1	T1.35	

- After cutting the tube, be sure to remove all burrs and finish tubing ends to the correct surface. (The same must be done for branch tubes (purchased separately).)
- When bending tubes, be sure the bend radius is at least 4 times the outer diameter of the tube.
- When cutting or bending tubes, be careful not to cause any pinching or blockage of the tube.

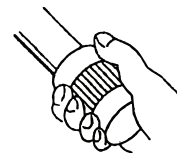

Fig. 15



**CAUTION**

- **Prevent foreign substances such as dirt or water from entering the tube by sealing the end of the tubes with either a cap or with tape. Otherwise, this can damage the devices and result in malfunction.**

### 3-3. Connecting the refrigerant tubing

1. Remove the rubber washers on the gas and liquid tubes from the pipe connection panel.
2. Connect the tubes and perform brazing.
3. Reattach the gas tube, liquid tube fastening panel, and fastening rubber as they were originally.

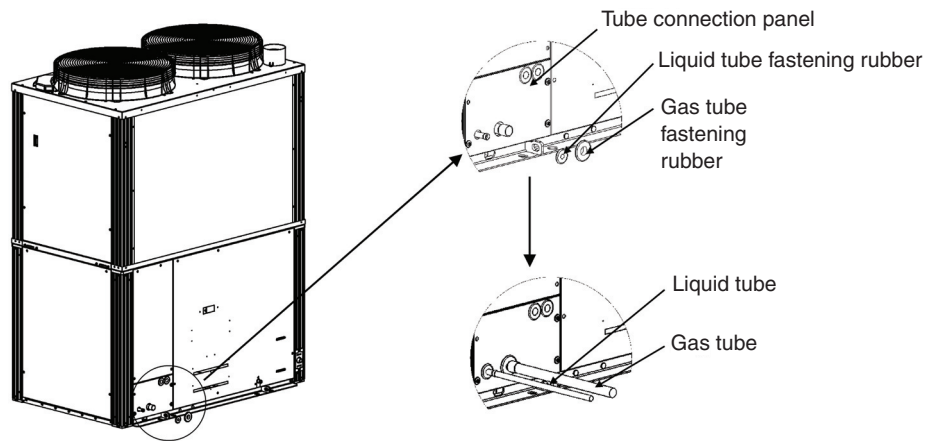

Fig. 16

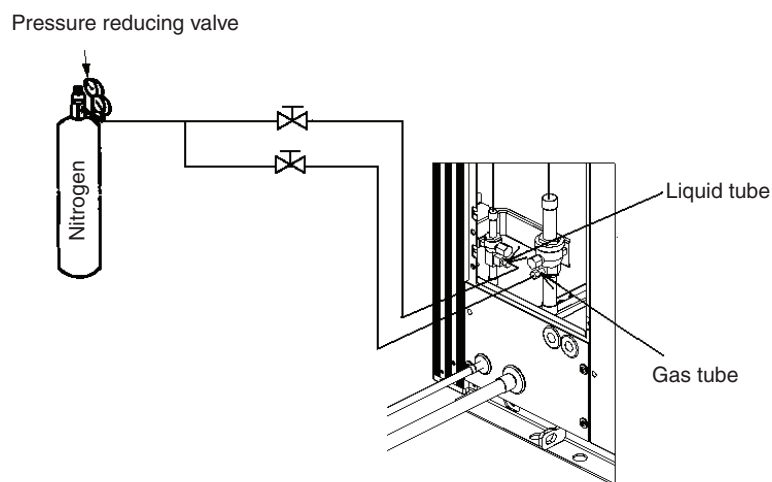

Fig. 17



#### Be sure to perform the following before brazing.

- The rubber that fastens the tubes is damaged easily by heat. Be sure to remove it before brazing.
  - Cool the tubes with wet cloths or other materials to prevent the value inside the machine from being damaged by the brazing heat.
  - Be sure to replace the contents of the tube with nitrogen to prevent the formation of an oxide film. (Oxygen, carbon dioxide or refrigerant may not be used)
  - Do not use commercially available oxide film agents (antioxidants). They can adversely affect the refrigerant and the refrigeration oil, and can cause malfunctions.
  - If using flare connections (for the indoor connectors or other part), apply refrigeration oil to the flared part.
- \* With a 3-way multi system, there will be 3 tubes. Treat each of the tubes in the same way.

### 3-4. Tubing airtightness test and vacuum application

An airtightness test is required for gas heat pump A/C as part of industry installation guidelines. Follow the procedure below to perform the test and confirm there is no leakage from any connections.

- Connect the manifold gauge to both service ports - on the wide tube side and narrow tube size. Then connect the nitrogen tank, vacuum pump, and other items as shown in Fig. 18.

#### CAUTION

Connect an R410A control valve (Schrader valve) at the service port for the shut-off valve.

If an R410A control valve (Schrader valve) is not connected, it may cause a frost burn due to refrigerant leaking when the charge hose is removed.



#### CAUTION

Use nitrogen to raise the pressure to the airtightness test pressure (4.15 MPaG) and confirm that there is no leakage. Refrigerant leakage can cause suffocation and injury to nearby persons.

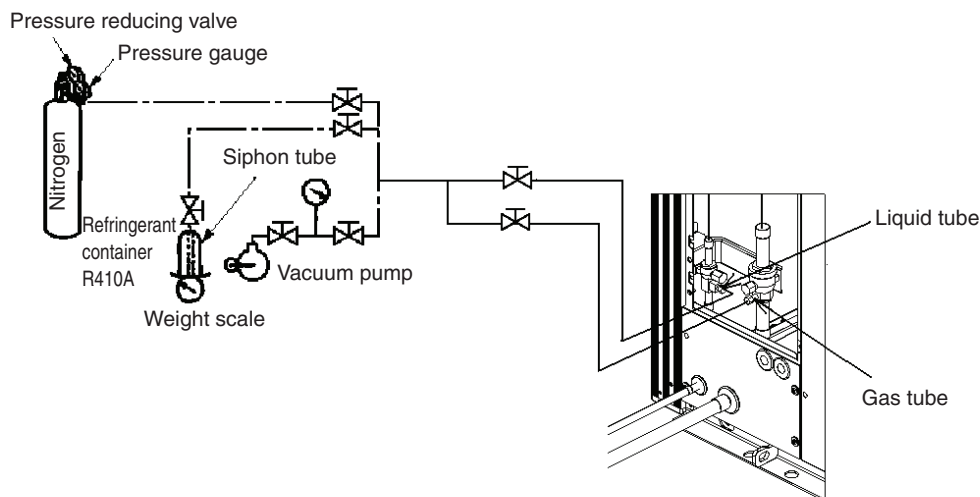

Fig. 18

- When checking for air/vacuum tightness, do so at all service ports at the same time. (With all the valves to the outdoor units closed.)  
Always use nitrogen when performing air tightness checks.  
(Oxygen, carbon dioxide or refrigerant may not be used)  
When performing air tightness checks on the tubes between indoor/outdoor units, we recommend doing so on the tubes independently, prior to connecting outdoor units.
- After the airtightness test is completed, apply vacuum of 667 Pa (-755 mmHg, 5 Torr) or below to the indoor unit and tubing.
- Do not leave for a long period of time after the vacuum state has been reached.

#### CAUTION

There is a check valve at each service port.

\* With a 3-way multi system, there will be 3 tubes. Treat each of the tubes in the same way.

### 3-5. Refrigerant charge

#### Calculation of amount of additional refrigerant charge

- Table 6 shows the refrigerant charge at factory shipping time. Additional refrigerant must be added according to the size and length of the tubing. If a water heat exchanger unit is installed, provide an additional refrigerant charge for the connecting line portion. (Use the values in Table 5 to calculate liquid tube size and length.)

**Table 8 Quantity of additional refrigerant charge**

Liquid tube size (mm)	Additional charge quantity per meter (g/m)
Ø6.35	26
Ø9.52	56
Ø12.7	128
Ø15.88	185
Ø19.05	259
Ø22.22	366

**Table 9**

Type	Quantity of refrigerant charge when shipped (kg)
45.0 kW	10.5
56.0 kW	11.5
71.0 kW	
85.0 kW	

$$\text{Required additional refrigerant charge (g)} = 456 \times (A) + 366 \times (B) + 259 \times (C) + 185 \times (D) + 128 \times (E) + 56 \times (F) + 26 \times (G) + \text{Unit additional charge amount (H)}$$

- (A) = total length in meters of 25.4 mm diameter liquid tubing
- (B) = total length in meters of 22.22 mm diameter liquid tubing
- (C) = total length in meters of 19.05 mm diameter liquid tubing
- (D) = total length in meters of 15.88 mm diameter liquid tubing
- (E) = total length in meters of 12.7 mm diameter liquid tubing
- (F) = total length in meters of 9.52 mm diameter liquid tubing
- (G) = total length in meters of 6.35 mm diameter liquid tubing
- (H) = Unit additional charge amount (Table 7)

**Table 10**

Type	Unit additional charge amount (kg)
45.0 kW	–
56.0 kW	0.5
71.0 kW	2.5
85.0 kW	11.0 <sup>*1</sup>

<sup>\*1</sup> When connecting a water heat exchange unit, the value is 10.0 kg.

- Be careful to charge accurately according to refrigerant weight.
- Charging procedure
  - Evacuate the system, close the gauge manifold at the gas tube side to ensure that no refrigerant enters the gas tube side, then charge the system with liquid refrigerant at the liquid tube side. While charging, keep all valves fully closed. The compressor can be damaged if liquid refrigerant is added at the gas tube side.
- If the system does not accept the predetermined quantity of refrigerant, fully open all valves and run the system (either heating or cooling). While the system is running, gradually add refrigerant at the low pressure side by slightly opening the valve on the cylinder just enough so that the liquid refrigerant is gasified as it is sucked into the system. (This step is normally only needed when commissioning the system.)
  - All outdoor unit valves should be fully open.
- When charging is completed, fully open all valves.
- Avoid liquid back-flow when charging with R410A refrigerant by adding small amounts at a time.

### CAUTION

- When charging with additional refrigerant, use liquid only.
- R410A cylinders are colored gray with a pink top.
- Check whether a siphon tube is present (indicated on the label at the top of the cylinder).
- Depending on refrigerant and system pressure, conventional refrigerant (R22, R407C) equipment may or may not be compatible with R410A equipment, so care is needed. In particular, the gauge manifold used must be specifically designed for R410A.
- Be sure to check the limiting density.
- Refer to the section “4. OPENING THE CLOSED VALVES” (→ page 17) when the instructions call for fully opening all valves.

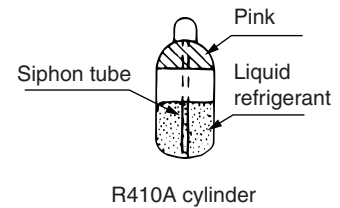

### 3-6. Finishing the outer tubing covering



### CAUTION

- Insulate absolutely all of the tubes to units, including branch tubes. The surface of insulating materials is subject to condensation, especially in a hot, humid environment, so choose insulation that is thick enough, as per JIS A 9501. Further, fill in any gaps to prevent moisture from getting in at the ends and joints of the insulation. If not enough insulation is used, it may result in leaking or dripping water. The criteria for selecting insulation are provided in the installation planning guide, so refer to it in selecting materials. Use insulation for gas tubes that is heat resistant to at least 120°C and at least 80°C for liquid (and suction tubes) tubes.
- Use separate piping for the power cables and the control cables. If the cables are passed through the same pipes, the effects of electrical noise and induction can cause malfunctions.

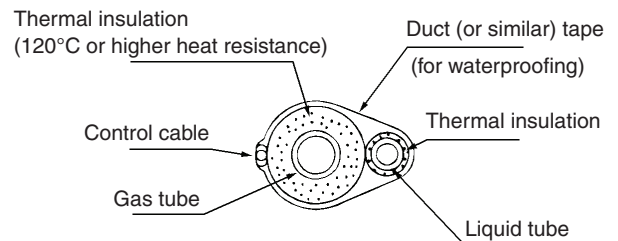

### 3-Way Multi 3-tube Side

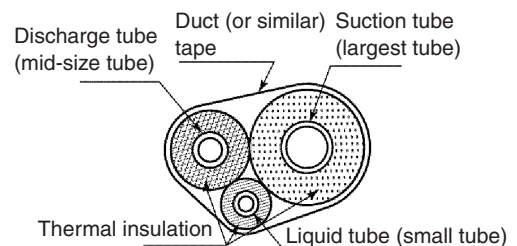

Fig. 19

## 4. OPENING THE CLOSED VALVES

Ball valves are used for the closed valves on the outdoor unit. Each can be opened and closed by rotating the tab 90 degrees.

Follow the procedure below to securely open the valves.

1. Remove the cap.
2. Slowly and securely turn the tab to the left (counterclockwise) 90 degrees. The valve is fully open when the tab has been rotated 90 degrees (when it contacts the stopper). Do not forcefully attempt to turn the tab past this point.

### CAUTION

Be sure to open the closed valve all the way.

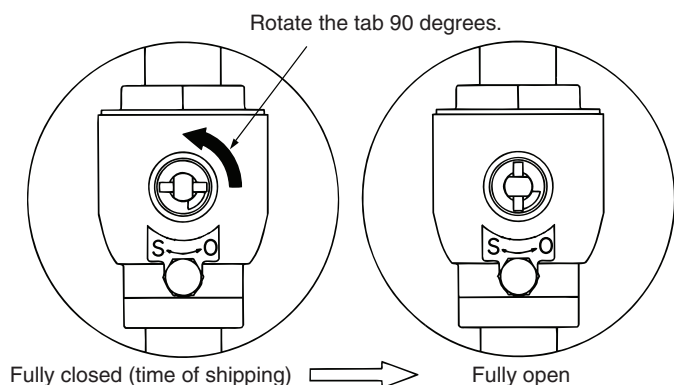

Fig. 20 Rotating the Tab

### 3. Reattach and tighten the cap.

- Cap tightening torque
 

Liquid side (45.0 kW)	13 N·m
Liquid side (56.0 - 85.0 kW)	30 N·m
Gas side (45.0 - 85.0 kW)	30 N·m
  
- <3WAY>
 

Liquid side	13 N·m
Suction gas side	30 N·m
Discharge gas side	30 N·m

### 5. AFTER INSTALLATION IS COMPLETED

- Record the actual length of refrigerant tubing and the amount of refrigerant charge. With the outdoor unit, the “label for showing the actual length of refrigerant tubing and the amount of refrigerant charged” is provided. Enter the details in the designated spaces, and apply the label to the inside of the electrical box panel, at the top.

**This will be needed for subsequent maintenance.  
Be sure to enter this information and apply the label.**

### 6. ENGINE REPLACEMENT PATHWAY

- During installation, consider the engine external dimensions listed at right and ensure that there is a sufficient pathway for moving the engine. This pathway will be required should the engine need to be replaced.

**Table 11**

Engine external dimensions (mm)			Package weight (kg)
Width	Depth	Height	
670 (810)	640 (760)	650 (700)	170

\* Figures in parentheses are the external dimensions of the wood shipping crate.

### 7. USING A VIBRATION-RESISTANT FRAME

- A vibration-reduction frame must be used if the unit is installed in locations where noise and vibration can be a problem, such as on rooftops above living spaces or conference rooms. If a vibration-resistant frame is used, be sure to install steady braces or other support, and take measures to prevent applying excessive force to the refrigerant tubing.
- Refer to the instruction manual supplied with the vibration-resistant frame when installing the frame.

#### (1) When Using Singular Frames

- When anchoring the refrigerant tubing, be sure to set the tubing anchor for each outdoor unit at least 1.5 m away from the respective unit (as shown in Fig. 21-1).
- When installing a ball valve, be sure to install them within area B. (Installation in area A is prohibited.)

Ball valve (provided by installer)

SGP-BV355K (for 25/20 hp)(purchased separately)

SGP-BV 450M (for 16 hp) (purchased separately)

Gas trip-valve kit

SGP-VK32K

(purchased separately)

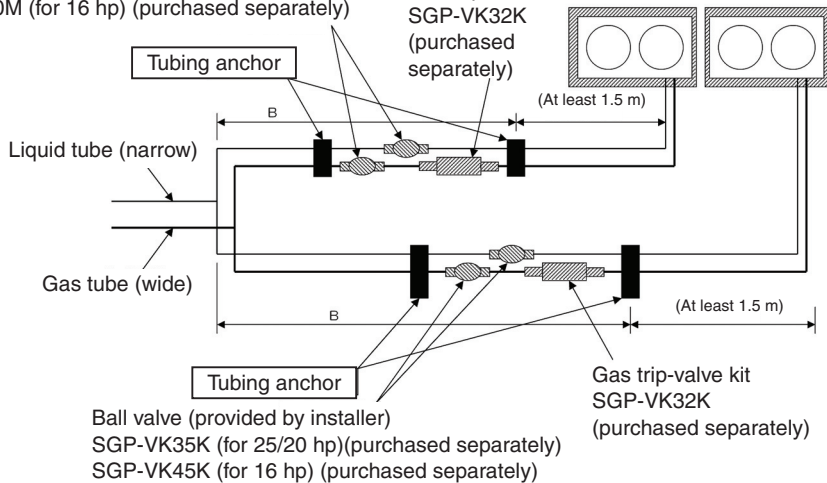

Fig. 21-1



**CAUTION**

When using single-type vibration-resistant frames, never install tubing in the manner shown at the right. Doing so puts excessive weight on the entire tubing installation and may result tube damage.

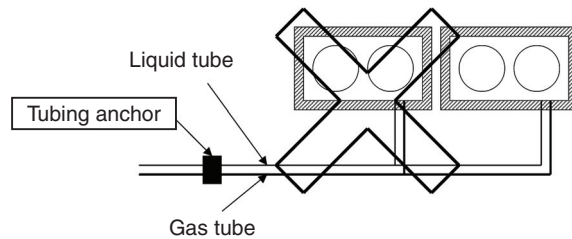

Fig. 21-2

### (2) When Using Interlocking Frames

- When using interlocking vibration-resistant frames, always use frames designed for use with the GHP-W Multi series.

\* There are is no vibration-resistant frame for connected types of units compatible with U-30GE2E5 or U-30GEP2E5.

- After installing the frame, be sure to install steady braces or other support, and take measures to prevent applying excessive force to the refrigerant tubing.
- If installing gas trip-valve kits or ball valves to each outdoor unit, be sure to install them on the vibration-resistant frame. (Installation on the ground is prohibited.)
- When anchoring the refrigerant tubing, always anchor the tubing at the main tubing to prevent tube damage from excessive weight.

When determining the anchor position, refer to the dimensions for A in Fig. 22.

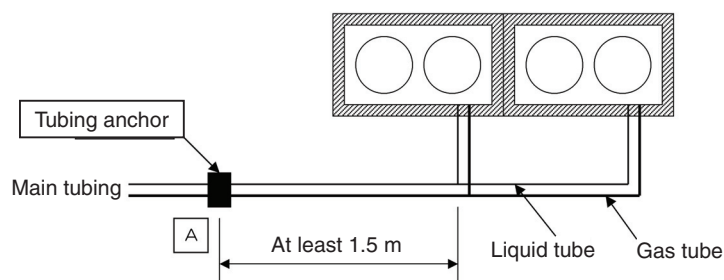



Fig. 22



### Procedure and Technical Points for System Installation - Hot Water Circulation

- The following instruction documents are attached for the outdoor unit: “Procedures and Technical Points for Electrical Wiring Work (Outdoors)” and “Procedures and Technical Points for Test Run.” Be sure to also refer to these documents.

#### Precautions on installation for hot water piping



CAUTION

- **The permitted pressure in hot water piping in outdoor unit is 0.7 MPa.**
- **Install suitable water drainage valves and air extraction valves for hot water piping. Air mixing with fluid inside the pipes may result in noise, corrosion and reduced performance.**
- **Use a hot water circulation volume within the range of 2.1 m<sup>3</sup>/h to 3.9 m<sup>3</sup>/h.**
- **Operation outside this range may result in malfunction due to corrosion in the heat exchanger and freezing in the pipe or in air residue.**
- **Always provide ample heat insulation work for the hot water pipes.**
- **Inadequate heat insulation will cause heat loss. There is also a danger of breakage in extremely cold weather.**

- Install the hot water circulation pump on the hot water inlet piping side.
- Ensure that the nozzle gauge for the hot water outlet piping is greater than the nozzle gauge of the connecting piping (i.e., 20 A), and that there are as few bending portions and as little flow disturbance in the piping as possible. Also, use union joints near the outdoor unit, and ensure that the unit can be easily separated.
- In the inlet piping of the outdoor unit, install a strainer (80 mesh or greater) to protect the hot water outlet heat exchanger. Also, install valves in the outlet pipes, and before and after the strainer for maintenance and servicing.
- Fit the piping with temperature and pressure gauges. There are necessary for checking and maintenance work.
- Fit the water piping with a water temperature gauge and flow adjustment valve so that it is possible to adjust the rate of hot water flow while reading the water temperature gauge during trial operation. Do not touch the adjustment valve after the adjustment.
- Install support fixtures as appropriate for hot water outlet piping and ensure that the outdoor unit is not subject to excessive loads.

#### Cleaning of hot water piping and air purging

- Always clean the piping to remove waste and burr and also any remains of flux inside the piping, which may cause deterioration of antifreeze agent and gelling.

#### Note

Ensure that air is thoroughly discharged. Residual air may prevent water flow and obstruct pipe cleaning.

#### Antifreeze and antirust



CAUTION

- Failure to use antifreeze may result in damage due to freezing around and resting of the appliance and piping.

- An antifreeze filling method is used to prevent freezing in the water circulation system. For prevention of freezing and rust, always use the recommended antifreeze agent: Sanyo genuine Apollo GHP Coolant S.
- Apply this antifreeze agent at a concentration of 35 to 55% in order to attain the rated performance for rust and freezing prevention. Dilute the antifreeze using tap water.
- Set the level of concentration of the antifreeze referring to a temperature 10°C below the lowest year-round outdoor temperature.

#### Antifreeze Performance

Concentration (capacity)	35%	40%	45%	50%	55%
Specific gravity (20°C)	1.056	1.063	1.071	1.078	1.085
Freezing point	-20°C	-24°C	-30°C	-35°C	-42°C





# Contents

- 1. Periodic inspection items and intervals
  - (1) Test run ..... G-2
  - (2) Warranty period..... G-2
  - (3) Periodic inspection items outside the warranty period ..... G-2
  
- 2. Periodic replacement parts .....G-4

In order to use a gas heat pump (GHP) air conditioning system for a long time, periodic inspections need to be performed by a specialist service person.

Sanyo operates a yearly periodic inspection contract system, so customers are encouraged to take out a contract when they purchase GHP.

After a contract is concluded, a specialist service person will visit to perform periodic inspections at intervals based on the number of hours of operation and depending on the periodic inspection content.

For further details regarding the contract, consult with the dealer where this system was purchased or our service company.

### (1) Test run

Inspection items	(Test run inspection) <ul style="list-style-type: none"> <li>• Verification of installation work</li> <li>• Inspection of electrics</li> <li>• Inspection of main unit</li> <li>• Inspection of engine system</li> <li>• Inspection of safety protection devices</li> <li>• Acquisition of operation data</li> <li>• Check for gas leaks</li> </ul>	Note: If any installation work problem is found during the test run, the customer should request that the contractor that installed the equipment remedy the problem.
------------------	---	--

### (2) Warranty period

The period of warranty is one year from the day of completion of hand-over of the equipment after performing a test run.

However, for the engine and parts requiring periodic replacement, the period shall be the shorter of one year from the date of completion of hand-over of the system after performing a test run or 2,000 operating hours.

### (3) Periodic inspection items outside the warranty period

The number of periodic inspections per year varies depending upon the number of hours of operating the heating and cooling system.

The table below shows the case for 2,000 hours of heating/cooling operation in one year. If a periodic inspection contract is concluded, then a GHP specialist service person will visit to carry out the indicated inspections, replace parts, and make adjustments.

(The time to visit will be determined by the service person.)

		Periodic inspection items	
Inspection period	To be determined by the specialist GHP service person.		
Inspection items	<ul style="list-style-type: none"> <li>• Coolant level inspection and filling: 10,000 hours or 5 years</li> <li>• Drain filter filler inspection: 10,000 hours or 5 years</li> <li>• Inspection and adjustment of each part: In accordance with the company's periodic inspection content                             <ul style="list-style-type: none"> <li>Inspection of engine system</li> <li>Inspection of safety protection devices</li> <li>Inspection and filling of engine oil</li> <li>Acquisition of operation data</li> <li>Check for gas leaks</li> </ul> </li> </ul>		
Periodic replacement parts	Replacement interval	Part name	
		Model Type 45.0 kW/56.0 kW/71.0 kW/85.0 kW	
	10,000 hours or 5 years	<ul style="list-style-type: none"> <li>• Engine oil</li> <li>• Engine oil filter</li> <li>• Air cleaner element</li> <li>• Spark plugs</li> <li>• Compressor operation belt</li> <li>• Oil absorbent mat</li> <li>• Oil absorbent tube</li> </ul>	
Note: The engine and the sub-oil panel are subject to the engine oil change.			
Periodic adjustments	<ul style="list-style-type: none"> <li>• Adjustment of the engine valve clearances: 10,000 hours or 5 years</li> </ul>		

A charge is made for periodic inspection.

Note: The periodic replacement period is calculated on the basis of 2,000 operating hours per year, and 13 years of use.

If it becomes necessary to replace parts other than the periodic replacement parts above, there will be a charge separate from the periodic inspection contract charge.

Note: Garbage and dust sticking to the heat exchanger fans of the indoor unit and outdoor unit may result in reduced performance or a failure.

Therefore, it is recommended that you consult with the dealer where the system was purchased or with a specialist service company, and have garbage removed from the heat exchangers, and the heat exchangers cleaned. (A charge will be made for this service.)

■ U-16GE2E5 · U-20GE2E5 · U-25GE2E5 · U-16GF2E5 · U-20GF2E5 · U-25GF2E5

Replacement rank (Replacement time)	Maintenance kit	Part code	Part name	Quantity
C-5 (10,000 hours or 5 years)	CZ-PSK560S	CV638-012-7993	Oil filter	1
		CV638-011-7550	Air cleaner element	1
		CV623-194-7664	Spark plugs	4
		CV623-317-2903	Compressor operation belt	1
		CV623-317-2897	Oil absorbent mat	14
		CV623-317-0114	Drain filter packing	1
C-10 (20,000 hours or 10 years)	CZ-PSK560S	CV638-012-7993	Oil filter	1
		CV638-011-7550	Air cleaner element	1
		CV623-194-7664	Spark plugs	4
		CV623-317-2903	Compressor operation belt	1
		CV623-317-2897	Oil absorbent mat	14
		CV623-317-0114	Drain filter packing	1

■ U-16GEP2E5 · U-20GEP2E5 · U-25GEP2E5

Replacement rank (Replacement time)	Maintenance kit	Part code	Part name	Quantity
C-5 (10,000 hours or 5 years)	CZ-PSK560SP	CV638-012-7993	Oil filter	1
		CV638-011-7550	Air cleaner element	1
		CV623-194-7664	Spark plugs	4
		CV623-317-2903	Compressor operation belt	1
		CV623-317-2897	Oil absorbent mat	14
		CV623-317-0114	Drain filter packing	1
		CV623-172-4463	Generator operation belt	1
C-10 (20,000 hours or 10 years)	CZ-PSK560SP	CV638-012-7993	Oil filter	1
		CV638-011-7550	Air cleaner element	1
		CV623-194-7664	Spark plugs	4
		CV623-317-2903	Compressor operation belt	1
		CV623-317-2897	Oil absorbent mat	14
		CV623-317-0114	Drain filter packing	1
		CV623-172-4463	Generator operation belt	1

■ U-30GE2E5

Replacement rank (Replacement time)	Maintenance kit	Part code	Part name	Quantity
C-5 (10,000 hours or 5 years)	CZ-PSK850S	CV623-197-6640	Oil filter	1
		CV638-011-7550	Air cleaner element	1
		CV623-194-7664	Spark plugs	4
		CV638-018-9625	Compressor operation belt	1
		CV623-317-2897	Oil absorbent mat	14
		CV623-317-0114	Drain filter packing	1
C-10 (20,000 hours or 10 years)	CZ-PSK850S	CV623-197-6640	Oil filter	1
		CV638-011-7550	Air cleaner element	1
		CV623-194-7664	Spark plugs	4
		CV638-018-9625	Compressor operation belt	1
		CV623-317-2897	Oil absorbent mat	14
		CV623-317-0114	Drain filter packing	1

