

NEW PRODUCTS 2018 — 2019

## EFFICIENT SOLUTIONS



# AQUAREA

## Aquarea Air to Water Heat Pump Range.

Aquarea is a ground breaking low energy system for heating and domestic hot water production: delivering outstanding performance, even at extreme outdoor temperatures.

### New Aquarea H Generation A+++.

The beauty of comfort. The new H Generation is being introduced ranging from 3 to 16kW. The small capacity units are specially designed for low energy homes and achieve an impressive COP of 5 (on the 3kW).



### New All in One H Generation.

The new All in One solution from 3 to 16kW with 200L stainless tank with free maintenance. The "A" class pump provides a small foot print and ideal solution for new, retrofit homes.



### New Mono-Bloc Generation.

The "A" class water pump equipped with the new remote controller maximises savings while improving the performance and comfort.



### Aquarea Smart Cloud for Professionals.

Aquarea Smart Cloud will activate remote maintenance service while end user is controlling and monitoring its heating and DHW remotely. This remote maintenance will save time, installation visits by connecting Aquarea to a powerful cloud infrastructure. Remote checker, remote error codes, remote set up functions... all this will be possible by installers with CZ-TAW1 and end user acceptance.

### Wide range of optional parts.

Wide range of quality accessories like Fan Coils and wide range of enamelled tanks and high efficiency stainless steel.



\* The Good Design Award is among the most prestigious awards for product design excellence. Winning this award has underscored the outstanding performance and energy savings of the Panasonic indoor units All in One and Bi-Bloc. In addition, these units' clean, tidy design and functionality make the Aquarea line the ideal system for household applications.

# DOMESTIC

## Domestic Range.

Panasonic has developed a range of domestic products designed for you and your clients.

### R32 Full Domestic range.

All Domestic has transformed to R32 with excellent performance. Panasonic has not just fully adapted to new refrigerant, the new units has been design to maximize the advantages of new refrigerant from Wall, to Cassette, Hide Away, Floor Console and Multi Split Systems.



### Etherea stylish and outstanding features.

Highest energy class A+++ in both heating and cooling, purifies the air with advance purifying nanoe™ system, equipped with Econavi sensors to maximize the comfort and efficiency with imperceptible 19dB(A).

Etherea White awarded with the prestigious IF Design Award 2017.

### Purifying air we breath.

Panasonic systems are equipping different technologies to purify and clean the air. Anti allergy nanoe™ and PM2.5 filters are some examples to take care of the air we breathe.



### New stylish Floor Console.

The new R32 Floor Console has been designed for European market from Scratch. New Floor Consoles purifies the air with nanoe™ X, quiet operation, high efficiency, new design control remote and accurate design are its attributes.

### New Generation Wifi control.

Arriving in April'18 the new generation Panasonic Wifi Control, with completely new user interface and controlling all domestic functions.



# COMMERCIAL

## Commercial Range.

The commercial range is constantly expanding so that you can always offer your clients the optimal solutions: high performance, silent machines and a complete range of ducts, cassettes and ceiling installations.

### nanoe™ X purifies air with PACi 90x90 Cassette.

Thanks to advances in design and technology such as the new high performance turbo fan, which is more efficient and silent, the nanoe™ X air cleaner which provides healthy air, the floor temperature & humidity sensor that give more control, the new PU2 Panasonic 90 x 90 4 way cassette provides a high-class solution for energy savings, healthy environment and comfort.



### Panasonic PACi R32.

New R32 PACi range helps to find more environmental friendly solutions in commercial applications. This pure refrigerant also increase the efficiency of the system.



### New wall design wall type PK2 Series.

Commercial air conditioning and aesthetics find a new ally in with new PK2 series. Following same shape as design award Etherea, PK2 series will combine with any indoor design.



### Server room solutions.

Choose the best solution to ensure any server room needs. Designed for high durability and adverse weather conditions its server room ad hoc control ensure permanent operation and failure alarms communications.

### New control CZ-RTC5B with datanavi.

Ready to control Z PACi systems with backup and alternate operation.

### Complete AHU Solution.

Demand control 0-10V, box IP65 case, cold draft prevention, monitoring status digital output, remote control built-in.



# VRF

## VRF Systems.

The VRF industrial range considerably improves efficiency so even large buildings can benefit from a high-level of comfort with less energy consumption.

### VRF Systems ECOi EX.

A VRF System delivering energy-saving performance, powerful operation, reliability and comfort surpassing anything previously possible. It represents a true paradigm shift in air conditioning solutions.



### Mini ECOi LE Series.

The Mini ECOi combines smartly compact body with high specifications. It delivers high levels of energy-saving, powerful operation, reliability and comfort.

### 2-Pipe ECO G GE3 Series.

"L" type heat exchanger and new inverter DC fan motor with a 3-blade propeller to improve energy efficiency through about 30% reduction in electrical power consumption.



### VRF Smart Connectivity.

Panasonic's VRF Smart Connectivity is a completely new, state-of-the-art solution providing energy saving and comfort as well as simple installation, operation and running.

### Panasonic AC Smart Cloud.

Centralised control of your business premises, from wherever 24/7. Smartly control, maintain, optimise and save.



# INDEX



## EDITORIAL

- 6 A DESIRE TO CREATE THINGS OF VALUE
- 8 A GLOBALLY TRUSTED AIR CONDITIONING BRAND
- 10 100% PANASONIC, THE DNA OF JAPANESE CRAFTSMANSHIP
- 12 PANASONIC: ECO & SMART IDEAS FOR A SUSTAINABLE LIFESTYLE
- 14 PROJECTS & CASE STUDIES OF PANASONIC HEATING AND COOLING SOLUTIONS
- 16 PRO CLUB, THE PROFESSIONAL WEBSITE OF PANASONIC
- 17 AQUAREA DESIGNER



## AQUAREA

- 18 WELCOME TO AQUAREA AIR TO WATER HEAT PUMP
- 20 HIGHLIGHTED FEATURES
- 22 HOW DO YOU GET HEATING AND DOMESTIC HOT WATER FROM AIR?
- 24 AQUAREA HEAT PUMP LINE-UP
- 26 AQUAREA H GENERATION A+++
- 28 AQUAREA HIGH PERFORMANCE
- 30 AQUAREA T-CAP
- 32 AQUAREA HT
- 34 AQUAREA COMMERCIAL
- 36 AQUAREA SMART & SERVICE CLOUD
- 38 CONTROL & CONNECTIVITY
- 39 AQUAREA + PV PANELS
- 40 AQUAREA HEAT PUMPS LINE-UP
- 42 AQUAREA HIGH PERFORMANCE ALL IN ONE BI-BLOC H GENERATION SINGLE PHASE. HEATING AND COOLING 1 OR 2 ZONES
- 43 AQUAREA HIGH PERFORMANCE ALL IN ONE BI-BLOC H GENERATION THREE PHASE. HEATING AND COOLING
- 44 AQUAREA ALL IN ONE H GENERATION T-CAP BI-BLOC SINGLE PHASE / THREE PHASE. HEATING AND COOLING
- 45 AQUAREA ALL IN ONE H GENERATION T-CAP BI-BLOC THREE PHASE. SUPER QUIET OUTDOOR UNIT. HEATING AND COOLING
- 46 AQUAREA HIGH PERFORMANCE BI-BLOC H GENERATION SINGLE PHASE. HEATING AND COOLING - SDC
- 47 AQUAREA HIGH PERFORMANCE BI-BLOC H GENERATION THREE PHASE. HEATING AND COOLING - SDC
- 48 AQUAREA H GENERATION T-CAP BI-BLOC SINGLE PHASE / THREE PHASE. HEATING AND COOLING - SXC
- 49 AQUAREA H GENERATION T-CAP BI-BLOC THREE PHASE. SUPER QUIET OUTDOOR UNIT. HEATING AND COOLING - SDC
- 50 AQUAREA H GENERATION HIGH PERFORMANCE MONO-BLOC SINGLE PHASE. HEATING AND COOLING - MDC
- 51 AQUAREA H GENERATION T-CAP MONO-BLOC SINGLE PHASE / THREE PHASE. HEATING AND COOLING - MXC
- 52 AQUAREA F GENERATION HT BI-BLOC SINGLE PHASE / THREE PHASE. HEATING ONLY - SHF
- 53 AQUAREA G GENERATION HT MONO-BLOC SINGLE PHASE. HEATING ONLY - MHF
- 54 AQUAREA AIR RADIATORS, FAN COILS FOR HEAT PUMP APPLICATION
- 55 NEW VERSATILE AND EFFICIENT FAN COIL RANGE. FAN COIL COMPATIBLE WITH AQUAREA AND VRF SYSTEMS
- 56 SANITARY TANKS
- 58 AQUAREA DHW
- 60 ACCESSORIES & CONTROL
- 62 PANASONIC'S AQUAREA OFFERS THE BEST FOR YOU AND YOUR HOME
- 64 HEATING & COOLING CAPACITY TABLES
- 73 EXAMPLES OF INSTALLATIONS



## DOMESTIC

- 74 WELCOME TO DOMESTIC RANGE
- 76 HIGHLIGHTED FEATURES
- 78 R32 REFRIGERANT GAS
- 80 ETHEREA STYLISH AND OUTSTANDING FEATURES
- 82 NANO-SIZED ELECTROSTATIC ATOMIZED WATER PARTICLES, NANO™
- 84 ECONAVI INTELLIGENT SENSORS. DISCOVER HOW TO ACHIEVE ENERGY SAVINGS
- 86 PANASONIC R2 ROTARY COMPRESSOR
- 88 WALL MOUNTED TZ/TE COMPACT STYLE
- 90 HEATCHARGE. ENERGY CHARGE SYSTEM
- 92 R22 RENEWAL
- 94 CONTROL & CONNECTIVITY
- 96 DOMESTIC AIR CONDITIONER RANGE R32
- 98 WALL MOUNTED HEATCHARGE VZ INVERTER+ • R32 GAS
- 99 WALL MOUNTED ETHEREA INVERTER+ SILVER / PURE WHITE MATT • R32 GAS
- 100 WALL MOUNTED TZ COMPACT STYLE INVERTER • R32 GAS
- 101 NEW WALL MOUNTED FZ TYPE STANDARD INVERTER • R32 GAS
- 102 WALL MOUNTED PZ TYPE STANDARD INVERTER • R32 GAS
- 103 NEW WALL MOUNTED PROFESSIONAL INVERTER -20°C • R32 GAS
- 104 NEW NANO™ X. QUALITY AIR FOR LIFE
- 105 NEW FLOOR CONSOLE TYPE INVERTER+ • R32 GAS
- 106 NEW 4 WAY 60X60 CASSETTE INVERTER • R32 GAS
- 107 NEW LOW STATIC PRESSURE HIDE AWAY INVERTER • R32 GAS
- 108 MULTI SPLIT AND FREE MULTI SYSTEM
- 114 DOMESTIC AIR CONDITIONER RANGE R410A
- 116 WALL MOUNTED ETHEREA INVERTER+ SILVER / MATT PEARL WHITE • R410A GAS
- 117 WALL MOUNTED TE COMPACT STYLE INVERTER • R410A GAS
- 118 NEW WALL MOUNTED FE TYPE STANDARD INVERTER • R410A GAS
- 119 WALL MOUNTED BE TYPE STANDARD INVERTER • R410A GAS
- 120 WALL MOUNTED DE TYPE STANDARD INVERTER • R410A GAS
- 121 WALL MOUNTED PROFESSIONAL INVERTER -20°C • R410A GAS
- 123 FLOOR CONSOLE TYPE INVERTER+ • R410A GAS
- 124 4 WAY 60X60 CASSETTE STANDARD INVERTER • R410A GAS
- 125 LOW STATIC PRESSURE HIDE AWAY STANDARD INVERTER • R410A GAS
- 130 FEATURE COMPARISON
- 132 FEATURES EXPLAINED
- 133 ACCESSORIES & CONTROL
- 134 FREE MULTI R32 COMBINATIONS TABLE
- 151 MULTI WALL TZ COMBINATIONS TABLE
- 153 FREE MULTI R410A COMBINATIONS TABLE
- 168 MULTI WALL RE COMBINATIONS TABLE



### Quality Management System Certificate



**Certified to ISO 9001: 2008**  
Panasonic Appliances Air-Conditioning  
Malaysia. Sdn.Bhd.  
Cert. No.: MY-AR 1010



**Certified to ISO 9001: 2008**  
Panasonic Appliances Air-Conditioning  
(GuangZhou) Co., Ltd.  
Registration Number: 01209Q20645R5L

### Environmental Management System Certificate



**Certified to ISO 14001: 2004**  
Panasonic Appliances Air-Conditioning  
Malaysia Sdn.Bhd.  
Cert. No.: MY-EP0112



**Certified to ISO 14001: 2004**  
Panasonic Appliances Air-Conditioning  
(GuangZhou) Co., Ltd.  
Registration Number: 02110E10562R4L



## COMMERCIAL

- 170 WELCOME TO THE COMMERCIAL RANGE
- 172 HIGHLIGHTED FEATURES
- 174 PACi OUTDOOR UNITS ENERGY SAVING CONCEPT
- 176 PACi ELITE: EXCELLENT SEER AND SCOP VALUES
- 178 SOLUTIONS FOR SERVER ROOMS
- 180 GENERATION PACi 90x90 CASSETTE
- 182 RANGE OF COMMERCIAL UNITS R32
- 184 NEW WALL MOUNTED PROFESSIONAL INVERTER -20°C • R32 GAS
- 186 NEW PACi ELITE WALL MOUNTED INVERTER+ • R32 GAS
- 188 NEW PACi STANDARD WALL MOUNTED INVERTER+ • R32 GAS
- 190 NEW PACi ELITE 4 WAY 60x60 CASSETTE INVERTER+ • R32 GAS
- 191 NEW PACi STANDARD 4 WAY 60x60 CASSETTE INVERTER+ • R32 GAS
- 192 NEW PACi ELITE 4 WAY 90x90 CASSETTE INVERTER+ • R32 GAS
- 194 NEW PACi STANDARD 4 WAY 90x90 CASSETTE INVERTER+ • R32 GAS
- 196 NEW PACi ELITE CEILING INVERTER+ • R32 GAS
- 198 NEW PACi STANDARD CEILING INVERTER+ • R32 GAS
- 200 NEW PACi ELITE HIGH STATIC PRESSURE HIDE AWAY INVERTER+ • R32 GAS
- 202 NEW PACi STANDARD HIGH STATIC PRESSURE HIDE AWAY INVERTER+ • R32 GAS
- 204 PACi ELITE LOW STATIC PRESSURE HIDE AWAY INVERTER+ • R32 GAS
- 206 PACi STANDARD LOW STATIC PRESSURE HIDE AWAY INVERTER+ • R32 GAS
- 208 RANGE OF COMMERCIAL UNITS R410A
- 210 WALL MOUNTED PROFESSIONAL INVERTER -20°C • R410A GAS
- 212 NEW PACi ELITE WALL MOUNTED INVERTER+ • R410A GAS
- 214 NEW PACi STANDARD WALL MOUNTED INVERTER+ • R410A GAS
- 216 PACi ELITE 4 WAY 60x60 CASSETTE INVERTER+ • R410A GAS
- 217 PACi STANDARD 4 WAY 60x60 CASSETTE INVERTER+ • R410A GAS
- 218 PACi ELITE 4 WAY 90x90 CASSETTE INVERTER+ • R410A GAS
- 220 PACi STANDARD 4 WAY 90x90 CASSETTE INVERTER+ • R410A GAS
- 222 PACi ELITE CEILING INVERTER+ • R410A GAS
- 224 PACi STANDARD CEILING INVERTER+ • R410A GAS
- 226 PACi ELITE HIGH STATIC PRESSURE HIDE AWAY INVERTER+ • R410A GAS
- 228 PACi STANDARD HIGH STATIC PRESSURE HIDE AWAY INVERTER+ • R410A GAS
- 230 PACi ELITE LOW STATIC PRESSURE HIDE AWAY INVERTER+ • R410A GAS
- 232 PACi STANDARD LOW STATIC PRESSURE HIDE AWAY INVERTER+ • R410A GAS
- 234 BIG PACi HIGH STATIC PRESSURE HIDE AWAY 20,0-25,00KW INVERTER+ • R410A GAS
- 236 PACi SINGLE, TWIN, TRIPLE AND DOUBLE-TWIN SYSTEM • R32 GAS AND • R410A GAS
- 242 PANASONIC VENTILATION SOLUTIONS
- 243 NEW ELECTRIC AIR CURTAIN
- 244 AIR HANDLING UNIT KIT 10-25KW FOR PACi
- 246 AIR CURTAIN WITH DX COIL, CONNECTED TO THE VRF OR PACi SYSTEMS
- 248 PANASONIC PACi ELITE CAN COOL ROOMS DOWN TO 8°C
- 250 R22 RENEWAL FAST, EASY TO INSTALL AND COST EFFECTIVE
- 254 ACCESSORIES & CONTROL



## VRF SYSTEMS

- 256 PANASONIC INDUSTRIAL VRF SYSTEMS
- 258 VRF HIGHLIGHTED FEATURES
- 260 PANASONIC: DELIVERING TOP ENERGY EFFICIENCIES FOR MANY YEARS
- 262 PANASONIC VRF: TOP IN COMFORT
- 264 SOLUTIONS FOR RESTAURANTS
- 266 YOUR ENTIRE HOTEL WITH SUPERIOR COMFORT, CONTROL AND SAVINGS TOO
- 268 INNOVATIVE SOLUTIONS FOR RETAIL
- 270 RANGE OF VRF OUTDOOR UNITS
- 272 BEST EFFICIENCY ECOi SERIES FROM PANASONIC
- 274 MINI ECOi LE SERIES FOR LIGHT COMMERCIAL & RESIDENTIAL USE
- 280 ECOi EX THE GAME CHANGER
- 286 2-PIPE ECOi EX ME2 SERIES
- 296 NEW 3-PIPE ECOi EX MF3 SERIES
- 302 ECO G, THE GAS DRIVEN VRF
- 308 2-PIPE ECO G GE3 SERIES
- 310 NEW 3-PIPE ECO G GF3 SERIES
- 312 NEW PANASONIC GHP/EHP HYBRID SYSTEM
- 316 WATER HEAT EXCHANGER FOR HYDRONIC APPLICATIONS
- 320 LEAK DETECTION AND AUTOMATIC REFRIGERANT PUMP DOWN
- 321 DESIGN SUPPORT SOFTWARE FOR VRF
- 322 NEW VRF SYSTEMS INDOOR UNITS
- 324 ECOi AND ECO G SYSTEMS INDOOR UNITS RANGE
- 326 U2 TYPE 4 WAY 90X90 CASSETTE
- 328 Y2 TYPE 4 WAY 60X60 CASSETTE
- 329 L1 TYPE 2 WAY CASSETTE
- 330 D1 TYPE 1 WAY CASSETTE
- 331 F2 TYPE VARIABLE STATIC PRESSURE HIDE AWAY
- 332 M1 TYPE SLIM VARIABLE STATIC PRESSURE HIDE AWAY CONCEALED DUCT
- 333 E2 TYPE HIGH STATIC PRESSURE HIDE AWAY
- 334 HEAT RECOVERY WITH DX COIL
- 335 T2 TYPE CEILING
- 336 K2 TYPE WALL MOUNTED
- 337 P1 TYPE FLOOR STANDING
- 338 R1 TYPE CONCEALED FLOOR STANDING
- 339 HYDROKIT FOR ECOi WATER AT 45°C
- 340 AQUAREA AIR RADIATORS. FAN COILS FOR HEAT PUMP APPLICATION
- 341 NEW VERSATILE AND EFFICIENT FAN COIL RANGE
- 342 PANASONIC VENTILATION SOLUTIONS
- 344 AHU CONNECTION KIT 16, 28 AND 56KW FOR ECOi AND ECO G
- 346 AIR CURTAIN WITH DX COIL, CONNECTED TO THE VRF OR PACi SYSTEMS
- 348 ENERGY RECOVERY VENTILATION
- 350 HEAT RECOVERY WITH DX COIL
- 352 DIMENSIONS AND TUBE SIZES OF BRANCHES AND HEADERS FOR ECOi 2-PIPE SYSTEMS
- 354 BRANCHES AND HEADERS FOR 3-PIPE ECOi AND MINI ECOi
- 356 ACCESSORIES & CONTROL



## CONTROL AND CONNECTIVITY

- 358 CONTROL AND CONNECTIVITY
- 360 CONNECT TO THE FUTURE. VRF SMART CONNECTIVITY
- 366 PANASONIC AC SMART CLOUD
- 368 REMOTE CONTROLLER WITH ECONAVI
- 370 NEW DATANAVI
- 372 ECONAVI SENSOR
- 374 INTELLIGENT CONTROLLER
- 376 CONTROL FOR HOTEL APPLICATION
- 378 CONTROL AND CONNECTIVITY
- 380 INDIVIDUAL CONTROLLERS
- 382 CENTRALISED CONTROLLERS
- 387 PACi AND VRF CONNECTIVITY & CONTROL
- 388 ECOi, ECO G AND PACi CONNECTIVITY INDOOR UNITS



## 390 REFRIGERATION

## 396 DIMENSIONS

# A DESIRE TO CREATE THINGS OF VALUE

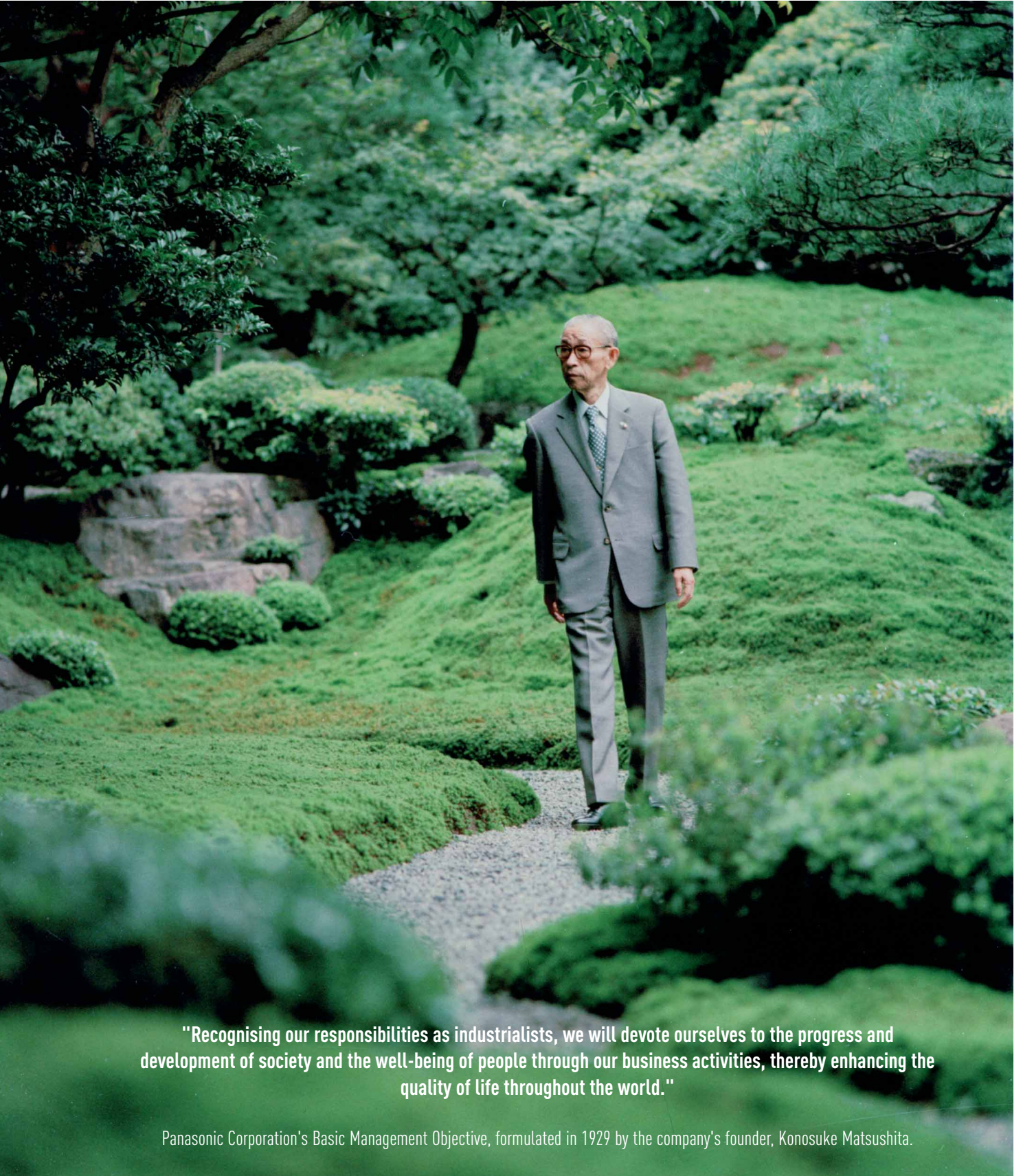

**"Recognising our responsibilities as industrialists, we will devote ourselves to the progress and development of society and the well-being of people through our business activities, thereby enhancing the quality of life throughout the world."**

Panasonic Corporation's Basic Management Objective, formulated in 1929 by the company's founder, Konosuke Matsushita.

Panasonic: celebrating two major milestones in 2018.



Panasonic Corporation, 100th anniversary

Look ahead to the "Future," keep taking on challenges. Starting back in 1918, Panasonic has constantly added to its guarantee for innovation, taking tomorrow's technologies and applying them to today's needs.

Always making "people" central to our activities, and thereby focusing on "people's lives," we will continue to provide better living for our customers. This is the unchanging commitment we at Panasonic have had over many years.

Now, we are aiming to expand our contribution to "better living" everywhere. This means that in the variety of spaces where our customers go about their lives, ranging from inside the home, the office, the store, the automobile, and the airplane, as well as in the town, we will provide not only single pieces of hardware, but also total solutions including software and services. We will pursue the concept of "A Better Life, A Better World," meeting the needs of each individual customer.

To that end, we will leverage the strengths that we at Panasonic have long developed in our consumer electronics business, together with the strengths of our business partners who have in-depth expertise in many areas, and we will work to combine these strengths by pursuing "Cross-Value Innovation." In this way, we will create new value. This is the new and challenging task we are now addressing.



1958 First room air conditioner launched for domestic installation.

Panasonic Heating and Cooling, 60th anniversary

Panasonic starts with a desire to create things of value. Sixty years ago, as hard work and dedication results in one innovative product after another, the new company took its first steps towards becoming the electronics giant of today. Heating and Cooling Solutions designed and produced by Panasonic since 1958.



1971 Starts production of absorption chillers.



1973 Panasonic launches the first highly efficient air-to-water heat pump in Japan.



1975 Panasonic becomes the first Japanese air conditioner manufacturer in Europe.



1985 Introduces first GHP (gas heat pump) VRF air conditioner.



1989 Introduces world's first simultaneous 3-Pipe heating/cooling VRF System.



2008 Etherea new concept: high efficiency and high performances with a great design.



2010 New Aquarea. Panasonic introduces Aquarea, an innovative new, low-energy system in Europe.



2012 New GHP units. Panasonic's gas-driven VRF Systems are ideal for projects where power restrictions apply.



2016 New VRF Systems ECOi EX with extraordinary energy-saving performance.



Looking ahead The first Hybrid System with VRF and GHP in Europe.

# A GLOBALLY TRUSTED AIR CONDITIONING BRAND





Panasonic – leading the way in Heating and Cooling.  
With more than 50 years of experience, selling to more than 120 countries around the world, Panasonic is one of the leaders in the heating and cooling sector.

With a diverse network of production and R&D facilities, Panasonic delivers innovative products incorporating cutting-edge technologies that set the standard for air conditioners worldwide. Expanding globally, Panasonic provides superior international products transcending borders.



Testing laboratory Panasonic Gunma, Japan (PAPARS).

### 100% Panasonic: we control the process

The company is also a world leader in innovation as it has filed more than 91,539 patents to improve its customers' lives. Moreover, Panasonic is determined to remain at the forefront of its market. In all, the company has produced more than 200 million compressors and its products are manufactured in 294 plants which are located all over the world. You can be assured of the extremely high quality of Panasonic's heat pumps. This wish to excel has made Panasonic a leading company in heating and turn-key air conditioning solutions. These offer maximum effectiveness, comply with all environmental standards and meet the most avant-garde construction requirements of our time.

### Constantly Improving

At Panasonic, we know that the best is always yet to come. This is why our air conditioning and heat pump solutions are constantly upgraded. Panasonic is committed to offering our customers innovative products in the heating and cooling market across Europe, and has the ambition to not only meet but also exceed their requirements. Our Technology & Design teams anticipate the needs of tomorrow. We look to produce smaller, quieter, efficient solutions - with better technological features – that can reduce energy consumption while providing suitable temperature conditions for the user.

### Our project in Europe

With operations in 31 countries, Panasonic Europe is able to support your projects wherever you are located. Panasonic will ensure the same level of know how and quality throughout the chain. Panasonic offers its customers training centres and training academies for installers, design offices and service teams in all major countries. Your projects are safe in our hands.



Panasonic is committed to offering our customers innovative products in the heating and cooling market across Europe, which not only meet but exceed their requirements. Key to success is Panasonic's investment in R&D, manufacture and training to ensure innovative, cutting edge products and investment in our distribution channels and partners so that these products are accessible in Europe. Panasonic has developed a comprehensive network across Europe of training centers and training academies for installers, design offices and service teams in all major countries.



100% PANASONIC, THE DNA OF  
JAPANESE CRAFTSMANSHIP

JAPAN  
QUALITY



Applying advanced technologies that truly make life better, we live by an unparalleled commitment to product quality. Panasonic is building on the Japanese tradition of uncompromising quality control worldwide, developing and manufacturing fine products and delivering them to customers everywhere.

---

**At Panasonic, we believe that the best air conditioner is one that works quietly and effectively in the background whilst minimising its impact on the environment**

People who use our products can look forward to long years of high-quality performance without the need for constant service. As part of our rigorous design and development process, Panasonic air conditioners undergo a variety of stringent tests to ensure their effectiveness and long-term reliability. Tests for durability, waterproofing, shock resistance, and noise are conducted on component parts or on the finished products themselves. As a result of all of these time consuming efforts, Panasonic air conditioners meet industrial standards and regulations in every country where they are sold.

---

**International Standard Quality**

To uphold the company's reputation around the world, Panasonic strives continuously to offer quality with minimized environmental impact.

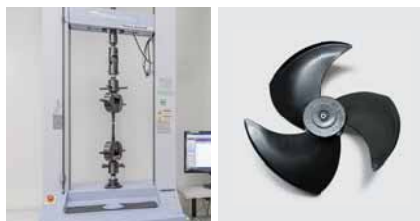

**Reliable parts that meet or exceed industrial standards.**

In every country where they are sold, Panasonic air conditioners comply with all required industrial standards and regulations. In addition, Panasonic conducts stringent testing to ensure the reliability of parts and materials. The strength of the resin material used in a propeller fan is confirmed by a tension test.



**Compliance with RoHS / REACH substance restrictions.**

Panasonic products and used materials strictly comply with chemical substance restrictions as defined by RoHS or REACH. During the development and production of parts, stringent inspections are conducted on over 100 materials to ensure that no hazardous substances are included.



**Sophisticated production process.**

Panasonic's air conditioner production lines employ state-of-the-art factory automation technologies to ensure products are manufactured with high attention to quality to meet expectations of reliability and trustworthiness.

---

**Durability**

At Panasonic we know the importance of a long service life with minimal maintenance. That's why we subject our air conditioners to a wide range of stringent durability tests.



**Long-term durability test.**

To ensure durability and stable operation for many years, we conduct a long-term continuous operation test under conditions that are much more severe than actual operating conditions.



**Compressor reliability test.**

After the continuous operation test, we remove the compressor from a selected outdoor unit, disassemble it, and examine the internal mechanisms and parts for potential failure. This helps ensure reliable long-term performance under harsh conditions.



**Waterproofing test.**

The unit - which is subject to rain and wind - complies with IPX4 waterproof specifications. Contact sections on printed circuit boards are resin-potted to prevent adverse effects caused by exposure to water (an unlikely occurrence).

# PANASONIC: ECO & SMART IDEAS FOR A SUSTAINABLE LIFESTYLE

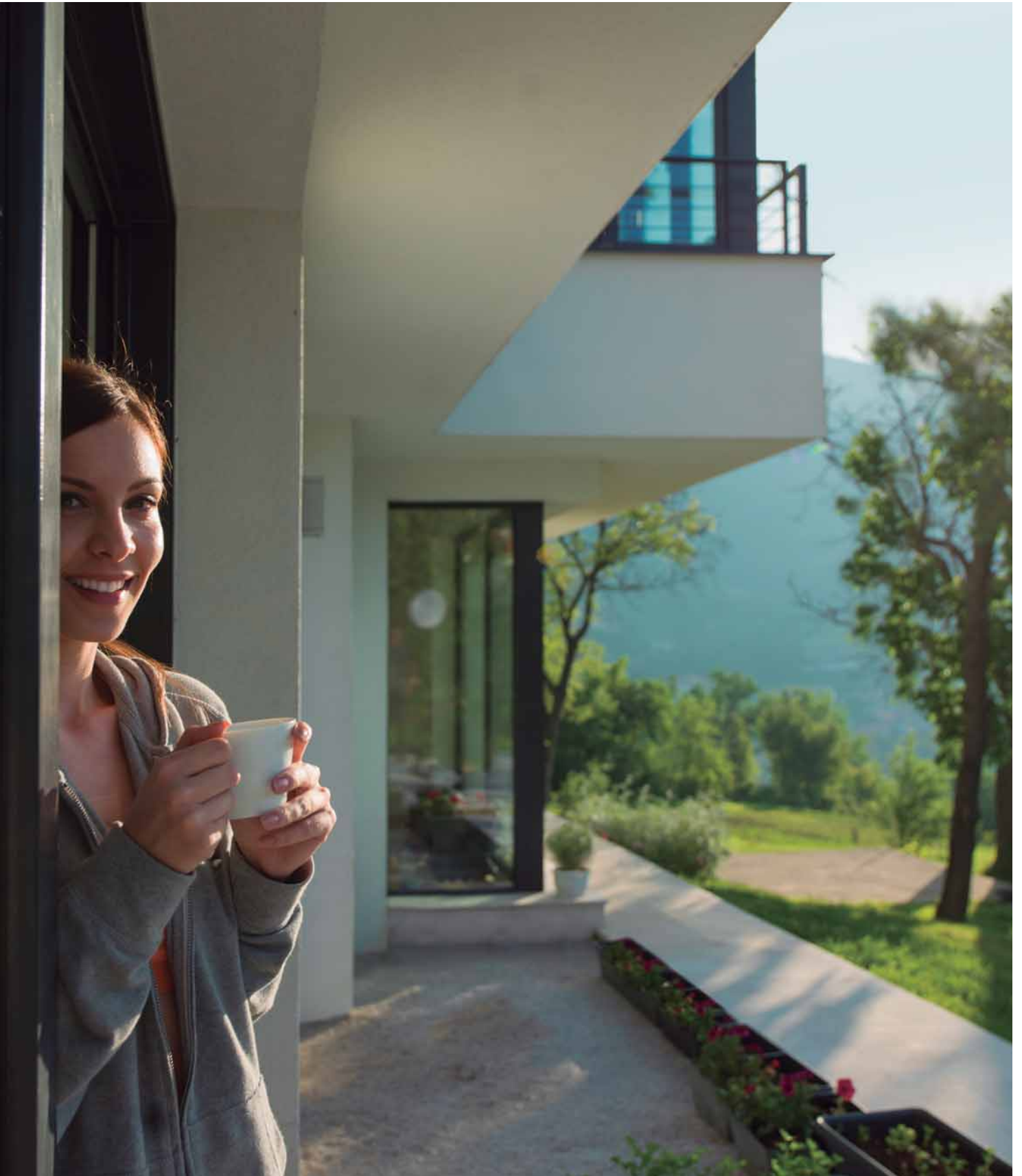

A better life, a better world.  
Panasonic is creating a safe and secure society with clean energy.

**Exemplary sustainable projects**

**Fujisawa Sustainable Smart Town - Located Approximately 50km West of Tokyo.**

Fujisawa is an eco and smart town that holds people’s lifestyles at the heart of town development. Fujisawa SST Council is a consortium led by Panasonic Corporation spearheading the development of the Fujisawa Sustainable Smart Town (Fujisawa SST).

The sustainable energy services in Fujisawa SST include Panasonic’s cutting-edge technology for LED lighting, solar panels, storage batteries, and household fuel cell cogeneration systems or heat pump water heater equipped in each home.

The Fujisawa SST Management Company is the town management company located in the SQUARE, which is serving as the main landmark of the town and a central communication base. Together with partner companies, the company provides five essential services in the town: energy, security, mobility, healthcare and community. The company also collects and manages information relating to the town’s overall environment, energy, security and safety to support an eco and smart life in the town.



There is also a detached housing zone for non car owners and by using the town’s eco-car sharing and rent-a-car services, residents in the zone can enjoy their lifestyles without the need to own a car while reducing economic burden and making effective use of the lot. In addition to that, environmentally-friendly logistic services are provided to the residents.

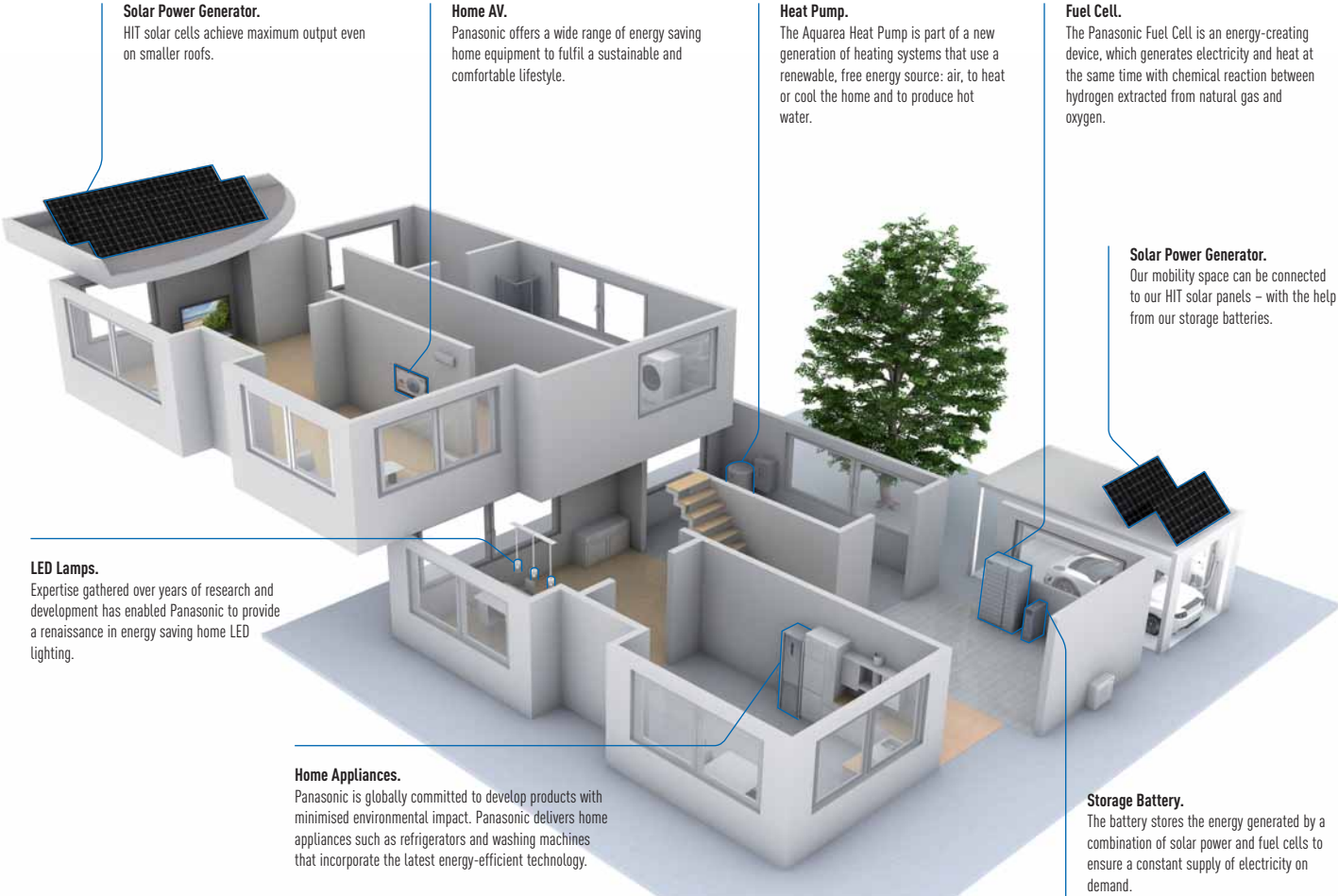

# PROJECTS & CASE STUDIES OF PANASONIC HEATING AND COOLING SOLUTIONS



The new Hotel Vincci Gala with efficiency class A, up to 70% save energy. Barcelona, Spain. ECOi - ECO 6

Panasonic, a partner with the knowledge and experience to achieve your objectives and green needs.

### Integrated technology that permits better work, easy installation, high efficiency performance, and energy savings

Our main targets are the distributed services and B2B-integrated solutions.

Panasonic provides a single point of contact for the design and maintenance of your system, making things easy for you.

Given our experience in processes, technologies and complex business models, we can offer you effective solutions that reduce costs, whilst also being efficient, user-friendly, reliable and innovative. Another advantage we offer to our clients is a support service for systems integration projects, which we provide through our wide range of services and solutions.

As a global company, we have at our disposal the financial, logistical and technical resources to develop complex and wide-ranging solutions, both at country and international level by implementing them both on-time and on-budget.



Passive house in Tychowo near Stargard Szczecinski, Poland. **Aquarea**



New Hotel Monument 5\*GL is located in an 1896 palace. Barcelona, Spain. **ECOi and E-Control**



New IKEA "Click and Collect" store in city centre. Birmingham, UK. **ECOi - ECO G**



21 of the 5-6 bedroom luxury homes in Straffan Co.Kildare, Ireland. **Aquarea**



Andalucia Technology Park. Offices of high energetic efficiency. Spain. **ECOi**



The latest glamorous Burger & Lobster restaurant in Bath. UK. **Aquarea**



Madrid's new hotel Only You Atocha. The hotel has 206 rooms distributed over seven floors. **ECO G**



Lo + Fit Galapagar Gym. Madrid, Spain. **VRF, PACi, AHU**



Marina Village Greystones. 205 apartments and 153 houses. Ireland. **Aquarea**



The Hat, a modern hostel in Madrid. Spain. **ECO G**



Zalando's solution for its warehouse office conversion at Grand Canal Quay, Dublin. **ECOi**



Lock Building, offices for media giant Viacom. Camden, London, UK. **ECOi**

# PRO CLUB. THE PROFESSIONAL WEBSITE OF PANASONIC



**PRO Club** 

Download on  
[www.panasonicproclub.com](http://www.panasonicproclub.com)  
or connect simply with your  
smartphone to the PRO Club  
using this QR



Panasonic PRO Club ([www.panasonicproclub.com](http://www.panasonicproclub.com)) is the online tool which makes your life easier! You just have to register and a lot of functionalities are freely available to you, where ever you are, from your computer or smart phone!

- Print catalogues with your logo and your address
- Download the latest Aquarea designer to define your system and select the good Aquarea Heat pump.
- Calculate the specs of the Aquarea Air fan coil based on the parameters of your system
- Get Documents of conformity and all other documents you may need
- Download all the service manuals, end user manuals and installation manuals
- Know what to do with error codes
- Find out about the latest news first
- Register for training

### Highlighted Features.

- Extensive library of resources
- Tools & Apps for end users. Check availability in your country:
  - My Home: sizing wizard for domestic and Air to Water range
  - My Project: Contact form to Panasonic team
  - iFinder: Lists of installers displayed by postcode
- Special offers & promotions
- Training PRO Academy

- Catalogues (Commercial documentation)
- Marketing (Images in high resolution, advertisements, deco guidelines)
- Tools (Professional software, sizing tools...)
- Installers customize leaflets in PDF format with their logo & contact details
- Energy label generator. Download energy labels of any device in PDF format
- Heating calculator
- Noise calculator for outdoor unit
- Aquarea Radiator calculator
- Error Code Search by error code or unit ref. Compatible with smartphone and tablet computer
- Revit / CAD Images / Spec texts
- Access to Pananet, online library of technical documentation
- Download Documents of Conformity and other Certifications
- Commissioning online

**Panasonic PRO Club is fully compatible with tablet computer and smartphone.**

Panasonic has an impressive range of support services for designers, specifiers, engineers and distributors working in the heating and cooling markets.



Easy download Panasonic service documentation and brochures



Customise leaflets with your logo & contact details. Save and print the PDF



Energy label generator. Download Energy labels of any device in PDF format



Error Code on your smartphone and your PC: Search by error code or model reference. Online version + downloadable version for offline use



# AQUAREA DESIGNER



This program allows HVAC designers, installers and distributors to identify the correct heat pump for a particular application from Panasonic's Aquarea range, calculate the savings compared to other heat sources and very quickly calculate CO<sub>2</sub> emissions.

Using Panasonic's Aquarea Designer, projects can be developed simply and easily, by either using the Quick Design or Expert Design options. Each allows the user to build up the project data in a simple step-by-step process and choose to output reports (in either Quick or Large formats) as HTML files or as print-outs. To create these useful reports, project data is input, including:

- Heated area
- Heating requirement
- Heating flow and return temperatures
- Climate data (from a simple drop-down menu) including outdoor temperature
- Type of hot water tank, storage capacity and hot water target temperature

**Panasonic provides bespoke software helping system designers, installers and dealers to very quickly design and size systems, create wiring diagrams and issue bills of quantities at the push of a button.**



## Aquarea Designer also means saving

Aquarea Designer will calculate the project's energy costs in terms of hot water, heating and pumping. It will show the equipment running times and calculate the COP (coefficient of performance). It then allows the designer to show clients a comparison with other equipment options such as heating by conventional gas-fired boilers, oil systems, wood, standard electric heating and electric night storage heaters. This compares running costs, initial investment costs and maintenance costs. The comparison can also be made for CO<sub>2</sub> emissions and savings.

## The Panasonic PRO Academy

Panasonic takes its responsibility to its distributors, specifiers and installers seriously and has developed a comprehensive Training Programme. The Panasonic Pro-Academy encompasses the traditional hands-on approach to teaching.

New training courses cover three levels. Design, installation, and commissioning & trouble-shooting. Training courses include:

- Domestic applications Air to Air
- Aquarea air source heat pumps
- VRF ECOi

The courses are offered on site at Panasonic's premises across Europe. The Training Centres display Panasonic's latest product range and give delegates an opportunity to get a hands-on experience with the latest controllers, indoor and outdoor units from the VRF ECOi, Etheera, GHP and Aquarea ranges.



Download on  
[www.panasonicproclub.com](http://www.panasonicproclub.com)  
or connect simply with your  
smartphone to the PRO Club  
using this QR



# WELCOME TO AQUAREA AIR TO WATER HEAT PUMP



Aquarea's Air to Water Heat Pump for residential and commercial applications. Offering capacities from 3kW all the way through to 16kW, the Aquarea Heat Pump Range is the widest on the market, ensuring a system is available, whatever your heating and cooling needs. Suitable for new build and refurbishment projects, the solutions are cost-effective with minimised environmental impact.



# HIGHLIGHTED FEATURES



GOOD  
DESIGN  
AWARD  
2017



The Good Design Award is among the most prestigious awards for product design excellence. Winning this award has underscored the outstanding performance and energy savings of the Panasonic indoor units All in One and Bi-Bloc. In addition, these units' clean, tidy design and functionality make the Aquearea line the ideal system for household applications.

Panasonic's Aquarea range of Heat Pumps deliver major energy savings thanks to its incredible efficiency even at -20°C. The Panasonic Aquarea Heat Pumps are designed and produced by Panasonic and not by other companies.

The Aquarea Heat Pump is a system that generates the perfect temperature and produces hot water, in an easy, cheap and environmentally conscious way, by transferring heat instead of generating it. It is among the Technologies listed on the International Energy Agency (IEA) Blue Map, whose goal is to reduce CO<sub>2</sub> emissions to half the levels emitted in 2005, by the year 2050.

Aquarea is part of a new generation of heating solutions that use a renewable, free energy source (the air) to heat or cool the home and to produce hot water:

- Extremely high efficiency (COP of 5,08 for 5kW Mono-bloc unit)
- Line up developed for low consumption homes (starting at 3kW)
- T-CAP solution is ideal for cold areas, as it maintains the nominal capacity up to -15°C
- Easy to control with your smart phone (using an optional interface)
- Large range of efficient tanks for domestic hot water storage

### Energy saving



Better efficiency & Value for medium temperature applications. Energy efficiency class up to A++ in a scale from A++ to G.



Better efficiency & Value for low temperature applications. Energy efficiency class up to A++ in a scale from A++ to G.



Better efficiency & Value for Domestic Hot Water. Energy efficiency class up to A in a scale from A to G.

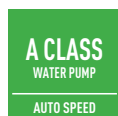

Aquarea are built-in with A class energy efficiency water pump. High efficiency circulating the water in the heating installation.



Panasonic Inverter compressors are designed to achieve outstanding level of performance.

### High Performance



Aquarea High Performance for low consumption houses. From 3 to 16kW. For a house with low temperature radiators or under-floor heating, our high performance Aquarea HP is a good solution. \*COP of 5,08 for 5kW Mono-bloc.



Aquarea T-CAP for extremely low temperatures. From 9 to 16kW. If the most important aspect is to maintain nominal heating capacities even at temperatures as low as -7°C or -15°C, select the Aquarea T-CAP.



Aquarea HT ideal for retrofit. From 9 to 12kW. For a house with traditional high-temperature radiators, the Aquarea HT solution is the most appropriate, can work in output water temperatures of 65°C even at outdoor temperatures as low as -20°C.



DHW. With Aquarea you can also heat your domestic hot water at a very low cost with the optional hot water cylinder.



Down to -20°C in heating mode. The Heat Pumps work in Heat Pump mode with an outdoor temperature is as low as -20°C.



Water filter (easy access & fast clip technology) for H Generation.



Water stop valve included on H Generation.

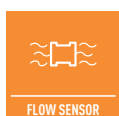

Water Flow Sensor included on H Generation.



We guarantee the outdoor unit compressors in the entire range for five years.



SG Ready: Thanks to Aquarea HPM, Aquarea range (Bi-bloc and Mono-bloc) is holding the SG Ready Label (Smart Grid Ready Label), given by Bundesverband Wärmepumpe (German Heat Pump Association). This Label shows the real capacity of Aquarea to be connected in an intelligent grid control. MCS Certificate number: MCS HP0086.\*



### High connectivity



Renovation. Our Aquarea Heat Pumps can be connected to an existing or new boiler for optimum comfort even at very low outdoor temperatures.



Solar Kit. For even greater efficiency, our Aquarea Heat Pumps can be connected to photovoltaic solar panels with an optional kit.



Remote controller with full dotted 3,5" wide back light screen. Menu with 17 available languages easy to use for installer and user. Included on H Generation.



Internet Control is a next generation system providing a user-friendly remote controller of air conditioning or Heat Pump units from everywhere, using a simple Android or iOS smartphone, tablet or PC via internet.

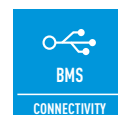

Connectivity. The communication port is integrated into the indoor unit and provides easy connection to, and control of, your Panasonic Heat Pump to your home or building management system.

\* Not all products certified. As the certification process is on-going and the list of certified products constantly changing, please check for latest details on the official websites.

# HOW DO YOU GET HEATING AND DOMESTIC HOT WATER FROM AIR?



Aquarea Air to Water Heat Pump, outstanding seasonal efficiency. At the forefront of energy innovation, Aquarea is resolutely positioned as a “green” heating and air conditioning solution.

### Introducing the Panasonic Aquarea – Air Source Heat Pump

An Aquarea air source Heat Pump circulates fresh air and passes it over refrigerant-filled coils (like a refrigerator). The captured heat is automatically transferred to water, which is then ready for use in your heating system and for supplying all of your domestic hot water needs. Panasonic’s latest technology offers you a sustainable alternative to oil, LPG and electric heating systems.

### “Green” High-efficiency heating with Panasonic’s Air to Water Heat Pump Systems

Panasonic’s Aquarea Heat Pump provides savings of up to 80% on heating expenses compared to electrical heaters. For example, the Aquarea 5kW system has a COP of 5,08. This is 5,08 more than a conventional electrical heating system which has a maximum COP of 1. This is equivalent to an 80%\* saving. Consumption can be further reduced by connecting photovoltaic solar panels to the Aquarea system.

### Why Air Source Heat Pumps?

- Heating, cooling and domestic hot water produced with a single system
- Best in terms of efficiency: even at extreme outdoor temperatures
- Environmentally advanced: can be connected to solar panels
- Technology that adapts to each home: extreme low temp, high temperature, whatever the climate
- Wide range of solutions: floor heating, radiators and fan coils
- Reduced heating bills and maintenance costs
- Reduce your carbon footprint
- Simple to integrate into existing heating systems
- Energy efficient alternative to oil, LPG and electric systems
- Ideal for properties without access to mains gas
- Externally positioned saving valuable internal living space

Aquarea Air to Water Heat Pump: An innovative low energy solution, designed to create great comfort at home even at extreme outdoor temperatures. Providing heat to radiators, underfloor heating, Fan Coils as well as producing domestic hot water.

### Heat Pump: Up to 80% of required heat energy taken from ambient air

Based on Air to Water heat pump technology, Aquarea is highly efficient. It captures heat energy from the ambient air and transfers it to heat the water needed to warm your home and domestic hot water - it can even cool your home as required. Compared to other technologies, up to 80% of the heat energy required is taken from the ambient air - even in extremely low temperatures.



### Energy consumption comparison.

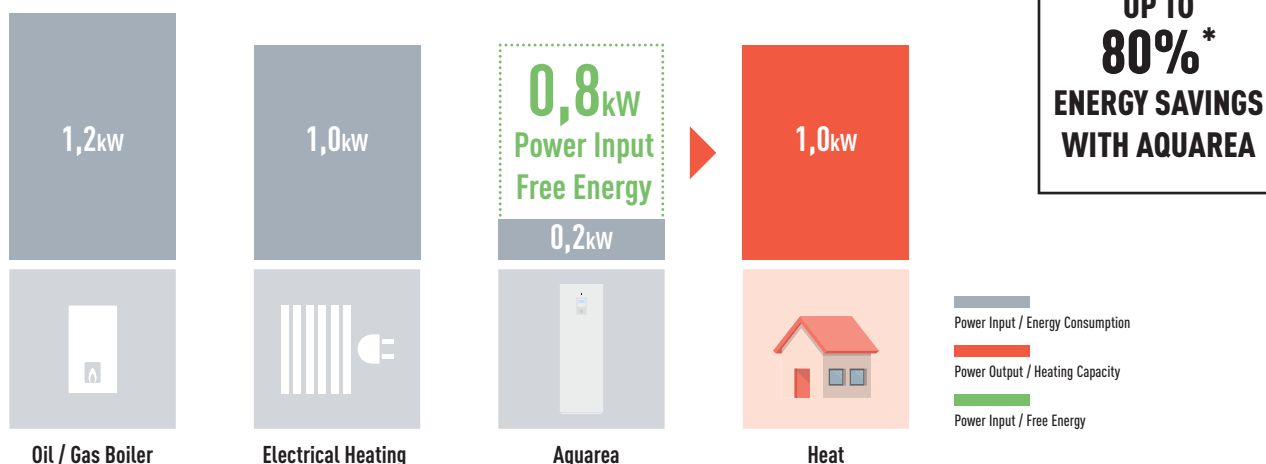

\* Rating conditions: Heating: Inside air temperature: 20°C Dry Bulb / Outside air temperature: 7°C Dry Bulb / 6°C Wet Bulb. Conditions : Water input temperature: 30°C Water output temperature: 35°C.

# AQUAREA HEAT PUMP LINE-UP

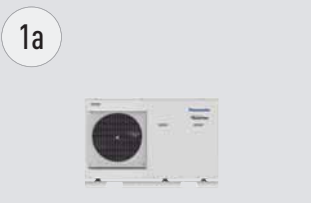
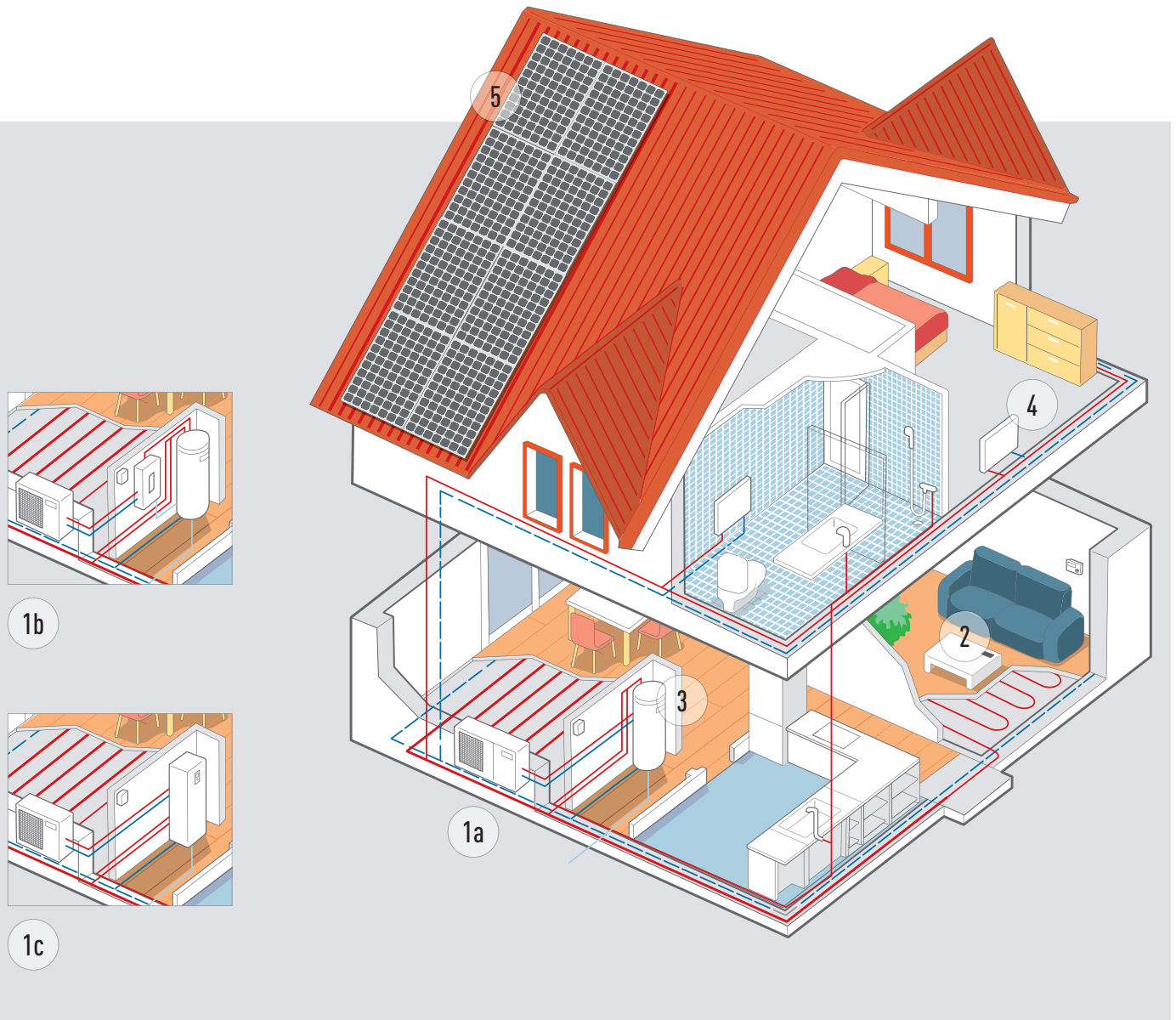

**Mono-bloc system.**

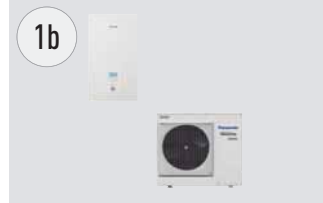

**Bi-bloc system.**

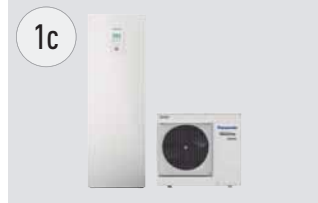

**All in One system.**



**Control through smart phone, tablet or computer (optional).**

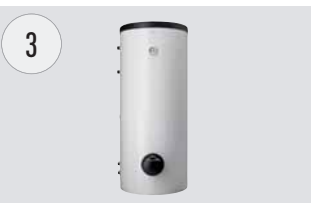

**Super High Efficiency cylinder (optional).**



**High efficient radiators for heating and cooling (optional).**



**New versatile and efficient fan coil (optional).**

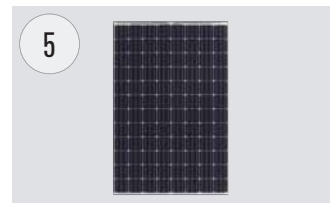

**Heat Pump + HIT Photovoltaic solar panel (optional).**



Panasonic Aquarea offers you solutions, helping to make the home more efficient and the installation cheaper and easier.

**Aquarea High Performance. For new installations and low consumption homes**

Outstanding efficiency and energy savings with minimised CO<sub>2</sub> emissions and minimum space. Improved performance with COP's up to 5,08.

**Aquarea T-CAP. For extremely low temperatures, refurbishment and innovation**

Ideal to ensure that the heating capacity is maintained even at very low temperatures. This line-up is able to maintain the Heat Pump output capacity until -20°C outdoor temperature without the help of an electrical booster heater.

**Aquarea HT. For a house with old high-temperature radiators**

Ideal for retrofit: green energy source works with existing radiators. Aquarea HT Solution is the most appropriate, provides output water temperatures of 65°C even at outdoor temperatures as low as -15°C.

**Aquarea DHW**

A energy class in all tanks.  
Possible to connect to solar plant or boiler.  
SG Ready available.

Aquarea High Performance	Aquarea T-CAP	Aquarea HT	Aquarea DHW
Mono-bloc Bi-bloc All in One	Mono-bloc Bi-bloc All in One	Mono-bloc Bi-bloc	
Heating - Cooling - DHW	Heating - Cooling - DHW	Heating - DHW	Only DHW
Single Phase from 3 to 16kW Three Phase from 9 to 16kW	Single Phase from 9 to 12kW Three Phase from 9 to 16kW	Single Phase from 9 to 12kW Three Phase from 9 to 12kW	From 80 to 295L
<b>Connectable to</b>			
Radiators - Fan Coil - Underfloor heating - DHW	Radiators - Fan Coil - Underfloor heating - DHW	Traditional high-temperature radiators - DHW	Domestic hot water
<b>Application</b>			
Normal installation	For extreme cold ambient	Retrofit for old radiators	Only DHW
<b>Energy efficiency</b>			
Heating 35°C / 55°C	Heating 35°C / 55°C	Heating 35°C / 55°C	Floor standing DHW 65°C / Wall mounted DHW 55°C
<b>Outdoor ambient temperature limit. Operation</b>			
-20°C	-28°C	-20°C	-7°C
<b>Outdoor ambient temperature limit. Constant capacity (35°C)</b>			
-7°C	-20°C	-15°C	
<b>Supply temperature for heating. Max. / Heat pump only</b>			
75°C / 55°C	75°C / 60°C <sup>1</sup>	75°C / 65°C	75°C / 65°C / 55°C
<b>Control and connectivity</b>			
Smart Grid Ready <sup>1</sup>	Smart Grid Ready <sup>1</sup>	Smart Grid Ready <sup>1</sup>	Smart Grid Ready <sup>1</sup>
Wireless Lan Ready	Wireless Lan Ready	Wireless Lan Ready	
<b>Range</b>			
Bi-bloc from 3 to 16kW Mono-bloc from 5 to 16kW All in One from 3 to 16kW (185L)	Bi-bloc from 9 to 16kW Mono-bloc from 9 to 16kW All in One from 9 to 16kW (185L)	Bi-bloc from 9 to 12kW Mono-bloc from 9 to 12kW	From 80 to 295L

All data in this chart is applicable in most of models in each line up, check product specs to confirm. 1) H Generation with CZ-NS4P, F and G Generation with Heat Pump Manager.

# AQUAREA H GENERATION A+++



The beauty of comfort. The H Generation is being introduced from 3 to 16kW. The small capacities are specially designed for low energy homes and achieve an impressive COP of 5 (on the 3kW).

### Better Efficiency & Value A++/A++

- A++ for medium temperature applications (radiators. ErP 55°C)
- A++ for low temperature applications (floor heating. ErP 35°C)
- 3 & 5 kW models will meet the energy efficiency class A+++ as applicable from Sept. 2019

### Aquarea, a new generation of energy efficient heating and hot water

Thanks to the system's high degree of technology and advanced control, it is able to maintain a high output capacity and efficiency even at -7°C and -15°C. The Aquarea's software can be set for the requirements of low consumption homes in order to maximise energy efficiency. Whatever the weather, Aquarea can work even at -28°C lower limit. The compact design of the outdoor unit makes installation very easy.

### Design

Improved square design with white goods finish. Modern remote controller can be installed up to 50m from the indoor unit.

### Installer Friendly:

- Electrical connections is now located on front side
- Easy access to parts and easy to install by having all pipings in a row
- Remote controller with full dotted wide screen and new functions
- Can connect additional room temperature sensor, solar kit, 2 zones control, swimming pool and circulating pump (need optional PCB: CZ-NS4P)

### Compact and free space. More value in 1 compact space:

- Line strainer (easy access & fast clip technology)
- Isolation valves
- Electronic flow sensor
- 3 way valve ready (optional CZ-NV1 in internal space)

### All in One with 2 zones control

- 2 heating circuits, with 2 different water temperatures
- 2 water pumps and 2 water filters
- Floor heating water control with mixing valve

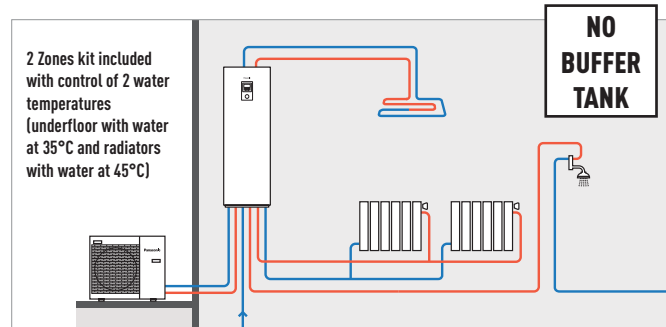

### All in One, compact and easy to install

Space-saving solution ideal for installations with restricted space. In addition, Panasonic has developed bivalent and cascade systems that give the user control of two heating zones.

The Aquarea All in One belongs to the new generation of Panasonic heat pumps for heating, cooling and providing domestic hot water in the home. Aquarea T-CAP is one of the newest heat pumps on the market, maintaining nominal heating capacities even at temperatures as low as -20°C\*. This ensures the best possible seasonal energy efficiency ratio. The heat pumps are tested at an outdoor temperature of -28°C to ensure stable operation.

BEST IN TEST 2017: \* Applies to All in One T-CAP 9kW H Generation Three Phase at 35°C water outlet temperature test: The highest measured SCOP (energy efficiency) of all air/water heat pumps, in the corresponding category, that have been published on the heat pump list of the Danish Technological Agency: [sparenergi.dk/forbruger/vaerktoej/](http://sparenergi.dk/forbruger/vaerktoej/)

### Aquarea Smart Cloud for H Generation

#### The most advanced heating control for today and for the future:

Easy and powerful energy management. The Aquarea Smart Cloud is much more than a simple thermostat for switching a heating device on or off. It is a powerful and intuitive service for remotely controlling the full range of heating and domestic hot water functions, including monitoring energy consumption, Malfunction notification, Failure & Remote Servicing as some options.

### Advanced Control

**Ease of use:** Remote controller with full dotted 3,5" wide back light screen provides clearer visibility to the user.

**Relocation:** Remote controller can be installed up to 50m from the indoor unit.

### Accessory

Optional PCB (CZ-NS4P). With this PCB you can also manage one or more functions like below: SG Ready, 0-10V demand signal, 2-zones control function (pump + mixing valve), solar and external switch (heat / cool).

# AQUAREA HIGH PERFORMANCE



For new installations and low consumption homes.  
 Outstanding efficiency and energy savings with minimised CO<sub>2</sub> emissions and minimum space.

### High Performance helps you to meet strict building requirements and reduce building costs

The heating and production of domestic hot water have a very important impact on the energy consumption of a house. Efficient Panasonic Heat Pumps can help to significantly reduce the energy consumption of the house.

#### Key points of the line-up

- Improved performance with COP's up to 5,08
- Reduced energy consumption through our circulating pump with energy efficiency class "A"
- Remote controller functions added: Auto mode, holiday mode, power consumption display

Panasonic has designed the Aquarea Bi-bloc and Mono-bloc Heat Pumps for homes which have high performance requirements. Whatever the weather, Aquarea can work even at -20°C! The Aquarea is easy to install on new or existing installations, in all types of properties.

### High Performance Pumps are also Highly Efficient (take the WH-MDC05F3E5 for example)

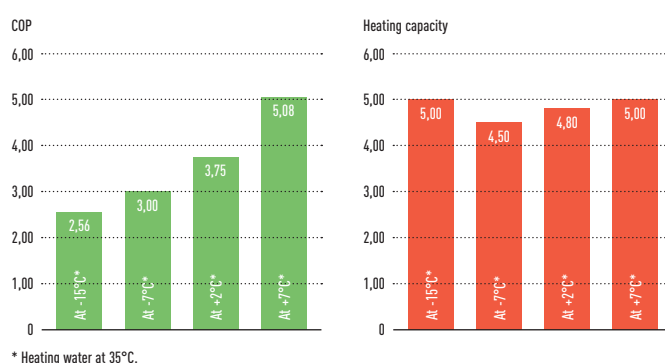

### Standard circulating pumps vs our circulating pump with energy efficiency class "A"

Comparison of energy consumption of circulation pumps. Circulating pump with energy efficiency class "A" with Dynamic flow control for 5kW Mono-bloc.

\* Based on German market: Assuming Standard pump may vary depending on consumption and energy cost.

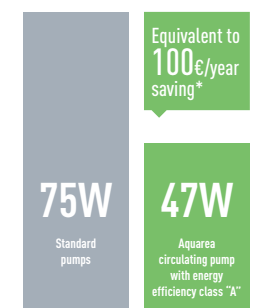

### Panasonic created a night mode to reduce the noise when it's needed

Special attention has been given to noise levels

1. Sound pressure measured at 1m from the outdoor unit and at 1,5m height.
2. At standard condition working at heating capacity at +7°C (heating water at 35°C) for two fans outdoor units. For one fan outdoor units, night mode reduction is 3dB(A).

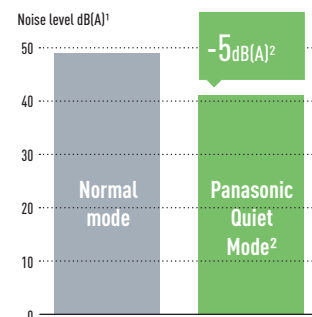

### Advanced Controller for H Generation



Improved visibility & Easy operation with large full dot LCD display and large touch panel!

Remote controller can be removed from indoor unit and installed in living room.

#### Key Points:

Full large dot LCD screen (3,5 inch): High resolution screen with backlight, easy set up, check conditions easily, flat, innovative design, temperature sensor included in controller.

### Remote controller

Panasonic has introduced a remote controller to improve performance, enhance comfort and improve even more the savings of the system.

#### Function for installer:

- Floor heating concrete dry mode: Allows for a slow increase in temperature of underfloor heating via software.
- Heating and Cooling Mode: Authorised PRO Partners can enable the cooling mode through a special operation via the remote controller on site
- Installer can select delta T. Water pump speed is selected automatically due to this setting

#### Function for End User:

- Auto Mode: Automatically changes from heating to cooling depending on outdoor temperature.
- Energy Consumption Display: Displays the Heat Pump's energy consumption, split by heating, cooling and domestic hot water, showing the total consumption figure.
- Holiday Mode: Enables the system to resume at the preset temperature after your holiday

# AQUAREA T-CAP



For retrofit and new builds, install the T-CAP heat pump where the kW output capacity is demanding.

### Ensure the heating capacity is maintained even at low temperatures

The whole T-CAP line-up can replace old gas or oil boilers, and in a new application with underfloor heating, radiators or even fan-coil heaters, the whole T-CAP line-up is an ideal replacement for old gas/oil boilers. All Aquarea heat pumps can also be connected to a solar thermal or PV system in order to increase efficiency and minimise the impact on the ecosystem.

### Higher efficiency compared to other heating systems

Panasonic Heat Pumps have a maximum COP of 4,85 at +7°C which makes them much more efficient than others heating systems.

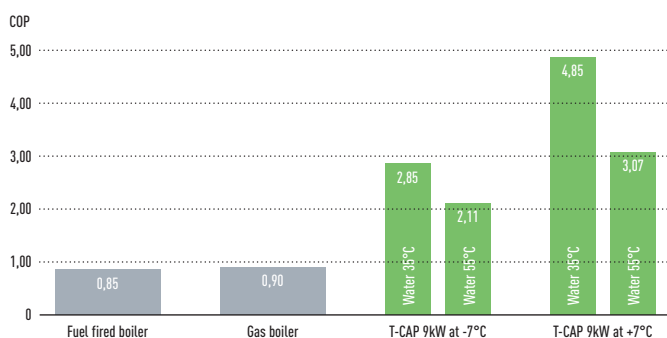

### More Energy saving

T-CAP is also able to provide extremely high efficiencies, whatever the outside or the water temperature.

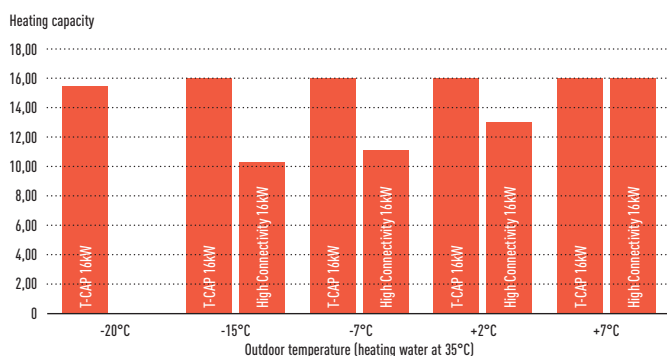

### Key points of the line-up

- Ability to maintain the heat pump kW<sup>1</sup> output capacity until -20°C outdoor temperature without the help of an electrical booster heater
- High heating capacity even at low ambient temperatures
- Additional functions: Auto and holiday mode, boost, drying concrete and power consumption display
- Backup heater capacity can be selected depending on the model (3/6/9kW)
- Cooling mode activation possible via software<sup>2</sup>

1) At 35°C flow. 2) This activation can only be done by service partner or installer.

### With a Panasonic heat pump, there is no need to oversize in order to reach the required capacity at low temperatures

- Panasonic's unique software and inverter technology for low consumption houses, allows the heat pump to produce heating water at 35°C. When only a little heating is required due to warmer outside air temperature
- All Aquarea heat pump's have a 10L expansion vessel fitted internally
- Aquarea heat pump's has an inverter compressor which can regulate the output capacity depending on demand
- Twin dice system included within the system (Twin fan outdoor unit)
- 3/6/9kW electrical heater is included in the heat pump (depending on unit)
- Panasonic heat pumps can work in outdoor temperatures as low as -28°C and guarantee the capacity without backup heating down to -20°C<sup>1</sup>
- Panasonic heat pumps are very quiet and have a noise reduction setting for night mode. See noise calculator on [www.panasonicproclub.com](http://www.panasonicproclub.com)

1) 35°C flow temperature.

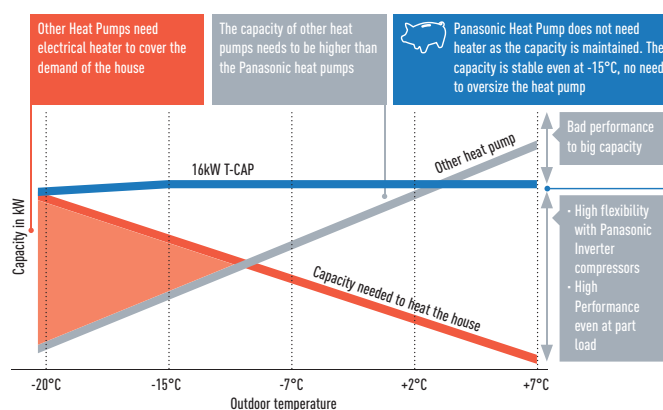

### New Aquarea Super Quiet T-CAP Bi-bloc

The special outdoor chassis notably reduces operation sound by up to 11dB (when setting at quiet mode level 2 WH-UQ12HE8).



# AQUAREA HT

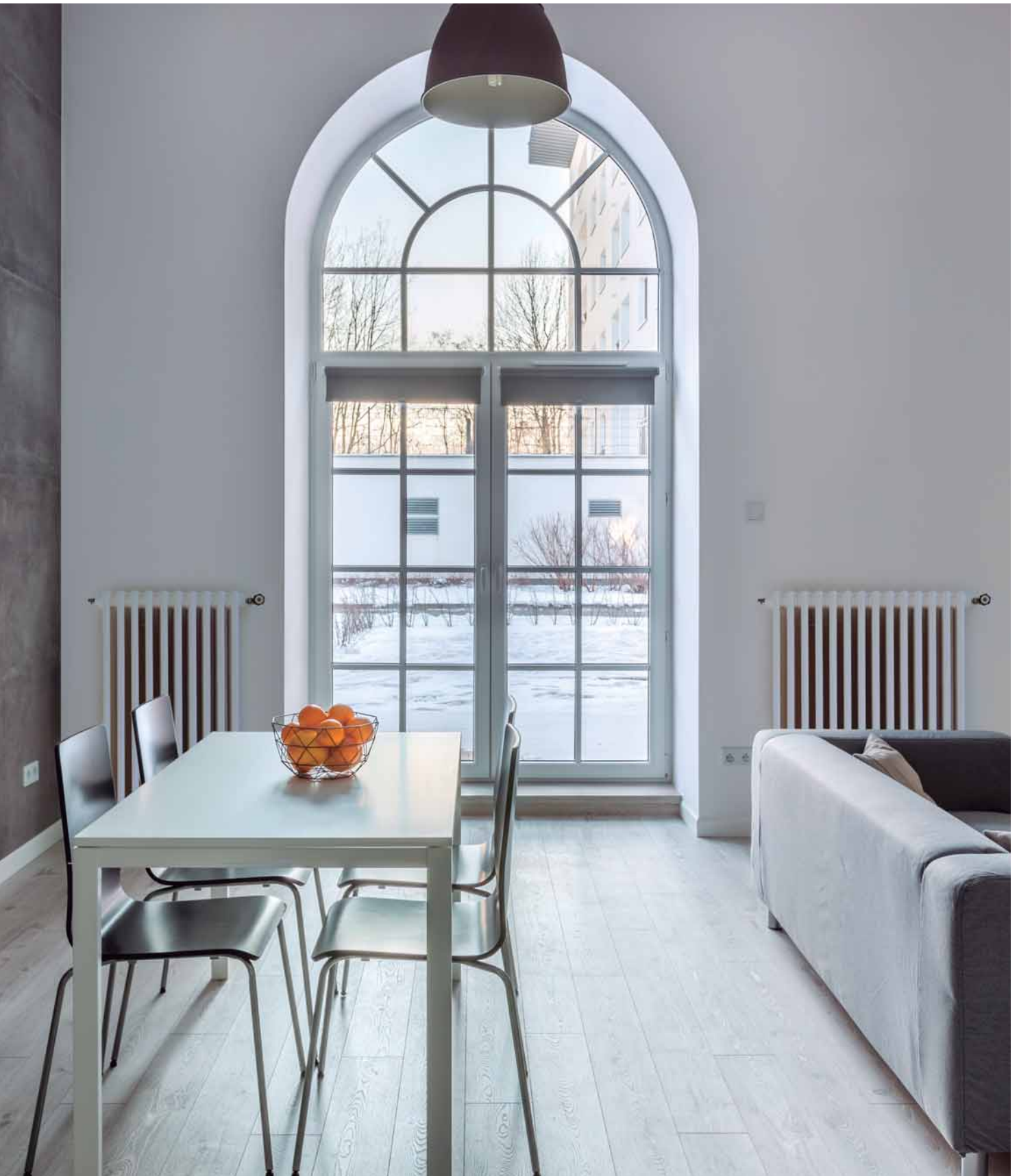



Aquarea HT can produce a flow temperature of 65°C making it the ideal high efficiency replacement for oil/gas boilers connected to high temperature radiators.

### Green energy source works with existing radiators

The Aquarea HT (9kW & 12kW) allows you to replace your traditional heating source (such as oil or gas) while keeping the existing old style radiators for minimum disruption to the home.

### Aquarea HT: High savings and low CO<sub>2</sub>

The benefit of replacing a traditional heating systems with Aquarea HT are clear: Reduced CO<sub>2</sub> emissions, future proofing running costs. Panasonic Heat Pumps are much more efficient than fossil fueled boilers and help you to reach your house energy targets.

### Yearly savings with Aquarea HT

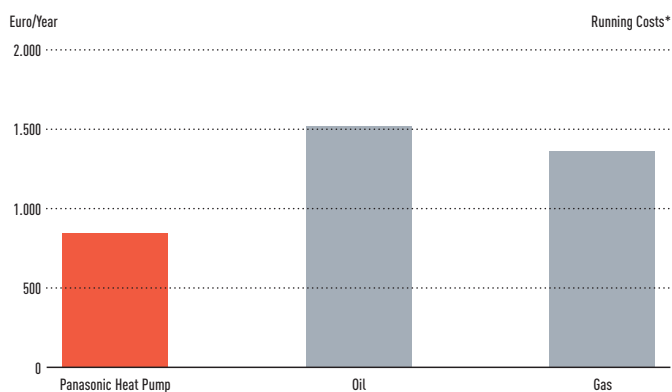

\* For a 170m<sup>2</sup> house and 40 W/m<sup>2</sup> energy losses in central Europe Conditions, outside minimum conditions -10°C.

### Panasonic Aquarea HT is highly efficient even at low outdoor temperatures

Heating Capacity of a 9kW HT (WH-SHF09F3E5).

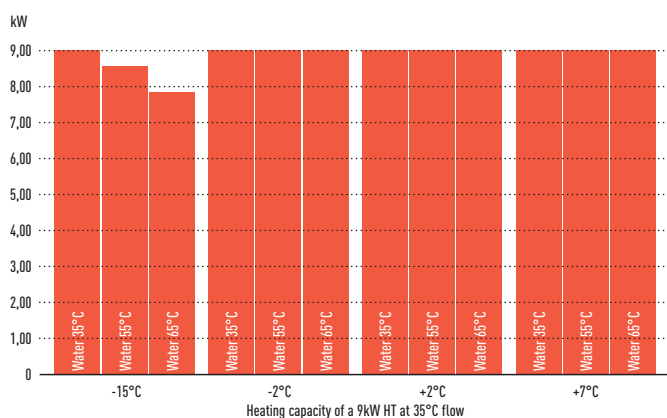

### Smart Bivalent operation

Using the Aquarea bivalent controller, it is now possible to combine different heat sources (boiler with heat pump) allowing to set up the system to operate in the most efficient way.



### Heat Pump + Boiler with DHW cylinder controlled by the smart bivalent controller.

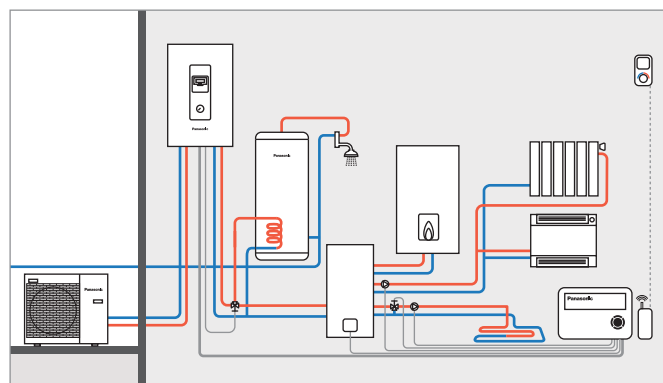

### Easy installation

Air source Heat Pumps are simple to install. They do not require a chimney, gas connection or oil/lpg tank. All that is required is a power supply connection.

COP (Coefficient of Performance) of a 9kW HT (WH-MHF09G3E5).

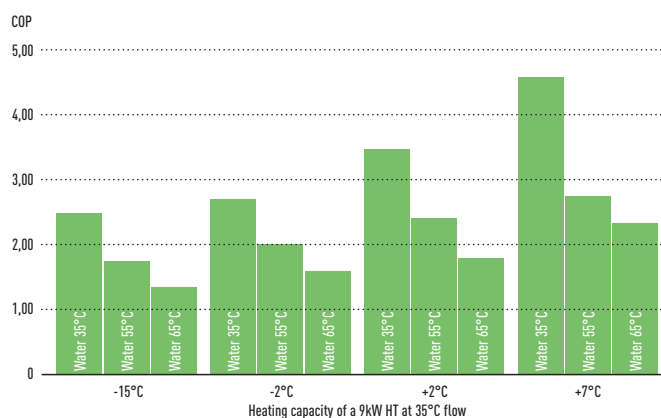

The Aquarea HT range is easy to install and is available with nominal heat outputs of 9kW or 12kW. These can be either single or three phase, in both Bi-bloc and Mono-bloc versions.

# AQUAREA COMMERCIAL

Restaurant with Aquarea

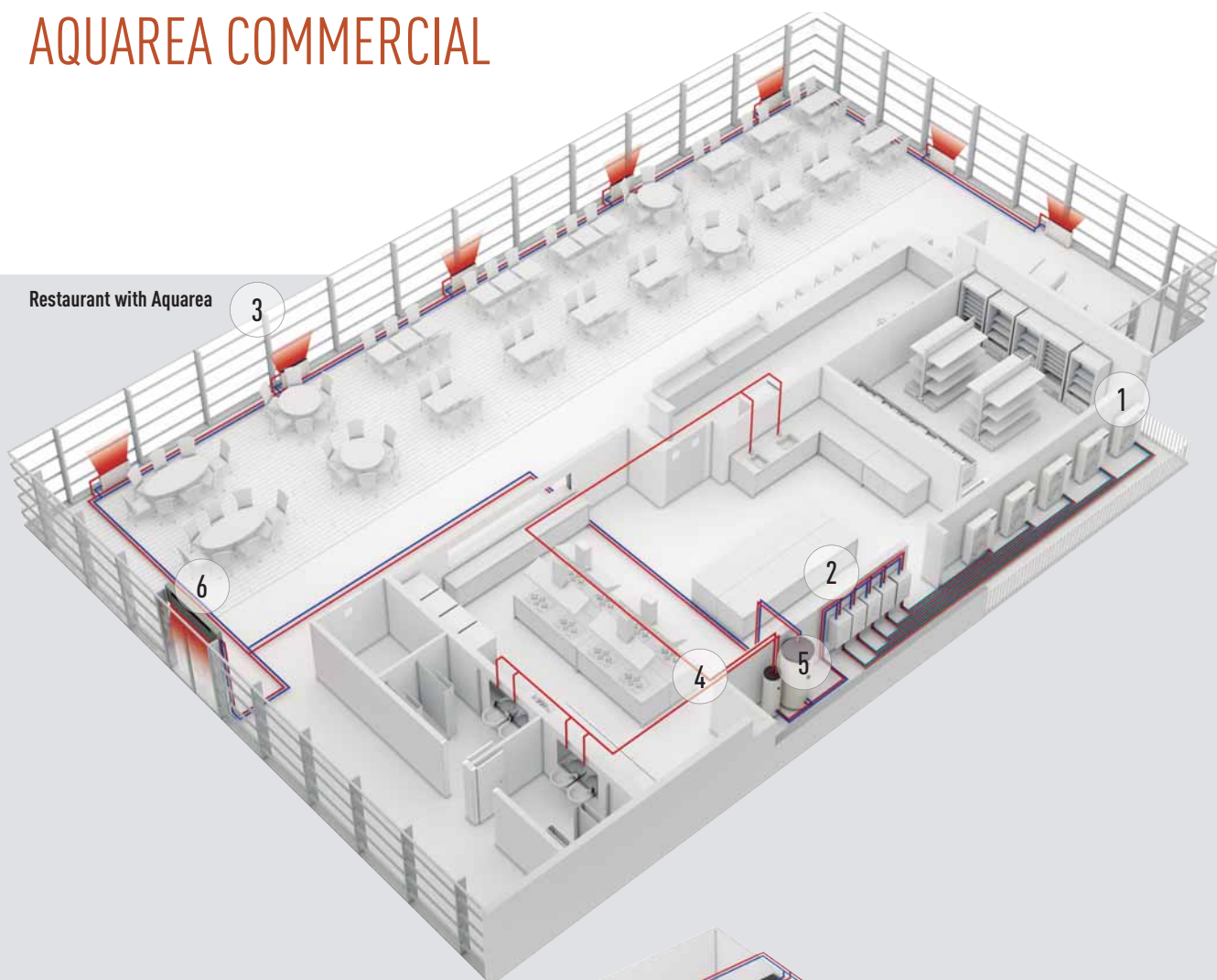

Supermarket with Aquarea

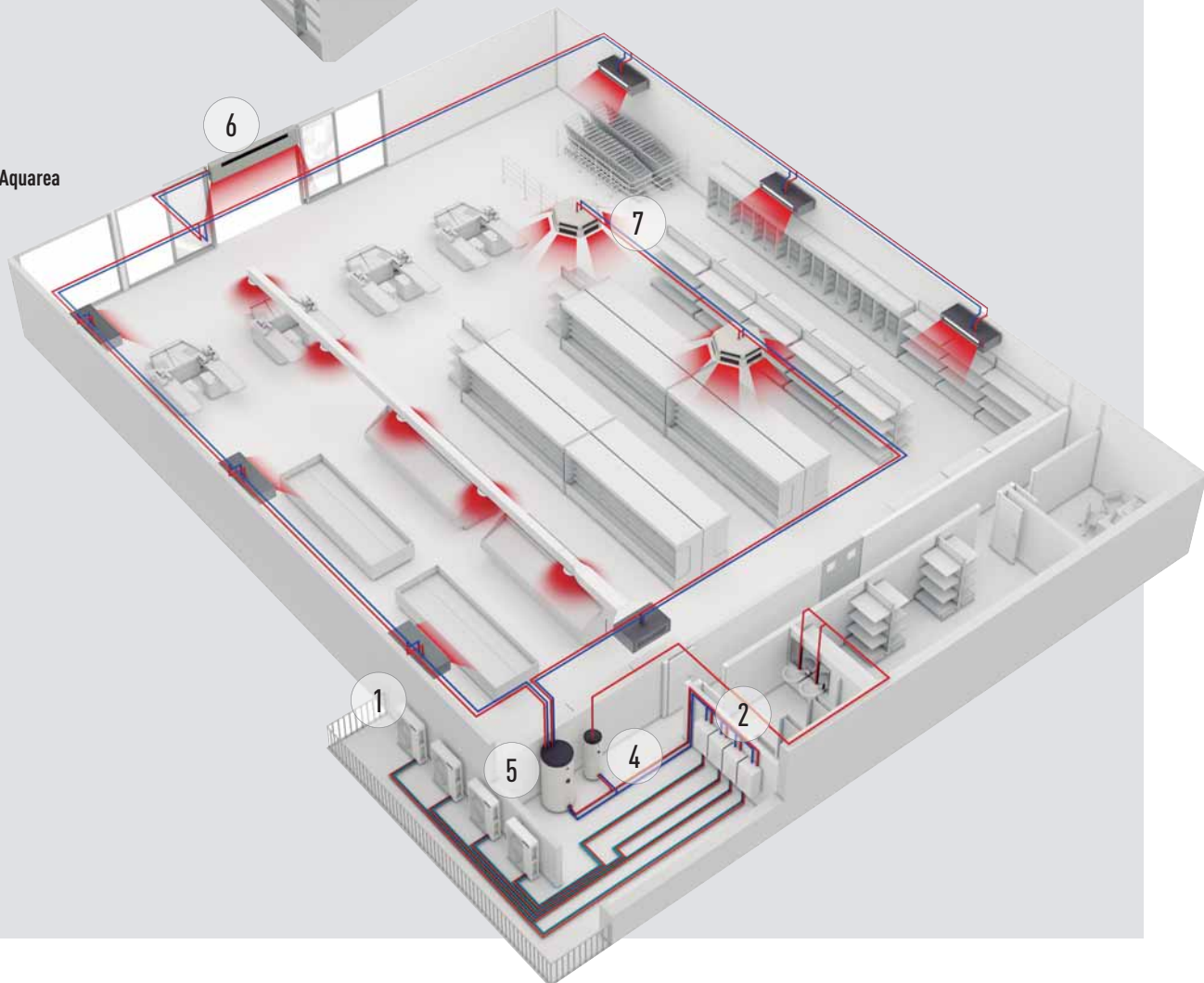

**Solutions for best savings. Efficient Panasonic Heat Pumps can help to significantly reduce the energy consumption of your business. Recent improvements to air source Heat Pump technology, including compact single unit systems, can provide an ideal housing and commercial solution.**

They offer space saving, energy-efficient heating and can be easily adapted for installation in flats, houses and commercial premises. Businesses producing heat, such as restaurants, installing an Aquarea Heat Pump system can also use this wasted heat to improve energy efficiency further.

### Restaurant with Aquarea

If you are looking for savings for your business, Aquarea is the right choice! Ideal for heating, cooling and for production of big quantities of hot water at 65°C, Aquarea have a quick return on investment and a low carbon footprint.

#### Key points:

- Produce hot water efficiency
- Fast return of investment
- Easy control

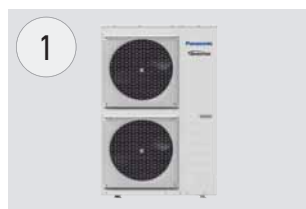

**Aquarea T-CAP.**  
Heat Pump 16kW on cascade mode.

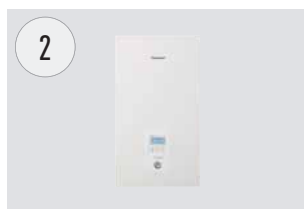

**High Efficiency Aquarea Hydrokit.**



**High efficiency Aquarea Air radiators.**  
32% more efficient than standard radiators.



**New versatile and efficient fan coils.**  
Innovation for an optimum comfort.

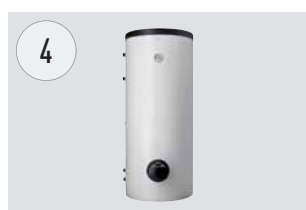

**Super high efficiency Tanks.**  
From 200L to 500L for domestic hot water.



**Buffer Tank of 1000L.**



**Air Curtain with DX Coil.**  
Designed for smooth operation and efficient performance.



**Convectors.**

### Supermarket with Aquarea

Heat pump technology is scalable, meaning that it can be installed in buildings of varying sizes, offering both small- and large-scale heating solutions. The technology is also environmentally friendly when compared to traditional heating systems alternatives based on fossil fuel energy and in addition it is more energy efficient.

#### Can be integrated in the water system.

Easy connection to existing system

- Fan Coils
- Floor Heating
- 4 way and 2 way convectors
- Domestic hot water tanks
- High efficiency
- Very good part load management

### Case study: Carluccio's restaurant

On of UK's leading Italian restaurant, Carluccio's, wanted to install a system which would provide the desired volume of hot water, at the correct temperature while at the same time reduced energy costs. Previous restaurants in the chain had been fitted with a more traditional 12kW boiler system. FWP installed a 12kW Aquarea T-CAP mono bloc unit which would allow for the free air from the kitchen roof space to be transferred through

condensing unit providing hot water at the optimum temperature. With a high coefficient of performance (COP), the system returns an impressive 4kW of energy, for every kW used. This makes the Aquarea far more cost effective than a conventional heating system. To heat the water for their Leeds restaurant cost £3782 whilst at the Meadowhall site the comparable cost was just £951. These sizeable savings mean the site will see a return on investment in approximately 2 years.

# AQUAREA SMART & SERVICE CLOUD

## 1 AQUAREA SMART CLOUD FOR END USERS



### Easy and powerful energy management

The Aquarea Smart Cloud is much more than a simple thermostat for switching a heating device on or off. It is a powerful and intuitive service for remotely controlling the full range of heating and hot water functions, including monitoring energy consumption.

### How does it work?

Connect Aquarea H Generation system to the cloud using wireless LAN or a wired LAN Network. User connects to the Cloud portal to remotely operate all unit functions and can also permit partners to access customised functions for remote maintenance and monitoring. See demo:

<https://aquarea.aircon.panasonic.eu>

### Requirements.

1. H Generation Aquarea system
2. In-house internet connection with router wireless LAN or wired LAN
3. Get a Panasonic ID in <https://aquarea-smart.panasonic.com/>

### Functions:

- Visualization & Control
- Scheduling
- Energy Statistics
- Malfunction notification



\* User interface image may change without notification.

### Advantages

Energy savings, comfort and control from anywhere. Increase efficiency and resources management, operating costs savings and owner satisfaction. The Aquarea Smart Cloud services are focused on enabling full remote maintenance of the Aquarea system. This allow maintenance specialists to engage in predictive maintenance and system fine-tuning, as well as fixing malfunctions when they occur.

Aquarea compatibility	H Generation
Connection point	CN-CNT Aquarea port
Home router connection	Wireless or Wired LAN
Temperature sensor	Can use remote controller sensor
Tablet or PC browser compatibility*	Yes
Operation from remote — On/Off — House Temp setting mode selection — DHW setting — Error codes — Scheduling	Yes
Heating areas	Up to 2 zones
Power consumption estimation — Operation log history	Yes — Yes

\* Check browsers and version compatibility.

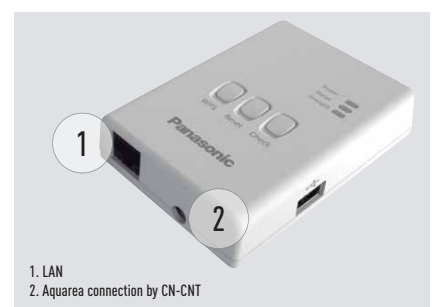

1. LAN  
2. Aquarea connection by CN-CNT

The most advanced heating control for today and for the future.  
Aquarea connect to Cloud with CZ-TAW1, opening 2 different platforms.



# 2 AQUAREA SERVICE CLOUD FOR INSTALLERS / MAINTENANCE



### The real remote maintenance made simple

The Aquarea Service Cloud allows to installers to take care remotely of their customers heating systems. Saving time, money and shortening response time increasing customer satisfaction.

### Advanced functions for remote maintenance with professional screens:

- Global view at a glance
- Error log history
- Full unit information
- Statistics always available
- All settings available

#### Home page.

All users connected status at a glance. 2 view options: Map view or list view only.

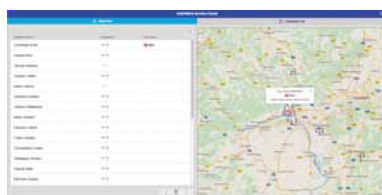

#### Statistics tag.

Customisable statistics of a maximum 73 parameters. Available anytime with the information of last 7 days.

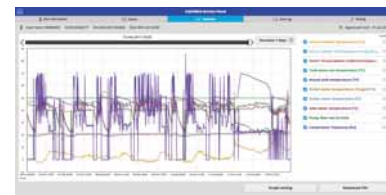

#### Status tag.

Current status of unit with a maximum 28 parameters.



#### Settings tag.

Full settings of system remotely including user and installer settings.



## Activation Aquarea Service Cloud

### Requirements.

Hardware and connection	End user registration	Installer / maintenance registration
H Generation Aquarea connected to CZ-TAW1	Get Panasonic ID	Get Service ID
In house internet connection with Wireless LAN or Wired LAN	Aquarea Smart Cloud	Aquarea Service Cloud

### Connecting unit to installer/maintenance.

Process can be initiated either both by end user or by installer. Whenever end user can select/change level of control is giving to installer (4 levels).

Installer registration: <https://aquarea-service.panasonic.com/>

End user registration: <https://aquarea-smart.panasonic.com/>

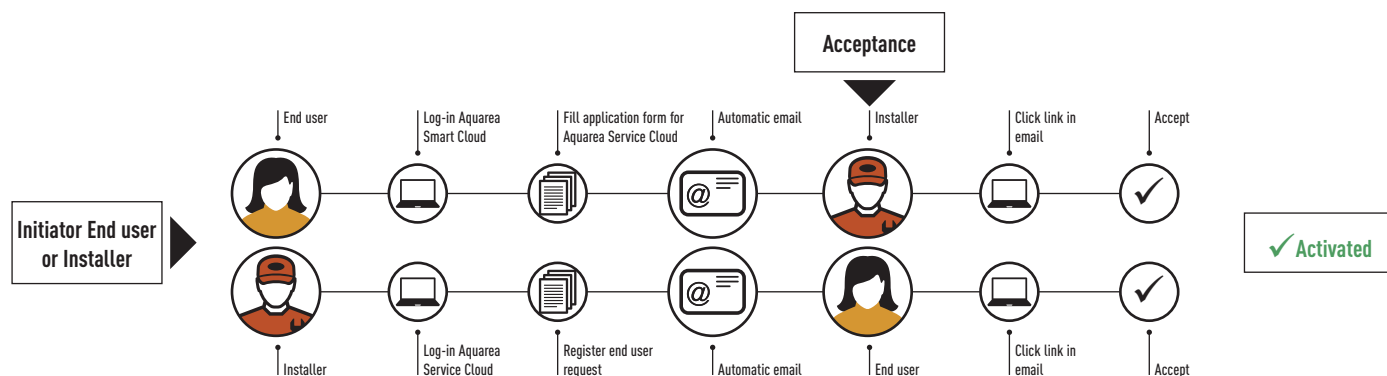

# CONTROL & CONNECTIVITY



Home connectivity and Home Managements Systems integration is becoming more and more popular. These integrations helps to control all house devices from centralised platform and helps to optimise the operation and running costs. Panasonic interfaces are made to work with

both Modbus and KNX, the most populars protocols. Also for non integrated control, Panasonic developed a simple connection to Wireless LAN, with this End User can control remotely its own heat pump from wherever.

## Connectivity. Control by BMS

Great flexibility for integration into your KNX / Modbus projects allows fully bi-directional monitoring and control of all the functioning parameters.

Reference	 PAW-AW-KNX-1i / PAW-AW-KNX-H	Modbus® PAW-AW-MBS-1 / PAW-AW-MBS-H
	Small dimensions	✓
Quick installation and possibility of hidden installation	✓	✓
External power not required	✓	✓
Direct connection to the unit	✓	✓
Control and monitoring, from sensors or gateways, of the internal variables of the indoor unit and error codes and indication	✓ Fully interoperable	
Control and monitoring, from any BMS or PLC Modbus Master, of internal variables of the indoor unit and error codes and indication		✓ Fully interoperable
Aquarea unit can be controlled simultaneously by its remote controller and by KNX / Modbus Master devices	✓	✓

These interfaces allows full monitoring and control, bi-directional, of all the functioning parameters of Aquarea control from KNX / Modbus installations.

Model name	Interface
PAW-AW-KNX-H	KNX interface for H Generation
PAW-AW-MBS-H	Modbus interface for H Generation
PAW-AW-KNX-1i	KNX interface (not compatible with H Generation)
PAW-AW-MBS-1	Modbus interface (not compatible with H Generation)
PA-AW-WIFI-1TE	Internet control WLAN connection (not compatible with H Generation)
CZ-TAW1	Aquarea Smart Cloud, H Generation Internet control through wireless or wired LAN

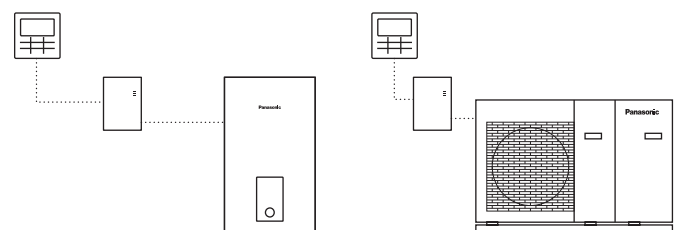

# AQUAREA + PV PANELS



Aquarea H Generation can synchronize with PV panels with simple CZ-NS4P PCB. A part of converting Aquarea in Smart Grid Ready, there is a new advantage, this new PCB allows 0-10V control. With this Aquarea demand is adapting all moment with the PV panel production. Innovative algorithm balancing the heat pump's consumption and the in-house comfort, based on the outside temperature and the energy demand of the building.



## Heat up Domestic Hot Water for free.

### Comparison on new housing.

#### Increase usage of self production by: 120%

The Panasonic Aquarea PV Control could increase the energy usage of the heat pump coming from the Photovoltaic panels from 352kWh to 775kWh a year. Results of simulations:

#### New building Frankfurt (non-optimized).

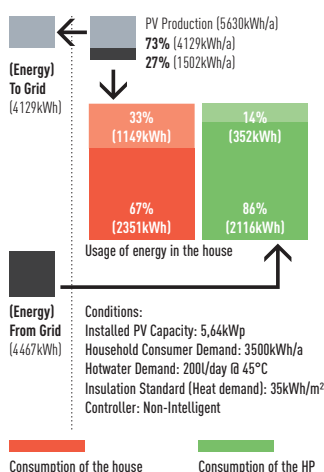

#### New building Frankfurt (optimized-eco).

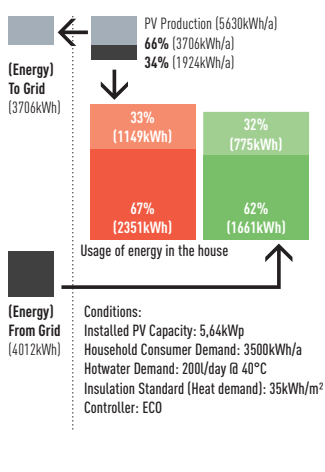

### Comparison on old housing.

#### Increase usage of self production by: 71%

The Panasonic Aquarea PV Control could increase the energy consumption of the heat pump coming from the Photovoltaic Panels from 526kWh to 898kWh a year. Results of simulations:

#### Old building Frankfurt (non-optimized).

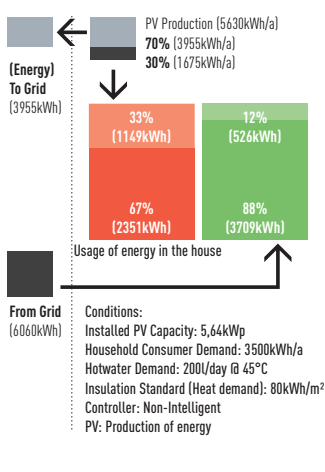



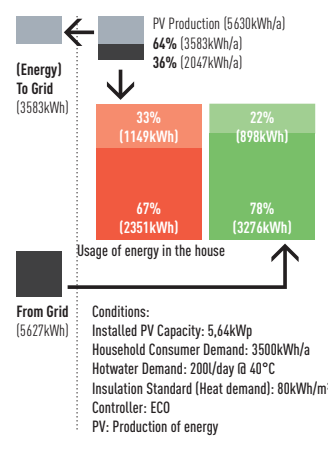



















#### Old building Frankfurt (optimized-eco).



Consumption of the house Consumption of the HP

# AQUAREA HEAT PUMPS LINE-UP

		3kW	5kW	7kW
<b>Aquarea High Performance for well insulated houses</b> 	<b>P. 42-43</b> <b>All in One</b> Single Phase Three Phase 	 WH-ADC0309H3E5 WH-ADC0309H3E5B WH-UD03HE5-1	 WH-ADC0309H3E5 WH-ADC0309H3E5B WH-UD05HE5-1	 WH-ADC0309H3E5 WH-ADC0309H3E5B WH-UD07HE5-1
	<b>P. 46-47</b> <b>Bi-bloc</b> Single Phase Three Phase 	  WH-SDC03H3E5-1 WH-UD03HE5-1	  WH-SDC05H3E5-1 WH-UD05HE5-1	  WH-SDC07H3E5-1 WH-UD07HE5-1
	<b>P. 50</b> <b>Mono-bloc</b> Single Phase 		 WH-MDC05H3E5	 WH-MDC07H3E5
<b>Aquarea T-CAP High Capacity for cold areas</b> 	<b>P. 44-45</b> <b>All in One</b> Single Phase Three Phase 			
	<b>P. 48-49</b> <b>Bi-bloc</b> Single Phase Three Phase 			
	<b>P. 51</b> <b>Mono-bloc</b> Single Phase Three Phase 			
<b>Aquarea HT for retrofit</b> 	<b>P. 52</b> <b>Bi-bloc</b> Single Phase Three Phase 			
	<b>P. 53</b> <b>Mono-bloc</b> Single Phase 			



9kW



WH-ADC0309H3E5  
WH-ADC0309H3E5B  
WH-UD09HE5-1  
WH-ADC0916H9E8  
WH-UD09HE8



WH-SDC09H3E5-1  
WH-UD09HE5-1  
WH-SDC09H3E8  
WH-UD09HE8



WH-MDC09H3E5



WH-ADC1216H6E5  
WH-UX09HE5  
WH-ADC0916H9E8  
WH-UX09HE8  
WH-ADC0916H9E8  
WH-UQ09HE8



WH-SXC09H3E5  
WH-UX09HE5  
WH-SXC09H3E8  
WH-UX09HE8  
WH-SQC09H3E8  
WH-UQ09HE8



WH-MXC09H3E5  
WH-MXC09H3E8



WH-SHF09F3E5  
WH-UH09FE5  
WH-SHF09F3E8  
WH-UH09FE8



WH-MHF09G3E5

12kW



WH-ADC1216H6E5  
WH-UD12HE5  
WH-ADC0916H9E8  
WH-UD12HE8



WH-SDC12H6E5  
WH-UD12HE5  
WH-SDC12H9E8  
WH-UD12HE8



WH-MDC12H6E5



WH-ADC1216H6E5  
WH-UX12HE5  
WH-ADC0916H9E8  
WH-UX12HE8  
WH-ADC0916H9E8  
WH-UQ12HE8



WH-SXC12H6E5  
WH-UX12HE5  
WH-SXC12H9E8  
WH-UX12HE8  
WH-SQC12H9E8  
WH-UQ12HE8



WH-MXC12H6E5  
WH-MXC12H9E8



WH-SHF12F6E5  
WH-UH12FE5  
WH-SHF12F9E8  
WH-UH12FE8



WH-MHF12G6E5

16kW



WH-ADC1216H6E5  
WH-UD16HE5  
WH-ADC0916H9E8  
WH-UD16HE8



WH-SDC16H6E5  
WH-UD16HE5  
WH-SDC16H9E8  
WH-UD16HE8



WH-MDC16H6E5



WH-ADC0916H9E8  
WH-UX16HE8  
WH-ADC0916H9E8  
WH-UQ16HE8



WH-SXC16H9E8  
WH-UX16HE8  
WH-SQC16H9E8  
WH-UQ16HE8



WH-MXC16H9E8

# AQUAREA HIGH PERFORMANCE ALL IN ONE H GENERATION SINGLE PHASE. HEATING AND COOLING 1 OR 2 ZONES



## Panasonic has developed a highly efficient solution, easy to install

Aquarea All in One is the new generation of Panasonic Heat Pumps for Heating, Cooling and Domestic Hot Water (DHW). This range intelligently integrates the best Hydrokit technology with a stainless steel tank.

- Easy remote controller to set up
- Reduced installation spaces
- Electrical connections at the front
- Easier installation and maintenance
- Remote controller functions (cooling mode activation possible by software. This activation can only be done by service partner)

### Technical focus

- Space saving: 1800 x 598 x 717 (H x W x D)
- Reduced installation costs
- Piping at the bottom of the All in One (easy to install)
- Reduced installation time and minimised installation errors



		Single Phase (Power to indoor)					
Kit		KIT-ADC03HE5	KIT-ADC05HE5	KIT-ADC07HE5	KIT-ADC09HE5	KIT-ADC12HE5	KIT-ADC16HE5
Heating capacity [A +7°C, W 35°C]	kW	3,20	5,00	7,00	9,00	12,00	16,00
COP [A +7°C, W 35°C]	W/W	5,00	4,63	4,46	4,13	4,74	4,28
Heating capacity [A +2°C, W 35°C]	kW	3,20	4,20	6,55	6,70	11,40	13,00
COP [A +2°C, W 35°C]	W/W	3,56	3,11	3,34	3,13	3,44	3,28
Heating capacity [A -7°C, W 35°C]	kW	3,20	4,20	5,15	5,90	10,00	11,40
COP [A -7°C, W 35°C]	W/W	2,69	2,59	2,68	2,52	2,73	2,57
Cooling capacity [A 35°C, W 7/12°C]	kW	3,20	4,50	6,00	7,00	10,00	12,20
EER [A 35°C, W 7/12°C]	W/W	3,08	2,69	2,63	2,43	2,81	2,56
Energy Efficiency Class at 35°C <sup>1</sup> / 55°C <sup>1</sup> / DHW <sup>2</sup>		A++ / A+ / A	A++ / A+ / A	A++ / A+ / A	A++ / A+ / A	A++ / A+ / A	A++ / A+ / A
System label 35°C / 55°C <sup>3</sup>		A+++ / A++	A+++ / A++	A+++ / A++	A+++ / A++	A+++ / A++	A+++ / A++
<b>Indoor unit 1 zone hydrokit</b>		<b>WH-ADC0309H3E5</b>	<b>WH-ADC0309H3E5</b>	<b>WH-ADC0309H3E5</b>	<b>WH-ADC0309H3E5</b>	<b>WH-ADC1216H6E5</b>	<b>WH-ADC1216H6E5</b>
<b>Indoor unit 2 zones built-in hydrokit</b>		<b>WH-ADC0309H3E5B</b>	<b>WH-ADC0309H3E5B</b>	<b>WH-ADC0309H3E5B</b>	<b>WH-ADC0309H3E5B</b>	—	—
Sound pressure Heat / Cool	dB(A)	28/28	28/28	28/28	28/28	33/33	33/33
Dimension H x W x D	mm	1800x598x717	1800x598x717	1800x598x717	1800x598x717	1800x598x717	1800x598x717
Net weight	kg	124	124	124	124	124	124
Water pipe connector	Inch	R 1 1/4	R 1 1/4	R 1 1/4	R 1 1/4	R 1 1/4	R 1 1/4
A class pump	Number of speeds	Variable Speed	Variable Speed	Variable Speed	Variable Speed	Variable Speed	Variable Speed
	Input power (Min/Max) W	30/120	30/120	30/120	30/120	36/152	36/152
Heating water flow [ΔT=5 K, 35°C]	L/min	9,2	14,3	20,1	25,8	34,4	45,9
Capacity of integrated electric heater	kW	3	3	3	3	6	6
Recommended fuse	A	15/15	15/15	30/15	30/15	30/30	30/30
Recommended cable size, supply 1 & 2	mm <sup>2</sup>	3x1,5/3x1,5	3x1,5/3x1,5	3x2,5/3x1,5	3x2,5/3x1,5	3x4,0/3x4,0	3x4,0/3x4,0
Water volume	L	185	185	185	185	185	185
Maximum water temperature	°C	65	65	65	65	65	65
Material inside tank		Stainless steel	Stainless steel	Stainless steel	Stainless steel	Stainless steel	Stainless steel
<b>Outdoor unit</b>		<b>WH-UD03HE5-1</b>	<b>WH-UD05HE5-1</b>	<b>WH-UD07HE5-1</b>	<b>WH-UD09HE5-1</b>	<b>WH-UD12HE5</b>	<b>WH-UD16HE5</b>
Sound pressure Heat / Cool	dB(A)	48/47	49/48	50/48	51/50	52/50	55/54
Sound power Heat / Cool	dB	64/65	65/66	68/66	69/68	69/68	72/72
Dimension H x W x D	mm	622x824x298	622x824x298	795x900x320	795x900x320	1340x900x320	1340x900x320
Net weight	kg	39	39	66	66	101	101
Refrigerant [R410A]	kg/TCO <sub>2</sub> Eq.	1,20/2,506	1,20/2,506	1,45/3,028	1,45/3,028	2,55/5,324	2,55/5,324
Pipe diameter Liquid / Gas	Inch (mm)	1/4(6,35)/1/2(12,70)	1/4(6,35)/1/2(12,70)	1/4(6,35)/5/8(15,88)	1/4(6,35)/5/8(15,88)	3/8(9,52)/5/8(15,88)	3/8(9,52)/5/8(15,88)
Pipe length range	m	3 - 15	3 - 15	3 - 40	3 - 40	3 - 50	3 - 50
Elevation difference (in/out)	m	5	5	30	30	30	30
Pipe length for additional gas	m	10	10	10	10	10	10
Additional gas amount	g/m	20	20	30	30	50	50
Operation range Outdoor ambient	°C	-20 ~ +35	-20 ~ +35	-20 ~ +35	-20 ~ +35	-20 ~ +35	-20 ~ +35
Water outlet Heat / Cool	°C	25 ~ 55/5 ~ 20	25 ~ 55/5 ~ 20	25 ~ 55/5 ~ 20	25 ~ 55/5 ~ 20	25 ~ 55/5 ~ 20	25 ~ 55/5 ~ 20

### Accessories

<b>PAW-ADC-PREKIT-1</b>	Pre installation kit for piping
<b>PAW-ADC-CV150</b>	Decorative magnetic side cover
<b>CZ-NS4P</b>	Additional functions PCB

### Accessories

<b>CZ-TAW1</b>	Aquarea Smart Cloud for remote control and maintenance through wireless or wired LAN
<b>PAW-A2W-RTWIRED</b>	Room thermostat

EER and COP calculation is based in accordance to EN14511. Sound pressure measured at 1m from the outdoor unit and at 1,5m height. Heating sound pressure measured at +7°C (heating water at 55°C). Insulated tested under EN12897. 1) Scale from A++ to G. 2) Scale from A to G. 3) Scale from A+++ to D. System label with controller. This product is designed to meet European water quality standard 98/93 EC. The lifespan of the product is not guaranteed in the case of the use of groundwater, such as spring water or well water, the use of tap water when salt or other impurities are contained, nor in areas of acidic water quality. Maintenance and warranty costs related to these cases are the customer's responsibility.



INTERNET CONTROL: Optional. GOOD DESIGN AWARD 2017: Indoor units All in One and Bi-bloc H Generation awarded with the prestigious Good Design Award 2017.

High Performance All in One

R410A

# AQUAREA HIGH PERFORMANCE ALL IN ONE H GENERATION THREE PHASE. HEATING AND COOLING



GOOD DESIGN AWARD 2017

## Panasonic has developed a highly efficient solution, easy to install

Aquarea All in One is the new generation of Panasonic Heat Pumps for Heating, Cooling and Domestic Hot Water (DHW). This new range intelligently integrates the best Hydrokit technology with a stainless steel tank.

- Reduced installation time and minimised installation errors
- Easy remote controller to set up
- Reduced installation spaces
- Electrical connections at the front
- Easier installation and maintenance
- Remote controller functions (cooling mode activation possible by software. This activation can only be done by service partner)

### Technical focus

- Space saving: 1800 x 598 x 717 (H x W x D)
- Reduced installation costs
- Piping at the bottom of the All in One (easy to install)

**CZ-TAW1**  
Cloud connection. For user control and installer remote maintenance.

**A++**  
EP 55°C  
Scale from A++ to G

**A**  
DHW  
Scale from A to G

**A+++**  
35°C SYSTEM LABEL  
Scale from A+++ to D

				Three Phase (Power to indoor)			
Kit				KIT-ADC9HE8	KIT-ADC12HE8	KIT-ADC16HE8	
Heating capacity (A +7°C, W 35°C)		kW		9,00	12,00	16,00	
COP (A +7°C, W 35°C)		W/W		4,84	4,74	4,28	
Heating capacity (A +2°C, W 35°C)		kW		9,00	11,40	13,00	
COP (A +2°C, W 35°C)		W/W		3,59	3,44	3,28	
Heating capacity (A -7°C, W 35°C)		kW		9,00	10,00	11,40	
COP (A -7°C, W 35°C)		W/W		2,85	2,73	2,57	
Cooling capacity (A 35°C, W 7/12°C)		kW		7,00	10,00	12,20	
EER (A 35°C, W 7/12°C)		W/W		3,17	2,85	2,56	
Energy Efficiency Class at 35°C <sup>1</sup> / 55°C <sup>1</sup> / DHW <sup>2</sup>				A+++ / A++ / A		A+++ / A++ / A	
System label 35°C / 55°C <sup>3</sup>				A+++ / A++		A+++ / A++	
Indoor unit				WH-ADC0916H9E8	WH-ADC0916H9E8	WH-ADC0916H9E8	
Sound pressure		Heat / Cool	dB(A)	33/33	33/33	33/33	
Dimension		HxWxD	mm	1800x598x717	1800x598x717	1800x598x717	
Net weight			kg	126	126	126	
Water pipe connector			Inch	R 1 1/4	R 1 1/4	R 1 1/4	
A class pump		Number of speeds		Variable Speed	Variable Speed	Variable Speed	
		Input power (Min/Max)	W	36/152	36/152	36/152	
Heating water flow (ΔT=5 K, 35°C)			L/min	25,8	34,4	45,9	
Capacity of integrated electric heater			kW	9	9	9	
Recommended fuse			A	16/16	16/16	16/16	
Recommended cable size, supply 1 & 2			mm <sup>2</sup>	5x1,5/5x1,5	5x1,5/5x1,5	5x1,5/5x1,5	
Water volume			L	185	185	185	
Maximum water temperature			°C	65	65	65	
Material inside tank				Stainless steel	Stainless steel	Stainless steel	
Outdoor unit				WH-UD09HE8	WH-UD12HE8	WH-UD16HE8	
Sound pressure		Heat / Cool	dB(A)	51/49	52/50	55/54	
Sound power		Heat / Cool	dB	68/67	69/68	72/72	
Dimension		HxWxD	mm	1340x900x320	1340x900x320	1340x900x320	
Net weight			kg	107	107	107	
Refrigerant (R410A)			kg/TCO <sub>2</sub> Eq.	2,55/5,324	2,55/5,324	2,55/5,324	
Pipe diameter		Liquid / Gas	Inch (mm)	3/8(9,52)/5/8(15,88)	3/8(9,52)/5/8(15,88)	3/8(9,52)/5/8(15,88)	
Pipe length range			m	3-30	3-30	3-30	
Elevation difference (in/out)			m	30	30	30	
Pipe length for additional gas			m	10	10	10	
Additional gas amount			g/m	50	50	50	
Operation range		Outdoor ambient	°C	-20 ~ +35	-20 ~ +35	-20 ~ +35	
Water outlet		Heat / Cool	°C	25-55/5-20	25-55/5-20	25-55/5-20	

### Accessories

<b>PAW-ADC-PREKIT-1</b>	Pre installation kit for piping
<b>PAW-ADC-CV150</b>	Decorative magnetic side cover
<b>CZ-NS4P</b>	Additional functions PCB

### Accessories

<b>CZ-TAW1</b>	Aquarea Smart Cloud for remote control and maintenance through wireless or wired LAN
<b>PAW-A2W-RTWIRED</b>	Room thermostat

EER and COP calculation is based in accordance to EN14511. Sound pressure measured at 1m from the outdoor unit and at 1,5m height. Heating sound pressure measured at +7°C (heating water at 55°C). Insulated tested under EN12897. 1) Scale from A++ to G. 2) Scale from A to G. 3) Scale from A+++ to D. System label with controller. This product is designed to meet European water quality standard 98/93 EC. The lifespan of the product is not guaranteed in the case of the use of groundwater, such as spring water or well water, the use of tap water when salt or other impurities are contained, nor in areas of acidic water quality. Maintenance and warranty costs related to these cases are the customer's responsibility.



INTERNET CONTROL: Optional. GOOD DESIGN AWARD 2017: Indoor units All in One and Bi-bloc H Generation awarded with the prestigious Good Design Award 2017.

# AQUAREA T-CAP ALL IN ONE H GENERATION SINGLE PHASE / THREE PHASE. HEATING AND COOLING



GOOD DESIGN AWARD 2017



## Benefits of the T-CAP All in One unit!

Aquarea T-CAP can work in extreme outdoor conditions as low as -28°C and warranty the capacity without back up heating down to -20°C. Ready to work at extreme outdoor conditions the H Generation T-CAP can produce water up to 60°C, expanding its possibilities for retrofit application.

- Reduced installation costs
- Reduced installation time and minimised installation errors
- Easy remote controller to set up
- Electrical connections at the front
- Easier installation and maintenance
- Remote controller functions (cooling mode activation possible by software. This activation can only be done by service partner)

## Technical focus

- Works at temperatures as low as -28°C
- Constant capacity up to -20°C

**CZ-TAW1**  
Cloud connection. For user control and installer remote maintenance.

**A++**

ErP 55°C  
Scale from A++ to G

**A**

DHW  
Scale from A to G

**A+++**

35°C SYSTEM LABEL  
Scale from A+++ to D

Kit	Single Phase (Power to indoor)			Three Phase (Power to indoor)		
	KIT-AXC9HE5	KIT-AXC12HE5	KIT-AXC9HE8	KIT-AXC12HE8	KIT-AXC16HE8	
Heating capacity [A +7°C, W 35°C]	kW	9,00	12,00	9,00	12,00	16,00
COP [A +7°C, W 35°C]	W/W	4,84	4,74	4,84	4,74	4,28
Heating capacity [A +2°C, W 35°C]	kW	9,00	12,00	9,00	12,00	16,00
COP [A +2°C, W 35°C]	W/W	3,59	3,44	3,59	3,44	3,10
Heating capacity [A -7°C, W 35°C]	kW	9,00	12,00	9,00	12,00	16,00
COP [A -7°C, W 35°C]	W/W	2,85	2,72	2,85	2,72	2,49
Cooling capacity [A 35°C, W 7/12°C]	kW	7,00	10,00	7,00	10,00	12,20
EER [A 35°C, W 7/12°C]	W/W	3,17	2,81	3,17	2,81	2,57
Energy Efficiency Class at 35°C <sup>1</sup> / 55°C <sup>1</sup> / DHW <sup>2</sup>		A++ / A+ / A	A++ / A+ / A	A++ / A+ / A	A++ / A+ / A	A++ / A+ / A
System label 35°C / 55°C <sup>3</sup>		A+++ / A++	A+++ / A++	A+++ / A++	A+++ / A++	A+++ / A++
<b>Indoor unit</b>		<b>WH-ADC1216H6E5</b>	<b>WH-ADC1216H6E5</b>	<b>WH-ADC0916H9E8</b>	<b>WH-ADC0916H9E8</b>	<b>WH-ADC0916H9E8</b>
Sound pressure	Heat / Cool	33/33		33/33		33/33
Dimension	H x W x D	1800 x 598 x 717		1800 x 598 x 717		1800 x 598 x 717
Net weight		124		126		126
Water pipe connector		R 1 1/4		R 1 1/4		R 1 1/4
A class pump	Number of speeds	Variable Speed		Variable Speed		Variable Speed
	Input power (Min/Max)	36/152		36/152		36/152
Heating water flow [ΔT=5 K, 35°C]	L/min	25,8		25,8		34,4
Capacity of integrated electric heater	kW	6		9		9
Recommended fuse	A	30/30		16/16		16/16
Recommended cable size, supply 1 & 2	mm <sup>2</sup>	3 x 4,0/3 x 4,0		5 x 1,5/5 x 1,5		5 x 1,5/5 x 1,5
Water volume	L	185		185		185
Maximum water temperature	°C	65		65		65
Material inside tank		Stainless steel		Stainless steel		Stainless steel
<b>Outdoor unit</b>		<b>WH-UX09HE5</b>	<b>WH-UX12HE5</b>	<b>WH-UX09HE8</b>	<b>WH-UX12HE8</b>	<b>WH-UX16HE8</b>
Sound pressure	Heat / Cool	51/49		51/49		52/50
Sound power	Heat / Cool	68/67		68/67		69/68
Dimension	H x W x D	1340 x 900 x 320		1340 x 900 x 320		1340 x 900 x 320
Net weight		101		108		118
Refrigerant [R410A]	kg / TCO <sub>2</sub> Eq.	2,85/5,951		2,85/5,951		2,85/5,951
Pipe diameter	Liquid / Gas	3/8 [9,52] / 5/8 [15,88]		3/8 [9,52] / 5/8 [15,88]		3/8 [9,52] / 5/8 [15,88]
Pipe length range	m	3 - 30		3 - 30		3 - 30
Elevation difference (in/out)	m	20		20		20
Pipe length for additional gas	m	10		10		10
Additional gas amount	g/m	50		50		50
Operation range	Outdoor ambient	-28 ~ +35		-28 ~ +35		-28 ~ +35
Water outlet	Heat / Cool	25 - 60/5 - 20		25 - 60/5 - 20		25 - 60/5 - 20

Accessories	
<b>PAW-ADC-PREKIT-1</b>	Pre installation kit for piping
<b>PAW-ADC-CV150</b>	Decorative magnetic side cover
<b>CZ-NS4P</b>	Additional functions PCB

Accessories	
<b>CZ-TAW1</b>	Aquarea Smart Cloud for remote control and maintenance through wireless or wired LAN
<b>PAW-A2W-RTWIRED</b>	Room thermostat

EER and COP calculation is based in accordance to EN14511. Sound pressure measured at 1m from the outdoor unit and at 1,5m height. Heating sound pressure measured at +7°C (heating water at 55°C). Insulated tested under EN12897. 1) Scale from A++ to G. 2) Scale from A to G. 3) Scale from A+++ to D. System label with controller. This product is designed to meet European water quality standard 98/93 EC. The lifespan of the product is not guaranteed in the case of the use of groundwater, such as spring water or well water, the use of tap water when salt or other impurities are contained, nor in areas of acidic water quality. Maintenance and warranty costs related to these cases are the customer's responsibility.

A+++  
ErP 55°C

A++  
ErP 35°C

A  
DHW

INVERTER+

A CLASS  
WATER PUMP  
CONSTANT HEATING  
T-CAP

-20°C  
CONSTANT HEATING  
T-CAP

WATER AT  
60°C  
FLOW TEMPERATURE

DHW

-28°C  
HEATING MODE

STOP VALVE

FLOW SENSOR

BOILER CONNECTION

ADVANCED CONTROL

INTERNET CONTROL

BMS  
CONNECTIVITY

10 YEARS  
WARRANTY

INTERNET CONTROL: Optional. GOOD DESIGN AWARD 2017: Indoor units All in One and Bi-bloc H Generation awarded with the prestigious Good Design Award 2017.

# NEW AQUAREA T-CAP ALL IN ONE H GENERATION THREE PHASE. SUPER QUIET OUTDOOR UNIT. HEATING AND COOLING



GOOD DESIGN AWARD 2017

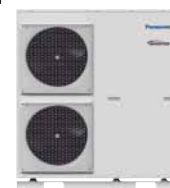

## Benefits of the T-CAP All in One unit!

Aquarea T-CAP can work in extreme outdoor conditions as low as -28°C and warranty the capacity without back up heating down to -20°C. Ready to work at extreme outdoor conditions the H Generation T-CAP can produce water up to 60°C, expanding its possibilities for retrofit application.

- Reduced installation costs
- Reduced installation time and minimised installation errors
- Easy remote controller to set up
- Electrical connections at the front
- Easier installation and maintenance
- Remote controller functions (cooling mode activation possible by software. This activation can only be done by service partner)

## Technical focus

- Works at temperatures as low as -28°C
- Constant capacity up to -20°C

**CZ-TAW1**  
Cloud connection. For user control and installer remote maintenance.

**A++**  
E:P 55°C  
Scale from A++ to G

**A**  
DHW  
Scale from A to G

**A+++**  
35°C SYSTEM LABEL  
Scale from A+++ to D

				Three Phase (Power to indoor)		
Kit				KIT-AQC9HE8	KIT-AQC12HE8	KIT-AQC16HE8
Heating capacity (A +7°C, W 35°C)		kW		9,00	12,00	16,00
COP (A +7°C, W 35°C)		W/W		4,84	4,74	4,28
Heating capacity (A +2°C, W 35°C)		kW		9,00	12,00	16,00
COP (A +2°C, W 35°C)		W/W		3,59	3,44	3,10
Heating capacity (A -7°C, W 35°C)		kW		9,00	12,00	16,00
COP (A -7°C, W 35°C)		W/W		2,85	2,72	2,49
Cooling capacity (A 35°C, W 7/12°C)		kW		7,00	10,00	12,20
EER (A 35°C, W 7/12°C)		W/W		3,17	2,81	2,57
Energy Efficiency Class at 35°C <sup>1</sup> / 55°C <sup>1</sup> / DHW <sup>2</sup>				A++ / A++ / A	A++ / A++ / A	A++ / A++ / A
System label 35°C / 55°C <sup>3</sup>				A+++ / A++	A+++ / A++	A+++ / A++
Indoor unit				WH-ADC0916H9E8	WH-ADC0916H9E8	WH-ADC0916H9E8
Sound pressure		Heat / Cool	dB(A)	33/33	33/33	33/33
Dimension		HxWxD	mm	1800x598x717	1800x598x717	1800x598x717
Net weight			kg	126	126	126
Water pipe connector			Inch	R 1 1/4	R 1 1/4	R 1 1/4
A class pump		Number of speeds		Variable Speed	Variable Speed	Variable Speed
		Input power (Min/Max)	W	36/152	36/152	36/152
Heating water flow (ΔT=5 K. 35°C)			L/min	25,8	34,4	45,9
Capacity of integrated electric heater			kW	9	9	9
Recommended fuse			A	16/16	16/16	16/16
Recommended cable size, supply 1 & 2			mm <sup>2</sup>	5x1,5/5x1,5	5x1,5/5x1,5	5x1,5/5x1,5
Water volume			L	185	185	185
Maximum water temperature			°C	65	65	65
Material inside tank				Stainless steel	Stainless steel	Stainless steel
Outdoor unit				WH-UQ09HE8	WH-UQ12HE8	WH-UQ16HE8
Sound pressure		Heat / Cool	dB(A)	47/48	48/49	51/53
Sound power		Heat / Cool	dB	61/63	62/64	65/68
Dimension		HxWxD	mm	1410x1283x320	1410x1283x320	1410x1283x320
Net weight			kg	151	151	161
Refrigerant (R410A)			kg/TCO <sub>2</sub> Eq.	2,85/5,951	2,85/5,951	2,99/6,243
Pipe diameter		Liquid / Gas	Inch (mm)	3/8(9,52)/5/8(15,88)	3/8(9,52)/5/8(15,88)	3/8(9,52)/5/8(15,88)
Pipe length range			m	3-30	3-30	3-30
Elevation difference (in/out)			m	20	20	20
Pipe length for additional gas			m	10	10	10
Additional gas amount			g/m	50	50	50
Operation range		Outdoor ambient	°C	-28~+35	-28~+35	-28~+35
Water outlet		Heat / Cool	°C	20-60/5-20	20-60/5-20	20-60/5-20

### Accessories

<b>PAW-ADC-PREKIT-1</b>	Pre installation kit for piping
<b>PAW-ADC-CV150</b>	Decorative magnetic side cover
<b>CZ-NS4P</b>	Additional functions PCB

### Accessories

<b>CZ-TAW1</b>	Aquarea Smart Cloud for remote control and maintenance through wireless or wired LAN
<b>PAW-A2W-RTWIRED</b>	Room thermostat

EER and COP calculation is based in accordance to EN14511. Sound pressure measured at 1m from the outdoor unit and at 1,5m height. Heating sound pressure measured at +7°C (heating water at 55°C). Insulated tested under EN12897. 1) Scale from A++ to G. 2) Scale from A to G. 3) Scale from A+++ to D. System label with controller. This product is designed to meet European water quality standard 98/93 EC. The lifespan of the product is not guaranteed in the case of the use of groundwater, such as spring water or well water, the use of tap water when salt or other impurities are contained, nor in areas of acidic water quality. Maintenance and warranty costs related to these cases are the customer's responsibility.

A++

A++

A

INVERTER+

A CLASS WATER PUMP

-20°C CONSTANT HEATING T-CAP

WATER AT 60°C FLOW TEMPERATURE

DHW

-28°C HEATING MODE

55-65°C WATER FILTER

STOP VALVE

FLOW SENSOR

BOILER CONNECTION

ADVANCED CONTROL

INTERNET CONTROL

BMS CONNECTIVITY

5 YEARS WARRANTY

INTERNET CONTROL: Optional. GOOD DESIGN AWARD 2017: Indoor units All in One and Bi-bloc H Generation awarded with the prestigious Good Design Award 2017.

# AQUAREA HIGH PERFORMANCE BI-BLOC H GENERATION SINGLE PHASE. HEATING AND COOLING - SDC



The new H Generation are specially designed for low energy homes and achieve an impressive COP of 5 (on the 3,2kW)

Thanks to the system's high degree of technology and advanced control, it is able to maintain a high capacity and efficiency even at -7°C and -15°C. The Aquarea's software is optimised to the requirements of low consumption homes in order to maximise energy efficiency. Whatever the weather, Aquarea can work even at -20°C. The compact design of the outdoor unit makes installation very easy.

- Very high energy savings A+++ (\*)
- Simple installation & maintenance
- Special software for low consumption homes with minimum output temperature: 20°C
- Works at temperatures as low as -20°C
- Automatic Air purge valve
- Display of the compressor frequency

### Technical focus

- Super efficient: COP of 5 in the 3,2kW!



			Single Phase Heating and Cooling					
Kit			KIT-WC03H3E5	KIT-WC05H3E5	KIT-WC07H3E5	KIT-WC09H3E5	KIT-WC012H6E5	KIT-WC016H6E5
Heating capacity [A +7°C, W 35°C]	kW		3,20	5,00	7,00	9,00	12,00	16,00
COP [A +7°C, W 35°C]	W/W		5,00	4,63	4,46	4,13	4,74	4,28
Heating capacity [A +2°C, W 35°C]	kW		3,20	4,20	6,55	6,70	11,40	13,00
COP [A +2°C, W 35°C]	W/W		3,56	3,11	3,34	3,13	3,44	3,28
Heating capacity [A -7°C, W 35°C]	kW		3,20	4,20	5,15	5,90	10,00	11,40
COP [A -7°C, W 35°C]	W/W		2,69	2,59	2,68	2,52	2,73	2,57
Cooling capacity [A 35°C, W 7/12°C]	kW		3,20	4,50	6,00	7,00	10,00	12,20
EER [A 35°C, W 7/12°C]	W/W		3,08	2,69	2,63	2,43	2,81	2,56
Energy Efficiency Class at 35°C <sup>1</sup> / 55°C <sup>1</sup>			A++ / A++	A++ / A++	A++ / A++	A++ / A++	A++ / A++	A++ / A++
System label 35°C / 55°C <sup>2</sup>			A+++ / A+++	A+++ / A+++	A+++ / A+++	A+++ / A+++	A+++ / A+++	A+++ / A+++
<b>Indoor unit</b>			<b>WH-SDC03H3E5-1</b>	<b>WH-SDC05H3E5-1</b>	<b>WH-SDC07H3E5-1</b>	<b>WH-SDC09H3E5-1</b>	<b>WH-SDC12H6E5</b>	<b>WH-SDC16H6E5</b>
Sound pressure	Heat / Cool	dB(A)	28/28	28/28	30/30	30/30	33/33	33/33
Dimension	H x W x D	mm	892 x 500 x 340	892 x 500 x 340	892 x 500 x 340	892 x 500 x 340	892 x 500 x 340	892 x 500 x 340
Net weight		kg	44	44	44	44	44	45
Water pipe connector		Inch	R 1 1/4	R 1 1/4	R 1 1/4	R 1 1/4	R 1 1/4	R 1 1/4
A class pump	Number of speeds		Variable Speed	Variable Speed	Variable Speed	Variable Speed	Variable Speed	Variable Speed
	Input power (Min/Max)	W	30/100	33/106	34/114	40/120	34/110	30/105
Heating water flow (ΔT=5 K, 35°C)		L/min	9,2	14,3	20,1	25,8	34,4	45,9
Capacity of integrated electric heater		kW	3	3	3	3	6	6
Recommended fuse		A	15/30	15/30	15/30	15/30	30/30	30/30
Recommended cable size, supply 1 & 2		mm <sup>2</sup>	3 x 1,5/3 x 1,5	3 x 1,5/3 x 1,5	3 x 1,5/3 x 1,5	3 x 1,5/3 x 1,5	3 x 4,0 or 6,0/3 x 4,0	3 x 4,0 or 6,0/3 x 4,0
<b>Outdoor unit</b>			<b>WH-UD03HE5-1</b>	<b>WH-UD05HE5-1</b>	<b>WH-UD07HE5-1</b>	<b>WH-UD09HE5-1</b>	<b>WH-UD12HE5</b>	<b>WH-UD16HE5</b>
Sound pressure	Heat / Cool	dB(A)	48/47	49/48	50/48	51/50	52/50	55/54
Sound power	Heat / Cool	dB	64/65	65/66	68/66	69/68	69/68	72/72
Dimension	H x W x D	mm	622 x 824 x 298	622 x 824 x 298	795 x 900 x 320	795 x 900 x 320	1340 x 900 x 320	1340 x 900 x 320
Net weight		kg	39	39	66	66	101	101
Refrigerant (R410A)		kg/TCO <sub>2</sub> Eq.	1,20/2,506	1,20/2,506	1,45/3,028	1,45/3,028	2,55/5,324	2,55/5,324
Pipe diameter	Liquid / Gas	Inch (mm)	1/4(6,35)/1/2(12,70)	1/4(6,35)/1/2(12,70)	1/4(6,35)/5/8(15,88)	1/4(6,35)/5/8(15,88)	3/8(9,52)/5/8(15,88)	3/8(9,52)/5/8(15,88)
Pipe length range		m	3 - 15	3 - 15	3 - 40	3 - 40	3 - 50	3 - 50
Elevation difference (in/out)		m	5	5	30	30	30	30
Pipe length for additional gas		m	10	10	10	10	10	10
Additional gas amount		g/m	20	20	30	30	50	50
Operation range	Outdoor ambient	°C	-20 ~ +35	-20 ~ +35	-20 ~ +35	-20 ~ +35	-20 ~ +35	-20 ~ +35
Water outlet	Heat / Cool	°C	25 - 55/5 - 20	25 - 55/5 - 20	25 - 55/5 - 20	25 - 55/5 - 20	25 - 55/5 - 20	25 - 55/5 - 20

### Accessories

<b>PAW-TD20C1E5</b>	Tank 200L - Stainless steel
<b>PAW-TD30C1E5</b>	Tank 300L - Stainless steel
<b>PAW-TG20C1E3STD-1</b>	Tank 200L - Enamelled
<b>PAW-TG30C1E3STD-1</b>	Tank 300L - Enamelled
<b>PAW-3WYVLV-SI</b>	External 3 way valve
<b>CZ-NV1</b>	3 way valve Kit for inside of hydrokit

### Accessories

<b>CZ-NS4P</b>	Additional functions PCB
<b>PAW-BTANK50L</b>	Buffer tank 50L
<b>CZ-TAW1</b>	Aquarea Smart Cloud for remote control and maintenance through wireless or wired LAN
<b>PAW-A2W-RTWIRED</b>	Room thermostat

EER and COP calculation is based in accordance to EN14511. Sound pressure measured at 1m from the outdoor unit and at 1,5m height. Heating sound pressure measured at +7°C (heating water at 55°C). 1) Scale from A++ to G. 2) Scale from A+++ to D. System label with controller.



INTERNET CONTROL: Optional. GOOD DESIGN AWARD 2017: Indoor units ALL in One and Bi-bloc H Generation awarded with the prestigious Good Design Award 2017.

High Performance Bi-bloc

R410A

# AQUAREA HIGH PERFORMANCE BI-BLOC H GENERATION THREE PHASE. HEATING AND COOLING - SDC



The new H Generation are specially designed for low energy homes and achieve an impressive COP of 5 (on the 3,2kW)

Thanks to the system's high degree of technology and advanced control, it is able to maintain a high capacity and efficiency even at -7°C and -15°C. The Aquarea's software is optimised to the requirements of low consumption homes in order to maximise energy efficiency. Whatever the weather, Aquarea can work even at -20°C. The compact design of the outdoor unit makes installation very easy.

- Very high energy savings A+++ (\*)
- Simple installation & maintenance
- Special software for low consumption homes with minimum output temperature: 20°C
- Works at temperatures as low as -20°C
- Automatic Air purge valve
- Display of the compressor frequency

### Technical focus

- Super efficient: COP of 5 in the 3,2kW!



				Three Phase (Power to indoor)		
Kit				KIT-WC09H3E8	KIT-WC12H9E8	KIT-WC16H9E8
Heating capacity (A +7°C, W 35°C)		kW		9,00	12,00	16,00
COP (A +7°C, W 35°C)		W/W		4,84	4,74	4,28
Heating capacity (A +2°C, W 35°C)		kW		9,00	11,40	13,00
COP (A +2°C, W 35°C)		W/W		3,59	3,44	3,28
Heating capacity (A -7°C, W 35°C)		kW		9,00	10,00	11,40
COP (A -7°C, W 35°C)		W/W		2,85	2,73	2,57
Cooling capacity (A 35°C, W 7/12°C)		kW		7,00	10,00	12,20
EER (A 35°C, W 7/12°C)		W/W		3,17	2,81	2,56
Energy Efficiency Class at 35°C <sup>1</sup> / 55°C <sup>1</sup>				A++ / A++	A++ / A++	A++ / A++
System label 35°C / 55°C <sup>2</sup>				A+++ / A++	A+++ / A++	A+++ / A++
<b>Indoor unit</b>				<b>WH-SDC09H3E8</b>	<b>WH-SDC12H9E8</b>	<b>WH-SDC16H9E8</b>
Sound pressure	Heat / Cool	dB(A)		33/33	33/33	33/33
Dimension	H x W x D	mm		892 x 500 x 340	892 x 500 x 340	892 x 500 x 340
Net weight		kg		44	45	45
Water pipe connector		Inch		R 1 1/4	R 1 1/4	R 1 1/4
A class pump	Number of speeds			Variable Speed	Variable Speed	Variable Speed
	Input power (Min/Max)	W		32/102	34/110	30/105
Heating water flow (ΔT=5 K, 35°C)		L/min		25,8	34,4	45,9
Capacity of integrated electric heater		kW		3	9	9
Recommended fuse		A		15/30	15/30	15/30
Recommended cable size, supply 1 & 2		mm <sup>2</sup>		3 x 1,5/3 x 1,5	3 x 1,5/3 x 1,5	3 x 1,5/3 x 1,5
<b>Outdoor unit</b>				<b>WH-UD09HE8</b>	<b>WH-UD12HE8</b>	<b>WH-UD16HE8</b>
Sound pressure	Heat / Cool	dB(A)		51/49	52/50	55/54
Sound power	Heat / Cool	dB		68/67	69/68	72/72
Dimension	H x W x D	mm		1340 x 900 x 320	1340 x 900 x 320	1340 x 900 x 320
Net weight		kg		107	107	107
Refrigerant (R410A)		kg/TCO <sub>2</sub> Eq.		2,55/5,324	2,55/5,324	2,55/5,324
Pipe diameter	Liquid / Gas	Inch (mm)		3/8(9,52)/5/8(15,88)	3/8(9,52)/5/8(15,88)	3/8(9,52)/5/8(15,88)
Pipe length range		m		3-30	3-30	3-30
Elevation difference (in/out)		m		30	30	30
Pipe length for additional gas		m		10	10	10
Additional gas amount		g/m		50	50	50
Operation range	Outdoor ambient	°C		-20 ~ +35	-20 ~ +35	-20 ~ +35
Water outlet	Heat / Cool	°C		25-55/5-20	25-55/5-20	25-55/5-20

### Accessories

<b>PAW-TD20C1E5</b>	Tank 200L - Stainless steel
<b>PAW-TD30C1E5</b>	Tank 300L - Stainless steel
<b>PAW-TG20C1E3STD-1</b>	Tank 200L - Enamelled
<b>PAW-TG30C1E3STD-1</b>	Tank 300L - Enamelled
<b>PAW-3WYVLV-SI</b>	External 3 way valve
<b>CZ-NV1</b>	3 way valve Kit for inside of hydrokit

### Accessories

<b>CZ-NS4P</b>	Additional functions PCB
<b>PAW-BTANK50L</b>	Buffer tank 50L
<b>CZ-TAW1</b>	Aquarea Smart Cloud for remote control and maintenance through wireless or wired LAN
<b>PAW-A2W-RTWIRED</b>	Room thermostat

EER and COP calculation is based in accordance to EN14511. Sound pressure measured at 1m from the outdoor unit and at 1,5m height. Heating sound pressure measured at +7°C (heating water at 55°C). 1) Scale from A++ to G. 2) Scale from A+++ to D. System label with controller.



INTERNET CONTROL: Optional. GOOD DESIGN AWARD 2017: Indoor units All in One and Bi-bloc H Generation awarded with the prestigious Good Design Award 2017.

# AQUAREA T-CAP BI-BLOC H GENERATION SINGLE PHASE / THREE PHASE. HEATING AND COOLING - SXC



GOOD  
DESIGN  
AWARD  
2017



## The best for extreme outdoor conditions. Constant capacity at -20°C

Aquarea T-CAP can work in extreme outdoor conditions as low as -28°C and warranty the capacity without back up heating down to 20°C. Ready to work at extreme outdoor conditions the H Generation T-CAP can produce water up to 60°C, expanding its possibilities for retrofit application. H Generation is the quickest to install and easiest maintenance.

- Simple installation & maintenance
- Constant capacity up to -20°C
- Water temperature up to 60°C
- Special software for low consumption homes with minimum output temperature: 20°C
- Works at temperatures as low as -28°C
- Automatic Air purge valve
- Display of the compressor frequency

## Technical focus

- Very high energy savings A++

**CZ-TAW1**  
Cloud connection. For user control and installer remote maintenance.

**A++**

ErP 35°C  
Scale from A++ to G

**A++**

ErP 55°C  
Scale from A++ to G

**A+++**

35°C SYSTEM LABEL  
Scale from A+++ to D

			Single Phase (Power to indoor)		Three Phase (Power to indoor)		
Kit			KIT-WXC09H3E5	KIT-WXC12H6E5	KIT-WXC09H3E8	KIT-WXC12H9E8	KIT-WXC16H9E8
Heating capacity [A +7°C, W 35°C]	kW		9,00	12,00	9,00	12,00	16,00
COP [A +7°C, W 35°C]	W/W		4,84	4,74	4,84	4,74	4,28
Heating capacity [A +2°C, W 35°C]	kW		9,00	12,00	9,00	12,00	16,00
COP [A +2°C, W 35°C]	W/W		3,59	3,44	3,59	3,44	3,10
Heating capacity [A -7°C, W 35°C]	kW		9,00	12,00	9,00	12,00	16,00
COP [A -7°C, W 35°C]	W/W		2,85	2,72	2,85	2,72	2,49
Cooling capacity [A 35°C, W 7°C]	kW		7,00	10,00	7,00	10,00	12,20
EER [A 35°C, W 7°C]	W/W		3,17	2,81	3,17	2,81	2,57
Energy Efficiency Class at 35°C <sup>1</sup> / 55°C <sup>2</sup>			<b>A++</b> / <b>A++</b>	<b>A++</b> / <b>A++</b>	<b>A++</b> / <b>A++</b>	<b>A++</b> / <b>A++</b>	<b>A++</b> / <b>A++</b>
System label 35°C / 55°C <sup>2</sup>			<b>A+++</b> / <b>A++</b>	<b>A++</b> / <b>A++</b>	<b>A+++</b> / <b>A++</b>	<b>A++</b> / <b>A++</b>	<b>A++</b> / <b>A++</b>
<b>Indoor unit</b>			<b>WH-SXC09H3E5</b>	<b>WH-SXC12H6E5</b>	<b>WH-SXC09H3E8</b>	<b>WH-SXC12H9E8</b>	<b>WH-SXC16H9E8</b>
Sound pressure	Heat / Cool	dB(A)	33/33	33/33	33/33	33/33	33/33
Dimension	H x W x D	mm	892 x 500 x 340	892 x 500 x 340	892 x 500 x 340	892 x 500 x 340	892 x 500 x 340
Net weight		kg	43	43	43	44	45
Water pipe connector		Inch	R 1 1/4	R 1 1/4	R 1 1/4	R 1 1/4	R 1 1/4
A class pump	Number of speeds		Variable Speed	Variable Speed	Variable Speed	Variable Speed	Variable Speed
	Input power (Min/Max)	W	32/102	34/110	32/102	34/110	30/105
Heating water flow (ΔT=5 K, 35°C)		L/min	25,8	34,4	25,8	34,4	45,9
Capacity of integrated electric heater		kW	3	6	3	9	9
Recommended fuse		A	30/30	30/30	16/16	16/16	16/16
Recommended cable size, supply 1 & 2		mm <sup>2</sup>	3x4,0 or 6,0/3x4,0	3x4,0 or 6,0/3x4,0	5x1,5/3x1,5	5x1,5/5x1,5	5x1,5/5x1,5
<b>Outdoor unit</b>			<b>WH-UX09HE5</b>	<b>WH-UX12HE5</b>	<b>WH-UX09HE8</b>	<b>WH-UX12HE8</b>	<b>WH-UX16HE8</b>
Sound pressure	Heat / Cool	dB(A)	51/49	52/50	51/49	52/50	55/54
Sound power	Heat / Cool	dB	68/67	69/68	68/67	69/68	72/71
Dimension	H x W x D	mm	1340 x 900 x 320	1340 x 900 x 320	1340 x 900 x 320	1340 x 900 x 320	1340 x 900 x 320
Net weight		kg	101	101	108	108	118
Refrigerant (R410A)		kg/TCO <sub>2</sub> Eq.	2,85/5,951	2,85/5,951	2,85/5,951	2,85/5,951	2,90/6,055
Pipe diameter	Liquid / Gas	Inch (mm)	3/8(9,52)/5/8(15,88)	3/8(9,52)/5/8(15,88)	3/8(9,52)/5/8(15,88)	3/8(9,52)/5/8(15,88)	3/8(9,52)/5/8(15,88)
Pipe length range		m	3-30	3-30	3-30	3-30	3-30
Elevation difference (in/out)		m	30	30	30	30	30
Pipe length for additional gas		m	10	10	10	10	10
Additional gas amount		g/m	50	50	50	50	50
Operation range	Outdoor ambient	°C	-28 ~ +35	-28 ~ +35	-28 ~ +35	-28 ~ +35	-28 ~ +35
Water outlet	Heat / Cool	°C	25-60/5-20	25-60/5-20	25-60/5-20	25-60/5-20	25-60/5-20

## Accessories

<b>PAW-TD20C1E5</b>	Tank 200L - Stainless steel
<b>PAW-TD30C1E5</b>	Tank 300L - Stainless steel
<b>PAW-TG20C1E3STD-1</b>	Tank 200L - Enamelled
<b>PAW-TG30C1E3STD-1</b>	Tank 300L - Enamelled
<b>PAW-3WYVLV-SI</b>	External 3 way valve
<b>CZ-NV1</b>	3 way valve Kit for inside of hydrokit

## Accessories

<b>CZ-NS4P</b>	Additional functions PCB
<b>PAW-BTANK50L</b>	Buffer tank 50L
<b>CZ-TAW1</b>	Aquarea Smart Cloud for remote control and maintenance through wireless or wired LAN
<b>PAW-A2W-RTWIRED</b>	Room thermostat

EER and COP calculation is based in accordance to EN14511. Sound pressure measured at 1m from the outdoor unit and at 1,5m height. Heating sound pressure measured at +7°C (heating water at 55°C). 1) Scale from A++ to G. 2) Scale from A+++ to D. System label with controller.

A+++  
ErP 55°C

A++  
ErP 35°C

INVERTER+

A CLASS  
WATER PUMP  
CONSTANT HEATING  
T-CAP

-20°C  
CONSTANT HEATING  
T-CAP

WATER AT  
60°C  
FLOW TEMPERATURE

DHW

-28°C  
HEATING MODE

WATER FILTER

STOP VALVE

FLOW SENSOR

BOILER CONNECTION

SOLAR KIT

ADVANCED CONTROL

INTERNET CONTROL

CONNECTIVITY

BMS

9 YEARS  
WARRANTY

INTERNET CONTROL: Optional. GOOD DESIGN AWARD 2017: Indoor units ALL in One and Bi-bloc H Generation awarded with the prestigious Good Design Award 2017.



# AQUAREA T-CAP BI-BLOC H GENERATION THREE PHASE. SUPER QUIET OUTDOOR UNIT. HEATING AND COOLING - SQC



GOOD DESIGN AWARD 2017



## The best for extreme outdoor conditions. Constant capacity at -20°C

Aquarea T-CAP can work in extreme outdoor conditions as low as -28°C and warranty the capacity without back up heating down to 20°C. Ready to work at extreme outdoor conditions the H Generation T-CAP can produce water up to 60°C, expanding its possibilities for retrofit application. H Generation is the quickest to install and easiest maintenance.

### Technical focus

- Very high energy savings A++

- Noise reduction of 7dB is based on power level when heating mode
- With Quite mode we can reach 10 ~ 12dB(A)
- Constant capacity up to -20°C
- Water temperature up to 60°C
- Special software for low consumption homes with minimum output temperature: 20°C
- Works at temperatures as low as -28°C
- Display of the compressor frequency

**CZ-TAW1**  
Cloud connection. For user control and installer remote maintenance.

**A++**

ErP 35°C  
Scale from A++ to G

**A++**

ErP 55°C  
Scale from A++ to G

**A+++**

35°C SYSTEM LABEL  
Scale from A+++ to D

				Three Phase New Super Quiet outdoor unit		
Kit				KIT-WQC09H3E8	KIT-WQC12H9E8	KIT-WQC16H9E8
Heating capacity (A +7°C, W 35°C)		kW		9,00	12,00	16,00
COP (A +7°C, W 35°C)		W/W		4,84	4,74	4,28
Heating capacity (A +2°C, W 35°C)		kW		9,00	12,00	16,00
COP (A +2°C, W 35°C)		W/W		3,59	3,44	3,10
Heating capacity (A -7°C, W 35°C)		kW		9,00	12,00	16,00
COP (A -7°C, W 35°C)		W/W		2,85	2,72	2,49
Cooling capacity (A 35°C, W 7°C)		kW		7,00	10,00	12,20
EER (A 35°C, W 7°C)		W/W		3,17	2,81	2,57
Energy Efficiency Class at 35°C <sup>1</sup> / 55°C <sup>1</sup>				<b>A++ / A++</b>	<b>A++ / A++</b>	<b>A++ / A++</b>
System label 35°C / 55°C <sup>2</sup>				<b>A+++ / A++</b>	<b>A++ / A++</b>	<b>A++ / A++</b>
<b>Indoor unit</b>				<b>WH-SQC09H3E8</b>	<b>WH-SQC12H9E8</b>	<b>WH-SQC16H9E8</b>
Sound pressure	Heat / Cool	dB(A)		33/33	33/33	33/33
Dimension	H x W x D	mm		892 x 500 x 340	892 x 500 x 340	892 x 500 x 340
Net weight		kg		43	44	45
Water pipe connector		Inch		R 1 1/4	R 1 1/4	R 1 1/4
A class pump	Number of speeds			Variable Speed	Variable Speed	Variable Speed
	Input power (Min/Max)	W		32/102	34/110	30/105
Heating water flow (ΔT=5 K, 35°C)		L/min		25,8	34,4	45,9
Capacity of integrated electric heater		kW		3	9	9
Recommended fuse		A		15/30	15/30	15/30
Recommended cable size, supply 1 & 2		mm <sup>2</sup>		3 x 1,5/3 x 1,5	3 x 1,5/3 x 1,5	3 x 1,5/3 x 1,5
<b>Outdoor unit</b>				<b>WH-UQ09HE8</b>	<b>WH-UQ12HE8</b>	<b>WH-UQ16HE8</b>
Sound pressure	Heat / Cool	dB(A)		47/48	48/49	51/53
Sound power	Heat / Cool	dB		61/63	62/64	65/68
Dimension	H x W x D	mm		1410 x 1283 x 320	1410 x 1283 x 320	1410 x 1283 x 320
Net weight		kg		151	151	161
Refrigerant (R410A)		kg/TCO <sub>2</sub> Eq.		2,85/5,951	2,85/5,951	2,99/6,243
Pipe diameter	Liquid / Gas	Inch (mm)		3/8(9,52)/5/8(15,88)	3/8(9,52)/5/8(15,88)	3/8(9,52)/5/8(15,88)
Pipe length range		m		3-30	3-30	3-30
Elevation difference (in/out)		m		20	20	20
Pipe length for additional gas		m		10	10	10
Additional gas amount		g/m		50	50	50
Operation range	Outdoor ambient	°C		-28 ~ +35	-28 ~ +35	-28 ~ +35
Water outlet	Heat / Cool	°C		20-60/5-20	20-60/5-20	20-60/5-20

### Accessories

<b>PAW-TD20C1E5</b>	Tank 200L - Stainless steel
<b>PAW-TD30C1E5</b>	Tank 300L - Stainless steel
<b>PAW-TG20C1E3STD-1</b>	Tank 200L - Enamelled
<b>PAW-TG30C1E3STD-1</b>	Tank 300L - Enamelled
<b>PAW-3WYVLV-SI</b>	External 3 way valve
<b>CZ-NV1</b>	3 way valve Kit for inside of hydrokit

### Accessories

<b>CZ-NS4P</b>	Additional functions PCB
<b>PAW-BTANK50L</b>	Buffer tank 50L
<b>CZ-TAW1</b>	Aquarea Smart Cloud for remote control and maintenance through wireless or wired LAN
<b>PAW-A2W-RTWIRED</b>	Room thermostat

EER and COP calculation is based in accordance to EN14511. Sound pressure measured at 1m from the outdoor unit and at 1,5m height. Heating sound pressure measured at +7°C (heating water at 55°C). 1) Scale from A++ to G. 2) Scale from A+++ to D. System label with controller.

A++

A++

A CLASS WATER PUMP

-20°C CONSTANT HEATING

WATER AT 60°C

-28°C

INTERNET CONTROL: Optional. GOOD DESIGN AWARD 2017: Indoor units All in One and Bi-bloc H Generation awarded with the prestigious Good Design Award 2017.

# AQUAREA HIGH PERFORMANCE MONO-BLOC H GENERATION SINGLE PHASE. HEATING AND COOLING - MDC



The Aquaarea MDC range adapts well in an existing installation with a boiler backup, and in a new application with underfloor heating, low temperature radiators or even fan-coil heaters

This range can also be connected to a solar kit in order to increase efficiency and minimise the impact on the ecosystem. Finally, it is possible to connect a thermostat for even better heating and cooling control and management.

Whatever the weather, Aquaarea can work even at -20°C. The Mono-bloc is easy to install in new and existing residential properties.

## Technical focus

- Optional Smartphone control
- Range from 5 to 9kW, Single Phase
- Maximum hydraulic module output temperature: 55°C
- Works at temperatures as low as -20°C
- Cooling temperature range 5 ~ 20°C

**CZ-TAW1**  
Cloud connection. For user control and installer remote maintenance.

**A++**

ErP 55°C  
Scale from A++ to G

**A++**

ErP 35°C  
Scale from A++ to G

**A+++**

35°C SYSTEM LABEL  
Scale from A+++ to D

		Single Phase Heating and Cooling				
Outdoor unit		WH-MDC05H3E5	WH-MDC07H3E5	WH-MDC09H3E5	WH-MDC12H6E5	WH-MDC16H6E5
Heating capacity [A +7°C, W 35°C]	kW	5,00	7,00	9,00	12,00	16,00
COP [A +7°C, W 35°C]	W/W	5,08	4,52	4,29	4,74	4,28
Heating capacity [A +2°C, W 35°C]	kW	4,80	6,60	6,80	11,40	13,00
COP [A +2°C, W 35°C]	W/W	3,36	3,30	3,18	3,44	3,28
Heating capacity [A -7°C, W 35°C]	kW	4,70	5,50	6,40	10,00	11,40
COP [A -7°C, W 35°C]	W/W	2,85	2,70	2,60	2,73	2,57
Cooling capacity [A 35°C, W 7°C]	kW	4,50	6,00	7,00	10,00	12,20
EER [A 35°C, W 7°C]	W/W	3,28	2,78	2,60	2,81	2,56
Energy Efficiency Class at 35°C <sup>1</sup> / 55°C <sup>1</sup>		A++ / A++	A++ / A++	A++ / A++	A++ / A++	A++ / A++
System label 35°C / 55°C <sup>2</sup>		A+++ / A++	A+++ / A++	A+++ / A++	A+++ / A++	A+++ / A++
Sound pressure Heat / Cool	dB(A)	49 / 47	50 / 48	51 / 49	52 / 50	55 / 54
Sound power Heat / Cool	dB	65 / 65	68 / 66	69 / 67	69 / 68	72 / 72
Dimension H x W x D	mm	865 x 1283 x 320	865 x 1283 x 320	865 x 1283 x 320	1410 x 1283 x 320	1410 x 1283 x 320
Net weight	kg	94	104	104	140	140
Refrigerant (R410A) <sup>3</sup>	kg/TCO <sub>2</sub> Eq.	1,30/2714	1,35/2819	1,35/2819	2,10/4,385	2,10/4,385
Water pipe connector	Inch	R 1 1/4	R 1 1/4	R 1 1/4	R 1 1/4	R 1 1/4
A class pump	Number of speeds	Variable Speed	Variable Speed	Variable Speed	Variable Speed	Variable Speed
	Input power (Min/Max) W	34/96	36/100	39/108	34/110	38/120
Heating water flow [ΔT=5 K, 35°C]	L/min	14,3	20,1	25,8	34,4	45,9
Capacity of integrated electric heater	kW	3	3	3	6	6
Input Power	Heat kW	0,985	1,55	2,10	2,53	3,74
	Cool kW	1,37	2,16	2,69	3,56	4,76
Running and Starting current	Heat Cool	A A	4,7 7,2	9,6 9,6	11,7 11,7	16,9 16,9
Current 1	Heat	A	13,0	21,0	22,9	24,0
	Cool	A	6,3	9,9	12,2	16,2
Current 2	Heat	A	13,0	13,0	13,0	26,0
	Cool	A	13,0	13,0	13,0	26,0
Recommended fuse	A	30/15	30/15	30/16	30/30	30/30
Recommended cable size, supply 1 & 2	mm <sup>2</sup>	3x4,0 or 6,0/3x4,0	3x4,0 or 6,0/3x4,0	3x4,0 or 6,0/3x4,0	3x4,0 or 6,0/3x4,0	3x4,0 or 6,0/3x4,0
Operation range	Outdoor ambient	°C	-20 ~ +35	-20 ~ +35	-20 ~ +35	-20 ~ +35
	Water outlet	°C	20 ~ 55	20 ~ 55	20 ~ 55	25 ~ 55
Water outlet	Heat	°C	20 ~ 55	20 ~ 55	20 ~ 55	25 ~ 55
	Cool	°C	5 ~ 20	5 ~ 20	5 ~ 20	5 ~ 20

Accessories	
<b>PAW-TD20C1E5</b>	Tank 200L - Stainless steel
<b>PAW-TD30C1E5</b>	Tank 300L - Stainless steel
<b>PAW-TG20C1E3STD-1</b>	Tank 200L - Enamelled
<b>PAW-TG30C1E3STD-1</b>	Tank 300L - Enamelled
<b>PAW-3WYVLV-SI</b>	3 way valve

Accessories	
<b>PAW-BTANK50L</b>	Buffer tank 50L
<b>CZ-TAW1</b>	Aquaarea Smart Cloud for remote control and maintenance through wireless or wired LAN
<b>PAW-A2W-RTWIRED</b>	Room thermostat

EER and COP calculation is based in accordance to EN14511. Sound pressure measured at 1m from the outdoor unit and at 1,5m height. Heating sound pressure measured at +7°C (heating water at 55°C). Authorized service partner or Authorized installer can enable the cooling mode through a special operation via the remote controller on site. 1) Scale from A++ to G. 2) Scale from A+++ to D. System label with controller. 3) WH-MDC models are hermetically sealed.

A+++  
ErP 55°C

A++  
ErP 35°C

INVERTER+

A CLASS  
WATER PUMP  
AUTO SPEED

5,08  
COP  
HIGH PERFORMANCE

-20°C  
DHW

HEATING MODE

WATER FILTER

STOP VALVE

FLOW SENSOR

BOILER CONNECTION

SOLAR KIT

ADVANCED CONTROL

INTERNET CONTROL

BMS  
CONNECTIVITY

5  
YEARS  
WARRANTY

INTERNET CONTROL: Optional.

## NEW AQUAREA T-CAP MONO-BLOC H GENERATION SINGLE PHASE / THREE PHASE. HEATING AND COOLING - MXC

NEW  
18

### The MXC is ideal for residential properties which don't have an external boiler and require a maintained capacity level

T-CAP stands for Total Capacity. This line-up is able to maintain the same nominal capacity even at -20°C without the help of an electrical booster heater. T-CAP is also able to provide extremely high efficiency, regardless of the outside temperature or the water temperature. The MXC adapts well in an existing installation with a boiler backup, and in a new application with underfloor heating, low temperature radiators or even fan-coil heaters. This range can also be connected to a solar kit in order to increase efficiency and minimise the impact on the environment. Finally, it is possible to connect a thermostat for even better heating or cooling control and management.

### Technical focus

- Efficient control of room temperature based on the outdoor temperature, indoor temperature using the Aquarea Manager.
- Optional Smartphone control
- Range from 9 to 16 kW, Single and Three Phase
- Maximum hydraulic module output temperature: 55°C
- Works at temperatures as low as -20°C
- Cooling temperature range 5 ~ 20°C



Tentative data		Single Phase			Three Phase	
Outdoor unit		WH-MXC09H3E5	WH-MXC12H6E5	WH-MXC09H3E8	WH-MXC12H9E8	WH-MXC16H9E8
Heating capacity (A +7°C, W 35°C)	kW	9,00	12,00	9,00	12,00	16,00
COP (A +7°C, W 35°C)	W/W	4,84	4,74	4,84	4,74	4,28
Heating capacity (A +2°C, W 35°C)	kW	9,00	12,00	9,00	12,00	16,00
COP (A +2°C, W 35°C)	W/W	3,59	3,44	3,59	3,44	3,10
Heating capacity (A -7°C, W 35°C)	kW	9,00	12,00	9,00	12,00	16,00
COP (A -7°C, W 35°C)	W/W	2,85	2,72	2,85	2,72	2,49
Cooling capacity (A 35°C, W 7°C)	kW	7,00	10,00	7,00	10,00	12,20
EER (A 35°C, W 7°C)	W/W	3,17	2,81	3,17	2,81	2,56
Energy Efficiency Class at 35°C <sup>1</sup> / 55°C <sup>1</sup>		A+++ / A++	A+++ / A++	A+++ / A++	A+++ / A++	A+++ / A++
System label 35°C / 55°C <sup>2</sup>		A+++ / A++	A+++ / A++	—	—	—
Sound pressure	Heat / Cool	dB(A)	51 / 49	52 / 50	51 / 49	55 / 54
Sound power	Heat / Cool	dB	68 / 67	69 / 68	68 / 67	72 / 71
Dimension	H x W x D	mm	1410 x 1283 x 320	1410 x 1283 x 320	1410 x 1283 x 320	1410 x 1283 x 320
Net weight		kg	142	142	151	164
Refrigerant (R410A) <sup>3</sup>		kg/TCO <sub>2</sub> Eq.	2,30 / 4,802	2,30 / 4,802	2,30 / 4,802	2,35 / 4,907
Water pipe connector		Inch	R 1 1/4	R 1 1/4	R 1 1/4	R 1 1/4
A class pump	Number of speeds		Variable Speed	Variable Speed	Variable Speed	Variable Speed
	Input power (Min/Max) W		32 / 102	34 / 110	32 / 102	34 / 110
Heating water flow (ΔT=5 K, 35°C)		L/min	25,8	34,4	25,8	34,4
Capacity of integrated electric heater		kW	3	6	3	9
Input Power	Heat	kW	1,86	2,53	1,86	2,53
	Cool	kW	2,21	3,56	2,21	3,56
Running and Starting current	Heat	A	8,8	11,7	3,0	4,0
	Cool	A	10,4	16,5	3,5	5,3
Current 1		A	29,0	29,0	14,7	11,9
Current 2		A	13,0	26,0	13,0	13,0
Recommended fuse		A	30/30	30/30	16/16	16/16
Recommended cable size, supply 1 & 2		mm <sup>2</sup>	3x4,0 or 6,0/3x4,0	3x4,0 or 6,0/3x4,0	5x1,5/3x1,5	5x1,5/5x1,5
Operation range	Outdoor ambient	°C	-20 ~ +35	-20 ~ +35	-20 ~ +35	-20 ~ +35
		°C	25 ~ 60	25 ~ 60	25 ~ 60	25 ~ 60
Water outlet	Heat	°C	5 ~ 20	5 ~ 20	5 ~ 20	5 ~ 20
	Cool	°C	5 ~ 20	5 ~ 20	5 ~ 20	5 ~ 20

### Accessories

PAW-TD20C1E5	Tank 200L - Stainless steel
PAW-TD30C1E5	Tank 300L - Stainless steel
PAW-TG20C1E3STD-1	Tank 200L - Enamelled
PAW-TG30C1E3STD-1	Tank 300L - Enamelled
PAW-3WYVLV-SI	3 way valve

### Accessories

PAW-BTANK50L	Buffer tank 50L
CZ-TAW1	Aquarea Smart Cloud for remote control and maintenance through wireless or wired LAN
PAW-A2W-RTWIRED	Room thermostat

EER and COP calculation is based in accordance to EN14511. Sound pressure measured at 1m from the outdoor unit and at 1,5m height. Heating sound pressure measured at +7°C (heating water at 55°C). 1) Scale from A++ to G. 2) Scale from A+++ to D. System label with controller. 3) WH-MXC models are hermetically sealed. \* Tentative data.



INTERNET CONTROL: Optional.

# AQUAREA HT BI-BLOC F GENERATION SINGLE PHASE / THREE PHASE. HEATING ONLY - SHF



## Aquarea HT is able to deliver water heated to 65°C with the Heat Pump alone

For a house with high temperature radiators (for example, cast iron radiators), the Aquarea High Temperature Solution is the most suited as it provides output water temperatures of 65°C even at -20°C.

- Optional Smartphone control
- Range from 9 to 12kW, Single and Three Phase
- Maximum hydraulic module output temperature: 65°C
- Works at temperatures as low as -20°C
- Maximum 20m rise between the outdoor unit and the hydraulic module

### Technical focus

- Remote controller functions
- Efficient control of room temperature based on the outdoor temperature, indoor temperature using the Aquarea Manager

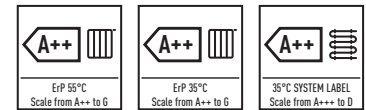

Kit	Single Phase (Power to indoor)		Three Phase (Power to indoor)			
	KIT-WHF09F3E5	KIT-WHF12F6E5	KIT-WHF09F3E8	KIT-WHF12F9E8		
Heating capacity [A +7°C, W 35°C]	kW	9,00	12,00	9,00	12,00	
COP [A +7°C, W 35°C]	W/W	4,64	4,46	4,64	4,46	
Heating capacity [A +2°C, W 35°C]	kW	9,00	12,00	9,00	12,00	
COP [A +2°C, W 35°C]	W/W	3,45	3,26	3,45	3,26	
Heating capacity [A -7°C, W 35°C]	kW	9,00	12,00	9,00	12,00	
COP [A -7°C, W 35°C]	W/W	2,74	2,52	2,74	2,52	
Heating capacity [A +7°C, W 65°C]	kW	9,00	12,00	9,00	12,00	
COP [A +7°C, W 65°C]	W/W	2,48	2,41	2,48	2,41	
Heating capacity [A +2°C, W 65°C]	kW	9,00	10,30	9,00	10,30	
COP [A +2°C, W 65°C]	W/W	2,06	2,01	2,06	2,01	
Heating capacity [A -7°C, W 65°C]	kW	9,00	9,60	9,00	9,60	
COP [A -7°C, W 65°C]	W/W	1,79	1,77	1,79	1,77	
Energy Efficiency Class at 35°C <sup>1</sup> / 55°C <sup>1</sup>		A++ / A++	A++ / A++	A++ / A++	A++ / A++	
System label 35°C / 55°C <sup>2</sup>		A++ / A++	A++ / A++	A++ / A++	A++ / A++	
<b>Indoor unit</b>		<b>WH-SHF09F3E5</b>	<b>WH-SHF12F6E5</b>	<b>WH-SHF09F3E8</b>	<b>WH-SHF12F9E8</b>	
Sound pressure	dB(A)	33	33	33	33	
Dimension	HxWxD	892x502x353	892x502x353	892x502x353	892x502x353	
Net weight	kg	46	47	47	48	
Water pipe connector	Inch	R 1 1/4	R 1 1/4	R 1 1/4	R 1 1/4	
Pump	Number of speeds	7	7	7	7	
	Input power (Min/Max)	W	38/100	40/106	38/100	40/106
Heating water flow (ΔT=5 K, 35°C)	L/min	25,8	34,4	25,8	34,4	
Capacity of integrated electric heater	kW	3	6	3	9	
Recommended fuse	A	30/30	30/30	30/16	30/16	
Recommended cable size, supply 1 & 2	mm <sup>2</sup>	3x4,0 or 6,0/3x4,0	3x4,0 or 6,0/3x4,0	5x1,5/3x1,5	5x1,5/5x1,5	
<b>Outdoor unit</b>		<b>WH-UH09FE5</b>	<b>WH-UH12FE5</b>	<b>WH-UH09FE8</b>	<b>WH-UH12FE8</b>	
Sound pressure / Sound power	dB(A) / dB	51/66	52/67	51/66	52/67	
Dimension / Net weight	HxWxD	mm / kg	1340x900x320/104	1340x900x320/104	1340x900x320/110	1340x900x320/110
Refrigerant (R407C)	kg / TCO <sub>2</sub> Eq.	2,90/5,145	2,90/5,145	2,90/5,145	2,90/5,145	
Pipe diameter	Liquid / Gas	Inch (mm)	3/8(9,52)/5/8(15,88)	3/8(9,52)/5/8(15,88)	3/8(9,52)/5/8(15,88)	3/8(9,52)/5/8(15,88)
Pipe length range	m	3-30	3-30	3-30	3-30	
Elevation difference (in/out)	m	20	20	20	20	
Pipe length for additional gas	m	10	10	10	10	
Additional gas amount	g/m	70	70	70	70	
Operation range	Outdoor ambient	°C	-20 ~ +35	-20 ~ +35	-20 ~ +35	-20 ~ +35
Water outlet	°C	25 ~ 65	25 ~ 65	25 ~ 65	25 ~ 65	

### Accessories

<b>PAW-TD20C1E5</b>	Tank 200L - Stainless steel
<b>PAW-TD30C1E5</b>	Tank 300L - Stainless steel
<b>PAW-TG20C1E3STD-1</b>	Tank 200L - Enamelled
<b>PAW-TG30C1E3STD-1</b>	Tank 300L - Enamelled
<b>PAW-3WYVLV-SI</b>	External 3 way valve

### Accessories

<b>PAW-BTANK50L</b>	Buffer tank 50L
<b>PA-AW-WIFI-1TE</b>	WLAN interface
<b>PAW-A2W-BIV</b>	Bivalent control
<b>PAW-FILTER</b>	Filter
<b>PAW-A2W-RTWIRED</b>	Room thermostat

EER and COP calculation is based in accordance to EN14511. Sound pressure measured at 1m from the outdoor unit and at 1,5m height. Heating sound pressure measured at +7°C (heating water at 55°C). 1) Scale from A++ to G. 2) Scale from A+++ to D. System label with controller.



INTERNET CONTROL: Optional.

HT Mono-bloc

R407C

## AQUAREA HT MONO-BLOC G GENERATION SINGLE PHASE. HEATING ONLY - MHF

### Aquarea HT is able to deliver 65°C with the Heat Pump alone

For a house with high temperature radiators (for example, cast iron radiators), the Aquarea High Temperature Solution is most suited as it provides output water temperatures of 65°C even at -20°C.



### Technical focus

- Efficient control of room temperature based on the outdoor temperature, indoor temperature using the Aquarea Manager.
- Optional Smartphone control
- Range from 9 to 12kW, Single and Three Phase
- Maximum hydraulic module output temperature: 65°C
- Works at temperatures as low as -20°C

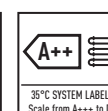
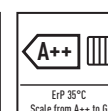

#### Single Phase

Outdoor unit		WH-MHF09G3E5	WH-MHF12G6E5
Heating capacity (A +7°C, W 35°C)	kW	9,00	12,00
COP (A +7°C, W 35°C)	W/W	4,64	4,46
Heating capacity (A +2°C, W 35°C)	kW	9,00	12,00
COP (A +2°C, W 35°C)	W/W	3,45	3,26
Heating capacity (A -7°C, W 35°C)	kW	9,00	12,00
COP (A -7°C, W 35°C)	W/W	2,74	2,52
Heating capacity (A +7°C, W 65°C)	kW	9,00	12,00
COP (A +7°C, W 65°C)	W/W	2,48	2,41
Heating capacity (A +2°C, W 65°C)	kW	9,00	10,30
COP (A +2°C, W 65°C)	W/W	2,06	2,01
Heating capacity (A -7°C, W 65°C)	kW	9,00	9,60
COP (A -7°C, W 65°C)	W/W	1,79	1,77
Energy Efficiency Class at 35°C <sup>1</sup> / 55°C <sup>1</sup>		A++ / A++	A++ / A++
System label 35°C / 55°C <sup>2</sup>		A++ / A++	A++ / A++
Sound pressure	dB(A)	51	52
Sound power	dB	68	69
Dimension	HxWxD	mm	1410 x 1283 x 320
Net weight	kg	151	151
Refrigerant (R407C) <sup>3</sup>	kg/TCO <sub>2</sub> Eq.	1,92/3,406	1,92/3,406
Water pipe connector	Inch	R 1 1/4	R 1 1/4
Pump	Number of speeds	7	7
	Input power (Min/Max)	W	—
Heating water flow (ΔT=5 K, 35°C)	L/min	25,8	34,4
Capacity of integrated electric heater	kW	3	6
Input Power	kW	1,94	2,69
Running and Starting current	A	9,3	12,8
Current 1	A	28,5	29,0
Current 2	A	13,0	26,0
Recommended fuse	A	30/30	30/30
Recommended cable size, supply 1 & 2	mm <sup>2</sup>	3x4,0 or 6,0/3x4,0	3x4,0 or 6,0/3x4,0
Operation range	Outdoor ambient	°C	-20 ~ +35
Water outlet	°C	25 ~ 65	25 ~ 65

#### Accessories

<b>PAW-TD20C1E5</b>	Tank 200L - Stainless steel
<b>PAW-TD30C1E5</b>	Tank 300L - Stainless steel
<b>PAW-TG20C1E3STD-1</b>	Tank 200L - Enamelled
<b>PAW-TG30C1E3STD-1</b>	Tank 300L - Enamelled
<b>PAW-3WYVLV-SI</b>	External 3 way valve

#### Accessories

<b>PAW-BTANK50L</b>	Buffer tank 50L
<b>PA-AW-WIFI-1TE</b>	WLAN interface
<b>PAW-A2W-BIV</b>	Bivalent control
<b>PAW-FILTER</b>	Filter
<b>PAW-A2W-RTWIRED</b>	Room thermostat

EEER and COP calculation is based in accordance to EN14511. Sound pressure measured at 1m from the outdoor unit and at 1,5m height. Heating sound pressure measured at +7°C (heating water at 55°C). 1) Scale from A++ to G. 2) Scale from A+++ to D. System label with controller. 3) WH-MHF models are hermetically sealed.



INTERNET CONTROL: Optional.

# AQUAREA AIR RADIATORS. FAN COILS FOR HEAT PUMP APPLICATION

AQUAREA  
AIR



## New line up of Super low temperature radiators for Heat Pump application: Aquarea Air 200/700/900 with radiating effect

The slimline Panasonic Aquarea Air radiators deliver high efficiency climate control.

With a depth of just under 13cm they are at the cutting edge of the market. Blending easily into the home, Aquarea Air's elegant design and product refinements are clear to see in every detail. Exceptional ventilation efficiency means the motor uses considerably less energy (low wattage). The fan speed is continuously modulated by the temperature controller with proportional integral logic, with undoubted advantages for regulating the temperature and humidity in summer mode.



With standard cast radiators.

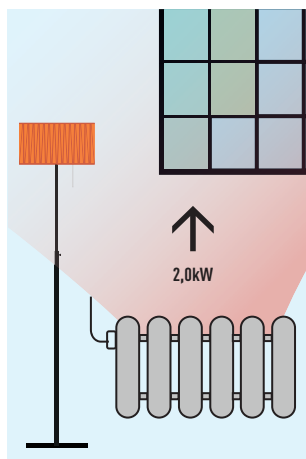

Water at 65°C needed.

With Aquarea Air.

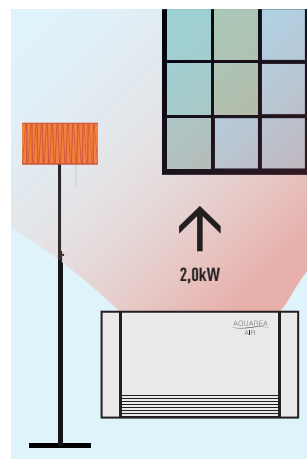

Water at 35°C needed.

### Technical focus:

- Front panel heating with radiant effect
- High heating capacity (without main fan running)
- 4 fan speeds and capacities
- Exclusive design
- Extremely compact (only 12,9cm deep)
- Cooling and dehumidification functions possible (drain is needed)
- 3-way valve included (no overflow valve needed on the installation if more than 3 radiators installed)
- Touch screen thermostat

All temperature curves and capacity are available on [www.panasonicproclub.com](http://www.panasonicproclub.com)

Fan Coils for Heat Pump application		PAW-AAIR-200-1					PAW-AAIR-700-1					PAW-AAIR-900-1				
Total heating capacity	W	138,00	160,00	217,00	470,00	570,00	223,00	360,00	708,00	1032,00	1188,00	273,00	475,00	886,00	1420,00	1703,00
Water flow	kg/h	23,70	27,50	37,30	80,80	98,00	38,40	61,90	121,80	177,50	204,30	47,00	81,70	152,40	244,20	292,90
Water pressure drop	kPa	0,10	0,20	0,40	2,00	2,90	0,10	0,10	0,30	0,80	1,00	0,10	0,20	0,50	1,60	2,20
	m <sup>3</sup> /min	0,50	0,60	0,90	1,90	2,70	0,70	1,40	2,60	4,20	5,30	0,90	1,80	4,10	6,10	7,70
Air flow	Speed	Main	Super	Min	Med	Max	Main	Super	Min	Med	Max	Main	Super	Min	Med	Max
		Fan Off	Min				Fan Off	Min				Fan Off	Min			
Maximum input power	W	2,00	5,00	7,00	9,00	13,00	3,00	9,00	14,00	18,00	22,00	3,00	11,00	16,00	20,00	24,00
Sound pressure	dB(A)	17,60	18,80	24,70	33,20	39,40	18,40	19,60	25,80	34,10	40,20	18,40	22,30	26,20	34,40	42,20
Inlet water temperature	°C	35	35	35	35	35	35	35	35	35	35	35	35	35	35	35
Outlet water temperature	°C	30	30	30	30	30	30	30	30	30	30	30	30	30	30	30
Inlet air temperature	°C	19,00	19,00	19,00	19,00	19,00	19,00	19,00	19,00	19,00	19,00	19,00	19,00	19,00	19,00	19,00
Outlet air temperature	°C	34,50	32,60	38,90	32,00	30,00	34,90	32,40	33,30	31,80	30,60	34,80	32,50	30,20	31,10	30,60
Dimension (HxWxD)	mm	735x579 x 129					935x579 x 129					1135x579 x 129				
Net weight	kg	17					20					23				
3 ways valve included		Yes					Yes					Yes				
Touch screen thermostat		Yes					Yes					Yes				

## NEW VERSATILE AND EFFICIENT FAN COIL RANGE. FAN COIL COMPATIBLE WITH AQUAREA AND VRF SYSTEMS

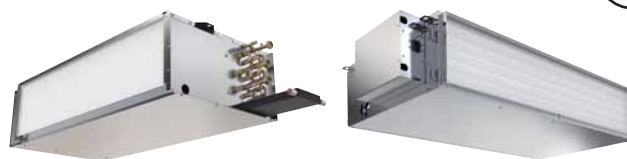
NEW  
18

### New range of Fan Coil units

Easy to install, improvement in sounds levels and performances, are the key developments carried on our Fan Coil units. The Fan Coil is issued from that development striving to meet customers' wishes and advices.

New Fan Coil range consist on one compact ducted range ideal for residential and commercial use and one model with high static pressure for commercial applications. The range certified by Eurovent includes drain pan and filter and are equipped with a low consumption fan motor. Easy maintenance and access.

### 1 Innovation for an optimum comfort

New range of Fan Coil for heating and cooling with 6 capacities from 2,4 to 14,8kw in cooling and from 3,0 to 19,9kW in heating. It can bring full year comfort together with an Aquarea system or VRF systems.

### 2 Low energy consumption fan

5 Speed level. The units are fitted with a fan-motor assembly of which the fan is composed of double inlet forward curved centrifugal wheel dynamically balanced and specially designed for an optimal air flow.

### 3 Quality and efficient Coil

Made of staggered copper tubes, mechanically expanded into aluminium fins, assuring maximum heat transfer efficiency. Equipped with a main chilled water coil with 3 rows.

### 4 Easy and flexible installation

- Suction G2 air filter from both sides and for the bottom
- Includes drain pan

Tentative data			Compact units					High Static Pressure
Model			PAW-FC-D24	PAW-FC-D40	PAW-FC-D55	PAW-FC-D65	PAW-FC-D90	PAW-FC-H150
Total cooling capacity	Med / S-Hi	kW	2,0/2,4	3,1/4,1	4,2/5,5	5,8/6,6	6,7/9,1	11,9/14,8
Sensible cooling	Med / S-Hi	kW	1,7/2,1	2,2/3,0	3,0/4,0	4,3/5,0	4,9/7,0	9,6/12,9
Heating capacity	Med / S-Hi	kW	2,4/3,0	3,9/5,4	4,0/5,3	7,4/8,7	9,3/12,6	14,9/19,9
Power consumption	S-Lo / Med / S-Hi	W	24/50/81	33/57/86	39/76/112	60/114/161	90/112/188	180/421/675
Fuse rating		A	2	2	2	2	2	3,17
Dimensions	H x W x D	mm	220 x 624 x 430	220 x 994 x 430	220 x 1179 x 430	220 x 994 x 530	220 x 1250 x 530	356 x 1380 x 798
Dimensions (including pan and electrical box)	H x W x D	mm	220 x 862 x 430	220 x 1232 x 430	220 x 1417 x 430	220 x 1232 x 530	220 x 1463 x 530	356 x 1600 x 798
Weight (without water content)		kg	15,5	24	28	29	43	63
Sound power global	S-Lo / Med / S-Hi	dB(A)	31/45/53	36/48/57	40/52/58	46/59/63	52/57/66	52/64/71
Static pressure	Max	Pa	50	70	70	70	70	110
Airflow <sup>1</sup>	Med / S-Hi	m <sup>3</sup> /h	388/483	486/716	640/933	989/1064	936/1397	2112/3176
Water pressure drop	Med / S-Hi	kPa	9,9/14,3	13,0/22,4	25,2/42,2	13,9/17,9	22,6/40,3	19,8/26,1
Fan speeds			3 speeds	3 speeds	3 speeds	3 speeds	3 speeds	3 speeds
Fan motor and total speeds			AC 5 speeds	AC 5 speeds	AC 5 speeds	AC 5 speeds	AC 5 speeds	AC 5 speeds
Drain pan			Included	Included	Included	Included	Included	Included
Air filter			Included	Included	Included	Included	Included	Included
Water connections		Inch	1/2	1/2	1/2	1/2 [1/4 cooling]	1/2	1

1) Airflow at 0Pa of static pressure.

Performances based on: Summer air 27°C /19°C (wet Bulb and chilled water 7/12°C - Winter air 20°C, entering water temperature 50°C.

## SANITARY TANKS. A WIDE RANGE OF TANKS ADAPTED TO EVERY NEED

Panasonic offers best combination of Aquarea with DHW. The wide range is covered with 1 Tank with buffer tank, 2 Stainless Tanks with energy efficiency class A and 5 Enamelled tanks from 150 to 400L.

### New Combo Tank.

The best option to combine with Mono-bloc units. DHW tank with buffer tank. Designed for retrofit applications, the DHW 185l tank with a 80l buffer tank is particularly suitable for fast integration on an existing installation. Panasonic has developed a tank with 80l Buffer tank and 185l sanitary hot water cylinder. This tank includes a 3-way valve and an "A" Class pump. Easy to install, nice looking, high efficiency for DHW production and for heating.

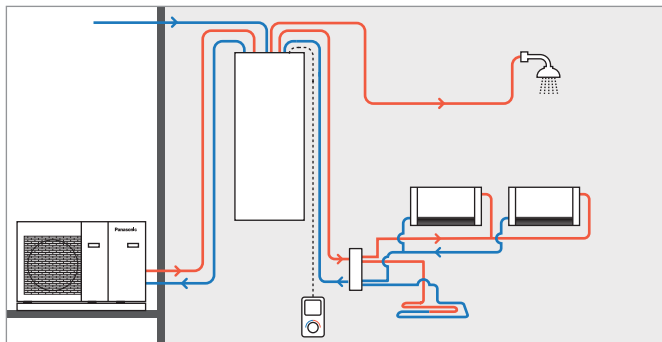

		PAW-TD20B8E3-1	
Dimension H x W x D	mm	1770 x 640 x 690	
Weight (empty)	kg	150	
Volume	L	185	
Power supply	V, Phase, Hz	230, 1, 50	
<b>Hot water tank</b>			
Volume	L	185	
Max working pressure	MPa (bar)	0,8 (8)	
Pressure test	MPa (bar)	1,2 (12)	
Max working temp	°C	90	
Connections	mm	Ø22	
Material		S 275 JR vitrified	
Insulation	Material, t=mm	PUR, 50	
Heating coil surface	m <sup>2</sup>	2,1	
Electrical heater	W	3000	
Energy loss at 65°C	kWh/24h	1,3	
<b>Buffer tank</b>			
Volume	L	80	
Max working pressure	MPa (bar)	0,6 (6)	
Pressure test	MPa (bar)	0,9 (9)	
Max working temp	°C	100	
Connections	mm	Ø22	
Material		S235 JR	
Insulation	Material, t=mm	PUR 40mm	
<b>ErP data</b>			
		<b>Hot water tank 185</b>	<b>Buffer tank 80</b>
Energy efficiency class (from A+ to F)		B	B
Standing loss	W	53	46
Storage volume	L	185	80

1) EU Regulation 812/2013, 2) Tested pursuant to EN 12897:2006.









### Enamelled Tank.





With our enamelled tanks wide range, we can satisfy any size needs. Consisting on 4 different size: 150, 200, 300 and 400L. The 300L is also available in with 2 coils version.

### Stainless Steel Tank.

The best heat pump in market needs to be complemented with best efficiency tank. Panasonic energy efficiency A Class Stainless Tank consist in 2 capacities 200 and 300L. These 2 models are anode free does not require any maintenance.

Tanks		Stainless Steel Tank	
Model		PAW-TD20C1E5	PAW-TD30C1E5
			
Water volume	L	192	280
Maximum water temperature	°C	75	75
Dimensions	Hight / Diameter	mm	mm
		1265/595	1745/595
Weight / filled with water	kg	53/—	65/—
Electric heater	kW	1,5	1,5
Power supply	V	230	230
Material inside tank		Stainless steel	Stainless steel
Exchange surface	m <sup>2</sup>	1,8	1,8
Energy loss at 65°C <sup>1</sup>	kWh/24h	0,99	1,13
3 Way valve accessory PAW-3WYVLV-SI or CZ-NV1		Optional	Optional
20m temperature sensor cable included		Yes	Yes
Heat up time	Valuation	★★★★	★★★★
Energy losses	Valuation	★★★★	★★★★
Energy Efficiency Class (from A+ to F)		A	A
Warranty		2 years	2 years
Maintenance required		No	No

1) Insulated tested under EN12897. \* Includes proportional control thermostat.

Tanks		Enamelled Tank				Enamelled 2 coils Tank (for bivalent Solar + HP)
Model		PAW-TG15C1EZ	PAW-TG20C1E3STD-1	PAW-TG30C1E3STD-1	PAW-TG40C1E3STD-1	PAW-TG30C2E3STD-1
						
Water volume	L	150	185	285	396	284
Maximum water temperature	°C	85	95	95	95	95
Dimensions	Hight / Diameter	mm	mm	mm	mm	mm
		1345/500	1507/580	1565/680	1888/760	1417/760
Weight / filled with water	kg	70/220	97/282	140/425	171/567	134/418
Electric heater	kW	2	3	3	3	3
Power supply	V	230	230	230	230	230
Material inside tank		Steel enamelled	Enamelled	Enamelled	Enamelled	Enamelled
Exchange surface	m <sup>2</sup>	1,4	2,0	2,5	6,1	2,4 (for HP) +1,0 (for solar or boiler)
Energy loss at 65°C <sup>1</sup>	kWh/24h	1,41	1,6	2,1	1,7	1,6
3 Way valve accessory PAW-3WYVLV-SI or CZ-NV1		Optional	Optional	Optional	Optional	Optional
20m temperature sensor cable included		Yes	Yes	Yes	Yes	Yes
Heat up time	Valuation		★★★★	★★★★	★★★★	★★★★
Energy losses	Valuation		★★★★	★★★★	★★★★	★★★★
Energy Efficiency Class (from A+ to F)		C	C	C	B	B
Warranty		2 years	2 years	2 years	2 years	2 years
Maintenance required		Yearly	Yearly	Yearly	Yearly	Yearly

1) Insulated tested under EN12897. \* Includes proportional control thermostat.

## AQUAREA DHW

### DHW tank with built-in Heat Pump

The Heat Pump is one of the most energy efficient and cost effective methods of water heating. The pump is mounted on the storage tank and draws energy from the ambient air, using that extra energy source to heat the water up to 55°C.

### Wall mounted Aquarea DHW. Mid Capacity: 80/100/120L

Designed for maximum energy savings, Aquarea DHW's medium tank volume has been designed as a perfect replacement for the electric water heater. The conventional medium tank volume has been boosted with a heat pump generator, which delivers superior energy performance. The air-to-water heat pump design with air ducts enables the selection of inlet and outlet points for the air, which allows it to be used in various parts of the home (kitchen, bathroom, sunrooms, etc.).



### Aquarea DHW Advantages

- High-technology rotational compressor ensures higher energy efficiency and a higher coefficient of performance, which means major energy savings – up to 75%.
- Wrapped around the inside of the outer cover of the tank, it prevents the build-up of limescale, extends the useful life of the equipment and improves safety.
- The dimensions and heating capability of a medium volume Aquarea DHW tank can easily replace an existing electric water heater. Its small size allows it to be installed in spaces where previously a conventional electric water heater would be installed.
- Impressive tank protection is provided through the use of superior super-clean enamel and a large magnesium element. These ensure durability even in the harshest operating conditions, without harmful additives in the water.

### Floor standing at -7°C Aquarea DHW. High capacity: 200/295L

The DHW is ready to achieve levels of high efficiency even at temperatures as low as -7°C. With this range it is possible to connect an additional heat source, such as solar energy. In PAW-DHWM300AE, the heat pump cools and de-humidifies the air pumped either from outdoors or from within the building. By choosing the point of air capture and exhaust, you can ventilate and de-humidify some rooms, while extracting the cooled air either into the environment or into another room that you wish to cool.

## Floor standing at -7°C Aquarea DHW. High capacity: 200/295L.

## Technical focus

- Energy efficiency A class
- 119,1 % Energy efficiency  $\eta_{wh}^1$
- 1204,2kWh AEC annual electricity consumption<sup>1</sup>
- 6,57kWh Daily electricity consumption  $Q_{elec}^2$
- 55°C Thermostat temperature settings
- 0 Value of smart

1) EU Regulation 812/2013 ; EN 16147:2010. 2) EN 16147:2010.

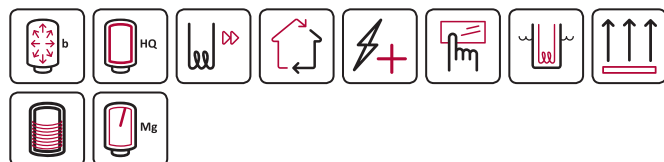

## Wall mounted Aquarea DHW. Mid Capacity: 80/100/120L.

## Technical focus

- Capacity: 80, 100 and 120L
- Vertical wall mounting
- Operating range between -7°C to +35°C
- LCD touch screen display



Model Reference	Floor standing at -7°C*			Wall mounted			
	PAW-DHWM200A	PAW-DHWM300A	PAW-DHWM300AE	PAW-DHWM80ZNT	PAW-DHWM100ZNT	PAW-DHWM120ZNT	
Volume	L	208	295	276	80	100	120
Height / with air ducts	mm	1540x670x690	1960x670x690	1960x670x690	1197x506x533	1342x506x533	1497x506x533
Connections to the water supply network		G1	G1	G1	G1/2	G1/2	G1/2
Dimension of air ducts	mm / m	Ø160/—	Ø160/—	Ø160/—	Ø125(150x70)/10	Ø125(150x70)/10	Ø125(150x70)/10
Net weight / with water	kg	149/365	164/459	207/480	58/138	62/162	68/188
Nominal electrical power	W	490	490	490	250	250	250
Reference tapping cycle		L	XL	XL	M	M	M
Energy consumption by chosen cycle A7 / W10-55 <sup>1</sup>	kWh	4,05	5,77	5,96	2,45	2,35	2,51
Energy consumption by chosen cycle A15 / W10-55 <sup>2</sup>	kWh	3,95	5,65	5,75	2,04	2,05	2,08
COP DHW (A7 / W10-55) EN 16147 <sup>1</sup>		3,00	3,33	3,30	2,65	2,63	2,61
COP DHW (A15 / W10-55) EN 16147 <sup>2</sup>		3,07	3,39	3,38	3,10	3,10	3,10
Energy Efficiency Class (from A+ to F)		<b>A</b>	<b>A</b>	<b>A</b>	<b>A</b>	<b>A</b>	<b>A</b>
Standby Input power according to EN16147	W	28	18	20	19	20	27
Sound power / Sound Pressure on 1m	dB / dB(A)	—/58	—/58	—/58	51,0/39,5	51,0/39,5	51,0/39,5
Refrigerant		R134a	R134a	R134a	R134a	R134a	R134a
Quantity of refrigerant	g	1100	1100	1100	540	540	540
Operating range - air temperature	°C	-7/+35	-7/+35	-7/+35	-7/+35	-7/+35	-7/+35
Nominal air flow rate (Maximum)	m³/min	7,5	7,5	7,5	1,7-3,8	1,7-3,8	1,7-3,8
Maximum pressure drop (volumetric flow rate at 5,5m³/min (60%))	Pa	100	100	100	—	—	—
Pressure drop by 2,5m³/min (60%/80%) (Maximum) <sup>3</sup>	Pa	—	—	—	70(90)	70(90)	70(90)
Enamelled steel tank / Protective magnesium anode		+/+	+/+	+/+	+/+	+/+	+/+
Average insulation thickness	mm	—	—	—	40-85	40-85	40-85
External source exchanger (m² surface / connection)		—	—	2,7/G1	—	—	—
Max. power consumption without heater	W	490	490	490	—	—	—
Max. power consumption with heater	W	2490	2490	2490	2350	2350	2350
Number of electrical heaters x power	W	2x1000	2x1000	2x1000	2x1000	2x1000	2x1000
Voltage / Frequency	V / Hz	230/50	230/50	230/50	230/50	230/50	230/50
Electric protection	A	16	16	16	16	16	16
Moisture protection		IP24	IP24	IP24	IP24	IP24	IP24
Working pressure (Storage tank / Heat Exchanger)	MPa (bar)	0,6(6)/0,9(9)	0,6(6)/0,9(9)	1,0(10)	1,0(10)	1,0(10)	1,0(10)
Heating with heat pump Min / Max	°C	55/65	55/65	55/65	55/—	55/—	55/—
Heating with electrical heater	°C	75	75	75	75	75	75
Refrigerant (R134a) <sup>4</sup>	kg/TCO <sub>2</sub> Eq.	1,100/1,573	1,100/1,573	1,100/1,573	0,540/0,772	0,540/0,772	0,540/0,772

1) Heating of sanitary water up to 55°C with inlet air temperature at 7°C, humidity at 89% and inlet water temperature at 10°C. According to EN16147. 2) Heating of sanitary water up to 55°C with inlet air temperature at 15°C, humidity at 74% and inlet water temperature at 10°C. According to EN16147. 3) Normal fan speed 60%, higher fan speed - special setting on 80%. 4) Aquarea DHW units are hermetically sealed. \* When connected as pressurised, use of safety valve is mandatory.



Pressurised

High-Quality insulation

Fast heating

Air ducts

Additional heating source

Electronic regulation with touch screen

Indirect tubular air heating element

Vertical floor mounting

Vertical wall mounting

External exchanger

Magnesium anode corrosion protection

# ACCESSORIES & CONTROL

## Optional PCB's for additional functions



**CZ-NS2P**  
PCB for solar connection kit for Mono-bloc systems.



**CZ-NS3P**  
PCB for solar connection kit for Mono-bloc systems 6kW and 9kW.



**CZ-NS4P**  
PCB for advanced functions in H Generation.

## Deice accessories



**CZ-NE1P**  
Base pan heater (for all old Bi-bloc and Mono-bloc, not for the 3 and 5kW).

**CZ-NE2P**  
Base pan heater (for 3kW and 5kW).

**CZ-NE3P**  
Base pan heater for H Generation.

## Accessories for All in One

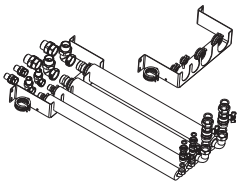

**PAW-ADC-PREKIT-1**  
Flexible pipings and wall mounting plate for All in One H Generation.

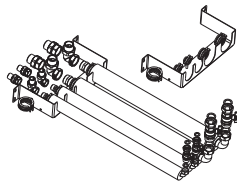

**PAW-ADC-PREKIT**  
Flexible pipings and wall mounting plate for All in One G Generation.



**PAW-ADC-CV150**  
Decorative magnetic side cover.

## Accessories for Aquarea Air

**PAW-AAIR-LEGS-1**  
Kits of 2 legs to support the Aquarea Air on the floor and to protect the water pipings.

## Accessories for Aquarea DHW

**PAW-DHWE2C**  
2kW optional electrical heater for floor standing.

**PAW-DHWE3C**  
3kW optional electrical heater for floor standing.

## Special outdoor supports



**PAW-WTRAY**  
Tray for condenser water compatible with base ground support.



**PAW-GRDSTD40**  
Outdoor elevation platform.



**PAW-GRDBSE20**  
Outdoor base ground support for noise and vibration absorption (600 x 95 x 130mm, 500kg).

## Sanitary tank accessories



**PAW-TS1**  
Tank sensor with 6m cable length.



**CZ-TK1**  
Temperature sensor kit for third party tank (with copper pocket and 6m length sensor cable).

**PAW-TS2**  
Tank sensor with 20m cable length.

**PAW-TS4**  
Tank sensor with 6m cable length and only 6mm diameter.

## Hydraulic accessories



**PAW-A2W-2ZONEKIT**  
2 zone kit.



**PAW-BTANK50L**  
Buffer tank 50L.



**CZ-NV1**  
3 way valve ready for All in One H Generation (optional in internal space).

**PAW-3WYVLV-SI**  
External 3 way valve.

**PAW-2PMP2ZONE**  
2 zone kit, hydraulic switch, manifold, 2 A-class pumps, 1 mixture valve.

**PAW-A2W-2ZONECVR**  
2 zone kit box cover.

**PAW-FILTER**  
2 check valves + filter with 1" (no needed for H Generation).

**PAW-FILTER-ONLY**  
Filter with 1" (no needed for H Generation).

**PAW-A2WFILTERFLOW**  
Filter and water flow meter (no needed for H Generation).

**Aquarea Manager accessories (not compatible with H Generation)**



**PAW-HPM1**  
Aquarea Manager with LCD.



**PAW-HPM2**  
Aquarea Manager without LCD.



**PAW-HPMED**  
Touch screen.

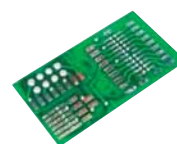

**PAW-HPMINT-U**  
Interface to connect Aquarea Manager to Heat pump Aquarea Bi-bloc (HPM can control all parameters from HP).



**PAW-HPMB1**  
Buffer tank sensor.



**PAW-LANCABLE**  
Network cable.



**PAW-HPMAH1**  
Water flow pipe sensor for heating circuit.



**PAW-HPMUH**  
Outdoor temperature sensor.

**PAW-HPMINT-M**  
Interface to connect Aquarea Manager to Heat pump Aquarea Mono-bloc (HPM can control all parameters from HP).

**PAW-HPMDHW**  
Buffer tank sensor with well.

**PAW-HPMSOL1**  
Buffer tank sensor solar (with higher temperature range).



**PAW-A2WSWITCH**  
Network switch.

**PAW-HPMINT-F**  
Interface to connect Aquarea Manager to Heat pump Aquarea Mono-bloc and Bi-bloc F type (HPM can control all parameters from HP).

**PAW-HPMR4**  
Room sensor + set point adaptation.

**PAW-DEWPOINTSSENSOR**  
Dew point sensor.

**Aquarea Manager Kits**

**PAW-HPM12ZONE-U**  
HPM with room sensor and setpoint adaption for Bi-bloc + sensors.

**PAW-HPM12ZONELCD-U**  
HPM with LCD wireless room thermostat for Bi-bloc + sensors.

**PAW-HPM12ZONE-M**  
HPM with room sensor and setpoint adaption for Mono-bloc + sensors.

**PAW-HPM12ZONELCD-M**  
HPM with LCD wireless room thermostat for Mono-bloc + sensors.

**PAW-HPM12ZONE-UF**  
HPM with room sensor and setpoint adaption for F Generation.

**PAW-HPM12ZONELCD-UF**  
HPM with LCD wireless room thermostat for F Generation.

**PAW-HPM12ZONE-MF**  
HPM with room sensor and setpoint adaption for F Generation.

**PAW-HPM12ZONELCD-M**  
HPM with LCD wireless room thermostat for F Generation.

**Connectivity solutions**



**CZ-TAW1**  
Aquarea Smart Cloud for remote control and maintenance through wireless or wired LAN.



**PAW-AW-KNX-1i\***  
KNX interface.



**PAW-AW-MBS-1\***  
Modbus interface.

**PA-AW-WIFI-1TE\***  
IntesisHome interface with temperature sensor accessory.

**PAW-AW-KNX-H**  
KNX interface for H Generation.

**PAW-AW-MBS-H**  
Modbus interface for H Generation.

\* Not compatible with H Generation.

**Controller**



**PAW-A2W-BIV**  
Bivalent controller.

\* Not compatible with H Generation.

**Fan coil Controller**



**PAW-FC-303TC**  
Fan coil control.

**Room thermostats**



**PAW-A2W-RTWIRED**  
Wired LCD room thermostat with weekly timer.



**PAW-A2W-RTWIRELESS**  
Wireless LCD room thermostat with weekly timer.

**H Generation sensors**



**PAW-A2W-TSOD**  
Outdoor ambient sensor.



**PAW-A2W-TSRT**  
Zone room sensor.



**PAW-A2W-TSHC**  
Zone water sensor.



**PAW-A2W-TSSO**  
Solar sensor.

**PAW-A2W-TSBU**  
Buffer tank sensor.

# PANASONIC'S AQUAREA OFFERS THE BEST FOR YOU AND YOUR HOME

Panasonic will supply the energy label and a product fiche for all delivered products affected by these regulations, which sales partners, traders and contractors must use when labelling our products.

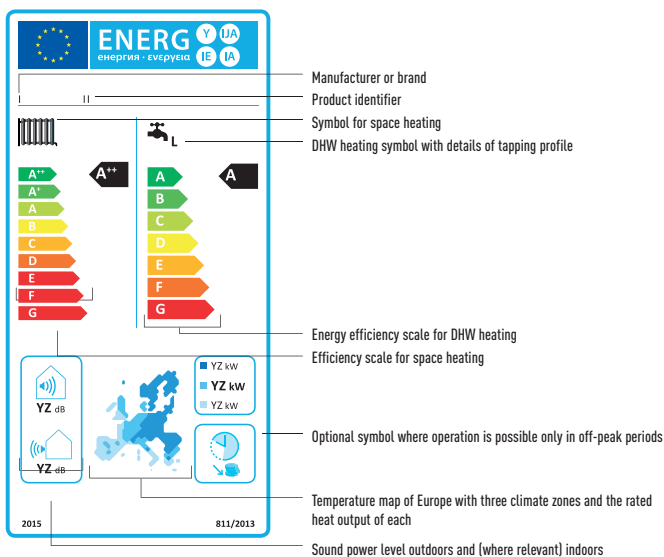

## Energy Label

Fridges, dishwashers, washing machines, ovens – it all started with white goods in the 1990s. Today, other energy-consuming appliances also carry the European energy efficiency label, such as TV sets, lighting and – since September 2014 – even vacuum cleaners. Since 2013 the regulations already apply to air conditioners and heat pumps. Since September 2015, it has been applicable also to room heaters, water heaters and storage water heaters.

Minimum energy efficiency requirements are also specified for manufacturers of system and combi boilers, water heaters and DHW cylinders.

Energy Labels are to assist consumers in their purchasing decisions, and ecodesign requirements on products are to help reduce private energy demand, as well as to contribute minimising global warming.

## Panasonic helps you to calculate the system label .

From 26th September 2015, installers can be assured that all products manufactured after this date will be sold with the required energy efficiency labels which will aid installers with their paperwork. While it is the manufacturer's responsibility to issue their products with the required labels, the installers will need to calculate and issue an energy efficiency label for the entire heating system. Whether installing a new heating system or installing new boilers, controls or renewables into an existing system, it is, and will continue to be, the installer's responsibility to calculate and issue energy efficiency labels. Calculators which assist installers with this process are available on [www.panasonicproclub.com](http://www.panasonicproclub.com).

## Information on the energy efficiency label.

The rating system for Heat Pumps classifies them into nine efficiency categories. The best energy efficiency category is A++. The best energy efficiency class is currently A++, the worst is G. The energy efficiency label for system boilers shows its efficiency category on a scale from A++ to G (from A to G for hot water cylinders). In September 2019, a more rigorous scale will be introduced from A+++ to D, and from A+ to F for hot water cylinders.

## Panasonic helps you to calculate the system label

[www.panasonicproclub.com](http://www.panasonicproclub.com)

or connect simply with your smartphone to the PRO Club using this QR



**PRO Club**

## A typical example of savings and performances that Aquarea can offer to you.

### A 125m<sup>2</sup> house in Reims

The example below shows a typical 3 bedroom French home and highlights the potential savings that can be achieved with Panasonic's Aquarea heat pump\*.

\* Calculations were carried using Panasonic's Aquarea Designer software, available from the PRO Club website ([www.panasonicproclub.com](http://www.panasonicproclub.com)).

Service hot water	
Type of service	Hot water with heat pump
Tank volume	300 Litre
Average daily need	200 Litre
Cold water inlet temperature	10°C
Target tank temperature	50°C
Exchange loss	5K
Electrical auxiliary heating necessary	No

Used Panasonic heat pump	
<b>Description</b>	<b>T-CAP 12kW</b>
<b>Sanitary tank</b>	<b>Stainless steel 300L</b>
Heat pump type	Air / Water
Capacity / consumption at 2°C (heating water at 35°C)	Heat: 11,7kW, Electric: 3,4kW
Recommended flow-through of air	80,0m <sup>3</sup> /min
Maximum flow temperature	55°C
Mode of operation	Monovalent
Design	-5,0°C
Number of heat pumps used	1
Wattage of fan (included in heat pump performance data: yes)	60W
Power consumption of heat circulation pump(s)	180W

Building data	
Address	Reims (French)
Building area	125m <sup>2</sup>
Standard heating requirement	11,3kW
Internal gains	5625kWh/year
Solar gains (windows)	4500kWh/year
Indoor design temperature	20°C
Outdoor temperature limit for heating 'ON'	15°C
Heat distribution	Underfloor heating by 100 %
	Radiator heating by -- %
	Wall heating by -- %
Maximum flow water temperature	55°C
Maximum return water temperature	50°C
Solar collector area	-- m <sup>2</sup>

Rate data	
Description	French (Panasonic)
Shut off times total	0,0 h/day
Weekends with shut off times	Yes
Daytime rate of heat pump	Time for daytime rate
	5-19 o'clock
Nighttime rate of heat pump	Time for nighttime rate
	19-5 o'clock
Heat circulation pump(s)	Like heat pump: yes -- pence/kWh
Heating element for monoenergetic operation	Like heat pump: yes -- pence/kWh
Heating element for post heating of hot water	Like heat pump: yes -- pence/kWh

Climatic data								
Climatic location	Reims (FR)							
Monthly average temperatures in °C	Jan	3,4	Apr	8,0	Jul	16,0	Oct	10,4
	Feb	3,6	May	11,2	Aug	15,9	Nov	6,7
	Mar	5,7	Jun	14,1	Sep	13,7	Dec	4,6

### Calculation results

#### Monthly heat consumption in kWh.

Annual energy costs		Caused by heat consumers	
<b>Caused by heat producers</b>		Space heating	1220 €
Heat pump	1600 €	Service hot water	225 €
Hot water heating rod	0 €	Heat circulation pump(s)	155 €
<b>Total</b>		<b>Total</b>	<b>1600 €</b>

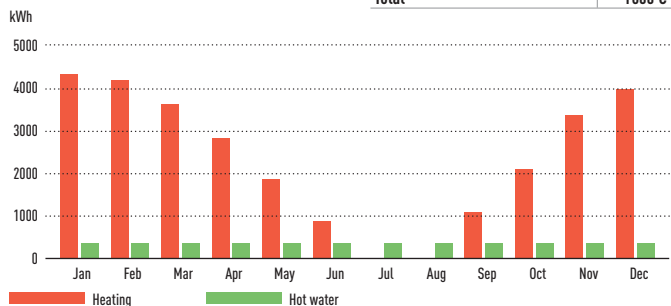

#### Aquarea energy coverage.

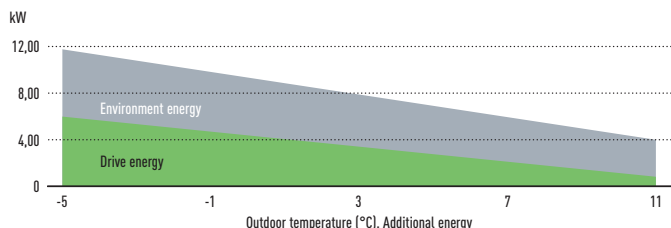

#### Comparison of running costs.

Operational costs				
Type of heating	Price in pence / kWh	Efficiency (%)	Additional costs in €/year	Total costs in €/year
Heat pump	-	-	0	1600
Oil	6,5	85	0	3050
Gas	4,0	90	0	1868
Wood heating	5,0	80	0	2539
Electric night storage heater	12,0	100	0	4455
Electric heating element	14,0	100	0	5197

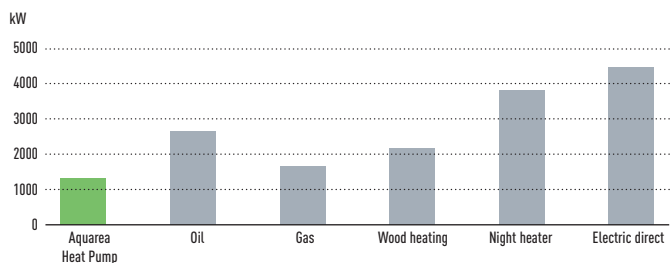

#### Comparison of CO<sub>2</sub> emissions.

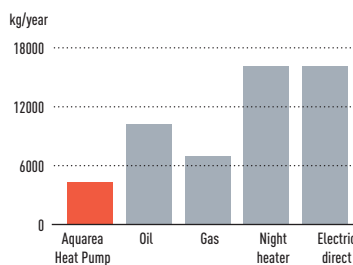

#### Comparison of CO<sub>2</sub> savings.

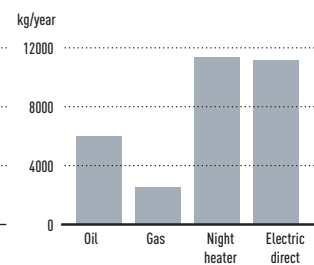

**HEATING & COOLING CAPACITY TABLES.** Based on outlet temperature and outside temperature.

**Aquarea High Performance Bi-bloc H Generation Single Phase. Heating and Cooling**

WH-UD03HE5-1																		
Tamb	HC	IP	COP	HC	IP	COP	HC	IP	COP	HC	IP	COP	HC	IP	COP	HC	IP	COP
LWC	30	30	30	35	35	35	40	40	40	45	45	45	50	50	50	55	55	55
-15	3,20	1,26	2,54	3,20	1,39	2,30	3,10	1,52	2,04	3,00	1,64	1,83	2,80	1,78	1,57	2,75	1,92	1,43
-7	3,20	1,08	2,96	3,20	1,19	2,69	3,20	1,34	2,39	3,20	1,48	2,16	3,20	1,67	1,92	3,20	1,86	1,72
2	3,20	0,82	3,90	3,20	0,90	3,56	3,20	1,03	3,11	3,20	1,16	2,76	3,20	1,33	2,41	3,20	1,49	2,15
7	3,20	0,58	5,52	3,20	0,64	5,00	3,20	0,77	4,16	3,20	0,89	3,60	3,20	1,05	3,05	3,20	1,20	2,67
16	3,20	0,50	6,40	3,20	0,55	5,82	3,20	0,64	5,00	3,20	0,72	4,44	3,20	0,86	3,72	3,20	0,99	3,23
25	3,20	0,42	7,62	3,20	0,46	6,96	3,20	0,55	5,82	3,20	0,63	5,08	3,20	0,73	4,38	3,20	0,82	3,90
WH-UD05HE5-1																		
Tamb	HC	IP	COP	HC	IP	COP	HC	IP	COP	HC	IP	COP	HC	IP	COP	HC	IP	COP
LWC	30	30	30	35	35	35	40	40	40	45	45	45	50	50	50	55	55	55
-15	4,20	1,75	2,40	4,20	1,94	2,16	3,80	1,96	1,94	3,40	1,98	1,72	3,20	2,05	1,56	3,00	2,12	1,42
-7	4,20	1,46	2,88	4,20	1,62	2,59	4,00	1,72	2,33	3,80	1,82	2,09	3,70	1,95	1,90	3,55	2,08	1,71
2	4,20	1,22	3,44	4,20	1,35	3,11	4,20	1,50	2,80	4,20	1,65	2,55	4,15	1,86	2,23	4,10	2,07	1,98
7	5,00	0,97	5,15	5,00	1,08	4,63	5,00	1,28	3,91	5,00	1,48	3,38	5,00	1,68	2,98	5,00	1,89	2,65
16	5,00	0,83	6,02	5,00	0,92	5,43	5,00	1,15	4,35	5,00	1,38	3,62	5,00	1,53	3,27	5,00	1,68	2,98
25	5,00	0,74	6,76	5,00	0,82	6,10	5,00	1,02	4,90	5,00	1,22	4,10	5,00	1,35	3,70	5,00	1,49	3,36
WH-UD07HE5-1																		
Tamb	HC	IP	COP	HC	IP	COP	HC	IP	COP	HC	IP	COP	HC	IP	COP	HC	IP	COP
LWC	30	30	30	35	35	35	40	40	40	45	45	45	50	50	50	55	55	55
-15	—	—	—	4,60	1,98	2,32	4,60	2,19	2,10	4,60	2,40	1,92	4,55	2,63	1,73	4,50	2,86	1,57
-7	—	—	—	5,15	1,92	2,68	5,08	2,14	2,37	5,00	2,36	2,12	4,90	2,45	2,00	4,80	2,54	1,89
2	—	—	—	6,55	1,96	3,34	6,58	2,29	2,87	6,60	2,62	2,52	6,30	2,82	2,23	6,00	3,01	1,99
7	—	—	—	7,00	1,57	4,46	7,00	1,84	3,80	7,00	2,10	3,33	6,90	2,35	2,94	6,80	2,59	2,63
25	—	—	—	7,00	0,97	7,22	6,74	1,14	5,91	6,48	1,31	4,95	6,24	1,43	4,36	6,00	1,55	3,87
WH-UD09HE5-1																		
Tamb	HC	IP	COP	HC	IP	COP	HC	IP	COP	HC	IP	COP	HC	IP	COP	HC	IP	COP
LWC	30	30	30	35	35	35	40	40	40	45	45	45	50	50	50	55	55	55
-15	—	—	—	5,90	2,66	2,22	5,65	2,82	2,00	5,40	2,98	1,81	5,20	3,08	1,69	5,00	3,18	1,57
-7	—	—	—	5,90	2,34	2,52	5,85	2,61	2,24	5,80	2,88	2,01	5,80	2,98	1,95	5,80	3,08	1,88
2	—	—	—	6,70	2,14	3,13	6,65	2,38	2,79	6,60	2,62	2,52	6,30	2,82	2,23	6,00	3,01	1,99
7	—	—	—	9,00	2,18	4,13	9,00	2,49	3,61	9,00	2,79	3,23	8,95	3,25	2,75	8,90	3,70	2,41
25	—	—	—	9,00	1,26	7,14	8,66	1,48	5,85	8,32	1,69	4,92	8,03	1,85	4,34	7,74	2,01	3,85
WH-UD12HE5																		
Tamb	HC	IP	COP	HC	IP	COP	HC	IP	COP	HC	IP	COP	HC	IP	COP	HC	IP	COP
LWC	30	30	30	35	35	35	40	40	40	45	45	45	50	50	50	55	55	55
-15	9,30	3,46	2,69	8,90	3,62	2,46	8,50	3,79	2,24	8,10	3,95	2,05	7,50	4,05	1,85	7,00	4,16	1,68
-7	10,40	3,37	3,09	10,00	3,66	2,73	9,60	3,95	2,43	9,20	4,24	2,17	8,70	4,26	2,04	8,20	4,27	1,92
2	11,80	3,10	3,81	11,40	3,31	3,44	11,00	3,53	3,12	10,60	3,74	2,83	9,80	3,94	2,49	9,10	4,14	2,20
7	12,00	2,10	5,71	12,00	2,53	4,74	12,00	2,96	4,05	12,00	3,39	3,54	12,00	3,78	3,17	12,00	4,16	2,88
25	12,00	1,38	8,70	12,00	1,66	7,23	11,80	1,94	6,08	11,70	2,23	5,25	11,50	2,49	4,62	11,40	2,74	4,16
WH-UD16HE5																		
Tamb	HC	IP	COP	HC	IP	COP	HC	IP	COP	HC	IP	COP	HC	IP	COP	HC	IP	COP
LWC	30	30	30	35	35	35	40	40	40	45	45	45	50	50	50	55	55	55
-15	10,60	4,09	2,59	10,30	4,38	2,35	10,00	4,67	2,14	9,70	4,96	1,96	8,80	4,94	1,78	7,90	4,91	1,61
-7	11,90	4,03	2,95	11,40	4,43	2,57	10,80	4,83	2,24	10,30	5,22	1,97	9,60	5,09	1,89	9,00	4,95	1,82
2	13,50	3,74	3,61	13,00	3,96	3,28	12,40	4,18	2,97	11,90	4,40	2,70	10,80	4,46	2,42	9,80	4,51	2,17
7	16,00	3,21	4,98	16,00	3,74	4,28	16,00	4,27	3,75	16,00	4,80	3,33	15,20	5,11	2,97	14,50	5,41	2,68
25	16,00	2,31	6,93	16,00	2,69	5,95	16,00	3,07	5,21	16,00	3,45	4,64	16,00	3,67	4,36	15,90	3,89	4,09

Tamb: Ambient Temperature [°C]. LWC: Leaving Water Condenser Temperature [°C]. HC: Heating Capacity [kW]. CC: Cooling Capacity [kW]. IP: Power Input [kW]  
 This data is measured by Panasonic in accordance with EN14511-2 standard. This data is for reference purpose only, and does not guarantee the performance.



## Aquarea High Performance Bi-bloc H Generation Single Phase. Heating and Cooling

## WH-UD03HE5-1

Tamb	CC	IP	EER	CC	IP	EER	CC	IP	EER
LWC	7	7	7	14	14	14	18	18	18
18	2,40	0,42	5,71	4,40	0,73	6,03	3,70	0,49	7,55
25	3,20	0,73	4,38	4,10	0,86	4,77	3,50	0,59	5,93
35	3,20	1,04	3,08	3,90	1,07	3,64	3,30	0,74	4,46
43	2,90	1,20	2,42	3,50	1,20	2,92	3,00	0,88	3,41

## WH-UD05HE5-1

Tamb	CC	IP	EER	CC	IP	EER	CC	IP	EER
LWC	7	7	7	14	14	14	18	18	18
18	4,50	0,89	5,06	5,00	0,90	5,56	5,70	0,90	6,33
25	5,00	1,43	3,50	6,30	1,50	4,20	5,40	1,06	5,09
35	4,50	1,67	2,69	5,50	1,68	3,27	5,00	1,33	3,76
43	3,30	1,53	2,16	4,10	1,52	2,70	4,40	1,53	2,88

## WH-UD07HE5-1

Tamb	CC	IP	EER	CC	IP	EER	CC	IP	EER
LWC	7	7	7	14	14	14	18	18	18
18	4,80	0,80	6,00	7,20	1,16	6,21	6,00	1,13	5,31
25	7,00	1,90	3,68	8,47	1,78	4,76	6,00	1,27	4,72
35	6,00	2,28	2,63	6,60	2,48	2,66	6,00	1,68	3,57
43	4,85	2,65	1,83	6,00	2,82	2,13	4,80	1,98	2,42

## WH-UD09HE5-1

Tamb	CC	IP	EER	CC	IP	EER	CC	IP	EER
LWC	7	7	7	14	14	14	18	18	18
18	5,40	1,00	5,40	8,40	1,62	5,19	7,00	1,61	4,35
25	7,85	2,40	3,27	10,20	2,46	4,15	7,00	1,77	3,95
35	7,00	2,88	2,43	7,60	3,20	2,38	7,00	2,15	3,26
43	5,20	2,85	1,82	6,99	3,84	1,82	5,60	2,55	2,20

## WH-UD12HE5

Tamb	CC	IP	EER	CC	IP	EER	CC	IP	EER
LWC	7	7	7	14	14	14	18	18	18
16	7,86	1,18	6,66	13,15	1,40	9,39	10,00	1,73	5,78
25	12,08	2,90	4,17	15,70	2,05	7,66	10,00	1,97	5,08
35	10,00	2,56	3,91	12,00	2,67	4,49	10,00	2,40	4,17
43	7,80	3,80	2,05	11,10	3,19	3,48	8,00	2,85	2,81

## WH-UD16HE5

Tamb	CC	IP	EER	CC	IP	EER	CC	IP	EER
LWC	7	7	7	14	14	14	18	18	18
16	9,20	1,62	5,68	16,40	2,58	6,36	12,20	2,45	4,98
25	14,40	3,92	3,67	19,20	3,83	5,01	12,20	2,79	4,37
35	12,20	4,76	2,56	15,00	4,98	3,01	12,20	2,96	4,12
43	7,75	3,40	2,28	13,80	5,95	2,32	9,70	4,00	2,43

Tamb: Ambient Temperature (°C). LWC: Leaving Water Condenser Temperature (°C). HC: Heating Capacity (kW). CC: Cooling Capacity (kW). IP: Power Input (kW)  
 This data is measured by Panasonic in accordance with EN14511-2 standard. This data is for reference purpose only, and does not guarantee the performance.

**HEATING & COOLING CAPACITY TABLES.** Based on outlet temperature and outside temperature.

**Aqueara High Performance Bi-bloc H Generation Three Phase. Heating and Cooling**

WH-UD09HE8																		
Tamb	HC	IP	COP	HC	IP	COP	HC	IP	COP	HC	IP	COP	HC	IP	COP	HC	IP	COP
LWC	30	30	30	35	35	35	40	40	40	45	45	45	50	50	50	55	55	55
-15	8,65	3,06	2,83	8,30	3,21	2,59	7,95	3,41	2,33	7,60	3,61	2,11	7,15	3,71	1,93	6,70	3,81	1,76
-7	9,35	2,91	3,21	9,00	3,16	2,85	8,85	3,54	2,50	8,70	3,92	2,22	8,30	3,89	2,13	7,90	3,86	2,05
2	9,31	2,35	3,96	9,00	2,51	3,59	9,00	2,78	3,24	9,00	3,05	2,95	8,90	3,49	2,55	8,80	3,94	2,23
7	9,00	1,54	5,84	9,00	1,86	4,84	9,00	2,16	4,17	9,00	2,46	3,66	9,00	2,76	3,26	9,00	3,06	2,94
25	9,00	1,05	8,57	9,00	1,24	7,26	8,73	1,44	6,06	8,46	1,64	5,16	8,28	1,82	4,55	8,10	2,00	4,05
WH-UD12HE8																		
Tamb	HC	IP	COP	HC	IP	COP	HC	IP	COP	HC	IP	COP	HC	IP	COP	HC	IP	COP
LWC	30	30	30	35	35	35	40	40	40	45	45	45	50	50	50	55	55	55
-15	9,30	3,46	2,69	8,90	3,62	2,46	8,50	3,79	2,24	8,10	3,95	2,05	7,50	4,05	1,85	7,00	4,16	1,68
-7	10,40	3,37	3,09	10,00	3,66	2,73	9,60	3,95	2,43	9,20	4,24	2,17	8,70	4,26	2,04	8,20	4,27	1,92
2	11,80	3,10	3,81	11,40	3,31	3,44	11,00	3,53	3,12	10,60	3,74	2,83	9,80	3,94	2,49	9,10	4,14	2,20
7	12,00	2,10	5,71	12,00	2,53	4,74	12,00	2,96	4,05	12,00	3,39	3,54	12,00	3,78	3,17	12,00	4,16	2,88
25	12,00	1,38	8,70	12,00	1,66	7,23	11,80	1,94	6,08	11,70	2,23	5,25	11,50	2,49	4,62	11,40	2,74	4,16
WH-UD16HE8																		
Tamb	HC	IP	COP	HC	IP	COP	HC	IP	COP	HC	IP	COP	HC	IP	COP	HC	IP	COP
LWC	30	30	30	35	35	35	40	40	40	45	45	45	50	50	50	55	55	55
-15	10,60	4,09	2,59	10,30	4,38	2,35	10,00	4,67	2,14	9,70	4,96	1,96	8,80	4,94	1,78	7,90	4,91	1,61
-7	11,90	4,03	2,95	11,40	4,43	2,57	10,80	4,83	2,24	10,30	5,22	1,97	9,60	5,09	1,89	9,00	4,95	1,82
2	13,50	3,74	3,61	13,00	3,96	3,28	12,40	4,18	2,97	11,90	4,40	2,70	10,80	4,46	2,42	9,80	4,51	2,17
7	16,00	3,21	4,98	16,00	3,74	4,28	16,00	4,27	3,75	16,00	4,80	3,33	15,20	5,11	2,97	14,50	5,41	2,68
25	16,00	2,31	6,93	16,00	2,69	5,95	16,00	3,07	5,21	16,00	3,45	4,64	16,00	3,67	4,36	15,90	3,89	4,09

**Aqueara High Performance Bi-bloc H Generation Three Phase. Heating and Cooling**

WH-UD09HE8									
Tamb	CC	IP	EER	CC	IP	EER	CC	IP	EER
LWC	7	7	7	14	14	14	18	18	18
16	7,50	1,15	6,52	9,10	1,20	7,58	7,00	1,13	6,19
25	8,35	1,77	4,72	10,90	1,78	6,12	7,00	1,24	5,65
35	7,00	2,23	3,14	8,30	2,32	3,58	7,00	1,52	4,61
43	5,52	2,54	2,17	7,69	2,77	2,78	5,60	1,80	3,11
WH-UD12HE8									
Tamb	CC	IP	EER	CC	IP	EER	CC	IP	EER
LWC	7	7	7	14	14	14	18	18	18
16	7,86	1,18	6,66	13,15	1,40	9,39	10,00	1,73	5,78
25	12,08	2,90	4,17	15,70	2,05	7,66	10,00	1,97	5,08
35	10,00	2,56	3,91	12,00	2,67	4,49	10,00	2,40	4,17
43	7,80	3,80	2,05	11,10	3,19	3,48	8,00	2,85	2,81
WH-UD16HE8									
Tamb	CC	IP	EER	CC	IP	EER	CC	IP	EER
LWC	7	7	7	14	14	14	18	18	18
16	9,20	1,62	5,68	16,40	2,58	6,36	12,20	2,45	4,98
25	14,40	3,92	3,67	19,20	3,83	5,01	12,20	2,79	4,37
35	12,20	4,76	2,56	15,00	4,98	3,01	12,20	2,96	4,12
43	7,75	3,40	2,28	13,80	5,95	2,32	9,70	4,00	2,43

Tamb: Ambient Temperature (°C). LWC: Leaving Water Condenser Temperature (°C). HC: Heating Capacity (kW). CC: Cooling Capacity (kW). IP: Power Input (kW)  
 This data is measured by Panasonic in accordance with EN14511-2 standard. This data is for reference purpose only, and does not guarantee the performance.

**Aquarea T-CAP Bi-bloc H Generation Single Phase / Three Phase. Heating and Cooling**

WH-UX09HE5																		
Tamb	HC	IP	COP	HC	IP	COP	HC	IP	COP	HC	IP	COP	HC	IP	COP	HC	IP	COP
LWC	30	30	30	35	35	35	40	40	40	45	45	45	50	50	50	55	55	55
-15	9,00	3,24	2,78	9,00	3,51	2,56	9,00	3,91	2,30	9,00	4,30	2,09	9,00	4,73	1,90	9,00	5,16	1,74
-7	9,00	2,71	3,32	9,00	3,16	2,85	9,00	3,62	2,49	9,00	4,07	2,21	9,00	4,27	2,11	9,00	4,46	2,02
2	9,00	2,36	3,81	9,00	2,51	3,59	9,00	2,78	3,24	9,00	3,05	2,95	9,00	3,56	2,53	9,00	4,07	2,21
7	9,00	1,64	5,49	9,00	1,86	4,84	9,00	2,16	4,17	9,00	2,46	3,66	9,00	2,76	3,26	9,00	3,06	2,94
25	13,60	1,50	9,07	13,60	1,71	7,95	13,20	1,93	6,84	12,80	2,14	5,98	12,00	2,41	4,98	11,20	2,67	4,19
WH-UX12HE5																		
Tamb	HC	IP	COP	HC	IP	COP	HC	IP	COP	HC	IP	COP	HC	IP	COP	HC	IP	COP
LWC	30	30	30	35	35	35	40	40	40	45	45	45	50	50	50	55	55	55
-15	12,00	4,75	2,53	12,00	4,96	2,42	12,00	5,41	2,22	11,00	5,38	2,04	10,80	5,82	1,86	10,50	6,26	1,68
-7	12,00	3,85	3,12	12,00	4,41	2,72	12,00	4,98	2,41	12,00	5,54	2,17	12,00	5,90	2,03	12,00	6,26	1,92
2	12,00	3,19	3,76	12,00	3,49	3,44	12,00	3,87	3,10	12,00	4,25	2,82	12,00	4,86	2,47	12,00	5,47	2,19
7	12,00	2,18	5,50	12,00	2,53	4,74	12,00	2,96	4,05	12,00	3,39	3,54	12,00	3,78	3,17	12,00	4,16	2,88
25	13,60	1,55	8,77	13,60	1,76	7,73	13,40	2,10	6,38	13,20	2,43	5,43	12,60	2,66	4,74	12,00	2,89	4,15
WH-UX09HE8																		
Tamb	HC	IP	COP	HC	IP	COP	HC	IP	COP	HC	IP	COP	HC	IP	COP	HC	IP	COP
LWC	30	30	30	35	35	35	40	40	40	45	45	45	50	50	50	55	55	55
-15	9,00	3,24	2,78	9,00	3,51	2,56	9,00	3,91	2,30	9,00	4,30	2,09	9,00	4,73	1,90	9,00	5,16	1,74
-7	9,00	2,71	3,32	9,00	3,16	2,85	9,00	3,62	2,49	9,00	4,07	2,21	9,00	4,27	2,11	9,00	4,46	2,02
2	9,00	2,36	3,81	9,00	2,51	3,59	9,00	2,78	3,24	9,00	3,05	2,95	9,00	3,56	2,53	9,00	4,07	2,21
7	9,00	1,64	5,49	9,00	1,86	4,84	9,00	2,16	4,17	9,00	2,46	3,66	9,00	2,76	3,26	9,00	3,06	2,94
25	13,60	1,50	9,07	13,60	1,71	7,95	13,20	1,93	6,84	12,80	2,14	5,98	12,00	2,41	4,98	11,20	2,67	4,19
WH-UX12HE8																		
Tamb	HC	IP	COP	HC	IP	COP	HC	IP	COP	HC	IP	COP	HC	IP	COP	HC	IP	COP
LWC	30	30	30	35	35	35	40	40	40	45	45	45	50	50	50	55	55	55
-15	12,00	4,75	2,53	12,00	4,96	2,42	12,00	5,41	2,22	12,00	5,86	2,05	11,80	6,24	1,89	11,60	6,62	1,75
-7	12,00	3,85	3,12	12,00	4,41	2,72	12,00	4,98	2,41	12,00	5,54	2,17	12,00	5,90	2,03	12,00	6,26	1,92
2	12,00	3,19	3,76	12,00	3,49	3,44	12,00	3,87	3,10	12,00	4,25	2,82	12,00	4,86	2,47	12,00	5,47	2,19
7	12,00	2,18	5,50	12,00	2,53	4,74	12,00	2,96	4,05	12,00	3,39	3,54	12,00	3,78	3,17	12,00	4,16	2,88
25	13,60	1,55	8,77	13,60	1,76	7,73	13,40	2,10	6,38	13,20	2,43	5,43	12,60	2,66	4,74	12,00	2,89	4,15
WH-UX16HE8																		
Tamb	HC	IP	COP	HC	IP	COP	HC	IP	COP	HC	IP	COP	HC	IP	COP	HC	IP	COP
LWC	30	30	30	35	35	35	40	40	40	45	45	45	50	50	50	55	55	55
-15	16,00	6,30	2,54	16,00	6,89	2,32	16,00	7,45	2,15	16,00	8,10	1,98	16,00	8,48	1,89	15,20	8,96	1,70
-7	16,00	5,85	2,74	16,00	6,42	2,49	16,00	7,00	2,29	16,00	7,57	2,11	16,00	8,10	1,98	16,00	8,62	1,86
2	16,00	4,67	3,43	16,00	5,21	3,07	16,00	5,74	2,79	16,00	6,31	2,54	16,00	6,90	2,32	16,00	7,50	2,13
7	16,00	3,35	4,78	16,00	3,74	4,28	16,00	4,30	3,72	16,00	4,80	3,33	16,00	5,43	2,95	16,00	5,91	2,71
16	16,00	2,59	6,18	16,00	3,18	5,03	16,00	3,71	4,31	16,00	4,27	3,75	16,00	4,86	3,29	16,00	5,22	3,07
25	16,00	2,02	7,92	16,00	2,58	6,20	16,00	2,91	5,50	16,00	3,36	4,76	16,00	3,74	4,28	16,00	4,00	4,00

**Aquarea T-CAP Bi-bloc H Generation Single Phase / Three Phase. Heating and Cooling**

Models	WH-UX09HE5									WH-UX12HE5								
	Tamb	CC	IP	EER	CC	IP	EER	CC	IP	EER	CC	IP	EER	CC	IP	EER	CC	IP
LWC	7	7	7	14	14	14	18	18	18	7	7	7	14	14	14	18	18	18
18	7,00	1,36	5,15	8,55	1,41	6,06	7,00	1,00	7,00	10,00	1,75	5,71	13,20	1,96	6,73	10,00	1,40	7,14
25	7,65	1,91	4,01	11,10	1,98	5,61	7,00	1,10	6,36	11,20	2,67	4,19	16,50	3,01	5,48	10,00	1,60	6,25
35	7,00	2,21	3,17	9,23	2,37	3,89	7,00	1,35	5,19	10,00	3,56	2,81	12,55	3,63	3,46	10,00	1,95	5,13
43	6,25	2,66	2,35	8,55	2,71	3,15	5,60	1,60	3,50	8,00	3,35	2,39	10,00	3,46	2,89	8,00	2,30	3,48
Models	WH-UX09HE8						WH-UX12HE8						WH-UX16HE8					
	Tamb	CC	IP	EER	CC	IP	EER	CC	IP	EER	CC	IP	EER	CC	IP	EER	CC	IP
LWC	7	7	7	18	18	18	7	7	7	18	18	18	7	7	7	18	18	18
18	7,00	1,36	5,15	—	—	—	7,50	1,41	5,32	—	—	—	8,50	1,70	5,00	10,00	1,70	5,88
25	7,65	1,91	4,01	—	—	—	8,90	2,16	4,12	—	—	—	14,00	4,00	3,50	14,00	2,94	4,76
35	7,00	2,21	3,17	—	—	—	10,00	3,56	2,81	—	—	—	12,20	4,76	2,56	12,20	3,50	3,49
43	6,25	2,66	2,35	—	—	—	8,00	3,01	2,66	—	—	—	7,10	3,31	2,15	9,80	3,31	2,96

Tamb: Ambient Temperature (°C). LWC: Leaving Water Condenser Temperature (°C). HC: Heating Capacity (kW). CC: Cooling Capacity (kW). IP: Power Input (kW). This data is measured by Panasonic in accordance with EN14511-2 standard. This data is for reference purpose only, and does not guarantee the performance.

## HEATING & COOLING CAPACITY TABLES. Based on outlet temperature and outside temperature.

### Aquarea T-CAP Bi-bloc H Generation Three Phase. Super Quiet outdoor unit. Heating and Cooling - SQC

WH-UQ09HE8																		
Tamb	HC	IP	COP	HC	IP	COP	HC	IP	COP	HC	IP	COP	HC	IP	COP	HC	IP	COP
LWC	30	30	30	35	35	35	40	40	40	45	45	45	50	50	50	55	55	55
-15	9,00	3,24	2,78	9,00	3,51	2,56	9,00	3,91	2,30	9,00	4,30	2,09	9,00	4,73	1,90	9,00	5,16	1,74
-7	9,00	2,71	3,32	9,00	3,16	2,85	9,00	3,62	2,49	9,00	4,07	2,21	9,00	4,27	2,11	9,00	4,46	2,02
2	9,00	2,36	3,81	9,00	2,51	3,59	9,00	2,78	3,24	9,00	3,05	2,95	9,00	3,56	2,53	9,00	4,07	2,21
7	9,00	1,64	5,49	9,00	1,86	4,84	9,00	2,16	4,17	9,00	2,46	3,66	9,00	2,76	3,26	9,00	3,06	2,94
25	13,60	1,50	9,07	13,60	1,71	7,95	13,20	1,93	6,84	12,80	2,14	5,98	12,00	2,41	4,98	11,20	2,67	4,19
WH-UQ12HE8																		
Tamb	HC	IP	COP	HC	IP	COP	HC	IP	COP	HC	IP	COP	HC	IP	COP	HC	IP	COP
LWC	30	30	30	35	35	35	40	40	40	45	45	45	50	50	50	55	55	55
-15	12,00	4,75	2,53	12,00	4,96	2,42	12,00	5,41	2,22	12,00	5,86	2,05	11,80	6,24	1,89	11,60	6,62	1,75
-7	12,00	3,85	3,12	12,00	4,41	2,72	12,00	4,98	2,41	12,00	5,54	2,17	12,00	5,90	2,03	12,00	6,26	1,92
2	12,00	3,19	3,76	12,00	3,49	3,44	12,00	3,87	3,10	12,00	4,25	2,82	12,00	4,86	2,47	12,00	5,47	2,19
7	12,00	2,18	5,50	12,00	2,53	4,74	12,00	2,96	4,05	12,00	3,39	3,54	12,00	3,78	3,17	12,00	4,16	2,88
25	13,60	1,55	8,77	13,60	1,76	7,73	13,40	2,10	6,38	13,20	2,43	5,43	12,60	2,66	4,74	12,00	2,89	4,15
WH-UQ16HE8																		
Tamb	HC	IP	COP	HC	IP	COP	HC	IP	COP	HC	IP	COP	HC	IP	COP	HC	IP	COP
LWC	30	30	30	35	35	35	40	40	40	45	45	45	50	50	50	55	55	55
-15	16,00	6,30	2,54	16,00	6,89	2,32	16,00	7,45	2,15	16,00	8,10	1,98	16,00	8,48	1,89	15,20	8,96	1,70
-7	16,00	5,85	2,74	16,00	6,42	2,49	16,00	7,00	2,29	16,00	7,57	2,11	16,00	8,10	1,98	16,00	8,62	1,86
2	16,00	4,67	3,43	16,00	5,21	3,07	16,00	5,74	2,79	16,00	6,31	2,54	16,00	6,90	2,32	16,00	7,50	2,13
7	16,00	3,35	4,78	16,00	3,74	4,28	16,00	4,30	3,72	16,00	4,80	3,33	16,00	5,43	2,95	16,00	5,91	2,71
16	16,00	2,59	6,18	16,00	3,18	5,03	16,00	3,71	4,31	16,00	4,27	3,75	16,00	4,86	3,29	16,00	5,22	3,07
25	16,00	2,02	7,92	16,00	2,58	6,20	16,00	2,91	5,50	16,00	3,36	4,76	16,00	3,74	4,28	16,00	4,00	4,00

### Aquarea T-CAP Bi-bloc H Generation Three Phase. Super Quiet outdoor unit. Heating and Cooling - SQC

WH-UQ09HE8						
Tamb	CC	IP	EER	CC	IP	EER
LWC	7	7	7	18	18	18
18	7,00	1,36	5,15	—	—	—
25	7,65	1,91	4,01	—	—	—
35	7,00	2,21	3,17	—	—	—
43	6,25	2,66	2,35	—	—	—
WH-UQ12HE8						
Tamb	CC	IP	EER	CC	IP	EER
LWC	7	7	7	18	18	18
18	7,50	1,41	5,32	—	—	—
25	8,90	2,16	4,12	—	—	—
35	10,00	3,56	2,81	—	—	—
43	8,00	3,01	2,66	—	—	—
WH-UQ16HE8						
Tamb	CC	IP	EER	CC	IP	EER
LWC	7	7	7	18	18	18
18	8,50	1,70	5,00	10,00	1,70	5,88
25	14,00	4,00	3,50	14,00	2,94	4,76
35	12,20	4,76	2,56	12,20	3,50	3,49
43	7,10	3,31	2,15	9,80	3,31	2,96

Tamb: Ambient Temperature (°C). LWC: Leaving Water Condenser Temperature (°C). HC: Heating Capacity (kW). CC: Cooling Capacity (kW). IP: Power Input (kW)  
This data is measured by Panasonic in accordance with EN14511-2 standard. This data is for reference purpose only, and does not guarantee the performance.

**Aquarea High Performance Mono-bloc H Generation Single Phase. Heating and Cooling - MDC**

<b>WH-MDC05H3E5</b>																		
Tamb	HC	IP	COP	HC	IP	COP	HC	IP	COP	HC	IP	COP	HC	IP	COP	HC	IP	COP
LWC	30	30	30	35	35	35	40	40	40	45	45	45	50	50	50	55	55	55
-15	5,13	2,02	2,54	5,00	2,20	2,27	4,88	2,39	2,04	4,75	2,57	1,85	4,08	2,29	1,78	3,40	2,00	1,70
-7	4,80	1,49	3,23	4,70	1,65	2,85	4,60	1,82	2,53	4,50	1,98	2,27	4,40	2,13	2,07	4,30	2,28	1,89
2	5,10	1,34	3,81	4,80	1,43	3,36	4,50	1,52	2,96	4,20	1,61	2,61	4,10	1,67	2,46	4,00	1,72	2,33
7	5,00	0,79	6,33	5,00	0,99	5,08	5,00	1,18	4,24	5,00	1,37	3,65	5,00	1,57	3,19	5,00	1,76	2,84
12	4,85	0,77	6,29	4,83	0,89	5,46	4,82	1,00	4,82	4,80	1,12	4,29	4,74	1,25	3,81	4,68	1,37	3,42
<b>WH-MDC07H3E5</b>																		
Tamb	HC	IP	COP	HC	IP	COP	HC	IP	COP	HC	IP	COP	HC	IP	COP	HC	IP	COP
LWC	30	30	30	35	35	35	40	40	40	45	45	45	50	50	50	55	55	55
-15	4,60	1,68	2,75	4,60	1,89	2,43	4,60	2,11	2,19	4,60	2,32	1,98	4,55	2,56	1,78	4,50	2,79	1,61
-7	5,60	1,88	2,99	5,50	2,04	2,70	5,40	2,21	2,45	5,30	2,37	2,24	5,15	2,56	2,01	5,00	2,75	1,82
2	6,65	1,79	3,73	6,60	2,00	3,30	6,55	2,22	2,96	6,50	2,43	2,67	6,40	2,64	2,43	6,30	2,84	2,22
7	7,00	1,33	5,28	7,00	1,55	4,52	7,00	1,78	3,94	7,00	2,00	3,50	7,00	2,24	3,13	7,00	2,47	2,83
12	7,00	1,30	5,38	7,00	1,45	4,83	7,05	1,65	4,27	7,10	1,90	3,74	7,15	2,10	3,40	7,20	2,30	3,13
<b>WH-MDC09H3E5</b>																		
Tamb	HC	IP	COP	HC	IP	COP	HC	IP	COP	HC	IP	COP	HC	IP	COP	HC	IP	COP
LWC	30	30	30	35	35	35	40	40	40	45	45	45	50	50	50	55	55	55
-15	6,10	2,34	2,61	5,90	2,50	2,36	5,70	2,67	2,14	5,50	2,83	1,94	5,25	2,99	1,76	5,00	3,14	1,59
-7	6,55	2,26	2,90	6,40	2,46	2,60	6,25	2,66	2,35	6,10	2,86	2,13	5,95	3,06	1,95	5,80	3,25	1,78
2	6,85	1,92	3,58	6,80	2,14	3,18	6,75	2,37	2,85	6,70	2,59	2,59	6,50	2,78	2,34	6,30	2,96	2,13
7	9,00	1,80	5,01	9,00	2,10	4,29	9,00	2,41	3,74	9,00	2,71	3,32	9,00	3,01	2,99	9,00	3,31	2,72
12	9,10	1,61	5,65	9,00	1,79	5,03	9,00	2,09	4,31	9,10	2,40	3,79	9,20	2,80	3,29	9,30	3,00	3,10
<b>WH-MDC12H6E5</b>																		
Tamb	HC	IP	COP	HC	IP	COP	HC	IP	COP	HC	IP	COP	HC	IP	COP	HC	IP	COP
LWC	30	30	30	35	35	35	40	40	40	45	45	45	50	50	50	55	55	55
-15	9,30	3,46	2,69	8,90	3,62	2,46	8,50	3,79	2,24	8,10	3,95	2,05	—	—	—	7,00	4,10	1,71
-7	10,40	3,37	3,09	10,00	3,66	2,73	9,60	3,95	2,43	9,20	4,24	2,17	—	—	—	8,20	4,21	1,95
2	11,80	3,10	3,81	11,40	3,31	3,44	11,00	3,53	3,12	10,60	3,74	2,83	—	—	—	9,10	4,08	2,23
7	12,00	2,10	5,71	12,00	2,53	4,74	12,00	2,96	4,05	12,00	3,39	3,54	—	—	—	12,00	4,10	2,93
12	12,00	1,38	8,70	12,00	1,66	7,23	11,80	1,94	6,08	11,70	2,23	5,25	—	—	—	11,40	2,74	4,16
<b>WH-MDC16H6E5</b>																		
Tamb	HC	IP	COP	HC	IP	COP	HC	IP	COP	HC	IP	COP	HC	IP	COP	HC	IP	COP
LWC	30	30	30	35	35	35	40	40	40	45	45	45	50	50	50	55	55	55
-15	10,60	4,09	2,59	10,30	4,38	2,35	10,00	4,67	2,14	9,70	4,96	1,96	7,90	4,84	1,63	—	—	—
-7	11,90	4,03	2,95	11,40	4,43	2,57	10,80	4,83	2,24	10,30	5,22	1,97	9,00	4,88	1,84	—	—	—
2	13,50	13,74	0,98	13,00	3,96	3,28	12,40	4,18	2,97	11,90	4,40	2,70	9,80	4,44	2,21	—	—	—
7	16,00	3,21	4,98	16,00	3,74	4,28	16,00	4,27	3,75	16,00	4,80	3,33	14,50	5,33	2,72	—	—	—
12	16,00	2,31	6,93	16,00	2,69	5,95	16,00	3,07	5,21	16,00	3,45	4,64	15,90	3,89	4,09	—	—	—

Tamb: Ambient Temperature (°C). LWC: Leaving Water Condenser Temperature (°C). HC: Heating Capacity (kW). CC: Cooling Capacity (kW). IP: Power Input (kW)  
 This data is measured by Panasonic in accordance with EN14511-2 standard. This data is for reference purpose only, and does not guarantee the performance.

**HEATING & COOLING CAPACITY TABLES.** Based on outlet temperature and outside temperature.**Aquarea High Performance Mono-bloc H Generation Single Phase. Heating and Cooling - MDC****WH-MDC05H3E5**

Tamb	CC	IP	EER	CC	IP	EER	CC	IP	EER
<b>LWC</b>	<b>7</b>	<b>7</b>	<b>7</b>	<b>14</b>	<b>14</b>	<b>14</b>	<b>18</b>	<b>18</b>	<b>18</b>
<b>24</b>	5,15	1,06	4,86	6,45	1,05	6,14	5,90	0,73	8,08
<b>35</b>	4,50	1,37	3,28	5,52	1,36	4,06	5,10	1,00	5,10
<b>43</b>	3,74	1,55	2,41	4,65	1,60	2,91	4,25	1,20	3,54

**WH-MDC07H3E5**

Tamb	CC	IP	EER	CC	IP	EER	CC	IP	EER
<b>LWC</b>	<b>7</b>	<b>7</b>	<b>7</b>	<b>14</b>	<b>14</b>	<b>14</b>	<b>18</b>	<b>18</b>	<b>18</b>
<b>24</b>	6,85	1,78	3,85	8,15	1,80	4,53	7,10	1,20	5,92
<b>35</b>	6,00	2,16	2,78	5,35	1,53	3,51	6,00	1,55	3,87
<b>43</b>	4,90	2,48	1,98	4,45	1,80	2,47	5,10	1,85	2,76

**WH-MDC09H3E5**

Tamb	CC	IP	EER	CC	IP	EER	CC	IP	EER
<b>LWC</b>	<b>7</b>	<b>7</b>	<b>7</b>	<b>14</b>	<b>14</b>	<b>14</b>	<b>18</b>	<b>18</b>	<b>18</b>
<b>24</b>	7,30	1,92	3,80	8,60	1,98	4,34	8,20	1,55	5,29
<b>35</b>	7,00	2,69	2,60	6,40	1,93	3,32	7,00	1,95	3,59
<b>43</b>	5,25	2,84	1,85	5,40	2,25	2,40	6,00	2,30	2,61

**WH-MDC12H6E5**

Tamb	CC	IP	EER	CC	IP	EER	CC	IP	EER
<b>LWC</b>	<b>7</b>	<b>7</b>	<b>7</b>	<b>14</b>	<b>14</b>	<b>14</b>	<b>18</b>	<b>18</b>	<b>18</b>
<b>16</b>	7,86	1,18	6,66	13,15	2,05	6,41	10,00	1,73	5,78
<b>25</b>	12,08	2,90	4,17	15,70	3,05	5,15	10,00	1,97	5,08
<b>35</b>	10,00	3,56	2,81	12,00	3,67	3,27	10,00	2,15	4,65
<b>43</b>	7,80	3,80	2,05	11,10	3,19	3,48	8,00	2,85	2,81

**WH-MDC16H6E5**

Tamb	CC	IP	EER	CC	IP	EER	CC	IP	EER
<b>LWC</b>	<b>7</b>	<b>7</b>	<b>7</b>	<b>14</b>	<b>14</b>	<b>14</b>	<b>18</b>	<b>18</b>	<b>18</b>
<b>16</b>	9,20	1,62	5,68	16,40	2,58	6,36	12,20	2,45	4,98
<b>25</b>	14,40	3,92	3,67	19,20	3,83	5,01	12,20	2,79	4,37
<b>35</b>	12,20	4,76	2,56	15,00	4,98	3,01	12,20	2,96	4,12
<b>43</b>	7,75	3,40	2,28	13,80	5,95	2,32	9,70	4,00	2,43

Tamb: Ambient Temperature (°C). LWC: Leaving Water Condenser Temperature (°C). HC: Heating Capacity (kW). CC: Cooling Capacity (kW). IP: Power Input (kW)  
 This data is measured by Panasonic in accordance with EN14511-2 standard. This data is for reference purpose only, and does not guarantee the performance.

**Aquarea T-CAP Mono-bloc H Generation Single Phase / Three Phase. Heating and Cooling - MXC**

**WH-MXC09H3E5 / WH-MXC09H3E8**

Tamb	HC	IP	COP	HC	IP	COP	HC	IP	COP	HC	IP	COP	HC	IP	COP	HC	IP	COP
LWC	30	30	30	35	35	35	40	40	40	45	45	45	50	50	50	55	55	55
-15	9,00	3,24	2,78	9,00	3,51	2,56	9,00	3,91	2,30	9,00	4,30	2,09	9,00	4,73	1,90	9,00	5,16	1,74
-7	9,00	2,71	3,32	9,00	3,16	2,85	9,00	3,62	2,49	9,00	4,07	2,21	9,00	4,27	2,11	9,00	4,46	2,02
2	9,00	2,36	3,81	9,00	2,51	3,59	9,00	2,78	3,24	9,00	3,05	2,95	9,00	3,56	2,53	9,00	4,07	2,21
7	9,00	1,64	5,49	9,00	1,86	4,84	9,00	2,16	4,17	9,00	2,46	3,66	9,00	2,76	3,26	9,00	3,06	2,94
25	13,60	1,50	9,07	13,60	1,71	7,95	13,20	1,93	6,84	12,80	2,14	5,98	12,00	2,41	4,98	11,20	2,67	4,19

**WH-MXC12H6E5**

Tamb	HC	IP	COP	HC	IP	COP	HC	IP	COP	HC	IP	COP	HC	IP	COP	HC	IP	COP
LWC	30	30	30	35	35	35	40	40	40	45	45	45	50	50	50	55	55	55
-15	12,00	4,75	2,53	12,00	4,96	2,42	12,00	5,41	2,22	11,00	5,38	2,04	10,80	5,82	1,86	10,50	6,26	1,68
-7	12,00	3,85	3,12	12,00	4,41	2,72	12,00	4,98	2,41	12,00	5,54	2,17	12,00	5,90	2,03	12,00	6,26	1,92
2	12,00	3,19	3,76	12,00	3,49	3,44	12,00	3,87	3,10	12,00	4,25	2,82	12,00	4,86	2,47	12,00	5,47	2,19
7	12,00	2,18	5,50	12,00	2,53	4,74	12,00	2,96	4,05	12,00	3,39	3,54	12,00	3,78	3,17	12,00	4,16	2,88
25	13,60	1,55	8,77	13,60	1,76	7,73	13,40	2,10	6,38	13,20	2,43	5,43	12,60	2,66	4,74	12,00	2,89	4,15

**WH-MXC12H9E8**

Tamb	HC	IP	COP	HC	IP	COP	HC	IP	COP	HC	IP	COP	HC	IP	COP	HC	IP	COP
LWC	30	30	30	35	35	35	40	40	40	45	45	45	50	50	50	55	55	55
-15	12,00	4,75	2,53	12,00	4,96	2,42	12,00	5,41	2,22	12,00	5,86	2,05	11,80	6,24	1,89	11,60	6,62	1,75
-7	12,00	3,85	3,12	12,00	4,41	2,72	12,00	4,98	2,41	12,00	5,54	2,17	12,00	5,90	2,03	12,00	6,26	1,92
2	12,00	3,19	3,76	12,00	3,49	3,44	12,00	3,87	3,10	12,00	4,25	2,82	12,00	4,86	2,47	12,00	5,47	2,19
7	12,00	2,18	5,50	12,00	2,53	4,74	12,00	2,96	4,05	12,00	3,39	3,54	12,00	3,78	3,17	12,00	4,16	2,88
25	13,60	1,55	8,77	13,60	1,76	7,73	13,40	2,10	6,38	13,20	2,43	5,43	12,60	2,66	4,74	12,00	2,89	4,15

**WH-MXC16H9E8**

Tamb	HC	IP	COP	HC	IP	COP	HC	IP	COP	HC	IP	COP	HC	IP	COP	HC	IP	COP
LWC	30	30	30	35	35	35	40	40	40	45	45	45	50	50	50	55	55	55
-15	16,00	6,30	2,54	16,00	6,89	2,32	16,00	7,45	2,15	16,00	8,10	1,98	16,00	8,48	1,89	15,20	8,96	1,70
-7	16,00	5,85	2,74	16,00	6,42	2,49	16,00	7,00	2,29	16,00	7,57	2,11	16,00	8,10	1,98	16,00	8,62	1,86
2	16,00	4,67	3,43	16,00	5,21	3,07	16,00	5,74	2,79	16,00	6,31	2,54	16,00	6,90	2,32	16,00	7,50	2,13
7	16,00	3,35	4,78	16,00	3,74	4,28	16,00	4,30	3,72	16,00	4,80	3,33	16,00	5,43	2,95	16,00	5,91	2,71
16	16,00	2,59	6,18	16,00	3,18	5,03	16,00	3,71	4,31	16,00	4,27	3,75	16,00	4,86	3,29	16,00	5,22	3,07
25	16,00	2,02	7,92	16,00	2,58	6,20	16,00	2,91	5,50	16,00	3,36	4,76	16,00	3,74	4,28	16,00	4,00	4,00

**Aquarea T-CAP Mono-bloc H Generation Single Phase / Three Phase. Heating and Cooling - MXC**

Models	WH-MXC09H3E5									WH-MXC12H6E5								
Tamb	CC	IP	EER	CC	IP	EER	CC	IP	EER	CC	IP	EER	CC	IP	EER	CC	IP	EER
LWC	7	7	7	14	14	14	18	18	18	7	7	7	14	14	14	18	18	18
18	7,00	1,36	5,15	8,55	1,41	6,06	7,00	1,00	7,00	10,00	1,75	5,71	13,20	1,96	6,73	10,00	1,40	7,14
25	7,65	1,91	4,01	11,10	1,98	5,61	7,00	1,10	6,36	11,20	2,67	4,19	16,50	3,01	5,48	10,00	1,60	6,25
35	7,00	2,21	3,17	9,23	2,37	3,89	7,00	1,35	5,19	10,00	3,56	2,81	12,55	3,63	3,46	10,00	1,95	5,13
43	6,25	2,66	2,35	8,55	2,71	3,15	5,60	1,60	3,50	8,00	3,35	2,39	10,00	3,46	2,89	8,00	2,30	3,48
Models	WH-MXC09H3E8						WH-MXC12H9E8						WH-MXC16H9E8					
Tamb	CC	IP	EER	CC	IP	EER	CC	IP	EER	CC	IP	EER	CC	IP	EER	CC	IP	EER
LWC	7	7	7	18	18	18	7	7	7	18	18	18	7	7	7	18	18	18
18	7,00	1,36	5,15	—	—	—	7,50	1,41	5,32	—	—	—	8,50	1,70	5,00	10,00	1,70	5,88
25	7,65	1,91	4,01	—	—	—	8,90	2,16	4,12	—	—	—	14,00	4,00	3,50	14,00	2,94	4,76
35	7,00	2,21	3,17	—	—	—	10,00	3,56	2,81	—	—	—	12,20	4,76	2,56	12,20	3,50	3,49
43	6,25	2,66	2,35	—	—	—	8,00	3,01	2,66	—	—	—	7,10	3,31	2,15	9,80	3,31	2,96

Tamb: Ambient Temperature (°C). LWC: Leaving Water Condenser Temperature (°C). HC: Heating Capacity (kW). CC: Cooling Capacity (kW). IP: Power Input (kW)  
 This data is measured by Panasonic in accordance with EN14511-2 standard. This data is for reference purpose only, and does not guarantee the performance.





# EXAMPLES OF INSTALLATIONS

**Aquarea H Generation: Bivalent with buffer tank and mixing valve.**

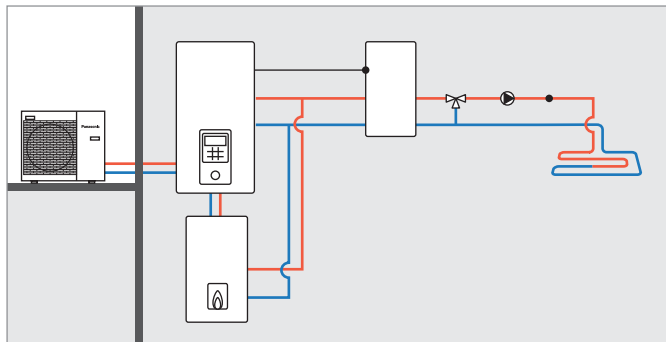

**Aquarea H Generation: Buffer tank with solar and mixing valve.**

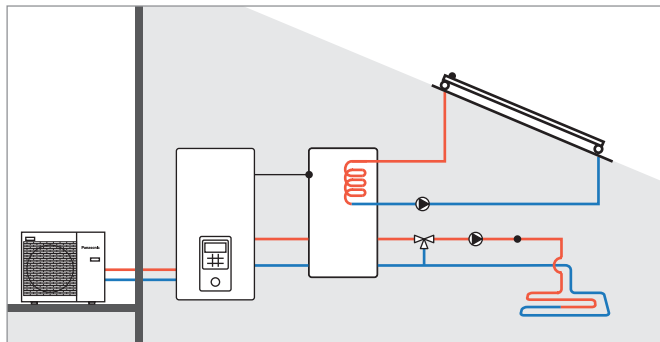

**Aquarea H Generation: 2 zones with external kit without buffer tank.**

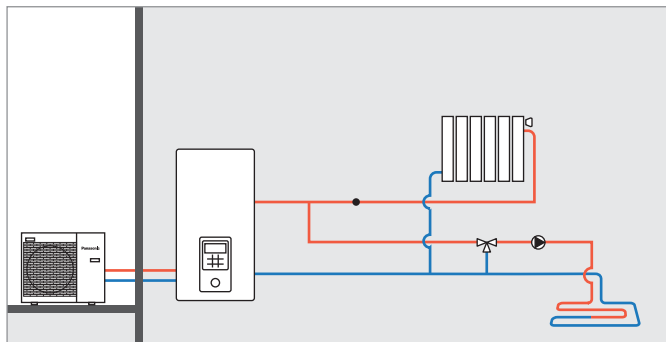

**Aquarea H Generation: 2 zones with external kit, buffer tank and swimming pool.**

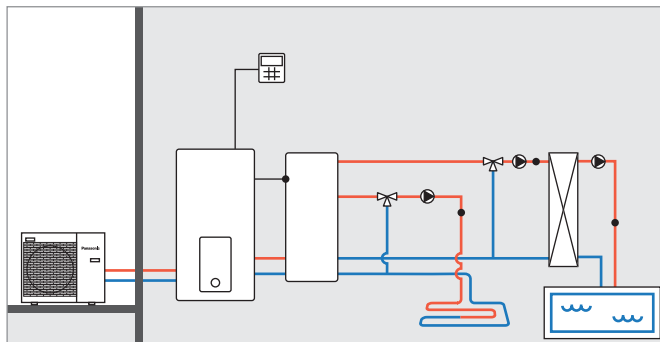

**Aquarea All in One H Generation: 2 zones with external kit, without buffer tank.**

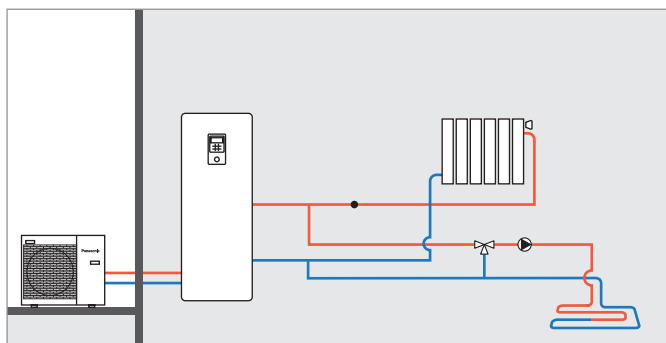

**Aquarea All in One 2 zones H Generation: 2 zones built-in, without buffer tank.**

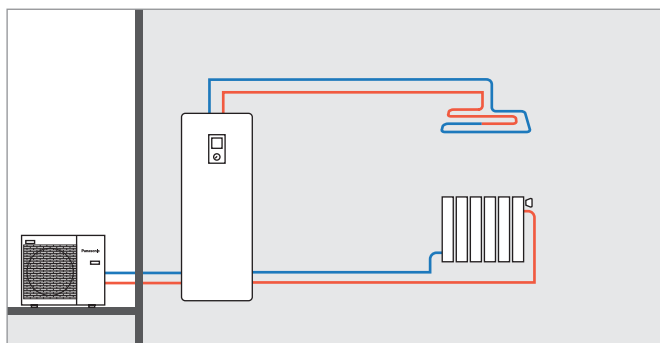

# WELCOME TO DOMESTIC RANGE



Go green. Go clean. Go your way.

Panasonic Air Conditioners are designed to provide more than just comfort cooling to homes. They save energy. They purify your surroundings. They adjust cooling power to suit your living spaces and styles. Living an eco-lifestyle your way is now easier than ever.

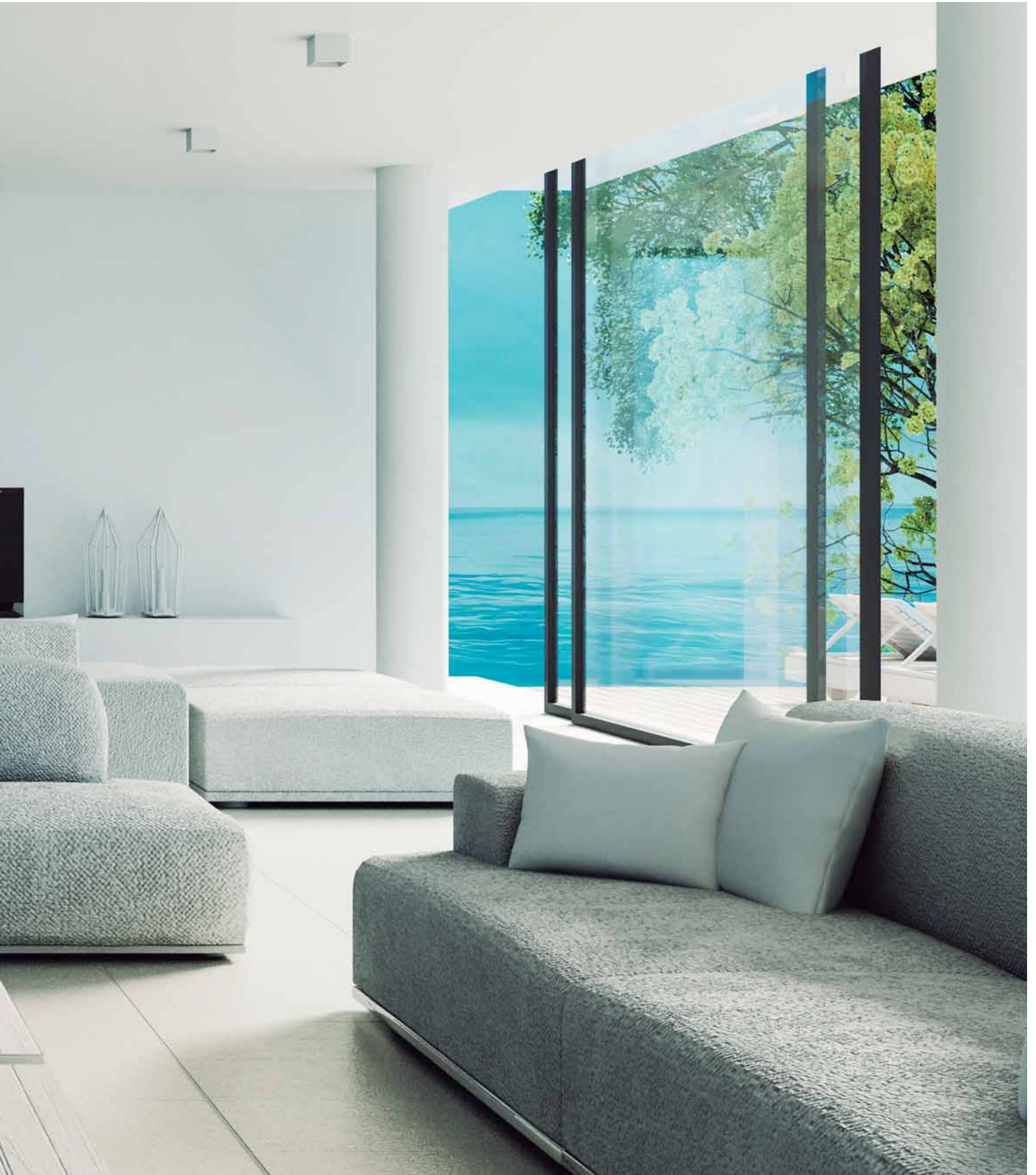

# HIGHLIGHTED FEATURES



Panasonic has developed a range of products designed for you, better than ever before.

With its innovative design, high efficiency and advanced purification system, the Etherea range has been designed with your clients in mind.

Panasonic air conditioners provide more savings and more comfort

We believe that going green shouldn't compromise on comfort. That's why Panasonic is introducing the Econavi system; combining human sensor and control program technology to detect and reduce waste of energy by 38%.

Our super silent air conditioners guarantee the purified air to take care of

you and your family. And, for a cleaner living environment, the nanoe™ helps purify the air as well as your surroundings. Together, these breakthrough technologies define what Panasonic's Eco Clean Life Innovation is all about – innovations that improve our environment while making life as comfortable as possible.

Energy saving

Icon: 38% ECONAVI

Intelligent Human Activity Sensor and Sunlight Sensor technologies that can detect and reduce waste of energy by optimising air conditioner according to room conditions. With just one touch of a button, you can save energy.

Icon: A+++ 10,50 SEER

Exceptional Seasonal Cooling Efficiency based on the ErP regulation. Higher SEER ratings mean greater efficiency. Save all the year while cooling!

Icon: A+++ 6,20 SCOP

Exceptional Seasonal Heating Efficiency based on the ErP regulation. Higher SCOP ratings mean greater efficiency. Save all the year while heating!

Icon: INVERTER+

Inverter Plus System classification highlight the Panasonic highest performing systems

Icon: R2 ROTARY COMPRESSOR

Panasonic R2 Rotary Compressor. Designed to withstand extreme conditions, it delivers high performance and efficiency.

Icon: R32 NEW REFRIGERANT GAS

Our heat pumps containing the refrigerant R32 show a drastic reduction in the value of Global Warming Potential (GWP). An important step to reduce greenhouse gases. R32 is also a components refrigerant, making it easy to recycle.

High performance and healthy air

Icon: 99% nanoe

nanoe™ utilises nano-technology fine particles to purify the air in the room. It works effectively on airborne and adhesive micro-organisms such as certain types of bacteria, viruses and mould.

Icon: PM2,5 FILTER

Particulate matter (PM2,5) can be found suspended in the air, including dust, dirt, smoke and liquid droplets. This filter can catch PM2,5 particles including hazardous pollutants as well as house dust and pollen.

Icon: 19dB(A) SUPER QUIET

With Super Quiet technology our devices are much more quiet than a library (30dB(A)).

Icon: HUMIDITY CONTROL MILD DRY

The Perfect Humidity Air controls the humidity level in the air to prevent over-dryness.

Icon: AEROWINGS

More comfort with Aerowings. Direct airflow to ceiling to create shower cooling effect by twin flap built in indoor.

Icon: -10°C COOLING MODE

Down to -10°C in cooling only mode. The air conditioner works in cooling only mode with an outdoor temperature of -10°C.

Icon: -15°C HEATING MODE

Down to -15°C in heating mode. The air conditioner works in heat pump mode with an outdoor temperature is as low as -15°C.

Icon: SUMMER HOUSE

Summer House, this innovative function keeps the house at 8/10 or 8/15°C to avoid freezing pipes during the winter. This function is highly appreciated in summer house or week end houses.

Icon: R22 R410A R22 RENEWAL

The Panasonic renewal system allows good quality existing R22 pipe work to be re-used whilst installing new high efficiency R410A systems.

Icon: R410A R22 R32 R410A/R22 RENEWAL

The Panasonic renewal system allows good quality existing R410A or R22 pipe work to be re-used whilst installing new high efficiency R32 systems.

Icon: 5 YEARS COMPRESSOR WARRANTY

5 Years Warranty. We guarantee the outdoor unit compressors in the entire range for five years.

High connectivity

Icon: INTEGRATION P LINK

Domestic integration to P Link - CZ-CAPRA1. Can connect all ranges to P Link. Full control is now possible.

Icon: INTERNET CONTROL

Internet Control is a next generation system providing a user-friendly remote controller of air conditioning or heat pump units from everywhere, using a simple Android or iOS smartphone, tablet or PC via internet.

Icon: BMS CONNECTIVITY

The communication port is integrated into the indoor unit and provides easy connection to, and control of, your Panasonic heat pump to your home or building management system.

# R32 REFRIGERANT GAS



**A 'small' change that changes everything**

Not everyone is ready for change. Indeed, there are some who resist the future. But at Panasonic we will keep believing in technologies that improve people's lives. Which is why we are now presenting a generation of air conditioners with R32, an innovative refrigerant in all ways imaginable: it is easy to install, and compared to most other refrigerants it has a much lower environmental impact and saves energy. The result? Greater wellbeing for people and for the planet. Because there will always be people who resist change. But we say: Goodbye yesterday. Hello R32.

**Today Panasonic. Tomorrow everyone.**

European regulation EU 517/2014 makes the replacement of fluorinated gases (F-gases) compulsory, such as R410A, for environmental reasons,

although it also grants a transition period from 2017 to 2030. Must we wait? No. Our commitment to innovation is not hampered by dates. Which is why we are jumping the gun and are now presenting our generation of air conditioners that employ the R32 refrigerant.

**HCFC phase-down schedule.**

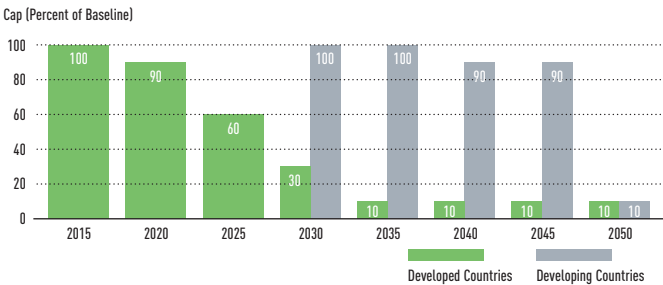

\* By replacing R22 with R32 we are significantly reducing the ozone depletion potential of our air conditioners. The use of air conditioning is rapidly increasing in developing countries thus making it increasingly necessary to use refrigerants with low global warming potential.

**Goodbye yesterday**

The generation of air conditioners with R32 represents innovation in every way. Shall we list them?

**1. Installation innovation.**

- Extremely easy to install, practically the same as R410A. (Just remember to verify that the pressure gauge and vacuum pump are compatible with the R32)
- This refrigerant is 100% pure, which makes it easier to recycle and reuse

**2. Environmental innovation.**

- Zero impact on the ozone layer
- 75% less impact on global warming vs R410A

	R410A	R32
Composition	Blend of 50% R32 + 50% R125	100% R32. (No blend)
GWP (Global Warming Potential)	2087,5	675
ODP (Ozone Depletion Potential)	0	0

R32 is a refrigerant with just one-third the global warming potential of R410A, meaning less risk of damage to the environment.

**3. Economic and energy consumption innovation.**

- Lower cost and greater savings:
  - 30% less refrigerant
- Higher energy efficiency than R410A

LCCP: Life Cycle Climate Performance (lower global warming impact). Safety: Low toxicity level.

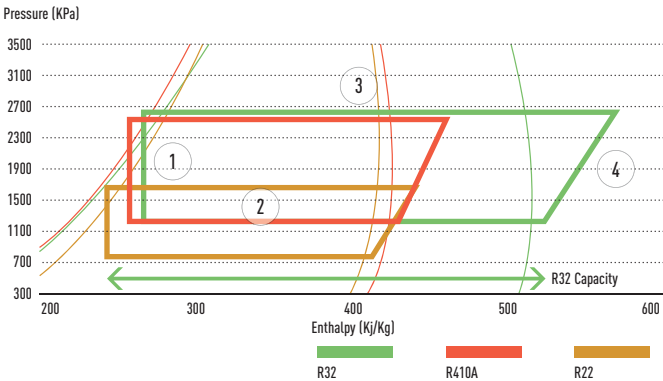

1. Expansion. 2. Evaporization. 3. Condensation. 4. Compression.

**100 Year global warming potential of different refrigerants.**

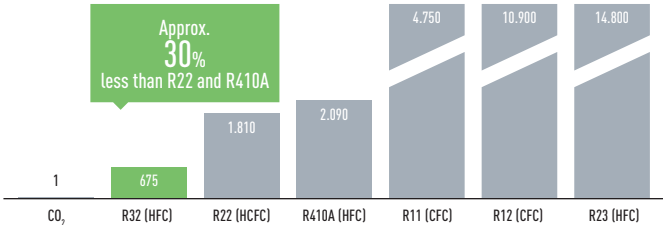

IPCC Fourth Assessment Report. Values for 100 years warming potential.

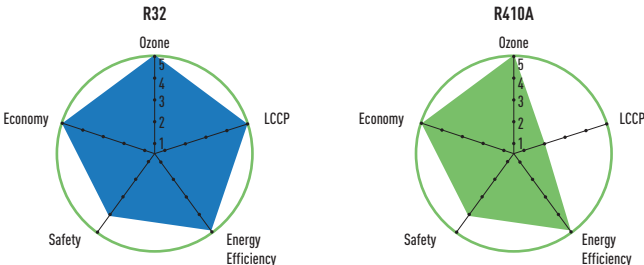

# ETHEREA STYLISH AND OUTSTANDING FEATURES



The iF Product Design Awards are among the most prestigious awards for product design excellence. Winning the award thanks to its highly intelligent functionality, the Panasonic Ethera is the ideal air-conditioning system for domestic and commercial applications.





Etherea with Econavi intelligent sensor and nanoe™ air-purifying system: outstanding efficiency A+++, comfort (Super Quiet technology only 19dB(A)) and healthy air combined with a breakthrough design.

Etherea. Perfect outside, perfect inside

The Etherea has an astonishingly slim design.

A breakthrough design that combines perfectly with the most modern environments. We have selected the best materials and processes for a refined design. And now they're available in an elegant metallic or matt silver and matt or gloss white.



Discover how to achieve energy savings with the Etherea A+++.

Econavi Sensor technology reduces the waste of energy by adjusting the operation of the air conditioner to suit the requirements of the room. With just one touch of a button, you can save energy efficiently with uninterrupted cooling, comfort and convenience.

Get the best for your health with Etherea and nanoe™.

Using nanoe™ with nano-technology, nano-sized electrostatic atomised water particles purify the air in the room. It works effectively on airborne and adhesive micro-organisms such as certain types of bacteria, viruses and mould thus ensuring a cleaner living environment.

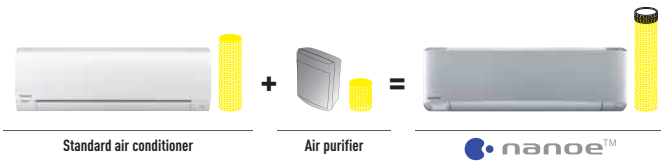

Etherea and Heatcharge performance: highest energy class

Etherea and Heatcharge. Economical, environment-friendly operation high SCOP (Seasonal Coefficient of Performance). Original Panasonic Inverter technology and a high performance compressor provide top-class operating efficiency. This lets you enjoy lower electricity bills while contributing to environmental protection.



Outstanding savings for your home

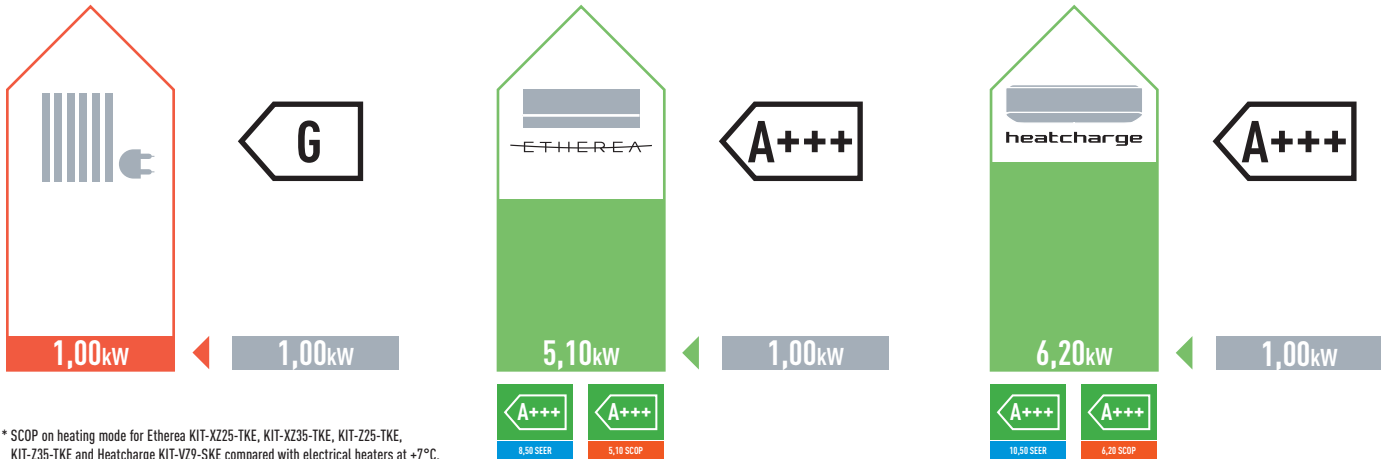

\* SCOP on heating mode for Etherea KIT-XZ25-TKE, KIT-XZ35-TKE, KIT-Z25-TKE, KIT-Z35-TKE and Heatcharge KIT-VZ9-SKE compared with electrical heaters at +7°C.

# NANO-SIZED ELECTROSTATIC ATOMIZED WATER PARTICLES, NANO<sup>e</sup>™, THAT IMPROVE AIR QUALITY

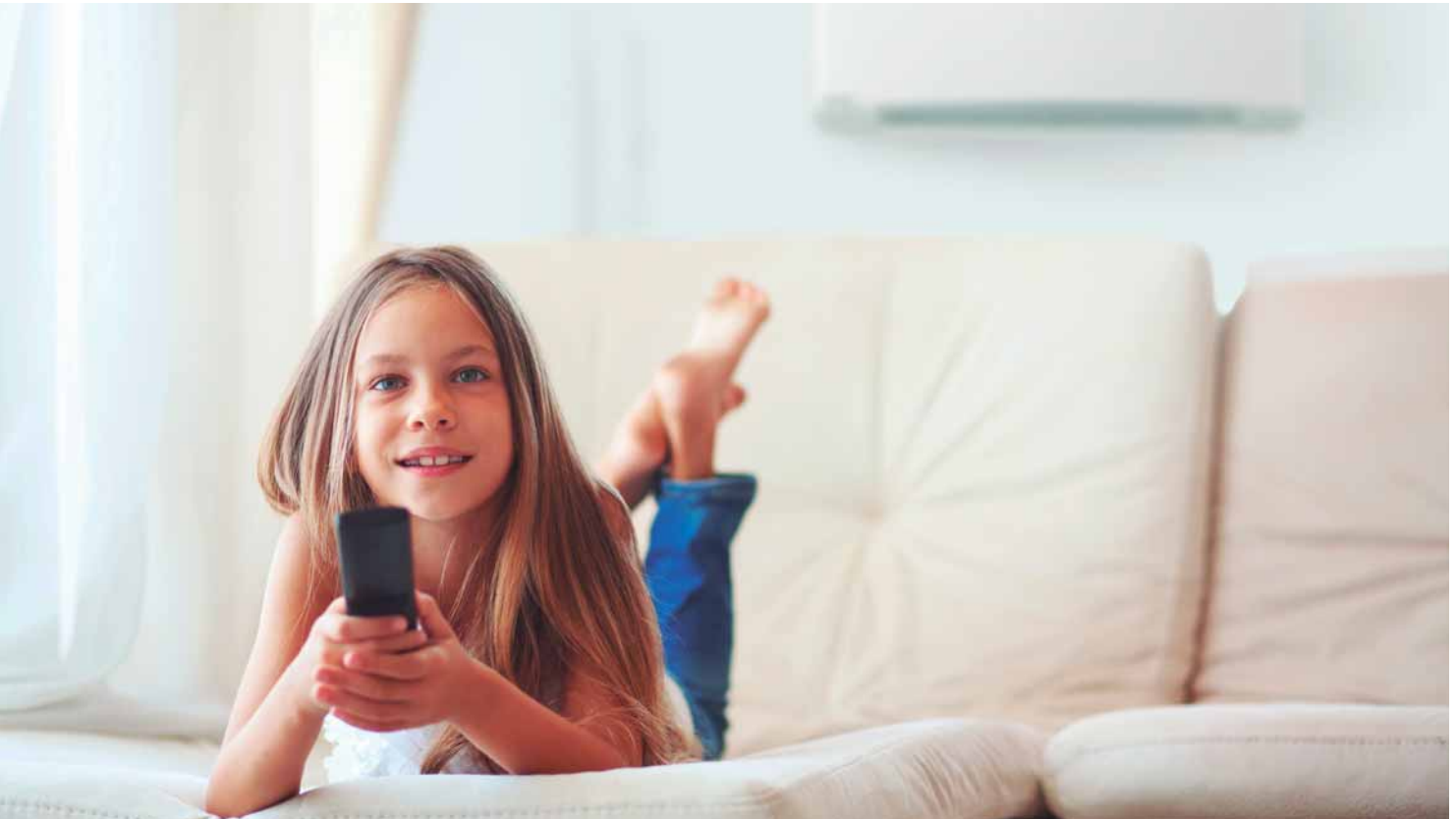

The world is focusing its attention on this breakthrough technology that could be the key to the air purification.

**VIRUS  
BACTERIA  
POLLEN  
INHIBITION**

**Airborne**  
Inhibit 99,9% of certain types of bacteria and viruses in the air.

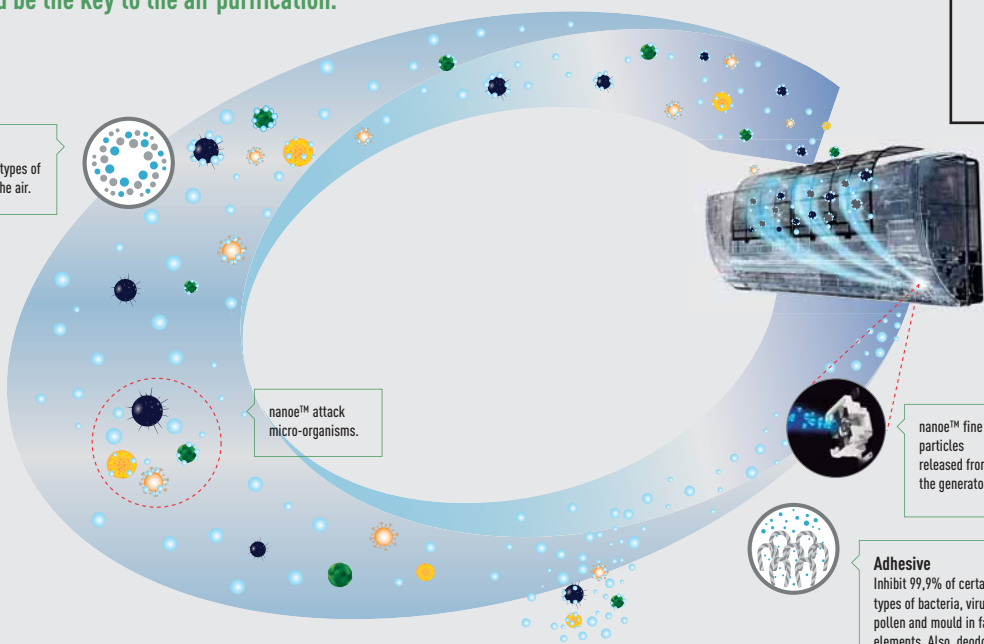

nanoe™ attack micro-organisms.

nanoe™ fine particles released from the generator.

**Adhesive**  
Inhibit 99,9% of certain types of bacteria, viruses, pollen and mould in fabric elements. Also, deodorize odour inside.

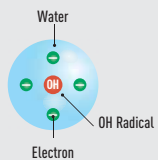

nanoe™ is nano-sized electrostatic atomized water particles with plentiful OH radicals. Its effectiveness of bacteria inhibition depends on the number of OH radical, which is generated at the rate of 480 billion per second.



Proven benefits of electrostatic atomized water particles, nanoe™, through experiments. The benefits range widely from helping to inhibit certain viruses, bacteria, mould and allergens, but also moisturizing skin. Experiments by universities and research institutions have proven the effects of nanoe™.

Characteristics of nanoe™ Technology

1. Long Life. 6 times longer lifespan than general negative ion. nanoe™ contains moisture around 1000 times more than general negative ion. Being contained in water particles, it has a longer lifespan and is able to spread for a long distance.

Comparison of distribution in the room



nanoe™ spreads to every corner.

General negative ion Ions decay before spreading throughout the room.

2. Water-originated. nanoe™ comes from condensed moisture in the air so that water replenishment for nanoe™ generation is not required.

nanoe™ is tiny enough to penetrate into clothes for inhibiting mould and deodorizing

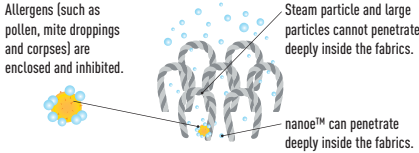

3. Microscopic Scale. With the size of one-billionth of a meter, nanoe™ is much smaller than steam. It can deeply penetrate into cloth fabrics to deodorize.

\* 1nm (nanometer) = one billionth of meter.

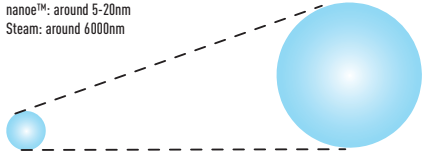

How does nanoe™ technology help you?

1. Virus / Bacteria / Pollen inhibition. Inhibits certain virus. Influenza virus 99,9% inhibited.

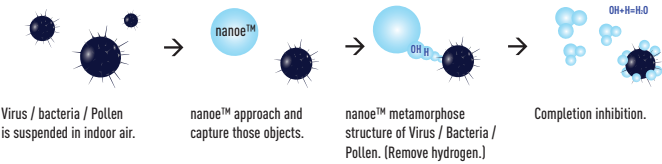

The effectiveness of nanoe™

Table with 5 columns: Tested contents, Result (deactivate), Testing condition (Size, Time), Tested laboratory / company, Report doc No. Rows include Airborne Virus/Bacteria and Adhesive Virus/Bacteria/Tobacco odour/Cedar pollen.

2. Deodorization. Deodorization effect works with the smell adhered at objects like sofa and curtains. Reduce 90% Odour (tobacco smell) after 120 minutes.

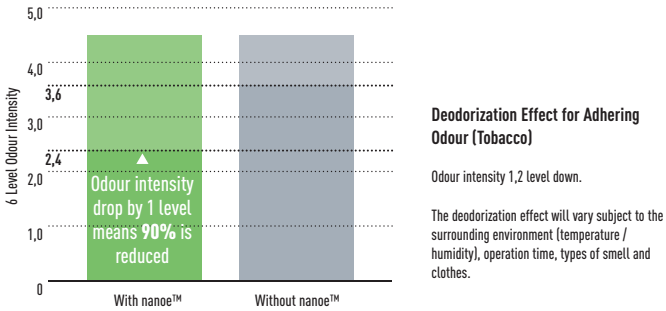

- Test Laboratory: Panasonic Corporation Analysis Center. - Test Methodology: Verifying with 6-level odour intensity indication in 10m² test room. - Deodorization Method: nanoe™ emit. - Test Subject: Adhering Tobacco Smell. - Test Result: 1,2 level of odour intensity is decreased after 120 minutes. - Report No.: BAA33-130125-D01.

3. Moisturing Skin. Helps retain the moisture of the skin.

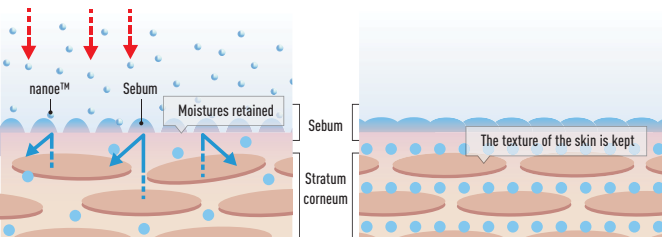

With nanoe™ nanoe™ hydrate the sebum on the skin to prevent the loss of moistures.

After 28 days Skin is hydrated that nanoe™ keeps the texture of the skin.

Test Laboratory: FCG Research Institute Inc. Report no. 19104

Reliable technology chosen by the world. The cutting edge technology of Panasonic's nanoe™ purifying technology has been chosen by Lexus to equip its vehicles for clean indoor air.



# ECONAVI INTELLIGENT SENSORS. DISCOVER HOW TO ACHIEVE ENERGY SAVINGS





Econavi detects and reduces this waste of energy in all the right ways. Using high-tech sensors and precise control programs, it analyses room conditions and adjusts cooling power accordingly. Econavi is smart enough to locate and operate in all the right places to give you more comfort and better energy savings.

**5 Features saving energy all at once: Econavi with intelligent eco sensors**

Intelligent Sensors detect potential waste of energy using the Human Activity Sensor and Sunlight Sensor. It is able to monitor human location, movements, absence and sunlight intensity. It then automatically adjusts cooling power to save energy efficiently with uninterrupted heating and cooling comfort and convenience.

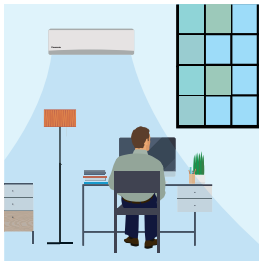

**Temperature Wave**  
Rhythmic temperature-controlled pattern to save energy without sacrificing comfort.

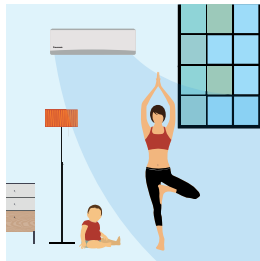

**Area Search**  
Directs airflow to wherever you are in the room. Econavi detects changes in human movements and reduces the waste of cooling the unoccupied area of the room.

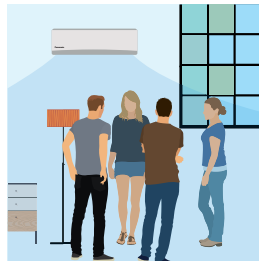

**Activity Detection**  
Adapts cooling power to your daily activities. Econavi detects changes in activity levels and reduces the waste of cooling with unnecessary power.



**Absence Detection**  
Reduces cooling power when you are not around. Econavi detects human absence in the room and reduces the waste of cooling an empty room.



**Sunlight Detection**  
Adjusts cooling power to changes in sunlight intensity.

**Econavi sunlight sensor**

**Sunlight Detection (on Cooling and Heating Mode).**

Econavi detects changes in sunlight intensity in the room and judges whether it is sunny or cloudy/night. It reduces waste of energy by reducing cooling under less sunny conditions on the cooling mode or reducing heating operation under more sunnier conditions on the heating mode.

**Sunlight detection (on cooling mode)**

**Sunny**

Econavi is switched on when it is sunny.

**Detect**

Econavi detects less cooling power is required.

**Reduce waste of energy**

Reduces cooling power by an amount equivalent to increasing the set temperature by 1°C.

**Sunlight detection (on heating mode)**

**Cloudy/Night**

Econavi is switched on when it is cloudy/night.

**Detect**

Econavi detects less heating power is required.

**Reduce waste of energy**

Reduces heating power by an amount equivalent to decreasing the set temperature by 1°C.

**Temperature wave**

**Rhythmic temperature-controlled pattern to save energy without sacrificing comfort.**

Econavi with Temperature Wave was developed based on an understanding of Thermal Physiology; the human body adapts physiologically to changes in temperature. Taking advantage of this understanding, Panasonic's R&D Centre has developed the Rhythmic Temperature Control pattern, which offsets the air conditioner's performance against thermal physiological responses.

Hence, when Econavi detects human presence and low activity level, Temperature Wave adapts to this rhythmic temperature control to realise further energy savings without sacrificing comfort.

**How does temperature wave works?**

**When Econavi detects low activity**

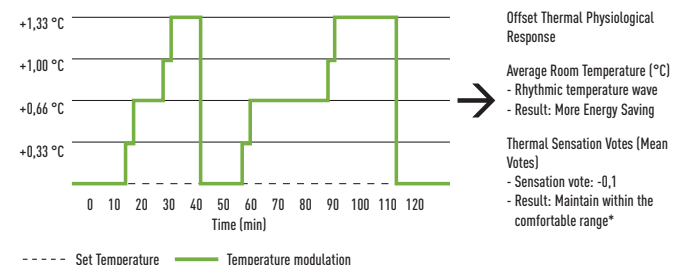

The result of the experiment showed that thermal sensation was maintained within the comfortable range\* even though average set temperature was moderately increased. Hence, when Econavi detects human presence and low activity level, Temperature Wave adapts to this rhythmic temperature control to realise further energy saving without sacrificing comfort.

\* The thermal condition of which PMV (Predicted Mean Value) is within -0.5 to +0.5 is recommended as comfortable condition (in the condition B) by International Standard EN ISO 7730.



So much saved with so little effort  
Up to 38%\* energy savings for Inverter cooling model with temperature wave.

# PANASONIC R2 ROTARY COMPRESSOR



R2 rotary compressors utilize rolling piston technology. The R2 compressor has been tested in extreme conditions: higher efficiency, single and dual piston, R32 / R410A refrigerant, compact size.

## Making the world a cooler place since 1978

Panasonic Rotary Compressors for Room Air Conditioners have been installed in the most demanding environments around the world. Designed to withstand extreme conditions, Panasonic Rotary delivers high performance, efficiency and reliable service, no matter where you are. Panasonic, the world's largest manufacturer of rotary compressors.

## R2 Compressor Value

### About R2 Compressor.

Built upon 36 years of compressor design and production experience, R2 is the next generation of Rotary Compressors for residential central air conditioning. The technology improvements, enhanced materials and simple design ensure R2 compressors are reliable, efficient and quiet. The R2 Compressor delivers quality, comfort and peace of mind in homes around the world.

Panasonic's Rotary Compressors have been life tested in some of the world's most demanding environments. Proven for years many of the most demanding areas of the world, the R2 design is the compressor of choice by contractors and homeowners in these challenging climates. For the high performance that homeowners demand, R2 Rotary Compressors are considered by the industry experts.

## Why is the Panasonic R2 Rotary Compressor so efficient?

1. High efficiency motor. The premium silicon steel motor meets industry efficiency requirements.
2. Improved lubrication of high volume oil pump. The extended, high volume oil pump in conjunction with a larger capacity oil reservoir provides superior lubrication.
3. Accumulator has larger refrigerant capacity. The larger accumulator accommodates generous refrigerant amounts needed in longer line length installations.

### Leading Technology.

Used in over 80% of cooling solutions globally, rotary is the world's dominant residential air conditioning compression technology. Panasonic is the leading rotary and residential AC compressor manufacturer in the world, with over 200 million compressors produced.

### Benefits.

Central air conditioning delivered with a Panasonic R2 Rotary Compressor ensures a superior level of comfort at an economical cost.

The secret is flexibility. Panasonic Inverter air conditioners have the flexibility to vary the rotation speed of the compressor. This allows it to use less energy to maintain the set temperature while also being able to cool the room quicker at start up. So you can enjoy better savings on your electricity bills while maintaining cooling comfort.

**Inverter technology**

**Great energy-saving performance. Reduces electricity consumption.**

Panasonic Inverter air conditioners are designed to give you exceptional energy savings and performance. At the start up of an air conditioner's operation, a boost in power is required to reach the set temperature. After the set temperature is reached, less power is required to maintain it. The Panasonic Inverter air conditioner varies the rotation speed of the compressor. This provides a highly precise method of maintaining the set temperature.

**Constant Comfort.**

Precise temperature control with a wide power output range enables an inverter air conditioner to meet different room occupancy levels – thus ensuring constant comfort.

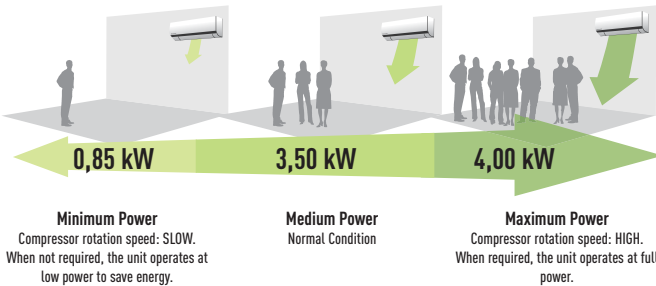

Graph shows the 1,5HP Inverter model's wide power output range during cooling. / Graph shows the 1,5HP Inverter model's wide power output range during cooling.

**Quick Comfort.**

Panasonic Inverter air conditioners can operate with higher power during the start up period to cool the room 1,5 times faster and heat the room 4 times faster than non-Inverter models.

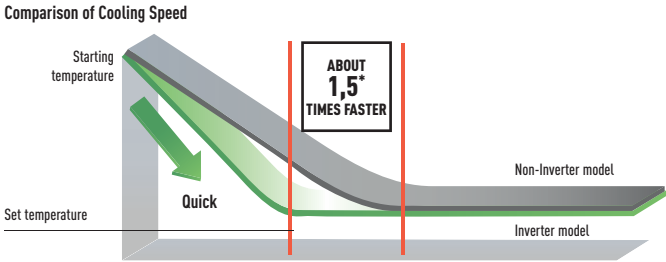

\* 1,5HP Inverter vs. non-Inverter. Outside room temperature: 35°C; setting temperature: 25°C

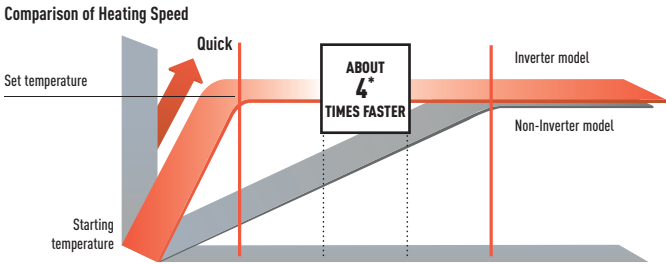

\* Comparison of 1,0HP Inverter and Non-Inverter. Outside room temperature: 2°C; Setting temperature: 25°C

**Silent ambient and relaxing atmosphere 18 dB(A)**

We have succeeded in making one of the most silent air conditioners on the market. Panasonic Inverter air conditioner's indoor operating noise has been reduced as the Inverter constantly varies its output power to enable more precise temperature control.

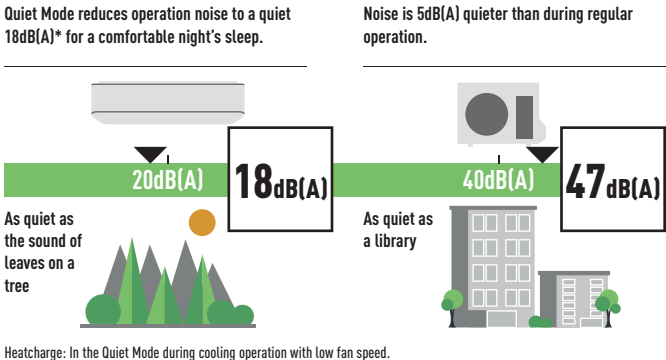

**Mild Dry Cooling**

Mild dry cooling maintains a higher level of relative humidity of up to 10% compared to regular cooling operation. This helps to reduce skin dryness - and a dry throat.

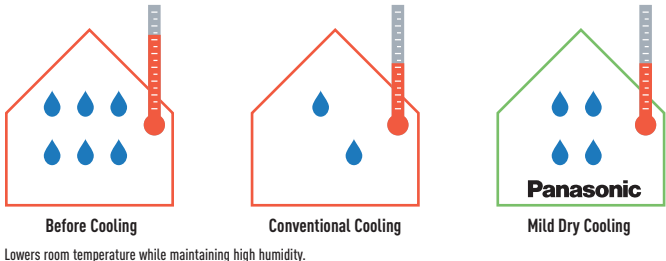

# WALL MOUNTED TZ/TE COMPACT STYLE





TZ/TE compact indoor size.  
The TZ/TE indoor units have compact size. With 799mm of width, you can put the air conditioner on the top of the door.

**TZ Inverter models powerful and efficient**

**Heating power and efficiency.**

- R32 gas is more environmentally friendly than R410A
- Complete line-up of standard Inverter models
- Super Quiet! Only 20dB(A)
- High energy savings
- Long connection distance (from 15m up to 30m)
- Wired Controller (optional)

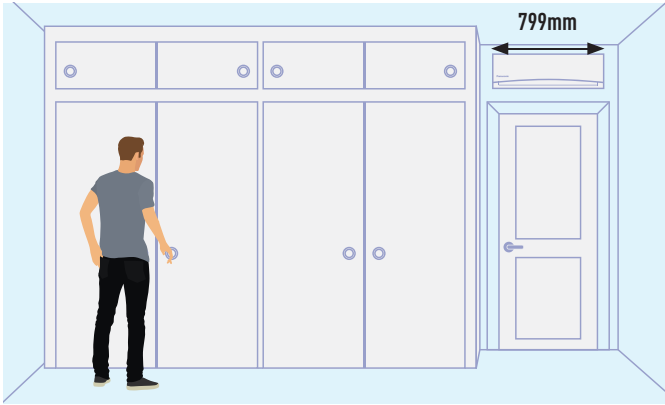

**PM2,5 Filter**

PM2,5 Filter. Particulate matter (PM2,5) can be found suspended in the air, including dust, dirt, smoke and liquid droplets. This filter can catch PM2,5 particles including hazardous pollutants as well as house dust and pollen. It is able maintain clean the air of the room by deodorization too.

**Aerowings**

Panasonic's Aerowings feature incorporates two independent blades that concentrate airflow to cool you down in the shortest time possible. This also helps distribute cool air evenly throughout the room.

**Superior airflow control. Indirect airflow after reaching set temperature.**

Aerowings features two independent blades that give you more control over the direction of the airflow. Without Aerowings, with direct airflow, the target never changes, so you can easily begin to feel too cold as you are subjected to the continuous icy blast.

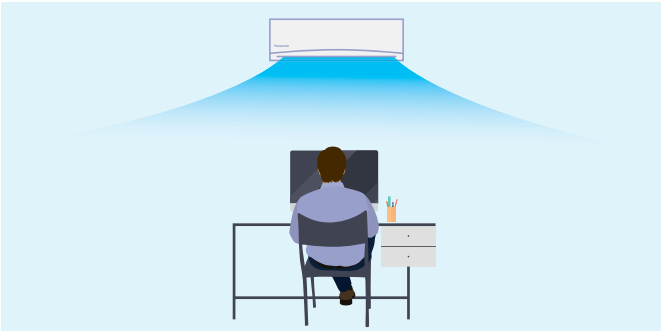

**Comfort that goes on and on with Shower Cooling.**

After reaching a set temperature, the Aerowings twin blades direct air towards the ceiling to create the Shower Cooling effect. Then, the Human Activity Sensor detects the level of activity and adjusts the temperature to keep you comfortable.

**Panasonic Air Conditioners with Aerowings feature an indoor design with wider intake grille and super-high fan speed to produce bigger air volume.**

**For Shower Cooling.**

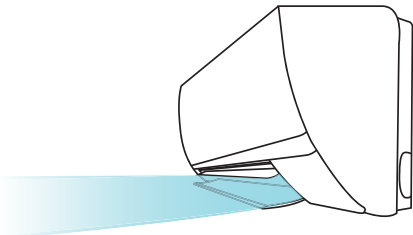

This ensures cool air is evenly distributed throughout the room and you can stay comfortable without experiencing continuous direct cooling.

# HEATCHARGE. ENERGY CHARGE SYSTEM



**Heating power and efficiency**

- Energy Charge System. Heat storage unit which features Non-Stop heating and fast heating function
- Higher efficiency and comfort with Econavi sunlight detection and human activity detection
- nanoE™ air purifying system
- More powerful airflow to quickly reach the desired temperature

**Panasonic's full line-up of A+++ heat pumps.**

In response to the Kyoto Protocol, the European Union set some challenging targets for the reduction in greenhouse-gas emissions. By the year 2020, across the member states, the EU wants to have achieved the following objectives:

- A 20% cut in greenhouse gas emissions (from 1990 base levels)
- The share of renewables in the energy mix to increase by 20%
- An overall reduction of 20% in energy consumption

**Powerful, reliable heating even at low ambient winter temperatures**

When the air conditioner is operating, the compressor, which is the power source of the unit, generates heat. Until now, this heat was released into the atmosphere. Panasonic focused on this waste heat! Heatcharge is a unique, innovative Panasonic technology that stores this waste heat in the compressor and effectively uses it as heating energy. This lets you enjoy a new level of air conditioner heating power and efficiency.

**Constant heating.**

Using stored heat provides stable heating with less drop in temperature. Even when heating operation stops during defrost operation, stored heat continues to constantly warm the room. This eliminates the previous discomfort due to the temperature dropping when heating temporarily stops to ensure stable air conditioner heating.

**Conventional.** The room gradually becomes cold.  
Defrost operation: About 11 to 15 min. Fall in room temperature: About 5 to 6 °C

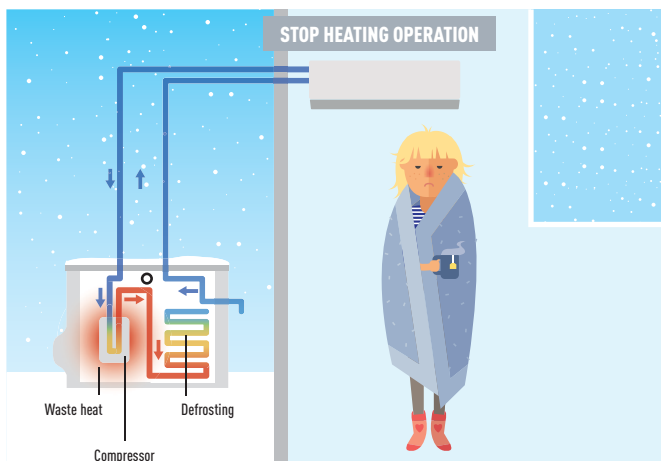

**Heatcharge.** The room is thoroughly warmed.  
Defrost operation: About 5 to 6 min. Fall in room temperature: About 1 to 2 °C

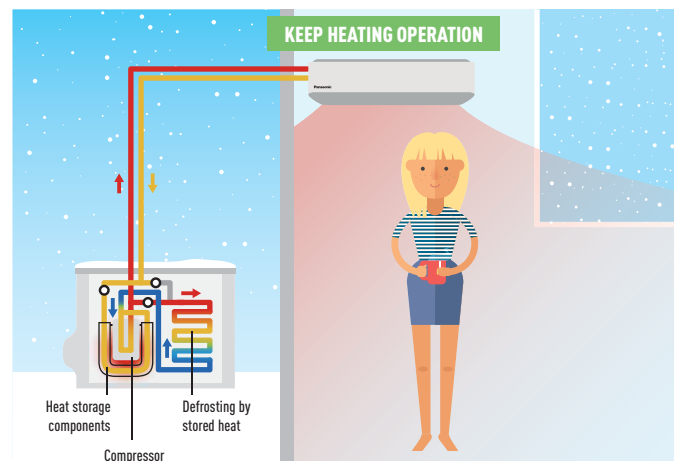

\* Defrost operation time and how low room temperature falls differ depending on the environment in which the unit is being used (how insulated and airtight and room is), operation conditions, and temperature conditions.  
\* Output air temperature falls during defrost operation. How low room temperature falls differs depending on the environment in which the unit is being used (how insulated and airtight and room is), operation conditions, and temperature conditions.  
\* In environments where a lot of frost accumulates, heating may stop during defrost operation.

**Conventional.**  
During operation, heat is generated inside the compressor.

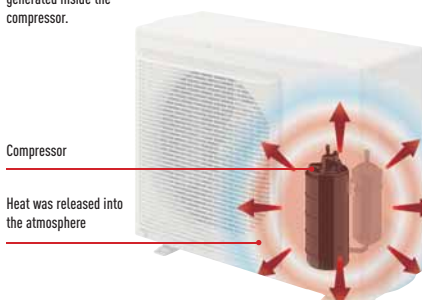

**Heatcharge.**  
Heat generated by the compressor is stored inside and used to warm the refrigerant to efficiently increase heating power.

Waste heat is "charged" and used effectively



**Heatcharge.**  
The compressor is wrapped and exhaust heat is used for charging.

Heatcharge tank  
Waste heat from the compressor is stored.

Finless heat exchanger  
Stored heat is converted to energy.

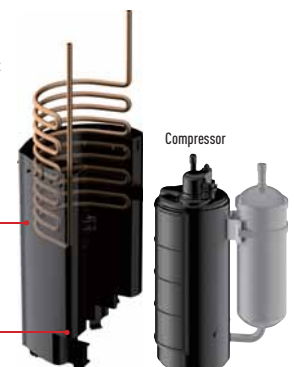

# R22 RENEWAL. PANASONIC STANDARD UNITS CAN BE INSTALLED ON EXISTING R22 PIPINGS

Change your old air conditioning system to a more efficient system!

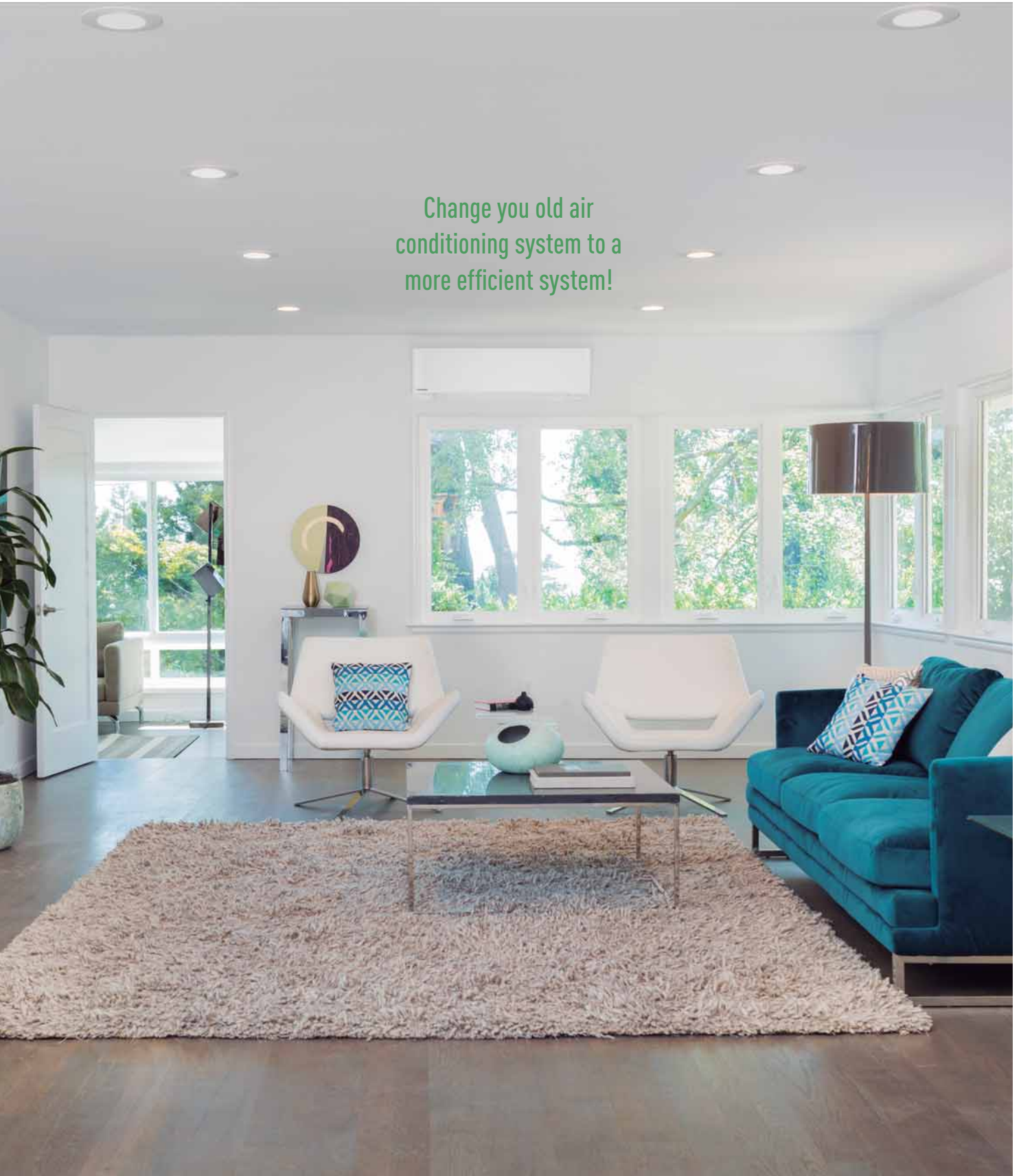

**An important drive to further reduce the potential damage to our ozone**

- All Panasonic standard SKE, TKE and UKE units can be install on existing R22 pipings
- No need of additional accessories (only pipe reduces)
- Approximately 30% energy saving compared to R22 units

**Panasonic is doing its part**

We at Panasonic are also doing our part – recognising that all finances are under pressure at the moment. Panasonic has developed a clean and cost effective solution to enable this latest legislation to be introduced with as minimum an effect on businesses and cash reserves as possible.

The Panasonic renewal system allows good quality existing R22 pipe work to be re-used whilst installing new high efficiency R410A / R32 systems.

By bringing a simple solution to the problem Panasonic can renew all Split Systems and PACi systems; and depending upon certain restrictions we don't even limit the manufacturer's equipment we are replacing.

By installing a new high efficiency Panasonic R410A / R32 system you can benefit from around 30% running cost saving compared to the R22 system.

Yes...

1. Check the capacity of the system you wish to replace
  2. Select from the Panasonic range the best system to replace it with
  3. Follow the procedure detailed in the brochure and technical data
- Simple...

R22 - The reduction of Chlorine critical for a cleaner future.

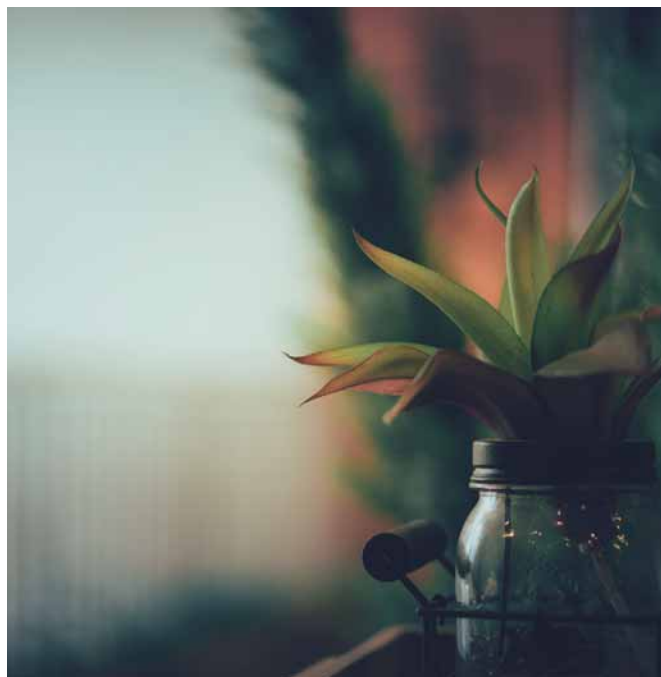

**Guidance on re-using of existing R22 piping for a new R410A / R32 installation**

**1. Precaution.**

The existing R22 piping can be re-used for a R410A / R32 system installation if the following conditions are met and the piping are finally verified to be:

- Dry (no moisture remained in the piping)
- Clean (no dust remained in the piping)
- Tight (no refrigerant leak at the joining and piping)

**2. Conditions.**

- Recover the refrigerant and oil.
- Operate "force cooling" according to the recommended operation time, regardless of the piping length.
- Single split: 10min.
- Multi split: 30min.
- After that, carry out "pump down" to recover the refrigerant and oil from the existing R22 system

\* Note: If pump down operation is not possible due to the malfunction of the system, flush and wash the existing piping to collect back the oil and dirt inside the system.

- Check the oil condition.
- If the oil contains dirt, wash the existing pipes
- Check the oil colour.
- After pump down, use a cotton bud to wipe the oil from the existing pipe.
- If the oil colour is higher than ASTM3, use a new pipe as re-use of old piping is not allowed
- Check pipe thickness.
- Make sure that the pipe thickness is more than 0,8mm.
- If the thickness is less than 0,8mm, use a new pipe
- Rework the flare for R410A / R32 connection.
- Do not reuse the old flare nuts.

**Deterioration Criteria for Refrigerant Oil**

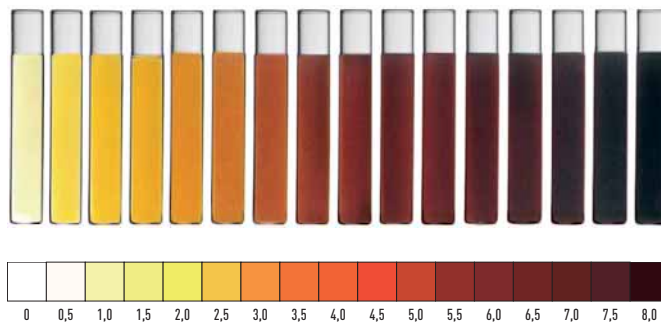

Make sure to use the new flare nuts attached to the R410A / R32 system

\* Note: If the existing piping size is 1/4" (6,35mm) and 1/2" (12,7mm), and the new R410A / R32 system is 1/4" (6,35mm) and 3/8" (9,52mm), use a pipe reducer connected at indoor and outdoor unit.

**3. Applicable Model.**

Panasonic single split room air conditioner from CS/CU-RE/UE/YE/XE/CE/NE/E\*NKE and PKE series onwards.

Panasonic multi split room air conditioner from CU-2E/3E/4E/5PBE series onwards.

		Liquid		
		Gas	3/8 (9,52)	1/2 (12,70) 5/8 (15,88)
Split	16 / 20 / 25 / 35	1,6 - 3,5kW	✓	▲
	42 / 50 / 60	4,2 - 6,0kW	✗	✓
	71	6,8 - 7,5kW	✗	✗

- ✓ Standard piping connection with current piping length and refrigerant charge rules.
- ▲ This combinations is allowed respecting maximum piping length and refrigerant charged declared in model installed as new.
- ✗ This combinations is not allowed as it is out of piping diameter.

# CONTROL & CONNECTIVITY

NEW 18



## Advanced smartphone control for Domestic Range.

Control air to air heat pump operation with Panasonic Comfort Cloud plus additional functions only available thru the Cloud from wherever and whenever. One user can manage up to 200 units and also set up different user and rights. Also energy monitor is possible giving the chance to learn how to reduce even more the operating cost.



## New possibilities, new applications

- Families:** Different users can be set up, such as each child can manage their own room only. In the case of second houses, this can be remotely pre-cooled or pre-warmed. Or just turned off remotely if someone forget and left the system on.
- Multi tenant owner:** Can manage different sites, up to 200 units with just one smartphone. Knowing the consumption of each place and remotely have error codes remotely for better and quick maintenance.
- Small and medium sized offices:** Owner can control different rooms of the office easily and give unit by unit access to their staff. Also providing information to know where energy might be wasted for heating and cooling and promoting best comfort practices.

### 1 New boundaries in Control

With Panasonic Comfort Cloud the user can manage all functions of the heat pump plus even more. All functions that your heat pump can include like nano<sup>™</sup> air purifier, Econavi sensors, air Flow direction, speed, temperature setting, mode,... all these can be simply managed through Panasonic Comfort Cloud. Also some other additional functions can be easily managed through the app including:

- All on/off at once. For sites with more than one unit in one site, user can turn them all on or off with just one click
- Set weekly timer. Set up to 6 events per day, 42 in a week, easy, intuitive and fast
- Pre-heat or cool. Control your house or office comfort - before you arrive!
- Error code notification. If trouble occurs, error notification or maintenance code is shown



### 2 Energy monitor and statistics

Knowing the energy each unit uses when operating is key to see opportunities to reduce the energy bill. Panasonic Comfort Cloud stores the energy consumption\* of each unit, which can then be shown in easy and powerful statistics graphs. This function is available from TKE and UKE generation.

With the weekly timer the operation can be adjusted to optimize the usage of the energy.

\*Estimated energy consumption data accuracy is depending on power supply quality.



### 3 Scalability and users management

Easily to include additional units and locations as well as including several users with different access rights. This creates more possibilities to manage family house, a second house and also provides opportunities for small/medium sized offices or multi-tenant properties.

- Up to 200 units. Up to 10 Locations (20 units per site)
- User's control rights. Main user can set up other users with limited rights on units and set up

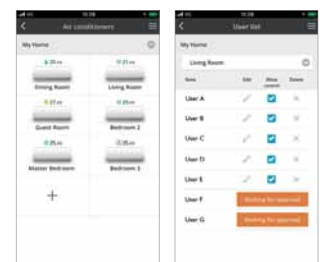

## CZ-TACG1 Panasonic Wifi kit

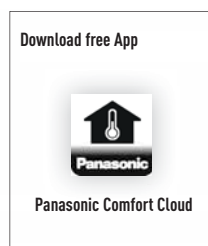
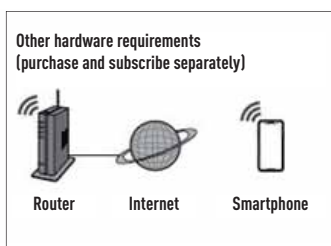
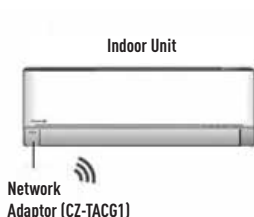

Input Voltage	DC 12V
Power Consumption	Max. 660mW
Size (H x W x D) mm	66 x 36 x 12
Mass	Approx. 85g
Interface	1 x Wireless LAN
Wireless LAN Standard	IEEE 802.11 b/g/n
Frequency Range	2.4GHz band
Encryption	AES

Compatibility: Most Panasonic Domestic range are compatible with CZ-TACG1 WLAN accessory: CS-XZ\*\*TKEW, CS-Z\*\*TKEW, CS-TE\*\*TKEW, CS-TZ\*\*TKEW, CS-FE\*\*UKE, CS-FZ\*\*UKE, CS-PZ\*\*TKE, CS-UZ\*\*TKE, CS-KE\*\*TKE, CS-BE\*\*TKE, CS-DE\*\*TKE, CS-Z\*\*TKEA, CS-Z\*\*UFEAW, CS-Z\*\*UB4EAW, CS-Z\*\*UD3EAW, CS-E\*\*SKEW, CS-XE\*\*SKEW, CS-Z\*\*SKEW, CS-XZ\*\*SKEW, CS-TZ\*\*SKEW, CS-UZ\*\*SKE, CS-PZ\*\*SKE. VKE generation will be also compatible. Remark: indoor temperature display and some special functions are not available through the app for all models. Languages: Available in 19 European languages: Bulgarian, Croatian, Czech, Danish, Deutsch, English, Estonian, Finnish, Français, Greek, Hungarian, Italiano, Norwegian, Polish, Portuguese, Slovenian, Spanish, Swedish and Turkish.

Panasonic offers its customers cutting-edge technology, specially designed to ensure our air conditioning systems deliver even higher performance. You can properly manage the air conditioning and perform comprehensive monitoring and control, with all of the features the remote controller provides at home, from anywhere in the world thanks to the internet applications Panasonic has created for you.

### Domestic integration to P Link - CZ-CAPRA1

Can connect all ranges to P Link. Full control is now possible.

#### Integrates any unit in big system control.

- PKEA Server room integration
- Small offices with Domestic indoors
- Tender for refurbishment (old system Domestic and VRF in one installation)

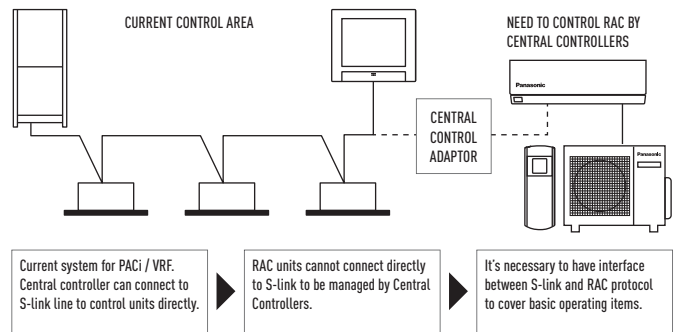

**Basic operation items:** ON/OFF, Mode select, Temperature setting, Fan speed, Flap setting, Remote control prohibit, Econavi ON/OFF.

**External input:** ON/OFF control signal, Abnormal stop signal.

**External output for Relay<sup>1</sup>:** Operation status (ON/OFF), Alarm status output.

1) Because current CN-CNT connector can not provide the power for external output relay, additional Input power for external relay is necessary.

### Connectivity. Control by BMS

Great flexibility for integration into your KNX, EnOcean, Modbus and BacNet projects allows fully bi-directional monitoring and control of all the functioning parameters.

Reference	KNX <sup>®</sup> PAW-AC-KNX-1i	Modbus <sup>®</sup> PAW-AC-MBS-1	enOcean <sup>®</sup> PAW-AC-ENO-1i	BACnet <sup>™</sup> PAW-AC-BAC-1 <sup>1</sup>
Quick installation and possibility of hidden installation	✓	✓	✓	✓
External power not required	✓	✓	✓	✓
Direct connection to the AC indoor unit	✓ (Split or Multi Split)	✓ (Split or Multi Split)	✓ (Split)	✓
Control and monitoring of the internal variables of the indoor unit and error codes and indication	✓ Fully compatible	✓ Fully compatible	✓ Fully compatible	
Use the AC ambient temperature or the one measured by external sensor	✓	✓	✓	
AC unit can be controlled simultaneously by the remote controller of the AC unit and interface devices	✓	✓	✓	
Advanced control functions	✓	✓	✓	
4 binary inputs. They work as standard interface binary inputs as well as being used to control the AC directly	✓	✓	✓	
Total Control and Supervision. Real states of the AC unit's internal variables				✓

1) This interface allows a complete and natural integration of Panasonic air conditioners into either BACnet IP or MS/TP networks. Is a BTL certified device.

#### PAW-AC-DIO

Dry contact ON/OFF Interface. Panasonic has developed for hotels applications a dry contact PCB which works with Ethera, RE, UE and YE indoor units in order to control simply the unit centrally.

- ON/OFF signal by 3rd party BMS
- PCB connected to CN-RMT port on indoor unit PCB





















### Easy connectivity

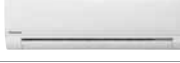
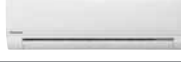



















CN-CNT easy to access. Previous Ethera indoor unit had to be dismantle to reach connector. Can easier connect: Wireless accessory / KNX / Modbus / CZ-CAPRA1 to integrate to PACI control.



Model name	Interface
CZ-TACG1	NEW Panasonic WLAN kit for internet control
CZ-CAPRA1	RAC interface adapter for integration into P Link
PAW-IR-WIFI-1	Interface by Infra red sensor, only ON/OFF and temperature setting
PAW-AC-ENO-1i	EnOcean interface for TKE and UKE models
PAW-AC-KNX-1i	KNX interface for TKE and UKE models
PAW-AC-MBS-1	Modbus interface for TKE and UKE models
PAW-AC-BAC-1	BacNet interface for TKE and UKE models
PAW-AC-HEAT-1	Heating only PCB for Ethera, 4-Way 60x60 Cassette and Low static pressure hide away
PAW-AC-DIO	PCB for wall mounted with dry contacts, On/Off, Error message (all OKE and RKE wall mounted)
PAW-SMSCONTROL	Control of the Ethera, Flagship and Heatcharge by SMS (need additional SIM card)

# DOMESTIC AIR CONDITIONER RANGE R32

Page	1x1 Kits	2,0kW	2,5kW	3,5kW
P. 98	Wall Mounted Heatcharge VZ Inverter+ • R32 GAS		 KIT-VZ9-SKE	 KIT-VZ12-SKE
P. 99	Wall Mounted Etherea Inverter+ Silver • R32 GAS	 KIT-XZ20-TKE	 KIT-XZ25-TKE	 KIT-XZ35-TKE
P. 99	Wall Mounted Etherea Inverter+ Pure White Matt • R32 GAS	 KIT-Z20-TKE	 KIT-Z25-TKE	 KIT-Z35-TKE
P. 100	Wall Mounted TZ Compact Style • R32 GAS	 KIT-TZ20-TKE-1	 KIT-TZ25-TKE-1	 KIT-TZ35-TKE-1
P. 101	<b>NEW</b> Wall Mounted FZ Type Standard Inverter • R32 GAS		 KIT-FZ25-UKE	 KIT-FZ35-UKE
P. 102	Wall Mounted PZ Type Standard Inverter • R32 GAS		 KIT-PZ25-TKE	 KIT-PZ35-TKE
P. 103	<b>NEW</b> Wall Mounted Professional Inverter -20°C • R32 GAS		 KIT-Z25-TKEA	 KIT-Z35-TKEA
P. 105	<b>NEW</b> Floor Console Type Inverter+ • R32 GAS		 KIT-Z25-UFE	 KIT-Z35-UFE
P. 106	<b>NEW</b> 4 Way 60x60 Cassette Standard Inverter • R32 GAS		 KIT-Z25-UB4	 KIT-Z35-UB4
P. 107	<b>NEW</b> Low Static Pressure Hide Away Standard Inverter • R32 GAS		 KIT-Z25-UD3	 KIT-Z35-UD3



















Page	Free Multi	1,6kW	2,0kW	2,5kW	3,5kW
P. 111	Etherea Silver		 CS-XZ20TKEW	 CS-XZ25TKEW	 CS-XZ35TKEW
P. 111	Etherea Pure White Matt	 CS-MZ16TKE	 CS-Z20TKEW	 CS-Z25TKEW	 CS-Z35TKEW
P. 111	TZ Compact Style	 CS-MTZ16TKE	 CS-TZ20TKEW-1	 CS-TZ25TKEW-1	 CS-TZ35TKEW-1
P. 111	<b>NEW</b> Floor Console Type		 CS-MZ20UFEA	 CS-Z25UFEAW	 CS-Z35UFEAW
P. 111	<b>NEW</b> 4 Way 60x60 Cassette		 CS-MZ20UB4EA	 CS-Z25UB4EAW	 CS-Z35UB4EAW
P. 111	<b>NEW</b> Low Static Pressure Hide Away		 CS-MZ20UD3EA	 CS-Z25UD3EAW	 CS-Z35UD3EAW

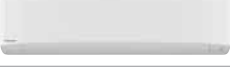

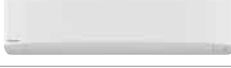









Page	Free Multi	3,2~6,0kW	3,2~6,0kW	3,2~7,7kW	4,5~9,5kW	4,5~11,2kW	4,5~11,5kW	4,5~14,7kW	4,5~18,3kW
P. 110	Outdoor unit Free Multi System Z	 CU-2Z35TBE	 CU-2Z41TBE	 CU-2Z50TBE	 CU-3Z52TBE	 CU-3Z68TBE	 CU-4Z68TBE	 CU-4Z80TBE	 CU-5Z90TBE



Splits 1x1

R32

4,2kW	5,0kW	6,0kW	7,1kW
	 KIT-XZ50-TKE		
 KIT-Z42-TKE	 KIT-Z50-TKE		 KIT-Z71-TKE
 KIT-TZ42-TKE-1	 KIT-TZ50-TKE	 KIT-TZ60-TKE	 KIT-TZ71-TKE
	 KIT-FZ50-UKE	 KIT-FZ60-UKE	
	 KIT-PZ50-TKE		
 KIT-Z42-TKEA	 KIT-Z50-TKEA		 KIT-Z71-TKEA
	 KIT-Z50-UFE		
	 KIT-Z50-UB4	 KIT-Z60-UB4	
	 KIT-Z50-UD3	 KIT-Z60-UD3	

4,2kW	5,0kW	6,0kW	7,1kW
	 CS-XZ50TKEW		
 CS-Z42TKEW	 CS-Z50TKEW		 CS-Z71TKEW
 CS-TZ42TKEW-1	 CS-TZ50TKEW	 CS-TZ60TKEW	 CS-TZ71TKEW
	 CS-Z50UFEAW		
	 CS-Z50UB4EAW	 CS-Z60UB4EAW	
	 CS-Z50UD3EAW	 CS-Z60UD3EAW	

Page	Multi Wall TZ	3,2~6,0kW	3,2~7,7kW	4,5~9,5kW
------	---------------	-----------	-----------	-----------

P. 112 Outdoor unit Multi TZ for wall TZ indoors



CU-2TZ41TBE



CU-2TZ50TBE



CU-3TZ52TBE

# WALL MOUNTED HEATCHARGE VZ INVERTER+

## • R32 GAS



### heatcharge

The Heatcharge from Panasonic has the capacity to store heat on the outdoor unit which allows heating to start quickly just after turning on the heat pump. It also ensures maximum comfort and heat in the house even during defrost operation as Heat charge also stores heat to prevent cool air during defrost.

Econavi builds-in a Sunlight Detection technology to adjust output ideally thereby giving you the best comfort at anytime whilst saving energy.

Furthermore, the nanoe™ revolutionary air-purifying system utilises nano technology fine particles to remove and deactivate 99% of certain airborne and adhesive micro-organisms like bacteria, viruses and mould.

### Technical focus

- R32 gas is more environmentally friendly than R410A
- Performance tested at -35°C Outdoor temperature
- Energy Charge System. Heat storage unit which realizes NON-STOP heating and fast heating function
- Econavi sensor: Even higher efficiency and great comfort
- nanoe™ air purifying system, 99% effective to certain airborne and adhesives mould, viruses, bacteria and pollen allergen
- Super Quiet! Only 18dB(A), equivalent to night-time in the country
- More powerful airflow to quickly reach the desired temperature

Kit			KIT-VZ9-SKE	KIT-VZ12-SKE
Cooling capacity	Nominal (Min - Max)	kW	2,50 (0,60 - 3,00)	3,50 (0,60 - 4,00)
<b>SEER<sup>1)</sup></b>		<b>W/W</b>	<b>10,50</b> ◀A+++	<b>10,00</b> ◀A+++
Pdesign (cooling)		kW	2,50	3,50
Input power cooling	Nominal (Min - Max)	kW	0,43 (0,14 - 0,61)	0,80 (0,14 - 0,98)
Annual energy consumption <sup>3)</sup>		kWh/a	83	122
Heating capacity	Nominal (Min - Max)	kW	3,60 (0,60 - 7,80)	4,20 (0,60 - 9,20)
COP <sup>2)</sup>		W/W	5,63 A	5,04 A
Heating capacity at -7°C		kW	5,00	5,60
COP at -7°C <sup>2)</sup>		W/W	2,07	2,00
<b>SCOP<sup>1)</sup></b>		<b>W/W</b>	<b>6,20</b> ◀A+++	<b>5,90</b> ◀A+++
Pdesign at -10°C		kW	3,60	4,20
Input power heating	Nominal (Min - Max)	kW	0,64 (0,14 - 2,72)	0,83 (0,14 - 3,16)
Annual energy consumption <sup>3)</sup>		kWh/a	812	995
Indoor unit			CS-VZ9SKE	CS-VZ12SKE
Power source		V	230	230
Recommended fuse		A	16	16
Connection indoor / outdoor		mm <sup>2</sup>	4 x 1,5	4 x 1,5
Air volume	Cool / Heat (Hi)	m <sup>3</sup> /min	12,5/15,5	12,9/15,9
Sound pressure <sup>4)</sup>	Cool (Hi / Lo / Q-Lo)	dB(A)	44/27/18	45/33/18
	Heat (Hi / Lo / Q-Lo)	dB(A)	44/26/18	45/29/18
Dimension	H x W x D	mm	295 x 798 x 375	295 x 798 x 375
Net weight		kg	14,5	14,5
Outdoor unit			CU-VZ9SKE	CU-VZ12SKE
Air volume	Cool / Heat (Hi)	m <sup>3</sup> /min	33,1/33,1	35,4/33,9
Sound pressure <sup>4)</sup>	Cool / Heat (Hi)	dB(A)	49/49	50/50
Dimension <sup>5)</sup>	H x W x D	mm	630 x 799 x 299	630 x 799 x 299
Net weight		kg	39,5	39,5
Piping connections	Liquid pipe	Inch (mm)	1/4 (6,35)	1/4 (6,35)
	Gas pipe	Inch (mm)	3/8 (9,52)	3/8 (9,52)
Pipe length range		m	3 - 15	3 - 15
Elevation difference (in/out) <sup>6)</sup>		m	12	12
Pipe length for additional gas		m	7,5	7,5
Additional gas amount		g/m	20	20
Refrigerant (R32)		kg/TCO <sub>2</sub> Eq.	1,05/0,70875	1,10/0,7425
Operating range	Cool Min ~ Max	°C	-10 ~ +43	-10 ~ +43
	Heat Min ~ Max	°C	-30 ~ +24	-30 ~ +24

#### Accessories

- CZ-TACG1** NEW Panasonic WLAN kit for internet control
- CZ-CAPRA1** RAC interface adapter for integration into P Link

#### Accessories

- PAW-SMSCONTROL** Control by SMS (need additional SIM card)

1) Energy Label Scale from A+++ to D. 2) EER and COP calculation is based in accordance to EN14511. 3) The annual energy consumption is calculated in accordance to EU/626/2011. 4) The sound pressure of the units shows the value measured of a position 1m in front of the main body and 0,8m below the unit. The sound pressure is measured in accordance with Eurovent 6/C/006-97 specification. 5) Add 70mm for piping port. 6) When installing the outdoor unit at a higher position than the indoor unit.



SEER and SCOP: For KIT-VZ9-SKE. -35°C HEATING MODE: Heating performance tested at -35°C by SP, European third party laboratory. INTERNET CONTROL: Optional.

Splits 1x1

R32

# WALL MOUNTED ETHEREA INVERTER+ SILVER / PURE WHITE MATT • R32 GAS



ETHEREA

## Etherea with enhanced Econavi sensor and nanoE™ air-purifying system

Econavi features an in-built human activity sensor and a sunlight detection technology to adjust output thereby giving you the best comfort at anytime whilst saving energy. Econavi not only optimizes air flow orientation and volume according to human presence, it also reduces cooling power automatically by no/less sunshine. With Econavi, additional energy savings can be reached up to 38%, whilst increasing your comfort. Furthermore, the nanoE™ revolutionary air-purifying system utilises nano technology fine particles to remove and deactivate 99% of certain airborne and adhesive micro-organisms like bacteria, viruses and mould.

## Technical focus

- R32 gas is more environmentally friendly than R410A
- Econavi sensor: Even higher efficiency and great comfort
- nanoE™ air purifying system, 99% effective to certain airborne and adhesives mould, viruses, bacteria and pollen allergen
- Aerowings to control air draft direction
- Mild Dry Cooling: prevent a rapid decrease in room humidity
- Super Quiet! Only 19dB(A), equivalent to night-time in the countryside
- More powerful airflow to quickly reach the desired temperature
- Wired control (Optional)
- Smartphone control (Optional)

Wall Mounted Etherea  
Silver



## Tentative data

Kit Silver			KIT-XZ20-TKE	KIT-XZ25-TKE	KIT-XZ35-TKE	—	KIT-XZ50-TKE	—
Kit Pure White Matt			KIT-Z20-TKE	KIT-Z25-TKE	KIT-Z35-TKE	KIT-Z42-TKE	KIT-Z50-TKE	KIT-Z71-TKE
Cooling capacity	Nominal (Min - Max)	kW	2,05 [0,75 - 2,40]	2,50 [0,85 - 3,20]	3,50 [0,85 - 4,00]	4,20 [0,85 - 5,00]	5,00 [0,98 - 6,00]	7,10 [0,98 - 8,50]
EER <sup>1)</sup>	Nominal (Min - Max)	W/W	4,56 [3,13 - 4,32]A	4,81 [3,54 - 4,05]A	4,22 [3,54 - 3,81]A	3,39 [3,27 - 3,18]A	3,55 [3,50 - 3,08]A	3,27 [2,33 - 2,93]A
SEER <sup>2)</sup>		W/W	7,50 <b>A+++</b>	8,50 <b>A+++</b>	8,50 <b>A+++</b>	6,90 <b>A+++</b>	7,90 <b>A+++</b>	6,50 <b>A+++</b>
Pdesign (cooling)		kW	2,10	2,50	3,50	4,20	5,00	7,10
Input power cooling	Nominal (Min - Max)	kW	0,45 [0,24 - 0,56]	0,52 [0,24 - 0,79]	0,83 [0,24 - 1,05]	1,24 [0,26 - 1,57]	1,41 [0,28 - 1,95]	2,17 [0,42 - 2,90]
Annual energy consumption <sup>3)</sup>		kWh/a	98	103	144	213	222	382
Heating capacity	Nominal (Min - Max)	kW	2,80 [0,70 - 4,00]	3,40 [0,80 - 5,00]	4,00 [0,80 - 5,80]	5,30 [0,80 - 6,80]	5,80 [0,98 - 8,00]	8,60 [0,98 - 10,20]
Heating capacity at -7°C		kW	2,38	2,95	3,40	4,11	4,80	6,31
COP <sup>1)</sup>	Nominal (Min - Max)	W/W	4,52 [3,89 - 4,04]A	4,79 [4,44 - 3,97]A	4,44 [4,44 - 3,87]A	3,68 [4,21 - 3,51]A	4,03 [2,88 - 3,16]A	3,66 [2,45 - 3,46]A
SCOP <sup>2)</sup>		W/W	4,70 <b>A+++</b>	5,10 <b>A+++</b>	5,10 <b>A+++</b>	4,00 <b>A+</b>	4,70 <b>A+++</b>	4,20 <b>A+</b>
Pdesign at -10°C		kW	2,10	2,70	3,20	3,60	4,20	5,50
Input power heating	Nominal (Min - Max)	kW	0,62 [0,18 - 0,99]	0,71 [0,18 - 1,26]	0,90 [0,18 - 1,50]	1,44 [0,19 - 1,94]	1,44 [0,34 - 2,53]	2,35 [0,40 - 2,95]
Annual energy consumption <sup>3)</sup>		kWh/a	626	741	878	1260	1251	1833
Indoor unit Silver			CS-XZ20TKEW	CS-XZ25TKEW	CS-XZ35TKEW	—	CS-XZ50TKEW	—
Indoor unit Pure White Matt			CS-Z20TKEW	CS-Z25TKEW	CS-Z35TKEW	CS-Z42TKEW	CS-Z50TKEW	CS-Z71TKEW
Power source		V	230	230	230	230	230	230
Recommended fuse		A	16	16	16	16	16	20
Connection indoor / outdoor		mm <sup>2</sup>	4x1,5	4x1,5	4x1,5	4x1,5	4x2,5	4x2,5
Air volume	Cool / Heat	m <sup>3</sup> /min	9,9/10,8	10,0/11,5	10,7/12,4	11,2/12,3	19,2/21,3	19,8/21,5
Moisture removal volume		L/h	1,3	1,5	2,0	2,4	2,8	4,1
Sound pressure <sup>4)</sup>	Cool (Hi / Lo / Q-Lo)	dB(A)	37/24/19	39/25/19	42/28/19	43/31/25	44/37/30	47/38/30
	Heat (Hi / Lo / Q-Lo)	dB(A)	38/25/19	41/27/19	43/33/19	43/35/29	44/37/30	47/38/30
Dimension	HxWxD	mm	295x919x194	295x919x194	295x919x194	295x919x194	302x1120x236	302x1120x236
Net weight		kg	9	10	10	10	12	13
Outdoor unit			CU-Z20TKE	CU-Z25TKE	CU-Z35TKE	CU-Z42TKE	CU-Z50TKE	CU-Z71TKE
Air volume	Cool / Heat	m <sup>3</sup> /min	26,9/26,9	28,7/28,7	34,4/35,6	33,3/33,7	39,7/38,6	44,7/45,8
Sound pressure <sup>4)</sup>	Cool / Heat (Hi)	dB(A)	45/46	46/47	48/50	49/51	47/47	52/54
Dimension <sup>5)</sup>	HxWxD	mm	542x780x289	542x780x289	619x824x299	619x824x299	695x875x320	695x875x320
Net weight		kg	30	31	34	32	42	49
Piping connections	Liquid pipe	Inch (mm)	1/4 (6,35)	1/4 (6,35)	1/4 (6,35)	1/4 (6,35)	1/4 (6,35)	1/4 (6,35)
	Gas pipe	Inch (mm)	3/8 (9,52)	3/8 (9,52)	3/8 (9,52)	1/2 (12,70)	1/2 (12,70)	5/8 (15,88)
Pipe length range		m	3~15	3~15	3~15	3~15	3~20	3~30
Elevation difference (in/out) <sup>6)</sup>		m	15	15	15	15	15	20
Pipe length for additional gas		m	7,5	7,5	7,5	7,5	7,5	10
Additional gas amount		g/m	10	10	10	10	15	25
Refrigerant (R32)		kg/TCO <sub>2</sub> Eq.	0,76/0,513	0,85/0,574	0,91/0,614	0,87/0,587	1,11/0,749	1,37/0,925
Operating range	Cool Min ~ Max	°C	-10 ~ +43	-10 ~ +43	-10 ~ +43	-10 ~ +43	-10 ~ +43	-10 ~ +43
	Heat Min ~ Max	°C	-15 ~ +24	-15 ~ +24	-15 ~ +24	-15 ~ +24	-15 ~ +24	-15 ~ +24

### Accessories

<b>CZ-TACG1</b>	NEW Panasonic WLAN kit for internet control
<b>CZ-CAPRA1</b>	RAC interface adapter for integration into P Link

### Accessories

<b>CZ-RD514C</b>	Wired remote controller for Wall Mounted and Floor Console
------------------	--

1) EER and COP calculation is based in accordance to EN14511. 2) Energy Label Scale from A+++ to D. 3) The annual energy consumption is calculated in accordance to EU/626/2011. 4) The sound pressure of the units shows the value measured of a position 1m in front of the main body and 0,8m below the unit. The sound pressure is measured in accordance with Eurovent 6/C/006-97 specification. Q-Lo: Quiet mode. Lo: The lowest fan speed. 5) Add 70mm for piping port. 6) When installing the outdoor unit at a higher position than the indoor unit. \* Tentative data.



SEER and SCOP: For KIT-XZ25-TKE, KIT-XZ35-TKE, KIT-Z25-TKE and KIT-Z35-TKE. SUPER QUIET: For KIT-XZ20-TKE, KIT-XZ25-TKE, KIT-XZ35-TKE, KIT-Z20-TKE, KIT-Z25-TKE and KIT-Z35-TKE. INTERNET CONTROL: Optional. iF DESIGN AWARD 2017: Etherea White awarded with the prestigious iF Design Award 2017.

Rating Conditions: Cooling Indoor 27°C DB / 19°C WB. Cooling Outdoor 35°C DB / 24°C WB. Heating Indoor 20°C DB. Heating Outdoor 7°C DB / 4°C WB. (DB: Dry Bulb; WB: Wet Bulb) Specifications subject to change without notice. For detailed information about ErP / Energy Labelling, please visit our websites [www.aircon.panasonic.eu](http://www.aircon.panasonic.eu) or [www.ptc.panasonic.eu](http://www.ptc.panasonic.eu).

# WALL MOUNTED TZ COMPACT STYLE INVERTER

## • R32 GAS



### TZ compact indoor size

The TZ indoor units have compact size. With 799mm of width, you can put the air conditioner on the top of the door.

The TZ Inverter models are powerful and efficient, with a high energy efficiency class of A++ / A+. The TZ works in cooling mode from -10°C outdoors and -15°C in heating with a high efficiency. Furthermore, the PM2,5 filter and the low operation noise is making this TZ Series a great choice in the compact category.

### Technical focus

- Compact design with 799mm
- R32 gas is more environmentally friendly than R410A
- Aerowings to control air draft direction
- PM2,5 Filter to create clean and comfort indoor quality
- Complete line-up of standard Inverter models
- Super Quiet! Only 20dB(A)
- High energy savings
- This units can be installed on R410A and R22 pipings
- Long connection distance (from 15m up to 30m)
- Wired control (Optional)
- Smartphone control (Optional)

Kit			KIT-TZ20-TKE-1	KIT-TZ25-TKE-1	KIT-TZ35-TKE-1	KIT-TZ42-TKE-1	KIT-TZ50-TKE	KIT-TZ60-TKE	KIT-TZ71-TKE
Cooling capacity	Nominal (Min - Max)	kW	2,00(0,75 - 2,40)	2,50(0,85 - 3,00)	3,50(0,85 - 3,90)	4,20(0,85 - 4,60)	5,00(0,98 - 5,60)	6,30(0,98 - 7,10)	7,10(0,98 - 8,10)
EER <sup>1)</sup>	Nominal (Min - Max)	W/W	4,08(3,00 - 4,00)A	3,85(3,40 - 3,41)A	3,57(3,33 - 3,36)A	3,36(3,21 - 2,80)A	3,40(3,44 - 3,24)A	3,26(3,50 - 2,98)A	3,17(2,33 - 3,03)B
SEER <sup>2)</sup>		W/W	<b>6,80</b> A++	<b>6,90</b> A++	<b>6,70</b> A++	<b>6,30</b> A++	<b>6,80</b> A++	<b>6,50</b> A++	<b>6,10</b> A++
Pdesign (cooling)		kW	2,00	2,50	3,50	4,20	5,00	6,30	7,10
Input power cooling	Nominal (Min - Max)	kW	0,49(0,25 - 0,60)	0,65(0,25 - 0,88)	0,98(0,26 - 1,16)	1,25(0,27 - 1,64)	1,47(0,29 - 1,73)	1,93(0,28 - 2,38)	2,24(0,42 - 2,67)
Annual energy consumption <sup>3)</sup>		kWh/a	103	127	183	233	257	339	407
Heating capacity	Nominal (Min - Max)	kW	2,70(0,70 - 3,60)	3,30(0,80 - 4,10)	4,00(0,80 - 5,10)	5,00(0,80 - 6,80)	5,80(0,98 - 7,80)	7,20(0,98 - 8,50)	8,60(0,98 - 9,90)
Heating capacity at -7°C		kW	2,14	2,70	3,30	3,90	4,79	5,24	6,13
COP <sup>1)</sup>	Nominal (Min - Max)	W/W	4,15(3,78 - 3,53)A	4,18(4,10 - 3,66)A	4,04(4,00 - 3,70)A	3,73(4,00 - 3,33)A	3,77(2,88 - 3,39)A	3,44(2,88 - 3,15)B	3,51(2,45 - 3,47)B
SCOP <sup>2)</sup>		W/W	<b>4,60</b> A++	<b>4,60</b> A++	<b>4,60</b> A++	<b>4,00</b> A+	<b>4,30</b> A+	<b>4,20</b> A+	<b>4,00</b> A+
Pdesign at -10°C		kW	1,90	2,40	2,80	3,60	4,00	4,60	5,50
Input power heating	Nominal (Min - Max)	kW	0,65(0,19 - 1,02)	0,79(0,20 - 1,12)	0,99(0,20 - 1,38)	1,34(0,20 - 2,04)	1,54(0,34 - 2,30)	2,09(0,34 - 2,70)	2,45(0,40 - 2,85)
Annual energy consumption <sup>3)</sup>		kWh/a	578	730	852	1260	1302	1533	1925
<b>Indoor unit</b>			<b>CS-TZ20TKEW-1</b>	<b>CS-TZ25TKEW-1</b>	<b>CS-TZ35TKEW-1</b>	<b>CS-TZ42TKEW-1</b>	<b>CS-TZ50TKEW</b>	<b>CS-TZ60TKEW</b>	<b>CS-TZ71TKEW</b>
Air volume	Cool / Heat	m <sup>3</sup> /min	9,6/10,6	10,5/11,4	11,3/12,1	12,3/12,9	19,9/20,8	20,8/21,4	20,0/22,0
Moisture removal volume		L/h	1,3	1,5	2,0	2,4	2,8	3,5	4,1
Sound pressure <sup>4)</sup>	Cool (Hi / Lo / Q-Lo)	dB(A)	37/25/20	40/26/20	42/30/20	44/31/29	44/37/34	45/37/34	47/38/35
	Heat (Hi / Lo / Q-Lo)	dB(A)	38/26/22	40/27/22	42/33/22	44/35/28	44/37/34	45/37/34	47/38/35
Dimension	H x W x D	mm	290 x 799 x 197	290 x 799 x 197	290 x 799 x 197	290 x 799 x 197	302 x 1102 x 244	302 x 1102 x 244	302 x 1102 x 244
Net weight		kg	8	8	8	8	12	12	13
<b>Outdoor unit</b>			<b>CU-TZ20TKE-1</b>	<b>CU-TZ25TKE-1</b>	<b>CU-TZ35TKE-1</b>	<b>CU-TZ42TKE-1</b>	<b>CU-TZ50TKE</b>	<b>CU-TZ60TKE</b>	<b>CU-TZ71TKE</b>
Power source		V	230	230	230	230	230	230	230
Recommended fuse		A	16	16	16	16	16	20	20
Connection indoor / outdoor		mm <sup>2</sup>	4 x 1,5	4 x 1,5	4 x 1,5	4 x 1,5	4 x 2,5	4 x 2,5	4 x 2,5
Air volume	Cool / Heat	m <sup>3</sup> /min	28,9/27,4	29,0/27,6	29,1/30,2	33,6/34,0	33,0/32,2	42,6/41,5	44,7/48,1
Sound pressure <sup>4)</sup>	Cool / Heat (Hi)	dB(A)	46/47	47/48	48/50	49/51	48/49	49/49	52/54
		mm	542 x 780 x 289	542 x 780 x 289	542 x 780 x 289	619 x 824 x 299	619 x 824 x 299	695 x 875 x 320	695 x 875 x 320
Net weight		kg	27	28	33	34	40	42	49
Piping connections	Liquid pipe	Inch (mm)	1/4(6,35)	1/4(6,35)	1/4(6,35)	1/4(6,35)	1/4(6,35)	1/4(6,35)	1/4(6,35)
	Gas pipe	Inch (mm)	3/8(9,52)	3/8(9,52)	3/8(9,52)	1/2(12,70)	1/2(12,70)	1/2(12,70)	5/8(15,88)
Pipe length range		m	3~15	3~15	3~15	3~15	3~20	3~30	3~30
Elevation difference (in/out) <sup>6)</sup>		m	15	15	15	15	15	15	20
Pipe length for additional gas		m	7,5	7,5	7,5	7,5	7,5	7,5	10
Additional gas amount		g/m	10	10	10	10	15	15	25
Refrigerant (R32)		kg/TCO <sub>2</sub> Eq.	0,61/0,412	0,70/0,473	0,82/0,554	0,87/0,587	1,14/0,770	1,11/0,749	1,32/0,891
Operating range	Cool Min ~ Max	°C	-10 ~ +43	-10 ~ +43	-10 ~ +43	-10 ~ +43	-10 ~ +43	-10 ~ +43	-10 ~ +43
	Heat Min ~ Max	°C	-15 ~ +24	-15 ~ +24	-15 ~ +24	-15 ~ +24	-15 ~ +24	-15 ~ +24	-15 ~ +24

### Accessories

- CZ-TACG1** NEW Panasonic WLAN kit for internet control
- CZ-CAPRA1** RAC interface adapter for integration into P Link

### Accessories

- CZ-RD514C** Wired remote controller for Wall Mounted and Floor Console

1) EER and COP calculation is based in accordance to EN14511. 2) Energy Label Scale from A+++ to D. 3) The annual energy consumption is calculated in accordance to EU/626/2011. 4) The sound pressure of the units shows the value measured of a position 1m in front of the main body and 0,8m below the unit. The sound pressure is measured in accordance with Eurovent 6/C/006-97 specification. Q-Lo: Quiet mode. Lo: The lowest fan speed. 5) Add 70mm for piping port. 6) When installing the outdoor unit at a higher position than the indoor unit.



SEER and SCOP: For KIT-TZ25-TKE-1. SUPER QUIET: For KIT-TZ20-TKE-1, KIT-TZ25-TKE-1 and KIT-TZ35-TKE-1. INTERNET CONTROL: Optional.

Splits 1x1

R32

**NEW WALL MOUNTED FZ  
TYPE STANDARD INVERTER**

• R32 GAS



**New FZ series inverter powerful and efficient**



**Technical focus**

- R32 gas is more environmentally friendly than R410A
- PM2,5 Filter to create clean and comfort indoor quality
- Super Quiet! Only 20dB(A)
- High energy savings
- Cooling even at -10°C
- These units can be installed on R22 pipings
- Long connection distance
- Wired control (Optional)
- Smartphone control (Optional)

Kit			KIT-FZ25-UKE	KIT-FZ35-UKE	KIT-FZ50-UKE	KIT-FZ60-UKE
Cooling capacity	Nominal (Min - Max)	kW	2,50(0,85 - 3,00)	3,40(0,85 - 3,90)	5,00(0,98 - 5,40)	6,25(0,98 - 7,10)
EER <sup>1)</sup>	Nominal (Min - Max)	W/W	3,68(3,40 - 3,33)A	3,18(3,33 - 3,05)B	3,03(3,44 - 2,90)B	3,24(3,50 - 2,96)A
<b>SEER <sup>2)</sup></b>		<b>W/W</b>	<b>6,20</b> ◀A++	<b>6,10</b> ◀A++	<b>6,50</b> ◀A++	<b>6,20</b> ◀A++
Pdesign (cooling)		kW	2,50	3,40	5,00	6,30
Input power cooling	Nominal (Min - Max)	kW	0,68(0,25 - 0,90)	1,07(0,26 - 1,28)	1,65(0,29 - 1,86)	1,93(0,28 - 2,40)
Annual energy consumption <sup>3)</sup>		kWh/a	141	195	269	356
Heating capacity	Nominal (Min - Max)	kW	3,15(0,80 - 3,60)	3,84(0,80 - 4,40)	5,40(0,98 - 7,50)	6,80(0,98 - 8,50)
Heating capacity at -7°C		kW	2,14	2,60	4,58	5,24
COP <sup>1)</sup>	Nominal (Min - Max)	W/W	4,04(4,10 - 3,46)A	3,66(4,10 - 3,41)A	3,42(2,80 - 3,06)B	3,51(2,88 - 3,11)B
<b>SCOP <sup>2)</sup></b>		<b>W/W</b>	<b>4,10</b> ◀A+	<b>4,10</b> ◀A+	<b>3,90</b> ◀A	<b>3,90</b> ◀A
Pdesign at -10°C		kW	1,90	2,40	4,00	4,60
Input power heating	Nominal (Min - Max)	kW	0,78(0,20 - 1,04)	1,05(0,20 - 1,29)	1,58(0,35 - 2,45)	1,94(0,34 - 2,73)
Annual energy consumption <sup>3)</sup>		kWh/a	649	820	1436	1651
<b>Indoor unit</b>			<b>CS-FZ25UKE</b>	<b>CS-FZ35UKE</b>	<b>CS-FZ50UKE</b>	<b>CS-FZ60UKE</b>
Power source		V	230	230	230	230
Recommended fuse		A	16	16	16	—
Connection indoor / outdoor		mm <sup>2</sup>	4 x 1,5	4 x 1,5	4 x 2,5	—
Air volume	Cool / Heat	m <sup>3</sup> /min	10,3/11,0	10,7/11,2	11,6/12,5	17,2/18,7
Moisture removal volume		L/h	1,5	2,0	2,8	3,5
Sound pressure <sup>4)</sup>	Cool (Hi / Lo / Q-Lo)	dB(A)	37/26/20	38/30/20	44/37/34	45/37/34
	Heat (Hi / Lo / Q-Lo)	dB(A)	37/27/24	38/33/25	44/37/34	45/37/34
Dimension	H x W x D	mm	290 x 850 x 199	290 x 850 x 199	290 x 870 x 214	290 x 1070 x 240
Net weight		kg	8	8	9	12
<b>Outdoor unit</b>			<b>CU-FZ25UKE</b>	<b>CU-FZ35UKE</b>	<b>CU-FZ50UKE</b>	<b>CU-FZ60UKE</b>
Air volume	Cool / Heat	m <sup>3</sup> /min	30,5/30,5	31,1/31,1	32,7/32,7	42,6/41,5
Sound pressure <sup>4)</sup>	Cool / Heat (Hi)	dB(A)	48/49	48/50	48/49	49/49
Dimension <sup>5)</sup>	H x W x D	mm	542 x 780 x 289	542 x 780 x 289	619 x 824 x 299	695 x 875 x 320
Net weight		kg	26	27	38	43
Piping connections	Liquid pipe	Inch (mm)	1/4(6,35)	1/4(6,35)	1/4(6,35)	1/4(6,35)
	Gas pipe	Inch (mm)	3/8(9,52)	3/8(9,52)	1/2(12,70)	1/2(12,70)
Pipe length range		m	3 - 15	3 - 15	3 - 15	3 - 30
Elevation difference (in/out) <sup>6)</sup>		m	15	15	15	15
Pipe length for additional gas		m	7,5	7,5	7,5	7,5
Additional gas amount		g/m	10	10	15	15
Refrigerant (R32)		kg/TCO <sub>2</sub> Eq.	0,58/0,392	0,67/0,452	1,14/0,770	1,15/0,776
Operating range	Cool Min ~ Max	°C	-10 ~ +43	-10 ~ +43	-10 ~ +43	-10 ~ +43
	Heat Min ~ Max	°C	-15 ~ +24	-15 ~ +24	-15 ~ +24	-15 ~ +24

Accessories	
<b>CZ-TACG1</b>	NEW Panasonic WLAN kit for internet control
<b>CZ-CAPRA1</b>	RAC interface adapter for integration into P Link

Accessories	
<b>CZ-RD514C</b>	Wired remote controller for Wall Mounted and Floor Console

1) EER and COP calculation is based in accordance to EN14511. 2) Energy Label Scale from A+++ to D. 3) The annual energy consumption is calculated in accordance to EU/626/2011. 4) The sound pressure of the units shows the value measured of a position 1m in front of the main body and 0,8m below the unit. The sound pressure is measured in accordance with Eurovent 6/C/006-97 specification. Q-Lo: Quiet mode. Lo: The lowest fan speed. 5) Add 70mm for piping port. 6) When installing the outdoor unit at a higher position than the indoor unit.

SEER and SCOP: For KIT-FZ50-UKE. SUPER QUIET: For KIT-FZ25-UKE and KIT-FZ35-UKE. INTERNET CONTROL: Optional.

# WALL MOUNTED PZ TYPE STANDARD INVERTER • R32 GAS



## PZ Inverter models are powerful and efficient



## Technical focus

- R32 gas is more environmentally friendly than R410A
- Super Quiet! Only 20dB(A)
- High energy savings
- This units can be installed on R410A and R22 pipings
- Long connection distance
- Wired control (Optional)
- Smartphone control (Optional)

Kit			KIT-PZ25-TKE	KIT-PZ35-TKE	KIT-PZ50-TKE
Cooling capacity	Nominal (Min - Max)	kW	2,50 (0,85 - 3,00)	3,40 (0,85 - 3,90)	5,00 (0,98 - 5,40)
EER <sup>1)</sup>	Nominal (Min - Max)	W/W	3,62 (3,40 - 3,30) A	3,09 (3,33 - 3,00) B	2,98 (3,44 - 2,86) C
<b>SEER <sup>2)</sup></b>		<b>W/W</b>	<b>5,80 </b>	<b>5,60 </b>	<b>6,00 </b>
Pdesign (cooling)		kW	2,50	3,40	5,00
Input power cooling	Nominal (Min - Max)	kW	0,69 (0,25 - 0,91)	1,10 (0,26 - 1,30)	1,68 (0,29 - 1,89)
Annual energy consumption <sup>3)</sup>		kWh/a	151	213	292
Heating capacity	Nominal (Min - Max)	kW	3,15 (0,80 - 3,60)	3,84 (0,80 - 4,40)	5,40 (0,98 - 7,50)
Heating capacity at -7°C		kW	2,14	2,60	4,58
COP <sup>1)</sup>	Nominal (Min - Max)	W/W	4,09 (4,10 - 3,50) A	3,69 (4,10 - 3,46) A	3,44 (2,80 - 3,07) B
<b>SCOP <sup>2)</sup></b>		<b>W/W</b>	<b>4,10 </b>	<b>4,10 </b>	<b>4,00 </b>
Pdesign at -10°C		kW	1,90	2,40	4,00
Input power heating	Nominal (Min - Max)	kW	0,77 (0,20 - 1,03)	1,04 (0,20 - 1,27)	1,57 (0,35 - 2,44)
Annual energy consumption <sup>3)</sup>		kWh/a	649	820	1366
<b>Indoor unit</b>			<b>CS-PZ25TKE</b>	<b>CS-PZ35TKE</b>	<b>CS-PZ50TKE</b>
Power source		V	230	230	230
Recommended fuse		A	16	16	16
Connection indoor / outdoor		mm <sup>2</sup>	4 x 1,5	4 x 1,5	4 x 1,5
Air volume	Cool / Heat	m <sup>3</sup> /min	10,3/11,0	10,7/11,2	11,6/12,5
Moisture removal volume		L/h	1,5	2,0	2,8
Sound pressure <sup>4)</sup>	Cool (Hi / Lo / Q-Lo)	dB(A)	37/26/20	38/30/20	44/37/34
	Heat (Hi / Lo / Q-Lo)	dB(A)	37/27/24	38/33/25	44/37/34
Dimension	H x W x D	mm	290 x 850 x 199	290 x 850 x 199	290 x 870 x 214
Net weight		kg	8	8	9
<b>Outdoor unit</b>			<b>CU-PZ25TKE</b>	<b>CU-PZ35TKE</b>	<b>CU-PZ50TKE</b>
Air volume	Cool / Heat	m <sup>3</sup> /min	30,5/30,5	31,1/31,1	32,7/32,7
Sound pressure <sup>4)</sup>	Cool / Heat (Hi)	dB(A)	48/49	48/50	48/49
Dimension <sup>5)</sup>	H x W x D	mm	542 x 780 x 289	542 x 780 x 289	619 x 824 x 299
Net weight		kg	26	27	38
Piping connections	Liquid pipe	Inch (mm)	1/4 (6,35)	1/4 (6,35)	1/4 (6,35)
	Gas pipe	Inch (mm)	3/8 (9,52)	3/8 (9,52)	1/2 (12,70)
Pipe length range		m	3 - 15	3 - 15	3 - 15
Elevation difference (in/out) <sup>6)</sup>		m	15	15	15
Pipe length for additional gas		m	7,5	7,5	7,5
Additional gas amount		g/m	10	10	15
Refrigerant (R32)		kg/TCO <sub>2</sub> Eq.	0,58/0,392	0,67/0,452	1,14/0,770
Operating range	Cool Min ~ Max	°C	+5 ~ +43	+5 ~ +43	+5 ~ +43
	Heat Min ~ Max	°C	-15 ~ +24	-15 ~ +24	-15 ~ +24

Accessories	
<b>CZ-TACG1</b>	NEW Panasonic WLAN kit for internet control
<b>CZ-CAPRA1</b>	RAC interface adapter for integration into P Link

Accessories	
<b>CZ-RD514C</b>	Wired remote controller for Wall Mounted and Floor Console

1) EER and COP calculation is based in accordance to EN14511. 2) Energy Label Scale from A+++ to D. 3) The annual energy consumption is calculated in accordance to EU/626/2011. 4) The sound pressure of the units shows the value measured of a position 1m in front of the main body and 0,8m below the unit. The sound pressure is measured in accordance with Eurovent 6/C/006-97 specification. Q-Lo: Quiet mode. Lo: The lowest fan speed. 5) Add 70mm for piping port. 6) When installing the outdoor unit at a higher position than the indoor unit.



SEER: For KIT-PZ50-TKE. SCOP: For KIT-PZ25-TKE and KIT-PZ35-TKE. SUPER QUIET: For KIT-PZ25-TKE and KIT-PZ35-TKE.

Splits 1x1

R32

**NEW WALL MOUNTED  
PROFESSIONAL INVERTER  
-20°C • R32 GAS**



**Complete line-up with high efficiency even at -20°C**

This Wall Mounted air conditioner is especially designed for professional applications such as computer rooms where cooling inside the room is necessary even when the outside temperature is low. Furthermore this air conditioner has an automatic changeover system, in order to maintain the inside temperature even when sharp outside temperature changes occur.

**Technical focus**

- **NEW!** New design
- R32 gas is more environmentally friendly than R410A
- Designed for 24h/7d a week operation
- Up to A+++ in cooling
- Highly efficient even at -20°C
- High durability rolling bearings
- Additional piping sensors to prevent freezing
- Automatic restart

KIT			KIT-Z25-TKEA	KIT-Z35-TKEA	KIT-Z42-TKEA	KIT-Z50-TKEA	KIT-Z71-TKEA
Cooling capacity	Nominal (Min - Max)	kW	2,50 [0,85 - 3,00]	3,50 [0,85 - 4,00]	4,20 [0,98 - 5,00]	5,00 [0,98 - 6,00]	7,10 [0,98 - 8,10]
EER <sup>1)</sup>	Nominal (Min - Max)	W/W	4,90 [5,00 - 4,29] A	4,07 [5,00 - 3,64] A	3,82 [4,90 - 3,25] A	3,60 [3,50 - 3,09] A	3,17 [2,33 - 3,03] B
SEER <sup>2)</sup>		W/W	<b>8,50</b> A+++	<b>8,50</b> A+++	<b>8,50</b> A+++	<b>8,50</b> A+++	<b>6,10</b> A++
Pdesign		kW	2,50	3,50	4,20	5,00	7,10
Input power cooling	Nominal (Min - Max)	kW	0,51 [0,17 - 0,70]	0,86 [0,17 - 1,10]	1,10 [0,20 - 1,54]	1,39 [0,28 - 1,94]	2,24 [0,42 - 2,67]
Annual energy consumption <sup>3)</sup>		kWh/a	103	144	173	206	407
Heating capacity	Nominal (Min - Max)	kW	3,40 [0,85 - 5,40]	4,00 [0,85 - 6,60]	5,40 [0,98 - 7,25]	5,80 [0,98 - 8,00]	8,60 [0,98 - 9,90]
Heating capacity at -7°C		kW	3,33	4,07	4,30	5,00	6,13
COP <sup>1)</sup>	Nominal (Min - Max)	W/W	4,86 [5,15 - 4,12] A	4,35 [5,15 - 3,63] A	4,00 [4,45 - 3,37] A	4,03 [2,88 - 3,20] A	3,51 [2,45 - 3,47] B
SCOP <sup>2)</sup>		W/W	<b>4,50</b> A+	<b>4,40</b> A+	<b>4,30</b> A+	<b>4,40</b> A+	<b>4,00</b> A+
Pdesign at -10°C		kW	2,80	3,60	3,80	4,40	5,50
Input power heating	Nominal (Min - Max)	kW	0,70 [0,17 - 1,31]	0,92 [0,17 - 1,82]	1,35 [0,22 - 2,15]	1,44 [0,34 - 2,50]	2,45 [0,40 - 2,85]
Annual energy consumption <sup>3)</sup>		kWh/a	871	1145	1237	1400	1925
Indoor unit			CS-Z25TKEA	CS-Z35TKEA	CS-Z42TKEA	CS-Z50TKEA	CS-Z71TKEA
Power source		V	230	230	230	230	230
Recommended fuse		A	16	16	16	16	20
Connection indoor / outdoor		mm <sup>2</sup>	4 x 1,5	4 x 1,5	4 x 1,5	4 x 2,5	4 x 2,5
Air Volume	Cool / Heat	m <sup>3</sup> /min	10,4 / 11,7	10,7 / 12,4	18,2 / 20,2	19,2 / 21,3	20,2 / 21,0
Moisture removal volume		L/h	1,5	2,0	2,4	2,8	4,1
Sound pressure <sup>4)</sup>	Cool (Hi / Lo / Q-Lo)	dB(A)	39 / 25 / 21	42 / 28 / 21	43 / 32 / 29	44 / 37 / 30	47 / 38 / 35
	Heat (Hi / Lo / Q-Lo)	dB(A)	41 / 27 / 22	43 / 30 / 22	44 / 35 / 29	44 / 37 / 30	47 / 38 / 35
Dimension	H x W x D	mm	295 x 919 x 194	295 x 919 x 194	302 x 1120 x 236	302 x 1120 x 236	302 x 1120 x 236
Net weight		kg	9	10	12	12	13
Outdoor unit			CU-Z25TKEA	CU-Z35TKEA	CU-Z42TKEA	CU-Z50TKEA	CU-Z71TKEA
Sound pressure <sup>4)</sup>	Cool / Heat (Hi)	dB(A)	46 / 48	48 / 50	48 / 50	48 / 50	52 / 54
Dimension <sup>5)</sup>	H x W x D	mm	619 x 824 x 299	619 x 824 x 299	619 x 824 x 299	695 x 875 x 320	695 x 875 x 320
Net weight		kg	37	38	38	43	49
Piping connections	Liquid pipe	Inch (mm)	1/4 (6,35)	1/4 (6,35)	1/4 (6,35)	1/4 (6,35)	1/4 (6,35)
	Gas pipe	Inch (mm)	3/8 (9,52)	3/8 (9,52)	1/2 (12,70)	1/2 (12,70)	5/8 (15,88)
Pipe length range		m	3 - 20	3 - 20	3 - 20	3 - 30	3 - 30
Elevation difference (in/out) <sup>6)</sup>		m	15	15	15	15	20
Pipe length for additional gas		m	7,5	7,5	7,5	7,5	10
Additional gas amount		g/m	10	10	10	15	25
Refrigerant (R32)		kg / TCO <sub>2</sub> Eq.	0,96 / 0,648	1,00 / 0,675	1,08 / 0,729	1,15 / 0,776	1,32 / 0,891
Operating range	Cool Min ~ Max	°C	-20 ~ +43	-20 ~ +43	-20 ~ +43	-20 ~ +43	-20 ~ +43
	Heat Min ~ Max	°C	-15 ~ +24	-15 ~ +24	-15 ~ +24	-15 ~ +24	-15 ~ +24

**Accessories**

<b>CZ-TACG1</b>	NEW Panasonic WLAN kit for internet control
<b>CZ-CAPRA1</b>	RAC interface adapter for integration into P Link
<b>PAW-WTRAY</b>	Tray for condenser water compatible with base ground support

**Accessories**

<b>PAW-GRDSTD40</b>	Outdoor elevation platform
<b>PAW-GRDBSE20</b>	Outdoor base ground support for noise and vibration absorption
<b>PAW-SERVER-PKEA</b>	PCB for installation in server rooms with security

1) EER and COP calculation is based in accordance to EN14511. 2) Energy Label Scale from A+++ to D. 3) The annual energy consumption is calculated in accordance to EU/626/2011. 4) The sound pressure of the units shows the value measured of a position 1m in front of the main body and 0,8m below the unit. The sound pressure is measured in accordance with Eurovent 6/C/006-97 specification. Q-Lo: Quiet mode. Lo: The lowest fan speed. 5) Add 70mm for piping port. 6) When installing the outdoor unit at a higher position than the indoor unit.

SEER and SCOP: For KIT-Z25-TKEA. SUPER QUIET: For KIT-Z25-TKEA. INTERNET CONTROL: Optional.

# NEW NANOE™ X. QUALITY AIR FOR LIFE

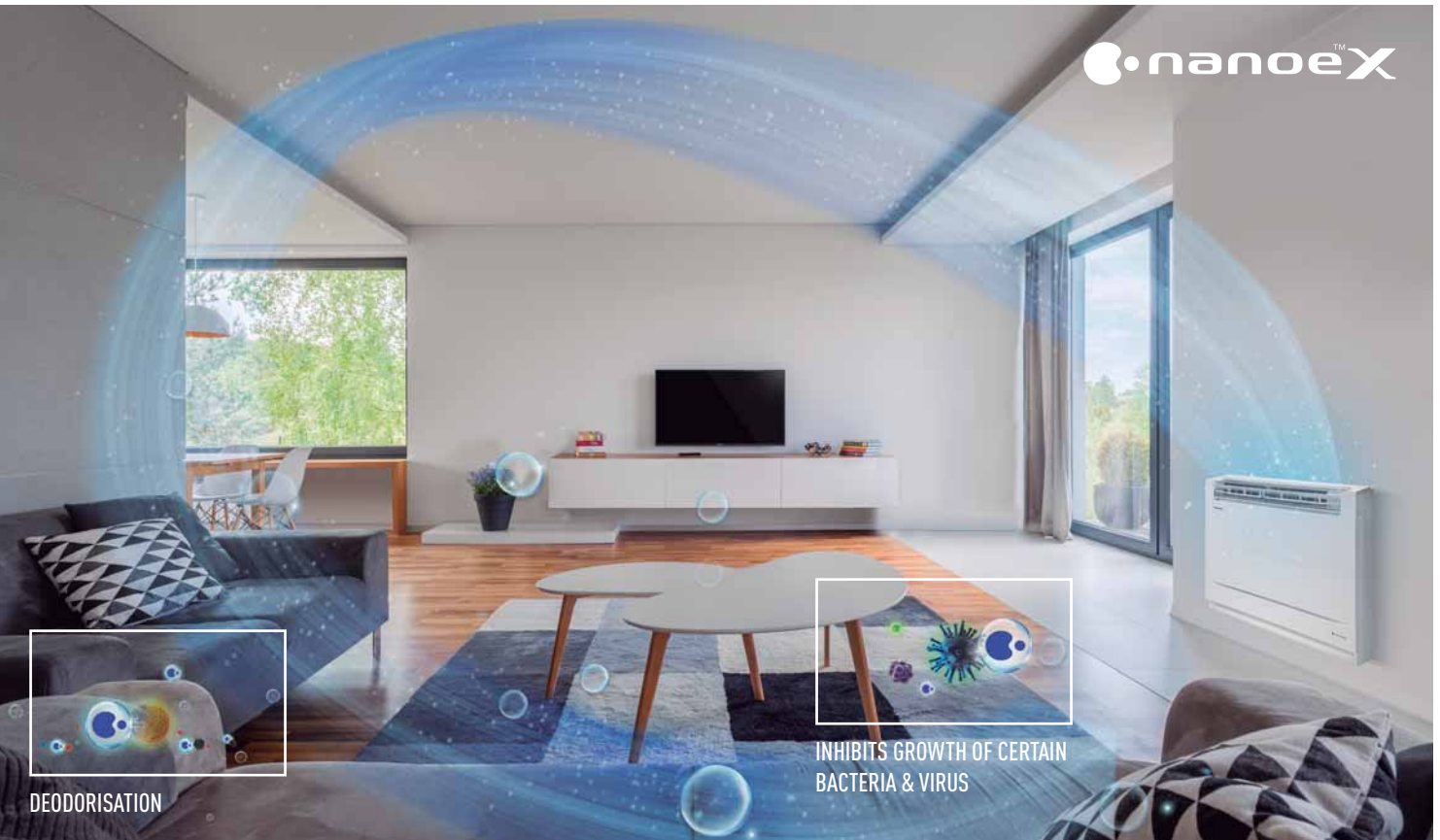

DEODORISATION

INHIBITS GROWTH OF CERTAIN BACTERIA & VIRUS

No matter where you are on planet earth, air is an essential part in your life. We're working to help every person enjoy better health and comfort by nanoe™ air purifier technologies.

## nanoe™ X deodorises and inhibits certain bacteria & viruses

nanoe™ X contains 10X times<sup>1</sup> more OH radicals.

The newly developed nanoe™ X device produces 10x times more OH radicals (4800 billion)<sup>1</sup> than regular nanoe™ device.

Greater amounts of OH radicals contained in nanoe™ X lead to outstanding effects in bacteria, viruses and allergens inhibition as well as deodorisation. A fresher and cleaner home awaits you.

1) Based on Panasonic Survey.

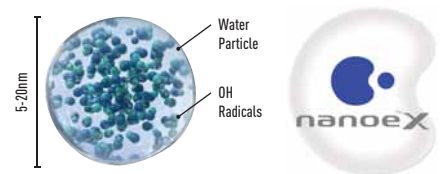

**4800 BILLION**  
**OH RADICALS /**  
**PER SECOND**

## How nanoe™ and nanoe™ X keeps air fresh & clean

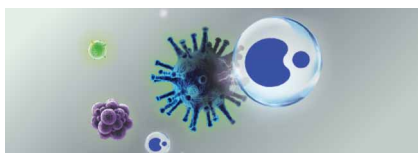

nanoe™ and nanoe™ X reaches bacteria.



OH radicals take away hydrogen from bacteria.



OH radicals transform hydrogen in bacteria to water and inhibit bacterial activity.



# NEW FLOOR CONSOLE TYPE INVERTER+

## • R32 GAS

**New Floor Console with new nanoe™ X air-purifying system: outstanding efficiency A++, comfort (Super Quiet technology only 20dB(A)) and healthy air combined with a breakthrough design**

Double airflow for improved comfort and temperature dispersion: through the top for an efficient cooling mode.



### Technical focus

- **NEW!** New design
- R32 gas is more environmentally friendly than R410A
- A breakthrough design that combines perfectly with the most modern environments. We have selected the best materials and processes for a refined design
- nanoe™ X with nano-technology, nano-sized electrostatic atomised water particles purify the air in the room
- High energy efficiency class A++ SEER and A++ SCOP
- Control your comfort and the power consumption with internet control
- New wireless control

Kit			KIT-Z25-UFE	KIT-Z35-UFE	KIT-Z50-UFE
Cooling capacity	Nominal (Min - Max)	kW	2,50 (0,85 - 3,40)	3,50 (0,85 - 3,80)	5,00 (0,90 - 5,70)
EER <sup>1)</sup>	Nominal (Min - Max)	W/W	4,81 (3,54 - 3,78) A	4,07 (3,54 - 3,73) A	3,60 (3,53 - 3,15) A
<b>SEER <sup>2)</sup></b>		<b>W/W</b>	<b>7,90</b> A++	<b>8,10</b> A++	<b>6,70</b> A++
Pdesign (cooling)		kW	2,50	3,50	5,00
Input power cooling	Nominal (Min - Max)	kW	0,52 (0,24 - 0,90)	0,86 (0,24 - 1,02)	1,39 (0,26 - 1,81)
Annual energy consumption <sup>3)</sup>		kWh/a	111	151	261
Heating capacity	Nominal (Min - Max)	kW	3,40 (0,85 - 5,00)	4,30 (0,85 - 6,00)	5,80 (0,90 - 8,10)
Heating capacity at -7°C		kW	2,88	3,37	5,03
COP <sup>1)</sup>	Nominal (Min - Max)	W/W	4,47 (3,54 - 3,70) A	3,98 (3,54 - 3,43) A	3,74 (3,46 - 3,12) A
<b>SCOP <sup>2)</sup></b>		<b>W/W</b>	<b>4,60</b> A++	<b>4,60</b> A++	<b>4,30</b> A++
Pdesign at -10°C		kW	2,70	3,20	4,40
Input power heating	Nominal (Min - Max)	kW	0,76 (0,24 - 1,35)	1,08 (0,24 - 1,75)	1,55 (0,26 - 2,60)
Annual energy consumption <sup>3)</sup>		kWh/a	822	974	1433
<b>Indoor unit</b>			<b>CS-Z25UFEAW</b>	<b>CS-Z35UFEAW</b>	<b>CS-Z50UFEAW</b>
Air volume	Cool / Heat	m³/min	9,6/9,9	9,9/10,1	11,6/13,2
Moisture removal volume		L/h	1,5	2,0	2,8
Sound pressure <sup>4)</sup>	Cool (Hi / Lo / Q-Lo)	dB(A)	38/25/20	39/26/20	44/31/27
	Heat (Hi / Lo / Q-Lo)	dB(A)	38/25/19	39/26/19	46/33/29
Dimension	HxWxD	mm	600 x 750 x 207	600 x 750 x 207	600 x 750 x 207
Net weight		kg	13	13	13
<b>Outdoor unit</b>			<b>CU-Z25UBEA</b>	<b>CU-Z35UBEA</b>	<b>CU-Z50UBEA</b>
Power source		V	230	230	230
Recommended fuse		A	16	16	16
Connection indoor / outdoor		mm²	—	—	—
Air volume	Cool / Heat	m³/min	28,7/27,2	34,3/33,5	39,7/38,6
Sound pressure <sup>4)</sup>	Cool / Heat (Hi)	dB(A)	46/47	48/48	48/48
Dimension <sup>5)</sup>	HxWxD	mm	542 x 780 x 289	619 x 824 x 299	695 x 875 x 320
Net weight		kg	33	35	43
Piping connections	Liquid pipe	Inch (mm)	1/4 (6,35)	1/4 (6,35)	1/4 (6,35)
	Gas pipe	Inch (mm)	3/8 (9,52)	3/8 (9,52)	1/2 (12,70)
Pipe length range		m	3 - 20	3 - 20	3 - 30
Elevation difference (in/out) <sup>6)</sup>		m	15	15	20
Pipe length for additional gas		m	7,5	7,5	7,5
Additional gas amount		g/m	10	10	15
Refrigerant (R32)		kg/TCO <sub>2</sub> Eq.	0,88/0,594	0,93/0,628	1,13/0,763
Operating range	Cool Min ~ Max	°C	-10 ~ +43	-10 ~ +43	-10 ~ +43
	Heat Min ~ Max	°C	-15 ~ +24	-15 ~ +24	-15 ~ +24

Accessories	
<b>CZ-TACG1</b>	NEW Panasonic WLAN kit for internet control
<b>CZ-CAPRA1</b>	RAC interface adapter for integration into P Link

Accessories	
<b>CZ-RD514C</b>	Wired remote controller for Wall Mounted and Floor Console

1) EER and COP calculation is based in accordance to EN14511. 2) Energy Label Scale from A+++ to D. 3) The annual energy consumption is calculated in accordance to EU/626/2011. 4) The sound pressure of the units shows the value measured of a position 1m in front of the main body. The sound pressure is measured in accordance with Eurovent 6/C/006-97 specification. Q-Lo: Quiet mode. Lo: The lowest fan speed. 5) Add 70mm for piping port. 6) When installing the outdoor unit at a higher position than the indoor unit.



SEER and SCOP: For KIT-Z35-UFE. SUPER QUIET: For KIT-Z25-UFE and KIT-Z35-UFE. INTERNET CONTROL: Optional.

# NEW 4 WAY 60X60 CASSETTE INVERTER

## • R32 GAS



**Specially designed for offices, retail and restaurant applications, this Cassette fits perfectly into 60x60 or 70x70 ceiling grids**

Compact Cassette with high efficiency even at low temperatures, this new Cassette can also be connected to KNX, Modbus, EnOcean interfaces for easy integration with your BMS systems. Interfaces have dry contacts (ON/OFF, error message) to enable easy integration.

Fit Panasonic's Cassette Type, and start to save all year round!

### Technical focus

- R32 gas is more environmentally friendly than R410A
- **NEW** CZ-BT20EW RAL9010 panel
- Cassettes can be controlled by KNX, EnOcean and Modbus
- Designed for easy installation in the standard European 60x60 ceiling grid
- Piping length up to 30m
- Maximum elevation difference up to 20m
- Ultra compact outdoor units for easy installation
- High pressure selector in case of high ceilings (higher than 2,7m)
- Drain pump included (maximum 750mm high)
- Air fresh entry available on the Cassette

KIT			KIT-Z25-UB4	KIT-Z35-UB4	KIT-Z50-UB4	KIT-Z60-UB4
Cooling capacity	Nominal (Min - Max)	kW	2,50 [0,85 - 3,20]	3,50 [0,85 - 4,00]	5,00 [0,90 - 5,80]	6,00 [0,90 - 6,35]
EER <sup>1)</sup>	Nominal (Min - Max)	W/W	4,55 [3,54 - 3,90] A	3,89 [3,54 - 3,39] A	3,25 [3,53 - 3,09] A	2,93 [3,53 - 2,89] C
<b>SEER <sup>2)</sup></b>		<b>W/W</b>	<b>6,30 A++</b>	<b>6,50 A++</b>	<b>6,40 A++</b>	<b>6,20 A++</b>
Pdesign (cooling)		kW	2,50	3,50	5,00	6,00
Input power cooling	Nominal (Min - Max)	kW	0,55 [0,24 - 0,82]	0,90 [0,24 - 1,18]	1,54 [0,26 - 1,88]	2,05 [0,26 - 2,20]
Annual energy consumption <sup>3)</sup>		kWh/a	139	188	273	339
Heating capacity	Nominal (Min - Max)	kW	3,20 [0,85 - 4,80]	4,50 [0,85 - 5,60]	5,60 [0,90 - 7,10]	7,00 [0,90 - 8,00]
Heating capacity at -7°C		kW	2,88	3,37	4,40	5,10
COP <sup>1)</sup>	Nominal (Min - Max)	W/W	4,05 [3,70 - 3,64] A	3,31 [3,70 - 3,20] C	3,03 [3,46 - 2,95] D	2,92 [3,46 - 2,91] D
<b>SCOP <sup>2)</sup></b>		<b>W/W</b>	<b>4,30 A+</b>	<b>4,20 A+</b>	<b>4,30 A+</b>	<b>4,20 A+</b>
Pdesign at -10°C		kW	2,70	3,00	3,80	4,00
Input power heating	Nominal (Min - Max)	kW	0,79 [0,23 - 1,32]	1,36 [0,23 - 1,75]	1,85 [0,26 - 2,41]	2,40 [0,26 - 2,75]
Annual energy consumption <sup>3)</sup>		kWh/a	879	1000	1237	1333
<b>Indoor unit</b>			<b>CS-Z25UB4EAW</b>	<b>CS-Z35UB4EAW</b>	<b>CS-Z50UB4EAW</b>	<b>CS-Z60UB4EAW</b>
<b>Panel</b>			<b>CZ-BT20EW</b>	<b>CZ-BT20EW</b>	<b>CZ-BT20EW</b>	<b>CZ-BT20EW</b>
Air volume	Cool / Heat	m <sup>3</sup> /min	10,5/10,8	10,5/10,8	11,5/11,8	12,4/13,5
Moisture removal volume		L/h	1,5	2,0	2,8	3,3
Sound pressure <sup>4)</sup>	Cool (Hi / Lo / Q-Lo)	dB(A)	34/25/22	34/26/23	37/28/25	42/32/29
	Heat (Hi / Lo / Q-Lo)	dB(A)	35/28/25	35/28/25	38/29/26	43/32/29
Dimension (HxWxD)	Indoor	mm	260x575x575	260x575x575	260x575x575	260x575x575
	Panel	mm	51x700x700	51x700x700	51x700x700	51x700x700
Net weight	Indoor / Panel	kg	18/2,5	18/2,5	18/2,5	18/2,5
<b>Outdoor unit</b>			<b>CU-Z25UBEA</b>	<b>CU-Z35UBEA</b>	<b>CU-Z50UBEA</b>	<b>CU-Z60UBEA</b>
Power source		V	230	230	230	230
Recommended fuse		A	—	—	—	—
Connection indoor / outdoor		mm <sup>2</sup>	—	—	—	—
Air volume	Cool / Heat	m <sup>3</sup> /min	28,7/27,2	34,3/33,5	39,7/38,6	42,6/41,5
Sound pressure <sup>4)</sup>	Cool / Heat (Hi)	dB(A)	46/47	48/48	48/48	49/50
Dimension <sup>5)</sup>	HxWxD	mm	542x780x289	619x824x299	695x875x320	695x875x320
Net weight		kg	33	35	43	43
Piping connections	Liquid pipe	Inch (mm)	1/4 [6,35]	1/4 [6,35]	1/4 [6,35]	1/4 [6,35]
	Gas pipe	Inch (mm)	3/8 [9,52]	3/8 [9,52]	1/2 [12,70]	1/2 [12,70]
Pipe length range		m	3 - 20	3 - 20	3 - 30	3 - 30
Elevation difference (in/out) <sup>6)</sup>		m	15	15	20	20
Pipe length for additional gas		m	7,5	7,5	7,5	7,5
Additional gas amount		g/m	10	10	15	15
Refrigerant (R32)		kg / TCO <sub>2</sub> Eq.	0,88/0,594	0,93/0,628	1,13/0,763	1,13/0,763
Operating range	Cool Min ~ Max	°C	-10 ~ +43	-10 ~ +43	-10 ~ +43	-10 ~ +43
	Heat Min ~ Max	°C	-15 ~ +24	-15 ~ +24	-15 ~ +24	-15 ~ +24

### Accessories

- CZ-TACG1** **NEW** Panasonic WLAN kit for internet control
- CZ-CAPRA1** RAC interface adapter for integration into P Link

### Accessories

- CZ-RD52CP** Wired remote controller for Cassette

1) EER and COP calculation is based in accordance to EN14511. 2) Energy Label Scale from A+++ to D. 3) The annual energy consumption is calculated in accordance to EU/626/2011. 4) The sound pressure of the units shows the value measured of a position 1,5m below the unit. The sound pressure is measured in accordance with Eurovent 6/C/006-97 specification. Q-Lo: Quiet mode. Lo: The lowest fan speed. 5) Add 70mm for piping port. 6) When installing the outdoor unit at a higher position than the indoor unit.



SEER and SCOP: For KIT-Z35-UB4EA. SUPER QUIET: For KIT-Z25-UB4EA. INTERNET CONTROL: Optional.

## NEW LOW STATIC PRESSURE HIDE AWAY INVERTER • R32 GAS

Designed for homes, offices, retail and restaurants, this duct is ideal for small rooms where the air conditioning and the heating should be nicely integrated and where high comfort and efficiency is needed

The duct can also be connected to KNX, Modbus, EnOcean interfaces for easy integration with your BMS systems. This interfaces have dry contacts (ON/OFF, error message) for easy integration.

Splits 1x1

R32

NEW  
18

### Technical focus

- R32 gas is more environmentally friendly than R410A
- Duct type can be controlled by KNX, EnOcean and Modbus
- Eco mode for 20% energy saving
- Extremely compact indoor units without losing static pressure (only 200mm high)
- Weekly timer, 42 settings per week
- Easy check mode for failure detection
- Drain pump included

KIT			KIT-Z25-UD3	KIT-Z35-UD3	KIT-Z50-UD3	KIT-Z60-UD3
Cooling capacity	Nominal (Min - Max)	kW	2,50 (0,85 - 3,20)	3,50 (0,85 - 4,00)	5,10 (0,90 - 5,70)	6,00 (0,90 - 6,50)
EER <sup>1)</sup>	Nominal (Min - Max)	W/W	4,31 (3,54 - 3,76) A	3,85 (3,54 - 3,36) A	3,27 (3,53 - 3,20) A	2,94 (3,53 - 2,83) C
SEER <sup>2)</sup>		W/W	5,90 A+	5,80 A+	5,90 A+	5,60 A+
Pdesign (cooling)		kW	2,50	3,50	5,10	6,00
Input power cooling	Nominal (Min - Max)	kW	0,58 (0,24 - 0,85)	0,91 (0,24 - 1,19)	1,56 (0,26 - 1,78)	2,04 (0,26 - 2,30)
Annual energy consumption <sup>3)</sup>		kWh/a	148	211	303	375
Heating capacity	Nominal (Min - Max)	kW	3,20 (0,85 - 4,60)	4,20 (0,85 - 5,10)	6,10 (0,90 - 7,20)	7,00 (0,90 - 8,00)
Heating capacity at -7°C		kW	2,60	3,00	4,50	5,10
COP <sup>1)</sup>	Nominal (Min - Max)	W/W	4,00 (3,70 - 3,68) A	3,82 (3,70 - 3,59) A	3,35 (3,46 - 3,27) C	3,24 (3,46 - 3,08) C
SCOP <sup>2)</sup>		W/W	4,20 A+	4,10 A+	4,10 A+	4,10 A+
Pdesign at -10°C		kW	2,60	2,80	4,00	4,60
Input power heating	Nominal (Min - Max)	kW	0,80 (0,23 - 1,25)	1,10 (0,23 - 1,42)	1,82 (0,26 - 2,20)	2,16 (0,26 - 2,60)
Annual energy consumption <sup>3)</sup>		kWh/a	867	956	1366	1571
Indoor unit			CS-Z25UD3EAW	CS-Z35UD3EAW	CS-Z50UD3EAW	CS-Z60UD3EAW
External static pressure <sup>4)</sup>	Min - Max	Pa	15 - 45	15 - 45	15 - 50	15 - 50
Air volume	Cool / Heat	m <sup>3</sup> /min	10,5/10,5	11,2/11,2	15,3/15,3	15,7/15,7
Moisture removal volume		L/h	1,5	2,0	2,8	3,3
Sound pressure <sup>5)</sup>	Cool (Hi / Lo / Q-Lo)	dB(A)	33/27/24	33/27/24	39/29/26	41/30/27
	Heat (Hi / Lo / Q-Lo)	dB(A)	35/27/24	35/27/24	39/30/27	41/32/29
Dimension	H x W x D	mm	200 x 750 x 640	200 x 750 x 640	200 x 750 x 640	200 x 750 x 640
Net weight		kg	19	19	19	19
Outdoor unit			CU-Z25UBEA	CU-Z35UBEA	CU-Z50UBEA	CU-Z60UBEA
Power source		V	230	230	230	230
Recommended fuse		A	16	16	16	—
Connection indoor / outdoor		mm <sup>2</sup>	4 x 1,5 to 2,5	4 x 1,5 to 2,5	4 x 1,5 to 2,5	—
Air volume	Cool / Heat	m <sup>3</sup> /min	28,7/27,2	34,3/33,5	39,7/38,6	42,6/41,5
Sound pressure <sup>5)</sup>	Cool / Heat (Hi)	dB(A)	46/47	48/48	48/48	49/50
Dimension <sup>6)</sup>	H x W x D	mm	542 x 780 x 289	619 x 824 x 299	695 x 875 x 320	695 x 875 x 320
Net weight		kg	33	35	43	43
Piping connections	Liquid pipe	Inch (mm)	1/4 (6,35)	1/4 (6,35)	1/4 (6,35)	1/4 (6,35)
	Gas pipe	Inch (mm)	3/8 (9,52)	3/8 (9,52)	1/2 (12,70)	1/2 (12,70)
Pipe length range		m	3 - 20	3 - 20	3 - 30	3 - 30
Elevation difference (in/out) <sup>7)</sup>		m	15	15	20	20
Pipe length for additional gas		m	7,5	7,5	7,5	7,5
Additional gas amount		g/m	10	10	15	15
Refrigerant (R32)		kg/TCO <sub>2</sub> Eq.	0,88/0,594	0,93/0,628	1,13/0,763	1,13/0,763
Operating range	Cool Min ~ Max	°C	-10 ~ +43	-10 ~ +43	-10 ~ +43	-10 ~ +43
	Heat Min ~ Max	°C	-15 ~ +24	-15 ~ +24	-15 ~ +24	-15 ~ +24

#### Accessories

**CZ-TACG1** NEW Panasonic WLAN kit for internet control

#### Accessories

**CZ-CAPRA1** RAC interface adapter for integration into P Link

1) EER and COP calculation is based in accordance to EN14511. 2) Energy Label Scale from A+++ to D. 3) The annual energy consumption is calculated in accordance to EU/626/2011. 4) The specification listed on the table indicates values under the condition of 25Pa (2,5mmAq) which are applied for factory default setting. Change switch on PCB from Hi to Shi to have more than 6,0mmAq. 5) The sound pressure of the units shows the value measured at a position of 1,5m below the unit with 1m duct on the suction side and 2m duct on the discharge side. The sound pressure is measured in accordance with Eurovent 6/C/006-97 specification. 6) Add 100mm for indoor unit or 70mm for outdoor unit for piping port. 7) When installing the outdoor unit at a higher position than the indoor unit. \* Tentative data.



SEER and SCOP: For KIT-Z25-UD3EA. INTERNET CONTROL: Optional.

Rating Conditions: Cooling Indoor 27°C DB / 19°C WB. Cooling Outdoor 35°C DB / 24°C WB. Heating Indoor 20°C DB. Heating Outdoor 7°C DB / 6°C WB. (DB: Dry Bulb; WB: Wet Bulb)  
Specifications subject to change without notice. For detailed information about ErP / Energy Labelling, please visit our websites [www.aircon.panasonic.eu](http://www.aircon.panasonic.eu) or [www.ptc.panasonic.eu](http://www.ptc.panasonic.eu).

# MULTI SPLIT AND FREE MULTI SYSTEM



## Panasonic offers widest range in Multi split systems

2 types of Multi split range from 3,5 to 9,0kW for 5 indoor units with one outdoor unit.

Free Multi Z	New Multi TZ Wall with R32 refrigerant
Full flexibility up to 9,0kW and up to 5 ports with wide range of indoor units including high performance Etherea indoor units, reaching up to A+++ / A++	From 4,1 to 5,2kW for TZ Wall Compact Style unit, reaches A++ / A+

Line up	Refrigerant	Capacities	Indoor unit ports	Efficiency up to	Indoor units				
					Etherea	Compact Style	Floor Console	Cassette	Duct
Multi Z	R32	8 units (3,5 ~ 9,0kW)	2~5	A+++ / A++	Yes	Yes	Yes	Yes	Yes
Multi TZ	R32	3 units (4,1 ~ 5,2kW)	2~3	A++ / A+		Yes			

## Multi split systems

Day & Night	Simultaneous
Ideal for 2 day and night areas. Simultaneous use possible.	When indoor units are most time working at same time.

**UP TO 5  
INDOOR UNITS  
WITH A SINGLE  
OUTDOOR UNIT**

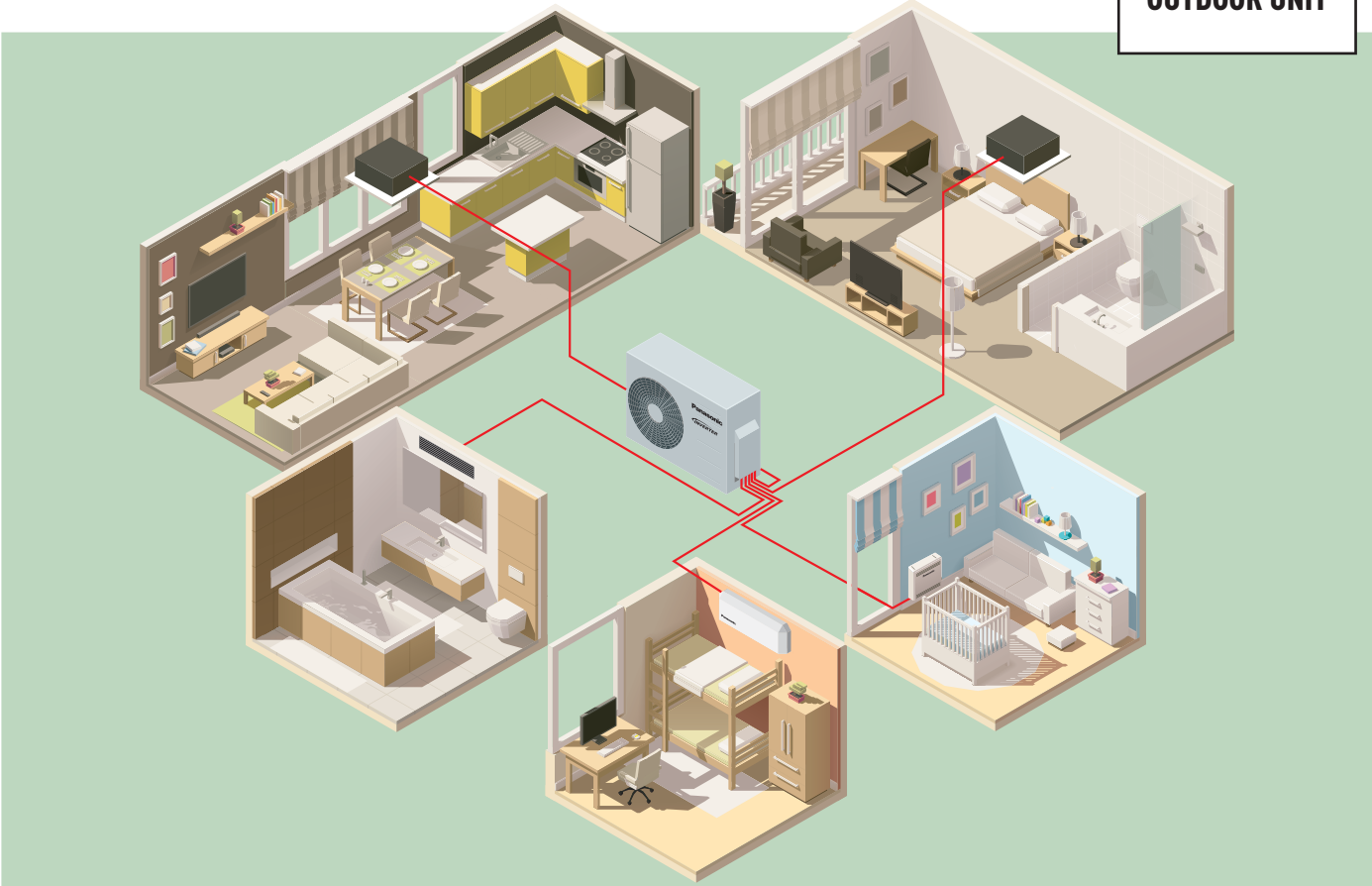

**Why a Multi Split is better than several separate split units**

**Up to 5 indoor units with a single outdoor unit.**

- Just one compact outdoor unit
- Increased comfort in the house since every room has its own indoor unit for heating

- Much more powerful than a single split
- More efficient since the units are always operating at full capacity
- You can connect all types of indoor units, such as wall types and consoles, depending on what suits your house best

**Solution with single split.**

One indoor unit is connected to one outdoor unit. The indoor unit is placed in the main hallway and heats the entire house. Certain rooms may not be perfectly heated, which causes inadequate comfort.

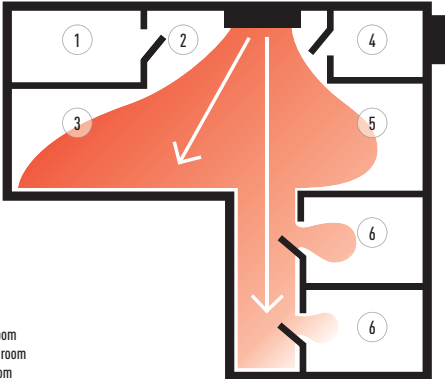

- 1. Laundry room
- 2. Entrance
- 3. Kitchen/dining area
- 4. Bathroom
- 5. Living room
- 6. Bedroom

**Solution with Multi Split.**

With one outdoor unit, you can connect up to five indoor units. There is one indoor unit per room or area. It gives an extreme increase in comfort levels. On the roof, there is only one outdoor unit.

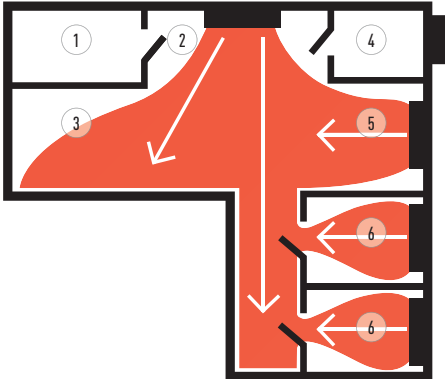



Outdoor unit Free Multi System Z • R32 GAS

System Capacity (Min - Max Indoor Cooling Capacity Nominal)		3,2 to 6,0kW	3,2 to 6,0kW	3,2 to 7,7kW	4,5 to 9,5kW	4,5 to 11,2kW	4,5 to 11,5kW	4,5 to 14,7kW	4,5 to 18,3kW
Unit		CU-2Z35TBE	CU-2Z41TBE	CU-2Z50TBE	CU-3Z52TBE	CU-3Z68TBE	CU-4Z68TBE	CU-4Z80TBE	CU-5Z90TBE
Cooling capacity	Nominal (Min - Max) kW	3,50(1,50-4,50)	4,10(1,50-5,20)	5,00(1,50-5,40)	5,20(1,80-7,30)	6,80(1,90-8,00)	6,80(1,90-8,80)	8,00(3,00-9,20)	9,00(2,90-11,50)
EER <sup>1)</sup>	Nominal (Min - Max) W/W	4,86(6,00-4,09)A	4,56(6,00-3,80)A	4,24(6,00-3,62)A	4,77 A	3,66(7,04-3,38)A	4,39(5,59-3,56)A	4,04(5,66-3,21)A	4,09(5,27-2,98)A
SEER <sup>2)</sup>	W/W	8,50 A+++	8,50 A+++	8,50 A+++	8,50 A+++	8,00 A++	8,00 A++	7,90 A++	8,50 A+++
Pdesign (cooling)	kW	3,50	4,10	5,00	5,20	6,80	6,80	8,00	9,00
Input power cooling	Nominal (Min - Max) kW	0,72(0,25-1,10)	0,90(0,25-1,37)	1,18(0,25-1,49)	1,09(0,36-2,18)	1,86(0,27-2,37)	1,55(0,34-2,47)	1,98(0,53-2,87)	2,20(0,55-3,86)
Annual energy consumption <sup>3)</sup>	kWh/a	144	169	206	214	298	298	990	1100
Heating capacity	Nominal (Min - Max) kW	4,20(1,10-5,60)	4,60(1,10-7,00)	5,60(1,10-7,20)	6,80(1,60-8,30)	8,50(3,30-10,40)	8,50(3,00-10,60)	9,40(4,20-10,60)	10,40(3,40-14,50)
Heating capacity at -7°C	kW	—	—	—	3,95	4,45	4,45	—	—
COP <sup>1)</sup>	Nominal (Min - Max) W/W	4,88(5,24-4,18)A	4,79(5,24-3,91)A	4,63(5,24-4,00)A	4,63(5,00-3,82)A	3,95(5,32-3,64)A	4,47(5,17-3,96)A	4,63(6,00-3,46)A	4,84(6,42-3,42)A
SCOP <sup>2)</sup>	W/W	4,60 A++	4,60 A++	4,60 A++	4,20 A+	4,20 A+	4,20 A+	4,70 A++	4,68 A++
Pdesign at -10°C	kW	3,20	3,50	4,20	5,0	5,20	5,80	6,80	8,50
Input power heating	Nominal (Min - Max) kW	0,86(0,21-1,34)	0,96(0,21-1,79)	1,21(0,21-1,80)	1,47(0,32-2,17)	2,15(0,62-2,86)	1,90(0,58-2,68)	2,03(0,70-3,06)	2,15(0,53-4,24)
Annual energy consumption <sup>3)</sup>	kWh/a	974	1065	1278	1667	1733	1933	2026	2543
Current	Cool / Heat A	3,35/4,00	4,15/4,45	5,35/5,50	5,00/6,70	8,40/9,70	7,00/8,60	9,50/9,50	10,50/10,10
Power source	V	230	230	230	230	230	230	230	230
Recommended fuse	A	16	16	16	16	16	20	20	25
Recommended power cable section	mm <sup>2</sup>	2,5	2,5	2,5	2,5	2,5	2,5	2,5	3,5
Sound pressure <sup>4)</sup>	Cool / Heat (Hi) dB(A)	48/50	48/50	50/52	47/48	51/52	49/50	51/52	53/54
Dimension <sup>5)</sup>	H x W x D mm	619 x 824 x 299	619 x 824 x 299	619 x 824 x 299	795 x 875 x 320	795 x 875 x 320	795 x 875 x 320	999 x 940 x 340	999 x 940 x 340
Net weight	kg	39	39	39	71	71	72	80	81
Piping connections	Liquid pipe Inch (mm)	1/4(6,35)	1/4(6,35)	1/4(6,35)	1/4(6,35)	1/4(6,35)	1/4(6,35)	1/4(6,35)	1/4(6,35)
	Gas pipe Inch (mm)	3/8(9,52)	3/8(9,52)	3/8(9,52)	3/8(9,52)	3/8(9,52)	3/8(9,52)	3/8(9,52)	3/8(9,52)
Pipe length range total <sup>6)</sup>	m	6-30	6-30	6-30	6-50	6-60	6-60	6-70	6-80
Pipe length range to one unit	m	3-20	3-20	3-20	3-25	3-25	3-25	3-25	3-25
Elevation difference (in/out)	m	10	10	10	15	15	15	15	15
Pipe length for additional gas	m	20	20	20	30	30	30	45	45
Additional gas amount	g/m	15	15	15	20	20	20	20	20
Refrigerant (R32)	kg/TCO <sub>2</sub> Eq.	1,12/0,756	1,12/0,756	1,12/0,756	2,10/1,418	2,10/1,418	2,10/1,418	2,72/1,836	2,72/1,836
Operating range	Cool Min ~ Max °C	-10 ~ +46	-10 ~ +46	-10 ~ +46	-10 ~ +46	-10 ~ +46	-10 ~ +46	-10 ~ +46	-10 ~ +46
	Heat Min ~ Max °C	-15 ~ +24	-15 ~ +24	-15 ~ +24	-15 ~ +24	-15 ~ +24	-15 ~ +24	-15 ~ +24	-15 ~ +24

1) EER and COP calculation is based in accordance to EN14511. 2) Energy Label Scale from A+++ to D. 3) The annual energy consumption is calculated in accordance to EU/626/2011. 4) The sound pressure of the units shows the value measured of a position 1m in front of the main body and 0,8m below the unit. The sound pressure is measured in accordance with Eurovent 6/C/006-97 specification. 5) Add 70 or 95mm for piping port. 6) Minimum piping length is 3 meters per indoor unit. Minimum quantity of connection: 2 indoor units.

Possible outdoor / indoor units combinations • R32 GAS

	Etherea Silver	Etherea Pure White Matt	Wall Mounted TZ Compact Style	NEW Floor Console*	NEW 4 Way 60x60 Cassette	NEW Low Static Pressure Hide Away
	16 20 25 35 42 50 60 71	16 20 25 35 42 50 60 71	16 20 25 35 42 50 60 71	16 20 25 35 42 50 60 71	16 20 25 35 42 50 60 71	16 20 25 35 42 50 60 71
CU-2Z35TBE // 3,2 - 6,0kW // 2 Rooms	✓ ✓	✓ ✓ ✓	✓ ✓ ✓	✓ ✓ ✓	✓ ✓ ✓	✓ ✓ ✓
CU-2Z41TBE // 3,2 - 6,0kW // 2 Rooms	✓ ✓	✓ ✓ ✓	✓ ✓ ✓	✓ ✓ ✓	✓ ✓ ✓	✓ ✓ ✓
CU-2Z50TBE // 3,2 - 7,7kW // 2 Rooms	✓ ✓ ✓ ✓ <sup>1)</sup>	✓ ✓ ✓ ✓ <sup>1)</sup>	✓ ✓ ✓ ✓ <sup>1)</sup>	✓ ✓ ✓ ✓ <sup>1)</sup>	✓ ✓ ✓ ✓ <sup>1)</sup>	✓ ✓ ✓ ✓ <sup>1)</sup>
CU-3Z52TBE // 4,5 - 9,5kW // 3 Rooms	✓ ✓ ✓ ✓ <sup>1)</sup>	✓ ✓ ✓ ✓ <sup>1)</sup>	✓ ✓ ✓ ✓ <sup>1)</sup>	✓ ✓ ✓ ✓ <sup>1)</sup>	✓ ✓ ✓ ✓ <sup>1)</sup>	✓ ✓ ✓ ✓ <sup>1)</sup>
CU-3Z68TBE // 4,5 - 11,2kW // 3 Rooms	✓ ✓ ✓ ✓ <sup>1)</sup>	✓ ✓ ✓ ✓ <sup>1)</sup>	✓ ✓ ✓ ✓ <sup>1)</sup>	✓ ✓ ✓ ✓ <sup>1)</sup>	✓ ✓ ✓ ✓ <sup>1)</sup>	✓ ✓ ✓ ✓ <sup>1)</sup>
CU-4Z68TBE // 4,5 - 11,5kW // 4 Rooms	✓ ✓ ✓ ✓ <sup>1)</sup>	✓ ✓ ✓ ✓ <sup>1)</sup>	✓ ✓ ✓ ✓ <sup>1)</sup>	✓ ✓ ✓ ✓ <sup>1)</sup>	✓ ✓ ✓ ✓ <sup>1)</sup>	✓ ✓ ✓ ✓ <sup>1)</sup>
CU-4Z80TBE // 4,5 - 14,7kW // 4 Rooms	✓ ✓ ✓ ✓ <sup>1)</sup>	✓ ✓ ✓ ✓ <sup>1)</sup>	✓ ✓ ✓ ✓ <sup>1)</sup>	✓ ✓ ✓ ✓ <sup>1)</sup>	✓ ✓ ✓ ✓ <sup>1)</sup>	✓ ✓ ✓ ✓ <sup>1)</sup>
CU-5Z90TBE // 4,5 - 18,3kW // 5 Rooms	✓ ✓ ✓ ✓ <sup>1)</sup>	✓ ✓ ✓ ✓ <sup>1)</sup>	✓ ✓ ✓ ✓ <sup>1)</sup>	✓ ✓ ✓ ✓ <sup>1)</sup>	✓ ✓ ✓ ✓ <sup>1)</sup>	✓ ✓ ✓ ✓ <sup>1)</sup>

1) A CZ-MA1P pipe reducer is needed on the 42 and 50, a CZ-MA2P pipe expander is needed on the 60 and 71, and CZ-MA3P pipe reducer on the 71. \* Compatible only with 2 ports Outdoor CU-2Z35TBE / CU-2Z41TBE / CU-2Z50TBE.

Outdoor Multi combination model

	Model
CS-MZ16TKE / CS-MTZ16TKE CS-XZ20TKEW / CS-Z20TKEW / CS-TZ20TKEW-1 / CS-MZ20UFEA / CS-MZ20UB4EA / CS-MZ20UD3EA CS-XZ25TKEW / CS-Z25TKEW / CS-TZ25TKEW-1 / CS-Z25UFEAW / CS-Z25UB4EAW / CS-Z25UD3EAW CS-XZ35TKEW / CS-Z35TKEW / CS-TZ35TKEW-1 / CS-Z35UFEAW / CS-Z35UB4EAW / CS-Z35UD3EAW	CU-2Z35TBE / CU-2Z41TBE / CU-2Z50TBE / CU-3Z52TBE / CU-3Z68TBE / CU-4Z68TBE / CU-4Z80TBE / CU-5Z90TBE
CS-Z42TKEW / CS-TZ42TKEW-1 CS-XZ50TKEW / CS-Z50TKEW / CS-TZ50TKEW / CS-Z50UFEAW / CS-Z50UB4EAW / CS-Z50UD3EAW	CU-2Z50TBE / CU-3Z52TBE / CU-3Z68TBE / CU-4Z68TBE / CU-4Z80TBE / CU-5Z90TBE
CS-TZ60TKEW / CS-Z60UB4EAW / CS-Z60UD3EAW	CU-3Z68TBE / CU-4Z68TBE / CU-4Z80TBE / CU-5Z90TBE
CS-Z71TKEW / CS-TZ71TKEW	CU-4Z80TBE / CU-5Z90TBE

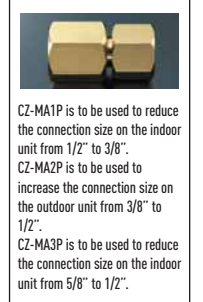

CZ-MA1P is to be used to reduce the connection size on the indoor unit from 1/2" to 3/8". CZ-MA2P is to be used to increase the connection size on the outdoor unit from 3/8" to 1/2". CZ-MA3P is to be used to reduce the connection size on the indoor unit from 5/8" to 1/2".

\* For CZ-MA3P necessary to use adaptor CZ-MA2P too.

Free Multi System Z

R32



IF DESIGN AWARD 2017: Etherea White awarded with the prestigious IF Design Award 2017. INTERNET CONTROL: Optional.



Wall Mounted Etherea	Indoor unit Silver	Indoor unit Pure White Matt	Cooling capacity kW / kCal/h	Heating capacity kW / kCal/h	Connection in. / out.	Sound pressure <sup>1)</sup>		Dimension / Net weight		Piping connections	
						Cool — Heat (Hi/Lo/S-Lo)		HxWxD		Liquid / Gas pipe	
						dB(A)		mm / kg		Inch (mm)	
1,6kW	—	CS-MZ16TKE	1,60/1380	2,60/2240	4x1,5	38/26/21 — 39/27/21		295x919x194/9		1/4(6,35)/3/8(9,52)	
2,0kW	CS-XZ20TKEW	CS-Z20TKEW	2,00/1720	3,20/2750	4x1,5	39/26/21 — 40/27/21		295x919x194/9		1/4(6,35)/3/8(9,52)	
2,5kW	CS-XZ25TKEW	CS-Z25TKEW	2,50/2150	3,60/3100	4x1,5	41/27/21 — 43/29/21		295x919x194/10		1/4(6,35)/3/8(9,52)	
3,5kW	CS-XZ35TKEW	CS-Z35TKEW	3,20/2750	4,50/3870	4x1,5	44/30/21 — 45/35/21		295x919x194/10		1/4(6,35)/3/8(9,52)	
4,2kW	—	CS-Z42TKEW	4,00/3440	5,60/4820	4x1,5	44/33/27 — 45/37/31		295x919x194/10		1/4(6,35)/1/2(12,70)	
5,0kW	CS-XZ50TKEW	CS-Z50TKEW	5,00/4300	6,80/5850	4x1,5	44/39/32 — 46/39/32		302x1120x236/12		1/4(6,35)/1/2(12,70)	
7,1kW	—	CS-Z71TKEW	7,10/6110	8,60/7395	—	49/40/32 — 49/40/32		302x1120x236/13		1/4(6,35)/5/8(15,88)	



Wall Mounted TZ Compact Style	Indoor unit	Cooling capacity kW / kCal/h	Heating capacity kW / kCal/h	Connection in. / out.	Sound pressure <sup>1)</sup>		Dimension / Net weight		Piping connections		
					Cool — Heat (Hi/Lo/S-Lo)		HxWxD		Liquid / Gas pipe		
						dB(A)		mm / kg		Inch (mm)	
1,60kW	CS-MTZ16TKE	1,60/1380	2,60/2240	4x1,5	38/27/22 — 39/28/24		290x799x197/8		1/4(6,35)/3/8(9,52)		
2,00kW	CS-TZ20TKEW-1	2,00/1720	3,20/2750	4x1,5	39/27/22 — 40/28/24		290x799x197/8		1/4(6,35)/3/8(9,52)		
2,50kW	CS-TZ25TKEW-1	2,50/2150	3,60/3100	4x1,5	42/28/22 — 42/29/24		290x799x197/8		1/4(6,35)/3/8(9,52)		
3,50kW <sup>2)</sup>	CS-TZ35TKEW-1	3,50/3010	4,50/3870	4x1,5	44/32/22 — 44/35/24		290x799x197/8		1/4(6,35)/3/8(9,52)		
4,20kW	CS-TZ42TKEW-1	4,20/3610	5,00/4300	4x1,5	44/33/31 — 46/37/30		290x799x197/8		1/4(6,35)/3/8(9,52)		
5,00kW	CS-TZ50TKEW	5,00/4300	5,30/4558	4x1,5	44/39/36 — 46/39/36		302x1102x244/12		1/4(6,35)/3/8(9,52)		
6,00kW	CS-TZ60TKEW	6,00/5160	8,50/7310	4x1,5	44/39/36 — 47/39/36		302x1102x244/12		1/4(6,35)/1/2(12,70)		
7,10kW	CS-TZ71TKEW	7,10/6110	8,70/7482	4x1,5	49/40/37 — 49/40/37		302x1102x244/13		1/4(6,35)/1/2(12,70)		



NEW Floor Console <sup>3) *</sup>	Indoor	Cooling capacity kW / kCal/h	Heating capacity kW / kCal/h	Connection in. / out.	Sound pressure <sup>1)</sup>		Dimension / Net weight		Piping connections		
					Cool — Heat (Hi/Lo/S-Lo)		HxWxD		Liquid / Gas pipe		
						dB(A)		mm / kg		Inch (mm)	
2,00kW	CS-MZ20UFEA	2,00/1720	3,20/2750	4x1,5	39/27/22 — 39/27/21		600x750x207/13		1/4(6,35)/3/8(9,52)		
2,50kW	CS-Z25UFEAW	2,50/2150	3,60/3100	4x1,5	40/27/22 — 40/27/21		600x750x207/13		1/4(6,35)/3/8(9,52)		
3,50kW <sup>2)</sup>	CS-Z35UFEAW	3,50/3010	4,50/3870	4x1,5	41/28/22 — 41/28/21		600x750x207/13		1/4(6,35)/3/8(9,52)		
5,00kW	CS-Z50UFEAW	5,00/4300	5,30/4558	4x1,5	44/33/29 — 48/35/31		600x750x207/13		1/4(6,35)/3/8(9,52)		



NEW CZ-BT20EW RAL9010 panel for 4 Way 60x60 Cassette (sold separately)



NEW 4 Way 60x60 Cassette*	Indoor / Panel	Cooling capacity kW / kCal/h	Heating capacity kW / kCal/h	Connection in. / out.	Sound pressure <sup>1)</sup>		Dimension / Net weight		Piping connections		
					Cool — Heat (Hi/Lo/S-Lo)		Indoor HxWxD		Liquid / Gas pipe		
						dB(A)		mm / kg		Inch (mm)	
2,00kW	CS-MZ20UB4EA / CZ-BT20EW	2,00/1720	3,20/2750	4x1,5	35/27/24 — 36/30/27		260x575x575/18 51x700x700/2,5		1/4(6,35)/3/8(9,52)		
2,50kW	CS-Z25UB4EAW / CZ-BT20EW	2,50/2150	3,60/3100	4x1,5	36/27/24 — 37/30/27		260x575x575/18 51x700x700/2,5		1/4(6,35)/3/8(9,52)		
3,50kW <sup>2)</sup>	CS-Z35UB4EAW / CZ-BT20EW	3,50/3010	4,50/3870	4x1,5	36/28/25 — 37/30/27		260x575x575/18 51x700x700/2,5		1/4(6,35)/3/8(9,52)		
5,00kW <sup>4)</sup>	CS-Z50UB4EAW / CZ-BT20EW	5,00/4300	6,80/5850	4x1,5	39/30/27 — 40/31/28		260x575x575/18 51x700x700/2,5		1/4(6,35)/3/8(9,52)		
6,00kW	CS-Z60UB4EAW / CZ-BT20EW	6,00/5160	8,50/7310	4x1,5	44/34/31 — 45/34/31		260x575x575/18 51x700x700/2,5		1/4(6,35)/1/2(12,70)		



NEW Low Static Pressure Hide Away*	Indoor	Cooling capacity kW / kCal/h	Heating capacity kW / kCal/h	Connection in. / out.	Sound pressure <sup>1)</sup>		Dimension / Net weight		Piping connections		
					Cool — Heat (Hi/Lo/S-Lo)		HxWxD		Liquid / Gas pipe		
						dB(A)		mm / kg		Inch (mm)	
2,00kW	CS-MZ20UD3EA	2,00/1720	3,20/2750	4x1,5	34/29/26 — 36/29/26		200x750x640/19		1/4(6,35)/3/8(9,52)		
2,50kW	CS-Z25UD3EAW	2,50/2150	3,60/3100	4x1,5	35/29/26 — 37/29/26		200x750x640/19		1/4(6,35)/3/8(9,52)		
3,50kW <sup>2)</sup>	CS-Z35UD3EAW	3,50/3010	4,50/3870	4x1,5	35/29/26 — 37/29/26		200x750x640/19		1/4(6,35)/3/8(9,52)		
5,00kW <sup>4)</sup>	CS-Z50UD3EAW	5,00/4300	6,80/5850	4x1,5	41/31/28 — 41/32/29		200x750x640/19		1/4(6,35)/3/8(9,52)		
6,00kW	CS-Z60UD3EAW	6,00/5160	8,50/7310	4x1,5	43/32/29 — 43/34/31		200x750x640/19		1/4(6,35)/1/2(12,70)		

1) The sound pressure of the units shows the value measured of a position 1m in front of the main body. The sound pressure is measured in accordance with Eurovent 6/C/006-97 specification. 2) The heating capacity is 4,20kW connected to a CU-Z235TBE. 3) Compatible only with 2 ports Outdoor CU-Z235TBE / CU-Z241TBE / CU-Z250TBE. 4) The heating capacity is 5,30kW connected to a CU-Z250TBE. \* Tentative data.



**NEW Outdoor unit Multi Wall TZ • R32 GAS**

System Capacity			3,2 ~ 6,0kW	3,2 ~ 7,7kW	4,5 ~ 9,5kW
Unit			CU-2TZ41TBE	CU-2TZ50TBE	CU-3TZ52TBE
Cooling capacity	Nominal (Min - Max)	kW	4,10 (1,50 - 4,70)	5,00 (1,50 - 5,40)	5,20 (1,80 - 6,60)
EER <sup>1)</sup>	Nominal (Min - Max)	W/W	4,14 (5,56 - 3,41) A	3,85 (5,56 - 3,33) A	4,52 (3,67 - 5,00) A
SEER <sup>2)</sup>	W/W		<b>7,10 A++</b>	<b>7,00 A++</b>	<b>7,60 A++</b>
Pdesign (cooling)		kW	4,10	5,00	5,20
Input power cooling	Nominal (Min - Max)	kW	0,99 (0,27 - 1,38)	1,30 (0,27 - 1,62)	1,15 (0,36 - 1,80)
Annual energy consumption <sup>3)</sup>		kWh/a	202	250	239
Heating capacity	Nominal (Min - Max)	kW	4,40 (1,10 - 6,30)	5,70 (1,10 - 6,40)	6,80 (1,60 - 7,50)
Heating capacity at -7°C		kW	—	—	—
COP <sup>1)</sup>	Nominal (Min - Max)	W/W	4,44 (5,00 - 3,54) A	4,35 (5,00 - 3,62) A	4,28 (3,87 - 5,00) A
SCOP <sup>2)</sup>	W/W		<b>4,30 A+</b>	<b>4,20 A+</b>	<b>4,20 A+</b>
Pdesign at -10°C		kW	3,50	4,50	5,00
Input power heating	Nominal (Min - Max)	kW	0,99 (0,22 - 1,78)	1,31 (0,22 - 1,77)	1,59 (0,32 - 1,94)
Annual energy consumption <sup>3)</sup>		kWh/a	1139	1500	1667
Current	Cool / Heat	A	4,60 / 4,60	6,00 / 6,00	5,30 / 7,30
Power source		V	230	230	230
Sound pressure <sup>4)</sup>	Cool / Heat (Hi)	dB(A)	48 / 50	50 / 52	48 / 48
Dimension <sup>5)</sup>	H x W x D	mm	542 x 780 x 289	542 x 780 x 289	795 x 875 x 320
Net weight		kg	35	35	71
Piping connections	Liquid pipe	Inch (mm)	1/4 (6,35)	1/4 (6,35)	1/4 (6,35)
	Gas pipe	Inch (mm)	3/8 (9,52)	3/8 (9,52)	3/8 (9,52)
Pipe length range total		m	6 ~ 30	6 ~ 30	6 ~ 50
Pipe length range to one unit		m	3 ~ 20	3 ~ 20	3 ~ 25
Elevation difference (in/out)		m	10	10	15
Pipe length for additional gas		m	20	20	30
Additional gas amount		g/m	15	15	20
Refrigerant (R32)		kg / TCO <sub>2</sub> Eq.	0,9 / 0,6075	0,9 / 0,6075	2,1 / 1,4175
Operating range	Cool Min ~ Max	°C	-10 ~ +46	-10 ~ +46	-10 ~ +46
	Heat Min ~ Max	°C	-15 ~ +24	-15 ~ +24	-15 ~ +24

1) EER and COP calculation is based in accordance to EN14511. 2) Energy Label Scale from A+++ to D. 3) The annual energy consumption is calculated in accordance to EU/626/2011. 4) The sound pressure of the units shows the value measured of a position 1m in front of the main body and 0,8m below the unit. The sound pressure is measured in accordance with Eurovent 6/C/006-97 specification. 5) Add 70 or 95mm for piping port. Minimum quantity of connection: 2 indoor units.

**Possible outdoor / indoor units combinations • R32 GAS**

**Wall Mounted TZ Compact Style**



	16	20	25	35	42	50
CU-2TZ41TBE // 3,2 ~ 6,0kW // 2 Rooms	✓	✓	✓	✓		
CU-2TZ50TBE // 3,2 ~ 7,7kW // 2 Rooms	✓	✓	✓	✓	✓	✓
CU-3TZ52TBE // 4,5 ~ 9,5kW // 3 Rooms	✓	✓	✓	✓	✓	✓



Wall Mounted TZ Compact Style	Indoor unit	Cooling capacity	Heating capacity	Connection	Sound pressure <sup>1)</sup>		Dimension / Net weight	Piping connections	
					Cool — Heat (Hi/Lo/S-Lo)	dB(A)		H x W x D	Liquid / Gas pipe
1,6kW	CS-MTZ16TKE	1,60 / 1380	2,60 / 2240	4 x 1,5	38 / 27 / 22 — 39 / 28 / 24		290 x 799 x 197 / 8	1/4 (6,35) / 3/8 (9,52)	
2,0kW	CS-TZ20TKEW-1	2,00 / 1720	3,20 / 2750	4 x 1,5	39 / 27 / 22 — 40 / 28 / 24		290 x 799 x 197 / 8	1/4 (6,35) / 3/8 (9,52)	
2,5kW	CS-TZ25TKEW-1	2,50 / 2150	3,60 / 3100	4 x 1,5	42 / 28 / 22 — 42 / 29 / 24		290 x 799 x 197 / 8	1/4 (6,35) / 3/8 (9,52)	
3,5kW	CS-TZ35TKEW-1	3,50 / 3010	4,50 / 3870	4 x 1,5	44 / 32 / 22 — 44 / 35 / 24		290 x 799 x 197 / 8	1/4 (6,35) / 3/8 (9,52)	
4,2kW	CS-TZ42TKEW-1	4,20 / 3610	5,00 / 4300	4 x 1,5	44 / 33 / 31 — 46 / 37 / 30		290 x 799 x 197 / 8	1/4 (6,35) / 1/2 (12,70)	
5,0kW	CS-TZ50TKEW	5,00 / 4300	5,30 / 4558	4 x 1,5	44 / 39 / 36 — 46 / 39 / 36		302 x 1102 x 244 / 12	1/4 (6,35) / 1/2 (12,70)	

1) The sound pressure of the units shows the value measured of a position 1m in front of the main body. The sound pressure is measured in accordance with Eurovent 6/C/006-97 specification.



## Multi Split System

R32



INTERNET CONTROL: Optional. IF DESIGN AWARD 2017: Ethena White awarded with the prestigious IF Design Award 2017.



## Ethena Multi Split Inverter+ • R32 GAS

Tentative data



















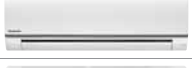
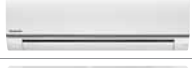

			Day & Night					
Rooms			2 Rooms			3 Rooms		
Kit Silver			KIT-2XZ2525-TBE	KIT-2XZ2035-TBE	KIT-2XZ2535-TBE	KIT-3XZ202035-TBE	KIT-3XZ252535-TBE	
Indoor unit Silver			CS-XZ25TKEW CS-XZ25TKEW	CS-XZ35TKEW CS-XZ20TKEW	CS-XZ35TKEW CS-XZ25TKEW	CS-XZ35TKEW CS-XZ20TKEW CS-XZ20TKEW	CS-XZ35TKEW CS-XZ25TKEW CS-XZ25TKEW	
Kit Pure White Matt			KIT-2Z2525-TBE	KIT-2Z2035-TBE	KIT-2Z2535-TBE	KIT-3Z202035-TBE	KIT-3Z252535-TBE	
Indoor unit Pure White Matt			CS-Z25TKEW CS-Z25TKEW	CS-Z35TKEW CS-Z20TKEW	CS-Z35TKEW CS-Z25TKEW	CS-Z35TKEW CS-Z20TKEW CS-Z20TKEW	CS-Z35TKEW CS-Z25TKEW CS-Z25TKEW	
Outdoor unit			CU-2Z41TBE	CU-2Z41TBE	CU-2Z41TBE	CU-3Z52TBE	CU-3Z52TBE	
Cooling capacity	Nominal (Min - Max)	kW	2,50 (1,10 - 3,50)	4,10 (1,50 - 5,20)	4,10 (1,50 - 5,20)	5,20 (1,80 - 7,30)	5,20 (1,80 - 7,30)	
EER		W/W	3,73A	4,56A	4,56A	4,48A	4,48A	
SEER		W/W						
Heating capacity	Nominal (Min - Max)	kW	3,60 (0,70 - 5,50)	4,60 (1,10 - 7,00)	4,60 (1,10 - 7,00)	6,80 (1,60 - 8,30)	6,80 (1,60 - 8,30)	
COP		W/W	3,50B	4,84A	4,84A	4,79A	4,79A	
SCOP		W/W						
Indoor dimension	(HxWxD)	mm	295x919x194	295x919x194	295x919x194	295x919x194	295x919x194	
Indoor net weight		kg	10	10 (9 for Z20)	10	10 (9 for Z20)	10	























			Simultaneous					
Rooms			2 Rooms			3 Rooms		
Kit Silver			KIT-2XZ2525-TKE	KIT-2XZ2035-TKE	KIT-2XZ2535-TKE	KIT-3XZ202035-TKE	KIT-3XZ252535-TKE	
Indoor unit Silver			CS-XZ25TKEW CS-XZ25TKEW	CS-XZ35TKEW CS-XZ20TKEW	CS-XZ35TKEW CS-XZ25TKEW	CS-XZ35TKEW CS-XZ20TKEW CS-XZ20TKEW	CS-XZ35TKEW CS-XZ25TKEW CS-XZ25TKEW	
Kit Pure White Matt			KIT-2Z2525-TKE	KIT-2Z2035-TKE	KIT-2Z2535-TKE	KIT-3Z202035-TKE	KIT-3Z252535-TKE	
Indoor unit Pure White Matt			CS-Z25TKEW CS-Z25TKEW	CS-Z35TKEW CS-Z20TKEW	CS-Z35TKEW CS-Z25TKEW	CS-Z35TKEW CS-Z20TKEW CS-Z20TKEW	CS-Z35TKEW CS-Z25TKEW CS-Z25TKEW	
Outdoor unit			CU-2Z50TBE	CU-2Z50TBE	CU-2Z50TBE	CU-3Z68TBE	CU-3Z68TBE	
Cooling capacity	Nominal (Min - Max)	kW	5,00 (1,50 - 5,40)	5,00 (1,50 - 5,40)	5,00 (1,50 - 5,40)	6,80 (1,90 - 8,00)	6,80 (1,90 - 8,00)	
EER		W/W	4,24A	4,24A	4,24A	3,56A	3,56A	
SEER		W/W	8,50 <b>A+++</b>					
Heating capacity	Nominal (Min - Max)	kW	5,60 (1,10 - 7,20)	5,40 (1,10 - 7,20)	5,40 (1,10 - 7,20)	8,50 (3,30 - 10,40)	8,50 (3,30 - 10,40)	
COP		W/W	4,63A	4,63A	4,63A	4,09A	4,09A	
SCOP		W/W	4,60 <b>A+++</b>					
Indoor dimension	(HxWxD)	mm	295x919x194	295x919x194	295x919x194	295x919x194	295x919x194	
Indoor net weight		kg	10	10 (9 for Z20)	10	10 (9 for Z20)	10	











Rating Conditions: Cooling Indoor 27°C DB / 19°C WB. Cooling Outdoor 35°C DB / 24°C WB. Heating Indoor 20°C DB. Heating Outdoor 7°C DB / 6°C WB. (DB: Dry Bulb; WB: Wet Bulb)  
 Specifications subject to change without notice. For detailed information about ErP / Energy Labelling, please visit our websites [www.aircon.panasonic.eu](http://www.aircon.panasonic.eu) or [www.ptc.panasonic.eu](http://www.ptc.panasonic.eu).

# DOMESTIC AIR CONDITIONER RANGE R410A















Page	1x1 Kits	2,0kW	2,5kW	3,5kW
P. 116	Wall Mounted Etherea Inverter+ Silver • R410A GAS	 KIT-XE7-SKE	 KIT-XE9-SKE	 KIT-XE12-SKE
P. 116	Wall Mounted Etherea Inverter+ Matt Pearl White • R410A GAS	 KIT-E7-SKEM	 KIT-E9-SKEM	 KIT-E12-SKEM
P. 117	Wall Mounted TE Compact Style • R410A GAS	 KIT-TE20-TKE	 KIT-TE25-TKE	 KIT-TE35-TKE
P. 118	<b>NEW</b> Wall Mounted FE Type Standard Inverter • R410A GAS		 KIT-FE25-UKE	 KIT-FE35-UKE
P. 119	Wall Mounted BE Type Standard Inverter • R410A GAS		 KIT-BE25-TKE-1	 KIT-BE35-TKE-1
P. 120	Wall Mounted DE Type Standard Inverter • R410A GAS		 KIT-DE25-TKE-1	 KIT-DE35-TKE-1
P. 121	Wall Mounted Professional Inverter -20°C • R410A GAS		 KIT-E9-PKEA	 KIT-E12-PKEA
P. 123	Floor Console Type Inverter+ • R410A GAS		 KIT-E9-PFE	 KIT-E12-PFE
P. 124	4-Way 60x60 Cassette Standard Inverter • R410A GAS		 KIT-E9-PB4EA	 KIT-E12-PB4EA
P. 125	Low Static Pressure Hide Away Standard Inverter • R410A GAS		 KIT-E9-PD3EA	 KIT-E12-QD3EA

















Page	Free Multi	1,6kW	2,0kW	2,5kW	3,5kW
P. 127	Etherea Silver		 CS-XZ20TKEW	 CS-XZ25TKEW	 CS-XZ35TKEW
P. 127	Etherea Pure White Matt	 CS-MZ16TKE	 CS-Z20TKEW	 CS-Z25TKEW	 CS-Z35TKEW
P. 127	TZ Compact Style	 CS-MZ16TKE	 CS-TZ20TKEW-1	 CS-TZ25TKEW-1	 CS-TZ35TKEW-1
P. 127	TE Compact Style		 CS-TE20TKEW	 CS-TE25TKEW	 CS-TE35TKEW
P. 127	<b>NEW</b> Floor Console Type		 CS-MZ20UFEA	 CS-Z25UFEAW	 CS-Z35UFEAW
P. 127	<b>NEW</b> 4 Way 60x60 Cassette		 CS-MZ20UB4EA	 CS-Z25UB4EAW	 CS-Z35UB4EAW
P. 127	<b>NEW</b> Low Static Pressure Hide Away		 CS-MZ20UD3EA	 CS-Z25UD3EAW	 CS-Z35UD3EAW



Page	Free Multi	3,2~5,7kW	3,2~5,7kW	3,2~7,5kW	4,5~9,0kW	4,5~11,0kW	4,5~11,0kW	4,5~13,6kW	4,5~17,5kW
P. 126	Outdoor unit Free Multi System E	 CU-2E12SBE	 CU-2E15SBE	 CU-2E18SBE	 CU-3E18PBE	 CU-3E23SBE	 CU-4E23PBE	 CU-4E27PBE	 CU-5E34PBE

Splits 1x1

R410A

4,2kW	5,0kW	6,0kW	7,1kW
	 KIT-XE18-SKE		
 KIT-E15-SKEM	 KIT-E18-SKEM		
 KIT-TE42-TKE	 KIT-TE50-TKE	 KIT-TE60-TKE	
	 KIT-FE50-UKE		
	 KIT-BE50-TKE		
	 KIT-DE50-TKE		
 KIT-E15-PKEA	 KIT-E18-PKEA		
	 KIT-E18-PFE		
	 KIT-E18-RB4EA	 KIT-E21-RB4EA	
	 KIT-E18-RD3EA		

4,2kW	5,0kW	6,0kW	7,1kW
	 CS-XZ50TKEW		
 CS-Z42TKEW	 CS-Z50TKEW		 CS-Z71TKEW
 CS-TZ42TKEW-1	 CS-TZ50TKEW	 CS-TZ60TKEW	 CS-TZ71TKEW
 CS-TE42TKEW	 CS-TE50TKEW	 CS-TE60TKEW	
	 CS-Z50UFEAW		
	 CS-Z50UB4EAW	 CS-Z60UB4EAW	
	 CS-Z50UD3EAW	 CS-Z60UD3EAW	

Page	Multi Wall TZ/TE	4,0 ~ 5,7kW	4,0 ~ 7,5kW	4,8 ~ 9,0kW
P. 128	Outdoor unit Multi RE for wall TZ indoors	 CU-2RE15SBE	 CU-2RE18SBE	 CU-3RE18SBE

# WALL MOUNTED ETHEREA INVERTER+ SILVER / MATT PEARL WHITE • R410A GAS



—ETHEREA—

## Etherea with enhanced Econavi sensor and nanoe™ air-purifying system

Econavi features an in-built human activity sensor and a new sunlight detection technology to adjust output thereby giving you the best comfort at anytime whilst saving energy. Econavi not only optimizes air flow orientation and volume according to human presence, it also reduces cooling power automatically by no/less sunshine. With Econavi, additional energy savings can be reached up to 38%, whilst increasing your comfort. Furthermore, the nanoe™ revolutionary air-purifying system utilises nano technology fine particles to remove and deactivate 99% of certain airborne and adhesive micro-organisms like bacteria, viruses and mould.

## Technical focus

- Econavi sensor: Even higher efficiency and great comfort
- nanoe™ air purifying system, 99% effective to certain airborne and adhesives mould, viruses, bacteria and pollen allergen
- Aerowings to control air draft direction
- Mild Dry Cooling: prevent a rapid decrease in room humidity
- Super Quiet! Only 19dB(A), equivalent to night-time in the countryside
- More powerful airflow to quickly reach the desired temperature
- Wired control (Optional)
- Smartphone control (Optional)

Wall Mounted Etherea Silver



Kit Silver			KIT-XE7-SKE	KIT-XE9-SKE	KIT-XE12-SKE	—	KIT-XE18-SKE
Kit Matt Pearl White			KIT-E7-SKEM	KIT-E9-SKEM	KIT-E12-SKEM	KIT-E15-SKEM	KIT-E18-SKEM
Cooling capacity	Nominal (Min - Max)	kW	2,05 (0,75 - 2,40)	2,50 (0,85 - 3,00)	3,50 (0,85 - 4,00)	4,20 (0,85 - 5,00)	5,00 (0,98 - 5,60)
EER <sup>1)</sup>	Nominal (Min - Max)	W/W	4,51 (3,13 - 4,29) A	4,67 (3,54 - 4,11) A	4,07 (3,54 - 3,67) A	3,33 (3,27 - 3,13) A	3,16 (3,50 - 3,08) B
<b>SEER <sup>2)</sup></b>	<b>W/W</b>		<b>7,10</b> <b>A++</b>	<b>8,20</b> <b>A++</b>	<b>8,10</b> <b>A++</b>	<b>6,60</b> <b>A++</b>	<b>6,90</b> <b>A++</b>
Pdesign (cooling)		kW	2,10	2,50	3,50	4,20	5,00
Input power cooling	Nominal (Min - Max)	kW	0,46 (0,24 - 0,56)	0,54 (0,24 - 0,73)	0,86 (0,24 - 1,09)	1,26 (0,26 - 1,60)	1,58 (0,28 - 1,82)
Annual energy consumption <sup>3)</sup>		kWh/a	104	107	151	223	254
Heating capacity	Nominal (Min - Max)	kW	2,80 (0,70 - 4,00)	3,40 (0,80 - 5,00)	4,00 (0,80 - 5,80)	5,30 (0,80 - 6,80)	5,80 (0,98 - 7,50)
Heating capacity at -7°C		kW	2,38	2,95	3,40	4,11	4,66
COP <sup>1)</sup>	Nominal (Min - Max)	W/W	4,48 (3,89 - 4,00) A	4,59 (4,44 - 3,82) A	4,21 (4,44 - 3,72) A	3,58 (4,21 - 3,42) B	3,30 (2,88 - 3,10) C
<b>SCOP <sup>2)</sup></b>	<b>W/W</b>		<b>4,60</b> <b>A++</b>	<b>4,70</b> <b>A++</b>	<b>4,80</b> <b>A++</b>	<b>3,90</b> <b>A</b>	<b>4,20</b> <b>A+</b>
Pdesign at -10°C		kW	2,10	2,70	3,20	3,60	4,20
Input power heating	Nominal (Min - Max)	kW	0,63 (0,18 - 1,00)	0,74 (0,18 - 1,31)	0,95 (0,18 - 1,56)	1,48 (0,19 - 1,99)	1,76 (0,34 - 2,42)
Annual energy consumption <sup>3)</sup>		kWh/a	639	804	933	1292	1400
<b>Indoor unit Silver</b>			<b>CS-XE7SKEW</b>	<b>CS-XE9SKEW</b>	<b>CS-XE12SKEW</b>	<b>—</b>	<b>CS-XE18SKEW</b>
<b>Indoor unit Matt Pearl White</b>			<b>CS-E7SKEW-M</b>	<b>CS-E9SKEW-M</b>	<b>CS-E12SKEW-M</b>	<b>CS-E15SKEW-M</b>	<b>CS-E18SKEW-M</b>
Power source		V	230	230	230	230	230
Recommended fuse		A	16	16	16	16	16
Connection indoor / outdoor		mm <sup>2</sup>	4 x 1,5	4 x 1,5	4 x 1,5	4 x 1,5	4 x 2,5
Air volume	Cool / Heat	m <sup>3</sup> /min	9,9 / 10,8	10,0 / 11,3	10,7 / 12,0	11,2 / 12,2	11,7 / 12,4
Moisture removal volume		L/h	1,3	1,5	2,0	2,4	2,8
Sound pressure <sup>4)</sup>	Cool (Hi / Lo / Q-Lo)	dB(A)	37 / 24 / 19	39 / 25 / 19	42 / 28 / 19	43 / 31 / 25	44 / 37 / 34
	Heat (Hi / Lo / Q-Lo)	dB(A)	38 / 25 / 19	40 / 27 / 19	42 / 33 / 19	43 / 35 / 29	44 / 37 / 34
Dimension	H x W x D	mm	295 x 919 x 194	295 x 919 x 194	295 x 919 x 194	295 x 919 x 194	295 x 919 x 194
Net weight		kg	9	10	10	10	10
<b>Outdoor unit</b>			<b>CU-E7SKE</b>	<b>CU-E9SKE</b>	<b>CU-E12SKE</b>	<b>CU-E15SKE</b>	<b>CU-E18SKE</b>
Air volume	Cool / Heat	m <sup>3</sup> /min	26,9 / 26,9	28,7 / 28,7	34,4 / 35,6	33,3 / 33,3	39,2 / 37,9
Sound pressure <sup>4)</sup>	Cool / Heat (Hi)	dB(A)	45 / 46	46 / 47	48 / 50	49 / 51	47 / 47
Dimension <sup>5)</sup>	H x W x D	mm	542 x 780 x 289	542 x 780 x 289	619 x 824 x 299	619 x 824 x 299	695 x 875 x 320
Net weight		kg	30	33	35	32	46
Piping connections	Liquid pipe	Inch (mm)	1/4 (6,35)	1/4 (6,35)	1/4 (6,35)	1/4 (6,35)	1/4 (6,35)
	Gas pipe	Inch (mm)	3/8 (9,52)	3/8 (9,52)	3/8 (9,52)	1/2 (12,70)	1/2 (12,70)
Pipe length range		m	3 - 15	3 - 15	3 - 15	3 - 15	3 - 20
Elevation difference (in/out) <sup>6)</sup>		m	15	15	15	15	15
Pipe length for additional gas		m	7,5	7,5	7,5	7,5	7,5
Additional gas amount		g/m	20	20	20	20	20
Refrigerant (R410A)		kg / TCO <sub>2</sub> Eq.	1,04 / 2,172	1,06 / 2,213	1,20 / 2,506	1,04 / 2,172	1,28 / 2,673
Operating range	Cool Min ~ Max	°C	-10 ~ +43	-10 ~ +43	-10 ~ +43	-10 ~ +43	-10 ~ +43
	Heat Min ~ Max	°C	-15 ~ +24	-15 ~ +24	-15 ~ +24	-15 ~ +24	-15 ~ +24

### Accessories

- CZ-TACG1** NEW Panasonic WLAN kit for internet control
- CZ-CAPRA1** RAC interface adapter for integration into P Link

### Accessories

- CZ-RD514C** Wired remote controller for Wall Mounted and Floor Console

1) EER and COP calculation is based in accordance to EN14511. 2) Energy Label Scale from A+++ to D. 3) The annual energy consumption is calculated in accordance to EU/626/2011. 4) The sound pressure of the units shows the value measured of a position 1m in front of the main body and 0,8m below the unit. The sound pressure is measured in accordance with Eurovent 6/C/006-97 specification. Q-Lo: Quiet mode. Lo: The lowest fan speed. 5) Add 70mm for piping port. 6) When installing the outdoor unit at a higher position than the indoor unit.



SEER and SCOP: SEER for KIT-XE9-SKE and KIT-E9-SKEM and SCOP for KIT-XE12-SKE and KIT-E12-SKEM. SUPER QUIET: For KIT-XE7-SKE, KIT-E7-SKEM, KIT-XE9-SKE, KIT-E9-SKEM, KIT-XE12-SKE and KIT-E12-SKEM. INTERNET CONTROL: Optional. IF DESIGN AWARD 2017: Etherea White awarded with the prestigious IF Design Award 2017.

Splits 1x1

R410A

## WALL MOUNTED TE COMPACT STYLE INVERTER

### • R410A GAS



### TE compact indoor size

The TE indoor units have compact size. With 799mm of width, you can put the air conditioner on the top of the door.

The TE Inverter models are powerful and efficient, with a high energy efficiency class of A++ / A+. The TE works in cooling mode from -10°C outdoors and -15°C in heating with a high efficiency. Furthermore, the PM2,5 filter and the low operation noise is making this TE Series a great choice in the compact category.

### Technical focus

- Compact design with 799mm
- Aerowings to control air draft direction
- PM2,5 Filter to create clean and comfort indoor quality
- Complete line-up of standard Inverter models
- Super Quiet! Only 20dB(A)
- High energy savings
- These units can be installed on R22 pipings
- Long connection distance (from 15m up to 30m)
- Wired control (Optional)
- Smartphone control (Optional)

Kit			KIT-TE20-TKE	KIT-TE25-TKE	KIT-TE35-TKE	KIT-TE42-TKE	KIT-TE50-TKE	KIT-TE60-TKE
Cooling capacity	Nominal (Min - Max)	kW	2,00 (0,75 - 2,40)	2,50 (0,85 - 3,00)	3,50 (0,85 - 3,90)	4,20 (0,85 - 4,60)	5,00 (0,98 - 5,60)	6,30 (0,98 - 7,10)
EER <sup>1)</sup>	Nominal (Min - Max)	W/W	3,77 (3,00 - 3,75) A	3,73 (3,40 - 3,30) A	3,43 (3,33 - 3,22) A	3,28 (3,21 - 2,75) A	3,36 (3,44 - 3,20) A	3,20 (3,50 - 2,93) A
SEER <sup>2)</sup>		W/W	6,10 A++	6,10 A++	6,10 A++	5,60 A+	6,50 A++	6,20 A++
Pdesign (cooling)		kW	2,00	2,50	3,50	4,20	5,00	6,30
Input power cooling	Nominal (Min - Max)	kW	0,53 (0,25 - 0,64)	0,67 (0,25 - 0,91)	1,02 (0,26 - 1,21)	1,28 (0,27 - 1,67)	1,49 (0,29 - 1,75)	1,97 (0,28 - 2,42)
Annual energy consumption <sup>3)</sup>		kWh/a	115	143	201	263	269	356
Heating capacity	Nominal (Min - Max)	kW	2,70 (0,70 - 3,60)	3,30 (0,80 - 4,10)	4,00 (0,80 - 5,10)	5,00 (0,80 - 6,80)	5,80 (0,98 - 7,80)	7,20 (0,98 - 8,50)
Heating capacity at -7°C		kW	2,14	2,70	3,30	3,90	4,66	5,24
COP <sup>1)</sup>	Nominal (Min - Max)	W/W	3,97 (3,78 - 3,43) A	4,07 (4,10 - 3,57) A	3,74 (4,00 - 3,54) A	3,65 (4,00 - 3,29) A	3,72 (2,88 - 3,36) A	3,38 (2,88 - 3,13) B
SCOP <sup>2)</sup>		W/W	4,00 A+	4,10 A+	4,10 A+	3,80 A	4,10 A+	4,00 A+
Pdesign at -10°C		kW	1,90	2,40	2,80	3,60	4,00	4,60
Input power heating	Nominal (Min - Max)	kW	0,68 (0,19 - 1,05)	0,81 (0,20 - 1,15)	1,07 (0,20 - 1,44)	1,37 (0,20 - 2,07)	1,56 (0,34 - 2,32)	2,13 (0,34 - 2,74)
Annual energy consumption <sup>3)</sup>		kWh/a	665	820	956	1326	1366	1610
<b>Indoor unit</b>			<b>CS-TE20TKEW</b>	<b>CS-TE25TKEW</b>	<b>CS-TE35TKEW</b>	<b>CS-TE42TKEW</b>	<b>CS-TE50TKEW</b>	<b>CS-TE60TKEW</b>
Air volume	Cool / Heat	m <sup>3</sup> /min	10,0/10,9	10,9/11,6	11,8/12,5	12,3/12,9	19,9/20,8	20,8/21,4
Moisture removal volume		L/h	1,3	1,5	2,0	2,4	2,8	3,5
Sound pressure <sup>4)</sup>	Cool (Hi / Lo / Q-Lo)	dB(A)	37/25/20	40/26/20	42/30/20	44/31/29	44/37/34	45/37/34
	Heat (Hi / Lo / Q-Lo)	dB(A)	38/26/22	40/27/22	42/33/22	44/35/28	44/37/34	45/37/34
Dimension	H x W x D	mm	290 x 799 x 197	290 x 799 x 197	290 x 799 x 197	290 x 799 x 197	302 x 1102 x 244	302 x 1102 x 244
Net weight		kg	8	8	8	8	12	12
<b>Outdoor unit</b>			<b>CU-TE20TKE</b>	<b>CU-TE25TKE</b>	<b>CU-TE35TKE</b>	<b>CU-TE42TKE</b>	<b>CU-TE50TKE</b>	<b>CU-TE60TKE</b>
Power source		V	230	230	230	230	230	230
Recommended fuse		A	16	16	16	16	16	16
Connection indoor / outdoor		mm <sup>2</sup>	4 x 1,5	4 x 1,5	4 x 1,5	4 x 1,5	4 x 1,5	4 x 1,5
Air volume	Cool / Heat	m <sup>3</sup> /min	31,2/29,7	30,0/28,9	28,7/30,4	33,6/34,0	33,0/33,9	42,6/41,5
Sound pressure <sup>4)</sup>	Cool / Heat (Hi)	dB(A)	46/47	47/48	48/50	49/51	48/49	49/49
Dimension <sup>5)</sup>	H x W x D	mm	542 x 780 x 289	542 x 780 x 289	542 x 780 x 289	619 x 824 x 299	619 x 824 x 299	695 x 875 x 320
Net weight		kg	26	27	32	32	40	42
Piping connections	Liquid pipe	Inch (mm)	1/4 (6,35)	1/4 (6,35)	1/4 (6,35)	1/4 (6,35)	1/4 (6,35)	1/4 (6,35)
	Gas pipe	Inch (mm)	3/8 (9,52)	3/8 (9,52)	3/8 (9,52)	1/2 (12,70)	1/2 (12,70)	1/2 (12,70)
Pipe length range		m	3 - 15	3 - 15	3 - 15	3 - 15	3 - 20	3 - 20
Elevation difference (in/out) <sup>6)</sup>		m	15	15	15	15	15	15
Pipe length for additional gas		m	7,5	7,5	7,5	7,5	7,5	7,5
Additional gas amount		g/m	15	15	20	20	20	20
Refrigerant (R410A)		kg/TCO <sub>2</sub> Eq.	0,66 / 1,378	0,77 / 1,608	0,95 / 1,984	1,01 / 2,109	1,38 / 2,881	1,34 / 2,798
Operating range	Cool Min ~ Max	°C	-10 ~ +43	-10 ~ +43	-10 ~ +43	-10 ~ +43	-10 ~ +43	-10 ~ +43
	Heat Min ~ Max	°C	-15 ~ +24	-15 ~ +24	-15 ~ +24	-15 ~ +24	-15 ~ +24	-15 ~ +24

### Accessories

<b>CZ-TACG1</b>	NEW Panasonic WLAN kit for internet control
<b>CZ-CAPRA1</b>	RAC interface adapter for integration into P Link

### Accessories

<b>CZ-RD514C</b>	Wired remote controller for Wall Mounted and Floor Console
------------------	--

1) EER and COP calculation is based in accordance to EN14511. 2) Energy Label Scale from A+++ to D. 3) The annual energy consumption is calculated in accordance to EU/626/2011. 4) The sound pressure of the units shows the value measured of a position 1m in front of the main body and 0,8m below the unit. The sound pressure is measured in accordance with Eurovent 6/C/006-97 specification. Q-Lo: Quiet mode. Lo: The lowest fan speed. 5) Add 70mm for piping port. 6) When installing the outdoor unit at a higher position than the indoor unit.

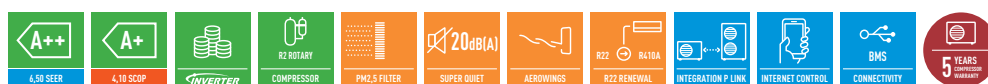

SEER and SCOP: For KIT-TE50-TKE. SUPER QUIET: For KIT-TE25-TKE, KIT-TE25-TKE and KIT-TE35-TKE. INTERNET CONTROL: Optional.

Rating Conditions: Cooling Indoor 27°C DB / 19°C WB. Cooling Outdoor 35°C DB / 24°C WB. Heating Indoor 20°C DB. Heating Outdoor 7°C DB / 4°C WB. (DB: Dry Bulb; WB: Wet Bulb)  
Specifications subject to change without notice. For detailed information about ErP / Energy Labelling, please visit our websites [www.aircon.panasonic.eu](http://www.aircon.panasonic.eu) or [www.ptc.panasonic.eu](http://www.ptc.panasonic.eu).

# NEW WALL MOUNTED FE TYPE STANDARD INVERTER

## • R410A GAS



### New FE series inverter powerful and efficient



### Technical focus

- PM2,5 Filter to create clean and comfort indoor quality
- Super Quiet! Only 20dB(A)
- High energy savings
- These units can be installed on R22 pipings
- Long connection distance
- Wired control (Optional)
- Smartphone control (Optional)

Kit			KIT-FE25-UKE	KIT-FE35-UKE	KIT-FE50-UKE
Cooling capacity	Nominal (Min - Max)	kW	2,50 [0,85 - 3,00]	3,40 [0,85 - 3,90]	5,00 [0,98 - 5,40]
EER <sup>1)</sup>	Nominal (Min - Max)	W/W	3,57 [3,40 - 3,26] A	3,12 [3,33 - 3,00] B	2,98 [3,44 - 2,86] C
<b>SEER <sup>2)</sup></b>		<b>W/W</b>	<b>6,20 A+++</b>	<b>6,10 A+++</b>	<b>6,20 A+++</b>
Pdesign (cooling)		kW	2,50	3,40	5,00
Input power cooling	Nominal (Min - Max)	kW	0,70 [0,25 - 0,92]	1,09 [0,26 - 1,30]	1,68 [0,29 - 1,89]
Annual energy consumption <sup>3)</sup>		kWh/a	141	195	282
Heating capacity	Nominal (Min - Max)	kW	3,15 [0,80 - 3,60]	3,84 [0,80 - 4,40]	5,40 [0,98 - 7,50]
Heating capacity at -7°C		kW	2,14	2,60	4,58
COP <sup>1)</sup>	Nominal (Min - Max)	W/W	3,99 [4,10 - 3,43] A	3,66 [4,10 - 3,41] A	3,38 [2,80 - 3,04] C
<b>SCOP <sup>2)</sup></b>		<b>W/W</b>	<b>3,80 A</b>	<b>3,80 A</b>	<b>3,90 A</b>
Pdesign at -10°C		kW	1,90	2,40	4,00
Input power heating	Nominal (Min - Max)	kW	0,79 [0,20 - 1,05]	1,05 [0,20 - 1,29]	1,60 [0,35 - 2,47]
Annual energy consumption <sup>3)</sup>		kWh/a	700	884	1436
Indoor unit			CS-FE25UKE	CS-FE35UKE	CS-FE50UKE
Power source		V	230	230	230
Recommended fuse		A	16	16	16
Connection indoor / outdoor		mm <sup>2</sup>	4x1,5	4x1,5	4x1,5
Air volume	Cool / Heat	m <sup>3</sup> /min	10,3/11,0	10,7/11,2	11,6/12,5
Moisture removal volume		L/h	1,5	2,0	2,8
Sound pressure <sup>4)</sup>	Cool (Hi / Lo / Q-Lo)	dB(A)	37/26/20	38/30/20	44/37/34
	Heat (Hi / Lo / Q-Lo)	dB(A)	37/27/24	38/33/25	44/37/34
Dimension	HxWxD	mm	290x850x199	290x850x199	290x870x214
Net weight		kg	8	8	9
Outdoor unit			CU-FE25UKE	CU-FE35UKE	CU-FE50UKE
Air volume	Cool / Heat	m <sup>3</sup> /min	30,5/30,5	31,1/31,1	32,7/32,7
Sound pressure <sup>4)</sup>	Cool / Heat (Hi)	dB(A)	48/49	48/50	48/49
Dimension <sup>5)</sup>	HxWxD	mm	542x780x289	542x780x289	619x824x299
Net weight		kg	26	27	38
Piping connections	Liquid pipe	Inch (mm)	1/4 [6,35]	1/4 [6,35]	1/4 [6,35]
	Gas pipe	Inch (mm)	3/8 [9,52]	3/8 [9,52]	1/2 [12,70]
Pipe length range		m	3 - 15	3 - 15	3 - 15
Elevation difference (in/out) <sup>6)</sup>		m	15	15	15
Pipe length for additional gas		m	7,5	7,5	7,5
Additional gas amount		g/m	15	15	20
Refrigerant (R410A)		kg/TCO <sub>2</sub> Eq.	0,66 / 1,378	0,86 / 1,796	1,34 / 2,798
Operating range	Cool Min ~ Max	°C	-10 ~ +43	-10 ~ +43	-10 ~ +43
	Heat Min ~ Max	°C	-15 ~ +24	-15 ~ +24	-15 ~ +24

#### Accessories

- CZ-TACG1** NEW Panasonic WLAN kit for internet control
- CZ-CAPRA1** RAC interface adapter for integration into P Link

#### Accessories

- CZ-RD514C** Wired remote controller for Wall Mounted and Floor Console

1) EER and COP calculation is based in accordance to EN14511. 2) Energy Label Scale from A+++ to D. 3) The annual energy consumption is calculated in accordance to EU/626/2011. 4) The sound pressure of the units shows the value measured of a position 1m in front of the main body and 0,8m below the unit. The sound pressure is measured in accordance with Eurovent 6/C/006-97 specification. Q-Lo: Quiet mode. Lo: The lowest fan speed (the lowest fan speed for FE50). 5) Add 70mm for piping port. 6) When installing the outdoor unit at a higher position than the indoor unit.



SEER and SCOP: For KIT-FE50-UKE. SUPER QUIET: For KIT-FE25-UKE and KIT-FE35-UKE. INTERNET CONTROL: Optional.

Splits 1x1

R410A

WALL MOUNTED BE TYPE  
STANDARD INVERTER

• R410A GAS



BE series inverter powerful and efficient



Technical focus

- Super Quiet! Only 20dB(A)
- High energy savings
- These units can be installed on R22 pipings
- Long connection distance
- Wired control (Optional)
- Smartphone control (Optional)

Kit			KIT-BE25-TKE-1	KIT-BE35-TKE-1	KIT-BE50-TKE
Cooling capacity	Nominal (Min - Max)	kW	2,50 [0,85 - 3,00]	3,40 [0,85 - 3,90]	5,00 [0,98 - 5,40]
EER <sup>1)</sup>	Nominal (Min - Max)	W/W	3,52 [3,40 - 3,23] A	3,06 [3,33 - 2,95] B	2,94 [3,44 - 2,83] C
SEER <sup>2)</sup>		W/W	5,80 <b>A+</b>	5,60 <b>A+</b>	5,90 <b>A+</b>
Pdesign (cooling)		kW	2,50	3,40	5,00
Input power cooling	Nominal (Min - Max)	kW	0,71 [0,25 - 0,93]	1,11 [0,26 - 1,32]	1,70 [0,29 - 1,91]
Annual energy consumption <sup>3)</sup>		kWh/a	151	213	297
Heating capacity	Nominal (Min - Max)	kW	3,15 [0,80 - 3,60]	3,84 [0,80 - 4,40]	5,40 [0,98 - 7,50]
Heating capacity at -7°C		kW	2,14	2,60	4,58
COP <sup>1)</sup>	Nominal (Min - Max)	W/W	4,04 [4,10 - 3,46] A	3,69 [4,10 - 3,44] A	3,40 [2,80 - 3,05] C
SCOP <sup>2)</sup>		W/W	4,00 <b>A+</b>	4,00 <b>A+</b>	4,00 <b>A+</b>
Pdesign at -10°C		kW	1,90	2,40	4,00
Input power heating	Nominal (Min - Max)	kW	0,78 [0,20 - 1,04]	1,04 [0,20 - 1,28]	1,59 [0,35 - 2,46]
Annual energy consumption <sup>3)</sup>		kWh/a	665	840	1400
<b>Indoor unit</b>			<b>CS-BE25TKE-1</b>	<b>CS-BE35TKE-1</b>	<b>CS-BE50TKE</b>
Power source		V	230	230	230
Recommended fuse		A	16	16	16
Connection indoor / outdoor		mm <sup>2</sup>	4 x 1,5	4 x 1,5	4 x 1,5
Air volume	Cool / Heat	m <sup>3</sup> /min	10,3/11,0	10,7/11,2	11,6/12,5
Moisture removal volume		L/h	1,5	2,0	2,8
Sound pressure <sup>4)</sup>	Cool (Hi / Lo / Q-Lo)	dB(A)	37/26/20	38/30/20	44/37/34
	Heat (Hi / Lo / Q-Lo)	dB(A)	37/27/24	38/33/25	44/37/34
Dimension	H x W x D	mm	290 x 850 x 199	290 x 850 x 199	290 x 870 x 214
Net weight		kg	8	8	9
<b>Outdoor unit</b>			<b>CU-BE25TKE-1</b>	<b>CU-BE35TKE-1</b>	<b>CU-BE50TKE</b>
Air volume	Cool / Heat	m <sup>3</sup> /min	30,5/30,5	31,1/31,1	32,7/32,7
Sound pressure <sup>4)</sup>	Cool / Heat (Hi)	dB(A)	48/49	48/50	48/49
Dimension <sup>5)</sup>	H x W x D	mm	542 x 780 x 289	542 x 780 x 289	619 x 824 x 299
Net weight		kg	26	27	38
Piping connections	Liquid pipe	Inch (mm)	1/4 [6,35]	1/4 [6,35]	1/4 [6,35]
	Gas pipe	Inch (mm)	3/8 [9,52]	3/8 [9,52]	1/2 [12,70]
Pipe length range		m	3 - 15	3 - 15	3 - 15
Elevation difference (in/out) <sup>6)</sup>		m	15	15	15
Pipe length for additional gas		m	7,5	7,5	7,5
Additional gas amount		g/m	15	15	20
Refrigerant (R410A)		kg/TCO <sub>2</sub> Eq.	0,66 / 1,378	0,86 / 1,796	1,34 / 2,798
Operating range	Cool Min ~ Max	°C	+5 ~ +43	+5 ~ +43	+5 ~ +43
	Heat Min ~ Max	°C	-15 ~ +24	-15 ~ +24	-15 ~ +24

Accessories	
<b>CZ-TACG1</b>	NEW Panasonic WLAN kit for internet control
<b>CZ-CAPRA1</b>	RAC interface adapter for integration into P Link

Accessories	
<b>CZ-RD514C</b>	Wired remote controller for Wall Mounted and Floor Console

1) EER and COP calculation is based in accordance to EN14511. 2) Energy Label Scale from A+++ to D. 3) The annual energy consumption is calculated in accordance to EU/626/2011. 4) The sound pressure of the units shows the value measured of a position 1m in front of the main body and 0,8m below the unit. The sound pressure is measured in accordance with Eurovent 6/C/006-97 specification. Q-Lo: Quiet mode. Lo: The lowest fan speed (the lowest fan speed for BE50). 5) Add 70mm for piping port. 6) When installing the outdoor unit at a higher position than the indoor unit.



SEER and SCOP: For KIT-BE50-TKE. INTERNET CONTROL: Optional.

# WALL MOUNTED DE TYPE STANDARD INVERTER

## • R410A GAS



### DE Inverter models are powerful and efficient



### Technical focus

- Super Quiet! Only 20dB(A)
- High energy savings
- These units can be installed on R22 pipings
- Long connection distance
- Wired control (Optional)
- Smartphone control (Optional)

### Tentative data

Kit			KIT-DE25-TKE-1	KIT-DE35-TKE-1	KIT-DE50-TKE
Cooling capacity	Nominal (Min - Max)	kW	2,50 (0,85 - 3,00)	3,40 (0,85 - 3,90)	5,00 (0,98 - 5,40)
EER <sup>1)</sup>	Nominal (Min - Max)	W/W	3,52 (3,40 - 3,23) A	3,06 (3,33 - 2,95) B	2,94 (3,44 - 2,83) C
SEER <sup>2)</sup>		W/W	5,80 <b>A+</b>	5,60 <b>A+</b>	5,90 <b>A+</b>
Pdesign (cooling)		kW	2,50	3,40	5,00
Input power cooling	Nominal (Min - Max)	kW	0,71 (0,25 - 0,93)	1,11 (0,26 - 1,32)	1,70 (0,29 - 1,91)
Annual energy consumption <sup>3)</sup>		kWh/a	151	213	297
Heating capacity	Nominal (Min - Max)	kW	3,15 (0,80 - 3,60)	3,84 (0,80 - 4,40)	5,40 (0,98 - 7,50)
Heating capacity at -7°C		kW	2,14	2,60	4,58
COP <sup>1)</sup>	Nominal (Min - Max)	W/W	4,04 (4,10 - 3,46) A	3,69 (4,10 - 3,44) A	3,40 (2,80 - 3,05) C
SCOP <sup>2)</sup>		W/W	4,00 <b>A+</b>	4,00 <b>A+</b>	4,00 <b>A+</b>
Pdesign at -10°C		kW	1,90	2,40	4,00
Input power heating	Nominal (Min - Max)	kW	0,78 (0,20 - 1,04)	1,04 (0,20 - 1,28)	1,59 (0,35 - 2,46)
Annual energy consumption <sup>3)</sup>		kWh/a	665	840	1400
<b>Indoor unit</b>			<b>CS-DE25TKE-1</b>	<b>CS-DE35TKE-1</b>	<b>CS-DE50TKE</b>
Power source		V	230	230	230
Recommended fuse		A	16	16	16
Connection indoor / outdoor		mm <sup>2</sup>	4 x 1,5	4 x 1,5	4 x 1,5
Air volume	Cool / Heat	m <sup>3</sup> /min	10,3/11,0	10,7/11,2	11,6/12,5
Moisture removal volume		L/h	1,5	2,0	2,8
Sound pressure <sup>4)</sup>	Cool (Hi / Lo / Q-Lo)	dB(A)	37/26/20	38/30/20	44/37/34
	Heat (Hi / Lo / Q-Lo)	dB(A)	37/27/24	38/33/25	44/37/34
Dimension	H x W x D	mm	290 x 850 x 199	290 x 850 x 199	290 x 870 x 214
Net weight		kg	8	8	9
<b>Outdoor unit</b>			<b>CU-DE25TKE-1</b>	<b>CU-DE35TKE-1</b>	<b>CU-DE50TKE</b>
Air volume	Cool / Heat	m <sup>3</sup> /min	30,5/30,5	31,1/31,1	32,7/32,7
Sound pressure <sup>4)</sup>	Cool / Heat (Hi)	dB(A)	48/49	48/50	48/49
Dimension <sup>5)</sup>	H x W x D	mm	542 x 780 x 289	542 x 780 x 289	619 x 824 x 299
Net weight		kg	26	27	38
Piping connections	Liquid pipe	Inch (mm)	1/4 (6,35)	1/4 (6,35)	1/4 (6,35)
	Gas pipe	Inch (mm)	3/8 (9,52)	3/8 (9,52)	1/2 (12,70)
Pipe length range		m	3 - 15	3 - 15	3 - 15
Elevation difference (in/out) <sup>6)</sup>		m	15	15	15
Pipe length for additional gas		m	7,5	7,5	7,5
Additional gas amount		g/m	15	15	20
Refrigerant (R410A)		kg/TCO <sub>2</sub> Eq.	0,66/1,378	0,86/1,796	1,34/2,798
Operating range	Cool Min ~ Max	°C	+5 ~ +43	+5 ~ +43	+5 ~ +43
	Heat Min ~ Max	°C	-15 ~ +24	-15 ~ +24	-15 ~ +24

### Accessories

- CZ-TACG1** NEW Panasonic WLAN kit for internet control
- CZ-CAPRA1** RAC interface adapter for integration into P Link

### Accessories

- CZ-RD514C** Wired remote controller for Wall Mounted and Floor Console

1) EER and COP calculation is based in accordance to EN14511. 2) Energy Label Scale from A+++ to D. 3) The annual energy consumption is calculated in accordance to EU/626/2011. 4) The sound pressure of the units shows the value measured of a position 1m in front of the main body and 0,8m below the unit. The sound pressure is measured in accordance with Eurovent 6/C/006-97 specification. Q-Lo: Quiet mode. Lo: The lowest fan speed (the lowest fan speed for DE50). 5) Add 70mm for piping port. 6) When installing the outdoor unit at a higher position than the indoor unit. \* Tentative data.



SEER and SCOP: For KIT-DE50-TKE. INTERNET CONTROL: Optional.



# WALL MOUNTED PROFESSIONAL INVERTER

## -20°C • R410A GAS



### Complete line-up with high efficiency even at -20°C

This Wall Mounted air conditioner is especially designed for professional applications such as computer rooms where cooling inside the room is necessary even when the outside temperature is low. Furthermore this air conditioner has an automatic changeover system, in order to maintain the inside temperature even when sharp outside temperature changes occur.

### Technical focus

- These units can be installed on R22 pipings
- Designed for 24h/7d a week operation
- Highly efficient even at -20°C
- High durability rolling bearings
- Additional piping sensors to prevent freezing

KIT			KIT-E9-PKEA	KIT-E12-PKEA	KIT-E15-PKEA	KIT-E18-PKEA
Cooling capacity	Nominal (Min - Max)	kW	2,50 (0,85 - 3,00)	3,50 (0,85 - 4,00)	4,20 (0,98 - 5,00)	5,00 (0,98 - 6,00)
EER <sup>1)</sup>	Nominal (Min - Max)	W/W	4,85 (4,23 - 5,00) A	4,02 (3,57 - 5,00) A	3,50 (3,50 - 3,16) A	3,47 (3,50 - 3,02) A
Cooling capacity at -10°C		kW	2,63	3,69	5,04	6,00
EER at -10°C		W/W	7,19	5,96	6,01	6,00
Cooling capacity at -20°C		kW	2,61	3,66	4,06	5,82
EER at -20°C		W/W	6,71	5,56	4,39	5,39
<b>SEER <sup>2)</sup></b>		<b>W/W</b>	<b>7,10</b> A++	<b>6,70</b> A++	<b>6,30</b> A++	<b>6,90</b> A++
Pdesign		kW	2,50	3,50	4,20	5,00
Input power cooling	Nominal (Min - Max)	kW	0,52 (0,17 - 0,71)	0,87 (0,17 - 1,12)	1,20 (0,28 - 1,58)	1,44 (0,28 - 1,99)
Annual energy consumption <sup>3)</sup>		kWh/a	123	183	233	254
Heating capacity	Nominal (Min - Max)	kW	3,40 (0,85 - 5,40)	4,00 (0,85 - 6,60)	5,40 (0,98 - 7,10)	5,80 (0,98 - 8,00)
Heating capacity at -7°C <sup>4)</sup>		kW	3,33	4,07	4,10	4,98
COP <sup>1)</sup>	Nominal (Min - Max)	W/W	4,86 (4,12 - 5,15) A	4,35 (3,63 - 5,15) A	3,75 (2,88 - 3,24) A	3,82 (2,88 - 3,11) A
<b>SCOP <sup>5)</sup></b>		<b>W/W</b>	<b>4,40</b> A+	<b>4,10</b> A+	<b>3,90</b> A	<b>4,20</b> A+
Pdesign at -10°C		kW	2,80	3,60	3,60	4,40
Input power heating	Nominal (Min - Max)	kW	0,70 (0,17 - 1,31)	0,92 (0,17 - 1,82)	1,44 (0,34 - 2,19)	1,52 (0,34 - 2,57)
Annual energy consumption <sup>3)</sup>		kWh/a	891	1229	1292	1467
Indoor unit			CS-E9PKEA	CS-E12PKEA	CS-E15PKEA	CS-E18PKEA
Power source		V	230	230	230	230
Recommended fuse		A	16	16	16	16
Connection indoor / outdoor		mm <sup>2</sup>	4 x 1,5	4 x 1,5	4 x 1,5	4 x 2,5
Air Volume	Cool / Heat	m <sup>3</sup> /min	13,3 / 14,6	13,6 / 14,7	14,1 / 15,0	17,9 / 19,3
Moisture removal volume		L/h	1,5	2,0	2,4	2,8
Sound pressure <sup>6)</sup>	Cool (Hi / Lo / Q-Lo)	dB(A)	39 / 26 / 23	42 / 29 / 26	43 / 32 / 29	44 / 37 / 34
	Heat (Hi / Lo / Q-Lo)	dB(A)	40 / 27 / 24	42 / 33 / 29	43 / 35 / 29	44 / 37 / 34
Dimension / Net weight	H x W x D	mm / kg	295 x 870 x 255 / 10	295 x 870 x 255 / 10	295 x 870 x 255 / 10	295 x 1070 x 255 / 13
Outdoor unit			CU-E9PKEA	CU-E12PKEA	CU-E15PKEA	CU-E18PKEA
Sound pressure <sup>6)</sup>	Cool / Heat (Hi)	dB(A)	46 / 47	48 / 50	46 / 46	47 / 47
Dimension <sup>7)</sup>	H x W x D	mm	622 x 824 x 299	622 x 824 x 299	695 x 875 x 320	695 x 875 x 320
Net weight		kg	36	36	45	46
Piping connections	Liquid pipe / Gas pipe	Inch (mm)	1/4 (6,35) / 3/8 (9,52)	1/4 (6,35) / 3/8 (9,52)	1/4 (6,35) / 1/2 (12,70)	1/4 (6,35) / 1/2 (12,70)
Pipe length range		m	3 - 15	3 - 15	3 - 15	3 - 20
Elevation difference (in/out) <sup>8)</sup>		m	5	5	15	15
Pipe length for additional gas		m	7,5	7,5	7,5	7,5
Additional gas amount		g/m	20	20	20	20
Refrigerant (R410A)		kg / TCO <sub>2</sub> Eq.	—	—	—	—
Operating range	Cool / Heat Min ~ Max	°C	-20 ~ +43 / -15 ~ +24	-20 ~ +43 / -15 ~ +24	-20 ~ +43 / -15 ~ +24	-20 ~ +43 / -15 ~ +24

Accessories	
<b>CZ-TACG1</b>	NEW Panasonic WLAN kit for internet control
<b>CZ-CAPRA1</b>	RAC interface adapter for integration into P Link
<b>PAW-GRDSTD40</b>	Outdoor elevation platform

Accessories	
<b>PAW-WTRAY</b>	Tray for condenser water compatible with base ground support
<b>PAW-GRDBSE20</b>	Outdoor base ground support for noise and vibration absorption
<b>PAW-SERVER-PKEA</b>	PCB for installation in server rooms with security

Rating Conditions for cooling capacity at low temperature: Cooling Indoor 27°C DB / 19°C WB. Cooling Outdoor 0°C DB / -10°C WB.  
 1) EER and COP calculation is based in accordance to EN14511. 2) Energy Label Scale from A+++ to D. SEER is calculated in base Eurovent IPLV for SBEM for U1 indoor unit SEER=a(EER25)+b(EER50)+c(EER75)+d(EER100) where EER25, EER50, EER75 and EER100 are the EER measured value at 25%, 50%, 75% and 100% part load for temperatures 20, 25, 30 and 35°C DB, respectively. a, b, c and d are values assigned for an office type. These values are given as a=0,2, b=0,36, c=0,32 and d=0,03. The internal temperatures are taken at 27°C DB and 19°C WB. 3) The annual energy consumption is calculated in accordance to EU/626/2011. 4) Heating capacity is calculated including defrost factor correction. 5) Energy Label Scale from A+++ to D. SCOP is calculated in base Eurovent IPLV for SBEM with U1 indoor unit including defrost correction factor. 6) The sound pressure of the units shows the value measured of a position 1m in front of the main body and 1,5m from the ground. The sound pressure is measured in accordance with Eurovent 6/C/006-97 specification. 7) Add 70mm for piping port. 8) When installing the outdoor unit at a higher position than the indoor unit. // Recommended fuse for the indoor 3A.

SEER and SCOP: For KIT-E9-PKEA. SUPER QUIET: For KIT-E9-PKEA. INTERNET CONTROL: Optional.

# MORE FOR YOUR HOME

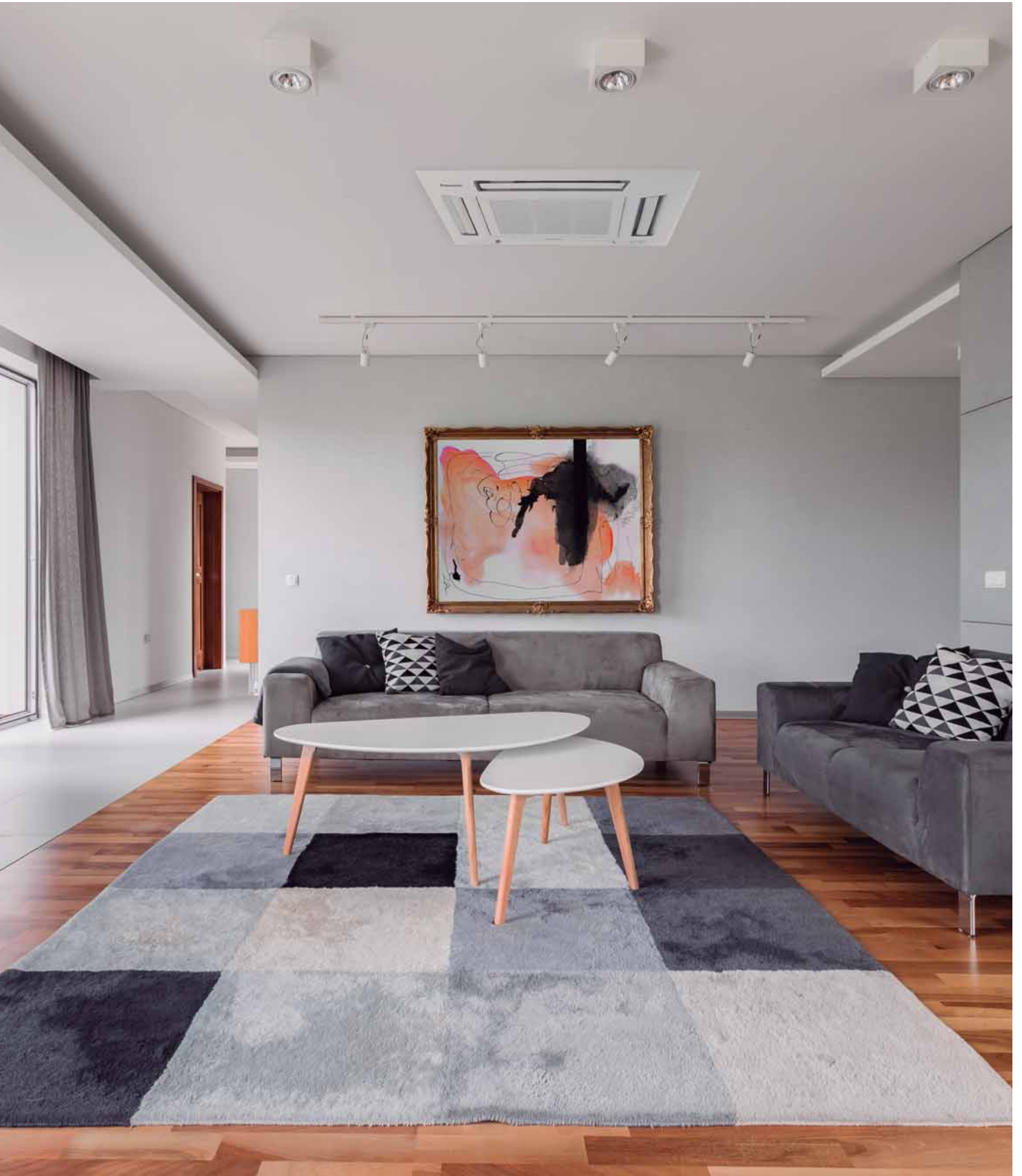

Splits 1x1

R410A

## FLOOR CONSOLE TYPE INVERTER+

### • R410A GAS



Console designed for discreet integration on walls, and for high performance, specifically in heat mode even when the outside temperature is as low as -15°C.

Double airflow for improved comfort and temperature dispersion: through the top for an efficient cooling mode, through the bottom for quick heating.

### Technical focus

- These units can be installed on R22 pipings
- Heating mode down to -15°C with high efficiency
- Double airflow for better efficiency
- Powerful mode for quick temperature setting
- R410A refrigerant gas

Kit			KIT-E9-PFE	KIT-E12-PFE	KIT-E18-PFE
Cooling capacity	Nominal (Min - Max)	kW	2,50 (0,85 - 3,00)	3,50 (0,85 - 3,80)	5,00 (0,98 - 5,60)
EER <sup>1)</sup>	Nominal (Min - Max)	W/W	4,50 A	3,72 A	3,25 A
SEER <sup>2)</sup>		W/W	6,10 <b>A++</b>	5,80 <b>A++</b>	6,20 <b>A++</b>
Pdesign (cooling)		kW	2,50	3,50	5,00
Input power cooling	Nominal (Min - Max)	kW	0,56	0,94	1,54
Annual energy consumption <sup>3)</sup>		kWh/a	143	211	282
Heating capacity	Nominal (Min - Max)	kW	3,40 (0,85 - 5,00)	4,00 (0,85 - 6,00)	5,80 (0,98 - 7,10)
Heating capacity at -7°C		kW	2,35	2,86	3,87
COP <sup>1)</sup>	Nominal (Min - Max)	W/W	4,20 A	4,00 A	3,63 A
SCOP <sup>2)</sup>		W/W	3,80 <b>A</b>	3,80 <b>A</b>	3,90 <b>A</b>
Pdesign at -10°C		kW	2,70	3,20	4,40
Input power heating	Nominal (Min - Max)	kW	0,81	1,00	1,60
Annual energy consumption <sup>3)</sup>		kWh/a	995	1179	1579
<b>Indoor unit</b>			<b>CS-E9GFEW</b>	<b>CS-E12GFEW</b>	<b>CS-E18GFEW</b>
Air volume	Cool / Heat	m <sup>3</sup> /min	9,3/9,6	9,5/10,0	11,0/13,0
Moisture removal volume		L/h	1,4	2,0	2,8
Sound pressure <sup>4)</sup>	Cool (Hi / Lo / Q-Lo)	dB(A)	38/27/23	39/28/24	44/36/32
	Heat (Hi / Lo / Q-Lo)	dB(A)	38/27/23	39/27/23	46/36/32
Dimension	HxWxD	mm	600x700x210	600x700x210	600x700x210
Net weight		kg	14	14	14
<b>Outdoor unit</b>			<b>CU-E9PFE</b>	<b>CU-E12PFE</b>	<b>CU-E18PFE</b>
Power source		V	230	230	230
Recommended fuse		A	16	16	16
Connection indoor / outdoor		mm <sup>2</sup>	3x1,5	3x1,5	3x2,5
Air volume	Cool / Heat	m <sup>3</sup> /min	29,8/29,8	33,3/33,3	39,2/37,9
Sound pressure <sup>4)</sup>	Cool / Heat (Hi)	dB(A)	46/47	48/50	47/48
	Dimension <sup>5)</sup>	HxWxD	542x780x289	619x824x299	695x875x320
Net weight		kg	33	34	46
Piping connections	Liquid pipe	Inch (mm)	1/4 (6,35)	1/4 (6,35)	1/4 (6,35)
	Gas pipe	Inch (mm)	3/8 (9,52)	3/8 (9,52)	1/2 (12,70)
Pipe length range		m	3 - 15	3 - 15	3 - 20
Elevation difference (in/out) <sup>6)</sup>		m	5	5	15
Pipe length for additional gas		m	7,5	7,5	7,5
Additional gas amount		g/m	20	20	20
Refrigerant (R410A)		kg/TCO <sub>2</sub> Eq.	0,97/2,025	1,00/2,088	1,12/2,339
Operating range	Cool Min ~ Max	°C	+16 ~ +43	+16 ~ +43	+16 ~ +43
	Heat Min ~ Max	°C	-15 ~ +24	-15 ~ +24	-15 ~ +24

### Accessories

**PAW-IR-WIFI-1** IR WLAN interface for Internet control

1) EER and COP calculation is based in accordance to EN14511. 2) Energy Label Scale from A+++ to D. 3) The annual energy consumption is calculated in accordance to EU/626/2011. 4) The sound pressure of the units shows the value measured of a position 1m in front of the main body and 1m below the unit. The sound pressure is measured in accordance with Eurovent 6/C/006-97 specification. Q-Lo: Quiet mode. Lo: The lowest fan speed. 5) Add 70mm for piping port. 6) When installing the outdoor unit at a higher position than the indoor unit.

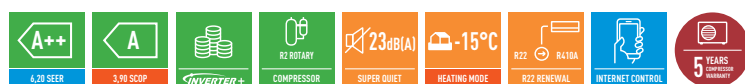

SEER and SCOP: For KIT-E18-PFE. SUPER QUIET: For KIT-E9-PFE. INTERNET CONTROL: Optional.

# 4 WAY 60x60 CASSETTE STANDARD INVERTER

## • R410A GAS



**Specially designed for offices, retail and restaurant applications, this Cassette fits perfectly into 60x60 or 70x70 ceiling grids**

Compact Cassette with high efficiency even at low temperatures, this Cassette in 9 and 12kW versions can also be connected to KNX, Modbus, EnOcean interfaces for easy integration with your BMS systems. Interfaces have dry contacts (ON/OFF, error message) to enable easy integration. With the wireless interfaces, you can also control the Cassette from your smartphone and internet very easily! Fit Panasonic's Cassette Type, and start to save all year round!

### Technical focus

- Cassettes can be controlled by IntesisHome, KNX, EnOcean and Modbus
- These units can be installed on R22 pipings
- Designed for easy installation in the standard European 60x60 ceiling grid
- Operation down to -10°C in cooling and heating modes
- Piping length up to 30m
- Maximum elevation difference up to 20m
- Ultra compact outdoor units for easy installation
- High pressure selector in case of high ceilings (higher than 2,7m)
- Drain pump included (maximum 750mm high)
- Air fresh entry available on the Cassette

KIT			KIT-E9-PB4EA	KIT-E12-PB4EA	KIT-E18-RB4EA	KIT-E21-RB4EA
Cooling capacity	Nominal (Min - Max)	kW	2,50 [0,85 - 3,00]	3,40 [0,85 - 4,00]	5,00 [0,90 - 5,80]	5,90 [0,90 - 6,30]
EER <sup>1)</sup>	Nominal (Min - Max)	W/W	4,55 [3,54 - 4,05] A	3,82 [3,54 - 3,33] A	3,13 [3,53 - 2,97] B	2,88 [3,53 - 2,86] C
SEER <sup>2)</sup>		W/W	5,80 <b>A+</b>	5,60 <b>A+</b>	5,80 <b>A+</b>	5,60 <b>A+</b>
Pdesign (cooling)		kW	2,50	3,40	5,00	5,90
Input power cooling	Nominal (Min - Max)	kW	0,55 [0,24 - 0,74]	0,89 [0,24 - 1,20]	1,60 [0,26 - 1,95]	2,05 [0,26 - 2,20]
Annual energy consumption <sup>3)</sup>		kWh/a	151	213	302	369
Heating capacity	Nominal (Min - Max)	kW	3,20 [0,85 - 4,80]	4,50 [0,85 - 5,60]	5,60 [0,90 - 7,10]	7,00 [0,90 - 8,00]
Heating capacity at -7°C		kW	2,60	3,00	—	—
COP <sup>1)</sup>	Nominal (Min - Max)	W/W	4,00 [3,70 - 3,56] A	3,17 [3,70 - 2,80] D	3,01 [3,46 - 2,92] D	2,86 [3,46 - 2,84] D
SCOP <sup>2)</sup>		W/W	4,00 <b>A+</b>	3,80 <b>A</b>	4,10 <b>A+</b>	4,10 <b>A+</b>
Pdesign at -10°C		kW	2,70	3,00	3,80	4,00
Input power heating	Nominal (Min - Max)	kW	0,80 [0,23 - 1,35]	1,42 [0,23 - 2,00]	1,86 [0,26 - 2,43]	2,45 [0,26 - 2,82]
Annual energy consumption <sup>3)</sup>		kWh/a	945	1105	1298	1366
<b>Indoor unit</b>			<b>CS-E9PB4EA</b>	<b>CS-E12PB4EA</b>	<b>CS-E18RB4EAW</b>	<b>CS-E21RB4EAW</b>
<b>Panel</b>			<b>CZ-BT20EW</b>	<b>CZ-BT20EW</b>	<b>CZ-BT20EW</b>	<b>CZ-BT20EW</b>
Air volume	Cool / Heat	m <sup>3</sup> /min	10,5 / 10,8	10,5 / 10,8	11,5 / 11,8	12,4 / 14,6
Moisture removal volume		L/h	1,5	2,3	2,8	3,3
Sound pressure <sup>4)</sup>	Cool (Hi / Lo / Q-Lo)	dB(A)	34 / 26 / 23	34 / 26 / 23	37 / 28 / 25	42 / 33 / 30
	Heat (Hi / Lo / Q-Lo)	dB(A)	35 / 28 / 25	35 / 28 / 25	38 / 29 / 26	43 / 34 / 31
Dimension (HxWxD)	Indoor	mm	260 x 575 x 575	260 x 575 x 575	260 x 575 x 575	260 x 575 x 575
	Panel	mm	51 x 700 x 700	51 x 700 x 700	51 x 700 x 700	51 x 700 x 700
Net weight	Indoor / Panel	kg	18 / 2,5	18 / 2,5	18 / 2,5	18 / 2,5
<b>Outdoor unit</b>			<b>CU-E9PB4EA</b>	<b>CU-E12PB4EA</b>	<b>CU-E18RBEA</b>	<b>CU-E21RBEA</b>
Power source		V	230	230	230	230
Recommended fuse		A	16	16	16	16
Connection indoor / outdoor		mm <sup>2</sup>	4 x 1,5 to 2,5	4 x 1,5 to 2,5	4 x 1,5 to 2,5	4 x 1,5 to 2,5
Sound pressure <sup>4)</sup>	Cool / Heat (Hi)	dB(A)	45 / 46	45 / 47	47 / 48	49 / 50
	HxWxD	mm	622 x 824 x 299	695 x 875 x 320	695 x 875 x 320	695 x 875 x 320
Net weight		kg	36	45	47	47
Piping connections	Liquid pipe	Inch (mm)	1/4 (6,35)	1/4 (6,35)	1/4 (6,35)	1/4 (6,35)
	Gas pipe	Inch (mm)	3/8 (9,52)	3/8 (9,52)	1/2 (12,70)	1/2 (12,70)
Pipe length range		m	3 ~ 20	3 ~ 20	3 ~ 30	3 ~ 30
Elevation difference (in/out) <sup>4)</sup>		m	15	15	20	20
Pipe length for additional gas		m	10	10	10	10
Additional gas amount		g/m	20	20	20	20
Refrigerant [R410A]		kg / TCO <sub>2</sub> Eq.	—	—	—	—
Operating range	Cool Min ~ Max	°C	-10 ~ +43	-10 ~ +43	-10 ~ +43	-10 ~ +43
	Heat Min ~ Max	°C	-10 ~ +24	-10 ~ +24	-10 ~ +24	-10 ~ +24

### Accessories

<b>CZ-TACG1</b>	NEW Panasonic WLAN kit for internet control
<b>CZ-CAPRA1</b>	RAC interface adapter for integration into P Link
<b>PA-AC-WIFI-1</b>	Full bidirectional WLAN interface for Internet control

### Accessories

<b>PAW-IR-WIFI-1</b>	IR WLAN interface for Internet control
<b>CZ-RD52CP</b>	Wired remote controller for Cassette

1) EER and COP calculation is based in accordance to EN14511. 2) Energy Label Scale from A+++ to D. 3) The annual energy consumption is calculated in accordance to EU/626/2011. 4) The sound pressure of the units shows the value measured of a position 1m in front of the main body and 1,5m below the unit. The sound pressure is measured in accordance with Eurovent 6/C/006-97 specification. Q-Lo: Quiet mode. Lo: The lowest fan speed. 5) Add 70mm for piping port. 6) When installing the outdoor unit at a higher position than the indoor unit.



SEER and SCOP: For KIT-E18-RB4EA. SUPER QUIET: For KIT-E9-PB4EA and KIT-E12-PB4EA. INTERNET CONTROL: Optional.

Splits 1x1

R410A

## LOW STATIC PRESSURE HIDE AWAY STANDARD INVERTER

### • R410A GAS



Designed for homes, offices, retail and restaurants, this duct is ideal for small rooms where the air conditioning and the heating should be nicely integrated and where high comfort and efficiency is needed

The 9 and 12kW duct can also be connected to KNX, Modbus, EnOcean interfaces for easy integration with your BMS systems. This interfaces have dry contacts (ON/OFF, error message) for easy integration. With the wireless interfaces, you can control the Duct also from your smartphone and internet very easily!

### Technical focus

- Duct type can be controlled by IntesisHome, KNX, EnOcean and Modbus
- These units can be installed on R22 pipings
- Eco mode for 20% energy saving
- Extremely compact indoor units without losing static pressure (only 235mm high)
- Weekly timer, 42 settings per week
- Easy check mode for failure detection
- Drain pump included (maximum 200mm)

KIT			KIT-E9-PD3EA	KIT-E12-QD3EA	KIT-E18-RD3EA
Cooling capacity	Nominal (Min - Max)	kW	2,50 (0,85 - 3,00)	3,40 (0,85 - 4,00)	5,10 (0,90 - 5,70)
EER <sup>1)</sup>	Nominal (Min - Max)	W/W	4,24 (3,54 - 3,95) A	3,86 (3,54 - 3,45) A	3,19 (3,53 - 3,13) B
SEER <sup>2)</sup>		W/W	5,80 <b>A+</b>	5,60 <b>A+</b>	5,80 <b>A+</b>
Pdesign (cooling)		kW	2,50	3,40	5,10
Input power cooling	Nominal (Min - Max)	kW	0,59 (0,24 - 0,76)	0,88 (0,24 - 1,16)	1,60 (0,26 - 1,82)
Annual energy consumption <sup>3)</sup>		kWh/a	151	213	308
Heating capacity	Nominal (Min - Max)	kW	3,20 (0,85 - 4,60)	4,00 (0,85 - 5,10)	6,10 (0,90 - 7,10)
Heating capacity at -7°C		kW	2,60	3,00	4,30
COP <sup>1)</sup>	Nominal (Min - Max)	W/W	3,72 (3,70 - 3,33) A	3,54 (3,70 - 3,29) B	3,33 (3,46 - 3,26) C
SCOP <sup>2)</sup>		W/W	4,20 <b>A+</b>	3,80 <b>A</b>	3,90 <b>A</b>
Pdesign at -10°C		kW	2,60	2,90	4,00
Input power heating	Nominal (Min - Max)	kW	0,86 (0,23 - 1,38)	1,13 (0,23 - 1,55)	1,83 (0,26 - 2,18)
Annual energy consumption <sup>3)</sup>		kWh/a	867	1068	1436
Indoor unit			CS-E9PD3EA	CS-E12QD3EAW	CS-E18RD3EAW
External static pressure <sup>4)</sup>	S-Hi / Hi / Me / Lo	Pa	N/A	N/A	N/A
Air volume	Cool / Heat	m <sup>3</sup> /min	6,9/8,1	9,3/10,4	15,3/15,3
Moisture removal volume		L/h	1,50	2,30	2,80
Sound pressure <sup>5)</sup>	Cool (Hi / Lo / Q-Lo)	dB(A)	33/27/24	34/27/24	41/30/27
	Heat (Hi / Lo / Q-Lo)	dB(A)	35/28/25	36/28/25	41/32/29
Dimension	H x W x D	mm	235 x 750 x 370	235 x 750 x 370	200 x 750 x 640
Net weight		kg	17	17	19
Outdoor unit			CU-E9PD3EA	CU-E12QD3EA	CU-E18RBEA
Power source		V	230	230	230
Recommended fuse		A	16	16	16
Connection indoor / outdoor		mm <sup>2</sup>	4 x 1,5 to 2,5	4 x 1,5 to 2,5	4 x 1,5 to 2,5
Sound pressure <sup>5)</sup>	Cool / Heat (Hi)	dB(A)	47/47	47/48	47/48
Dimension <sup>6)</sup>	H x W x D	mm	622 x 824 x 299	695 x 875 x 320	695 x 875 x 320
Net weight		kg	36	45	47
Piping connections	Liquid pipe	Inch (mm)	1/4 (6,35)	1/4 (6,35)	1/4 (6,35)
	Gas pipe	Inch (mm)	3/8 (9,52)	3/8 (9,52)	1/2 (12,70)
Pipe length range		m	3 - 20	3 - 20	3 - 30
Elevation difference (in/out) <sup>7)</sup>		m	15	15	20
Pipe length for additional gas		m	7,5	7,5	10
Additional gas amount		g/m	20	20	20
Refrigerant (R410A)		kg/TCO <sub>2</sub> Eq.	—	—	—
Operating range	Cool Min ~ Max	°C	-10 ~ +43	-10 ~ +43	-10 ~ +43
	Heat Min ~ Max	°C	-10 ~ +24	-10 ~ +24	-10 ~ +24

#### Accessories

**CZ-TACG1** **NEW** Panasonic WLAN kit for internet control

#### Accessories

**CZ-CAPRA1** RAC interface adapter for integration into P Link

1) EER and COP calculation is based in accordance to EN14511. 2) Energy Label Scale from A+++ to D. 3) The annual energy consumption is calculated in accordance to EU/626/2011. 4) The specification listed on the table indicates values under the condition of 29Pa (3,0mmAq) which are applied for factory default setting. Change switch on PCB from Hi to Shii to have more than 6,0mmAq. 5) The sound pressure of the units shows the value measured of a position of 1,5m below the unit with 1m duct on the suction side and 2m duct on the discharge side. The sound pressure is measured in accordance with Eurovent 6/C/006-97 specification. 6) Add 100mm for indoor unit or 70mm for outdoor unit for piping port. 7) When installing the outdoor unit at a higher position than the indoor unit.



SEER and SCOP: For KIT-E9-PD3EA. FILTER INCLUDED: For CS-E18RD3EAW. INTERNET CONTROL: Optional.

R410A

Free Multi System E



Outdoor unit Free Multi System E • R410A GAS

System Capacity (Min - Max Indoor Cooling Capacity Nominal)			3,2 to 5,7kW	3,2 to 5,7kW	3,2 to 7,5kW	4,5 to 9,0kW	4,5 to 11,0kW	4,5 to 11,0kW	4,5 to 13,6kW	4,5 to 17,5kW
Unit			CU-2E12SBE	CU-2E15SBE	CU-2E18SBE	CU-3E18PBE	CU-3E23SBE	CU-4E23PBE	CU-4E27PBE	CU-5E34PBE
Cooling capacity	Nominal (Min - Max)	kW	3,60(1,50 - 4,50)	4,50(1,50 - 5,20)	5,20(1,50 - 5,40)	5,20(1,80 - 7,30)	6,80(1,90 - 8,00)	6,80(1,90 - 8,00)	8,00(3,00 - 9,20)	10,00(2,90 - 11,50)
EER <sup>1)</sup>		W/W	4,50(6,00 - 4,09)	3,66(6,00 - 3,42)	3,42(6,00 - 3,42)	4,33(5,00 - 3,24)	3,56(7,04 - 3,38)	4,05(5,59 - 3,56)	4,04(5,66 - 3,21)	3,50(5,27 - 2,98)
SEER <sup>2)</sup>		W/W	6,50 A+++	6,50 A+++	6,50 A+++	7,00 A+++	7,00 A+++	7,00 A+++	7,00 A+++	6,50 A+++
Pdesign (cooling)		kW	3,60	4,50	5,20	5,20	6,80	6,80	8,00	10,00
Input power cooling	Nominal (Min - Max)	kW	0,80(0,25 - 1,10)	1,23(0,25 - 1,52)	1,52(0,25 - 1,58)	1,27(0,36 - 2,25)	1,91(0,27 - 2,37)	1,68(0,34 - 2,47)	1,98(0,53 - 2,87)	2,86(0,55 - 3,86)
Annual energy consumption <sup>3)</sup>		kWh/a	194	242	280	260	955	340	400	538
Heating capacity	Nominal (Min - Max)	kW	4,40(1,10 - 5,60)	5,40(1,10 - 7,00)	5,60(1,10 - 7,20)	6,80(1,60 - 8,30)	8,50(3,30 - 10,40)	8,50(3,00 - 10,40)	9,40(4,20 - 10,60)	12,00(3,40 - 14,50)
Heating capacity at -7°C		kW	3,54	3,54	3,65	4,90	6,05	6,05	7,08	8,85
COP <sup>1)</sup>		W/W	4,63(5,24 - 4,41)	4,62(5,24 - 4,19)	4,63(5,24 - 4,24)	4,69(3,93 - 5,00)	4,07(5,32 - 3,74)	4,47(4,08 - 5,17)	4,52(6,00 - 3,46)	4,20(6,42 - 3,42)
SCOP <sup>2)</sup>		W/W	4,00 A+	4,00 A+	4,00 A+	4,00 A+	4,00 A+	4,00 A+	4,00 A+	4,00 A+
Pdesign at -10°C		kW	4,00	4,00	4,20	4,80	5,20	5,50	8,00	10,00
Input power heating	Nominal (Min - Max)	kW	0,95(0,21 - 1,27)	1,17(0,21 - 1,67)	1,21(0,21 - 1,70)	1,41(0,32 - 2,18)	2,09(0,62 - 2,78)	1,85(0,58 - 2,60)	2,08(0,70 - 3,06)	2,86(0,53 - 4,24)
Annual energy consumption <sup>3)</sup>		kWh/a	1400	1400	1470	1680	1820	1925	2800	3500
Current	Cool / Heat	A	3,75/4,20	5,75/5,20	7,10/5,35	5,30/6,70	8,40/9,60	7,50/8,80	9,40/9,80	13,20/13,40
Power source		V	230	230	230	230	230	230	230	230
Recommended fuse		A	16	16	16	16	16	20	20	25
Recommended power cable section		mm <sup>2</sup>	2,5	2,5	2,5	2,5	2,5	2,5	2,5	3,5
Sound pressure <sup>4)</sup>	Cool / Heat (Hi)	dB(A)	47/49	47/49	49/51	46/47	50/51	50/51	51/52	53/54
Dimension <sup>5)</sup>	H x W x D	mm	619 x 824 x 299	619 x 824 x 299	619 x 824 x 229	795 x 875 x 320	795 x 875 x 320	795 x 875 x 320	999 x 940 x 340	999 x 940 x 340
Net weight		kg	39	39	39	71	71	72	80	81
Piping connections	Liquid pipe	Inch (mm)	1/4(6,35)	1/4(6,35)	1/4(6,35)	1/4(6,35)	1/4(6,35)	1/4(6,35)	1/4(6,35)	1/4(6,35)
	Gas pipe	Inch (mm)	3/8(9,52)	3/8(9,52)	3/8(9,52)	3/8(9,52)	3/8(9,52)	3/8(9,52)	3/8(9,52)	3/8(9,52)
Pipe length range total <sup>6)</sup>		m	6 - 30	6 - 30	6 - 30	6 - 50	6 - 60	6 - 60	6 - 80	6 - 80
Pipe length range to one unit		m	3 - 20	3 - 20	3 - 20	3 - 25	3 - 25	3 - 25	3 - 25	3 - 25
Elevation difference (in/out)		m	10	10	10	15	15	15	15	15
Pipe length for additional gas		m	20	20	20	30	30	30	45	45
Additional gas amount		g/m	15	15	15	20	20	20	20	20
Refrigerant (R410A)		kg/TCO <sub>2</sub> Eq.	1,40/2,9232	1,40/2,9232	1,40/2,9232	2,64/5,5123	2,64/5,5123	2,64/5,5123	3,40/7,0992	3,40/7,0992
Operating range	Cool Min ~ Max	°C	-10 ~ +46	-10 ~ +46	-10 ~ +46	-10 ~ +46	-10 ~ +46	-10 ~ +46	-10 ~ +46	-10 ~ +46
	Heat Min ~ Max	°C	-15 ~ +24	-15 ~ +24	-15 ~ +24	-15 ~ +24	-15 ~ +24	-15 ~ +24	-15 ~ +24	-15 ~ +24

1) EER and COP calculation is based in accordance to EN14511. 2) Energy Label Scale from A+++ to D. 3) The annual energy consumption is calculated in accordance to EU/626/2011. 4) The sound pressure of the units shows the value measured of a position 1m in front of the main body and 0,8m below the unit. The sound pressure is measured in accordance with Eurotest 6/C/006-97 specification. 5) Add 70 or 95mm for piping port. 6) Minimum piping length is 3 meters per indoor unit. Minimum quantity of connection: 2 indoor units.

Possible outdoor / indoor units combinations • R410A GAS

	Etherea Silver	Etherea Pure White Matt	Wall Mounted TZ / TE Compact Style	NEW Floor Console	NEW 4 Way 60x60 Cassette	NEW Low Static Pressure Hide Away
	16 20 25 35 42 50 60 71	16 20 25 35 42 50 60 71	16 20 25 35 42 50 60 71	16 20 25 35 42 50 60 71	16 20 25 35 42 50 60 71	16 20 25 35 42 50 60 71
CU-2E12SBE // 3,2 - 5,7kW // 2 Rooms	✓ ✓ ✓	✓ ✓ ✓	✓ ✓ ✓	✓ ✓ ✓	✓ ✓ ✓	✓ ✓ ✓
CU-2E15SBE // 3,2 - 5,7kW // 2 Rooms	✓ ✓ ✓	✓ ✓ ✓	✓ ✓ ✓	✓ ✓ ✓	✓ ✓ ✓	✓ ✓ ✓
CU-2E18SBE // 3,2 - 7,5kW // 2 Rooms	✓ ✓ ✓ ✓ <sup>1)</sup>	✓ ✓ ✓ ✓ <sup>1)</sup>	✓ ✓ ✓ ✓	✓ ✓ ✓ ✓ <sup>1)</sup>	✓ ✓ ✓ ✓ <sup>1)</sup>	✓ ✓ ✓ ✓ <sup>1)</sup>
CU-3E18PBE // 4,5 - 9,0kW // 3 Rooms	✓ ✓ ✓ ✓ <sup>1)</sup>	✓ ✓ ✓ ✓ <sup>1)</sup>	✓ ✓ ✓ ✓	✓ ✓ ✓ ✓ <sup>1)</sup>	✓ ✓ ✓ ✓ <sup>1)</sup>	✓ ✓ ✓ ✓ <sup>1)</sup>
CU-3E23SBE // 4,5 - 11,0kW // 3 Rooms	✓ ✓ ✓ ✓ <sup>1)</sup>	✓ ✓ ✓ ✓ <sup>1)</sup>	✓ ✓ ✓ ✓	✓ ✓ ✓ ✓ <sup>1)</sup>	✓ ✓ ✓ ✓ <sup>1)</sup>	✓ ✓ ✓ ✓ <sup>1)</sup>
CU-4E23PBE // 4,5 - 11,0kW // 4 Rooms	✓ ✓ ✓ ✓ <sup>1)</sup>	✓ ✓ ✓ ✓ <sup>1)</sup>	✓ ✓ ✓ ✓	✓ ✓ ✓ ✓ <sup>1)</sup>	✓ ✓ ✓ ✓ <sup>1)</sup>	✓ ✓ ✓ ✓ <sup>1)</sup>
CU-4E27PBE // 4,5 - 13,6kW // 4 Rooms	✓ ✓ ✓ ✓ <sup>1)</sup>	✓ ✓ ✓ ✓ <sup>1)</sup>	✓ ✓ ✓ ✓	✓ ✓ ✓ ✓ <sup>1)</sup>	✓ ✓ ✓ ✓ <sup>1)</sup>	✓ ✓ ✓ ✓ <sup>1)</sup>
CU-5E34PBE // 4,5 - 17,5kW // 5 Rooms	✓ ✓ ✓ ✓ <sup>1)</sup>	✓ ✓ ✓ ✓ <sup>1)</sup>	✓ ✓ ✓ ✓	✓ ✓ ✓ ✓ <sup>1)</sup>	✓ ✓ ✓ ✓ <sup>1)</sup>	✓ ✓ ✓ ✓ <sup>1)</sup>

1) A CZ-MA1P pipe reducer is needed on the 42 and 50, a CZ-MA2P pipe expander is needed on the 60 and CZ-MA3P pipe reducer on the 71.

Outdoor Multi combination model

	Model
CS-MZ16TKE / CS-MTZ16TKE CS-XZ20TKEW / CS-Z20TKEW / CS-TZ20TKEW-1 / CS-TE20TKEW / CS-MZ20UFEA / CS-MZ20UB4EA / CS-MZ20UD3EA CS-XZ25TKEW / CS-Z25TKEW / CS-TZ25TKEW-1 / CS-TE25TKEW / CS-Z25UFEAW / CS-Z25UB4EAW / CS-Z25UD3EAW CS-XZ35TKEW / CS-Z35TKEW / CS-TZ35TKEW-1 / CS-TE35TKEW / CS-Z35UFEAW / CS-Z35UB4EAW / CS-Z35UD3EAW	CU-2E12SBE / CU-2E15SBE / CU-2E18SBE / CU-3E18PBE / CU-3E23SBE / CU-4E23PBE / CU-4E27PBE / CU-5E34PBE
CS-Z42TKEW / CS-TZ42TKEW-1 / CS-TE42TKEW CS-XZ50TKEW / CS-Z50TKEW / CS-TZ50TKEW / CS-TE50TKEW / CS-Z50UFEAW / CS-Z50UD3EAW / CS-Z50UB4EAW	CU-2E18SBE / CU-3E18PBE / CU-3E23SBE / CU-4E23PBE / CU-4E27PBE / CU-5E34PBE
CS-TZ60TKEW / CS-TE60TKEW / CS-Z60UB4EAW / CS-Z60UD3EAW	CU-3E23SBE / CU-4E23PBE / CU-4E27PBE / CU-5E34PBE
CS-Z71TKEW / CS-TZ71TKEW	CU-4E27PBE / CU-5E34PBE

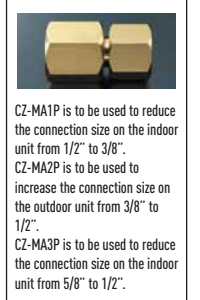

CZ-MA1P is to be used to reduce the connection size on the indoor unit from 1/2" to 3/8". CZ-MA2P is to be used to increase the connection size on the outdoor unit from 3/8" to 1/2". CZ-MA3P is to be used to reduce the connection size on the indoor unit from 5/8" to 1/2".

\* For CZ-MA3P necessary to use adaptor CZ-MA2P too.

Free Multi System E

R410A



IF DESIGN AWARD 2017: Ethera White awarded with the prestigious IF Design Award 2017. INTERNET CONTROL: Optional.



Wall Mounted Ethera	Indoor unit Silver	Indoor unit Pure White Matt	Cooling capacity kW / kCal/h	Heating capacity kW / kCal/h	Connection in. / out.	Sound pressure <sup>1</sup>		Dimension / Net weight HxWxD mm / kg	Piping connections	
						Cool	Heat (Hi/Lo/S-Lo)		Liquid	Gas pipe
1,6kW	—	CS-MZ16TKE	1,60/1380	2,60/2240	4x1,5	39/29/23	— 39/29/23	295x919x194/9	1/4 (6,35)	3/8 (9,52)
2,0kW	CS-XZ20TKEW	CS-Z20TKEW	2,00/1720	3,20/2750	4x1,5	37/24/19	— 38/25/19	295x919x194/9	1/4 (6,35)	3/8 (9,52)
2,5kW	CS-XZ25TKEW	CS-Z25TKEW	2,50/2150	3,60/3010	4x1,5	39/25/19	— 41/27/19	295x919x194/10	1/4 (6,35)	3/8 (9,52)
3,5kW <sup>2</sup>	CS-XZ35TKEW	CS-Z35TKEW	3,20/2750	4,50/3870	4x1,5	42/28/19	— 43/33/19	295x919x194/10	1/4 (6,35)	3/8 (9,52)
4,2kW	—	CS-Z42TKEW	4,00/3440	5,00/4300	4x1,5	43/31/25	— 43/35/29	295x919x194/10	1/4 (6,35)	1/2 (12,70)
5,0kW	CS-XZ50TKEW	CS-Z50TKEW	5,00/4300	5,30/4558	4x1,5	44/37/30	— 44/37/30	302x1120x236/12	1/4 (6,35)	1/2 (12,70)
7,1kW	—	CS-Z71TKEW	7,10/6105	8,90/7654	—	47/38/30	— 47/38/30	302x1120x236/13	1/4 (6,35)	5/8 (15,88)



Compact Style	Indoor unit TZ	Indoor unit TE	Cooling capacity kW / kCal/h	Heating capacity kW / kCal/h	Connection in. / out.	Sound pressure <sup>1</sup>		Dimension / Net weight HxWxD mm / kg	Piping connections	
						Cool	Heat (Hi/Lo/S-Lo)		Liquid	Gas pipe
1,6kW	CS-MTZ16TKE	—	1,60/1380	2,60/2240	4x1,5	—	—	290x799x197/8	1/4 (6,35)	3/8 (9,52)
2,0kW	CS-TZ20TKEW-1	CS-TE20TKEW	2,00/1720	3,20/2750	4x1,5	37/25/20	— 38/26/22	290x799x197/8	1/4 (6,35)	3/8 (9,52)
2,5kW	CS-TZ25TKEW-1	CS-TE25TKEW	2,50/2150	3,60/3010	4x1,5	40/26/20	— 40/27/22	290x799x197/8	1/4 (6,35)	3/8 (9,52)
3,5kW <sup>2</sup>	CS-TZ35TKEW-1	CS-TE35TKEW	3,20/2750	4,50/3870	4x1,5	42/30/20	— 42/33/22	290x799x197/8	1/4 (6,35)	3/8 (9,52)
4,2kW	CS-TZ42TKEW-1	CS-TE42TKEW	4,00/3440	5,00/4300	4x1,5	44/31/29	— 44/35/28	290x799x197/8	1/4 (6,35)	1/2 (12,70)
5,0kW	CS-TZ50TKEW	CS-TE50TKEW	5,00/4300	5,30/4558	4x1,5	44/37/34	— 44/37/34	302x1102x244/12	1/4 (6,35)	1/2 (12,70)
6,0kW	CS-TZ60TKEW	CS-TE60TKEW	6,00/5160	8,50/7310	4x1,5	45/37/34	— 45/37/34	302x1102x244/12	1/4 (6,35)	5/8 (15,88)
7,1kW	CS-TZ71TKEW	—	7,00/6020	8,70/7482	—	47/38/35	— 47/38/35	302x1102x244/13	1/4 (6,35)	5/8 (15,88)



SUPER QUIET: For CS-Z25UFEAW and CS-Z50UFEAW. INTERNET CONTROL: Optional.

NEW Floor Console*	Indoor	Cooling capacity kW / kCal/h	Heating capacity kW / kCal/h	Connection in. / out.	Sound pressure <sup>1</sup>		Dimension / Net weight HxWxD mm / kg	Piping connections	
					Cool	Heat (Hi/Lo/S-Lo)		Liquid	Gas pipe
2,0kW	CS-MZ20UFEA	2,00/1720	3,20/2750	4x1,5	—	—	600x750x207/13	—	—
2,8kW	CS-Z25UFEAW	2,50/2150	3,60/3010	4x1,5	38/25/20	— 38/25/19	600x750x207/13	1/4 (6,35)	3/8 (9,52)
3,5kW <sup>2</sup>	CS-Z35UFEAW	3,20/2750	4,50/3870	4x1,5	39/26/20	— 39/26/19	600x750x207/13	1/4 (6,35)	3/8 (9,52)
5,0kW	CS-Z50UFEAW	5,00/4300	5,30/4558	4x1,5	44/31/27	— 46/33/29	600x750x207/13	1/4 (6,35)	1/2 (12,70)



NEW CZ-BT20EW RAL9010 panel for 4 Way 60x60 Cassette (sold separately)

SUPER QUIET: For CS-Z25UB4EAW. INTERNET CONTROL READY and EASY CONTROL BY BMS: Optional.

NEW 4 Way 60x60 Cassette*	Indoor / Panel	Cooling capacity kW / kCal/h	Heating capacity kW / kCal/h	Connection in. / out.	Sound pressure <sup>1</sup>		Dimension / Net weight		Piping connections	
					Cool	Heat (Hi/Lo/S-Lo)	Indoor HxWxD	Panel HxWxD	Liquid	Gas pipe
2,0kW	CS-MZ20UB4EA / CZ-BT20EW	2,00/1720	3,20/2750	4x1,5	—	—	260x575x575/18	51x700x700/2,5	—	—
2,5kW	CS-Z25UB4EAW / CZ-BT20EW	2,50/2150	3,60/3010	4x1,5 to 2,5	34/25/22	— 35/28/25	260x575x575/18	51x700x700/2,5	1/4 (6,35)	3/8 (9,52)
3,5kW <sup>2</sup>	CS-Z35UB4EAW / CZ-BT20EW	3,20/2750	4,50/3870	4x1,5 to 2,5	34/26/23	— 35/28/25	260x575x575/18	51x700x700/2,5	1/4 (6,35)	3/8 (9,52)
5,0kW	CS-Z50UB4EAW / CZ-BT20EW	5,00/4300	5,30/4558	4x1,5 to 2,5	37/28/25	— 38/29/26	260x575x575/18	51x700x700/2,5	1/4 (6,35)	1/2 (12,70)
6,0kW	CS-Z60UB4EAW / CZ-BT20EW	6,00/5160	8,50/7310	4x1,5 to 2,5	42/32/29	— 43/32/29	260x575x575/18	51x700x700/2,5	1/4 (6,35)	1/2 (12,70)



INTERNET CONTROL READY and EASY CONTROL BY BMS: Optional.

NEW Low Static Pressure Hide Away*	Indoor	Cooling capacity kW / kCal/h	Heating capacity kW / kCal/h	Connection in. / out.	Sound pressure <sup>1</sup>		Dimension / Net weight HxWxD mm / kg	Piping connections	
					Cool	Heat (Hi/Lo/S-Lo)		Liquid	Gas pipe
2,0kW	CS-MZ20UD3EA	2,00/1720	3,20/2750	4x1,5	—	—	200x750x640/19	—	—
2,5kW	CS-Z25UD3EAW	2,50/2150	3,60/3010	4x1,5 to 2,5	33/27/24	— 35/27/24	200x750x640/19	1/4 (6,35)	3/8 (9,52)
3,5kW <sup>2</sup>	CS-Z35UD3EAW	3,20/2750	4,50/3870	4x1,5 to 2,5	33/27/24	— 35/27/24	200x750x640/19	1/4 (6,35)	3/8 (9,52)
5,0kW	CS-Z50UD3EAW	5,00/4300	5,30/4558	4x1,5 to 2,5	39/29/26	— 39/30/27	200x750x640/19	1/4 (6,35)	1/2 (12,70)
6,0kW	CS-Z60UD3EAW	6,00/5160	8,50/7310	4x1,5 to 2,5	41/30/27	— 41/32/29	200x750x640/19	1/4 (6,35)	1/2 (12,70)

1) The sound pressure of the units shows the value measured of a position 1m in front of the main body. The sound pressure is measured in accordance with Eurovent 6/C/006-97 specification. 2) The heating capacity is 4.40 kW connected to a CU-2E1ZSBE.  
\* Tentative data.

R410A

Multi Wall TZ/TE



**Outdoor unit Multi Wall TZ/TE • R410A GAS**

System Capacity			4,0 to 5,7kW	4,0 to 7,5kW	4,8 to 9,0kW
			CU-2RE15SBE	CU-2RE18SBE	CU-3RE18SBE
Cooling capacity	Nominal (Min - Max)	kW	4,40 (1,50 - 4,80)	4,80 (1,50 - 5,00)	5,20 (1,80 - 7,30)
SEER <sup>1)</sup>	W/W		6,50 <b>A++</b>	6,50 <b>A++</b>	7,00 <b>A++</b>
Pdesign (cooling)		kW	4,40	4,80	5,20
Annual energy consumption <sup>2)</sup>		kWh/a	237	258	260
Heating capacity	Nominal (Min - Max)	kW	4,80 (1,10 - 6,50)	5,20 (1,10 - 6,70)	6,80 (1,60 - 8,30)
SCOP <sup>1)</sup>	W/W		4,00 <b>A+</b>	4,00 <b>A+</b>	4,00 <b>A+</b>
Pdesign at -10°C		kW	3,60	3,80	4,80
Annual energy consumption <sup>2)</sup>		kWh/a	1260	1330	1680
Sound pressure <sup>3)</sup>	Cool (Hi)	dB(A)	47	49	46
	Heat (Hi)	dB(A)	49	51	47
Dimension <sup>4)</sup>	H x W x D	mm	619 x 824 x 299	619 x 824 x 299	795 x 875 x 320
Net weight		kg	39	39	71
Piping connections	Liquid pipe	Inch (mm)	1/4 (6,35)	1/4 (6,35)	1/4 (6,35)
	Gas pipe	Inch (mm)	3/8 (9,52)	3/8 (9,52)	3/8 (9,52)
Pipe length range total		m	6 - 30	6 - 30	6 - 50
Pipe length range to one unit		m	3 - 20	3 - 20	3 - 25
Elevation difference (in/out)		m	10	10	15
Pipe length for additional gas		m	20	20	30
Additional gas amount		g/m	15	15	20
Refrigerant [R410A]		kg/TCO <sub>2</sub> Eq.	1,40 / 2,9232	1,40 / 2,9232	2,64 / 5,5123
Operating range	Cool Min ~ Max	°C	+16 ~ +43	+16 ~ +43	+16 ~ +43
	Heat Min ~ Max	°C	-10 ~ +24	-10 ~ +24	-10 ~ +24

1) Energy Label Scale from A+++ to D. 2) The annual energy consumption is calculated in accordance to EU/626/2011. 3) The sound pressure of the units shows the value measured of a position 1m in front of the main body and 0,8m below the unit. The sound pressure is measured in accordance with Eurovent 6/C/006-97 specification. 4) Add 70 or 95mm for piping port. Minimum quantity of connection: 2 indoor units.

**Possible outdoor / indoor units combinations • R410A GAS**

	Wall Mounted TZ Compact Style						Wall Mounted TE Compact Style					
	16	20	25	35	42	50	16	20	25	35	42	50
CU-2RE15SBE // 4,0 - 5,7kW // 2 Rooms	✓	✓	✓	✓				✓	✓	✓		
CU-2RE18SBE // 4,0 - 7,5kW // 2 Rooms	✓	✓	✓	✓	✓	✓		✓	✓	✓	✓	✓
CU-3RE18SBE // 4,8 - 9,0kW // 3 Rooms	✓	✓	✓	✓	✓	✓		✓	✓	✓	✓	✓



Compact Style	Indoor unit TZ	Indoor unit TE	Cooling capacity	Heating capacity	Connection	Sound pressure <sup>1)</sup>	Dimension / Net weight	Piping connections
			kW / kCal/h	kW / kCal/h		Cool — Heat (Hi/L0/S-Lo)	HxWxD	Liquid / Gas pipe
					mm	dB(A)	mm / kg	Inch (mm)
1,6kW	CS-MTZ16TKE	—	1,60 / 1380	2,60 / 2240	4 x 1,5	—	290 x 799 x 197 / 8	1/4 (6,35) / 3/8 (9,52)
2,0kW	CS-TZ20TKEW-1	CS-TE20TKEW	2,00 / 1720	3,20 / 2750	4 x 1,5	37 / 25 / 20 — 38 / 26 / 23	290 x 799 x 197 / 8	1/4 (6,35) / 3/8 (9,52)
2,5kW	CS-TZ25TKEW-1	CS-TE25TKEW	2,50 / 2150	3,60 / 3010	4 x 1,5	40 / 26 / 20 — 40 / 27 / 24	290 x 799 x 197 / 8	1/4 (6,35) / 3/8 (9,52)
3,5kW	CS-TZ35TKEW-1	CS-TE35TKEW	3,20 / 2750	4,50 / 3870	4 x 1,5	42 / 30 / 20 — 42 / 33 / 25	290 x 799 x 197 / 8	1/4 (6,35) / 3/8 (9,52)
4,2kW	CS-TZ42TKEW-1	CS-TE42TKEW	4,00 / 3440	5,00 / 4300	4 x 1,5	44 / 31 / 29 — 44 / 35 / 28	290 x 799 x 197 / 8	1/4 (6,35) / 1/2 (12,70)
5,0kW	CS-TZ50TKEW	CS-TE50TKEW	5,00 / 4300	5,30 / 4558	4 x 1,5	44 / 37 / 34 — 44 / 37 / 34	302 x 1102 x 244 / 12	1/4 (6,35) / 1/2 (12,70)

1) The sound pressure of the units shows the value measured of a position 1m in front of the main body. The sound pressure is measured in accordance with Eurovent 6/C/006-97 specification.



## Multi Split System

R410A



INTERNET CONTROL: Optional. IF DESIGN AWARD 2017: Etherea White awarded with the prestigious IF Design Award 2017.



## Etherea Multi Split Inverter+ • R410A GAS

				Day & Night					
Rooms		2 Rooms			3 Rooms				
Kit Silver		KIT-2XE2525-SBE	KIT-2XE2035-SBE	KIT-2XE2535-SBE	KIT-3XE202035-PBE	KIT-3XE252535-PBE			
Indoor unit Silver		CS-XZ25TKEW CS-XZ25TKEW	CS-XZ35TKEW CS-XZ20TKEW	CS-XZ35TKEW CS-Z25TKEW	CS-XZ35TKEW CS-XZ20TKEW CS-XZ20TKEW	CS-XZ35TKEW CS-XZ25TKEW CS-XZ25TKEW			
Kit Pure White Matt		KIT-2E2525-SBE	KIT-2E2035-SBE	KIT-2E2535-SBE	KIT-3E202035-PBE	KIT-3E252535-PBE			
Indoor unit Pure White Matt		CS-Z25TKEW CS-Z25TKEW	CS-Z35TKEW CS-Z20TKEW	CS-Z35TKEW CS-Z25TKEW	CS-Z35TKEW CS-Z20TKEW CS-Z20TKEW	CS-Z35TKEW CS-Z25TKEW CS-Z25TKEW			
Outdoor unit		CU-2E15SBE	CU-2E15SBE	CU-2E15SBE	CU-3E18PBE	CU-3E18PBE			
Cooling capacity	Nominal (Min - Max)	kW	4,50 (1,50 - 5,20)	4,50 (1,50 - 5,20)	4,50 (1,50 - 5,20)	5,20 (1,90 - 7,20)	5,20 (1,90 - 7,20)		
EER		W/W	3,66 <b>A</b>	3,66 <b>A</b>	3,66 <b>A</b>	3,80 <b>A</b>	4,23 <b>A</b>		
Heating capacity	Nominal (Min - Max)	kW	5,40 (1,10 - 7,00)	5,40 (1,10 - 7,00)	5,40 (1,10 - 7,00)	6,80 (1,60 - 8,30)	6,80 (1,60 - 8,30)		
COP		W/W	4,62 <b>A</b>	4,62 <b>A</b>	4,62 <b>A</b>	4,36 <b>A</b>	4,17 <b>A</b>		
Indoor dimension	(HxWxD)	mm	295 x 919 x 194	295 x 919 x 194	295 x 919 x 194	295 x 919 x 194	295 x 919 x 194		
Indoor net weight		kg	10	10 (9 for Z20)	10	10 (9 for Z20)	10		

				Simultaneous					
Rooms		2 Rooms			3 Rooms				
Kit Silver		KIT-2XE2525-SKE	KIT-2XE2035-SKE	KIT-2XE2535-SKE	KIT-3XE202035-SKE	KIT-3XE252535-SKE			
Indoor unit Silver		CS-XZ25TKEW CS-XZ25TKEW	CS-XZ35TKEW CS-XZ20TKEW	CS-XZ35TKEW CS-XZ25TKEW	CS-XZ35TKEW CS-XZ20TKEW CS-XZ20TKEW	CS-XZ35TKEW CS-XZ25TKEW CS-XZ25TKEW			
Kit Pure White Matt		KIT-2E2525-SKE	KIT-2E2035-SKE	KIT-2E2535-SKE	KIT-3E202035-SKE	KIT-3E252535-SKE			
Indoor unit Pure White Matt		CS-Z25TKEW CS-Z25TKEW	CS-Z35TKEW CS-Z20TKEW	CS-Z35TKEW CS-Z25TKEW	CS-Z35TKEW CS-Z20TKEW CS-Z20TKEW	CS-Z35TKEW CS-Z25TKEW CS-Z25TKEW			
Outdoor unit		CU-2E18SBE	CU-2E18SBE	CU-2E18SBE	CU-3E23SBE	CU-3E23SBE			
Cooling capacity	Nominal (Min - Max)	kW	5,00 (1,50 - 5,20)	5,20 (1,50 - 5,40)	5,20 (1,50 - 5,40)	6,80 (1,90 - 8,00)	6,80 (1,90 - 8,00)		
EER		W/W	3,47 <b>A</b>	3,42 <b>A</b>	3,42 <b>A</b>	3,56 <b>A</b>	3,56 <b>A</b>		
Heating capacity	Nominal (Min - Max)	kW	5,60 (1,10 - 7,20)	5,60 (1,10 - 7,20)	5,60 (1,10 - 7,20)	8,50 (3,30 - 10,40)	8,50 (3,30 - 10,40)		
COP		W/W	4,63 <b>A</b>	4,63 <b>A</b>	4,63 <b>A</b>	4,09 <b>A</b>	4,09 <b>A</b>		
Indoor dimension	(HxWxD)	mm	295 x 919 x 194	295 x 919 x 194	295 x 919 x 194	295 x 919 x 194	295 x 919 x 194		
Indoor net weight		kg	10	10 (9 for Z20)	10	10 (9 for Z20)	10		



INTERNET CONTROL: Optional.



## Multi Split TZ Compact Style • R410A GAS

		Day & Night			Simultaneous					
Rooms		2 Rooms			3 Rooms			2 Rooms		
Kit		KIT-2RE2525-SBE	KIT-2RE2035-SBE	KIT-2RE2535-SBE	KIT-3RE202035-PBE	KIT-3RE252535-PBE	KIT-2RE2525-SKE	KIT-2RE2035-SKE	KIT-2RE2535-SKE	
Indoor unit		CS-TZ25TKEW-1 CS-TZ25TKEW-1	CS-TZ35TKEW-1 CS-TZ20TKEW-1	CS-TZ35TKEW-1 CS-TZ25TKEW-1	CS-TZ35TKEW-1 CS-TZ20TKEW-1 CS-TZ20TKEW-1	CS-TZ35TKEW-1 CS-TZ25TKEW-1 CS-TZ25TKEW-1	CS-TZ25TKEW-1 CS-TZ35TKEW-1	CS-TZ20TKEW-1 CS-TZ25TKEW-1	CS-TZ35TKEW-1 CS-TZ25TKEW-1	
Outdoor unit		CU-2RE15SBE	CU-2RE15SBE	CU-2RE15SBE	CU-3RE18SBE	CU-3RE18SBE	CU-2RE18SBE	CU-2RE18SBE	CU-2RE18SBE	
Cooling capacity	Nominal (Min - Max)	kW	4,40 (1,50 - 4,80)	4,40 (1,50 - 4,80)	4,40 (1,50 - 4,80)	5,20 (1,90 - 7,20)	5,20 (1,90 - 7,20)	4,80 (1,50 - 5,00)	4,80 (1,50 - 4,90)	4,80 (1,50 - 5,00)
EER		W/W	3,38 <b>A</b>	3,38 <b>A</b>	3,38 <b>A</b>	3,80 <b>A</b>	3,80 <b>A</b>	3,22 <b>A</b>	3,22 <b>A</b>	3,22 <b>A</b>
Heating capacity	Nominal (Min - Max)	kW	4,80 (1,10 - 6,50)	4,80 (1,10 - 6,50)	4,80 (1,10 - 6,50)	6,80 (1,60 - 8,30)	6,80 (1,60 - 8,30)	5,20 (1,10 - 6,70)	5,20 (1,10 - 6,70)	5,20 (1,10 - 6,70)
COP		W/W	4,00 <b>A</b>	4,00 <b>A</b>	4,00 <b>A</b>	4,17 <b>A</b>	4,17 <b>A</b>	4,00 <b>A</b>	4,00 <b>A</b>	4,00 <b>A</b>
Indoor dimension	HxWxD	mm	290 x 799 x 197	290 x 799 x 197	290 x 799 x 197	290 x 799 x 197	290 x 799 x 197	290 x 799 x 197	290 x 799 x 197	290 x 799 x 197
Indoor net weight		kg	8	8	8	8	8	8	8	8

# FEATURE COMPARISON

MODELS	WALL MOUNTED HEATCHARGE VZ INVERTER+ • R32 GAS	WALL MOUNTED ETHEREA INVERTER+ • R32 GAS	WALL MOUNTED TZ COMPACT STYLE • R32 GAS	WALL MOUNTED FZ TYPE STANDARD INVERTER • R32 GAS	WALL MOUNTED PZ TYPE STANDARD INVERTER • R32 GAS	WALL MOUNTED PROFESSIONAL INVERTER -20°C • R32 GAS	FLOOR CONSOLE TYPE INVERTER+ • R32 GAS	4 WAY 60x60 CASSETTE STANDARD INVERTER • R32 GAS
Econavi	✓ Sunlight Detection	✓						
Inverter+ system	✓	✓					✓	
Inverter system			✓	✓	✓	✓		✓
R2 Rotary Compressor	✓	✓	✓	✓	✓	✓	✓	✓
Refrigerant R32	✓	✓	✓	✓	✓	✓	✓	✓
nanoe™	✓	✓					✓ nanoe™ X	
PM2.5 Filter			✓	✓				
Antiallergy properties	✓	✓					✓	
Super Quiet*	✓	✓ 19dB(A) for XZ/TZ0, XZ/TZ5 and XZ/TZ5	✓ 20dB(A) for TZ20, TZ25 and TZ35	✓ 20dB(A) for FZ25 and FZ35	✓ 20dB(A) for PZ25 and PZ35	✓ 21dB(A) for Z25 and Z35	✓ 20dB(A) for Z25 and Z35	✓ 22dB(A) for Z25
Mild Dry Cooling		✓						
Aerowings		✓	✓					
Down to -10°C in cooling only	✓	✓	✓	✓		✓ -20°C	✓	✓
Down to -15°C in heating mode	✓ -30°C	✓	✓	✓	✓	✓	✓	✓
Summer House	✓							
R22 renewal								
R410A/R22 Renewal	✓	✓	✓	✓	✓	✓	✓	✓
Odour-removing function	✓	✓	✓	✓	✓	✓	✓	✓
Removable, washable panel	✓	✓	✓	✓	✓	✓	✓	✓
Powerful mode	✓	✓	✓	✓	✓	✓	✓	✓
Soft dry operation mode	✓	✓	✓	✓	✓	✓	✓	✓
Personal airflow creation	✓	✓	✓ For TZ50, TZ60 and TZ71					
Automatic vertical airflow control			✓ For TZ20, TZ25, TZ35 and TZ42	✓	✓		✓	✓
Manual horizontal airflow control			✓ For TZ20, TZ25, TZ35 and TZ42	✓	✓		✓	
AUTO mode (Inverter)	✓	✓	✓	✓	✓	✓	✓	✓
Simple Auto Changeover	✓	✓	✓	✓	✓			
Hot start mode	✓	✓	✓	✓	✓	✓	✓	✓
Real time clock with dual ON&OFF timer	✓	✓	✓	✓	✓		✓	✓
Real time clock with single ON&OFF timer			✓					
LCD Wireless remote controller	✓	✓	✓	✓	✓		✓	✓
Automatic restart	✓	✓	✓	✓	✓	✓	✓	✓
Long piping	✓ 15m	✓ 15m, 20m (XZ/TZ50), 20m (XZ/TZ71)	✓ 15m, 20m (TZ50), 30m (TZ71 and TZ60)	✓ 15m, 20m (FZ60)	✓ 15m	✓ 15m, 20m (Z50)	✓ 20m, 30m (Z50)	✓ 20m, 30m (Z50 and Z60)
Top-Panel maintenance access	✓	✓	✓	✓	✓	✓	✓	✓
Self-diagnosis function	✓	✓	✓	✓	✓	✓	✓	✓
CZ-CAPRA1: RAC interface adapter for integration into P Link	✓	✓	✓	✓	✓	✓	✓	✓
Internet Control	✓	✓	✓	✓	✓	✓	✓	✓
Easy control by BMS	✓	✓	✓	✓	✓	✓	✓	✓
Warranty on the compressor	✓	✓	✓	✓	✓	✓	✓	✓

\* At the lowest fan speed.

LOW STATIC PRESSURE HIDE AWAY STANDARD INVERTER • R32 GAS	WALL MOUNTED ETHEREA INVERTER+ • R410A GAS	WALL MOUNTED TE COMPACT STYLE • R410A GAS	WALL MOUNTED FE TYPE STANDARD INVERTER • R410A GAS	WALL MOUNTED BE TYPE STANDARD INVERTER • R410A GAS	WALL MOUNTED DE TYPE STANDARD INVERTER • R410A GAS	WALL MOUNTED PROFESSIONAL INVERTER -20°C • R410A GAS	FLOOR CONSOLE TYPE INVERTER+ • R410A GAS	4-WAY 60x60 CASSETTE STANDARD INVERTER • R410A GAS	LOW STATIC PRESSURE HIDE AWAY STANDARD INVERTER • R410A GAS
	✓								
	✓						✓		
✓		✓	✓	✓	✓	✓		✓	✓
✓	✓	✓	✓	✓	✓	✓	✓	✓	✓
✓									
	✓								
		✓	✓						
	✓								
	✓ 19dB(A) for XE/E7, XE/E9 and XE/E12	✓ 20dB(A) for TE20, TE25 and TE35	✓ 20dB(A) for FE25 and FE35	✓ 20dB(A) for BE25 and BE35	✓ 20dB(A) for DE25 and DE35	✓ 23dB(A) for E9	✓ 23dB(A) for E9	✓ 23dB(A) for E9 and E12	
	✓								
	✓	✓	✓						
✓	✓	✓	✓			✓ -20°C		✓	✓
✓	✓	✓	✓	✓	✓	✓	✓	✓ -10°C	✓ -10°C
	✓	✓	✓	✓	✓	✓	✓	✓	✓
✓	✓	✓	✓	✓	✓	✓	✓	✓	✓
✓	✓	✓	✓	✓	✓	✓	✓	✓	✓
✓	✓	✓	✓	✓	✓	✓	✓	✓	✓
	✓								
	✓	✓ For TE50 and TE60							
	✓	✓ For TE20, TE25, TE35 and TE42					✓	✓	
	✓	✓ For TE20, TE25, TE35 and TE42					✓		
✓	✓	✓	✓	✓	✓	✓	✓	✓	✓
	✓								
✓	✓	✓	✓	✓	✓	✓	✓	✓	✓
✓	✓	✓	✓	✓	✓	✓	✓	✓	✓
✓	✓	✓	✓	✓	✓	✓	✓	✓	✓
✓	✓	✓	✓	✓	✓	✓	✓	✓	✓
✓	✓	✓	✓	✓	✓	✓	✓	✓	✓
✓	✓	✓	✓	✓	✓	✓	✓	✓	✓
✓	✓	✓	✓	✓	✓	✓	✓	✓	✓
	✓	✓	✓	✓	✓	✓	✓	✓	✓
	✓	✓	✓	✓	✓	✓	✓	✓	✓
✓	✓ 20m, 30m (Z50 and Z60)	✓ 15m, 20m (XE/E18)	✓ 15m, 20m (TE50 and TE60)	✓ 15m	✓ 15m	✓ 15m, 20m (E18)	✓ 15m, 20m (E18)	✓ 20m, 30m (E18 and E21)	✓ 20m, 30m (E18)
✓	✓	✓	✓	✓	✓	✓	✓	✓	✓
✓	✓	✓	✓	✓	✓	✓	✓	✓	✓
✓	✓	✓	✓	✓	✓	✓	✓	✓	✓
✓	✓	✓	✓	✓	✓	✓	✓	✓	✓
✓	✓	✓	✓	✓	✓	✓	✓	✓	✓
✓	✓	✓	✓	✓	✓	✓	✓	✓	✓
✓	✓	✓	✓	✓	✓	✓	✓	✓	✓

# FEATURES EXPLAINED

## Energy saving

 **ECONAVI** 38%  
Econavi. The sensor determines the human activity level and the position in the room and adjust the air flow orientation for maximum comfort and maximum savings, and detects changes in sunlight intensity and judges whether it is sunny or cloudy/night. It reduces unnecessary heating under more sunlight conditions.

 **INVERTER+**  
Inverter Plus System. This classification highlight the Panasonic highest performing systems.

 **INVERTER**  
Inverter system. The Inverter range provides greater efficiency and comfort. Provides more precise temperature control, without highs and lows, and keeps the ambient temperature constant with lower energy consumption and a significant reduction in noise and vibration levels.

 **R2 ROTARY COMPRESSOR**  
R2 Rotary Compressor. Panasonic R2 Rotary Compressor. Designed to withstand extreme conditions, it delivers high performance and efficiency.

 **R32**  
Refrigerant R32. Our heat pumps containing the refrigerant R32 show a drastic reduction in the value of Global Warming Potential (GWP). An important step to reduce greenhouse gases. R32 is also a components refrigerant, making it easy to recycle.

## High performance and healthy air

 **nanoe™** 99%  
nanoe™. nanoe™ utilises nano-technology fine particles to purify the air in the room. It works effectively on airborne and adhesive micro-organisms such as certain types of bacteria, viruses and mould thus ensuring a cleaner living environment.

 **PM2.5 FILTER**  
PM2.5 Filter. Particulate matter (PM2.5) can be found suspended in the air, including dust, dirt, smoke and liquid droplets. Sized at 2.5µm, these particles are said to pose health problems as they can easily enter our lungs.

 **Antiallergy Properties**. System is equipped with antiallergy properties filter.

 **SUPER QUIET** 18dB(A)  
Super Quiet. Thanks to its latest generation compressor and its twin blade fan, our outdoor unit is one of the most silent on the market. The indoor unit emits an almost imperceptible 18 dB(A).

 **MILD DRY**  
Mild Dry Cooling. Fine control helps prevent a rapid decrease in room humidity while maintaining the set temperature. Maintains an RH\* up to 10% higher than cooling operation (\*RH: Relative Humidity). Ideal when sleeping with the air conditioner on.

 **AEROWINGS**  
Aerowings. More comfort with Aerowings. Direct airflow to ceiling to create shower cooling effect by twin flap built in indoor.

 **COOLING MODE** -10°C  
Down to -10°C in cooling only mode. The air conditioner works in cooling only mode with an outdoor temperature of -10°C.

 **HEATING MODE** -15°C  
Down to -15°C in heating mode. The air conditioner works in heat pump mode with an outdoor temperature is as low as -15°C.

 **SUMMER HOUSE**  
Summer House. This innovative function keeps the house at 7/8°C to avoid freezing pipes during the winter. This function is highly appreciated in summer house or week end houses.

 **R22 RENEWAL**  
R22 Renewal. The Panasonic renewal system allows good quality existing R22 pipe work to be re-used whilst installing new high efficiency R410A systems.

 **R410A/R22 RENEWAL**  
R410A/R22 Renewal. The Panasonic renewal system allows good quality existing R410A or R22 pipe work to be re-used whilst installing new high efficiency R32 systems.

 **Odour-removing function**. Allows the exchanger to be cleaned, preventing possible odours. While this function is connected, the fan also remains off momentarily to avoid unpleasant odours while the exchanger is being cleaned.

 **Removable, washable panel**. The front panel is easy to keep clean. It can be removed quickly in one single step and can be washed in water. A clean front panel ensures smoother, more efficient operation, which can save energy.

 **Powerful Mode**. The rapid and effective powerful mode is ideal for when you come home on the hottest or coldest days. It works at maximum power to reach the desired temperature in just 15 minutes.

 **Soft Dry Operation Mode**. The soft dry mode eliminates excess moisture with a soft breeze and provides a sense of wellbeing without much change in temperature.

 **Personal Airflow Creation**. Permits the air direction to be adjusted vertically and horizontally. This feature can be conveniently selected by remote controller.

 **Automatic Vertical Airflow Control**. The flap swings up and down automatically. The flow can also be set at a fixed angle with the remote controller.

 **Manual Horizontal Airflow Control**.

 **Auto Mode (Inverter)**. Automatically changes from cooling to heating depending on the set temperature for the room.

 **Simple Auto Changeover**. When the difference between the measured temperature and the set temperature is 3°C or more, it automatically switches the current operation mode to heating or cooling mode necessary to keep the temperature at a constantly comfortable level.

 **Hot Start Mode**. At the start of heating cycle and after defrost cycle, the indoor fan will start up once the indoor heat exchanger is warm.

 **24 DUAL**  
Real time clock with dual ON/OFF timer. This feature enables you to preset two different sets of start/stop operation timer (hour and minute) within a 24-hour time frame.

 **24**  
Real time clock with single ON/OFF timer. The exact operating time (hour and minute) can be set in advance. From here on, the unit will operate in accordance to these preset hours every day until the system is reset.

 **LCD Wireless Remote Controller**.

 **Automatic Restart**. This function permits automatic restarting if safe mode operation has stopped for some unusual reason, such as after a power cut. As soon as the power is back, the unit restarts with the parameters selected before it stopped.

 **Long Piping**. Indicates the maximum length of pipe between the outdoor unit and the indoor unit(s). The distances permitted, demonstrate the installations possible.

 **Top-Panel Maintenance Access**. Maintenance of an outdoor unit used to be quite a tedious task. Now, with the possibility of removing the top cover, maintenance is quick and easy.

 **Self-Diagnosis Function**. With this function the unit carries out a process self-diagnosis when a particular function does not work correctly. This allows faster servicing.

## High connectivity

 **INTEGRATION P LINK**  
CZ-CAPRA1: CZ-CNT port integration to PACi and ECOi. Domestic integration to P Link. Can connect ranges to P Link. Full control is now possible.

 **INTERNET CONTROL**  
Internet Control. Internet Control is a next generation system providing user-friendly remote controller of air conditioning or heat pump units from everywhere, using a simple Android or iOS smartphone, tablet or PC via internet.

 **BMS CONNECTIVITY**  
Easy control by BMS. The communication port is integrated into the indoor unit and provides easy connection to, and control of, your Panasonic heat pump to your home or building management system.

 **5 YEARS WARRANTY**  
5 Years Warranty. Panasonic guarantees the compressors in the entire range for five years.

# ACCESSORIES & CONTROL

## Optional PCB's for additional functions



**CZ-TACG1**  
NEW Panasonic WLAN kit for internet control.



**CZ-CAPRA1**  
RAC interface adapter for integration into P Link.



**PAW-AC-KNX-1i**  
KNX interface for TKE and UKE models.



**PAW-AC-MBS-1**  
Modbus interface for TKE and UKE models.



**PAW-AC-ENO-1i**  
EnOcean interface for TKE and UKE models.



**PAW-AC-BAC-1**  
BacNet interface for TKE and UKE models.



**PAW-AC-DIO**  
PCB for wall mounted with dry contacts, On/Off, Error message (all OKE and RKE wall mounted).



**PAW-AC-HEAT-1**  
Heating only PCB for Etherea, 4 Way 60x60 Cassette and Hide Away.



**PAW-SMSPCONTROL**  
Control of the Etherea, Flagship and Heatcharge by SMS (need additional SIM card).

## Individual Controls



**CZ-RD514C**  
Wired remote controller for Wall Mounted and Floor Console.



**CZ-RD52CP**  
Wired remote controller for Cassette.

## Panels



**CZ-BT20EW**  
NEW RAL9010 panel for 4 Way 60x60 Cassette.

## Pipe reducer



**CZ-MA1P**  
Is to be used to reduce the connection size on the indoor unit from 1/2" to 3/8".

**CZ-MA2P**  
Is to be used to increase the connection size on the outdoor unit from 3/8" to 1/2".

**CZ-MA3P**  
Is to be used to reduce the connection size on the indoor unit from 5/8" to 1/2".





Free Multi 3x1 CU-3Z52TBE. Minimum capacity connected: 4,5kW. Maximum capacity connected: 9,5kW • R32 GAS

Table with columns: Indoor unit capacity, Cooling capacity (kW), Rooms, EER, SEER¹, Input power rating, A.E.C., Current, Heating capacity (kW), Rooms, COP, SCOP¹, Input power rating, A.E.C., Current. Rows are categorized by room count (1 Room, 2 Rooms, 3 Rooms) and unit configurations.

1) Energy Label Scale from A+++ to D.





Free Multi 3x1 CU-3Z68TBE. Minimum capacity connected: 4,5kW. Maximum capacity connected: 11,2kW • R32 GAS

Table with columns: Indoor unit capacity, Cooling capacity (kW), Rooms, EER, SEER1, Input power rating, A.E.C., Current, Heating capacity (kW), Rooms, COP, SCOP1, Input power rating, A.E.C., Current. Includes rows for configurations like 25+25+35, 25+25+42, etc.

1) Energy Label Scale from A+++ to D.

Free Multi 4x1 CU-4Z68TBE. Minimum capacity connected: 4,5kW. Maximum capacity connected: 11,5kW • R32 GAS

Table with columns: Indoor unit capacity, Cooling capacity (kW), Rooms, EER, SEER1, Input power rating, A.E.C., Current, Heating capacity (kW), Rooms, COP, SCOP1, Input power rating, A.E.C., Current. Includes sections for 1 Room and 2 Rooms configurations.

Table with columns: Indoor unit capacity, Cooling capacity (kW), Rooms, EER, SEER1, Input power rating, A.E.C., Current, Heating capacity (kW), Rooms, COP, SCOP1, Input power rating, A.E.C., Current. Includes sections for 3 Rooms configurations.

Rating Conditions: Cooling Indoor 27°C DB / 19°C WB. Cooling Outdoor 35°C DB / 24°C WB. Heating Indoor 20°C DB. Heating Outdoor 7°C DB / 6°C WB. (DB: Dry Bulb; WB: Wet Bulb) Specifications subject to change without notice. For detailed information about ErP / Energy Labelling, please visit our websites www.aircon.panasonic.eu or www.ptc.panasonic.eu.











Free Multi System Z

R32

Free Multi 5x1 CU-5Z90TBE. Minimum capacity connected: 4,5kW. Maximum capacity connected: 18,3kW • R32 GAS

Table with 23 columns: Indoor unit capacity, Cooling capacity (kW), Rooms, EER, SEER1, Input power rating, A.E.C. Current, Heating capacity (kW), Rooms, COP, SCOP1, Input power rating, A.E.C. Current. Contains multiple rows for 1 Room, 2 Rooms, and 3 Rooms configurations.

Rating Conditions: Cooling Indoor 27°C DB / 19°C WB. Cooling Outdoor 35°C DB / 24°C WB. Heating Indoor 20°C DB / 6°C WB. (DB: Dry Bulb; WB: Wet Bulb) Specifications subject to change without notice. For detailed information about ErP / Energy Labelling, please visit our website www.aircon.panasonic.co.uk or www.ptc.panasonic.eu.





Free Multi 5x1 CU-SZ90TBE. Minimum capacity connected: 4,5kW. Maximum capacity connected: 18,3kW • R32 GAS

Table with columns: Indoor unit capacity, Cooling capacity (kW), Rooms, EER, SEER1, Input power rating, A.E.C. Current, Heating capacity (kW), Rooms, COP, SCOP1, Input power rating, A.E.C. Current. Rows list various configurations of indoor units and their performance metrics.

Rating Conditions: Cooling Indoor 27°C DB / 19°C WB. Cooling Outdoor 35°C DB / 24°C WB. Heating Indoor 20°C DB. Heating Outdoor 7°C DB / 4°C WB. WB: Wet Bulb. Specifications subject to change without notice. For detailed information about ErP / Energy Labelling, please visit our websites www.aircon.panasonic.eu or www.ptc.panasonic.eu.

FREE MULTI R32 COMBINATIONS TABLE

Free Multi 5x1 CU-5Z90TBE. Minimum capacity connected: 4,5kW. Maximum capacity connected: 18,3kW • R32 GAS

Table with 18 columns: Indoor unit capacity, Cooling capacity (kW), Rooms, EER, SEER, Input power, A.E.C., Current, Heating capacity (kW), Rooms, COP, SCOP, Input power, A.E.C., Current. Rows list various combinations of indoor units and their corresponding performance metrics.



FREE MULTI R32 COMBINATIONS TABLE

Free Multi 5x1 CU-5Z90TBE. Minimum capacity connected: 4,5kW. Maximum capacity connected: 18,3kW • R32 GAS

Table with columns: Indoor unit capacity, Cooling capacity (kW), EER, SEER, Input power, A.E.C., Current, Heating capacity (kW), COP, SCOP, Input power, A.E.C., Current. Rows list various indoor unit combinations and their performance metrics.





MULTI WALL TZ COMBINATIONS TABLE

Multi Wall TZ 2x1 CU-2TZ41TBE. Minimum capacity connected: 3,2kW. Maximum capacity connected: 6,0kW • R32 GAS

Table with 15 columns: Indoor unit capacity, Cooling capacity (kW), Rooms, EER, SEER1, Input power rating, A.E.C., Current, Heating capacity (kW), Rooms, COP, SCOP1, Input power rating, A.E.C., Current. Rows include 1 Room and 2 Rooms configurations.

Multi Wall TZ 2x1 CU-2TZ50TBE. Minimum capacity connected: 3,2kW. Maximum capacity connected: 7,7kW • R32 GAS

Table with 15 columns: Indoor unit capacity, Cooling capacity (kW), Rooms, EER, SEER1, Input power rating, A.E.C., Current, Heating capacity (kW), Rooms, COP, SCOP1, Input power rating, A.E.C., Current. Rows include 1 Room and 2 Rooms configurations.

1) Energy Label Scale from A+++ to D.

















Free Multi 4x1 CU-4E27PBE. Minimum capacity connected: 4,5kW. Maximum capacity connected: 13,6 kW • R410A GAS

Table with columns: Indoor unit capacity, Cooling capacity (kW), Rooms, EER, SEER1, Input power rating, A.E.C., Current, Heating capacity (kW), Rooms, COP, SCOP1, Input power rating, A.E.C., Current. Rows include configurations like 20+35+71, 20+42+42, up to 16+25+35+50.

Rating Conditions: Cooling Indoor 27°C DB / 19°C WB. Cooling Outdoor 35°C DB / 24°C WB. Heating Indoor 20°C DB. Heating Outdoor 7°C DB / 4°C WB. (DB: Dry Bulb; WB: Wet Bulb) Specifications subject to change without notice.





Free Multi 5x1 CU-5E34PBE. Minimum capacity connected: 4,5kW. Maximum capacity connected: 17,5kW • R410A GAS

Table with columns for Indoor unit capacity, Cooling capacity (kW), Rooms, EER, Input power rating, A.E.C., Current, Heating capacity (kW), Rooms, COP, Input power rating, A.E.C., and Current. Rows are categorized by room count (1, 2, 3 rooms) and include various unit combinations and capacities.

Rating Conditions: Cooling Indoor 27°C DB / 19°C WB. Cooling Outdoor 35°C DB / 24°C WB. Heating Indoor 20°C DB. Heating Outdoor 7°C DB / 4°C WB. (DB: Dry Bulb; WB: Wet Bulb) Specifications subject to change without notice. For detailed information about ErP / Energy Labelling, please visit our websites www.aircon.panasonic.eu or www.ptc.panasonic.eu.



Free Multi 5x1 CU-5E34PBE. Minimum capacity connected: 4,5kW. Maximum capacity connected: 17,5kW • R410A GAS

Table with 14 columns: Indoor unit capacity, Cooling capacity (kW), Rooms, EER, Input power rating, A.E.C., Current, Heating capacity (kW), Rooms, COP, Input power rating, A.E.C., Current. Rows list various unit configurations like 16+16+50+71, 16+20+20+20, etc.

Rating Conditions: Cooling Indoor 27°C DB / 19°C WB. Cooling Outdoor 35°C DB / 24°C WB. Heating Indoor 20°C DB. Heating Outdoor 7°C DB / 4°C WB. (DB: Dry Bulb; WB: Wet Bulb) Specifications subject to change without notice.







Free Multi 5x1 CU-5E34PBE. Minimum capacity connected: 4,5kW. Maximum capacity connected: 17,5kW • R410A GAS

Table with columns: Indoor unit capacity, Cooling capacity (kW). Rooms, EER, Input power rating, A.E.C., Current, Heating capacity (kW). Rooms, COP, Input power rating, A.E.C., Current. It lists various indoor unit configurations and their corresponding performance metrics.

1) Energy Label Scale from A+++ to D. Showing SEER and Pdesign (kWh) / SCOP and Pdesign at -10°C (kWh). Using EN 14825. Other: A.E.C. using internal procedure (only for reference). \* EER, COP, SEER, SCOP, Input power, Annual consumption is show following EU/626/2011 only on the 100% capacity combination as requested by the EU Regulation. \* Data for not simultaneous operation.

## MULTI WALL RE COMBINATIONS TABLE

### Multi Wall RE 2x1 CU-2RE15SBE. Minimum capacity connected: 4,0kW. Maximum capacity connected: 5,7kW • R410A GAS

Indoor unit capacity	Cooling capacity (kW). Rooms			EER	SEER <sup>1)</sup>	Input power rating	A.E.C.	Current	Heating capacity (kW). Rooms			COP	SCOP <sup>1)</sup>	Input power rating	A.E.C.	Current		
	A	B	Total (Min - Max)						W/W	W/W	kW						kWh	230V
<b>1 Room</b>																		
20	2,00		2,00 (1,10 - 2,50)	3,64	<b>A</b>	0,55 (0,23 - 0,69)	275	2,60	3,20		3,20 (0,70 - 4,30)	3,40	<b>B</b>	0,94 (0,19 - 1,35)	470	4,15		
25	2,50		2,50 (1,10 - 3,10)	3,52	<b>A</b>	0,71 (0,23 - 0,95)	355	3,35	3,60		3,60 (0,70 - 5,00)	3,21	<b>C</b>	1,12 (0,19 - 1,66)	560	4,95		
35	3,20		3,20 (1,10 - 3,70)	3,27	<b>A</b>	0,98 (0,23 - 1,21)	490	4,60	4,50		4,50 (0,70 - 5,70)	3,24	<b>C</b>	1,39 (0,19 - 1,78)	695	6,15		
<b>2 Rooms</b>																		
20+20	2,00	2,00	4,00 (1,50 - 4,60)	3,42	<b>A</b>	1,17 (0,27 - 1,34)	585	5,45	2,40	2,40	4,80 (1,10 - 6,30)	4,00	<b>A</b>	1,20 (0,24 - 1,61)	600	5,35		
20+25	1,95	2,45	4,40 (1,50 - 4,80)	3,38	<b>A</b>	6,50 <b>A+++</b>	1,30 (0,27 - 1,52)	650	6,10	2,15	2,65	4,80 (1,10 - 6,50)	4,00	<b>A</b>	4,00 <b>A+</b>	1,20 (0,24 - 1,67)	600	5,35
20+35	1,70	2,70	4,40 (1,50 - 4,80)	3,38	<b>A</b>	1,30 (0,27 - 1,52)	650	6,10	1,85	2,95	4,80 (1,10 - 6,50)	4,00	<b>A</b>	1,20 (0,24 - 1,67)	600	5,35		
25+25	2,20	2,20	4,40 (1,50 - 4,80)	3,38	<b>A</b>	1,30 (0,27 - 1,52)	650	6,10	2,40	2,40	4,80 (1,10 - 6,50)	4,00	<b>A</b>	1,20 (0,24 - 1,67)	600	5,35		
25+35	1,95	2,45	4,40 (1,50 - 4,80)	3,38	<b>A</b>	1,30 (0,27 - 1,52)	650	6,10	2,15	2,65	4,80 (1,10 - 6,50)	4,00	<b>A</b>	1,20 (0,24 - 1,67)	600	5,35		

### Multi Wall RE 2x1 CU-2RE18SBE. Minimum capacity connected: 4,0kW. Maximum capacity connected: 7,5kW • R410A GAS

Indoor unit capacity	Cooling capacity (kW). Rooms			EER	SEER <sup>1)</sup>	Input power rating	A.E.C.	Current	Heating capacity (kW). Rooms			COP	SCOP <sup>1)</sup>	Input power rating	A.E.C.	Current		
	A	B	Total (Min - Max)						W/W	W/W	kW						kWh	230V
<b>1 Room</b>																		
20	2,00		2,00 (1,10 - 2,50)	3,64	<b>A</b>	0,55 (0,23 - 0,69)	275	2,60	3,20		3,20 (0,70 - 4,30)	3,40	<b>B</b>	0,94 (0,19 - 1,35)	470	4,15		
25	2,50		2,50 (1,10 - 3,10)	3,52	<b>A</b>	0,71 (0,23 - 0,95)	355	3,35	3,60		3,60 (0,70 - 5,00)	3,21	<b>C</b>	1,12 (0,19 - 1,66)	560	4,95		
12	3,20		3,20 (1,10 - 3,70)	3,27	<b>A</b>	0,98 (0,23 - 1,21)	490	4,60	4,50		4,50 (0,70 - 5,70)	3,24	<b>C</b>	1,39 (0,19 - 1,78)	695	6,15		
42	4,00		4,00 (1,10 - 4,20)	3,10	<b>B</b>	1,29 (0,23 - 1,42)	645	6,05	5,00		5,00 (1,10 - 6,40)	3,03	<b>D</b>	1,65 (0,24 - 2,18)	825	7,30		
50	5,00		5,00 (1,20 - 5,10)	2,94	<b>C</b>	1,70 (0,24 - 1,82)	850	7,95	5,30		5,30 (1,10 - 6,80)	3,01	<b>D</b>	1,76 (0,24 - 2,29)	880	7,80		
<b>2 Rooms</b>																		
20+20	2,00	2,00	4,00 (1,50 - 4,60)	3,45	<b>A</b>	1,16 (0,27 - 1,34)	580	5,45	2,60	2,60	5,20 (1,10 - 6,30)	4,00	<b>A</b>	1,30 (0,24 - 1,61)	650	5,80		
20+25	2,00	2,50	4,50 (1,50 - 4,80)	3,44	<b>A</b>	1,31 (0,27 - 1,51)	655	6,10	2,30	2,90	5,20 (1,10 - 6,30)	4,00	<b>A</b>	1,30 (0,24 - 1,61)	650	5,80		
20+12	1,85	2,95	4,80 (1,50 - 4,90)	3,22	<b>A</b>	1,49 (0,27 - 1,58)	745	6,95	2,00	3,20	5,20 (1,10 - 6,70)	4,00	<b>A</b>	1,30 (0,24 - 1,70)	650	5,75		
20+42	1,60	3,20	4,80 (1,50 - 5,00)	3,22	<b>A</b>	1,49 (0,27 - 1,58)	745	6,95	1,75	3,45	5,20 (1,10 - 6,70)	4,00	<b>A</b>	1,30 (0,24 - 1,70)	650	5,75		
20+50	1,35	3,45	4,80 (1,50 - 5,00)	3,22	<b>A</b>	1,49 (0,27 - 1,58)	745	6,95	1,50	3,70	5,20 (1,10 - 6,70)	4,00	<b>A</b>	1,30 (0,24 - 1,70)	650	5,75		
25+25	2,40	2,40	4,80 (1,50 - 5,00)	3,22	<b>A</b>	6,50 <b>A+++</b>	1,49 (0,27 - 1,58)	745	6,95	2,60	2,60	5,20 (1,10 - 6,70)	4,00	<b>A</b>	4,00 <b>A+</b>	1,30 (0,24 - 1,70)	650	5,75
25+12	2,10	2,70	4,80 (1,50 - 5,00)	3,22	<b>A</b>	1,49 (0,27 - 1,58)	745	6,95	2,30	2,90	5,20 (1,10 - 6,70)	4,00	<b>A</b>	1,30 (0,24 - 1,70)	650	5,75		
25+42	1,85	2,95	4,80 (1,50 - 5,00)	3,22	<b>A</b>	1,49 (0,27 - 1,58)	745	6,95	2,00	3,20	5,20 (1,10 - 6,70)	4,00	<b>A</b>	1,30 (0,24 - 1,70)	650	5,75		
25+50	1,60	3,20	4,80 (1,50 - 5,00)	3,22	<b>A</b>	1,49 (0,27 - 1,58)	745	6,95	1,75	3,45	5,20 (1,10 - 6,70)	4,00	<b>A</b>	1,30 (0,24 - 1,70)	650	5,75		
12+12	2,40	2,40	4,80 (1,50 - 5,00)	3,22	<b>A</b>	1,49 (0,27 - 1,58)	745	6,95	2,60	2,60	5,20 (1,10 - 6,70)	4,00	<b>A</b>	1,30 (0,24 - 1,70)	650	5,75		
12+42	2,15	2,65	4,80 (1,50 - 5,00)	3,22	<b>A</b>	1,49 (0,27 - 1,58)	745	6,95	2,30	2,90	5,20 (1,10 - 6,70)	4,00	<b>A</b>	1,30 (0,24 - 1,70)	650	5,75		

<sup>1)</sup> Energy Label Scale from A+++ to D. Showing SEER and Pdesign (kWh) / SCOP and Pdesign at -10°C (kWh): Using EN 14825. Other: A.E.C. using internal procedure (only for reference).  
 \* EER, COP, SEER, SCOP, Input power, Annual consumption is show following EU/626/2011/ only on the 100% capacity combination as requested by the EU Regulation.  
 \* Data for not simultaneous operation.



Multi Wall RE

R410A

Multi Wall RE 3x1 CU-3RE18SBE. Minimum capacity connected: 4,5kW. Maximum capacity connected: 9,0kW • R410A GAS

Table with columns: Indoor unit capacity, Cooling capacity (kW), Rooms, EER, SEER1, Input power rating, A.E.C., Current, Heating capacity (kW), Rooms, COP, SCOP1, Input power rating, A.E.C., Current. Rows are categorized by room count (1 Room, 2 Rooms, 3 Rooms) and room configurations (e.g., 16+16, 16+20, etc.).

1) Energy Label Scale from A+++ to D. Showing SEER and Pdesign (kWh) / SCOP and Pdesign at -10°C (kWh). Using EN 14825. Other: A.E.C. using internal procedure (only for reference). \* EER, COP, SEER, SCOP, Input power, Annual consumption is show following EU/626/2011 only on the 100% capacity combination as requested by the EU Regulation. \* Data for not simultaneous operation.

# WELCOME TO THE COMMERCIAL RANGE

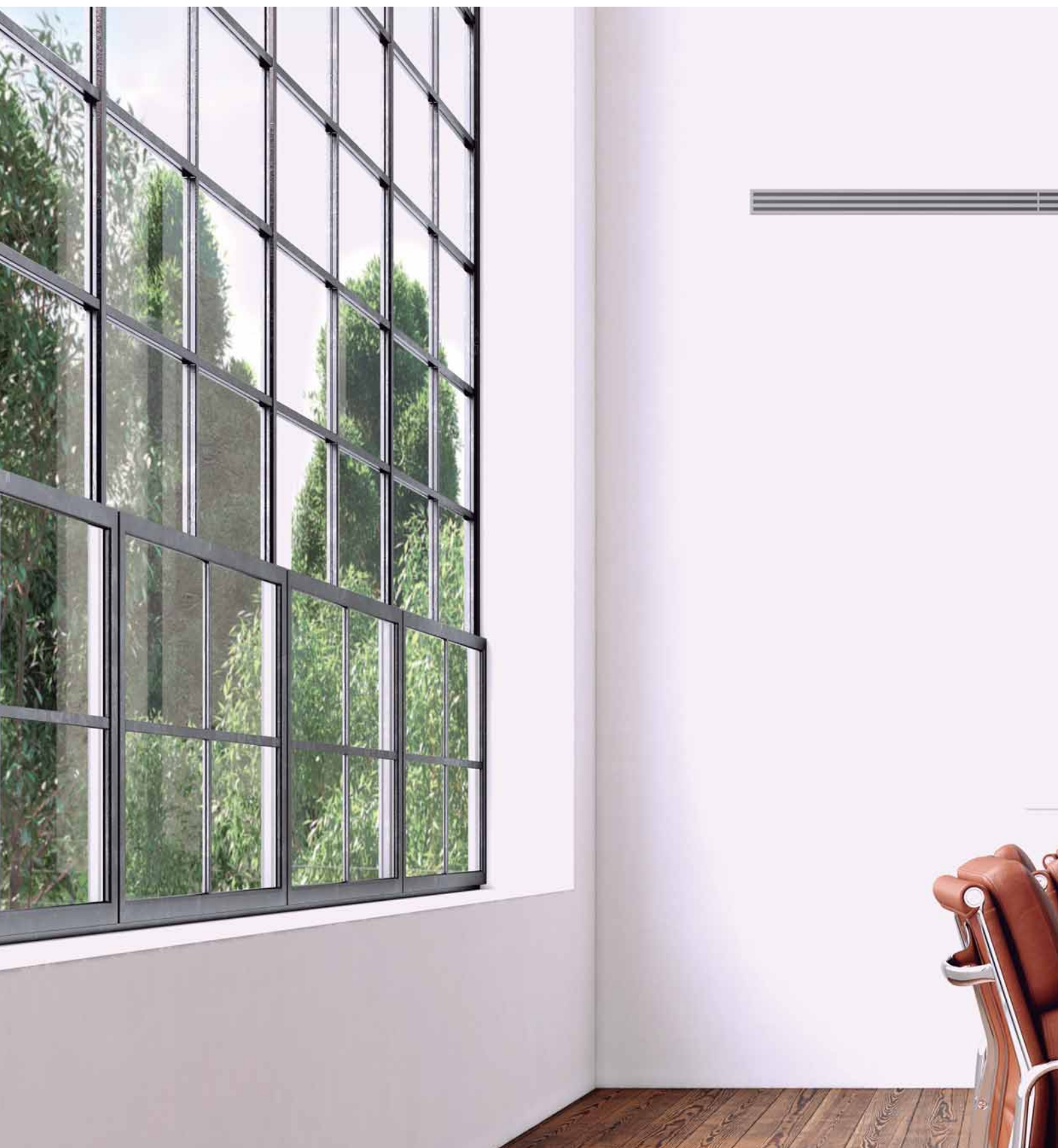

Panasonic has developed an impressive range of highly efficient commercial air conditioners. This range confirms our commitment to the environment. Our Inverter compressors optimise performance, here are some of the major features these air conditioning solutions offer.



# HIGHLIGHTED FEATURES

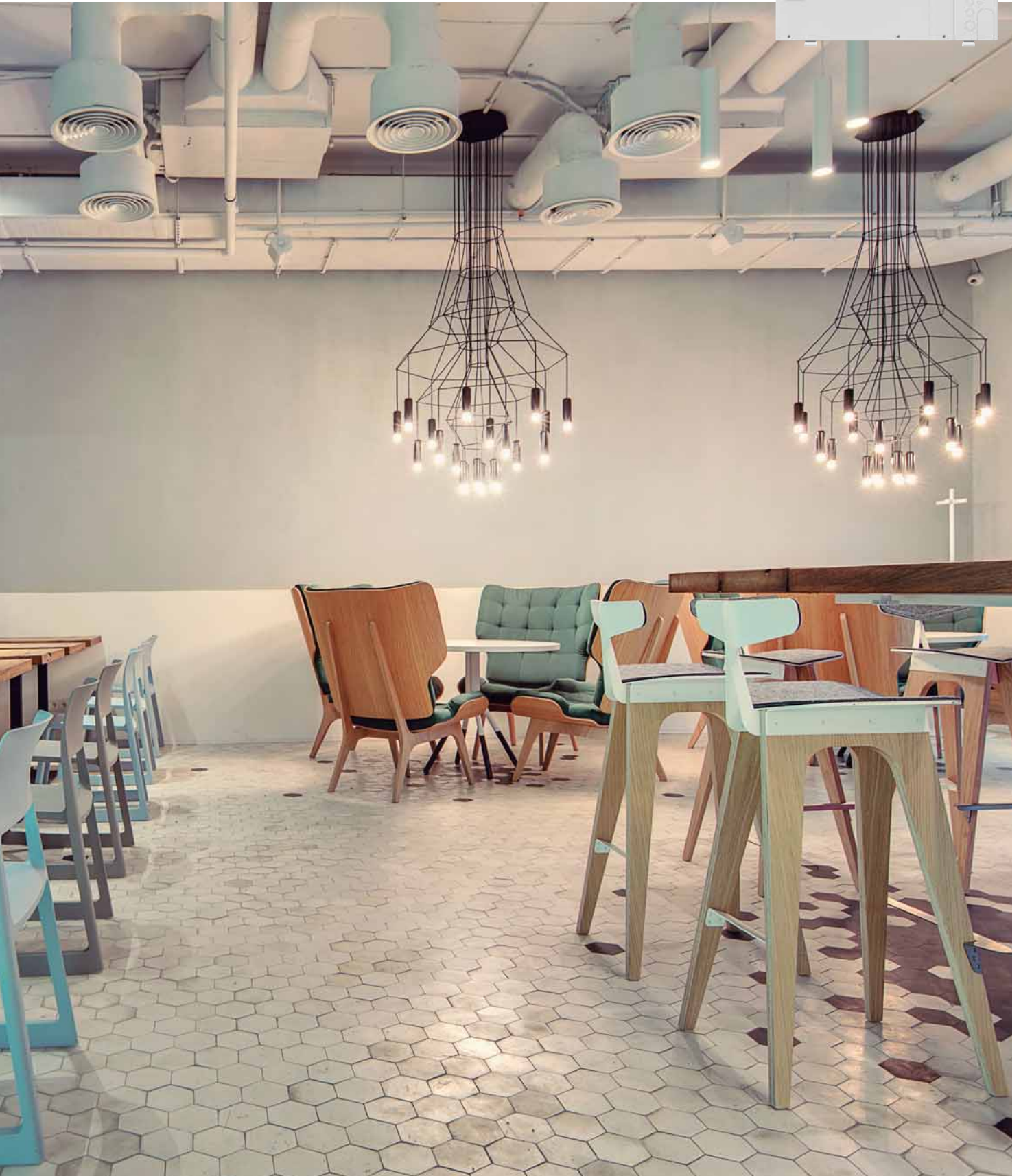



**PACi: Commercial air to air. The compact and high efficiency solution for shops, restaurants, offices or residential applications.**

**Commercial benefits**

**Great savings and improved comfort.**

Panasonic has developed an impressive range of highly efficient Commercial Air Conditioners. Our Inverter compressors optimise performance.

**A wide range for the industry, office or residence.**

From the smaller 1x1 to the more complete 4x1 solutions, Panasonic can

offer the most comfortable climate with solutions designed for every environment.

**High connectivity.**

The control systems allow you to manage all of your units for several locations. Receive real time status updates and maintenance alerts, while optimizing costs and energy usage.

**Energy saving**

**28%**  
ECONAVI

Intelligent Human Activity Sensor and Sunlight Sensor technologies that can detect and reduce waste of energy by optimising air conditioner operation according to room conditions. With just one touch of a button, you can save energy.

**A++**  
7,80 SEER

Exceptional Seasonal Cooling Efficiency based on the new ErP regulation. Higher SEER ratings mean greater efficiency. Save all the year while cooling!

**A+++**  
5,10 SCOP

Exceptional Seasonal Heating Efficiency based on the new ErP regulation. Higher SCOP ratings mean greater efficiency. Save all the year while heating!

**INVERTER+**

Inverter Plus System classification highlights the highest performing Panasonic systems.

**HIGH EFFICIENT COMPRESSOR**

Compressors that operate with a wider Hz range realize a more efficient operation throughout the year. For Big PACi Series PEZ.

**R32**  
NEW REFRIGERANT GAS

Our heat pumps containing the new refrigerant R32 show a drastic reduction in the value of Global Warming Potential (GWP). An important step to reduce greenhouse gases. R32 is also a components refrigerant, making it easy to recycle.

**High performance**

**BLUEFIN**

Panasonic has extended the life of its condensers with an original anti-rust coating. For Big PACi Series PEZ.

**BIG SIZE FAN**

Big size Fan provides larger airflow rate and very silent operation at low speed. For Big PACi Series PEZ.

**DC FAN**

DC Fan: Safe and precise.

**-15°C**  
COOLING MODE

The air conditioner works in cooling mode with an outdoor temperature of -15°C.

**-20°C**  
HEATING MODE

The air conditioner works in heat pump mode even when outdoor temperatures are as low as -20°C or -15°C.

**R410A/R22 RENEWAL**

The Panasonic renewal system allows good quality existing R410A or R22 pipe work to be re-used whilst installing new high efficiency R32 systems.

**R22 RENEWAL**

The Panasonic renewal system allows good quality existing R22 pipe work to be re-used whilst installing new high efficiency R410A systems.

**5 YEARS COMPRESSOR WARRANTY**

5 years warranty. We guarantee the outdoor unit compressors in the entire range for five years.

**High connectivity**

**PROFESSIONAL AC SMART CLOUD**

The AC Smart Cloud from Panasonic allows you to have complete control of all your installations. In a simple click, receive status updates from all your units in real-time, preventing breakdowns and optimizing costs.

**INTERNET CONTROL**

Internet Control is a next generation system providing a user-friendly remote control of air conditioning or heat pump units from everywhere, using a simple Android or iOS smartphone, tablet or PC via internet.

**BMS CONNECTIVITY**

The communication port is integrated into the indoor unit and provides easy connection to, and control of, your Panasonic heat pump to your home or building management system.

# PACi OUTDOOR UNITS ENERGY SAVING CONCEPT



Product quality and safety. All Panasonic air conditioners undergo strict quality and safety tests before sale. This rigorous process includes obtaining all necessary safety approvals, to ensure that all air conditioners we sell are not only built to the highest market standards, but are also completely safe.



### New PACi R32 Refrigerant Gas

Panasonic recommends R32 because it is comparably environmentally friendly. Compared to R22 and R410A, R32 has a very low potential impact on the depletion of ozone layer and global warming.

In line with the European Countries who are concerned in protecting and maintaining the environment by participating in the Montreal Protocol to protect the Ozone Layer and prevent Global Warming, Panasonic is leading the switch to R32.

### PACi Elite: Newly designed next generation of commercial air conditioning

Outstanding performance at low temperatures, high energy efficiency, power consumption in remote control display. The energy saving design structure of fans, fan motors, compressors and heat exchangers resulted in high COP value which ranked as one the top class in the industry. Additional benefits include reduced CO<sub>2</sub> emissions, energy consumption and operating costs.

#### PACi Elite. From 3,60 to 25,00kW.

- Meeting all necessary safety approvals to ensure quality and safety
- Top-class SEER: A++ / SCOP: A+++ at 3,60kW (in 90x90 Cassette)
- Cooling operation is possible when outdoor temperature as high as 46°C
- DC inverter technology combined with R32 and R410A
- Cooling operation is possible when outdoor temperature is as low as -15°C
- Heating operation is possible when outdoor temperature is as low as -20°C
- Compact outdoor units
- Auto restart from outdoor unit
- Twin, Triple and Double-Twin connection possible

#### 1. Installation innovation.

- Extremely easy to install, practically the same as R410A. (Just remember to verify that the pressure gauge and vacuum pump are compatible with R32)
- This refrigerant is 100% pure, which makes it easier to recycle and reuse

#### 2. Environmental innovation.

- Zero impact on the ozone layer
- 75% less impact on global warming

#### 3. Economic and energy consumption innovation.

- Lower cost and greater savings
- Higher energy efficiency than R410A

### PACi Standard: For economy and value

With high quality design and engineering, the PACi Standard is the perfect solution for projects which demand quality on a limited budget. In addition, its compact and lightweight design makes it ideal for installations with limited space including small commercial and residential applications.

The outdoor unit is much more compact than the previous model. The slim and lightweight design means the PACi outdoor unit can be installed in a number of situations.

#### PACi Standard. From 6,00 to 14,00kW.

- Good balance, system cost vs energy efficiency
- Top class SEER/SCOP as a Standard Inverter category  
SEER: A++ / SCOP: A++ at 6,00 and 7,10kW (in 90x90 Cassette)
- Interchangeable controller with ECOi
- Compact outdoor units
- Twin connection possible
- Cooling operation up to -10°C
- Heating operation up to -15°C



### Big PACi Elite R410A. Trusted power and high efficiency

PACi 20,00 and 25,00kW are designed to adapt the most current and demanding commercial needs. Ready to connect to 1 big ducted indoor unit or up to 4 indoor units.

#### Large capacity PACi Elite:

- High efficiency
- Better partial load (10% ~ 100%)
- More flexible piping
- Bluefin anti-rust coating
- 0-10V control demand
- Energy saving functions
- AHU connection kit
- From 1 to 4 indoor units

# PACi ELITE: EXCELLENT SEER AND SCOP VALUES





High operating efficiency using DC inverter compressor, DC motor and a heat exchanger design.

### New PACi R32 seasonal efficiency for daily energy saving

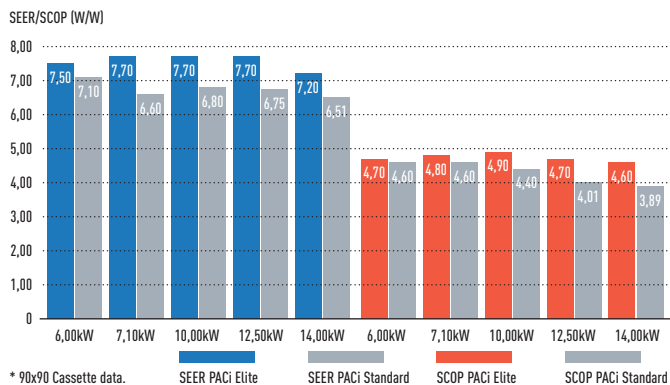

### Increased piping length for greater design flexibility

Adaptable to various building types and sizes.  
Maximum piping length: 75m (10,00, 12,50, 14,00kW). 50m (6,00, 7,10kW).

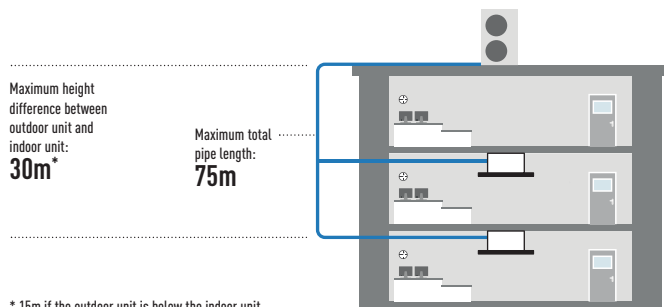

### PACi Elite design operation conditions

Cooling operation is possible when outdoor temperature is as low as -15°C or as high as 46°C. Heating operation is possible when outdoor temperature is as low as -20°C. The remote control temperature setting offers a range from 18°C to 30°C.

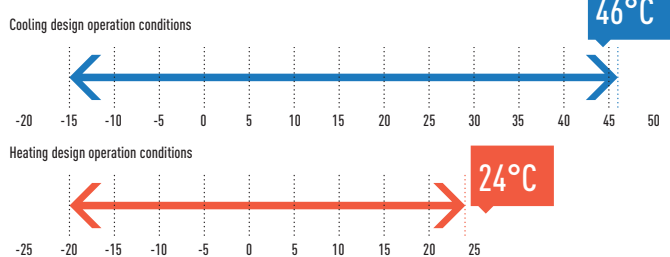

### Compact & Flexible-design

The slim and lightweight design means the PACi outdoor unit can be installed in a number of compact situations. As the unit only weighs 98kg (R410A), it is easy to carry and easy to install.

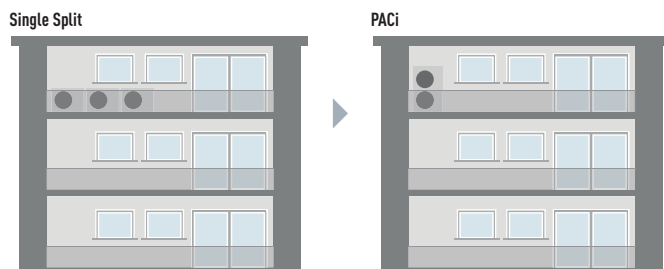

### Energy consumption monitoring display with the CZ-RTC5B

MENU 20:00 (Thu)

- 5.SILENT OPERATION
- 6.FILTER information
- 7.FILTER RIZE AND FALL
- 8.ENERGY-SAVING MONITOR
- ITEM Selection [←→]

Menu selection: 3 types (Day/Week/Year) of display are available.

Power consumption 20:30 (Thu)

Daily Energy consumption: Data is shown with Yesterday's record. (Graph starts from 0 o'clock to 24 o'clock only.)

Weekly Energy consumption: Power consumption of each day of the week can be checked.

Power consumption 20:30 (Thu)

Annual Energy consumption: Power consumption of each month can be checked.



Datanavi, a new way to connect.  
Simple and easy support tool with your smartphone.



### Demand response compliant (CZ-CAPDC3) as a standard function

This terminal allows demand control of the outdoor unit.  
Several setting levels are available:

- Level-1, 2, 3 : 75 / 50 / 0 %
- Level-1, 2 can be set in 40 - 100% (40, 45, 50...95, 100: each 5%)

Demand control terminal is available to control 0-50-75% of capacities.  
CZ-CAPDC3 is an optional for R410A models.

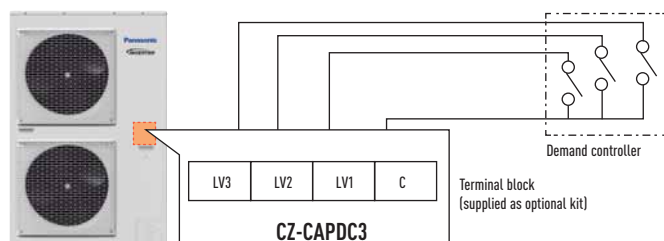

# SOLUTIONS FOR SERVER ROOMS



High efficiency products for 24/7 applications. Panasonic has developed a complete range of solutions for server rooms which efficiently protect your servers, keeping them at an appropriate temperature even when the outdoor temperature is below -20°C.



**High efficiency all the year**

**Key points:**

- **NEW!** From 2,5 to 7,10kW with new TKEA R32 gas units A+++ in cooling
- PACi units from 3,6 to 14kW
- Backup function
- Redundancy function
- Alternative run function
- Error information by dry contact
- Operation even at -20°C outdoor temperature
- High seasonal performance
- Product design for 24/7 operation

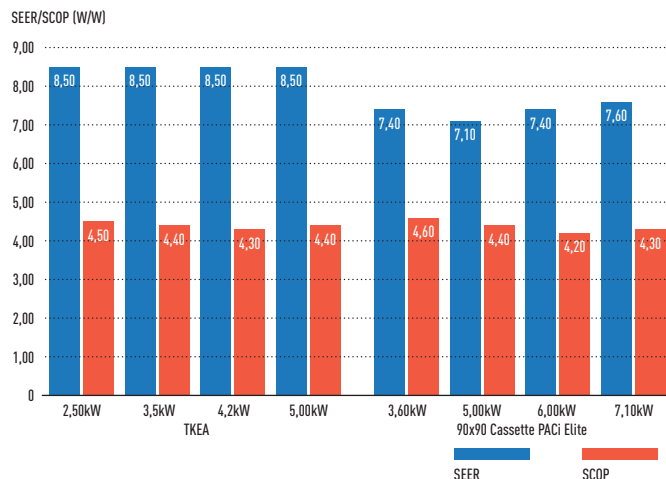

**Interface to run 2 TKEA / PKEA. PAW-SERVER-PKEA**

The PAW-SERVER-PKEA server room interface manages redundancy and backup of two TKEA / PKEA units with two different selectable modes:

- Plug and play by embedded redundancy and backup algorithm (no external signal needed. Further details please refer to operation manual)
- External (third party PLC) redundancy and backup management by dry contact

All settings are possible without the need for a computer connection. A special Energy Saving Mode is selectable by deep switch (available only in plug and play mode). The level of remote control input prohibition can be set when external management is by dry contact.

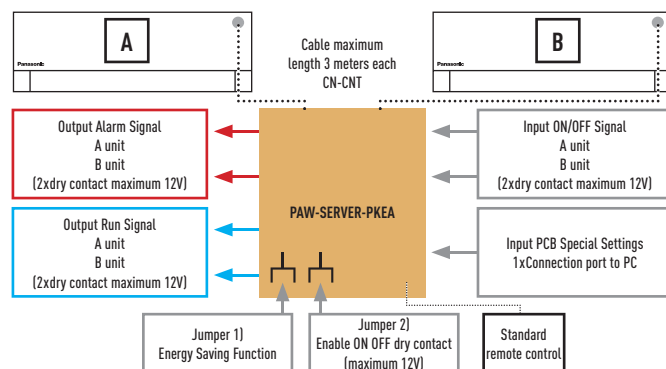

**Interfaces to run 2 or 3 PACi and VRF indoor units**

**PAW-PACR3.**

In combination with one PAW-T10V on each indoor unit, allows the redundant operation of 2 (or 3) PACi or VRF indoor units. All units will be operated by programmable turns in order to achieve the same operating time (example turn every 8 hours within a 24 hour period). If the room temperature exceeds a freely set value, the 2nd (or 3rd) unit will be switched ON and an alarm will be activated.

**Backup control by using CZ-RTC5B.**

Group wiring of 2 systems of PACi can do auto individual control.

- Rotation operation
- Backup operation
- Support operation

**CZ-CAPRA1.**

RAC interface adapter for integration into P Link.

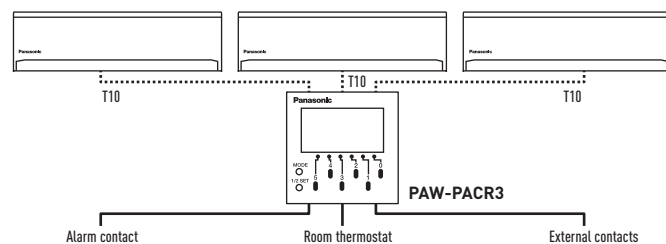

**Display and Settings:**

- Possible to select next unit manually
- Possible to reset operation
- LED display shows operation status of the 2 or 3 units
- Operation status output
- Alarm LED and alarm output
- Temperature limit can be set
- Temperature hysteresis can be set
- Room temperature is displayed
- Time counter displayed

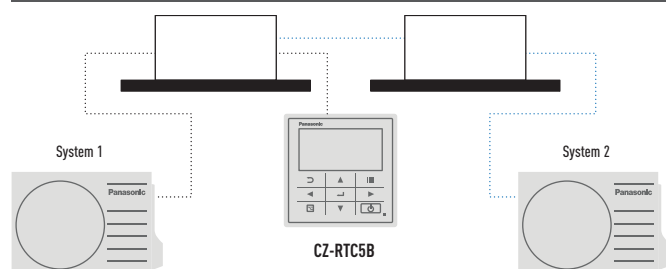

# GENERATION PACi 90x90 CASSETTE



Panasonic introduces a new modern flat panel design to blend into any space. These Cassettes have been developed to satisfy today's customer needs such as high energy saving, comfort and healthier air.

**PACi Cassette Panasonic**

- Better SCOP & SEER (up to 15%)
- Advanced comfort and energy saving by Econavi sensor
- Air purification nanoe™ X system
- Super quiet operation from 27dB(A)

These Cassettes offer upgraded Econavi and nanoe™ X purification systems as accessories for making application space more comfortable, healthy and efficient.



**Always fresh and clean air with nanoe™ X**

- nanoe™ X is available with the advanced technology of room air conditioning.
- Purifying operation can work simultaneously or independently from heating/cooling operation.
  - Inhibiting certain viruses, bacteria & deodorisation (bacteria, fungus, pollen, virus and cigarette smoke). OH radicals in nanoe™ X pull bacteria's hydrogen out to effectively deodorise and sterilise
  - Clean inside by nanoe™ X + Dry control: inside of indoor unit can be cleaned by short operation circuit with nanoe™ X and drying

CZ-RTC5B and optional accessory CZ-CNEXU1 are required to use nanoe™ X function.

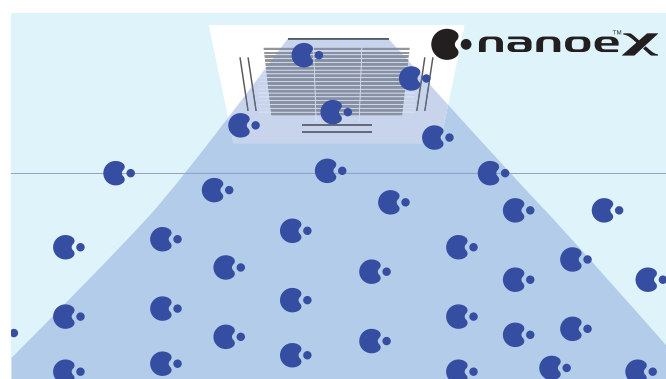

**Econavi intelligent sensor**

Human activity sensor and floor temperature sensor can reduce waste of energy by optimising air conditioner operation.



**Advanced Econavi functions.**

2 sensors (movement and floor temperature) can find waste of energy and control effectively. Floor temperature can detect up to 5m ceiling height.

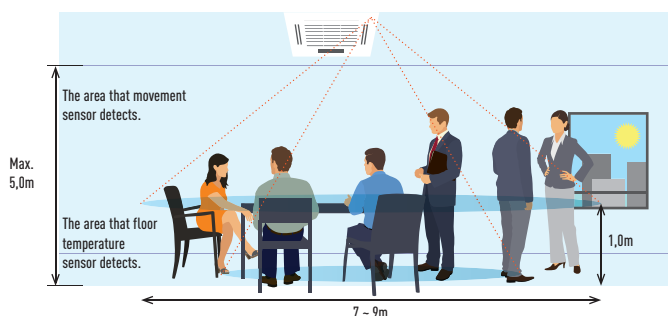

**Econavi exclusive panel. Optional (CZ-KPU3A)**



**Floor temperature sensor.**  
This sensor detects average floor temperature and operates circulation if floor temperature is low.



**Wired remote controller CZ-RTC5B is required.**

**Movement sensor.**  
This sensor detects the amount of human activity, and operates effectively.

**Humidity sensor.**

Humidity sensor has air suction function, and realises comfort and energy saving based on temperature and humidity.

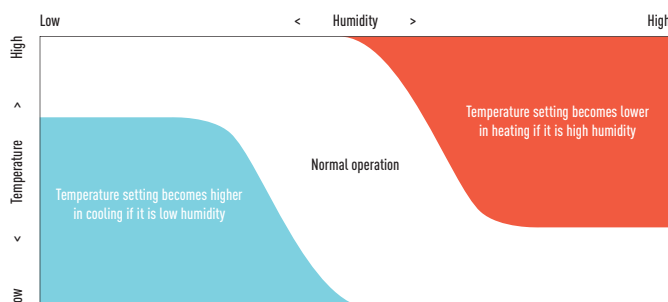





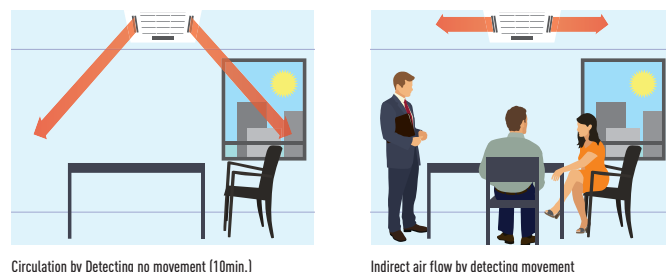







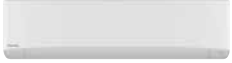
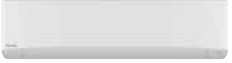
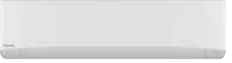















**Group control, circulation function.**

Circulating operation is activated when a room is unoccupied to evenly distribute air and minimize temperature gaps in both heating and cooling operation.





# RANGE OF COMMERCIAL UNITS R32

Page	Indoor units	2,50kW	3,50 ~ 3,60kW	4,50kW	5,00kW
P. 184	<b>NEW</b> Wall Mounted Professional Inverter -20°C • R32 GAS				
		KIT-E25-TKEA	KIT-E35-TKEA	KIT-E42-TKEA	KIT-E50-TKEA
P. 186	<b>NEW</b> Wall Inverter+ • R32 GAS				
			S-36PK2E5B	S-45PK2E5B	S-50PK2E5B
Check it in RAC part	<b>NEW</b> 4 Way 60x60 Cassette Inverter • R32 GAS				
		KIT-Z25-UB4	KIT-Z35-UB4		KIT-Z50-UB4
P. 190	<b>NEW</b> 4 Way 60x60 Cassette Inverter+ • R32 GAS				
			S-36PY2E5B	S-45PY2E5B	S-50PY2E5B
P. 192	<b>NEW</b> 4 Way 90x90 Cassette Inverter+ • R32 GAS				
			S-36PU2E5B	S-45PU2E5B	S-50PU2E5B
P. 196	<b>NEW</b> Ceiling Inverter+ • R32 GAS				
			S-36PT2E5B	S-45PT2E5B	S-50PT2E5B
Check it in RAC part	<b>NEW</b> Low Static Pressure Hide Away Inverter • R32 GAS				
		KIT-Z25-UD3	KIT-Z35-UD3		KIT-Z50-UD3
P. 200	<b>NEW</b> High Static Pressure Hide Away Inverter+ • R32 GAS				
			S-36PF1E5B	S-45PF1E5B	S-50PF1E5B
P. 204	<b>NEW</b> Low Static Pressure Hide Away Inverter+ • R32 GAS				
			S-36PN1E5B	S-45PN1E5B	S-50PN1E5B
<b>Outdoor units PACi Elite and Standard</b>			<b>3,60kW</b>		<b>5,00kW</b>
	<b>NEW</b> PACi Elite • R32 GAS				
			U-36PZH2E5		U-50PZH2E5
	<b>NEW</b> PACi Standard • R32 GAS				

1. These models will be available in Winter 2018. \* U\_\_E5 Single Phase / U\_\_E8 Three Phase.



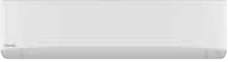
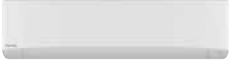
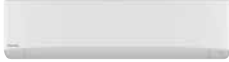

PACi Kits

R32

6,00kW	7,10kW	10,00kW	12,50kW	14,00kW
				
	KIT-E71-TKEA			
				
S-60PK2E5B	S-71PK2E5B	S-100PK2E5B (9,00kW)		
				
KIT-Z60-UB4				

				
S-60PU2E5B	S-71PU2E5B	S-100PU2E5B	S-125PU2E5B	S-140PU2E5B
				
S-60PT2E5B	S-71PT2E5B	S-100PT2E5B	S-125PT2E5B	S-140PT2E5B
				
KIT-Z60-UD3				

				
S-60PF1E5B	S-71PF1E5B	S-100PF1E5B	S-125PF1E5B	S-140PF1E5B
				
S-60PN1E5B	S-71PN1E5B	S-100PN1E5B	S-125PN1E5B	S-140PN1E5B

6,00kW	7,10kW	10,00kW	12,50kW	14,00kW
				
U-60PZH2E5	U-71PZH2E5 / U-71PZH2E8 <sup>1</sup>	U-100PZH2E5 / U-100PZH2E8 <sup>1</sup>	U-125PZH2E5 / U-125PZH2E8 <sup>1</sup>	U-140PZH2E5 / U-140PZH2E8 <sup>1</sup>

				
U-60PZ2E5	U-71PZ2E5	U-100PZ2E5 / U-100PZ2E8	U-125PZ2E5 / U-125PZ2E8	U-140PZ2E5 / U-140PZ2E8

## NEW WALL MOUNTED PROFESSIONAL INVERTER -20°C • R32 GAS



High efficiency products for 24/7 applications. Panasonic has developed a complete range of solutions for server rooms which efficiently protect your servers, keeping them at an appropriate temperature even when the outdoor temperature is below -20°C.

### High efficiency all the year

#### Key points:

- **NEW!** From 2,5 to 7,10kW with New TKEA R32 gas units
- Backup function
- Redundancy function
- Alternative run function
- Error information by dry contact
- Operation even at -20°C outdoor temperature
- High seasonal performance
- Product design for 24/7 operation



Splits 1x1

R32



**Complete line-up with high efficiency even at -20°C.**

This Wall Mounted air conditioner is especially designed for professional applications such as computer rooms where cooling inside the room is necessary even when the outside temperature is low. Furthermore this air conditioner has an automatic changeover system, in order to maintain the inside temperature even when sharp outside temperature changes occur.

**Technical focus**

- **NEW!** New design
- R32 gas is more environmentally friendly than R410A
- Designed for 24h/7d a week operation
- Up to A+++ in cooling
- Highly efficient even at -20°C
- High durability rolling bearings
- Additional piping sensors to prevent freezing
- Automatic restart

KIT			KIT-Z25-TKEA	KIT-Z35-TKEA	KIT-Z42-TKEA	KIT-Z50-TKEA	KIT-Z71-TKEA
Cooling capacity	Nominal (Min - Max)	kW	2,50 [0,85 - 3,00]	3,50 [0,85 - 4,00]	4,20 [0,98 - 5,00]	5,00 [0,98 - 6,00]	7,10 [0,98 - 8,10]
EER <sup>1)</sup>	Nominal (Min - Max)	W/W	4,90 [5,00 - 4,29] A	4,07 [5,00 - 3,64] A	3,82 [4,90 - 3,25] A	3,60 [3,50 - 3,09] A	3,17 [2,33 - 3,03] B
SEER <sup>2)</sup>		W/W	8,50 <b>A+++</b>	8,50 <b>A+++</b>	8,50 <b>A+++</b>	8,50 <b>A+++</b>	6,10 <b>A++</b>
Pdesign		kW	2,50	3,50	4,20	5,00	7,10
Input power cooling	Nominal (Min - Max)	kW	0,51 [0,17 - 0,70]	0,86 [0,17 - 1,10]	1,10 [0,20 - 1,54]	1,39 [0,28 - 1,94]	2,24 [0,42 - 2,67]
Annual energy consumption <sup>3)</sup>		kWh/a	103	144	173	206	407
Heating capacity	Nominal (Min - Max)	kW	3,40 [0,85 - 5,40]	4,00 [0,85 - 6,60]	5,40 [0,98 - 7,25]	5,80 [0,98 - 8,00]	8,60 [0,98 - 9,90]
Heating capacity at -7°C		kW	3,33	4,07	4,30	5,00	6,13
COP <sup>1)</sup>	Nominal (Min - Max)	W/W	4,86 [5,15 - 4,12] A	4,35 [5,15 - 3,63] A	4,00 [4,45 - 3,37] A	4,03 [2,88 - 3,20] A	3,51 [2,45 - 3,47] B
SCOP <sup>2)</sup>		W/W	4,50 <b>A+</b>	4,40 <b>A+</b>	4,30 <b>A+</b>	4,40 <b>A+</b>	4,00 <b>A+</b>
Pdesign at -10°C		kW	2,80	3,60	3,80	4,40	5,50
Input power heating	Nominal (Min - Max)	kW	0,70 [0,17 - 1,31]	0,92 [0,17 - 1,82]	1,35 [0,22 - 2,15]	1,44 [0,34 - 2,50]	2,45 [0,40 - 2,85]
Annual energy consumption <sup>3)</sup>		kWh/a	871	1145	1237	1400	1925
Indoor unit			CS-Z25TKEA	CS-Z35TKEA	CS-Z42TKEA	CS-Z50TKEA	CS-Z71TKEA
Power source		V	230	230	230	230	230
Recommended fuse		A	16	16	16	16	20
Connection indoor / outdoor		mm <sup>2</sup>	4 x 1,5	4 x 1,5	4 x 1,5	4 x 2,5	4 x 2,5
Air Volume	Cool / Heat	m <sup>3</sup> /min	10,40 / 11,70	10,70 / 12,40	18,20 / 20,20	19,20 / 21,30	20,20 / 21,00
Moisture removal volume		L/h	1,5	2,0	2,4	2,8	4,1
Sound pressure <sup>4)</sup>	Cool (Hi / Lo / Q-Lo)	dB(A)	39 / 25 / 21	42 / 28 / 21	43 / 32 / 29	44 / 37 / 30	47 / 38 / 35
	Heat (Hi / Lo / Q-Lo)	dB(A)	41 / 27 / 22	43 / 30 / 22	44 / 35 / 29	44 / 37 / 30	47 / 38 / 35
Dimension	H x W x D	mm	295 x 919 x 194	295 x 919 x 194	302 x 1120 x 236	302 x 1120 x 236	302 x 1120 x 236
Net weight		kg	9	10	12	12	13
Outdoor unit			CU-Z25TKEA	CU-Z35TKEA	CU-Z42TKEA	CU-Z50TKEA	CU-Z71TKEA
Sound pressure <sup>4)</sup>	Cool / Heat (Hi)	dB(A)	46 / 48	48 / 50	48 / 50	48 / 50	52 / 54
Dimension <sup>5)</sup>	H x W x D	mm	619 x 824 x 299	619 x 824 x 299	619 x 824 x 299	695 x 875 x 320	695 x 875 x 320
Net weight		kg	37	38	38	43	49
Piping connections	Liquid pipe	Inch (mm)	1/4 (6,35)	1/4 (6,35)	1/4 (6,35)	1/4 (6,35)	1/4 (6,35)
	Gas pipe	Inch (mm)	3/8 (9,52)	3/8 (9,52)	1/2 (12,70)	1/2 (12,70)	5/8 (15,88)
Pipe length range		m	3 - 20	3 - 20	3 - 20	3 - 30	3 - 30
Elevation difference (in/out) <sup>6)</sup>		m	15	15	15	15	20
Pipe length for additional gas		m	7,5	7,5	7,5	7,5	10
Additional gas amount		g/m	10	10	10	15	25
Refrigerant (R32)		kg / TCO <sub>2</sub> Eq.	0,96 / 0,648	1,00 / 0,675	1,08 / 0,729	1,15 / 0,776	1,32 / 0,891
Operating range	Cool Min ~ Max	°C	-20 ~ +43	-20 ~ +43	-20 ~ +43	-20 ~ +43	-20 ~ +43
	Heat Min ~ Max	°C	-15 ~ +24	-15 ~ +24	-15 ~ +24	-15 ~ +24	-15 ~ +24

**Accessories**

<b>CZ-TACG1</b>	NEW Panasonic WLAN kit for internet control
<b>CZ-CAPRA1</b>	RAC interface adapter for integration into P Link
<b>PAW-WTRAY</b>	Tray for condenser water compatible with base ground support

**Accessories**

<b>PAW-GRDSTD40</b>	Outdoor elevation platform
<b>PAW-GRDBSE20</b>	Outdoor base ground support for noise and vibration absorption
<b>PAW-SERVER-PKEA</b>	PCB for installation in server rooms with security

1) EER and COP calculation is based in accordance to EN14511. 2) Energy Label Scale from A+++ to D. 3) The annual energy consumption is calculated in accordance to EU/626/2011. 4) The sound pressure of the units shows the value measured of a position 1m in front of the main body and 0,8m below the unit. The sound pressure is measured in accordance with Eurovent 6/C/006-97 specification. Q-Lo: Quiet mode. Lo: The lowest fan speed. 5) Add 70mm for piping port. 6) When installing the outdoor unit at a higher position than the indoor unit.



SEER and SCOP: For KIT-Z25-TKEA. SUPER QUIET: For KIT-Z25-TKEA. INTERNET CONTROL: Optional.

## NEW PACi ELITE WALL MOUNTED INVERTER+

### • R32 GAS

NEW  
18



The wall mounted units with stylish matt color can be offered for many applications such as studios, gyms, high ceiling areas and even computer server rooms.

The compact design and flat face ensure discreet installation, even in a small space.

#### Technical focus

- Modern design with flat face and compact size
- Stylish matt white color
- DC FAN for better efficiency and control
- Six directional piping outlet
- Datanavi simple support tool app with remote controller (CZ-RTC5B)
- Easy connection and control of external fan or ERV using the connector PAW-FDC on the indoor unit PCB. The external device can be controlled by the remote control of the Panasonic indoor unit

Tentative data			Single Phase				
			3,60kW	5,00kW	6,00kW	7,10kW	9,00kW
KIT			KIT-36PK2ZH5	KIT-50PK2ZH5	KIT-60PK2ZH5	KIT-71PK2ZH5	KIT-100PK2ZH5
Remote controller			CZ-RTC5B	CZ-RTC5B	CZ-RTC5B	CZ-RTC5B	CZ-RTC5B
Cooling capacity	Nominal (Min - Max)	kW	3,60 (1,50 ~ 4,00)	5,00 (1,50 ~ 5,60)	6,10 (2,00 ~ 7,10)	7,10 (2,50 ~ 8,00)	9,50 (3,30 ~ 10,50)
EER <sup>1)</sup>		W/W	4,86	3,91	3,72	3,46	3,32
SEER <sup>2)</sup>		W/W	<b>6,60 A++</b>	<b>6,60 A++</b>	<b>6,70 A++</b>	<b>6,70 A++</b>	<b>6,30 A++</b>
Pdesign		kW	3,60	5,00	6,10	7,10	9,50
Input power cooling		kW	0,74	1,28	1,64	2,05	2,86
Annual energy consumption <sup>3)</sup>		kWh/a	—	—	—	—	—
Heating capacity	Nominal (Min - Max)	kW	4,00 (1,50 ~ 5,00)	5,60 (1,50 ~ 6,50)	7,00 (1,80 ~ 8,00)	8,00 (2,00 ~ 9,00)	9,50 (4,10 ~ 11,50)
Heating capacity at -7°C / -15°C <sup>4)</sup>		kW	—	—	—	—	—
COP <sup>1)</sup>		W/W	4,94	4,12	4,24	4,00	3,97
SCOP <sup>2)</sup>		W/W	<b>4,50 A+</b>	<b>4,30 A+</b>	<b>4,40 A+</b>	<b>4,30 A+</b>	<b>4,00 A+</b>
Pdesign at -10°C		kW	3,60	4,50	6,00	5,20	8,00
Input power heating		kW	0,81	1,36	1,65	2,00	2,39
Annual energy consumption <sup>3)</sup>		kWh/a	—	—	—	—	—
Indoor unit			S-36PK2E5B	S-50PK2E5B	S-60PK2E5B	S-71PK2E5B	S-100PK2E5B
Air volume	Hi / Med / Lo	m <sup>3</sup> /min	13/11/09	16/14/11	20/18/15	20/18/15	22/19/15
Sound pressure <sup>5)</sup>	Hi / Med / Lo	dB(A)	35/31/27	40/36/32	47/44/40	47/44/40	49/45/41
Dimension	HxWxD	mm	302x1120x236	302x1120x236	302x1120x236	302x1120x236	302x1120x236
Net weight		kg	13	13	14	14	14
Outdoor unit			U-36PZH2E5	U-50PZH2E5	U-60PZH2E5	U-71PZH2E5	U-100PZH2E5
Power source		V	220/230/240	220/230/240	220/230/240	220/230/240	220/230/240
Sound pressure	Cool / Heat (Hi)	dB(A)	45/46	46/48	46/49	48/50	52/52
Sound power	Cool / Heat (Hi)	dB	64/66	65/68	65/69	65/67	69/69
Dimension	HxWxD	mm	695x875x320	695x875x320	695x875x320	996x940x340	1416x940x340
Net weight		kg	49	49	49	68	101
Piping connections	Liquid pipe	Inch (mm)	1/4 (6,35)	1/4 (6,35)	3/8 (9,52)	3/8 (9,52)	3/8 (9,52)
	Gas pipe	Inch (mm)	1/2 (12,70)	1/2 (12,70)	5/8 (15,88)	5/8 (15,88)	5/8 (15,88)
Pipe length range		m	3~40	3~40	3~40	5~50	5~75
Elevation difference (in/out) <sup>6)</sup>		m	30	30	30	30	30
Pipe length for additional gas		m	30	30	30	30	30
Additional gas amount		g/m	—	—	—	—	—
Refrigerant (R32)		kg/TCO <sub>2</sub> Eq.	—	—	—	—	—
Operating range	Cool Min ~ Max	°C	-15 ~ +46	-15 ~ +46	-15 ~ +46	-15 ~ +46	-15 ~ +46
	Heat Min ~ Max	°C	-20 ~ +24	-20 ~ +24	-20 ~ +24	-20 ~ +24	-20 ~ +24
<b>Kit Price</b>		€					
Indoor unit Price		€					
Outdoor unit Price		€					
Wired Remote Controller Price		€					

#### Accessories

<b>CZ-RTC5B</b>	Wired remote controller with Econavi button and datanavi
<b>CZ-RWS3</b>	Wireless remote controller
<b>CZ-RE2C2</b>	Simplified remote controller
<b>PAW-GRDSTD40</b>	Outdoor elevation platform 400x900x400mm
<b>PAW-WTRAY</b>	Tray for condenser water compatible with base ground support

#### Accessories

<b>PAW-GRDBSE20</b>	Outdoor base ground support for noise and vibration absorption
<b>PAW-WPH7</b>	Wind protection shield for U-100/125/140PZH2E5/8
<b>PAW-WPH9</b>	Wind protection shield for U-71PZH2E5/8
<b>PAW-PACR3</b>	Interfaces to run 3 units on Backup and alternative run

PACi Kits

R32



**Closed discharge port.**

When the unit is turned OFF, the flap closes completely to prevent dust getting into the unit and to keep the equipment clean.

**Quiet operation.**

These units are among the quietest in the industry, making them ideal for hotels and hospitals.

**Smooth and durable design.**

Stylish matt color matches with modern interiors. The sleek, compact design ensures a discreet installation - even where space is limited.

**Piping outlet in six directions.**

Piping outlet is possible in the six directions of right, right rear, right bottom, left, left rear and left bottom, making the installation work easier.

**Air distribution is altered depending on the operational mode of the unit.**

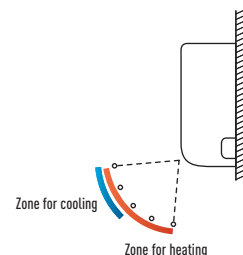

Tentative data			Three Phase	
			7,10kW	9,00kW
KIT			KIT-71PK2ZH8	KIT-100PK2ZH8
Remote controller			CZ-RTC5B	CZ-RTC5B
Cooling capacity	Nominal (Min - Max)	kW	7,10 (3,20 - 8,00)	9,50 (3,30 - 10,50)
EER <sup>1)</sup>		W/W	3,46	3,32
SEER <sup>2)</sup>		W/W	6,60 A++	6,20 A++
Pdesign		kW	7,10	9,50
Input power cooling		kW	2,05	2,86
Annual energy consumption <sup>3)</sup>		kWh/a	—	—
Heating capacity	Nominal (Min - Max)	kW	8,00 (2,80 - 9,00)	9,50 (4,10 - 11,50)
Heating capacity at -7°C / -15°C <sup>4)</sup>		kW	—	—
COP <sup>1)</sup>		W/W	4,00	3,97
SCOP <sup>2)</sup>		W/W	4,30 A+	4,00 A+
Pdesign at -10°C		kW	5,20	8,00
Input power heating		kW	2,00	2,39
Annual energy consumption <sup>3)</sup>		kWh/a	—	—
<b>Indoor unit</b>			<b>S-71PK2E5B</b>	<b>S-100PK2E5B</b>
Air volume	Hi / Med / Lo	m <sup>3</sup> /min	20 / 18 / 15	22 / 19 / 15
Sound pressure <sup>5)</sup>	Hi / Med / Lo	dB(A)	47 / 44 / 40	49 / 45 / 41
Dimension	H x W x D	mm	302 x 1120 x 236	302 x 1120 x 236
Net weight		kg	14	14
<b>Outdoor unit</b>			<b>U-71PZH2E8</b>	<b>U-100PZH2E8</b>
Power source		V	380 / 400 / 415	380 / 400 / 415
Sound pressure	Cool / Heat (Hi)	dB(A)	48 / 50	52 / 52
Sound power	Cool / Heat (Hi)	dB	65 / 67	69 / 69
Dimension	H x W x D	mm	996 x 940 x 340	1416 x 940 x 340
Net weight		kg	68	101
Piping connections	Liquid pipe	Inch (mm)	3/8 (9,52)	3/8 (9,52)
	Gas pipe	Inch (mm)	5/8 (15,88)	5/8 (15,88)
Pipe length range		m	5 - 50	5 - 75
Elevation difference (in/out) <sup>6)</sup>		m	30	30
Pipe length for additional gas		m	30	30
Additional gas amount		g/m	—	—
Refrigerant (R32)		kg/TCO: Eq.	—	—
Operating range	Cool Min ~ Max	°C	-15 ~ +46	-15 ~ +46
	Heat Min ~ Max	°C	-20 ~ +24	-20 ~ +24
<b>Kit Price</b>		€		
Indoor unit Price		€		
Outdoor unit Price		€		
Wired Remote Controller Price		€		

1) EER and COP calculation is based in accordance to EN14511. 2) For models below 12kW, the SEER and SCOP is calculated based on values of EU/626/2011. For models above 12kW, the SEER and SCOP is calculated based on values of EU/2281/2016. 3) The annual energy consumption is calculated in accordance to EU/626/2011. 4) Heating capacity is calculated including defrost factor correction. 5) The sound pressure of the units shows the value measured of a position 1m in front of the main body and 1,5m from the ground. The sound pressure is measured in accordance with Eurovent 6/C/006-97 specification. 6) When installing the outdoor unit at a higher position than the indoor unit.\* Recommended fuse for the indoor 3A.



SEER: For KIT-60PK2ZH5. SCOP: For KIT-36PK2ZH5. INTERNET CONTROL: Optional. Compatible with all Panasonic connectivity solutions. For detailed information go to the Control Systems section.

Rating Conditions: Cooling Indoor 27°C DB / 19°C WB. Cooling Outdoor 35°C DB / 24°C WB. Heating Indoor 20°C DB. Heating Outdoor 7°C DB / 6°C WB. (DB: Dry Bulb; WB: Wet Bulb) Specifications subject to change without notice. For detailed information about ErP, please visit our websites www.aircon.panasonic.eu or www.gtc.panasonic.eu.

## NEW PACi STANDARD WALL MOUNTED INVERTER+ • R32 GAS

NEW  
18



The wall mounted units with stylish matt color can be offered for many applications such as studios, gyms, high ceiling areas and even computer server rooms.

The compact design and flat face ensure discreet installation, even in a small space.

### Technical focus

- Modern design with flat face and compact size
- Stylish matt white color
- DC FAN for better efficiency and control
- Six directional piping outlet
- Datanavi simple support tool app with remote controller (CZ-RTC5B)
- Easy connection and control of external fan or ERV using the connector PAW-FDC on the indoor unit PCB. The external device can be controlled by the remote control of the Panasonic indoor unit

Tentative data			Single Phase		
			6,00kW	7,10kW	9,00kW
KIT			KIT-60PK2Z5	KIT-71PK2Z5	KIT-100PK2Z5
Remote controller			CZ-RTC5B	CZ-RTC5B	CZ-RTC5B
Cooling capacity	Nominal (Min - Max)	kW	6,10 (2,00 - 7,10)	7,10 (2,00 - 7,70)	9,00 (3,00 - 9,70)
EER <sup>1)</sup>	Nominal (Min - Max)	W/W	3,61	3,01	3,47 (5,36 - 3,13)
SEER <sup>2)</sup>		W/W	5,70 A+	5,40 A	6,50 A++
P <sub>design</sub>		kW	6,10	7,10	9,00
Input power cooling	Nominal (Min - Max)	kW	1,69	2,36	2,59 (0,56 - 3,10)
Annual energy consumption <sup>3)</sup>		kWh/a	—	—	485
Heating capacity	Nominal (Min - Max)	kW	6,10 (1,80 - 7,00)	7,10 (1,80 - 8,10)	9,00 (3,00 - 10,50)
Heating capacity at -7°C / -15°C <sup>4)</sup>		kW	—	—	7,92 / —
COP <sup>1)</sup>	Nominal (Min - Max)	W/W	4,49	4,23	3,93 (5,36 - 3,56)
SCOP <sup>2)</sup>		W/W	4,20 A+	4,10 A+	3,90 A
P <sub>design</sub> at -10°C		kW	6,00	6,00	9,00
Input power heating	Nominal (Min - Max)	kW	1,36	1,68	2,29 (0,56 - 2,95)
Annual energy consumption <sup>3)</sup>		kWh/a	—	—	3231
Indoor unit			S-60PK2E5B	S-71PK2E5B	S-100PK2E5B
Air volume	Hi / Med / Lo	m <sup>3</sup> /min	20,00 / 18,00 / 15,00	20,00 / 18,00 / 15,00	22,00 / 18,50 / 15,00
Moisture removal volume		L/h	2,0	3,0	4,3
Sound pressure <sup>5)</sup>	Hi / Med / Lo	dB(A)	47 / 44 / 40	47 / 44 / 40	49 / 45 / 41
Sound power	Hi / Med / Lo	dB	63 / 60 / 56	63 / 60 / 56	65 / 61 / 57
Dimension	H x W x D	mm	302 x 1120 x 236	302 x 1120 x 236	302 x 1120 x 236
Net weight		kg	14	14	14
Outdoor unit			U-60PZ2E5	U-71PZ2E5	U-100PZ2E5
Power source		V	220 / 230 / 240	220 / 230 / 240	220 / 230 / 240
Current	Cool	A	—	—	12,10 / 11,50 / 11,10
	Heat	A	—	—	10,60 / 10,29 / 9,70
Air volume	Cool / Heat	m <sup>3</sup> /min	—	—	76 / 70
Sound pressure	Cool / Heat (Hi)	dB(A)	46 / 48	49 / 49	52 / 52
Sound power	Cool / Heat (Hi)	dB	65 / 68	69 / 69	70 / 70
Dimension	H x W x D	mm	695 x 875 x 320	695 x 875 x 320	996 x 980 x 370
Net weight		kg	49	49	90
Piping connections	Liquid pipe	Inch (mm)	3/8 (9,52)	3/8 (9,52)	3/8 (9,52)
	Gas pipe	Inch (mm)	5/8 (15,88)	5/8 (15,88)	5/8 (15,88)
Pipe length range		m	3 - 40	3 - 40	5 - 50
Elevation difference (in/out) <sup>6)</sup>		m	30	30	30
Pipe length for additional gas		m	30	30	30
Additional gas amount		g/m	—	—	45
Refrigerant (R32)		kg / TCO <sub>2</sub> Eq.	—	—	2,60 / 1,755
Operating range	Cool Min ~ Max	°C	-10 ~ +43	-10 ~ +43	-10 ~ +43
	Heat Min ~ Max	°C	-15 ~ +24	-15 ~ +24	-15 ~ +24

### Accessories

<b>CZ-RTC5B</b>	Wired remote controller with Econavi button and datanavi
<b>CZ-RW53</b>	Wireless remote controller
<b>CZ-RE2C2</b>	Simplified remote controller

### Accessories

<b>PAW-GRDSTD40</b>	Outdoor elevation platform 400 x 900 x 400mm
<b>PAW-WTRAY</b>	Tray for condenser water compatible with base ground support
<b>PAW-GRDBSE20</b>	Outdoor base ground support for noise and vibration absorption

PACi Kits

R32



**Closed discharge port.**

When the unit is turned OFF, the flap closes completely to prevent dust getting into the unit and to keep the equipment clean.

**Quiet operation.**

These units are among the quietest in the industry, making them ideal for hotels and hospitals.

**Smooth and durable design.**

Stylish matt color matches with modern interiors. The sleek, compact design ensures a discreet installation - even where space is limited.

**Piping outlet in six directions.**

Piping outlet is possible in the six directions of right, right rear, right bottom, left, left rear and left bottom, making the installation work easier.

**Air distribution is altered depending on the operational mode of the unit.**

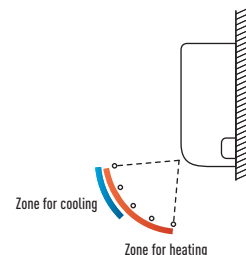

Tentative data			Three Phase
<b>KIT</b>			<b>9,00kW</b>
<b>Remote controller</b>			<b>KIT-100PK2Z8</b>
<b>CZ-RTCSB</b>			<b>CZ-RTCSB</b>
Cooling capacity	Nominal (Min - Max)	kW	9,00 (3,00 - 9,70)
EER <sup>1)</sup>	Nominal (Min - Max)	W/W	3,47 (5,36 - 3,13)
<b>SEER <sup>2)</sup></b>		<b>W/W</b>	<b>6,50 A++</b>
Pdesign		kW	9,00
Input power cooling	Nominal (Min - Max)	kW	2,59 (0,56 - 3,10)
Annual energy consumption <sup>3)</sup>		kWh/a	485
Heating capacity	Nominal (Min - Max)	kW	9,00 (3,00 - 10,50)
Heating capacity at -7°C / -15°C <sup>4)</sup>		kW	7,92 / —
COP <sup>1)</sup>	Nominal (Min - Max)	W/W	3,93 (5,36 - 3,56)
<b>SCOP <sup>2)</sup></b>		<b>W/W</b>	<b>3,90 A</b>
Pdesign at -10°C		kW	9,00
Input power heating	Nominal (Min - Max)	kW	2,29 (0,56 - 2,95)
Annual energy consumption <sup>3)</sup>		kWh/a	3231
<b>Indoor unit</b>			<b>S-100PK2E5B</b>
Air volume	Hi / Med / Lo	m <sup>3</sup> /min	22,00 / 18,50 / 15,00
Moisture removal volume		L/h	4,3
Sound pressure <sup>5)</sup>	Hi / Med / Lo	dB(A)	49 / 45 / 41
Sound power	Hi / Med / Lo	dB	65 / 61 / 57
Dimension	H x W x D	mm	302 x 1120 x 236
Net weight		kg	14
<b>Outdoor unit</b>			<b>U-100PZ2E8</b>
Power source		V	380 / 400 / 415
Current	Cool	A	4,10 / 3,90 / 3,15
	Heat	A	3,60 / 3,45 / 3,30
Air volume	Cool / Heat	m <sup>3</sup> /min	76 / 70
Sound pressure	Cool / Heat (Hi)	dB(A)	52 / 52
Sound power	Cool / Heat (Hi)	dB	70 / 70
Dimension	H x W x D	mm	996 x 980 x 370
Net weight		kg	90
Piping connections	Liquid pipe	Inch (mm)	3/8 (9,52)
	Gas pipe	Inch (mm)	5/8 (15,88)
Pipe length range		m	5 - 50
Elevation difference (in/out) <sup>6)</sup>		m	30
Pipe length for additional gas		m	30
Additional gas amount		g/m	45
Refrigerant (R32)		kg/TCO: Eq.	2,60 / 1,755
Operating range	Cool Min ~ Max	°C	-10 ~ +43
	Heat Min ~ Max	°C	-15 ~ +24

1) EER and COP calculation is based in accordance to EN14511. 2) For models below 12kW, the SEER and SCOP is calculated based on values of EU/626/2011. For models above 12kW, the SEER and SCOP is calculated based on values of EU/2281/2016. 3) The annual energy consumption is calculated in accordance to EU/626/2011. 4) Heating capacity is calculated including defrost factor correction. 5) The sound pressure of the units shows the value measured of a position 1m in front of the main body and 1,5m from the ground. The sound pressure is measured in accordance with Eurovent 6/C/006-97 specification. 6) When installing the outdoor unit at a higher position than the indoor unit.\* Recommended fuse for the indoor 3A.



SEER: For KIT-100PK2Z5. SCOP: For KIT-60PK2Z5. INTERNET CONTROL: Optional.  
Compatible with all Panasonic connectivity solutions. For detailed information go to the Control Systems section.

Rating Conditions: Cooling Indoor 27°C DB / 19°C WB. Cooling Outdoor 35°C DB / 24°C WB. Heating Indoor 20°C DB. Heating Outdoor 7°C DB / 6°C WB. (DB: Dry Bulb; WB: Wet Bulb)  
Specifications subject to change without notice. For detailed information about ErP, please visit our websites www.aircon.panasonic.eu or www.ptc.panasonic.eu.

# NEW PACi ELITE 4 WAY 60x60 CASSETTE INVERTER+ • R32 GAS

NEW  
18



Panel  
CZ-KPY3AW (size 700x700mm)  
CZ-KPY3BW (size 625x625mm)



Small and powerful, ideal for offices and restaurants.  
Standard units only for Twin, Triple and Double-twin combinations.

### Technical focus

- Fresh air distribution
- Multidirectional air flow
- Integrated drain pump gives 850mm lift
- 3 speed centrifugal fan
- DC FAN for better efficiency and control
- Easy connection and control of external fan or ERV using the connector PAW-FDC on the indoor unit PCB. The external device can be controlled by the remote control of the Panasonic indoor unit

Tentative data			Single Phase	
KIT			3,60kW KIT-36PY2ZH5	5,00kW KIT-50PY2ZH5
<b>Remote controller</b>			<b>CZ-RTC5B</b>	<b>CZ-RTC5B</b>
Cooling capacity	kW		3,60	5,00
EER <sup>1)</sup>	W/W		4,74	3,70
<b>SEER <sup>2)</sup></b>	<b>W/W</b>		<b>6,50 A++</b>	<b>6,40 A++</b>
Pdesign	kW		3,60	5,00
Input power cooling	kW		0,76	1,35
Annual energy consumption <sup>3)</sup>	kWh/a		—	—
Heating capacity	kW		4,00	5,60
Heating capacity at -7°C / -15°C <sup>4)</sup>	kW		—	—
COP <sup>1)</sup>	W/W		4,21	3,41
<b>SCOP <sup>2)</sup></b>	<b>W/W</b>		<b>4,30 A+</b>	<b>4,10 A+</b>
Pdesign at -10°C	kW		3,60	4,50
Input power heating	kW		0,95	1,64
Annual energy consumption <sup>3)</sup>	kWh/a		—	—
<b>Indoor unit</b>			<b>S-36PY2E5B</b>	<b>S-50PY2E5B</b>
Air volume	Hi / Med / Lo	m <sup>3</sup> /min	9,70/8,00/6,00	11,10/9,80/8,50
Moisture removal volume		L/h	1,5	2,4
Sound pressure <sup>4)</sup>	Hi / Med / Lo	dB(A)	36/32/26	40/37/33
Sound power	Hi / Med / Lo	dB	51/47/41	55/52/48
Dimension (HxWxD) / Net weight	Indoor	mm / kg	288x583x583/18	288x583x583/18
	CZ-KPY3AW Panel	mm / kg	31x700x700/2,4	31x700x700/2,4
	CZ-KPY3BW Panel	mm / kg	31x625x625/2,4	31x625x625/2,4
<b>Outdoor unit</b>			<b>U-36PZH2E5</b>	<b>U-50PZH2E5</b>
Power source		V	220/230/240	220/230/240
Current	Cool	A	—	—
	Heat	A	—	—
Air volume	Cool / Heat	m <sup>3</sup> /min	—	—
Sound pressure	Cool / Heat (Hi)	dB(A)	45/46	46/48
Sound power	Cool / Heat (Hi)	dB	64/66	65/68
Dimension / Net weight	HxWxD	mm / kg	695x875x320/49	695x875x320/49
Piping connections	Liquid pipe	Inch (mm)	1/4(6,35)	1/4(6,35)
	Gas pipe	Inch (mm)	1/2(12,70)	1/2(12,70)
Pipe length range		m	30	30
Elevation difference (in/out) <sup>4)</sup>		m	—	—
Pipe length for additional gas		m	30	30
Additional gas amount		g/m	—	—
Refrigerant (R32)		kg/TCO <sub>2</sub> Eq.	—	—
Operating range	Cool Min ~ Max	°C	-15 ~ +46 / -20 ~ +24	-15 ~ +46 / -20 ~ +24
	Heat Min ~ Max	°C	—	—

Accessories	
<b>CZ-RTC5B</b>	Wired remote controller with Econavi button and datanavi
<b>CZ-RWS3</b>	Wireless remote controller
<b>CZ-RE2C2</b>	Simplified remote controller
<b>PAW-WTRAY</b>	Tray for condenser water compatible with base ground support

Accessories	
<b>PAW-GRDBSE20</b>	Outdoor base ground support for noise and vibration absorption
<b>PAW-GRDSTD40</b>	Outdoor elevation platform 400 x 900 x 400mm



SEER and SCOP: For KIT-36PY2ZH5. INTERNET CONTROL: Optional.  
Compatible with all Panasonic connectivity solutions. For detailed information go to the Control Systems section.

## NEW PACi STANDARD 4 WAY 60x60 CASSETTE INVERTER+ • R32 GAS

PACi Kits

R32



Controller.  
Wired remote controller  
CZ-RIC5B  
Compatible with Econavi



Optional Controller  
Wireless remote controller  
CZ-RWS3



Optional Controller.  
Simplified remote controller  
CZ-RE2C2

### A drain height of approximately 850mm from the ceiling surface

The drain height can be increased by approx. 350mm over the conventional value by using a high-lift drain pump, and long horizontal piping is possible.

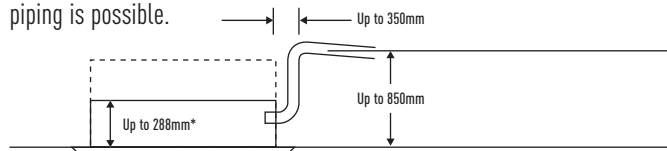

Lightweight at 18kg, the unit is also very slim with a height of only 288mm, making installation possible even in narrow ceilings.

### Lighter and slimmer, easier installation

Lightweight and very slim which makes installation possible even in narrow ceilings.

Designed to fit exactly into a 600x600mm ceiling grid without the need to alter the bar configuration.

Significant reduction of power consumption by using highly developed DC fan motors with variable speed, special heat exchangers, etc.

Tentative data			3,60kW	4,50kW	5,00kW
Indoor unit			S-36PY2E5B	S-45PY2E5B <sup>1)</sup>	S-50PY2E5B
Cooling capacity		kW	3,60	4,50	5,00
Heating capacity		kW	4,00	5,20	5,60
Current	Cool	A	0,30/0,30/0,30	0,32/0,32/0,32	0,35/0,35/0,35
	Heat	A	0,30/0,30/0,30	0,30/0,30/0,30	0,35/0,35/0,35
Input power	Cool	kW	0,04	0,04	0,05
	Heat	kW	0,04	0,04	0,04
Air volume	Cool (Hi / Lo)	m <sup>3</sup> /min	9,70/8,00/6,00	10,00/8,80/7,00	11,10/9,80/8,50
	Heat (Hi / Lo)	m <sup>3</sup> /min	9,90/8,20/6,00	10,30/9,20/7,00	11,10/9,80/8,50
Moisture removal volume		L/h	1,5	2,2	2,4
Sound pressure <sup>4)</sup>	Cool (Hi / Med / Lo)	dB(A)	36/32/26	38/34/28	40/37/33
	Heat (Hi / Med / Lo)	dB(A)	36/32/26	38/34/28	40/37/33
Sound power	Cool (Hi)	dB	51/47/41	53/49/43	55/52/48
	Heat (Hi)	dB	51/47/41	53/49/43	55/52/48
Dimension (H x W x D)	Indoor	mm	288 x 583 x 583	288 x 583 x 583	288 x 583 x 583
	Panel CZ-KPY3AW	mm	31 x 700 x 700	31 x 700 x 700	31 x 700 x 700
	Panel CZ-KPY3BW	mm	31 x 625 x 625	31 x 625 x 625	31 x 625 x 625
Net weight	Indoor	kg	18	18	18
	Panel	kg	2,4	2,4	2,4
Piping connections	Liquid pipe	Inch (mm)	1/4 (6,35)	1/4 (6,35)	1/4 (6,35)
	Gas pipe	Inch (mm)	1/2 (12,70)	1/2 (12,70)	1/2 (12,70)
Operating range	Cool Min ~ Max	°C	+18 ~ +32	+18 ~ +32	+18 ~ +32
	Heat Min ~ Max	°C	+16 ~ +30	+16 ~ +30	+16 ~ +30

1) Only for multi combinations.  
Recommended fuse for the indoor 3A.

1) EER and COP calculation is based in accordance to EN14511. 2) For models below 12kW, the SEER and SCOP is calculated based on values of EU/626/2011. For models above 12kW, the SEER and SCOP is calculated based on values of EU/2281/2016. 3) The annual energy consumption is calculated in accordance to EU/626/2011. 4) The sound pressure of the units shows the value measured of a position 1m in front of the main body and 1,5m from the ground. The sound pressure is measured in accordance with Eurovent 6/C/006-97 specification. 5) When installing the outdoor unit at a higher position than the indoor unit.\* Recommended fuse for the indoor 3A.

# NEW PACi ELITE 4 WAY 90x90 CASSETTE INVERTER+ • R32 GAS

NEW  
18



Panel:  
CZ-KPU3 (standard panel)  
CZ-KPU3A (Econavi exclusive panel)



## Large capacity PACi. Trusted comfort and high efficiency.

Thanks to advances in design and technology such as the high performance turbo fan which is more efficient and silent, and nanoE™ X air purification, the U2 Panasonic 4 way 90x90 Cassette offers high energy saving, fresh air and comfort.

## Technical focus

- High performance turbo fan, path system for heat exchanger
- nanoE™ X: The first air purifier technology in commercial air conditioning
- Econavi: Intelligent sensor to reduce waste of energy
- Datanavi simple support tool app with remote controller (CZ-RTC5B)
- Lower noise in slow fan operation
- Light weight, easy piping
- Drain pump included

Tentative data			Single Phase							
			3,60kW	5,00kW	6,00kW	7,10kW	10,00kW	12,50kW	14,00kW	
KIT			KIT-36PU2ZH5	KIT-50PU2ZH5	KIT-60PU2ZH5	KIT-71PU2ZH5	KIT-100PU2ZH5	KIT-125PU2ZH5	KIT-140PU2ZH5	
Remote controller			CZ-RTC5B	CZ-RTC5B	CZ-RTC5B	CZ-RTC5B	CZ-RTC5B	CZ-RTC5B	CZ-RTC5B	
Cooling capacity	Nominal (Min - Max)	kW	3,60(1,50 - 4,00)	5,00(1,50 - 5,60)	6,00(2,00 - 7,10)	7,10(2,20 - 9,00)	10,00(3,10 - 12,50)	12,50(3,20 - 14,00)	14,00(3,30 - 16,00)	
EER <sup>1)</sup>		W/W	5,14	4,31	4,05	4,06	4,41	3,80	3,41	
SEER <sup>2)</sup>		W/W	<b>7,80A++</b>	<b>7,80A++</b>	<b>7,50A++</b>	<b>7,70A++</b>	<b>7,70A++</b>	<b>7,70</b>	<b>7,20</b>	
Pdesign		kW	3,60	5,00	6,00	7,10	10,00	12,50	14,00	
Input power cooling		kW	0,70	1,16	1,48	1,75	2,27	3,29	4,11	
Annual energy consumption <sup>3)</sup>		kWh/a	—	—	—	—	—	—	—	
Heating capacity	Nominal (Min - Max)	kW	4,00(1,50 - 5,00)	5,60(1,50 - 6,50)	7,00(1,80 - 8,00)	8,00(2,00 - 9,00)	11,20(3,30 - 14,00)	14,00(3,40 - 16,00)	16,00(3,50 - 18,00)	
Heating capacity at -7°C / -15°C <sup>4)</sup>		kW	—	—	—	—	—	—	—	
COP <sup>1)</sup>		W/W	5,48	4,71	4,12	4,30	5,00	4,61	4,30	
SCOP <sup>2)</sup>		W/W	<b>5,10A+++</b>	<b>4,90A++</b>	<b>4,70A++</b>	<b>4,80A++</b>	<b>4,90A++</b>	<b>4,70</b>	<b>4,60</b>	
Pdesign at -10°C		kW	3,60	4,50	6,00	5,20	8,00	9,50	10,60	
Input power heating		kW	0,73	1,19	1,70	1,86	2,24	3,04	3,72	
Annual energy consumption <sup>3)</sup>		kWh/a	—	—	—	—	—	—	—	
<b>Indoor unit</b>			<b>S-36PU2E5B</b>	<b>S-50PU2E5B</b>	<b>S-60PU2E5B</b>	<b>S-71PU2E5B</b>	<b>S-100PU2E5B</b>	<b>S-125PU2E5B</b>	<b>S-140PU2E5B</b>	
Air volume	Hi / Med / Lo	m <sup>3</sup> /min	14,5/13,0/11,5	16,5/13,5/11,5	21,0/16,0/13,0	22,0/16,0/13,0	36,0/26,0/18,0	37,0/27,0/19,0	38,0/29,0/20,0	
Sound pressure <sup>5)</sup>	Hi / Med / Lo	dB(A)	30/28/27	32/29/27	36/31/28	37/31/28	45/38/32	46/39/33	47/40/34	
Dimension	Indoor (H x W x D)	mm	256 x 840 x 840	256 x 840 x 840	256 x 840 x 840	256 x 840 x 840	319 x 840 x 840	319 x 840 x 840	319 x 840 x 840	
	Panel (H x W x D)	mm	33,5 x 950 x 950	33,5 x 950 x 950	33,5 x 950 x 950	33,5 x 950 x 950	33,5 x 950 x 950	33,5 x 950 x 950	33,5 x 950 x 950	
Net weight	Indoor / Panel	kg	19/5	19/5	20/5	20/5	25/5	25/5	25/5	
<b>Outdoor unit</b>			<b>U-36PZH2E5</b>	<b>U-50PZH2E5</b>	<b>U-60PZH2E5</b>	<b>U-71PZH2E5</b>	<b>U-100PZH2E5</b>	<b>U-125PZH2E5</b>	<b>U-140PZH2E5</b>	
Power source		V	220/230/240	220/230/240	220/230/240	220/230/240	220/230/240	220/230/240	220/230/240	
Recommended fuse		A	—	—	—	—	—	—	—	
Connection indoor / outdoor		mm <sup>2</sup>	—	—	—	—	—	—	—	
	Cool	A	—	—	—	—	—	—	—	
Current	Heat	A	—	—	—	—	—	—	—	
		A	—	—	—	—	—	—	—	
Air volume	Cool / Heat	m <sup>3</sup> /min	—	—	—	—	—	—	—	
Sound pressure	Cool / Heat (Hi)	dB(A)	45/46	46/48	46/49	48/50	52/52	53/53	54/55	
Sound power	Cool / Heat (Hi)	dB	64/66	65/68	65/69	65/67	69/69	70/70	71/71	
Dimension	H x W x D	mm	695 x 875 x 320	695 x 875 x 320	695 x 875 x 320	996 x 940 x 340	1416 x 940 x 340	1416 x 940 x 340	1416 x 940 x 340	
Net weight		kg	49	49	49	68	101	101	101	
Piping connections	Liquid pipe	Inch (mm)	1/4(6,35)	1/4(6,35)	3/8(9,52)	3/8(9,52)	3/8(9,52)	3/8(9,52)	3/8(9,52)	
	Gas pipe	Inch (mm)	1/2(12,70)	1/2(12,70)	5/8(15,88)	5/8(15,88)	5/8(15,88)	5/8(15,88)	5/8(15,88)	
Pipe length range		m	3~40	3~40	3~40	5~50	5~75	5~75	5~75	
Elevation difference (in/out) <sup>6)</sup>		m	30	30	30	30	30	30	30	
Pipe length for additional gas		m	30	30	30	30	30	30	30	
Additional gas amount		g/m	—	—	—	—	—	—	—	
Refrigerant (R32)		kg/TCO <sub>2</sub> Eq.	—	—	—	—	—	—	—	
Operating range	Cool Min ~ Max	°C	-15 ~ +46	-15 ~ +46	-15 ~ +46	-15 ~ +46	-15 ~ +46	-15 ~ +46	-15 ~ +46	
	Heat Min ~ Max	°C	-20 ~ +24	-20 ~ +24	-20 ~ +24	-20 ~ +24	-20 ~ +24	-20 ~ +24	-20 ~ +24	

Accessories	
<b>CZ-RTC5B</b>	Wired remote controller with Econavi button and datanavi
<b>CZ-RWS3 + CZ-RWRU3</b>	Wireless remote controller
<b>CZ-RE2C2</b>	Simplified remote controller
<b>CZ-CNEXU1</b>	nanoE™ X air purifying system

Accessories	
<b>CZ-KPU3A</b>	Econavi exclusive panel
<b>PAW-WTRAY</b>	Tray for condenser water compatible with base ground support
<b>PAW-GRDBSE20</b>	Outdoor base ground support for noise and vibration absorption



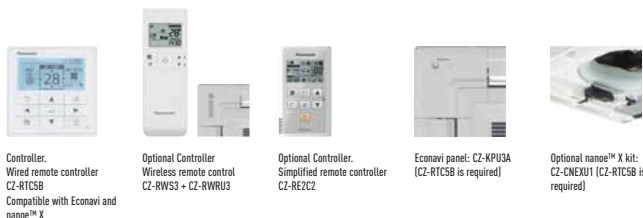

Controller. Wired remote controller CZ-RTCSB Compatible with Econavi and nanoE™ X  
 Optional Controller. Wireless remote control CZ-RWS3 + CZ-RWRU3  
 Optional Controller. Simplified remote controller CZ-REZC2  
 Econavi panel: CZ-KPU3A (CZ-RTCSB is required)  
 Optional nanoE™ X kit: CZ-CNEXU1 (CZ-RTCSB is required)

**Group control, circulation function**

Circulating operation is activated when a room is unoccupied to evenly distribute air and minimize temperature gaps in both heating and cooling operation.

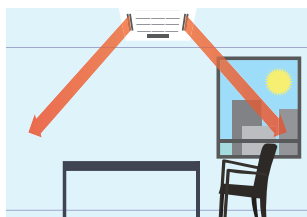

Circulation by Detecting no movement (10min.)



Indirect air flow by detecting movement

Tentative data			Three Phase			
			7,10kW	10,00kW	12,50kW	14,00kW
KIT			KIT-71PU2ZH8	KIT-100PU2ZH8	KIT-125PU2ZH8	KIT-140PU2ZH8
Remote controller			CZ-RTCSB	CZ-RTCSB	CZ-RTCSB	CZ-RTCSB
Cooling capacity	Nominal (Min - Max)	kW	7,10 (2,20 ~ 9,00)	10,00 (3,10 ~ 12,50)	12,50 (3,20 ~ 14,00)	14,00 (3,30 ~ 16,00)
EER <sup>1)</sup>		W/W	4,06	4,41	3,80	3,41
SEER <sup>2)</sup>		W/W	<b>7,60 A++</b>	<b>7,60 A++</b>	<b>7,60</b>	<b>7,20</b>
Pdesign		kW	7,10	10,00	12,50	14,00
Input power cooling		kW	1,75	2,27	3,29	4,11
Annual energy consumption <sup>3)</sup>		kWh/a	—	—	—	—
Heating capacity	Nominal (Min - Max)	kW	8,00 (2,00 ~ 9,00)	11,20 (3,30 ~ 14,00)	14,00 (3,40 ~ 16,00)	16,00 (3,50 ~ 18,00)
Heating capacity at -7°C / -15°C <sup>4)</sup>		kW	—	—	—	—
COP <sup>1)</sup>		W/W	4,30	5,00	4,61	4,30
SCOP <sup>2)</sup>		W/W	<b>4,80 A++</b>	<b>4,90 A++</b>	<b>4,70</b>	<b>4,60</b>
Pdesign at -10°C		kW	5,20	8,00	9,50	10,60
Input power heating		kW	1,86	2,24	3,04	3,72
Annual energy consumption <sup>3)</sup>		kWh/a	—	—	—	—
Indoor unit			S-71PU2E5B	S-100PU2E5B	S-125PU2E5B	S-140PU2E5B
Air volume	Hi / Med / Lo	m <sup>3</sup> /min	22,0 / 16,0 / 13,0	36,0 / 26,0 / 18,0	37,0 / 27,0 / 19,0	38,0 / 29,0 / 20,0
Sound pressure <sup>5)</sup>	Hi / Med / Lo	dB(A)	37 / 31 / 28	45 / 38 / 32	46 / 39 / 33	47 / 40 / 34
Dimension	Indoor (H x W x D)	mm	256 x 840 x 840	319 x 840 x 840	319 x 840 x 840	319 x 840 x 840
	Panel (H x W x D)	mm	33,5 x 950 x 950	33,5 x 950 x 950	33,5 x 950 x 950	33,5 x 950 x 950
Net weight	Indoor / Panel	kg	20 / 5	25 / 5	25 / 5	25 / 5
Outdoor unit			U-71PZH2E8	U-100PZH2E8	U-125PZH2E8	U-140PZH2E8
Power source		V	380 / 400 / 415	380 / 400 / 415	380 / 400 / 415	380 / 400 / 415
Recommended fuse		A	—	—	—	—
Connection indoor / outdoor		mm <sup>2</sup>	—	—	—	—
Current	Cool	A	—	—	—	—
	Heat	A	—	—	—	—
Air volume	Cool / Heat	m <sup>3</sup> /min	—	—	—	—
Sound pressure	Cool / Heat (Hi)	dB(A)	48 / 50	52 / 52	53 / 53	54 / 55
Sound power	Cool / Heat (Hi)	dB	65 / 67	69 / 69	70 / 70	71 / 71
Dimension	H x W x D	mm	996 x 940 x 340	1416 x 940 x 340	1416 x 940 x 340	1416 x 940 x 340
Net weight		kg	68	101	101	101
Piping connections	Liquid pipe	Inch (mm)	3/8 (9,52)	3/8 (9,52)	3/8 (9,52)	3/8 (9,52)
	Gas pipe	Inch (mm)	5/8 (15,88)	5/8 (15,88)	5/8 (15,88)	5/8 (15,88)
Pipe length range		m	5 ~ 50	5 ~ 75	5 ~ 75	5 ~ 75
Elevation difference (in/out) <sup>6)</sup>		m	30	30	30	30
Pipe length for additional gas		m	30	30	30	30
Additional gas amount		g/m	—	—	—	—
Refrigerant (R32)		kg / TCO <sub>2</sub> Eq.	—	—	—	—
Operating range	Cool Min ~ Max	°C	-15 ~ +46	-15 ~ +46	-15 ~ +46	-15 ~ +46
	Heat Min ~ Max	°C	-20 ~ +24	-20 ~ +24	-20 ~ +24	-20 ~ +24

1) EER and COP calculation is based in accordance to EN14511. 2) For models below 12kW, the SEER and SCOP is calculated based on values of EU/626/2011. For models above 12kW, the SEER and SCOP is calculated based on values of EU/2281/2016. 3) The annual energy consumption is calculated in accordance to EU/626/2011. 4) Heating capacity is calculated including defrost factor correction. 5) The sound pressure of the units shows the value measured of a position 1m in front of the main body and 1,5m from the ground. The sound pressure is measured in accordance with Eurovent 6/C/D06-97 specification. 6) When installing the outdoor unit at a higher position than the indoor unit.\* Recommended fuse for the indoor 3A.



SEER and SCOP: For KIT-36PU2ZH5, ECONAVI and INTERNET CONTROL: Optional.  
 Compatible with all Panasonic connectivity solutions. For detailed information go to the Control Systems section.

Rating Conditions: Cooling Indoor 27°C DB / 19°C WB. Cooling Outdoor 35°C DB / 24°C WB. Heating Indoor 20°C DB. Heating Outdoor 7°C DB / 6°C WB. (DB: Dry Bulb; WB: Wet Bulb)  
 Specifications subject to change without notice. For detailed information about ErP, please visit our websites www.aircon.panasonic.eu or www.gtc.panasonic.eu.



**nanoE™ X deodorises and inhibits certain bacteria & viruses**

The newly developed nanoE™ X device produces 10x times more OH radicals (4800 billion)<sup>1)</sup> than regular nanoE™ device. Greater amounts of OH radicals contained in nanoE™ X lead to outstanding effects in bacteria, viruses and allergens inhibition as well as deodorisation. A fresher and cleaner home awaits you.

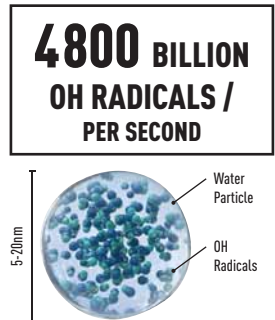

1) Based on Panasonic Survey.  
 CZ-RTCSB and optional accessory CZ-CNEXU1 are required to use nanoE™ X function.

# NEW PACi STANDARD 4 WAY 90x90 CASSETTE INVERTER+ • R32 GAS

NEW 18



## Large capacity PACi. Trusted comfort and high efficiency.

Thanks to advances in design and technology such as the high performance turbo fan which is more efficient and silent, and nanoe™ X air purification, the U2 Panasonic 4 way 90x90 Cassette offers high energy saving, fresh air and comfort.

## Technical focus

- High performance turbo fan, path system for heat exchanger
- nanoe™ X: The first air purifier technology in commercial air conditioning
- Econavi: Intelligent sensor to reduce waste of energy
- Datanavi simple support tool app with remote controller (CZ-RTC5B)
- Lower noise in slow fan operation
- Light weight, easy piping
- Drain pump included

			Single Phase					
			6,00kW	7,10kW	10,00kW	12,50kW	14,00kW	
KIT			KIT-60PU2Z5	KIT-71PU2Z5	KIT-100PU2Z5	KIT-125PU2Z5	KIT-140PU2Z5	
Remote controller			CZ-RTC5B	CZ-RTC5B	CZ-RTC5B	CZ-RTC5B	CZ-RTC5B	
Cooling capacity	Nominal (Min - Max)	kW	6,00 (2,00 - 7,10)	7,10 (2,00 - 7,70)	10,00 (3,00 - 11,50)	12,50 (3,20 - 13,50)	14,00 (3,30 - 15,00)	
EER <sup>1)</sup>	Nominal (Min - Max)	W/W	3,92	3,43	3,82 (5,36 - 2,88)	3,58 (5,33 - 2,81)	3,23 (5,32 - 2,73)	
SEER <sup>2)</sup>		W/W	7,10 A++	6,60 A++	6,80 A++	6,75	6,51	
Pdesign		kW	6,00	7,10	10,00	12,50	14,00	
Input power cooling	Nominal (Min - Max)	kW	1,53	2,07	2,62 (0,56 - 4,00)	3,49 (0,60 - 4,80)	4,34 (0,62 - 5,50)	
Annual energy consumption <sup>3)</sup>		kWh/a	—	—	515	—	—	
Heating capacity	Nominal (Min - Max)	kW	6,00 (1,80 - 7,00)	7,10 (1,80 - 8,10)	10,00 (3,00 - 14,00)	12,50 (3,30 - 15,00)	14,00 (3,40 - 16,00)	
Heating capacity at -7°C / -15°C <sup>4)</sup>		kW	—	—	—	—	—	
COP <sup>1)</sup>	Nominal (Min - Max)	W/W	4,44	4,18	4,93 (3,59 - 5,36)	4,43 (3,57 - 5,50)	4,18 (3,33 - 5,48)	
SCOP <sup>2)</sup>		W/W	4,60 A++	4,60 A++	4,40 A+	4,01	3,89	
Pdesign at -10°C		kW	6,00	6,00	10,00	12,50	14,00	
Input power heating	Nominal (Min - Max)	kW	1,35	1,70	2,03 (0,56 - 3,90)	2,82 (0,60 - 4,20)	3,35 (0,62 - 4,80)	
Annual energy consumption <sup>3)</sup>		kWh/a	—	—	3182	—	—	
<b>Indoor unit</b>			<b>S-60PU2E5B</b>	<b>S-71PU2E5B</b>	<b>S-100PU2E5B</b>	<b>S-125PU2E5B</b>	<b>S-140PU2E5B</b>	
Air volume	Hi / Med / Lo	m <sup>3</sup> /min	21,0/16,0/13,0	22,0/16,0/13,0	36,0/26,0/18,0	37,0/27,0/19,0	38,0/29,0/20,0	
Moisture removal volume		L/h	1,7	2,5	2,7	4,8	6,0	
Sound pressure <sup>5)</sup>	Hi / Med / Lo	dB(A)	36/31/28	37/31/28	45/38/32	46/39/33	47/40/34	
Sound power	Hi / Med / Lo	dB	51/46/43	52/46/43	60/53/47	61/54/48	62/55/49	
Dimension	Indoor (H x W x D)	mm	256 x 840 x 840	256 x 840 x 840	319 x 840 x 840	319 x 840 x 840	319 x 840 x 840	
	Panel (H x W x D)	mm	33,5 x 950 x 950	33,5 x 950 x 950	33,5 x 950 x 950	33,5 x 950 x 950	33,5 x 950 x 950	
Net weight	Indoor / Panel	kg	20/5	20/5	25/5	25/5	25/5	
<b>Outdoor unit</b>			<b>U-60PZ2E5</b>	<b>U-71PZ2E5</b>	<b>U-100PZ2E5</b>	<b>U-125PZ2E5</b>	<b>U-140PZ2E5</b>	
Power source		V	220/230/240	220/230/240	220/230/240	220/230/240	220/230/240	
Current	Cool	A	—	—	12,10/11,50/11,10	16,30/15,60/15,00	20,40/19,50/18,70	
	Heat	A	—	—	9,25/8,85/8,50	13,10/12,60/12,00	15,60/15,00/14,30	
Air volume	Cool / Heat	m <sup>3</sup> /min	—	—	76/70	86/78	89/83	
Sound pressure	Cool / Heat (Hi)	dB(A)	46/48	49/49	52/52	55/55	56/56	
Sound power	Cool / Heat (Hi)	dB	65/68	69/69	70/70	73/73	74/74	
Dimension	H x W x D	mm	695 x 875 x 320	695 x 875 x 320	996 x 980 x 370	996 x 980 x 370	996 x 980 x 370	
Net weight		kg	49	49	90	94	94	
Piping connections	Liquid pipe	Inch (mm)	3/8 (9,52)	3/8 (9,52)	3/8 (9,52)	3/8 (9,52)	3/8 (9,52)	
	Gas pipe	Inch (mm)	5/8 (15,88)	5/8 (15,88)	5/8 (15,88)	5/8 (15,88)	5/8 (15,88)	
Pipe length range		m	3 - 40	3 - 40	5 - 50	5 - 50	5 - 50	
Elevation difference (in/out) <sup>6)</sup>		m	30	30	30	30	30	
Pipe length for additional gas		m	30	30	30	30	30	
Additional gas amount		g/m	—	—	45	45	45	
Refrigerant (R32)		kg / TCO <sub>2</sub> Eq.	—	—	2,60 / 1,755	2,98 / 2,0115	2,98 / 2,0115	
Operating range	Cool Min ~ Max	°C	-10 ~ +43	-10 ~ +43	-10 ~ +43	-10 ~ +43	-10 ~ +43	
	Heat Min ~ Max	°C	-15 ~ +24	-15 ~ +24	-15 ~ +24	-15 ~ +24	-15 ~ +24	

### Accessories

<b>CZ-RTC5B</b>	Wired remote controller with Econavi button and datanavi
<b>CZ-RWS3 + CZ-RRWU3</b>	Wireless remote controller
<b>CZ-RE2C2</b>	Simplified remote controller
<b>CZ-CNEXU1</b>	nanoe™ X air purifying system

### Accessories

<b>CZ-KPU3A</b>	Econavi exclusive panel
<b>PAW-WTRAY</b>	Tray for condenser water compatible with base ground support
<b>PAW-GRDBSE20</b>	Outdoor base ground support for noise and vibration absorption

PACi Kits

R32



Controller. Wired remote controller CZ-RTCSB Compatible with Econavi and nanoE™ X  
 Optional Controller Wireless remote controller CZ-RWS3 + CZ-RWRU3  
 Optional Controller. Simplified remote controller CZ-REZC2  
 Econavi panel: CZ-KPU3A (CZ-RTCSB is required)  
 Optional nanoE™ X kit: CZ-CNEXU1 (CZ-RTCSB is required)



Group control, circulation function

Circulating operation is activated when a room is unoccupied to evenly distribute air and minimize temperature gaps in both heating and cooling operation.

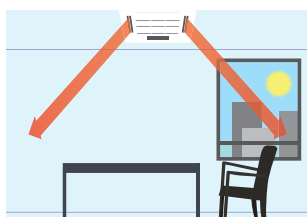

Circulation by Detecting no movement (10min.)



Indirect air flow by detecting movement

nanoE™ X deodorises and inhibits certain bacteria & viruses

The newly developed nanoE™ X device produces 10x times more OH radicals (4800 billion)<sup>1</sup> than regular nanoE™ device. Greater amounts of OH radicals contained in nanoE™ X lead to outstanding effects in bacteria, viruses and allergens inhibition as well as deodorisation. A fresher and cleaner home awaits you.

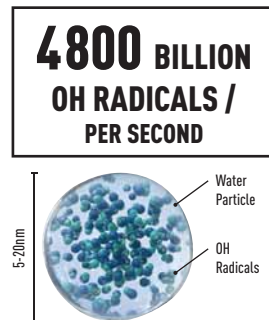

<sup>1</sup> Based on Panasonic Survey. CZ-RTCSB and optional accessory CZ-CNEXU1 are required to use nanoE™ X function.

KIT	10,00kW			12,50kW			14,00kW				
	KIT-100PU2Z8			KIT-125PU2Z8			KIT-140PU2Z8				
Remote controller	CZ-RTCSB			CZ-RTCSB			CZ-RTCSB				
Cooling capacity	Nominal (Min - Max)	kW	10,00 (3,00 - 11,50)	12,50 (3,20 - 13,50)	14,00 (3,30 - 15,00)	EER <sup>1)</sup>	Nominal (Min - Max)	W/W	3,82 (5,36 - 2,88)	3,58 (5,33 - 2,81)	3,23 (5,32 - 2,73)
SEER <sup>2)</sup>		W/W	6,70 A++	6,73	6,49	Pdesign		kW	10,00	12,50	14,00
Input power cooling	Nominal (Min - Max)	kW	2,62 (0,56 - 4,00)	3,49 (0,60 - 4,80)	4,34 (0,62 - 5,50)	Annual energy consumption <sup>3)</sup>		kWh/a	521	—	—
Heating capacity	Nominal (Min - Max)	kW	10,00 (3,00 - 14,00)	12,50 (3,30 - 15,00)	14,00 (3,30 - 16,00)	Heating capacity at -7°C / -15°C <sup>4)</sup>		kW	—	—	—
COP <sup>1)</sup>	Nominal (Min - Max)	W/W	4,93 (3,59 - 5,36)	4,43 (3,57 - 5,50)	4,18 (3,33 - 5,48)	SCOP <sup>2)</sup>		W/W	4,40 A+	4,01	3,89
Input power heating	Nominal (Min - Max)	kW	2,03 (0,56 - 3,90)	2,82 (0,60 - 4,20)	3,35 (0,62 - 4,80)	Pdesign at -10°C		kW	10,00	12,50	14,00
Annual energy consumption <sup>3)</sup>		kWh/a	3182	—	—	Indoor unit					
Air volume	Hi / Med / Lo	m <sup>3</sup> /min	36,0 / 26,0 / 18,0	37,0 / 27,0 / 19,0	38,0 / 29,0 / 20,0	Moisture removal volume		L/h	2,7	4,8	6,0
Sound pressure <sup>5)</sup>	Hi / Med / Lo	dB(A)	45 / 38 / 32	46 / 39 / 33	47 / 40 / 34	Sound power		dB	60 / 53 / 47	61 / 54 / 48	62 / 55 / 49
Dimension	Indoor (H x W x D)	mm	319 x 840 x 840	319 x 840 x 840	319 x 840 x 840	Net weight		kg	25/5	25/5	25/5
	Panel (H x W x D)	mm	33,5 x 950 x 950	33,5 x 950 x 950	33,5 x 950 x 950	Outdoor unit					
	Indoor / Panel	kg	25/5	25/5	25/5	Power source		V	380/400/415	380/400/415	380/400/415
Current	Cool	A	4,10 / 3,90 / 3,75	5,45 / 5,20 / 5,00	6,85 / 6,50 / 6,25	Air volume		m <sup>3</sup> /min	76 / 70	86 / 78	89 / 83
	Heat	A	3,15 / 3,00 / 2,90	4,40 / 4,15 / 4,00	5,25 / 4,95 / 4,80	Sound pressure		dB(A)	52 / 52	55 / 55	56 / 56
Sound power	Cool / Heat	dB	60 / 53 / 47	61 / 54 / 48	62 / 55 / 49	Sound power		dB	70 / 70	73 / 73	74 / 74
Dimension	H x W x D	mm	996 x 980 x 370	996 x 980 x 370	996 x 980 x 370	Dimension		mm	996 x 980 x 370	996 x 980 x 370	996 x 980 x 370
Net weight		kg	90	94	94	Piping connections		Inch (mm)	3/8 (9,52)	3/8 (9,52)	3/8 (9,52)
Piping connections	Liquid pipe	Inch (mm)	3/8 (9,52)	3/8 (9,52)	3/8 (9,52)	Gas pipe		Inch (mm)	5/8 (15,88)	5/8 (15,88)	5/8 (15,88)
Pipe length range		m	5 - 50	5 - 50	5 - 50	Pipe length range		m	5 - 50	5 - 50	5 - 50
Elevation difference (in/out) <sup>6)</sup>		m	30	30	30	Elevation difference (in/out) <sup>6)</sup>		m	30	30	30
Pipe length for additional gas		m	30	30	30	Pipe length for additional gas		m	30	30	30
Additional gas amount		g/m	45	45	45	Additional gas amount		g/m	45	45	45
Refrigerant (R32)		kg / TCO: Eq.	2,60 / 1,755	2,98 / 2,0115	2,98 / 2,0115	Refrigerant (R32)		kg / TCO: Eq.	2,60 / 1,755	2,98 / 2,0115	2,98 / 2,0115
Operating range	Cool Min ~ Max	°C	-10 ~ +43	-10 ~ +43	-10 ~ +43	Operating range		°C	-10 ~ +43	-10 ~ +43	-10 ~ +43
	Heat Min ~ Max	°C	-15 ~ +24	-15 ~ +24	-15 ~ +24			°C	-15 ~ +24	-15 ~ +24	-15 ~ +24

1) EER and COP calculation is based in accordance to EN14511. 2) For models below 12kW, the SEER and SCOP is calculated based on values of EU/626/2011. For models above 12kW, the SEER and SCOP is calculated based on values of EU/2281/2016. 3) The annual energy consumption is calculated in accordance to EU/626/2011. 4) Heating capacity is calculated including defrost factor correction. 5) The sound pressure of the units shows the value measured of a position 1m in front of the main body and 1,5m from the ground. The sound pressure is measured in accordance with Eurovent 6/C/D06-97 specification. 6) When installing the outdoor unit at a higher position than the indoor unit. \* Recommended fuse for the indoor 3A.

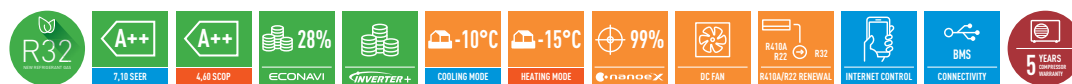

SEER and SCOP: For KIT-60PUZ25. ECONAVI and INTERNET CONTROL: Optional. Compatible with all Panasonic connectivity solutions. For detailed information go to the Control Systems section.

Rating Conditions: Cooling Indoor 27°C DB / 19°C WB. Cooling Outdoor 35°C DB / 24°C WB. Heating Indoor 20°C DB. Heating Outdoor 7°C DB / 6°C WB. (DB: Dry Bulb; WB: Wet Bulb) Specifications subject to change without notice. For detailed information about ErP, please visit our websites www.aircon.panasonic.eu or www.gtc.panasonic.eu.

## NEW PACi ELITE CEILING INVERTER+

### • R32 GAS



Ceiling mounted units provide large and wide air distribution which is good for big rooms. The height and depth of all capacities are the same for unified appearance in mixed installations.

#### Technical focus

- Wide air distribution for large rooms
- Horizontal air flow reaches maximum 9,5m
- Fresh air connection available on the unit
- Slim design with 235mm height fits narrow space
- Silent operation
- Datanavi simple support tool app with remote controller (CZ-RTC5B)
- Twin, Triple and Double-twin split options
- Easy connection and control of external fan or ERV using the connector PAW-FDC on the indoor unit PCB. The external device can be controlled by the remote control of the Panasonic indoor unit

Tentative data			Single Phase						
KIT			3,60kW	5,00kW	6,00kW	7,10kW	10,00kW	12,50kW	14,00kW
Remote controller			KIT-36PT2ZH5 CZ-RTC5B	KIT-50PT2ZH5 CZ-RTC5B	KIT-60PT2ZH5 CZ-RTC5B	KIT-71PT2ZH5 CZ-RTC5B	KIT-100PT2ZH5 CZ-RTC5B	KIT-125PT2ZH5 CZ-RTC5B	KIT-140PT2ZH5 CZ-RTC5B
Cooling capacity	kW		3,60	5,00	6,00	7,10	10,00	12,50	14,00
EER <sup>1)</sup>	W/W		5,14	4,07	3,92	3,76	4,03	3,41	3,08
SEER <sup>2)</sup>	W/W		<b>6,90A++</b>	<b>6,90A++</b>	<b>6,80A++</b>	<b>6,20A++</b>	<b>6,70A++</b>	<b>6,10</b>	<b>5,70</b>
Pdesign	kW		3,60	5,00	6,00	7,10	10,00	12,50	14,00
Input power cooling	kW		0,70	1,23	1,53	1,89	2,48	3,67	4,55
Annual energy consumption <sup>3)</sup>	kWh/a		—	—	—	—	—	—	—
Heating capacity	kW		4,00	5,60	7,00	8,00	11,20	14,00	16,00
Heating capacity at -7°C / -15°C <sup>4)</sup>	kW		—	—	—	—	—	—	—
COP <sup>1)</sup>	W/W		5,26	4,34	4,24	4,15	4,31	3,99	3,67
SCOP <sup>2)</sup>	W/W		<b>4,50A+</b>	<b>4,30A+</b>	<b>4,30A+</b>	<b>4,20A+</b>	<b>4,30A+</b>	<b>4,10</b>	<b>4,00</b>
Pdesign at -10°C	kW		3,60	4,50	6,00	5,20	8,00	9,50	10,60
Input power heating	kW		0,76	1,29	1,65	1,93	2,60	3,51	4,36
Annual energy consumption <sup>3)</sup>	kWh/a		—	—	—	—	—	—	—
Indoor unit			S-36PT2E5B	S-50PT2E5B	S-60PT2E5B	S-71PT2E5B	S-100PT2E5B	S-125PT2E5B	S-140PT2E5B
Air volume	Hi / Med / Lo	m <sup>3</sup> /min	14,0/12,0/10,5	15,0/12,5/10,5	20,0/17,0/14,5	21,0/18,0/15,5	30,0/25,0/23,0	34,0/28,0/24,0	35,0/29,0/25,0
Sound pressure <sup>5)</sup>	Hi / Med / Lo	dB(A)	36/32/29	37/33/29	38/34/30	39/35/31	42/37/35	46/40/36	47/41/37
Dimension	HxWxD	mm	235x960x690	235x960x690	235x1275x690	235x1275x690	235x1590x690	235x1590x690	235x1590x690
Net weight	Indoor / Panel	kg	27	27	33	33	40	40	40
Outdoor unit			U-36PZH2E5	U-50PZH2E5	U-60PZH2E5	U-71PZH2E5	U-100PZH2E5	U-125PZH2E5	U-140PZH2E5
Power source		V	220/230/240	220/230/240	220/230/240	220/230/240	220/230/240	220/230/240	220/230/240
Recommended fuse		A	—	—	—	—	—	—	—
Current	Cool	A	—	—	—	—	—	—	—
	Heat	A	—	—	—	—	—	—	—
Air volume	Cool / Heat	m <sup>3</sup> /min	—	—	—	—	—	—	—
Sound pressure	Cool / Heat (Hi)	dB(A)	45/46	46/48	46/49	48/50	52/52	53/53	54/55
Sound power	Cool / Heat (Hi)	dB	64/66	65/68	65/69	65/67	69/69	70/70	71/71
Dimension	HxWxD	mm	695x875x320	695x875x320	695x875x320	996x940x340	1416x940x340	1416x940x340	1416x940x340
Net weight		kg	49	49	49	68	101	101	101
Piping connections	Liquid pipe	Inch (mm)	1/4(6,35)	1/4(6,35)	3/8(9,52)	3/8(9,52)	3/8(9,52)	3/8(9,52)	3/8(9,52)
	Gas pipe	Inch (mm)	1/2(12,70)	1/2(12,70)	5/8(15,88)	5/8(15,88)	5/8(15,88)	5/8(15,88)	5/8(15,88)
Pipe length range		m	3~40	3~40	3~40	5~50	5~75	5~75	5~75
Elevation difference (in/out) <sup>6)</sup>		m	30	30	30	30	30	30	30
Pipe length for additional gas		m	30	30	30	30	30	30	30
Additional gas amount		g/m	—	—	—	—	—	—	—
Refrigerant (R32)		kg/TCO <sub>2</sub> Eq.	—	—	—	—	—	—	—
Operating range	Cool Min ~ Max	°C	-15~+46	-15~+46	-15~+46	-15~+46	-15~+46	-15~+46	-15~+46
	Heat Min ~ Max	°C	-20~+24	-20~+24	-20~+24	-20~+24	-20~+24	-20~+24	-20~+24

#### Accessories

<b>CZ-RTC5B</b>	Wired remote controller with Econavi button and datanavi
<b>CZ-RWS3 + CZ-RWRT3</b>	Wireless remote controller
<b>CZ-RE2C2</b>	Simplified remote controller
<b>PAW-WTRAY</b>	Tray for condenser water compatible with base ground support

#### Accessories

<b>PAW-GRDBSE20</b>	Outdoor base ground support for noise and vibration absorption
<b>PAW-GRDSTD40</b>	Outdoor elevation platform 400x900x400mm



Controller. Wired remote controller CZ-RTCSB Compatible with Econavi  
 Optional Controller. Wireless remote controller CZ-RWS3 + CZ-RWR13  
 Optional Controller. Simplified remote controller CZ-REZC2  
 Optional Econavi Sensor. CZ-CENSC1

PACi Kits R32



Further comfort improvement with airflow distribution

Horizontal air flow reaches maximum 9,5m. This is ideal for wide rooms.

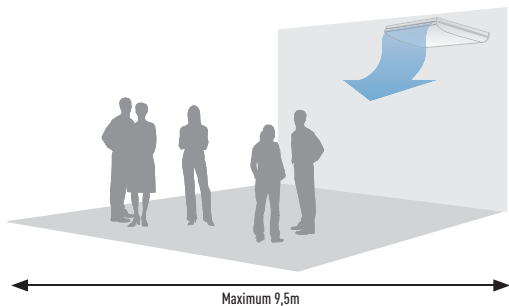

The wide air discharge opening expands the air flow to the left and the right. The unpleasant feeling caused when the air flow directly hits the human body is prevented by the "Draft prevention position", which changes the swing width, so that the degree of comfort is increased.

Air distribution is altered depending on the operational mode of the unit

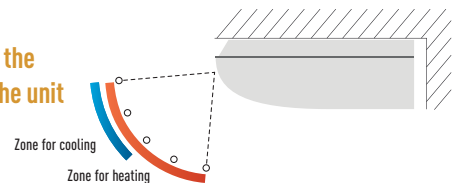

Tentative data		Three Phase			
KIT		7,10kW	10,00kW	12,50kW	14,00kW
Remote controller		KIT-71PT2ZH8	KIT-100PT2ZH8	KIT-125PT2ZH8	KIT-140PT2ZH8
		CZ-RTCSB	CZ-RTCSB	CZ-RTCSB	CZ-RTCSB
Cooling capacity	kW	7,10	10,00	12,50	14,00
EER <sup>1)</sup>	W/W	3,76	4,03	3,41	3,08
<b>SEER <sup>2)</sup></b>	<b>W/W</b>	<b>6,00 A+</b>	<b>6,70 A++</b>	<b>6,10</b>	<b>5,70</b>
Pdesign	kW	7,10	10,00	12,50	14,00
Input power cooling	kW	1,89	2,48	3,67	4,55
Annual energy consumption <sup>3)</sup>	kWh/a	—	—	—	—
Heating capacity	kW	8,00	11,20	14,00	16,00
Heating capacity at -7°C / -15°C <sup>4)</sup>	kW	—	—	—	—
COP <sup>1)</sup>	W/W	4,15	4,31	3,99	3,67
<b>SCOP <sup>2)</sup></b>	<b>W/W</b>	<b>4,20 A+</b>	<b>4,30 A+</b>	<b>4,10</b>	<b>4,00</b>
Pdesign at -10°C	kW	5,20	8,00	9,50	10,60
Input power heating	kW	1,93	2,60	3,51	4,36
Annual energy consumption <sup>3)</sup>	kWh/a	—	—	—	—
<b>Indoor unit</b>		<b>S-71PZH2E5B</b>	<b>S-100PZH2E5B</b>	<b>S-125PZH2E5B</b>	<b>S-140PZH2E5B</b>
Air volume	Hi / Med / Lo	m <sup>3</sup> /min	21,0/18,0/15,5	30,0/25,0/23,0	34,0/28,0/24,0
Sound pressure <sup>5)</sup>	Hi / Med / Lo	dB(A)	39/35/31	42/37/35	46/40/36
Dimension	H x W x D	mm	235 x 1275 x 690	235 x 1590 x 690	235 x 1590 x 690
Net weight	Indoor / Panel	kg	33	40	40
<b>Outdoor unit</b>		<b>U-71PZH2E8</b>	<b>U-100PZH2E8</b>	<b>U-125PZH2E8</b>	<b>U-140PZH2E8</b>
Power source		V	380/400/415	380/400/415	380/400/415
Recommended fuse		A	—	—	—
Current	Cool	A	—	—	—
	Heat	A	—	—	—
Air volume	Cool / Heat	m <sup>3</sup> /min	—	—	—
Sound pressure	Cool / Heat (Hi)	dB(A)	48/50	52/52	53/53
Sound power	Cool / Heat (Hi)	dB	65/67	69/69	70/70
Dimension	H x W x D	mm	996 x 940 x 340	1416 x 940 x 340	1416 x 940 x 340
Net weight		kg	68	101	101
Piping connections	Liquid pipe	Inch (mm)	3/8(9,52)	3/8(9,52)	3/8(9,52)
	Gas pipe	Inch (mm)	5/8(15,88)	5/8(15,88)	5/8(15,88)
Pipe length range		m	5-50	5-75	5-75
Elevation difference (in/out) <sup>6)</sup>		m	30	30	30
Pipe length for additional gas		m	30	30	30
Additional gas amount		g/m	—	—	—
Refrigerant (R32)		kg/TCO <sub>2</sub> Eq.	—	—	—
Operating range	Cool Min ~ Max	°C	-15 ~ +46	-15 ~ +46	-15 ~ +46
	Heat Min ~ Max	°C	-20 ~ +24	-20 ~ +24	-20 ~ +24

1) EER and COP calculation is based in accordance to EN14511. 2) For models below 12kW, the SEER and SCOP is calculated based on values of EU/626/2011. For models above 12kW, the SEER and SCOP is calculated based on values of EU/2281/2016. 3) The annual energy consumption is calculated in accordance to EU/626/2011. 4) Heating capacity is calculated including defrost factor correction. 5) The sound pressure of the units shows the value measured of a position 1m in front of the main body and 1,5m from the ground. The sound pressure is measured in accordance with Eurovent 6/C/006-97 specification. 6) When installing the outdoor unit at a higher position than the indoor unit.\* Recommended fuse for the indoor 3A.



SEER and SCOP: For KIT-36PT2ZH5. INTERNET CONTROL: Optional.  
 Compatible with all Panasonic connectivity solutions. For detailed information go to the Control Systems section.

Rating Conditions: Cooling Indoor 27°C DB / 19°C WB. Cooling Outdoor 35°C DB / 24°C WB. Heating Indoor 20°C DB. Heating Outdoor 7°C DB / 6°C WB. (DB: Dry Bulb; WB: Wet Bulb)  
 Specifications subject to change without notice. For detailed information about ErP, please visit our websites www.aircon.panasonic.eu or www.gtc.panasonic.eu.

## NEW PACi STANDARD CEILING INVERTER+

### • R32 GAS



Ceiling mounted units provide large and wide air distribution which is good for big rooms. The height and depth of all capacities are the same for unified appearance in mixed installations.

#### Technical focus

- Wide air distribution for large rooms
- Horizontal air flow reaches maximum 9,5m
- Fresh air connection available on the unit
- Slim design with 235mm height fits narrow space
- Silent operation
- Datanavi simple support tool app with remote controller (CZ-RTC5B)
- Twin, Triple and Double-twin split options
- Easy connection and control of external fan or ERV using the connector PAW-FDC on the indoor unit PCB. The external device can be controlled by the remote control of the Panasonic indoor unit

Tentative data			Single Phase					
			6,00kW	7,10kW	10,00kW	12,50kW	14,00kW	
KIT			KIT-60PT2Z5	KIT-71PT2Z5	KIT-100PT2Z5	KIT-125PT2Z5	KIT-140PT2Z5	
Remote controller			CZ-RTC5B	CZ-RTC5B	CZ-RTC5B	CZ-RTC5B	CZ-RTC5B	
Cooling capacity	Nominal (Min - Max)	kW	6,00	7,10	10,00 (3,00 - 11,50)	12,50 (3,20 - 13,50)	14,00 (3,30 - 15,00)	
EER <sup>1)</sup>	Nominal (Min - Max)	W/W	3,82	3,33	3,64 (5,36 - 2,80)	3,32 (5,33 - 2,77)	2,98 (5,32 - 2,73)	
SEER <sup>2)</sup>		W/W	6,70A++	6,10A++	6,50A++	5,77	5,49	
P <sub>design</sub>		kW	6,00	7,10	10,00	12,50	14,00	
Input power cooling	Nominal (Min - Max)	kW	1,57	2,13	2,75 (0,56 - 4,10)	3,76 (0,60 - 4,88)	4,70 (0,62 - 5,50)	
Annual energy consumption <sup>3)</sup>		kWh/a	—	—	535	1300	1530	
Heating capacity	Nominal (Min - Max)	kW	6,00	7,10	10,00 (3,00 - 14,00)	12,50 (3,30 - 15,00)	14,00 (3,40 - 16,00)	
Heating capacity at -7°C / -15°C <sup>4)</sup>		kW	—	—	8,85 / 6,40	11,00 / 8,00	12,00 / 8,40	
COP <sup>1)</sup>	Nominal (Min - Max)	W/W	4,51	4,25	4,24 (5,36 - 3,50)	3,89 (4,52 - 3,41)	3,70 (5,48 - 3,08)	
SCOP <sup>2)</sup>		W/W	4,20A+	4,20A+	4,20A+	3,75	3,70	
P <sub>design</sub> at -10°C		kW	6,00	6,00	10,00	12,50	13,60	
Input power heating	Nominal (Min - Max)	kW	1,33	1,67	2,36 (0,56 - 4,00)	3,21 (0,73 - 4,40)	3,78 (0,62 - 5,20)	
Annual energy consumption <sup>3)</sup>		kWh/a	—	—	3324	4669	5153	
Indoor unit			S-60PT2E5B	S-71PT2E5B	S-100PT2E5B	S-125PT2E5B	S-140PT2E5B	
Air volume	Hi / Med / Lo	m <sup>3</sup> /min	20,0 / 17,0 / 14,5	21,0 / 18,0 / 15,5	30/25/23	34/28/24	35/29/25	
Moisture removal volume		L/h	3,4	4,2	6,0	7,9	9,0	
Sound pressure <sup>5)</sup>	Hi / Med / Lo	dB(A)	38/34/30	39/35/31	42/37/35	46/40/36	47/41/37	
Sound power	Hi / Med / Lo	dB	56/52/48	57/53/49	60/55/53	64/58/54	65/59/55	
Dimension	H x W x D	mm	235 x 1275 x 690	235 x 1275 x 690	235 x 1590 x 690	235 x 1590 x 690	235 x 1590 x 690	
Net weight		kg	33	33	40	40	40	
Outdoor unit			U-60PZ2E5	U-71PZ2E5	U-100PZ2E5	U-125PZ2E5	U-140PZ2E5	
Power source		V	220/230/240	220/230/240	220/230/240	220/230/240	220/230/240	
Current	Cool	A	—	—	12,80/12,20/11,70	17,60/16,90/16,20	22,10/21,20/20,30	
	Heat	A	—	—	10,90/10,40/10,00	15,00/14,30/13,70	17,70/16,90/16,20	
Air volume	Cool / Heat	m <sup>3</sup> /min	—	—	76/70	86/78	89/83	
Sound pressure	Cool / Heat (Hi)	dB(A)	46/48	49/49	52/52	55/55	56/56	
Sound power	Cool / Heat (Hi)	dB	65/68	69/69	70/70	73/73	74/74	
Dimension	H x W x D	mm	695 x 875 x 320	695 x 875 x 320	996 x 980 x 370	996 x 980 x 370	996 x 980 x 370	
Net weight		kg	49	49	90	94	94	
Piping connections	Liquid pipe	Inch (mm)	3/8 (9,52)	3/8 (9,52)	3/8 (9,52)	3/8 (9,52)	3/8 (9,52)	
	Gas pipe	Inch (mm)	5/8 (15,88)	5/8 (15,88)	5/8 (15,88)	5/8 (15,88)	5/8 (15,88)	
Pipe length range		m	3-40	3-40	5-50	5-50	5-50	
Elevation difference (in/out) <sup>6)</sup>		m	30	30	30	30	30	
Pipe length for additional gas		m	30	30	30	30	30	
Additional gas amount		g/m	—	—	45	45	45	
Refrigerant (R32)		kg/TCO <sub>2</sub> Eq.	—	—	2,60/1,755	2,98/2,0115	2,98/2,0115	
Operating range	Cool Min ~ Max	°C	-10 ~ +43	-10 ~ +43	-10 ~ +43	-10 ~ +43	-10 ~ +43	
	Heat Min ~ Max	°C	-15 ~ +24	-15 ~ +24	-15 ~ +24	-15 ~ +24	-15 ~ +24	

#### Accessories

<b>CZ-RTC5B</b>	Wired remote controller with Econavi button and datanavi
<b>CZ-RWS3 + CZ-RWRT3</b>	Wireless remote controller
<b>CZ-RE2C2</b>	Simplified remote controller

#### Accessories

<b>PAW-WTRAY</b>	Tray for condenser water compatible with base ground support
<b>PAW-GRDBSE20</b>	Outdoor base ground support for noise and vibration absorption
<b>PAW-GRDSTD40</b>	Outdoor elevation platform 400 x 900 x 400mm

PACi Kits

R32



**Further comfort improvement with airflow distribution**  
Horizontal air flow reaches maximum 9,5m. This is ideal for wide rooms.

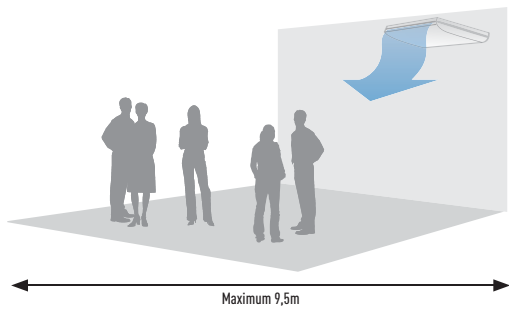

The wide air discharge opening expands the air flow to the left and the right. The unpleasant feeling caused when the air flow directly hits the human body is prevented by the "Draft prevention position", which changes the swing width, so that the degree of comfort is increased.

**Air distribution is altered depending on the operational mode of the unit**

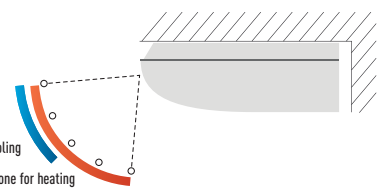

Tentative data			Three Phase		
			10,00kW	12,50kW	14,00kW
KIT			KIT-100PT2Z8	KIT-125PT2Z8	KIT-140PT2Z8
Remote controller			CZ-RTCSB	CZ-RTCSB	CZ-RTCSB
Cooling capacity	Nominal (Min - Max)	kW	10,00 (3,00 - 11,50)	12,50 (3,20 - 13,50)	14,00 (3,30 - 15,00)
EER <sup>1)</sup>	Nominal (Min - Max)	W/W	3,64 (5,36 - 2,80)	3,32 (5,33 - 2,77)	2,98 (5,32 - 2,73)
<b>SEER<sup>2)</sup></b>		<b>W/W</b>	<b>6,50 A++</b>	<b>5,75</b>	<b>5,48</b>
Pdesign		kW	10,00	12,50	14,00
Input power cooling	Nominal (Min - Max)	kW	2,75 (0,56 - 4,10)	3,76 (0,60 - 4,88)	4,70 (0,62 - 5,50)
Annual energy consumption <sup>3)</sup>		kWh/a	538	1304	1534
Heating capacity	Nominal (Min - Max)	kW	10,00 (3,00 - 14,00)	12,50 (3,30 - 15,00)	14,00 (3,40 - 16,00)
Heating capacity at -7°C / -15°C <sup>4)</sup>		kW	8,85 / 6,40	11,00 / 8,00	12,00 / 8,40
COP <sup>1)</sup>	Nominal (Min - Max)	W/W	4,24 (5,36 - 3,50)	3,89 (4,52 - 3,41)	3,70 (5,48 - 3,08)
<b>SCOP<sup>2)</sup></b>		<b>W/W</b>	<b>4,20 A+</b>	<b>3,75</b>	<b>3,70</b>
Pdesign at -10°C		kW	10,00	12,50	13,60
Input power heating	Nominal (Min - Max)	kW	2,36 (0,56 - 4,00)	3,21 (0,73 - 4,40)	3,78 (0,62 - 5,20)
Annual energy consumption <sup>3)</sup>		kWh/a	3324	4669	5153
<b>Indoor unit</b>			<b>S-100PT2E5B</b>	<b>S-125PT2E5B</b>	<b>S-140PT2E5B</b>
Air volume	Hi / Med / Lo	m <sup>3</sup> /min	30/25/23	34/28/24	35/29/25
Moisture removal volume		L/h	6,0	7,9	9,0
Sound pressure <sup>5)</sup>	Hi / Med / Lo	dB(A)	42/37/35	46/40/36	47/41/37
Sound power	Hi / Med / Lo	dB	60/55/53	64/58/54	65/59/55
Dimension	H x W x D	mm	235 x 1590 x 690	235 x 1590 x 690	235 x 1590 x 690
Net weight		kg	40	40	40
<b>Outdoor unit</b>			<b>U-100PZ2E8</b>	<b>U-125PZ2E8</b>	<b>U-140PZ2E8</b>
Power source		V	380/400/415	380/400/415	380/400/415
Current	Cool	A	4,37/4,15/4,00	5,90/5,60/5,40	7,40/7,05/6,80
	Heat	A	3,72/3,55/3,40	5,00/4,75/4,60	5,90/5,60/5,40
Air volume	Cool / Heat	m <sup>3</sup> /min	76/70	86/78	89/83
Sound pressure	Cool / Heat (Hi)	dB(A)	52/52	55/55	56/56
Sound power	Cool / Heat (Hi)	dB	70/70	73/73	74/74
Dimension	H x W x D	mm	996 x 980 x 370	996 x 980 x 370	996 x 980 x 370
Net weight		kg	90	94	94
Piping connections	Liquid pipe	Inch (mm)	3/8 (9,52)	3/8 (9,52)	3/8 (9,52)
	Gas pipe	Inch (mm)	5/8 (15,88)	5/8 (15,88)	5/8 (15,88)
Pipe length range		m	5 - 50	5 - 50	5 - 50
Elevation difference (in/out) <sup>6)</sup>		m	30	30	30
Pipe length for additional gas		m	30	30	30
Additional gas amount		g/m	45	45	45
Refrigerant (R32)		kg/TCO <sub>2</sub> Eq.	2,60 / 1,755	2,98 / 2,0115	2,98 / 2,0115
Operating range	Cool Min ~ Max	°C	-10 ~ +43	-10 ~ +43	-10 ~ +43
	Heat Min ~ Max	°C	-15 ~ +24	-15 ~ +24	-15 ~ +24

1) EER and COP calculation is based in accordance to EN14511. 2) For models below 12kW, the SEER and SCOP is calculated based on values of EU/626/2011. For models above 12kW, the SEER and SCOP is calculated based on values of EU/2281/2016. 3) The annual energy consumption is calculated in accordance to EU/626/2011. 4) Heating capacity is calculated including defrost factor correction. 5) The sound pressure of the units shows the value measured of a position 1m in front of the main body and 1,5m from the ground. The sound pressure is measured in accordance with Eurovent 6/C/006-97 specification. 6) When installing the outdoor unit at a higher position than the indoor unit.\* Recommended fuse for the indoor 3A.

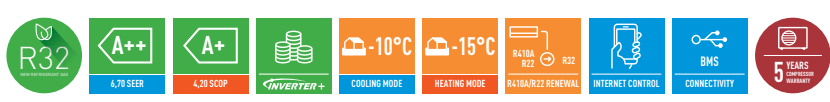

SEER and SCOP: For KIT-60PT2Z5. INTERNET CONTROL: Optional.  
Compatible with all Panasonic connectivity solutions. For detailed information go to the Control Systems section.

Rating Conditions: Cooling Indoor 27°C DB / 19°C WB. Cooling Outdoor 35°C DB / 24°C WB. Heating Indoor 20°C DB. Heating Outdoor 7°C DB / 6°C WB. (DB: Dry Bulb; WB: Wet Bulb)  
Specifications subject to change without notice. For detailed information about ErP, please visit our websites www.aircon.panasonic.eu or www.gtc.panasonic.eu.

## NEW PACi ELITE HIGH STATIC PRESSURE HIDE AWAY INVERTER+ • R32 GAS



The ducted systems are the ideal solution for flexible, concealed air conditioning and the optional 200mm spigots ensure simple, hassle-free connection to spiral ductwork.

### Technical focus

- High ESP (external static pressure) up to 150 Pa
- Automatic learning function for the required static pressure on site during commissioning (a standard wired remote controller is required)
- DC FAN for better efficiency and control
- Built in drain pump
- Datanavi simple support tool app with remote controller (CZ-RTC5B)
- Twin split options
- Easy connection and control of external fan or ERV using the connector PAW-FDC on the indoor unit PCB. The external device can be controlled by the remote control of the Panasonic indoor unit

Tentative data			Single Phase							
KIT			3,60kW	5,00kW	6,00kW	7,10kW	10,00kW	12,50kW	14,00kW	
Remote controller			KIT-36PF1ZH5 CZ-RTC5B	KIT-50PF1ZH5 CZ-RTC5B	KIT-60PF1ZH5 CZ-RTC5B	KIT-71PF1ZH5 CZ-RTC5B	KIT-100PF1ZH5 CZ-RTC5B	KIT-125PF1ZH5 CZ-RTC5B	KIT-140PF1ZH5 CZ-RTC5B	
Cooling capacity	kW		3,60	5,00	6,00	7,10	10,00	12,50	14,00	
EER <sup>1)</sup>	W/W		4,74	4,20	3,85	3,92	4,18	3,56	3,32	
SEER <sup>2)</sup>	W/W		5,90A+	6,00A+	6,10A++	6,40A++	5,80A+	5,90	5,80	
P <sub>design</sub>	kW		3,60	5,00	6,00	7,10	10,00	12,50	14,00	
Input power cooling	kW		0,76	1,19	1,56	1,81	2,39	3,51	4,22	
Annual energy consumption <sup>3)</sup>	kWh/a		—	—	—	—	—	—	—	
Heating capacity	kW		4,00	5,60	7,00	8,00	11,20	14,00	16,00	
Heating capacity at -7°C / -15°C <sup>4)</sup>	kW		—	—	—	—	—	—	—	
COP <sup>1)</sup>	W/W		4,76	4,18	4,02	3,85	4,31	4,02	3,60	
SCOP <sup>2)</sup>	W/W		4,10A+	4,10A+	4,20A+	4,20A+	3,80A	4,00	3,90	
P <sub>design</sub> at -10°C	kW		3,60	4,00	6,00	5,20	8,00	9,50	10,60	
Input power heating	kW		0,84	1,34	1,74	2,08	2,60	3,48	4,44	
Annual energy consumption <sup>3)</sup>	kWh/a		—	—	—	—	—	—	—	
Indoor unit			S-36PF1E5B	S-50PF1E5B	S-60PF1E5B	S-71PF1E5B	S-100PF1E5B	S-125PF1E5B	S-140PF1E5B	
External static pressure <sup>5)</sup>	Nominal (Min - Max)	Pa	70(10 - 150)	70(10 - 150)	70(10 - 150)	70(10 - 150)	100(10 - 150)	100(10 - 150)	100(10 - 150)	
Air volume	Hi / Med / Lo	m <sup>3</sup> /min	14,0/13,0/10,0	16,0/15,0/12,0	21,0/19,0/15,0	21,0/19,0/15,0	32,0/26,0/21,0	34,0/29,0/23,0	36,0/32,0/25,0	
Sound pressure <sup>5)</sup>	Hi / Med / Lo	dB(A)	33/29/25	34/30/26	35/32/26	35/32/26	38/34/31	39/35/32	40/36/33	
Dimension	H x W x D	mm	290 x 800 x 700	290 x 800 x 700	290 x 1000 x 700	290 x 1000 x 700	290 x 1400 x 700	290 x 1400 x 700	290 x 1400 x 700	
Net weight	Indoor / Panel	kg	28	28	33	33	45	45	45	
Outdoor unit			U-36PZH2E5	U-50PZH2E5	U-60PZH2E5	U-71PZH2E5	U-100PZH2E5	U-125PZH2E5	U-140PZH2E5	
Power source		V	220/230/240	220/230/240	220/230/240	220/230/240	220/230/240	220/230/240	220/230/240	
Recommended fuse		A	—	—	—	—	—	—	—	
Current	Cool	A	—	—	—	—	—	—	—	
	Heat	A	—	—	—	—	—	—	—	
Air volume	Cool / Heat	m <sup>3</sup> /min	—	—	—	—	—	—	—	
Sound pressure	Cool / Heat (Hi)	dB(A)	45/46	46/48	46/49	48/50	52/52	53/53	54/55	
Sound power	Cool / Heat (Hi)	dB	64/66	65/68	65/69	65/67	69/69	70/70	71/71	
Dimension	H x W x D	mm	695 x 875 x 320	695 x 875 x 320	695 x 875 x 320	996 x 940 x 340	1416 x 940 x 340	1416 x 940 x 340	1416 x 940 x 340	
Net weight		kg	49	49	49	68	101	101	101	
Piping connections	Liquid pipe	Inch (mm)	1/4(6,35)	1/4(6,35)	3/8(9,52)	3/8(9,52)	3/8(9,52)	3/8(9,52)	3/8(9,52)	
	Gas pipe	Inch (mm)	1/2(12,70)	1/2(12,70)	5/8(15,88)	5/8(15,88)	5/8(15,88)	5/8(15,88)	5/8(15,88)	
Pipe length range		m	3-40	3-40	3-40	5-50	5-75	5-75	5-75	
Elevation difference [in/out] <sup>6)</sup>		m	30	30	30	30	30	30	30	
Pipe length for additional gas		m	30	30	30	30	30	30	30	
Additional gas amount		g/m	—	—	—	—	—	—	—	
Refrigerant (R32)		kg/TCO <sub>2</sub> Eq.	—	—	—	—	—	—	—	
Operating range	Cool Min ~ Max	°C	-15 ~ +46	-15 ~ +46	-15 ~ +46	-15 ~ +46	-15 ~ +46	-15 ~ +46	-15 ~ +46	
	Heat Min ~ Max	°C	-20 ~ +24	-20 ~ +24	-20 ~ +24	-20 ~ +24	-20 ~ +24	-20 ~ +24	-20 ~ +24	

Accessories	
CZ-RTC5B	Wired remote controller with Econavi button and datanavi
CZ-RW53 + CZ-RWRC3	Wireless remote controller
CZ-RE2C2	Simplified remote controller
PAW-WTRAY	Tray for condenser water compatible with base ground support
PAW-GRDBSE20	Outdoor base ground support for noise and vibration absorption

Accessories	
PAW-GRDSTD40	Outdoor elevation platform 400 x 900 x 400mm
CZ-56DAF2	Air Outlet Plenum S...PF1E5B 36, 45 & 50
CZ-90DAF2	Air Outlet Plenum S...PF1E5B 60 & 71
CZ-160DAF2	Air Outlet Plenum S...PF1E5B 100, 125 & 140
CZ-DUMPA90MF2	Air Inlet Plenum S...PF1E5B 60 & 71
CZ-DUMPA160MF2	Air Inlet Plenum S...PF1E5B 100, 125 & 140





Controller. Wired remote controller CZ-RTCSB Compatible with Econavi  
 Optional Controller. Wireless remote controller CZ-RWS3 + CZ-RWRC3  
 Optional Controller. Simplified remote controller CZ-REZC2  
 Optional Econavi Sensor. CZ-CENSC1

Air Outlet Plenum (without regulation adaptor)		
	Diameters	Model
36, 45 & 50	2xØ 200	CZ-56DAF2
60 & 71	3xØ 200	CZ-90DAF2
100, 125 & 140	4xØ 200	CZ-160DAF2

Air Inlet Plenum		
	Diameters	Model
60 & 71	2xØ 250	CZ-DUMPA90MF2
100, 125 & 140	4xØ 200	CZ-DUMPA160MF2

Standardized height of 290mm for all models. Height standardization enables easy and uniform installation for models with different capacities.

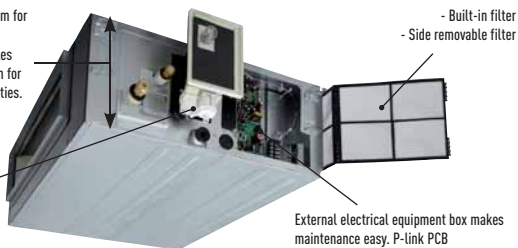

Built-in Drain pump (DC motor pump)

External electrical equipment box makes maintenance easy. P-link PCB

Tentative data

			Three Phase			
			7,10kW	10,00kW	12,50kW	14,00kW
			KIT-71PF1ZH8	KIT-100PF1ZH8	KIT-125PF1ZH8	KIT-140PF1ZH8
			CZ-RTCS5B	CZ-RTCS5B	CZ-RTCS5B	CZ-RTCS5B
Remote controller						
Cooling capacity	kW		7,10	10,00	12,50	14,00
EER <sup>1)</sup>	W/W		3,92	4,18	3,56	3,32
SEER <sup>2)</sup>	W/W		<b>6,10A++</b>	<b>5,80A+</b>	<b>5,90</b>	<b>5,80</b>
Pdesign	kW		7,10	10,00	12,50	14,00
Input power cooling	kW		1,81	2,39	3,51	4,22
Annual energy consumption <sup>3)</sup>	kWh/a		—	—	—	—
Heating capacity	kW		8,00	11,20	14,00	16,00
Heating capacity at -7°C / -15°C <sup>4)</sup>	kW		—	—	—	—
COP <sup>1)</sup>	W/W		3,85	4,31	3,48	3,60
SCOP <sup>2)</sup>	W/W		<b>4,10A+</b>	<b>3,80A</b>	<b>4,00</b>	<b>3,90</b>
Pdesign at -10°C	kW		5,20	8,00	9,50	10,60
Input power heating	kW		2,08	2,60	4,02	4,44
Annual energy consumption <sup>3)</sup>	kWh/a		—	—	—	—
Indoor unit			<b>S-71PF1E5B</b>	<b>S-100PF1E5B</b>	<b>S-125PF1E5B</b>	<b>S-140PF1E5B</b>
External static pressure <sup>5)</sup>	Nominal (Min - Max)	Pa	70 (10 - 150)	100 (10 - 150)	100 (10 - 150)	100 (10 - 150)
Air volume	Hi / Med / Lo	m <sup>3</sup> /min	21,0/19,0/15,0	32,0/26,0/21,0	34,0/29,0/23,0	36,0/32,0/25,0
Sound pressure <sup>5)</sup>	Hi / Med / Lo	dB(A)	35/32/26	38/34/31	39/35/32	40/36/33
Dimension	HxWxD	mm	290 x 1000 x 700	290 x 1400 x 700	290 x 1400 x 700	290 x 1400 x 700
Net weight	Indoor / Panel	kg	33	45	45	45
Outdoor unit			<b>U-71PZH2E8</b>	<b>U-100PZH2E8</b>	<b>U-125PZH2E8</b>	<b>U-140PZH2E8</b>
Power source		V	380/400/415	380/400/415	380/400/415	380/400/415
Recommended fuse		A	—	—	—	—
Current	Cool	A	—	—	—	—
	Heat	A	—	—	—	—
Air volume	Cool / Heat	m <sup>3</sup> /min	—	—	—	—
Sound pressure	Cool / Heat (Hi)	dB(A)	48/50	52/52	53/53	54/55
Sound power	Cool / Heat (Hi)	dB	65/67	69/69	70/70	71/71
Dimension	HxWxD	mm	996 x 940 x 340	1416 x 940 x 340	1416 x 940 x 340	1416 x 940 x 340
Net weight		kg	68	101	101	101
Piping connections	Liquid pipe	Inch (mm)	3/8 (9,52)	3/8 (9,52)	3/8 (9,52)	3/8 (9,52)
	Gas pipe	Inch (mm)	5/8 (15,88)	5/8 (15,88)	5/8 (15,88)	5/8 (15,88)
Pipe length range		m	5 - 50	5 - 75	5 - 75	5 - 75
Elevation difference (in/out) <sup>6)</sup>		m	30	30	30	30
Pipe length for additional gas		m	30	30	30	30
Additional gas amount		g/m	—	—	—	—
Refrigerant (R32)		kg/TCO <sub>2</sub> Eq.	—	—	—	—
Operating range	Cool Min ~ Max	°C	-15 ~ +46	-15 ~ +46	-15 ~ +46	-15 ~ +46
	Heat Min ~ Max	°C	-20 ~ +24	-20 ~ +24	-20 ~ +24	-20 ~ +24

1) EER and COP calculation is based in accordance to EN14511. 2) For models below 12kW, the SEER and SCOP is calculated based on values of EU/626/2011. For models above 12kW, the SEER and SCOP is calculated based on values of EU/2281/2016. 3) The annual energy consumption is calculated in accordance to EU/626/2011. 4) Heating capacity is calculated including defrost factor correction. At -10°C only for 10,00kW. 5) Medium External static pressure setting from factory. 6) The sound pressure of the units shows the value measured of a position 1m in front of the main body and 1,5m from the ground. The sound pressure is measured in accordance with Eurovent 6/C/006-97 specification. 7) When installing the outdoor unit at a higher position than the indoor unit.\* Recommended fuse for the indoor 3A.



SEER and SCOP: For KIT-71PF1ZH5. INTERNET CONTROL: Optional. Compatible with all Panasonic connectivity solutions. For detailed information go to the Control Systems section.

Rating Conditions: Cooling Indoor 27°C DB / 19°C WB. Cooling Outdoor 35°C DB / 24°C WB. Heating Indoor 20°C DB. Heating Outdoor 7°C DB / 6°C WB. (DB: Dry Bulb; WB: Wet Bulb) Specifications subject to change without notice. For detailed information about ErP, please visit our websites www.aircon.panasonic.eu or www.gtc.panasonic.eu.



The static pressure outside the unit can be increased up to 150 Pa

Type		36	45	50	60	71	100	125	140
Standard	Pa	70	70	70	70	70	100	100	100
Maximum available setting	Pa	150	150	150	150	150	150	150	150

More powerful drain pump

Using a high-lift drain pump, drain piping can be elevated up to 785mm from the base of the unit.

## NEW PACi STANDARD HIGH STATIC PRESSURE HIDE AWAY INVERTER+ • R32 GAS



The ducted systems are the ideal solution for flexible, concealed air conditioning and the optional 200mm spigots ensure simple, hassle-free connection to spiral ductwork.

### Technical focus

- High ESP (external static pressure) up to 150 Pa
- Automatic learning function for the required static pressure on site during commissioning (a standard wired remote controller is required)
- DC FAN for better efficiency and control
- Built in drain pump
- Datanavi simple support tool app with remote controller (CZ-RTC5B)
- Twin split options
- Easy connection and control of external fan or ERV using the connector PAW-FDC on the indoor unit PCB. The external device can be controlled by the remote control of the Panasonic indoor unit

Tentative data			Single Phase				
			6,00kW	7,10kW	10,00kW	12,50kW	14,00kW
KIT			KIT-60PF1Z5	KIT-71PF1Z5	KIT-100PF1Z5	KIT-125PF1Z5	KIT-140PF1Z5
Remote controller			CZ-RTC5B	CZ-RTC5B	CZ-RTC5B	CZ-RTC5B	CZ-RTC5B
Cooling capacity	Nominal (Min - Max)	kW	6,00	7,10	10,00 (3,00 - 11,50)	12,50 (3,20 - 13,50)	14,00 (3,30 - 15,00)
EER <sup>1)</sup>	Nominal (Min - Max)	W/W	3,49	2,87	3,66 (5,36 - 2,81)	3,52 (5,33 - 2,80)	3,18 (5,32 - 2,70)
SEER <sup>2)</sup>		W/W	5,50A	5,40A	5,60A+	5,56	5,38
P <sub>design</sub>		kW	6,00	7,10	10,00	12,50	14,00
Input power cooling	Nominal (Min - Max)	kW	1,72	2,47	2,73 (0,56 - 4,09)	3,55 (0,60 - 4,82)	4,40 (0,62 - 5,56)
Annual energy consumption <sup>3)</sup>		kWh/a	—	—	625	787	911
Heating capacity	Nominal (Min - Max)	kW	6,00	7,10	10,00 (3,00 - 14,00)	12,50 (3,30 - 15,00)	14,00 (3,40 - 16,00)
Heating capacity at -7°C / -15°C <sup>4)</sup>		kW	—	—	— / —	11,00 / —	12,00 / —
COP <sup>1)</sup>	Nominal (Min - Max)	W/W	4,55	4,13	4,31 (5,36 - 3,51)	4,02 (5,50 - 3,45)	3,79 (5,48 - 3,13)
SCOP <sup>2)</sup>		W/W	4,20A+	4,20A+	3,80A	3,61	3,54
P <sub>design</sub> at -10°C		kW	6,00	6,00	10,00	12,50	13,60
Input power heating	Nominal (Min - Max)	kW	1,32	1,72	2,32 (0,56 - 3,99)	3,11 (0,60 - 4,35)	3,69 (0,62 - 5,12)
Annual energy consumption <sup>3)</sup>		kWh/a	—	—	3684	4848	5379
<b>Indoor unit</b>			<b>S-60PF1E5B</b>	<b>S-71PF1E5B</b>	<b>S-100PF1E5B</b>	<b>S-125PF1E5B</b>	<b>S-140PF1E5B</b>
External static pressure <sup>5)</sup>	Nominal (Min - Max)	Pa	70 (10 - 150)	70 (10 - 150)	100 (10 - 150)	100 (10 - 150)	100 (10 - 150)
Air volume	Hi / Med / Lo	m <sup>3</sup> /min	21,0/19,0/15,0	21,0/19,0/15,0	32/26/21	34/29/23	36/32/25
Moisture removal volume		L/h	3,4	4,2	6,0	7,9	9,0
Sound pressure <sup>6)</sup>	Hi / Med / Lo	dB(A)	35/32/26	35/32/26	38/34/31	39/35/32	40/36/33
Sound power	Hi / Med / Lo	dB	57/54/48	57/54/48	60/56/53	61/57/54	62/58/55
Dimension	HxWxD	mm	290 x 1000 x 700	290 x 1000 x 700	290 x 1400 x 700	290 x 1400 x 700	290 x 1400 x 700
Net weight		kg	33	33	45	45	45
<b>Outdoor unit</b>			<b>U-60PZ2E5</b>	<b>U-71PZ2E5</b>	<b>U-100PZ2E5</b>	<b>U-125PZ2E5</b>	<b>U-140PZ2E5</b>
Power source		V	220/230/240	220/230/240	220/230/240	220/230/240	220/230/240
Current	Cool	A	—	—	12,10/11,60/11,10	16,10/15,50/14,80	20,20/19,30/18,60
	Heat	A	—	—	10,10/9,70/9,30	14,00/13,40/12,90	16,80/16,00/15,30
Air volume	Cool / Heat	m <sup>3</sup> /min	—	—	76/70	86/78	89/83
Sound pressure	Cool / Heat (Hi)	dB(A)	46/48	49/49	52/52	55/55	56/56
Sound power	Cool / Heat (Hi)	dB	65/68	69/69	70/70	73/73	74/74
Dimension	HxWxD	mm	695 x 875 x 320	695 x 875 x 320	996 x 980 x 370	996 x 980 x 370	996 x 980 x 370
Net weight		kg	49	49	90	94	94
Piping connections	Liquid pipe	Inch (mm)	3/8 (9,52)	3/8 (9,52)	3/8 (9,52)	3/8 (9,52)	3/8 (9,52)
	Gas pipe	Inch (mm)	5/8 (15,88)	5/8 (15,88)	5/8 (15,88)	5/8 (15,88)	5/8 (15,88)
Pipe length range		m	3 ~ 40	3 ~ 40	5 ~ 50	5 ~ 50	5 ~ 50
Elevation difference (in/out) <sup>7)</sup>		m	30	30	30	30	30
Pipe length for additional gas		m	30	30	30	30	30
Additional gas amount		g/m	—	—	45	45	45
Refrigerant (R32)		kg/TCO <sub>2</sub> Eq.	—	—	2,60/1,755	2,98/2,0115	2,98/2,0115
Operating range	Cool Min ~ Max	°C	-10 ~ +43	-10 ~ +43	-10 ~ +43	-10 ~ +43	-10 ~ +43
	Heat Min ~ Max	°C	-15 ~ +24	-15 ~ +24	-15 ~ +24	-15 ~ +24	-15 ~ +24

### Accessories

<b>CZ-RTC5B</b>	Wired remote controller with Econavi button and datanavi
<b>CZ-RWS3 + CZ-RWRC3</b>	Wireless remote controller
<b>CZ-RE2C2</b>	Simplified remote controller
<b>PAW-WTRAY</b>	Tray for condenser water compatible with base ground support
<b>PAW-GRDBSE20</b>	Outdoor base ground support for noise and vibration absorption

### Accessories

<b>PAW-GRDSTD40</b>	Outdoor elevation platform 400 x 900 x 400mm
<b>CZ-90DAF2</b>	Air Outlet Plenum S . .PF1E5B 60 & 71
<b>CZ-160DAF2</b>	Air Outlet Plenum S . .PF1E5B 100, 125 & 140
<b>CZ-DUMPA90MF2</b>	Air Inlet Plenum S . .PF1E5B 60 & 71
<b>CZ-DUMPA160MF2</b>	Air Inlet Plenum S . .PF1E5B 100, 125 & 140

PACi Kits

R32



**Air Outlet Plenum (without regulation adaptor)**

Diameters	Model
60 & 71	3xØ 200 CZ-90DAF2
100, 125 & 140	4xØ 200 CZ-160DAF2

**Air Inlet Plenum**

Diameters	Model
60 & 71	2xØ 250 CZ-DUMPA90MF2
100, 125 & 140	4xØ 200 CZ-DUMPA160MF2

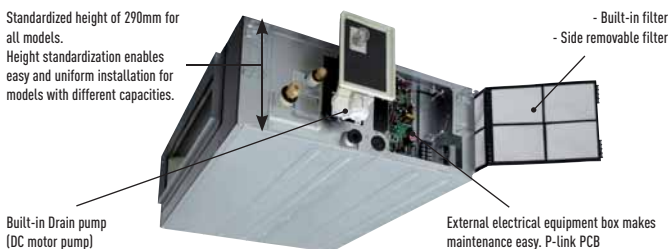

The static pressure outside the unit can be increased up to 150 Pa

Type		60	71	100	125	140
Standard	Pa	70	70	100	100	100
Maximum available setting	Pa	150	150	150	150	150

More powerful drain pump

Using a high-lift drain pump, drain piping can be elevated up to 785mm from the base of the unit.

Tentative data			Three Phase			
			10,00kW	12,50kW	14,00kW	
KIT			KIT-100PF1Z8	KIT-125PF1Z8	KIT-140PF1Z8	
Remote controller			CZ-RTCSB	CZ-RTCSB	CZ-RTCSB	
Cooling capacity	Nominal (Min - Max)	kW	10,00 (3,00 - 11,50)	12,50 (3,20 - 13,50)	14,00 (3,30 - 15,00)	
EER <sup>1)</sup>	Nominal (Min - Max)	W/W	3,66 (5,36 - 2,81)	3,52 (5,33 - 2,80)	3,18 (5,32 - 2,70)	
<b>SEER <sup>2)</sup></b>		<b>W/W</b>	<b>5,60 A+</b>	<b>5,54</b>	<b>5,37</b>	
Pdesign		kW	10,00	12,50	14,00	
Input power cooling	Nominal (Min - Max)	kW	2,73 (0,56 - 4,09)	3,55 (0,60 - 4,82)	4,40 (0,62 - 5,56)	
Annual energy consumption <sup>3)</sup>		kWh/a	625	790	912	
Heating capacity	Nominal (Min - Max)	kW	10,00 (3,00 - 14,00)	12,50 (3,30 - 15,00)	14,00 (3,40 - 16,00)	
Heating capacity at -7°C / -15°C <sup>4)</sup>		kW	— / —	11,00 / —	12,00 / —	
COP <sup>1)</sup>	Nominal (Min - Max)	W/W	4,31 (5,36 - 3,51)	4,02 (5,50 - 3,45)	3,79 (5,48 - 3,13)	
<b>SCOP <sup>2)</sup></b>		<b>W/W</b>	<b>3,80 A</b>	<b>3,61</b>	<b>3,54</b>	
Pdesign at -10°C		kW	10,00	12,50	13,60	
Input power heating	Nominal (Min - Max)	kW	2,32 (0,56 - 3,99)	3,11 (0,60 - 4,35)	3,69 (0,62 - 5,12)	
Annual energy consumption <sup>3)</sup>		kWh/a	3684	4848	5379	
Indoor unit			S-100PF1E5B	S-125PF1E5B	S-140PF1E5B	
External static pressure <sup>5)</sup>	Nominal (Min - Max)	Pa	100 (10 - 150)	100 (10 - 150)	100 (10 - 150)	
Air volume	Hi / Med / Lo	m <sup>3</sup> /min	32/26/21	34/29/23	36/32/25	
Moisture removal volume		L/h	6,0	7,9	9,0	
Sound pressure <sup>6)</sup>	Hi / Med / Lo	dB(A)	38/34/31	39/35/32	40/36/33	
Sound power	Hi / Med / Lo	dB	60/56/53	61/57/54	62/58/55	
Dimension	H x W x D	mm	290 x 1400 x 700	290 x 1400 x 700	290 x 1400 x 700	
Net weight		kg	45	45	45	
Outdoor unit			U-100PZ2E8	U-125PZ2E8	U-140PZ2E8	
Power source		V	380/400/415	380/400/415	380/400/415	
Current	Cool	A	4,15/3,95/3,80	5,40/5,10/4,95	6,75/6,40/6,15	
	Heat	A	3,45/3,30/3,20	4,70/4,45/4,30	5,60/5,30/5,15	
Air volume	Cool / Heat	m <sup>3</sup> /min	76/70	86/78	89/83	
Sound pressure	Cool / Heat (Hi)	dB(A)	52/52	55/55	56/56	
Sound power	Cool / Heat (Hi)	dB	70/70	73/73	74/74	
Dimension	H x W x D	mm	996 x 980 x 370	996 x 980 x 370	996 x 980 x 370	
Net weight		kg	90	94	94	
Piping connections	Liquid pipe	Inch (mm)	3/8 (9,52)	3/8 (9,52)	3/8 (9,52)	
	Gas pipe	Inch (mm)	5/8 (15,88)	5/8 (15,88)	5/8 (15,88)	
Pipe length range		m	5 - 50	5 - 50	5 - 50	
Elevation difference (in/out) <sup>7)</sup>		m	30	30	30	
Pipe length for additional gas		m	30	30	30	
Additional gas amount		g/m	45	45	45	
Refrigerant (R32)		kg / TCO: Eq.	2,60 / 1,755	2,98 / 2,0115	2,98 / 2,0115	
Operating range	Cool Min ~ Max	°C	-10 ~ +43	-10 ~ +43	-10 ~ +43	
	Heat Min ~ Max	°C	-15 ~ +24	-15 ~ +24	-15 ~ +24	

1) EER and COP calculation is based in accordance to EN14511. 2) For models below 12kW, the SEER and SCOP is calculated based on values of EU/626/2011. For models above 12kW, the SEER and SCOP is calculated based on values of EU/2281/2016. 3) The annual energy consumption is calculated in accordance to EU/626/2011. 4) Heating capacity is calculated including defrost factor correction. At -10°C only for 10,00kW. 5) Medium External static pressure setting from factory. 6) The sound pressure of the units shows the value measured of a position 1m in front of the main body and 1,5m from the ground. The sound pressure is measured in accordance with Eurovent 6/C/006-97 specification. 7) When installing the outdoor unit at a higher position than the indoor unit. \* Recommended fuse for the indoor 3A.



SEER: For KIT-100PF1Z5 and KIT-100PF1Z8. SCOP: For KIT-60PF1Z5 and KIT-71PF1Z5. INTERNET CONTROL: Optional. Compatible with all Panasonic connectivity solutions. For detailed information go to the Control Systems section.

Rating Conditions: Cooling Indoor 27°C DB / 19°C WB. Cooling Outdoor 35°C DB / 24°C WB. Heating Indoor 20°C DB. Heating Outdoor 7°C DB / 6°C WB. (DB: Dry Bulb; WB: Wet Bulb) Specifications subject to change without notice. For detailed information about ErP, please visit our websites www.aircon.panasonic.eu or www.ptc.panasonic.eu.

# PACi ELITE LOW STATIC PRESSURE HIDE AWAY INVERTER+ • R32 GAS

NEW  
18



The depth of only 250mm provides greater installation flexibility and the unit can be used in more applications. Ideal for sites with narrow ceiling voids.

Ultra-slim profile: 250mm height for all models.

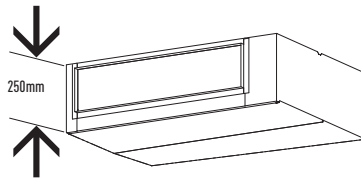

### Technical focus

- Automatic learning function for the required static pressure on site during commissioning (a standard wired remote controller is required. S-60/71/100/125/140PN1E5B models only)
- Compact indoor units without losing static pressure (only 250mm high)
- 50 Pa static pressure
- Easy maintenance and service via external electrical box
- 3 speed centrifugal fan through wired or wireless remote control
- DC FAN for better efficiency and control
- Easy connection and control of external fan or ERV using the connector PAW-FDC on the indoor unit PCB. The external device can be controlled by the remote control of the Panasonic indoor unit

Tentative data		Single Phase						
KIT		3,60kW	5,00kW	6,00kW	7,10kW	10,00kW	12,50kW	14,00kW
Remote controller		KIT-36PN1ZH5 CZ-RTC5B	KIT-50PN1ZH5 CZ-RTC5B	KIT-60PN1ZH5 CZ-RTC5B	KIT-71PN1ZH5 CZ-RTC5B	KIT-100PN1ZH5 CZ-RTC5B	KIT-125PN1ZH5 CZ-RTC5B	KIT-140PN1ZH5 CZ-RTC5B
Cooling capacity	kW	3,60	5,00	6,00	7,10	10,00	12,50	14,00
EER <sup>1)</sup>	W/W	3,85	3,35	3,40	3,40	3,95	3,35	3,15
SEER <sup>2)</sup>	W/W	<b>4,70 B</b>	<b>4,90 B</b>	<b>5,60 A</b>	<b>5,60 A</b>	<b>6,00 A+</b>	<b>5,90</b>	<b>5,80</b>
Pdesign	kW	3,60	5,00	6,00	7,10	10,00	12,50	14,00
Input power cooling	kW	0,94	1,49	1,76	2,09	2,53	3,73	4,44
Annual energy consumption <sup>3)</sup>	kWh/a	—	—	—	—	—	—	—
Heating capacity	kW	4,00	5,60	7,00	8,00	11,20	14,00	16,00
Heating capacity at -7°C / -15°C <sup>4)</sup>	kW	—	—	—	—	—	—	—
COP <sup>1)</sup>	W/W	4,40	3,35	3,75	3,68	3,90	3,70	3,50
SCOP <sup>2)</sup>	W/W	<b>4,00 A+</b>	<b>4,00 A+</b>	<b>4,00 A+</b>	<b>4,00 A+</b>	<b>4,00 A+</b>	<b>3,90</b>	<b>3,80</b>
Pdesign at -10°C	kW	3,60	3,80	5,60	5,20	8,00	9,50	10,60
Input power heating	kW	0,91	1,67	1,87	2,17	2,87	3,78	4,57
Annual energy consumption <sup>3)</sup>	kWh/a	—	—	—	—	—	—	—
Indoor unit		S-36PN1E5B	S-50PN1E5B	S-60PN1E5B	S-71PN1E5B	S-100PN1E5B	S-125PN1E5B	S-140PN1E5B
External static pressure <sup>5)</sup> Nominal (Min - Max)	Pa	25(10-80)	25(10-80)	25(10-80)	25(10-80)	40(10-80)	50(10-80)	50(10-80)
Air volume	Hi / Med / Lo	m <sup>3</sup> /min	—	—	—	—	—	—
Sound pressure <sup>5)</sup>	Hi / Med / Lo	dB(A)	35/33/30	36/34/30	38/36/31	38/36/31	39/37/32	40/38/33
Dimension	H x W x D	mm	250 x 780 x 650	250 x 780 x 650	250 x 1000 x 650	250 x 1000 x 650	250 x 1200 x 650	250 x 1200 x 650
Net weight	Indoor / Panel	kg	29	29	32	32	41	41
Outdoor unit		U-36PZH2E5	U-50PZH2E5	U-60PZH2E5	U-71PZH2E5	U-100PZH2E5	U-125PZH2E5	U-140PZH2E5
Power source	V	220/230/240	220/230/240	220/230/240	220/230/240	220/230/240	220/230/240	220/230/240
Recommended fuse	A	—	—	—	—	—	—	—
Current	Cool	A	—	—	—	—	—	—
	Heat	A	—	—	—	—	—	—
Air volume	Cool / Heat	m <sup>3</sup> /min	—	—	—	—	—	—
Sound pressure	Cool / Heat (Hi)	dB(A)	45/46	46/48	46/49	48/50	52/52	53/53
Sound power	Cool / Heat (Hi)	dB	64/66	65/68	65/69	65/67	69/69	70/70
Dimension	H x W x D	mm	695 x 875 x 320	695 x 875 x 320	695 x 875 x 320	996 x 940 x 340	1416 x 940 x 340	1416 x 940 x 340
Net weight		kg	49	49	49	68	101	101
Piping connections	Liquid pipe	Inch (mm)	1/4(6,35)	1/4(6,35)	3/8(9,52)	3/8(9,52)	3/8(9,52)	3/8(9,52)
	Gas pipe	Inch (mm)	1/2(12,70)	1/2(12,70)	5/8(15,88)	5/8(15,88)	5/8(15,88)	5/8(15,88)
Pipe length range		m	3-40	3-40	3-40	5-50	5-75	5-75
Elevation difference [in/out] <sup>6)</sup>		m	30	30	30	30	30	30
Pipe length for additional gas		m	30	30	30	30	30	30
Additional gas amount		g/m	—	—	—	—	—	—
Refrigerant (R32)		kg/TCO <sub>2</sub> Eq.	—	—	—	—	—	—
Operating range	Cool Min ~ Max	°C	-15 ~ +46	-15 ~ +46	-15 ~ +46	-15 ~ +46	-15 ~ +46	-15 ~ +46
	Heat Min ~ Max	°C	-20 ~ +24	-20 ~ +24	-20 ~ +24	-20 ~ +24	-20 ~ +24	-20 ~ +24

Accessories	
<b>CZ-RTC5B</b>	Wired remote controller with Econavi button and datanavi
<b>CZ-RWS3 + CZ-RWRC3</b>	Wireless remote controller
<b>CZ-RE2C2</b>	Simplified remote controller
<b>PAW-WTRAY</b>	Tray for condenser water compatible with base ground support

Accessories	
<b>PAW-GRDBSE20</b>	Outdoor base ground support for noise and vibration absorption
<b>PAW-GRDSTD40</b>	Outdoor elevation platform 400 x 900 x 400mm
<b>PAW-WPH7</b>	Wind protection shield for U-100/125/140PZH2E5/8
<b>PAW-WPH9</b>	Wind protection shield for U-71PZH2E5/8



Controller. Wired remote controller CZ-RTCSB Compatible with Econavi  
 Optional Controller. Wireless remote controller CZ-RWS3 + CZ-RWRC3  
 Optional Controller. Simplified remote controller CZ-REZC2  
 Optional Econavi Sensor. CZ-CENSC1

### System Example

An inspection port (450mmx450mm or more) is required at the control-box side of the indoor unit body.

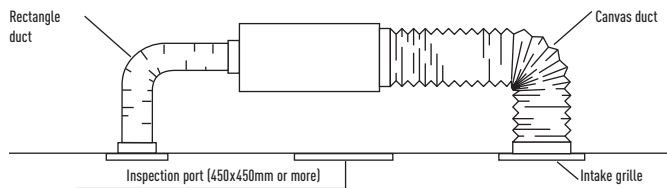

#### Tentative data

			Three Phase			
			7,10kW	10,00kW	12,50kW	14,00kW
			KIT-71PN1ZH8	KIT-100PN1ZH8	KIT-125PN1ZH8	KIT-140PN1ZH8
			CZ-RTCS5B	CZ-RTCS5B	CZ-RTCS5B	CZ-RTCS5B
Remote controller						
Cooling capacity	kW		7,10	10,00	12,50	14,00
EER <sup>1)</sup>	W/W		3,40	3,95	3,35	3,15
SEER <sup>2)</sup>	W/W		<b>5,40 A+</b>	<b>5,80 A+</b>	<b>5,80</b>	<b>5,70</b>
Pdesign	kW		7,10	10,00	12,50	14,00
Input power cooling	kW		2,09	2,53	3,73	4,44
Annual energy consumption <sup>3)</sup>	kWh/a		—	—	—	—
Heating capacity	kW		8,00	11,20	14,00	16,00
Heating capacity at -7°C / -15°C <sup>4)</sup>	kW		—	—	—	—
COP <sup>1)</sup>	W/W		3,68	3,90	3,70	3,50
SCOP <sup>2)</sup>	W/W		<b>4,00 A+</b>	<b>4,00 A+</b>	<b>3,90</b>	<b>3,80</b>
Pdesign at -10°C	kW		5,20	8,00	9,50	10,60
Input power heating	kW		2,17	2,87	3,78	4,57
Annual energy consumption <sup>3)</sup>	kWh/a		—	—	—	—
Indoor unit			<b>S-71PN1E5B</b>	<b>S-100PN1E5B</b>	<b>S-125PN1E5B</b>	<b>S-140PN1E5B</b>
External static pressure <sup>5)</sup>	Nominal (Min - Max)	Pa	25(10 - 80)	40(10 - 80)	50(10 - 80)	50(10 - 80)
Air volume	Hi / Med / Lo	m <sup>3</sup> /min	—	—	—	—
Sound pressure <sup>5)</sup>	Hi / Med / Lo	dB(A)	38/36/31	39/37/32	40/38/33	41/39/34
Dimension	HxWxD	mm	250 x 1000 x 650	250 x 1200 x 650	250 x 1200 x 650	250 x 1200 x 650
Net weight	Indoor / Panel	kg	32	41	41	41
Outdoor unit			<b>U-71PZH2E8</b>	<b>U-100PZH2E8</b>	<b>U-125PZH2E8</b>	<b>U-140PZH2E8</b>
Power source		V	380/400/415	380/400/415	380/400/415	380/400/415
Recommended fuse		A	—	—	—	—
Current	Cool	A	—	—	—	—
	Heat	A	—	—	—	—
Air volume	Cool / Heat	m <sup>3</sup> /min	—	—	—	—
Sound pressure	Cool / Heat (Hi)	dB(A)	48/50	52/52	53/53	54/55
Sound power	Cool / Heat (Hi)	dB	65/67	69/69	70/70	71/71
Dimension	HxWxD	mm	996 x 940 x 340	1416 x 940 x 340	1416 x 940 x 340	1416 x 940 x 340
Net weight		kg	68	101	101	101
Piping connections	Liquid pipe	Inch (mm)	3/8(9,52)	3/8(9,52)	3/8(9,52)	3/8(9,52)
	Gas pipe	Inch (mm)	5/8(15,88)	5/8(15,88)	5/8(15,88)	5/8(15,88)
Pipe length range		m	5 - 50	5 - 75	5 - 75	5 - 75
Elevation difference (in/out) <sup>6)</sup>		m	30	30	30	30
Pipe length for additional gas		m	30	30	30	30
Additional gas amount		g/m	—	—	—	—
Refrigerant (R32)		kg/TCO: Eq.	—	—	—	—
Operating range	Cool Min ~ Max	°C	-15 ~ +46	-15 ~ +46	-15 ~ +46	-15 ~ +46
	Heat Min ~ Max	°C	-20 ~ +24	-20 ~ +24	-20 ~ +24	-20 ~ +24

1) EER and COP calculation is based in accordance to EN14511. 2) For models below 12kW, the SEER and SCOP is calculated based on values of EU/626/2011. For models above 12kW, the SEER and SCOP is calculated based on values of EU/2281/2016. 3) The annual energy consumption is calculated in accordance to EU/626/2011. 4) Heating capacity is calculated including defrost factor correction. 5) Medium external static pressure setting from factory. 6) The sound pressure of the units shows the value measured of a position 1m in front of the main body and 1,5m from the ground. The sound pressure is measured in accordance with Eurovent 6/C/006-97 specification. 7) Add 100mm for piping part. 8) When installing the outdoor unit at a higher position than the indoor unit.\* Recommended fuse for the indoor 3A.



SEER and SCOP: KIT-100PN1ZH5. INTERNET CONTROL: Optional.  
 Compatible with all Panasonic connectivity solutions. For detailed information go to the Control Systems section.

Rating Conditions: Cooling Indoor 27°C DB / 19°C WB. Cooling Outdoor 35°C DB / 24°C WB. Heating Indoor 20°C DB. Heating Outdoor 7°C DB / 6°C WB. (DB: Dry Bulb; WB: Wet Bulb)  
 Specifications subject to change without notice. For detailed information about ErP, please visit our websites www.aircon.panasonic.eu or www.ptc.panasonic.eu.



### Cold Drafts Reduction at Heating

Accurate DX Coil temperature measurement by E1 and E2 sensor to reduce cold drafts at heating and increasing efficiency and comfort.

Before spec-in, please consult with an authorized Panasonic dealer.

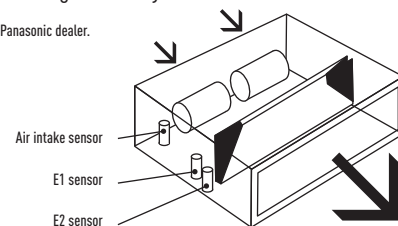

# PACi STANDARD LOW STATIC PRESSURE HIDE AWAY INVERTER+ • R32 GAS

NEW  
18



The depth of only 250mm provides greater installation flexibility and the unit can be used in more applications. Ideal for sites with narrow ceiling voids.

Ultra-slim profile: 250mm height for all models.

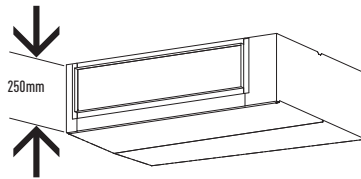

### Technical focus

- Automatic learning function for the required static pressure on site during commissioning (a standard wired remote controller is required. S-60/71/100/125/140PN1E5B models only)
- Compact indoor units without losing static pressure (only 250mm high)
- 50 Pa static pressure
- Easy maintenance and service via external electrical box
- 3 speed centrifugal fan through wired or wireless remote control
- DC FAN for better efficiency and control
- Easy connection and control of external fan or ERV using the connector PAW-FDC on the indoor unit PCB. The external device can be controlled by the remote control of the Panasonic indoor unit

Tentative data			Single Phase				
			6,00kW	7,10kW	10,00kW	12,50kW	14,00kW
KIT			KIT-60PN1Z5	KIT-71PN1Z5	KIT-100PN1Z5	KIT-125PN1Z5	KIT-140PN1Z5
Remote controller			CZ-RTC5B	CZ-RTC5B	CZ-RTC5B	CZ-RTC5B	CZ-RTC5B
Cooling capacity	kW		6,00	7,10	10,00	12,50	14,00
EER <sup>1)</sup>	W/W		3,20	2,95	3,10	3,00	2,90
SEER <sup>2)</sup>	W/W		<b>5,00 B</b>	<b>5,30 A</b>	<b>5,40 A</b>	<b>5,10</b>	<b>5,00</b>
Pdesign	kW		6,00	7,10	10,00	12,50	14,00
Input power cooling	kW		1,88	2,41	3,23	4,17	4,83
Annual energy consumption <sup>3)</sup>	kWh/a		—	—	—	—	—
Heating capacity	kW		6,00	7,10	10,00	12,50	14,00
Heating capacity at -7°C / -15°C <sup>4)</sup>	kW		—	—	—	—	—
COP <sup>1)</sup>	W/W		3,80	3,60	3,70	3,60	3,55
SCOP <sup>2)</sup>	W/W		<b>4,00 A+</b>	<b>4,00 A+</b>	<b>3,90 A</b>	<b>3,60</b>	<b>3,40</b>
Pdesign at -10°C	kW		5,60	5,60	7,60	12,50	14,00
Input power heating	kW		1,58	1,97	2,70	3,47	3,94
Annual energy consumption <sup>3)</sup>	kWh/a		—	—	—	—	—
Indoor unit			S-60PN1E5B	S-71PN1E5B	S-100PN1E5B	S-125PN1E5B	S-140PN1E5B
External static pressure <sup>5)</sup>	Nominal [Min - Max]	Pa	25(10 - 80)	25(10 - 80)	40(10 - 80)	50(10 - 80)	50(10 - 80)
Air volume	Hi / Med / Lo	m <sup>3</sup> /min	—	—	—	—	—
Sound pressure <sup>6)</sup>	Hi / Med / Lo	dB(A)	38/36/31	38/36/31	39/37/32	40/38/33	41/39/34
Dimension	H x W x D	mm	250 x 1000 x 650	250 x 1000 x 650	250 x 1200 x 650	250 x 1200 x 650	250 x 1200 x 650
Net weight		kg	32	32	41	41	41
Outdoor unit			U-60PZ2E5	U-71PZ2E5	U-100PZ2E5	U-125PZ2E5	U-140PZ2E5
Power source		V	220/230/240	220/230/240	220/230/240	220/230/240	220/230/240
Current	Cool	A	—	—	12,10/11,60/11,10	16,10/15,50/14,80	20,20/19,30/18,60
	Heat	A	—	—	10,10/9,70/9,30	14,00/13,40/12,90	16,80/16,00/15,30
Air volume	Cool / Heat	m <sup>3</sup> /min	—	—	76/70	86/78	89/83
Sound pressure	Cool / Heat (Hi)	dB(A)	46/48	49/49	52/52	55/55	56/56
Sound power	Cool / Heat (Hi)	dB	65/68	69/69	70/70	73/73	74/74
Dimension	H x W x D	mm	695 x 875 x 320	695 x 875 x 320	996 x 980 x 370	996 x 980 x 370	996 x 980 x 370
Net weight		kg	49	49	90	94	94
Piping connections	Liquid pipe	Inch (mm)	3/8(9,52)	3/8(9,52)	3/8(9,52)	3/8(9,52)	3/8(9,52)
	Gas pipe	Inch (mm)	5/8(15,88)	5/8(15,88)	5/8(15,88)	5/8(15,88)	5/8(15,88)
Pipe length range		m	3 - 40	3 - 40	5 - 50	5 - 50	5 - 50
Elevation difference (in/out) <sup>7)</sup>		m	30	30	30	30	30
Pipe length for additional gas		m	30	30	30	30	30
Additional gas amount		g/m	—	—	45	45	45
Refrigerant (R32)		kg/TCO <sub>2</sub> Eq.	—	—	2,60/1,755	2,98/2,0115	2,98/2,0115
Operating range	Cool Min ~ Max	°C	-10 ~ +43	-10 ~ +43	-10 ~ +43	-10 ~ +43	-10 ~ +43
	Heat Min ~ Max	°C	-15 ~ +24	-15 ~ +24	-15 ~ +24	-15 ~ +24	-15 ~ +24

### Accessories

<b>CZ-RTC5B</b>	Wired remote controller with Econavi button and datanavi
<b>CZ-RWS3 + CZ-RWRC3</b>	Wireless remote controller
<b>CZ-RE2C2</b>	Simplified remote controller
<b>PAW-WTRAY</b>	Tray for condenser water compatible with base ground support

### Accessories

<b>PAW-GRDBSE20</b>	Outdoor base ground support for noise and vibration absorption
<b>PAW-GRDSTD40</b>	Outdoor elevation platform 400 x 900 x 400mm
<b>PAW-WPH7</b>	Wind protection shield for U-100/125/140PZH2E5/8
<b>PAW-WPH9</b>	Wind protection shield for U-71PZH2E5/8

PACi Kits

R32



System Example

An inspection port (450mmx450mm or more) is required at the control-box side of the indoor unit body.

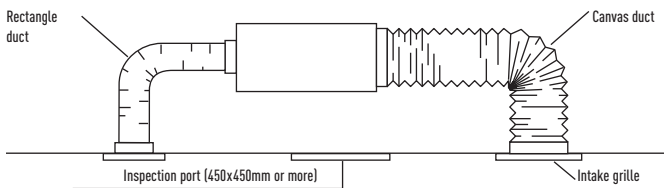

Cold Drafts Reduction at Heating

Accurate DX Coil temperature measurement by E1 and E2 sensor to reduce cold drafts at heating and increasing efficiency and comfort.

Before spec-in, please consult with an authorized Panasonic dealer.

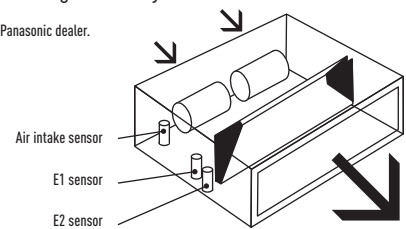

Tentative data			Three Phase			
			10,00kW	12,50kW	14,00kW	
KIT			KIT-100PN1Z8	KIT-125PN1Z8	KIT-140PN1Z8	
Remote controller			CZ-RTCSB	CZ-RTCSB	CZ-RTCSB	
Cooling capacity	kW		10,00	12,50	14,00	
EER <sup>1)</sup>	W/W		3,10	3,00	2,90	
<b>SEER <sup>2)</sup></b>	<b>W/W</b>		<b>5,30A</b>	<b>5,00</b>	<b>4,90</b>	
Pdesign	kW		10,00	12,50	14,00	
Input power cooling	kW		3,23	4,17	4,83	
Annual energy consumption <sup>3)</sup>	kWh/a		—	—	—	
Heating capacity	kW		10,00	12,50	14,00	
Heating capacity at -7°C / -15°C <sup>4)</sup>	kW		—	—	—	
COP <sup>1)</sup>	W/W		3,70	3,60	3,55	
<b>SCOP <sup>2)</sup></b>	<b>W/W</b>		<b>3,90A</b>	<b>3,60</b>	<b>3,40</b>	
Pdesign at -10°C	kW		7,60	12,50	14,00	
Input power heating	kW		2,70	3,47	3,94	
Annual energy consumption <sup>3)</sup>	kWh/a		—	—	—	
Indoor unit			S-100PN1E5B	S-125PN1E5B	S-140PN1E5B	
External static pressure <sup>5)</sup>	Nominal (Min - Max)	Pa	40(10 - 80)	50(10 - 80)	50(10 - 80)	
Air volume	Hi / Med / Lo	m <sup>3</sup> /min	—	—	—	
Sound pressure <sup>6)</sup>	Hi / Med / Lo	dB(A)	39 / 37 / 32	40 / 38 / 33	41 / 39 / 34	
Dimension	H x W x D	mm	250 x 1200 x 650	250 x 1200 x 650	250 x 1200 x 650	
Net weight		kg	41	41	41	
Outdoor unit			U-100PZ2E8	U-125PZ2E8	U-140PZ2E8	
Power source		V	380 / 400 / 415	380 / 400 / 415	380 / 400 / 415	
Current	Cool	A	4,15 / 3,95 / 3,80	5,40 / 5,10 / 4,95	6,75 / 6,40 / 6,15	
	Heat	A	3,45 / 3,30 / 3,20	4,70 / 4,45 / 4,30	5,60 / 5,30 / 5,15	
Air volume	Cool / Heat	m <sup>3</sup> /min	76 / 70	86 / 78	89 / 83	
Sound pressure	Cool / Heat (Hi)	dB(A)	52 / 52	55 / 55	56 / 56	
Sound power	Cool / Heat (Hi)	dB	70 / 70	73 / 73	74 / 74	
Dimension	H x W x D	mm	996 x 980 x 370	996 x 980 x 370	996 x 980 x 370	
Net weight		kg	90	94	94	
Piping connections	Liquid pipe	Inch (mm)	3/8 (9,52)	3/8 (9,52)	3/8 (9,52)	
	Gas pipe	Inch (mm)	5/8 (15,88)	5/8 (15,88)	5/8 (15,88)	
Pipe length range		m	5 - 50	5 - 50	5 - 50	
Elevation difference (in/out) <sup>7)</sup>		m	30	30	30	
Pipe length for additional gas		m	30	30	30	
Additional gas amount		g/m	45	45	45	
Refrigerant (R32)		kg / TCO <sub>2</sub> Eq.	2,60 / 1,755	2,98 / 2,0115	2,98 / 2,0115	
Operating range	Cool Min ~ Max	°C	-10 ~ +43	-10 ~ +43	-10 ~ +43	
	Heat Min ~ Max	°C	-15 ~ +24	-15 ~ +24	-15 ~ +24	















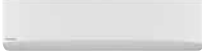
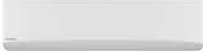
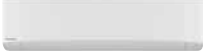
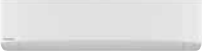















1) EER and COP calculation is based in accordance to EN14511. 2) For models below 12kW, the SEER and SCOP is calculated based on values of EU/626/2011. For models above 12kW, the SEER and SCOP is calculated based on values of EU/2281/2016. 3) The annual energy consumption is calculated in accordance to EU/626/2011. 4) Heating capacity is calculated including defrost factor correction. 5) Medium external static pressure setting from factory. 6) The sound pressure of the units shows the value measured of a position 1m in front of the main body and 1,5m from the ground. The sound pressure is measured in accordance with Eurovent 6/C/006-97 specification. 7) Add 100mm for piping port. 8) When installing the outdoor unit at a higher position than the indoor unit.\* Recommended fuse for the indoor 3A.



SEER: For KIT-100PN1Z5. SCOP: For KIT-60PN1Z5 and KIT-71PN1Z5. INTERNET CONTROL: Optional. Compatible with all Panasonic connectivity solutions. For detailed information go to the Control Systems section.

Rating Conditions: Cooling Indoor 27°C DB / 19°C WB. Cooling Outdoor 35°C DB / 24°C WB. Heating Indoor 20°C DB. Heating Outdoor 7°C DB / 6°C WB. (DB: Dry Bulb; WB: Wet Bulb) Specifications subject to change without notice. For detailed information about ErP, please visit our websites www.aircon.panasonic.eu or www.gtc.panasonic.eu.

# RANGE OF COMMERCIAL UNITS R410A

Page	Indoor Units	2,50kW	3,50 ~ 3,60kW	4,20 ~ 4,50kW	5,00kW	6,00kW
P. 210	Wall Mounted Professional Inverter -20°C • R410A GAS	 KIT-E9-PKEA	 KIT-E12-PKEA	 KIT-E15-PKEA	 KIT-E18-PKEA	
P. 212	<b>NEW</b> Wall Inverter+ • R410A GAS		 S-36PK2E5B	 S-45PK2E5B	 S-50PK2E5B	 S-60PK2E5B
<b>Check it in RAC part</b>	4-Way 60x60 Cassette Inverter • R410A GAS	 KIT-E9-PB4EA	 KIT-E12-PB4EA		 KIT-E18-RB4EA	 KIT-E21-RB4EA
P. 214	4 Way 60x60 Cassette Inverter+ • R410A GAS		 S-36PY2E5B	 S-45PY2E5B	 S-50PY2E5B	
P. 216	4 Way 90x90 Cassette Inverter+ • R410A GAS		 S-36PU2E5B	 S-45PU2E5B	 S-50PU2E5B	 S-60PU2E5B
P. 220	Ceiling Inverter+ • R410A GAS		 S-36PT2E5B	 S-45PT2E5B	 S-50PT2E5B	 S-60PT2E5B
<b>Check it in RAC part</b>	Low Static Pressure Hide Away Inverter • R410A GAS	 KIT-E9-PD3EA	 KIT-E12-QD3EA		 KIT-E18-RD3EA	
P. 224	High Static Pressure Hide Away Inverter+ • R410A GAS		 S-36PF1E5B	 S-45PF1E5B	 S-50PF1E5B	 S-60PF1E5B
P. 228	Low Static Pressure Hide Away Inverter+ • R410A GAS		 S-36PN1E5B	 S-45PN1E5B	 S-50PN1E5B	 S-60PN1E5B
P. 232	High Static Pressure Hide Away 20-25kW Inverter+ • R410A GAS					

Outdoor Units PACi Elite and Standard	3,60kW	5,00kW	6,00kW
PACi Elite	 U-36PE2E5A	 U-50PE2E5A	 U-60PE2E5A
PACi Standard			 U-60PEY2E5

U-...5A Single Phase / U-...E8A Three Phase. 1) The 4,50kW indoor unit are only available only for Twin, Triple and Double-Twin combinations.



PACi Kits

R410A

7,10kW

10,00kW

12,50kW

14,00kW

20,00kW

25,00kW



S-71PK2E5B

S-100PK2E5B (9,00kW)



S-71PU2E5B

S-100PU2E5B

S-125PU2E5B

S-140PU2E5B



S-71PT2E5B

S-100PT2E5B

S-125PT2E5B

S-140PT2E5B



S-71PF1E5B

S-100PF1E5B

S-125PF1E5B

S-140PF1E5B



S-71PN1E5B

S-100PN1E5B

S-125PN1E5B

S-140PN1E5B



S-200PE2E5



S-250PE2E5

7,10kW

10,00kW

12,50kW

14,00kW

20,00kW

25,00kW



U-71PE1E5A / U-71PE1E8A



U-100PE1E5A / U-100PE1E8A



U-125PE1E5A / U-125PE1E8A



U-140PE1E5A / U-140PE1E8A



U-200PE2E8A



U-250PE2E8A



U-71PEY2E5



U-100PEY1E5 / U-100PEY1E8



U-125PEY1E5 / U-125PEY1E8



U-140PEY1E8

# WALL MOUNTED PROFESSIONAL INVERTER

## -20°C • R410A GAS

Complete line-up with high efficiency even at -20°C

### High durability for 24/7 operation

#### Indoor Fan. Cross-Flow-Fan.

- High durability rolling bearings, large size (φ105mm) fan
- High efficiency blade
- Random pitch blade (low sound)

#### Compressor.

DC2P Panasonic original compressor, with high efficiency and reliability.

### Why is the Panasonic R2 Rotary Compressor so efficient?

1. High efficiency motor: the premium silicon steel motor meets industry efficiency requirements
2. Improved lubrication of high volume oil pump: the extended, high volume oil pump in conjunction with a larger capacity oil reservoir provides superior lubrication
3. Accumulator has larger refrigerant capacity: the larger accumulator accommodates generous refrigerant amounts needed in longer line length installations



### PKEA provides high capacity at -20°C!

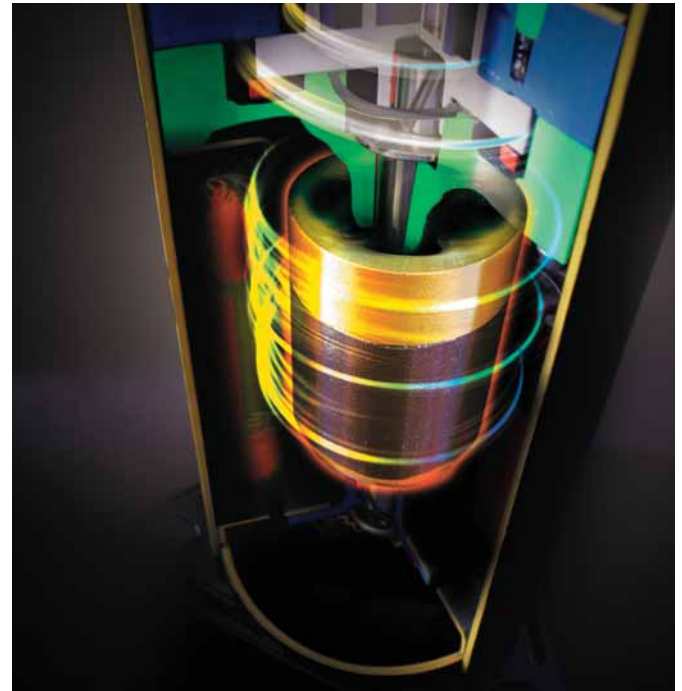
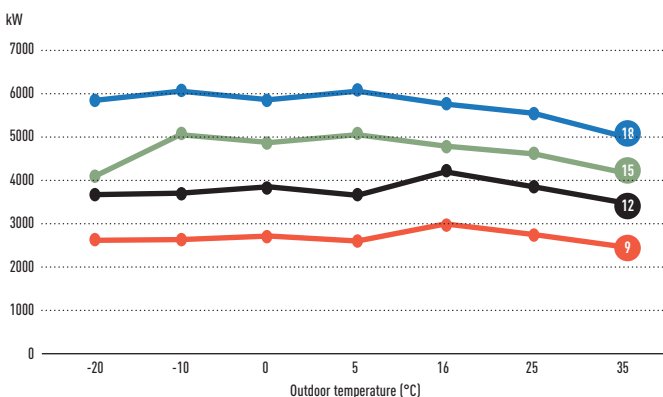

### Interface option to manage server room operation

The PAW-SERVER-PKEA server room interface manages redundancy and backup of two PKEA units with two different selectable modes:

- Plug and play by embedded redundancy and backup algorithm (no external signal needed. Further details please refer to operation manual)
- External (third party PLC) redundancy and backup management by dry contact

All settings are possible without the need for a computer connection. A special Energy Saving Mode is selectable by deep switch (available only in plug and play mode). The level of remote control input prohibition can be set when external management is by dry contact.

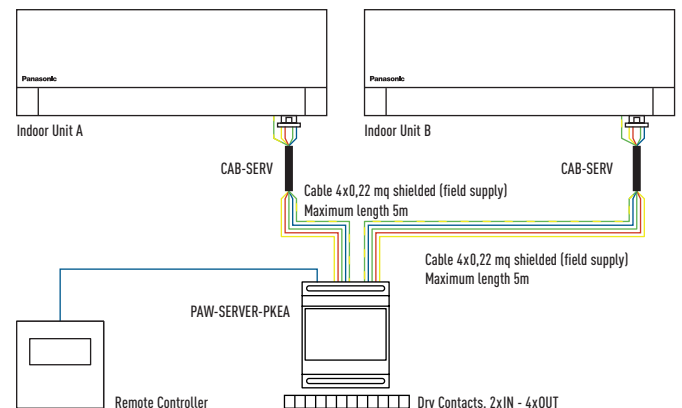

#### Main Features

- Cascade management
- Back Up system
- Overheating prevention

- ECO function
- BMS management available

#### Only available

- CS.ZXXTKEA
- CS.EXXQKE / PKE / NKE

Splits 1x1

R410A



This Wall Mounted air conditioner is especially designed for professional applications such as computer rooms where cooling inside the room is necessary even when the outside temperature is low. Furthermore this air conditioner has an automatic changeover system, in order to maintain the inside temperature even when sharp outside temperature changes occur.

- High durability rolling bearings
- Additional piping sensors to prevent freezing

**Technical focus**

- These units can be installed on R22 pipings
- Designed for 24h/7d a week operation
- Highly efficient even at -20°C

**Outdoor Features**

- Cooling even when ambient temperature is as low as -20°C
- Electronic expansion valve (accurate sub-cooling and adjustable refrigerant flow)
- Outdoor DC fan motor to provide flexible air-flow to ensure optimum condensation pressure (works on outdoor pipe temperature sensor)

KIT			KIT-E9-PKEA	KIT-E12-PKEA	KIT-E15-PKEA	KIT-E18-PKEA
Cooling capacity	Nominal (Min - Max)	kW	2,50 (0,85 - 3,00)	3,50 (0,85 - 4,00)	4,20 (0,98 - 5,00)	5,00 (0,98 - 6,00)
EER <sup>1)</sup>	Nominal (Min - Max)	W/W	4,85 (4,23 - 5,00)A	4,02 (3,57 - 5,00)A	3,50 (3,50 - 3,16)A	3,47 (3,50 - 3,02)A
Cooling capacity at -10°C		kW	2,63	3,69	5,04	6,00
EER at -10°C		W/W	7,19	5,96	6,01	6,00
Cooling capacity at -20°C		kW	2,61	3,66	4,06	5,82
EER at -20°C		W/W	6,71	5,56	4,39	5,39
<b>SEER <sup>2)</sup></b>	<b>W/W</b>		<b>7,10A++</b>	<b>6,70A++</b>	<b>6,30A++</b>	<b>6,90A++</b>
Pdesign		kW	2,50	3,50	4,20	5,00
Input power cooling	Nominal (Min - Max)	kW	0,52 (0,17 - 0,71)	0,87 (0,17 - 1,12)	1,20 (0,28 - 1,58)	1,44 (0,28 - 1,99)
Annual energy consumption <sup>3)</sup>		kWh/a	123	183	233	254
Heating capacity	Nominal (Min - Max)	kW	3,40 (0,85 - 5,40)	4,00 (0,85 - 6,60)	5,40 (0,98 - 7,10)	5,80 (0,98 - 8,00)
Heating capacity at -7°C <sup>4)</sup>		kW	3,33	4,07	4,10	4,98
COP <sup>1)</sup>	Nominal (Min - Max)	W/W	4,86 (4,12 - 5,15)A	4,35 (3,63 - 5,15)A	3,75 (2,88 - 3,24)A	3,82 (2,88 - 3,11)A
<b>SCOP <sup>5)</sup></b>	<b>W/W</b>		<b>4,40A+</b>	<b>4,10A+</b>	<b>3,90A</b>	<b>4,20A+</b>
Pdesign at -10°C		kW	2,80	3,60	3,60	4,40
Input power heating	Nominal (Min - Max)	kW	0,70 (0,17 - 1,31)	0,92 (0,17 - 1,82)	1,44 (0,34 - 2,19)	1,52 (0,34 - 2,57)
Annual energy consumption <sup>3)</sup>		kWh/a	891	1229	1292	1467
Indoor unit			CS-E9PKEA	CS-E12PKEA	CS-E15PKEA	CS-E18PKEA
Power source		V	230	230	230	230
Recommended fuse		A	16	16	16	16
Connection indoor / outdoor		mm <sup>2</sup>	4x1,5	4x1,5	4x1,5	4x2,5
Air Volume	Cool / Heat	m <sup>3</sup> /min	13,30 / 14,60	13,60 / 14,70	14,10 / 15,00	17,90 / 19,30
Moisture removal volume		L/h	1,50	2,00	2,40	2,80
Sound pressure <sup>6)</sup>	Cool (Hi / Lo / Q-Lo)	dB(A)	39 / 26 / 23	42 / 29 / 26	43 / 32 / 29	44 / 37 / 34
	Heat (Hi / Lo / Q-Lo)	dB(A)	40 / 27 / 24	42 / 33 / 29	43 / 35 / 29	44 / 37 / 34
Dimension / Net weight	HxWxD	mm / kg	295x870x255 / 10	295x870x255 / 10	295x870x255 / 10	295x1070x255 / 13
Outdoor unit			CU-E9PKEA	CU-E12PKEA	CU-E15PKEA	CU-E18PKEA
Sound pressure <sup>6)</sup>	Cool / Heat (Hi)	dB(A)	46 / 47	48 / 50	46 / 46	47 / 47
Dimension <sup>7)</sup>	HxWxD	mm	622x824x299	622x824x299	695x875x320	695x875x320
Net weight		kg	36	36	45	46
Piping connections	Liquid pipe / Gas pipe	Inch (mm)	1/4 (6,35) / 3/8 (9,52)	1/4 (6,35) / 3/8 (9,52)	1/4 (6,35) / 1/2 (12,70)	1/4 (6,35) / 1/2 (12,70)
Pipe length range		m	3 - 15	3 - 15	3 - 15	3 - 20
Elevation difference (in/out) <sup>8)</sup>		m	5	5	15	15
Pipe length for additional gas		m	7,5	7,5	7,5	7,5
Additional gas amount		g/m	20	20	20	20
Refrigerant (R410A)		kg/TCO <sub>2</sub> Eq.	—	—	—	—
Operating range	Cool / Heat Min ~ Max	°C	-20 ~ +43 / -15 ~ +24	-20 ~ +43 / -15 ~ +24	-20 ~ +43 / -15 ~ +24	-20 ~ +43 / -15 ~ +24

**Accessories**

<b>CZ-TACG1</b>	NEW Panasonic WLAN kit for internet control
<b>CZ-CAPRA1</b>	RAC interface adapter for integration into P Link
<b>PAW-WTRAY</b>	Tray for condenser water compatible with base ground support

**Accessories**

<b>PAW-GRDBSE20</b>	Outdoor base ground support for noise and vibration absorption
<b>PAW-GRDSTD40</b>	Outdoor elevation platform
<b>PAW-SERVER-PKEA</b>	PCB for installation in server rooms with security

Rating Conditions for cooling capacity at low temperature: Cooling Indoor 27°C DB / 19°C WB. Cooling Outdoor 0°C DB / -10°C WB.

1) EER and COP calculation is based in accordance to EN14511. 2) Energy Label Scale from A+++ to D. SEER is calculated in base Eurovent IPLV for SBEM for U1 indoor unit SEER=a(EER25)+b(EER50)+c(EER75)+d(EER100) where EER25, EER50, EER75 and EER100 are the EER measured value at 25%, 50%, 75% and 100% part load for temperatures 20, 25, 30 and 35°C DB, respectively. a, b, c and d are values assigned for an office type. These values are given as a=0,2, b=0,36, c=0,32 and d=0,03. The internal temperatures are taken at 27°C DB and 19°C WB. 3) The annual energy consumption is calculated in accordance to EU/626/2011. 4) Heating capacity is calculated including defrost factor correction. 5) Energy Label Scale from A+++ to D. SCOP is calculated in base Eurovent IPLV for SBEM with U1 indoor unit including defrost correction factor. 6) The sound pressure of the units shows the value measured of a position 1m in front of the main body and 1,5m from the ground. The sound pressure is measured in accordance with Eurovent 6/C/006-97 specification. 7) Add 70mm for piping port. 8) When installing the outdoor unit at a higher position than the indoor unit. // Recommended fuse for the indoor 3A.



SEER and SCOP: For KIT-E9-PKEA. SUPER QUIET: For KIT-E9-PKEA. INTERNET CONTROL: Optional.

# NEW PACi ELITE WALL MOUNTED INVERTER+ • R410A GAS



The wall mounted units with stylish matt color can be offered for many applications such as studios, gyms, high ceiling areas and even computer server rooms.

The compact design and flat face ensure discreet installation, even in a small space.

**High heating capacity at -7°C.**

### Technical focus

- Modern design with flat face and compact size
- Stylish matt white color
- DC FAN for better efficiency and control
- Six directional piping outlet
- Datanavi simple support tool app with remote controller (CZ-RTC5B)
- Easy connection and control of external fan or ERV using the connector PAW-FDC on the indoor unit PCB. The external device can be controlled by the remote control of the Panasonic indoor unit

			Single Phase					
			3,60kW	5,00kW	6,00kW	7,10kW	10,00kW	
KIT			KIT-36PK2E5D	KIT-50PK2E5D	KIT-60PK2E5D	KIT-71PK2E5D	KIT-100PK2E5D	
Remote controller			CZ-RTC5B	CZ-RTC5B	CZ-RTC5B	CZ-RTC5B	CZ-RTC5B	
Cooling capacity	Nominal (Min - Max)	kW	3,60(1,50 - 4,00)	5,00(1,50 - 5,60)	6,10(2,00 - 7,10)	7,10(2,50 - 8,00)	9,50(3,30 - 10,50)	
EER <sup>1)</sup>	Nominal (Min - Max)	W/W	4,56(6,25 - 4,30)	3,57(6,25 - 3,26)	3,53(6,67 - 3,02)	3,40(5,56 - 3,02)	3,25(3,93 - 3,09)	
SEER <sup>2)</sup>		W/W	6,40A+	6,20A+	6,40A+	6,70A+	6,30A+	
Pdesign		kW	3,60	5,00	6,10	7,10	9,50	
Input power cooling	Nominal (Min - Max)	kW	0,79(0,24 - 0,93)	1,40(0,24 - 1,72)	1,68(0,30 - 2,35)	2,09(0,45 - 2,65)	2,92(0,84 - 3,40)	
Annual energy consumption <sup>3)</sup>		kWh/a	197	282	319	371	528	
Heating capacity	Nominal (Min - Max)	kW	4,00(1,50 - 5,00)	5,60(1,50 - 6,50)	7,00(1,80 - 8,00)	8,00(2,00 - 9,00)	9,50(4,10 - 11,50)	
Heating capacity at -7°C / -15°C <sup>4)</sup>		kW	-/-	-/-	-/-	-/-	-/-	
COP <sup>1)</sup>	Nominal (Min - Max)	W/W	4,71(7,89 - 4,20)	3,94(7,89 - 3,39)	4,22(9,00 - 3,90)	4,00(5,00 - 3,10)	3,97(4,56 - 3,43)	
SCOP <sup>2)</sup>		W/W	4,30A+	4,10A+	4,20A+	4,10A+	3,80A	
Pdesign at -10°C		kW	3,60	5,00	6,00	7,10	9,50	
Input power heating	Nominal (Min - Max)	kW	0,85(0,19 - 1,19)	1,42(0,19 - 1,92)	1,66(0,20 - 2,05)	2,00(0,40 - 2,90)	2,92(0,84 - 3,40)	
Annual energy consumption <sup>3)</sup>		kWh/a	1172	1707	2000	2424	3325	
			S-36PK2E5B	S-50PK2E5B	S-60PK2E5B	S-71PK2E5B	S-100PK2E5B	
Air volume	Hi / Med / Lo	m <sup>3</sup> /min	13,00/11,00/9,00	16,00/17,50/11,00	20,00/17,50/14,50	20,00/17,50/14,50	22,00/18,50/15,00	
Sound pressure <sup>5)</sup>	Hi / Med / Lo	dB(A)	35/31/27	40/36/32	47/44/40	47/44/40	49/45/41	
Dimension	HxWxD	mm	302x1120x236	302x1120x236	302x1120x236	302x1120x236	302x1120x236	
Net weight		kg	13	13	14	14	14	
			U-36PE2E5A	U-50PE2E5A	U-60PE2E5A	U-71PE1E5A	U-100PE1E5A	
Power source		V	220/230/240	220/230/240	220/230/240	220/230/240	220/230/240	
Recommended fuse		A	-	-	-	-	-	
Connection indoor / outdoor		mm <sup>2</sup>	-	-	-	-	-	
Current	Cool	A	3,85/3,70/3,55	6,60/6,30/6,05	8,45/8,05/9,75	9,70/9,40/9,10	13,40/12,90/12,40	
	Heat	A	4,15/3,95/3,80	6,75/6,45/6,20	8,10/7,75/7,40	9,20/8,40/8,60	10,90/10,50/10,20	
Air volume	Cool / Heat	m <sup>3</sup> /min	38/38	38/41	38/41	60/60	110/95	
Sound pressure	Cool / Heat (Hi)	dB(A)	45/46	46/48	46/49	48/50	52/52	
Dimension	HxWxD	mm	619x799x299	619x799x299	619x799x299	996x940x340	1416x940x340	
Net weight		kg	39	39	40	69	98	
Piping connections	Liquid pipe	Inch (mm)	1/4(6,35)	1/4(6,35)	3/8(9,52)	3/8(9,52)	3/8(9,52)	
	Gas pipe	Inch (mm)	1/2(12,70)	1/2(12,70)	5/8(15,88)	5/8(15,88)	5/8(15,88)	
Pipe length range		m	3 - 40	3 - 40	3 - 40	5 - 50	5 - 75	
Elevation difference (in/out) <sup>6)</sup>		m	30	30	30	30	30	
Pipe length for additional gas		m	30	30	30	30	30	
Additional gas amount		g/m	20	20	40	50	50	
Refrigerant (R410A)		kg/TCO <sub>2</sub> Eq.	1,40/2,9232	1,40/2,9232	1,95/4,0716	2,35/4,9068	3,40/7,0992	
Operating range	Cool Min ~ Max	°C	-15 ~ +46	-15 ~ +46	-15 ~ +46	-15 ~ +46	-15 ~ +46	
	Heat Min ~ Max	°C	-20 ~ +24	-20 ~ +24	-20 ~ +24	-20 ~ +24	-20 ~ +24	

Accessories	
CZ-RTC5B	Wired remote controller with Econavi button and datanavi
CZ-RWS3	Wireless remote controller
CZ-RE2C2	Simplified remote controller
PAW-GRDSTD40	Outdoor elevation platform 400x900x400mm
PAW-WTRAY	Tray for condenser water compatible with base ground support
PAW-GRDBSE20	Outdoor base ground support for noise and vibration absorption

Accessories	
PAW-WPH7	Wind protection shield for U-100/125/140PE1E5A/8A and U-140PEY1E8
PAW-WPH9	Wind protection shield for U-71PE1E5A/8A and U-100/125PEY1E5/8
PAW-PACR3	Interfaces to run 3 units on Backup and alternative run

PACi Kits

R410A



**Closed discharge port.**

When the unit is turned OFF, the flap closes completely to prevent dust getting into the unit and to keep the equipment clean.

**Quiet operation.**

These units are among the quietest in the industry, making them ideal for hotels and hospitals.

**Smooth and durable design.**

Stylish matt color matches with modern interiors. The sleek, compact design ensures a discreet installation - even where space is limited.

**Piping outlet in six directions.**

Piping outlet is possible in the six directions of right, right rear, right bottom, left, left rear and left bottom, making the installation work easier.

**Air distribution is altered depending on the operational mode of the unit.**

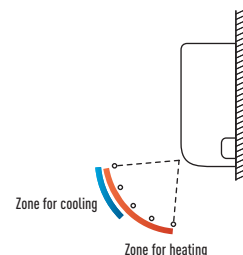

			Three Phase	
			7,10kW	10,00kW
<b>KIT</b>			<b>KIT-71PK2E8D</b>	<b>KIT-100PK2E8D</b>
<b>Remote controller</b>			<b>CZ-RTC5B</b>	<b>CZ-RTC5B</b>
Cooling capacity	Nominal (Min - Max)	kW	7,10 (3,20 - 8,00)	9,50 (3,30 - 10,50)
EER <sup>1)</sup>	Nominal (Min - Max)	W/W	3,40 (5,71 - 3,02)	3,25 (3,93 - 3,09)
<b>SEER <sup>2)</sup></b>		<b>W/W</b>	<b>6,50A++</b>	<b>6,10A+</b>
Pdesign		kW	7,10	9,50
Input power cooling	Nominal (Min - Max)	kW	2,09 (0,56 - 2,65)	2,92 (0,84 - 3,40)
Annual energy consumption <sup>3)</sup>		kWh/a	382	545
Heating capacity	Nominal (Min - Max)	kW	8,00 (2,80 - 9,00)	9,50 (4,10 - 11,50)
Heating capacity at -7°C / -15°C <sup>4)</sup>		kW	- / -	- / -
COP <sup>1)</sup>	Nominal (Min - Max)	W/W	4,00 (5,60 - 3,10)	3,97 (4,56 - 3,43)
<b>SCOP <sup>2)</sup></b>		<b>W/W</b>	<b>4,10A+</b>	<b>4,00A+</b>
Pdesign at -10°C		kW	7,10	9,50
Input power heating	Nominal (Min - Max)	kW	2,00 (0,50 - 2,90)	2,39 (0,90 - 3,35)
Annual energy consumption <sup>3)</sup>		kWh/a	2424	3325
<b>Indoor unit</b>			<b>S-71PK2E5B</b>	<b>S-100PK2E5B</b>
Air volume	Hi / Med / Lo	m <sup>3</sup> /min	20,00/17,50/14,50	22,00/18,50/15,00
Sound pressure <sup>5)</sup>	Hi / Med / Lo	dB(A)	47/44/40	49/45/41
Dimension	H x W x D	mm	302 x 1120 x 236	302 x 1120 x 236
Net weight		kg	14	14
<b>Outdoor unit</b>			<b>U-71PE1E8A</b>	<b>U-100PE1E8A</b>
Power source		V	380/400/415	380/400/415
Recommended fuse		A	16	16
Connection indoor / outdoor		mm <sup>2</sup>	2,50	2,50
Current	Cool	A	3,25/3,10/3,00	4,60/4,35/4,30
	Heat	A	3,05/3,00/2,85	3,70/3,55/3,45
Air volume	Cool / Heat	m <sup>3</sup> /min	60/60	110/95
Sound pressure	Cool / Heat (Hi)	dB(A)	48/50	52/52
Dimension	H x W x D	mm	996 x 940 x 340	1416 x 940 x 340
Net weight		kg	71	98
Piping connections	Liquid pipe	Inch (mm)	3/8 (9,52)	3/8 (9,52)
	Gas pipe	Inch (mm)	5/8 (15,88)	5/8 (15,88)
Pipe length range		m	5 - 50	5 - 75
Elevation difference (in/out) <sup>6)</sup>		m	30	30
Pipe length for additional gas		m	30	30
Additional gas amount		g/m	50	50
Refrigerant (R410A)		kg / TCO <sub>2</sub> Eq.	2,35 / 4,9068	3,40 / 7,0992
Operating range	Cool Min ~ Max	°C	-15 ~ +46	-15 ~ +46
	Heat Min ~ Max	°C	-20 ~ +24	-20 ~ +24

1) EER and COP calculation is based in accordance to EN14511. 2) For models below 12kW, the SEER and SCOP is calculated based on values of EU/626/2011. For models above 12kW, the SEER and SCOP is calculated based on values of EU/2281/2016. 3) The annual energy consumption is calculated in accordance to EU/626/2011. 4) Heating capacity is calculated including defrost factor correction. 5) The sound pressure of the units shows the value measured of a position 1m in front of the main body and 1,5m from the ground. The sound pressure is measured in accordance with Eurovent 6/C/006-97 specification. 6) When installing the outdoor unit at a higher position than the indoor unit. \* Recommended fuse for the indoor 3A.



SEER: For KIT-71PK2E5D. SCOP: For KIT-36PK2E5D. INTERNET CONTROL: Optional.  
Compatible with all Panasonic connectivity solutions. For detailed information go to the Control Systems section.

Rating Conditions: Cooling Indoor 27°C DB / 19°C WB. Cooling Outdoor 35°C DB / 24°C WB. Heating Indoor 20°C DB. Heating Outdoor 7°C DB / 6°C WB. (DB: Dry Bulb; WB: Wet Bulb)  
Specifications subject to change without notice. For detailed information about ErP, please visit our websites www.aircon.panasonic.eu or www.gtc.panasonic.eu.

# NEW PACi STANDARD WALL MOUNTED INVERTER+ • R410A GAS



The wall mounted units with stylish matt color can be offered for many applications such as studios, gyms, high ceiling areas and even computer server rooms.

The compact design and flat face ensure discreet installation, even in a small space.

### Technical focus

- Modern design with flat face and compact size
- Stylish matt white color
- DC FAN for better efficiency and control
- Six directional piping outlet
- Datanavi simple support tool app with remote controller (CZ-RTC5B)
- Easy connection and control of external fan or ERV using the connector PAW-FDC on the indoor unit PCB. The external device can be controlled by the remote control of the Panasonic indoor unit

			Single Phase		
			6,1kW	7,10kW	10,00kW
KIT			KIT-60PKY2E5D	KIT-71PKY2E5D	KIT-100PKY2E5D
Remote controller			CZ-RTC5B	CZ-RTC5B	CZ-RTC5B
Cooling capacity	Nominal (Min - Max)	kW	6,10 (2,00 - 7,10)	7,10 (2,00 - 7,70)	9,00 (2,70 - 9,70)
EER <sup>1)</sup>	Nominal (Min - Max)	W/W	3,47 (6,67 - 3,02)	2,90 (6,67 - 2,61)	2,67 (5,09 - 2,55)
SEER <sup>2)</sup>		W/W	5,70 A+	5,40 A	5,90 A+
Pdesign		kW	6,10	7,10	9,00
Input power cooling	Nominal (Min - Max)	kW	1,76 (0,30 - 2,35)	2,45 (0,30 - 2,95)	3,37 (0,53 - 3,80)
Annual energy consumption <sup>3)</sup>		kWh/a	375	460	534
Heating capacity	Nominal (Min - Max)	kW	6,10 (1,80 - 7,00)	7,10 (1,80 - 8,10)	9,00 (2,10 - 10,50)
Heating capacity at -7°C / -15°C <sup>4)</sup>		kW	- / -	- / -	9,97 / 8,43
COP <sup>1)</sup>	Nominal (Min - Max)	W/W	4,30 (9,00 - 4,12)	4,20 (9,00 - 3,60)	3,78 (5,12 - 3,50)
SCOP <sup>2)</sup>		W/W	4,00 A+	4,00 A+	3,90 A
Pdesign at -10°C		kW	6,00	6,00	9,00
Input power heating	Nominal (Min - Max)	kW	1,42 (0,20 - 1,70)	1,69 (0,20 - 2,25)	2,38 (0,41 - 3,00)
Annual energy consumption <sup>3)</sup>		kWh/a	2100	2100	3231
<b>Indoor unit</b>			<b>S-60PK2E5B</b>	<b>S-71PK2E5B</b>	<b>S-100PK2E5B</b>
Air volume	Hi / Med / Lo	m <sup>3</sup> /min	20,00 / 17,50 / 14,50	20,00 / 17,50 / 14,50	22,00 / 18,50 / 15,00
Sound pressure <sup>5)</sup>	Hi / Med / Lo	dB(A)	47 / 44 / 40	47 / 44 / 40	49 / 45 / 41
Dimension	HxWxD	mm	302 x 1120 x 236	302 x 1120 x 236	302 x 1120 x 236
Net weight		kg	14	14	14
<b>Outdoor unit</b>			<b>U-60PEY2E5</b>	<b>U-71PEY2E5</b>	<b>U-100PEY1E5</b>
Power source		V	220 / 230 / 240	220 / 230 / 240	220 / 230 / 240
Recommended fuse		A	-	-	25
Connection indoor / outdoor		mm <sup>2</sup>	-	-	4,0
Current	Cool	A	8,60 / 8,20 / 7,85	12,00 / 11,40 / 11,00	16,00 / 15,30 / 14,60
	Heat	A	6,85 / 6,55 / 6,30	8,25 / 7,85 / 7,55	10,90 / 10,60 / 10,10
Air volume	Cool / Heat	m <sup>3</sup> /min	38 / 41	44 / 41	76 / 67
Sound pressure	Cool / Heat (Hi)	dB(A)	46 / 48	49 / 49	54 / 54
Dimension	HxWxD	mm	619 x 799 x 299	619 x 799 x 299	996 x 940 x 340
Net weight		kg	40	40	73
Piping connections	Liquid pipe	Inch (mm)	3/8 (9,52)	3/8 (9,52)	3/8 (9,52)
	Gas pipe	Inch (mm)	5/8 (15,88)	5/8 (15,88)	5/8 (15,88)
Pipe length range		m	3 - 40	3 - 40	5 - 50
Elevation difference (in/out) <sup>6)</sup>		m	30	30	30
Pipe length for additional gas		m	30	30	30
Additional gas amount		g/m	40	40	50
Refrigerant (R410A)		kg / TCO <sub>2</sub> Eq.	1,95 / 4,0716	1,95 / 4,0716	2,60 / 5,4288
Operating range	Cool Min - Max	°C	-10 ~ +43	-10 ~ +43	-10 / +43
	Heat Min - Max	°C	-15 ~ +24	-15 ~ +24	-15 / +24

### Accessories

<b>CZ-RTC5B</b>	Wired remote controller with Econavi button and datanavi
<b>CZ-RWS3</b>	Wireless remote controller
<b>CZ-RE2C2</b>	Simplified remote controller
<b>PAW-GRDSTD40</b>	Outdoor elevation platform 400 x 900 x 400mm
<b>PAW-WTRAY</b>	Tray for condenser water compatible with base ground support
<b>PAW-GRDBSE20</b>	Outdoor base ground support for noise and vibration absorption

### Accessories

<b>PAW-WPH7</b>	Wind protection shield for U-100/125/140PE1E5A/8A and U-140PEY1E8
<b>PAW-WPH9</b>	Wind protection shield for U-71PE1E5A/8A and U-100/125PEY1E5/8
<b>PAW-PACR3</b>	Interfaces to run 3 units on Backup and alternative run



Controller. Wired remote controller CZ-RTCSB Compatible with Econavi  
 Optional Controller. Wireless remote controller CZ-RWS3  
 Optional Controller. Simplified remote controller CZ-REZC2  
 Optional Econavi Sensor. CZ-CENSC1

**Closed discharge port.**

When the unit is turned OFF, the flap closes completely to prevent dust getting into the unit and to keep the equipment clean.

**Quiet operation.**

These units are among the quietest in the industry, making them ideal for hotels and hospitals.

**Smooth and durable design.**

Stylish matt color matches with modern interiors. The sleek, compact design ensures a discreet installation - even where space is limited.

**PACi Kits** **R410A**



**Piping outlet in six directions.**

Piping outlet is possible in the six directions of right, right rear, right bottom, left, left rear and left bottom, making the installation work easier.

**Air distribution is altered depending on the operational mode of the unit.**

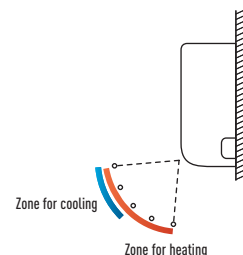

			Three Phase
			10,00kW
			KIT-100PKY2E8D
			CZ-RTCSB
<b>KIT</b>			
<b>Remote controller</b>			
Cooling capacity	Nominal (Min - Max)	kW	9,00 (2,70 - 9,70)
EER <sup>1)</sup>	Nominal (Min - Max)	W/W	2,67 (5,09 - 2,55)
<b>SEER <sup>2)</sup></b>		<b>W/W</b>	<b>5,80A+</b>
Pdesign		kW	9,00
Input power cooling	Nominal (Min - Max)	kW	3,37 (0,53 - 3,80)
Annual energy consumption <sup>3)</sup>		kWh/a	543
Heating capacity	Nominal (Min - Max)	kW	9,00 (2,10 - 10,50)
Heating capacity at -7°C / -15°C <sup>4)</sup>		kW	9,97 / 8,43
COP <sup>1)</sup>	Nominal (Min - Max)	W/W	3,78 (5,12 - 3,50)
<b>SCOP <sup>2)</sup></b>		<b>W/W</b>	<b>3,90A</b>
Pdesign at -10°C		kW	9,00
Input power heating	Nominal (Min - Max)	kW	2,38 (0,41 - 3,00)
Annual energy consumption <sup>3)</sup>		kWh/a	3231
<b>Indoor unit</b>			<b>S-100PK2E5B</b>
Air volume	Hi / Med / Lo	m <sup>3</sup> /min	22,00 / 18,50 / 15,00
Sound pressure <sup>5)</sup>	Hi / Med / Lo	dB(A)	49 / 45 / 41
Dimension	H x W x D	mm	302 x 1120 x 236
Net weight		kg	14
<b>Outdoor unit</b>			<b>U-100PEY1E8</b>
Power source		V	380 / 400 / 415
Recommended fuse		A	16
Connection indoor / outdoor		mm <sup>2</sup>	2,5
Current	Cool	A	5,40 / 5,10 / 4,95
	Heat	A	3,75 / 3,55 / 3,45
Air volume	Cool / Heat	m <sup>3</sup> /min	76 / 67
Sound pressure	Cool / Heat (Hi)	dB(A)	54 / 54
Dimension	H x W x D	mm	996 x 940 x 340
Net weight		kg	73
Piping connections	Liquid pipe	Inch (mm)	3/8 (9,52)
	Gas pipe	Inch (mm)	5/8 (15,88)
Pipe length range		m	5 - 50
Elevation difference (in/out) <sup>6)</sup>		m	30
Pipe length for additional gas		m	30
Additional gas amount		g/m	50
Refrigerant (R410A)		kg / TCO <sub>2</sub> Eq.	2,60 / 5,4288
Operating range	Cool Min ~ Max	°C	-10 / +43
	Heat Min ~ Max	°C	-15 / +24

1) EER and COP calculation is based in accordance to EN14511. 2) For models below 12kW, the SEER and SCOP is calculated based on values of EU/626/2011. For models above 12kW, the SEER and SCOP is calculated based on values of EU/2281/2016. 3) The annual energy consumption is calculated in accordance to EU/626/2011. 4) Heating capacity is calculated including defrost factor correction. 5) The sound pressure of the units shows the value measured of a position 1m in front of the main body and 1,5m from the ground. The sound pressure is measured in accordance with Eurovent 6/C/006-97 specification. 6) When installing the outdoor unit at a higher position than the indoor unit. \* Recommended fuse for the indoor 3A.



SEER and SCOP: For KIT-100PKY2E5D. INTERNET CONTROL: Optional.  
 Compatible with all Panasonic connectivity solutions. For detailed information go to the Control Systems section.

Rating Conditions: Cooling Indoor 27°C DB / 19°C WB. Cooling Outdoor 35°C DB / 24°C WB. Heating Indoor 20°C DB. Heating Outdoor 7°C DB / 6°C WB. (DB: Dry Bulb; WB: Wet Bulb)  
 Specifications subject to change without notice. For detailed information about ErP, please visit our websites www.aircon.panasonic.eu or www.gtc.panasonic.eu.

# PACi ELITE 4 WAY 60x60 CASSETTE INVERTER+ • R410A GAS



Small and powerful, ideal for offices and restaurants.  
Standard units only for Twin, Triple and Double-twin combinations.

High heating capacity at -7°C.

### Technical focus

- Fresh air distribution
- Multidirectional air flow
- Integrated drain pump gives 850mm lift
- 3 speed centrifugal fan
- DC FAN for better efficiency and control
- Easy connection and control of external fan or ERV using the connector PAW-FDC on the indoor unit PCB. The external device can be controlled by the remote control of the Panasonic indoor unit

			Single Phase	
			3,60kW	5,00kW
KIT			KIT-36PY2E5C	KIT-50PY2E5C
Remote controller			CZ-RTCS5B	CZ-RTCS5B
Cooling capacity	Nominal (Min - Max)	kW	3,60 (1,50 - 4,00)	5,00 (1,50 - 5,60)
EER <sup>1)</sup>	Nominal (Min - Max)	W/W	4,50 (6,25 - 421)	3,47 (6,25 - 3,16)
SEER <sup>2)</sup>		W/W	6,30A++	6,10A++
Pdesign		kW	3,60	5,00
Input power cooling	Nominal (Min - Max)	kW	0,80 (0,24 - 0,95)	1,44 (0,24 - 1,77)
Annual energy consumption <sup>3)</sup>		kWh/a	200	287
Heating capacity	Nominal (Min - Max)	kW	4,00 (1,50 - 5,00)	5,60 (1,50 - 6,50)
COP <sup>1)</sup>	Nominal (Min - Max)	W/W	4,08 (7,89 - 3,68)	3,31 (7,89 - 3,00)
SCOP <sup>2)</sup>		W/W	4,10A+	3,90A
Pdesign at -10°C		kW	3,60	5,00
Input power heating	Nominal (Min - Max)	kW	0,98 (0,19 - 1,36)	1,69 (0,19 - 2,17)
Annual energy consumption <sup>3)</sup>		kWh/a	1229	1795
Indoor unit			S-36PY2E5B	S-50PY2E5B
Air volume	Cool (Hi / Med / Lo)	m <sup>3</sup> /min	9,70 / 8,00 / 6,00	11,10 / 9,80 / 8,50
	Heat (Hi / Med / Lo)	m <sup>3</sup> /min	9,90 / 8,20 / 6,00	11,10 / 9,80 / 8,70
Moisture removal volume		L/h	2,1	2,8
Sound pressure <sup>4)</sup>	Hi / Med / Lo	dB(A)	36 / 32 / 26	40 / 37 / 33
Sound power	Hi / Med / Lo	dB	51 / 47 / 41	55 / 52 / 48
Dimension (HxWxD) / Net weight	Indoor	mm / kg	288 x 583 x 583 / 18	288 x 583 x 583 / 18
	CZ-KPY3AW Panel	mm / kg	31 x 700 x 700 / 2,4	31 x 700 x 700 / 2,4
	CZ-KPY3BW Panel	mm / kg	31 x 625 x 625 / 2,4	31 x 625 x 625 / 2,4
Outdoor unit			U-36PE2E5A	U-50PE2E5A
Power source		V	220 / 230 / 240	220 / 230 / 240
Current	Cool	A	3,80 / 3,60 / 3,50	6,70 / 6,50 / 6,20
	Heat	A	4,70 / 4,50 / 4,35	8,05 / 7,70 / 7,40
Air volume	Cool / Heat	m <sup>3</sup> /min	38 / 38	38 / 41
Sound pressure	Cool / Heat (Hi)	dB(A)	45 / 46	46 / 48
Sound power	Cool / Heat (Hi)	dB	64 / 66	65 / 68
Dimension / Net weight	HxWxD	mm / kg	619 x 799 x 299 / 39	619 x 799 x 299 / 39
Piping connections	Liquid pipe	Inch (mm)	1/4 (6,35)	1/4 (6,35)
	Gas pipe	Inch (mm)	1/2 (12,70)	1/2 (12,70)
Pipe length range		m	3 - 40	3 - 40
Elevation difference (in/out) <sup>6)</sup>		m	30	30
Pipe length for additional gas		m	30	30
Additional gas amount		g/m	20	20
Refrigerant (R410A)		kg/TCO <sub>2</sub> Eq.	1,40 / 2,9232	1,40 / 2,9232
Operating range	Cool Min ~ Max	°C	-15 ~ +46	-15 ~ +46
	Heat Min ~ Max	°C	-20 ~ +24	-20 ~ +24

### Accessories

<b>CZ-RTCS5B</b>	Wired remote controller with Econavi button and datanavi
<b>CZ-RWS3</b>	Wireless remote controller
<b>CZ-RE2C2</b>	Simplified remote controller

### Accessories

<b>PAW-WTRAY</b>	Tray for condenser water compatible with base ground support
<b>PAW-GRDBSE20</b>	Outdoor base ground support for noise and vibration absorption
<b>PAW-GRD5TD40</b>	Outdoor elevation platform 400 x 900 x 400mm



SEER and SCOP: For KIT-36PY2E5C. INTERNET CONTROL: Optional.  
Compatible with all Panasonic connectivity solutions. For detailed information go to the Control Systems section.



## PACi STANDARD 4 WAY 60x60 CASSETTE INVERTER+ • R410A GAS

PACi Kits

R410A



Controller.  
Wired remote controller  
CZ-RIC5B  
Compatible with Econavi



Optional Controller  
Wireless remote controller  
CZ-RWS3



Optional Controller.  
Simplified remote controller  
CZ-RE2C2

### A drain height of approximately 850mm from the ceiling surface

The drain height can be increased by approx. 350mm over the conventional value by using a high-lift drain pump, and long horizontal piping is possible.

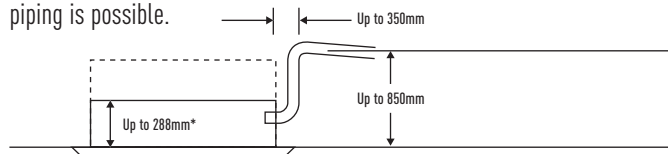

Lightweight at 18kg, the unit is also very slim with a height of only 288mm, making installation possible even in narrow ceilings.

### Lighter and slimmer, easier installation

Lightweight and very slim which makes installation possible even in narrow ceilings.

Designed to fit exactly into a 600x600mm ceiling grid without the need to alter the bar configuration.

Significant reduction of power consumption by using highly developed DC fan motors with variable speed, special heat exchangers, etc.

			3,60kW	4,50kW	5,00kW
Indoor unit			S-36PY2E5B	S-45PY2E5B <sup>1)</sup>	S-50PY2E5B
Cooling capacity		kW	3,60	4,50	5,00
Heating capacity		kW	4,20	5,20	5,60
Current	Cool	A	0,30	0,32	0,35
	Heat	A	0,30	0,30	0,35
Input power	Cool	kW	0,40	0,40	0,45
	Heat	kW	0,35	0,35	0,40
Air volume	Cool / Heat	m <sup>3</sup> /min	10,00/10,00	10,00/10,00	11,00/11,00
Moisture removal volume		L/h	2,1	2,5	2,8
Sound pressure <sup>4)</sup>	Cool (Hi / Med / Lo)	dB(A)	36/32/26	38/34/28	40/37/33
	Heat (Hi / Med / Lo)	dB(A)	36/32/26	38/34/28	40/37/33
Sound power	Cool (Hi)	dB	51/47/41	53/49/43	55/52/48
	Heat (Hi)	dB	51/47/41	53/49/43	55/52/48
Dimension (HxWxD)	Indoor	mm	288 x 583 x 583	288 x 583 x 583	288 x 583 x 583
	Panel CZ-KPY3AW	mm	31 x 700 x 700	31 x 700 x 700	31 x 700 x 700
	Panel CZ-KPY3BW	mm	31 x 625 x 625	31 x 625 x 625	31 x 625 x 625
Net weight	Indoor	kg	18	18	18
	Panel	kg	2,4	2,4	2,4
Piping connections	Liquid pipe	Inch (mm)	1/4 [6,35]	1/4 [6,35]	1/4 [6,35]
	Gas pipe	Inch (mm)	1/2 [12,70]	1/2 [12,70]	1/2 [12,70]
Operating range	Cool Min ~ Max	°C	+18 ~ +32	+18 ~ +32	+18 ~ +32
	Heat Min ~ Max	°C	+16 ~ +30	+16 ~ +30	+16 ~ +30

1) Only for multi combinations.  
Recommended fuse for the indoor 3A.

1) EER and COP calculation is based in accordance to EN14511. 2) For models below 12kW, the SEER and SCOP is calculated based on values of EU/626/2011. For models above 12kW, the SEER and SCOP is calculated based on values of EU/2281/2016. 3) The annual energy consumption is calculated in accordance to EU/626/2011. 4) The sound pressure of the units shows the value measured of a position 1m in front of the main body and 1,5m from the ground. The sound pressure is measured in accordance with Eurovent 6/C/006-97 specification. 5) When installing the outdoor unit at a higher position than the indoor unit.\* Recommended fuse for the indoor 3A.

# PACi ELITE 4 WAY 90x90 CASSETTE INVERTER+ • R410A GAS



## Large capacity PACi. Trusted comfort and high efficiency.

Thanks to advances in design and technology such as the high performance turbo fan which is more efficient and silent, and nanoe™ X air purification, the U2 Panasonic 4 way 90x90 Cassette offers high energy saving, fresh air and comfort.

## High heating capacity at -7°C.

## Technical focus

- High performance turbo fan, path system for heat exchanger
- nanoe™ X: The first air purifier technology in commercial air conditioning
- Econavi: Intelligent sensor to reduce waste of energy
- Datanavi simple support tool app with remote controller (CZ-RTC5B)
- Lower noise in slow fan operation
- Light weight, easy piping
- Drain pump included

			Single Phase						
			3,60kW	5,00kW	6,00kW	7,10kW	10,00kW	12,50kW	14,00kW
KIT			KIT-36PU2E5D	KIT-50PU2E5D	KIT-60PU2E5D	KIT-71PU2E5D	KIT-100PU2E5D	KIT-125PU2E5D	KIT-140PU2E5D
Remote controller			CZ-RTC5B	CZ-RTC5B	CZ-RTC5B	CZ-RTC5B	CZ-RTC5B	CZ-RTC5B	CZ-RTC5B
Cooling capacity	Nominal (Min - Max)	kW	3,60(1,50 - 4,00)	5,00(1,50 - 5,60)	6,00(2,00 - 7,10)	7,10(2,50 - 8,00)	10,00(3,03 - 12,50)	12,50(3,30 - 14,00)	14,00(3,30 - 15,50)
EER <sup>1)</sup>	Nominal (Min - Max)	W/W	4,68(6,25 - 4,40)	3,79(6,25 - 3,46)	3,75(8,00 - 3,23)	3,94(5,56 - 3,02)	4,27(4,29 - 3,38)	3,70(4,29 - 3,04)	3,30(4,29 - 2,70)
SEER <sup>2)</sup>		W/W	7,40A++	7,10A++	7,40A++	7,60A++	7,60A++	6,91	6,52
Pdesign		kW	3,60	5,00	6,00	7,10	10,00	12,50	14,00
Input power cooling	Nominal (Min - Max)	kW	0,77(0,24 - 0,91)	1,32(0,24 - 1,62)	1,60(0,25 - 2,20)	1,80(0,45 - 2,65)	2,34(0,77 - 3,70)	3,37(0,77 - 4,60)	4,24(0,77 - 5,74)
Annual energy consumption <sup>3)</sup>		kWh/a	170	246	284	327	461	—	—
Heating capacity	Nominal (Min - Max)	kW	4,00(1,50 - 5,00)	5,60(1,50 - 6,50)	7,00(1,80 - 8,00)	8,00(2,00 - 9,00)	11,20(4,10 - 14,00)	14,00(4,10 - 16,00)	16,00(4,10 - 18,00)
Heating capacity at -7°C / -15°C <sup>4)</sup>		kW	—/—	—/—	—/—	—/—	—/—	—/—	—/—
COP <sup>1)</sup>	Nominal (Min - Max)	W/W	5,13(7,89 - 4,63)	4,44(7,89 - 4,01)	4,07(9,00 - 3,90)	4,30(5,00 - 3,16)	5,00(5,19 - 3,18)	4,60(5,19 - 3,17)	4,30(5,19 - 3,15)
SCOP <sup>2)</sup>		W/W	4,60A++	4,40A+	4,20A+	4,30A+	4,80A++	4,10	3,90
Pdesign at -10°C		kW	3,60	5,00	6,00	7,10	10,00	12,50	14,00
Input power heating	Nominal (Min - Max)	kW	0,78(0,19 - 1,08)	1,26(0,19 - 1,62)	1,72(0,20 - 2,05)	1,86(0,40 - 2,85)	2,24(0,79 - 4,40)	3,04(0,79 - 5,04)	3,72(0,79 - 5,72)
Annual energy consumption <sup>3)</sup>		kWh/a	1095	1591	1999	2312	2917	—	—
<b>Indoor unit</b>			<b>S-36PU2E5B</b>	<b>S-50PU2E5B</b>	<b>S-60PU2E5B</b>	<b>S-71PU2E5B</b>	<b>S-100PU2E5B</b>	<b>S-125PU2E5B</b>	<b>S-140PU2E5B</b>
Air volume	Hi / Med / Lo	m³/min	14,50/13,00/11,50	16,50/13,50/11,50	21,00/16,00/13,00	22,00/16,00/13,00	36,00/26,00/18,00	37,00/27,00/19,00	38,00/29,00/20,00
Sound pressure <sup>5)</sup>	Hi / Med / Lo	dB(A)	30/28/27	32/29/27	36/31/28	37/31/28	45/38/32	46/39/33	47/40/34
Dimension	Indoor (HxWxD)	mm	256x840x840	256x840x840	256x840x840	256x840x840	319x840x840	319x840x840	319x840x840
	Panel (HxWxD)	mm	33,5x950x950	33,5x950x950	33,5x950x950	33,5x950x950	33,5x950x950	33,5x950x950	33,5x950x950
Net weight	Indoor / Panel	kg	19 / 5	19 / 5	20 / 5	20 / 5	25 / 5	25 / 5	25 / 5
<b>Outdoor unit</b>			<b>U-36PE2E5A</b>	<b>U-50PE2E5A</b>	<b>U-60PE2E5A</b>	<b>U-71PE1E5A</b>	<b>U-100PE1E5A</b>	<b>U-125PE1E5A</b>	<b>U-140PE1E5A</b>
Power source		V	220/230/240	220/230/240	220/230/240	220/230/240	220/230/240	220/230/240	220/230/240
Recommended fuse		A	—	—	—	20	25	30	16
Connection indoor / outdoor		mm²	—	—	—	2,5	4,0	6,0	2,5
Current	Cool	A	3,75/3,55/3,40	6,25/5,95/5,70	7,90/7,50/7,25	8,40/8,10/7,90	10,50/10,10/9,70	15,20/14,70/14,30	19,30/18,60/18,00
	Heat	A	3,80/3,60/3,45	6,05/5,75/5,50	8,50/8,15/7,80	8,60/8,25/8,00	10,10/9,70/9,40	13,70/13,30/12,90	16,90/16,30/15,80
Air volume	Cool / Heat	m³/min	38/38	38/41	38/41	60/60	110/95	130/110	135/120
Sound pressure	Cool / Heat (Hi)	dB(A)	45/46	46/48	46/49	48/50	52/52	53/53	54/55
Dimension	HxWxD	mm	619x799x299	619x799x299	619x799x299	996x940x340	1416x940x340	1416x940x340	1416x940x340
Net weight		kg	39	39	40	69	98	98	98
Piping connections	Liquid pipe	Inch (mm)	1/4(6,35)	1/4(6,35)	3/8(9,52)	3/8(9,52)	3/8(9,52)	3/8(9,52)	3/8(9,52)
	Gas pipe	Inch (mm)	1/2(12,70)	1/2(12,70)	5/8(15,88)	5/8(15,88)	5/8(15,88)	5/8(15,88)	5/8(15,88)
Pipe length range		m	3~40	3~40	3~40	5~50	5~75	5~75	5~75
Elevation difference (in/out) <sup>6)</sup>		m	30	30	30	30	30	30	30
Pipe length for additional gas		m	30	30	30	30	30	30	30
Additional gas amount		g/m	20	20	40	50	50	50	50
Refrigerant (R410A)		kg/TCO <sub>2</sub> Eq.	1,40/2,9232	1,40/2,9232	1,95/4,0716	2,35/4,9068	3,40/7,0992	3,40/7,0992	3,40/7,0992
Operating range	Cool Min ~ Max	°C	-15~+46	-15~+46	-15~+46	-15~+46	-15~+46	-15~+46	-15~+46
	Heat Min ~ Max	°C	-20~+24	-20~+24	-20~+24	-20~+24	-20~+24	-20~+24	-20~+24

Accessories	
<b>CZ-RTC5B</b>	Wired remote controller with Econavi button and datanavi
<b>CZ-RWS3 + CZ-RWRU3</b>	Wireless remote controller
<b>CZ-RE2C2</b>	Simplified remote controller
<b>CZ-CNEXU1</b>	nanoe™ X air purifying system
<b>CZ-KPU3A</b>	Econavi exclusive panel
<b>PAW-WTRAY</b>	Tray for condenser water compatible with base ground support

Accessories	
<b>PAW-GRDBSE20</b>	Outdoor base ground support for noise and vibration absorption
<b>PAW-WPH7</b>	Wind protection shield for U-100/125/140PE1E5A/8A and U-140PEY1E8
<b>PAW-WPH9</b>	Wind protection shield for U-71PE1E5A/8A and U-100/125PEY1E5/8

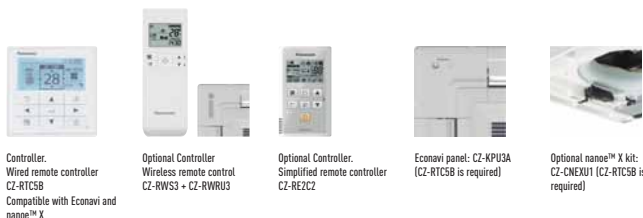

Controller. Wired remote controller CZ-RTCSB Compatible with Econavi and nanoe™ X  
 Optional Controller. Wireless remote control CZ-RWS3 + CZ-RWRU3  
 Optional Controller. Simplified remote controller CZ-REZC2  
 Econavi panel: CZ-KPU3A (CZ-RTCSB is required)  
 Optional nanoe™ X kit: CZ-CNEXU1 (CZ-RTCSB is required)

### Group control, circulation function

Circulating operation is activated when a room is unoccupied to evenly distribute air and minimize temperature gaps in both heating and cooling operation.

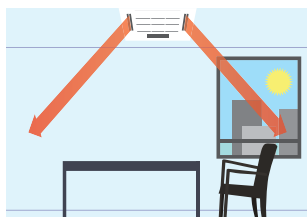

Circulation by Detecting no movement (10min.)



Indirect air flow by detecting movement

			Three Phase			
			7,10kW	10,00kW	12,50kW	14,00kW
KIT			KIT-71PU2E8D	KIT-100PU2E8D	KIT-125PU2E8D	KIT-140PU2E8D
Remote controller			CZ-RTCSB	CZ-RTCSB	CZ-RTCSB	CZ-RTCSB
Cooling capacity	Nominal (Min - Max)	kW	7,10 (3,20 - 8,00)	10,00 (3,30 - 12,50)	12,50 (3,30 - 14,00)	14,00 (3,30 - 15,00)
EER <sup>1)</sup>	Nominal (Min - Max)	W/W	3,94 (5,71 - 3,02)	4,27 (4,29 - 3,38)	3,70 (4,29 - 3,04)	3,30 (4,29 - 2,70)
SEER <sup>2)</sup>		W/W	<b>7,30A++</b>	<b>7,40A++</b>	<b>6,89</b>	<b>6,50</b>
Pdesign		kW	7,10	10,00	12,50	14,00
Input power cooling	Nominal (Min - Max)	kW	1,80 (0,56 - 2,65)	2,34 (0,77 - 3,70)	3,37 (0,77 - 4,60)	4,24 (0,77 - 5,74)
Annual energy consumption <sup>3)</sup>		kWh/a	340	473	—	—
Heating capacity	Nominal (Min - Max)	kW	8,00 (2,80 - 9,00)	11,20 (4,10 - 14,00)	14,00 (4,10 - 16,00)	16,00 (4,10 - 18,00)
Heating capacity at -7°C / -15°C <sup>4)</sup>		kW	— / —	— / —	— / —	— / —
COP <sup>1)</sup>	Nominal (Min - Max)	W/W	4,30 (5,60 - 3,16)	5,00 (5,19 - 3,18)	4,60 (5,19 - 3,17)	4,30 (5,19 - 3,15)
SCOP <sup>2)</sup>		W/W	<b>4,30A+</b>	<b>4,80A++</b>	<b>4,10</b>	<b>3,90</b>
Pdesign at -10°C		kW	7,10	10,00	12,50	14,00
Input power heating	Nominal (Min - Max)	kW	1,86 (0,50 - 2,85)	2,24 (0,79 - 4,40)	3,04 (0,79 - 5,04)	3,72 (0,79 - 5,72)
Annual energy consumption <sup>3)</sup>		kWh/a	2312	2917	—	—
Indoor unit			S-71PU2E5B	S-100PU2E5B	S-125PU2E5B	S-140PU2E5B
Air volume	Hi / Med / Lo	m <sup>3</sup> /min	22,00 / 16,00 / 13,00	36,00 / 26,00 / 18,00	37,00 / 27,00 / 19,00	38,00 / 29,00 / 20,00
Sound pressure <sup>5)</sup>	Hi / Med / Lo	dB(A)	37 / 31 / 28	45 / 38 / 32	46 / 39 / 33	47 / 40 / 34
Dimension	Indoor (H x W x D)	mm	256 x 840 x 840	319 x 840 x 840	319 x 840 x 840	319 x 840 x 840
	Panel (H x W x D)	mm	33,5 x 950 x 950	33,5 x 950 x 950	33,5 x 950 x 950	33,5 x 950 x 950
Net weight	Indoor / Panel	kg	20 / 5	25 / 5	25 / 5	25 / 5
Outdoor unit			U-71PE1E8A	U-100PE1E8A	U-125PE1E8A	U-140PE1E8A
Power source		V	380 / 400 / 415	380 / 400 / 415	380 / 400 / 415	380 / 400 / 415
Recommended fuse		A	16	16	16	16
Connection indoor / outdoor		mm <sup>2</sup>	2,5	2,5	2,5	2,5
Current	Cool	A	2,80 / 2,70 / 2,60	3,60 / 3,45 / 3,35	5,25 / 5,00 / 4,80	6,65 / 6,30 / 6,10
	Heat	A	2,90 / 2,80 / 2,70	3,45 / 3,30 / 3,20	4,75 / 4,50 / 4,35	5,80 / 5,55 / 5,35
Air volume	Cool / Heat	m <sup>3</sup> /min	60 / 60	110 / 95	130 / 110	135 / 120
Sound pressure	Cool / Heat (Hi)	dB(A)	48 / 50	52 / 52	53 / 53	54 / 55
Dimension	H x W x D	mm	996 x 940 x 340	1416 x 940 x 340	1416 x 940 x 340	1416 x 940 x 340
Net weight		kg	71	98	98	98
Piping connections	Liquid pipe	Inch (mm)	3/8 (9,52)	3/8 (9,52)	3/8 (9,52)	3/8 (9,52)
	Gas pipe	Inch (mm)	5/8 (15,88)	5/8 (15,88)	5/8 (15,88)	5/8 (15,88)
Pipe length range		m	5 - 50	5 - 75	5 - 75	5 - 75
Elevation difference (in/out) <sup>6)</sup>		m	30	30	30	30
Pipe length for additional gas		m	30	30	30	30
Additional gas amount		g/m	50	50	50	50
Refrigerant (R410A)		kg/TCO <sub>2</sub> Eq.	2,35 / 4,9068	3,40 / 7,0992	3,40 / 7,0992	3,40 / 7,0992
Operating range	Cool Min ~ Max	°C	-15 ~ +46	-15 ~ +46	-15 ~ +46	-15 ~ +46
	Heat Min ~ Max	°C	-20 ~ +24	-20 ~ +24	-20 ~ +24	-20 ~ +24

1) EER and COP calculation is based in accordance to EN14511. 2) For models below 12kW, the SEER and SCOP is calculated based on values of EU/626/2011. For models above 12kW, the SEER and SCOP is calculated based on values of EU/2281/2016. 3) The annual energy consumption is calculated in accordance to EU/626/2011. 4) Heating capacity is calculated including defrost factor correction. 5) The sound pressure of the units shows the value measured of a position 1m in front of the main body and 1,5m from the ground. The sound pressure is measured in accordance with Eurovent 6/C/006-97 specification. 6) When installing the outdoor unit at a higher position than the indoor unit.\* Recommended fuse for the indoor 3A.



SEER and SCOP: For KIT-100PU2E5D. ECONAVI and INTERNET CONTROL: Optional.  
 Compatible with all Panasonic connectivity solutions. For detailed information go to the Control Systems section.

Rating Conditions: Cooling Indoor 27°C DB / 19°C WB. Cooling Outdoor 35°C DB / 24°C WB. Heating Indoor 20°C DB. Heating Outdoor 7°C DB / 6°C WB. (DB: Dry Bulb; WB: Wet Bulb)  
 Specifications subject to change without notice. For detailed information about ErP, please visit our websites www.aircon.panasonic.eu or www.ptc.panasonic.eu.



### nanoe™ X deodorises and inhibits certain bacteria & viruses

The newly developed nanoe™ X device produces 10x times more OH radicals (4800 billion)<sup>1)</sup> than regular nanoe™ device. Greater amounts of OH radicals contained in nanoe™ X lead to outstanding effects in bacteria, viruses and allergens inhibition as well as deodorisation. A fresher and cleaner home awaits you.

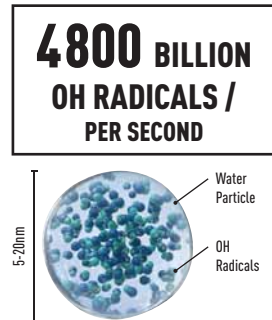

1) Based on Panasonic Survey.  
 CZ-RTCSB and optional accessory CZ-CNEXU1 are required to use nanoe™ X function.

# PACi STANDARD 4 WAY 90x90 CASSETTE INVERTER+ • R410A GAS



## Large capacity PACi. Trusted comfort and high efficiency.

Thanks to advances in design and technology such as the high performance turbo fan which is more efficient and silent, and nanoe™ X air purification, the U2 Panasonic 4 way 90x90 Cassette offers high energy saving, fresh air and comfort.

## Technical focus

- High performance turbo fan, path system for heat exchanger
- nanoe™ X: The first air purifier technology in commercial air conditioning
- Econavi: Intelligent sensor to reduce waste of energy
- Datanavi simple support tool app with remote controller (CZ-RTC5B)
- Lower noise in slow fan operation
- Light weight, easy piping
- Drain pump included

			Single Phase			
			6,00kW	7,10kW	10,00kW	12,50kW
KIT			KIT-60PUY2E5D	KIT-71PUY2E5D	KIT-100PUY2E5D	KIT-125PUY2E5D
Remote controller			CZ-RTC5B	CZ-RTC5B	CZ-RTC5B	CZ-RTC5B
Cooling capacity	Nominal (Min - Max)	kW	6,00 [2,00 - 7,10]	7,10 [2,00 - 7,70]	10,00 [3,30 - 12,50]	12,50 [3,80 - 13,50]
EER <sup>1)</sup>	Nominal (Min - Max)	W/W	3,70 [8,00 - 3,23]	3,24 [8,00 - 2,91]	4,27 [4,29 - 3,38]	3,16 [4,22 - 2,77]
SEER <sup>2)</sup>		W/W	7,00A++	6,50A++	7,60A++	6,22
Pdesign		kW	6,00	7,10	10,00	12,50
Input power cooling	Nominal (Min - Max)	kW	1,62 [0,25 - 2,20]	2,19 [0,25 - 2,65]	2,34 [0,77 - 3,70]	3,96 [0,90 - 4,88]
Annual energy consumption <sup>3)</sup>		kWh/a	300	382	461	—
Heating capacity	Nominal (Min - Max)	kW	6,00 [1,80 - 7,00]	7,10 [1,80 - 8,10]	11,20 [4,10 - 14,00]	12,50 [3,40 - 15,00]
Heating capacity at -7°C / -15°C <sup>4)</sup>		kW	— / —	— / —	— / —	— / —
COP <sup>1)</sup>	Nominal (Min - Max)	W/W	4,20 [9,00 - 4,24]	4,13 [9,00 - 3,68]	5,00 [5,19 - 3,18]	4,10 [4,66 - 3,41]
SCOP <sup>2)</sup>		W/W	4,10A+	4,20A+	4,80A++	3,87
Pdesign at -10°C		kW	6,00	6,00	10,00	12,50
Input power heating	Nominal (Min - Max)	kW	1,43 [0,20 - 1,65]	1,72 [0,20 - 2,20]	2,24 [0,79 - 4,40]	3,05 [0,73 - 4,40]
Annual energy consumption <sup>3)</sup>		kWh/a	2047	2002	2917	—
<b>Indoor unit</b>			<b>S-60PU2E5B</b>	<b>S-71PU2E5B</b>	<b>S-100PU2E5B</b>	<b>S-125PU2E5B</b>
Air volume	Hi / Med / Lo	m <sup>3</sup> /min	21,00/16,00/13,00	22,00/16,00/13,00	36,0/26,00/18,00	37,00/27,00/19,00
Sound pressure <sup>5)</sup>	Hi / Med / Lo	dB(A)	36/31/28	37/31/28	45/38/32	46/39/33
Dimension	Indoor (HxWxD)	mm	256x840x840	256x840x840	319x840x840	319x840x840
	Panel (HxWxD)	mm	33,5x950x950	33,5x950x950	33,5x950x950	33,5x950x950
Net weight	Indoor / Panel	kg	20 / 5	20 / 5	25 / 5	25 / 5
<b>Outdoor unit</b>			<b>U-60PEY2E5</b>	<b>U-71PEY2E5</b>	<b>U-100PEY1E5</b>	<b>U-125PEY1E5</b>
Power source		V	220/230/240	220/230/240	220/230/240	220/230/240
Recommended fuse		A	—	—	—	30
Connection indoor / outdoor		mm <sup>2</sup>	—	—	—	6,0
Current	Cool	A	8,00/7,60/7,30	10,70/10,30/9,85	14,80/14,20/13,60	18,80/18,00/17,20
	Heat	A	7,05/6,75/6,45	8,50/8,10/7,80	11,00/10,60/10,20	14,30/13,60/13,10
Air volume	Cool / Heat	m <sup>3</sup> /min	38/41	44/41	110/95	80/73
Sound pressure	Cool / Heat (Hi)	dB(A)	46/48	49/49	52/52	56/56
Dimension	HxWxD	mm	619x799x299	619x799x299	996x940x340	996x940x340
Net weight		kg	40	40	73	85
Piping connections	Liquid pipe	Inch (mm)	3/8 (9,52)	3/8 (9,52)	3/8 (9,52)	3/8 (9,52)
	Gas pipe	Inch (mm)	5/8 (15,88)	5/8 (15,88)	5/8 (15,88)	5/8 (15,88)
Pipe length range		m	3-40	3-40	5-50	5-50
Elevation difference (in/out) <sup>6)</sup>		m	30	30	30	30
Pipe length for additional gas		m	30	30	30	30
Additional gas amount		g/m	40	40	50	50
Refrigerant (R410A)		kg/TCO <sub>2</sub> Eq.	1,95/4,0716	1,95/4,0716	2,60/5,4288	3,20/6,6816
Operating range	Cool Min ~ Max	°C	-10 ~ +43	-10 ~ +43	-10 ~ +43	-10 ~ +43
	Heat Min ~ Max	°C	-15 ~ +24	-15 ~ +24	-15 ~ +24	-15 ~ +24

### Accessories

<b>CZ-RTC5B</b>	Wired remote controller with Econavi button and datanavi
<b>CZ-RWS3 + CZ-RWRU3</b>	Wireless remote controller
<b>CZ-RE2C2</b>	Simplified remote controller
<b>CZ-CNEXU1</b>	nanoe™ X air purifying system
<b>CZ-KPU3A</b>	Econavi exclusive panel
<b>PAW-WTRAY</b>	Tray for condenser water compatible with base ground support

### Accessories

<b>PAW-GRDBSE20</b>	Outdoor base ground support for noise and vibration absorption
<b>PAW-WPH7</b>	Wind protection shield for U-100/125/140PE1E5A/8A and U-140PEY1E8
<b>PAW-WPH9</b>	Wind protection shield for U-71PE1E5A/8A and U-100/125PEY1E5/8

PACi Kits

R410A



Controller. Wired remote controller CZ-RTCSB  
Compatible with Econavi and nano™ X  
Optional Controller. Wireless remote control CZ-RWS3 + CZ-RWRU3  
Optional Controller. Simplified remote controller CZ-REZC2  
Econavi panel: CZ-KPU3A (CZ-RTCSB is required)  
Optional nano™ X kit: CZ-CNEXU1 (CZ-RTCSB is required)



Group control, circulation function

Circulating operation is activated when a room is unoccupied to evenly distribute air and minimize temperature gaps in both heating and cooling operation.

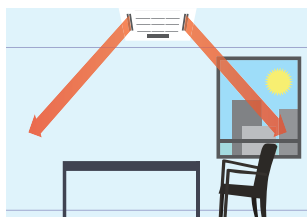

Circulation by Detecting no movement (10min.)



Indirect air flow by detecting movement

nano™ X deodorises and inhibits certain bacteria & viruses

The newly developed nano™ X device produces 10x times more OH radicals (4800 billion)<sup>1</sup> than regular nano™ device. Greater amounts of OH radicals contained in nano™ X lead to outstanding effects in bacteria, viruses and allergens inhibition as well as deodorisation. A fresher and cleaner home awaits you.

**4800 BILLION  
OH RADICALS /  
PER SECOND**

Water Particle  
OH Radicals

5-20mm

<sup>1</sup> Based on Panasonic Survey. CZ-RTCSB and optional accessory CZ-CNEXU1 are required to use nano™ X function.

KIT	Three Phase		
	10,00kW	12,50kW	14,00kW
<b>Remote controller</b>	<b>KIT-100PUY2E8D</b>	<b>KIT-125PUY2E8D</b>	<b>KIT-140PUY2E8D</b>
	<b>CZ-RTCSB</b>	<b>CZ-RTCSB</b>	<b>CZ-RTCSB</b>
Cooling capacity	Nominal (Min - Max) kW	10,00 (2,70 - 11,50)	12,50 (3,80 - 13,50)
EER <sup>1)</sup>	Nominal (Min - Max) W/W	3,16 (5,09 - 2,74)	3,16 (4,22 - 2,77)
<b>SEER <sup>2)</sup></b>	<b>W/W</b>	<b>6,60A++</b>	<b>6,20</b>
Pdesign	kW	10,00	12,50
Input power cooling	Nominal (Min - Max) kW	3,16 (0,53 - 4,20)	3,96 (0,90 - 4,88)
Annual energy consumption <sup>3)</sup>	kWh/a	530	—
Heating capacity	Nominal (Min - Max) kW	10,00 (2,10 - 13,80)	12,50 (3,40 - 15,00)
Heating capacity at -7°C / -15°C <sup>4)</sup>	kW	— / —	— / —
COP <sup>1)</sup>	Nominal (Min - Max) W/W	4,15 (5,12 - 3,45)	4,10 (4,66 - 3,41)
<b>SCOP <sup>2)</sup></b>	<b>W/W</b>	<b>4,30A+</b>	<b>3,87</b>
Pdesign at -10°C	kW	10,00	12,50
Input power heating	Nominal (Min - Max) kW	2,41 (0,41 - 4,00)	3,05 (0,73 - 4,40)
Annual energy consumption <sup>3)</sup>	kWh/a	3256	—
<b>Indoor unit</b>	<b>S-100PU2E5B</b>	<b>S-125PU2E5B</b>	<b>S-140PU2E5B</b>
Air volume	Hi / Med / Lo m <sup>3</sup> /min	36,00/26,00/18,00	37,00/27,00/19,00
Sound pressure <sup>5)</sup>	Hi / Med / Lo dB(A)	45/38/32	46/39/33
Dimension	Indoor (H x W x D) mm	319 x 840 x 840	319 x 840 x 840
	Panel (H x W x D) mm	33,5 x 950 x 950	33,5 x 950 x 950
Net weight	Indoor / Panel kg	25 / 5	25 / 5
<b>Outdoor unit</b>	<b>U-100PEY1E8</b>	<b>U-125PEY1E8</b>	<b>U-140PEY1E8</b>
Power source	V	380/400/415	380/400/415
Recommended fuse	A	16	16
Connection indoor / outdoor	mm <sup>2</sup>	2,5	2,5
Current	Cool A	5,00/4,75/4,60	6,20/5,90/5,70
	Heat A	3,80/3,60/3,50	4,75/4,50/4,35
Air volume	Cool / Heat m <sup>3</sup> /min	76/67	80/73
Sound pressure	Cool / Heat (Hi) dB(A)	54/54	56/56
Dimension	H x W x D mm	996 x 940 x 340	996 x 940 x 340
Net weight	kg	73	85
Piping connections	Liquid pipe Inch (mm)	3/8 (9,52)	3/8 (9,52)
	Gas pipe Inch (mm)	5/8 (15,88)	5/8 (15,88)
Pipe length range	m	5 - 50	5 - 50
Elevation difference (in/out) <sup>6)</sup>	m	30	30
Pipe length for additional gas	m	30	30
Additional gas amount	g/m	50	50
Refrigerant (R410A)	kg/TCO <sub>2</sub> Eq.	2,60/5,4288	3,20/6,6816
Operating range	Cool Min ~ Max °C	-10 ~ +43	-10 ~ +43
	Heat Min ~ Max °C	-15 ~ +24	-15 ~ +24

1) EER and COP calculation is based in accordance to EN14511. 2) For models below 12kW, the SEER and SCOP is calculated based on values of EU/626/2011. For models above 12kW, the SEER and SCOP is calculated based on values of EU/2281/2016. 3) The annual energy consumption is calculated in accordance to EU/626/2011. 4) Heating capacity is calculated including defrost factor correction. 5) The sound pressure of the units shows the value measured of a position 1m in front of the main body and 1,5m from the ground. The sound pressure is measured in accordance with Eurovent 6/C/006-97 specification. 6) When installing the outdoor unit at a higher position than the indoor unit.\* Recommended fuse for the indoor 3A.



SEER and SCOP: For KIT-100PUY2E5D. ECONAVI and INTERNET CONTROL: Optional. Compatible with all Panasonic connectivity solutions. For detailed information go to the Control Systems section.

Rating Conditions: Cooling Indoor 27°C DB / 19°C WB. Cooling Outdoor 35°C DB / 24°C WB. Heating Indoor 20°C DB. Heating Outdoor 7°C DB / 6°C WB. (DB: Dry Bulb; WB: Wet Bulb) Specifications subject to change without notice. For detailed information about ErP, please visit our websites www.aircon.panasonic.eu or www.ptc.panasonic.eu.

# PACi ELITE CEILING INVERTER+ • R410A GAS



Ceiling mounted units provide large and wide air distribution which is good for big rooms. The height and depth of all capacities are the same for unified appearance in mixed installations.

High heating capacity at -7°C.

## Technical focus

- Wide air distribution for large rooms
- Horizontal air flow reaches maximum 9,5m
- Fresh air connection available on the unit
- Slim design with 235mm height fits narrow space
- Silent operation
- Datanavi simple support tool app with remote controller (CZ-RTC5B)
- Twin, Triple and Double-twin split options
- Easy connection and control of external fan or ERV using the connector PAW-FDC on the indoor unit PCB. The external device can be controlled by the remote control of the Panasonic indoor unit

			Single Phase							
			3,60kW	5,00kW	6,00kW	7,10kW	10,00kW	12,50kW	14,00kW	
KIT			KIT-36PT2E5D	KIT-50PT2E5D	KIT-60PT2E5D	KIT-71PT2E5D	KIT-100PT2E5D	KIT-125PT2E5D	KIT-140PT2E5D	
Remote controller			CZ-RTC5B	CZ-RTC5B	CZ-RTC5B	CZ-RTC5B	CZ-RTC5B	CZ-RTC5B	CZ-RTC5B	
Cooling capacity	Nominal (Min - Max)	kW	3,60(1,50 - 4,00)	5,00(1,50 - 5,60)	6,00(2,00 - 7,10)	7,10(2,50 - 8,00)	10,00(3,30 - 12,50)	12,50(3,30 - 14,00)	14,00(3,30 - 15,00)	
EER <sup>1)</sup>	Nominal (Min - Max)	W/W	4,80(6,25 - 4,49)	3,73(6,25 - 3,41)	3,73(8,00 - 3,16)	3,68(5,56 - 2,88)	3,95(3,93 - 3,25)	3,35(3,93 - 2,88)	3,01(3,93 - 2,65)	
SEER <sup>2)</sup>		W/W	6,70A++	6,50A++	6,80A++	6,20A++	6,70A++	5,76	5,36	
Pdesign		kW	3,60	5,00	6,00	7,10	10,00	12,50	14,00	
Input power cooling	Nominal (Min - Max)	kW	0,75(0,24 - 0,89)	1,34(0,24 - 1,64)	1,61(0,25 - 2,25)	1,93(0,45 - 2,78)	2,53(0,84 - 3,85)	3,73(0,84 - 4,86)	4,65(0,84 - 5,65)	
Annual energy consumption <sup>3)</sup>		kWh/a	188	269	309	965	523	—	—	
Heating capacity	Nominal (Min - Max)	kW	4,00(1,50 - 5,00)	5,60(1,50 - 6,50)	7,00(1,80 - 8,00)	8,00(2,00 - 9,00)	11,20(4,10 - 14,00)	14,00(4,10 - 16,00)	16,00(4,10 - 18,00)	
Heating capacity at -7°C / -15°C <sup>4)</sup>		kW	—/—	—/—	—/—	7,52/7,65	12,04/11,20	13,48/12,38	14,24/12,69	
COP <sup>1)</sup>	Nominal (Min - Max)	W/W	5,00(7,89 - 4,50)	4,18(7,89 - 3,78)	4,22(9,00 - 4,10)	4,15(5,00 - 3,10)	4,31(4,56 - 3,18)	3,99(4,56 - 3,07)	3,67(4,56 - 3,04)	
SCOP <sup>2)</sup>		W/W	4,30A+	4,10A+	4,10A+	4,00A+	4,30A+	3,81	3,70	
Pdesign at -10°C		kW	3,60	5,00	6,00	7,10	10,00	12,50	14,00	
Input power heating	Nominal (Min - Max)	kW	0,80(0,19 - 1,11)	1,34(0,19 - 1,72)	1,66(0,20 - 1,95)	1,93(0,40 - 2,90)	2,60(0,90 - 4,40)	3,51(0,90 - 5,21)	4,36(0,90 - 5,93)	
Annual energy consumption <sup>3)</sup>		kWh/a	1172	1707	2050	2485	3256	—	—	
Indoor unit			S-36PT2E5B	S-50PT2E5B	S-60PT2E5B	S-71PT2E5B	S-100PT2E5B	S-125PT2E5B	S-140PT2E5B	
Air volume	Hi / Med / Lo	m <sup>3</sup> /min	14,00/12,00/10,50	15,00/12,50/10,50	20,00/17,00/14,50	21,00/18,00/15,50	30,00/25,00/23,00	34,00/28,00/24,00	35,00/29,00/25,00	
Sound pressure <sup>5)</sup>	Hi / Med / Lo	dB(A)	36/32/29	37/33/29	38/34/30	39/35/31	42/37/35	46/40/36	47/41/37	
Dimension	HxWxD	mm	235x960x690	235x960x690	235x1275x690	235x1275x690	235x1590x690	235x1590x690	235x1590x690	
Net weight		kg	27	27	33	33	40	40	40	
Outdoor unit			U-36PE2E5A	U-50PE2E5A	U-60PE2E5A	U-71PE1E5A	U-100PE1E5A	U-125PE1E5A	U-140PE1E5A	
Power source		V	220/230/240	220/230/240	220/230/240	220/230/240	220/230/240	220/230/240	220/230/240	
Recommended fuse		A	—	—	—	20	25	30	16	
Connection indoor / outdoor		mm <sup>2</sup>	—	—	—	2,5	4,0	6,0	2,5	
Current	Cool	A	3,55/3,40/3,25	6,30/6,00/5,75	7,90/7,50/7,20	9,00/8,70/8,40	11,50/11,10/10,60	17,00/16,40/15,80	21,20/20,50/19,80	
	Heat	A	3,80/3,65/3,50	6,35/6,10/5,80	8,15/7,80/7,45	8,90/8,60/8,30	11,80/11,40/11,00	16,00/15,40/14,90	19,80/19,20/18,50	
Air volume	Cool / Heat	m <sup>3</sup> /min	38/38	38/41	38/41	60/60	110/95	130/110	135/120	
Sound pressure	Cool / Heat (Hi)	dB(A)	45/46	46/48	46/49	48/50	52/52	53/53	54/55	
Dimension	HxWxD	mm	619x799x299	619x799x299	619x799x299	996x940x340	1416x940x340	1416x940x340	1416x940x340	
Net weight		kg	39	39	40	69	98	98	98	
Piping connections	Liquid pipe	Inch (mm)	1/4(6,35)	1/4(6,35)	3/8(9,52)	3/8(9,52)	3/8(9,52)	3/8(9,52)	3/8(9,52)	
	Gas pipe	Inch (mm)	1/2(12,70)	1/2(12,70)	5/8(15,88)	5/8(15,88)	5/8(15,88)	5/8(15,88)	5/8(15,88)	
Pipe length range		m	3~40	3~40	3~40	5~50	5~75	5~75	5~75	
Elevation difference (in/out) <sup>6)</sup>		m	30	30	30	30	30	30	30	
Pipe length for additional gas		m	30	30	30	30	30	30	30	
Additional gas amount		g/m	20	20	40	50	50	50	50	
Refrigerant (R410A)		kg/TCO <sub>2</sub> Eq.	1,40/2,9232	1,40/2,9232	1,95/4,0716	2,35/4,9068	3,40/7,0992	3,40/7,0992	3,40/7,0992	
Operating range	Cool Min ~ Max	°C	-15 ~ +46	-15 ~ +46	-15 ~ +46	-15 ~ +46	-15 ~ +46	-15 ~ +46	-15 ~ +46	
	Heat Min ~ Max	°C	-20 ~ +24	-20 ~ +24	-20 ~ +24	-20 ~ +24	-20 ~ +24	-20 ~ +24	-20 ~ +24	

## Accessories

<b>CZ-RTC5B</b>	Wired remote controller with Econavi button and datanavi
<b>CZ-RWS3 + CZ-RWRT3</b>	Wireless remote controller
<b>CZ-RE2C2</b>	Simplified remote controller
<b>PAW-WTRAY</b>	Tray for condenser water compatible with base ground support
<b>PAW-GRDBSE20</b>	Outdoor base ground support for noise and vibration absorption

## Accessories

<b>PAW-GRDSTD40</b>	Outdoor elevation platform 400x900x400mm
<b>PAW-WPH7</b>	Wind protection shield for U-100/125/140PE1E5A/8A and U-140PEY1E8
<b>PAW-WPH9</b>	Wind protection shield for U-71PE1E5A/8A and U-100/125PEY1E5/8



PACi Kits

R410A



**Further comfort improvement with airflow distribution**

Horizontal air flow reaches maximum 9,5m. This is ideal for wide rooms.

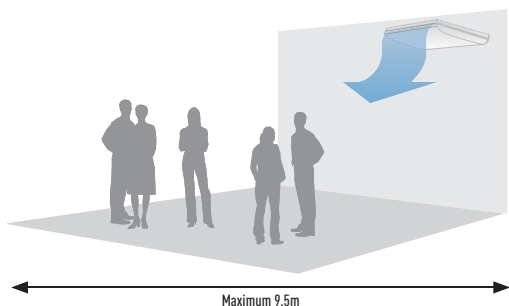

The wide air discharge opening expands the air flow to the left and the right. The unpleasant feeling caused when the air flow directly hits the human body is prevented by the "Draft prevention position", which changes the swing width, so that the degree of comfort is increased.

**Air distribution is altered depending on the operational mode of the unit**

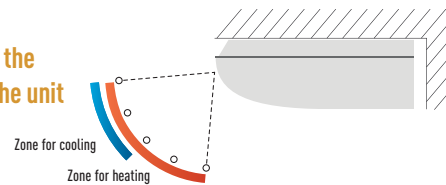

			Three Phase			
			7,10kW	10,00kW	12,50kW	14,00kW
KIT			KIT-71PT2E8D	KIT-100PT2E8D	KIT-125PT2E8D	KIT-140PT2E8D
Remote controller			CZ-RTCSB	CZ-RTCSB	CZ-RTCSB	CZ-RTCSB
Cooling capacity	Nominal (Min - Max)	kW	7,10 (2,50 - 8,00)	10,00 (3,30 - 12,50)	12,50 (3,30 - 14,00)	14,00 (3,30 - 15,00)
EER <sup>1)</sup>	Nominal (Min - Max)	W/W	3,68 (5,56 - 2,88)	3,95 (3,93 - 3,25)	3,35 (3,93 - 2,88)	3,01 (3,93 - 2,65)
SEER <sup>2)</sup>		W/W	<b>5,90A+</b>	<b>6,60A+</b>	<b>5,74</b>	<b>5,34</b>
Pdesign		kW	7,10	10,00	12,50	14,00
Input power cooling	Nominal (Min - Max)	kW	1,93 (0,45 - 2,78)	2,53 (0,84 - 3,85)	3,73 (0,84 - 4,86)	4,65 (0,84 - 5,65)
Annual energy consumption <sup>3)</sup>		kWh/a	421	531	—	—
Heating capacity	Nominal (Min - Max)	kW	8,00 (2,00 - 9,00)	11,20 (4,10 - 14,00)	14,00 (4,10 - 16,00)	16,00 (4,10 - 18,00)
Heating capacity at -7°C / -15°C <sup>4)</sup>		kW	7,52 / 7,65	12,04 / 11,20	13,48 / 12,38	14,24 / 12,69
COP <sup>1)</sup>	Nominal (Min - Max)	W/W	4,15 (5,00 - 3,10)	4,31 (4,56 - 3,18)	3,99 (4,56 - 3,07)	3,67 (4,56 - 3,04)
SCOP <sup>2)</sup>		W/W	<b>4,00A+</b>	<b>4,30A+</b>	<b>3,81</b>	<b>3,70</b>
Pdesign at -10°C		kW	7,10	10,00	12,50	14,00
Input power heating	Nominal (Min - Max)	kW	1,93 (0,40 - 2,90)	2,60 (0,90 - 4,40)	3,51 (0,90 - 5,21)	4,36 (0,90 - 5,93)
Annual energy consumption <sup>3)</sup>		kWh/a	2485	3256	—	—
Indoor unit			S-71PT2E5B	S-100PT2E5B	S-125PT2E5B	S-140PT2E5B
Air volume	Hi / Med / Lo	m <sup>3</sup> /min	21,00 / 18,00 / 15,50	30,00 / 25,00 / 23,00	34,00 / 28,00 / 24,00	35,00 / 29,00 / 25,00
Sound pressure <sup>5)</sup>	Hi / Med / Lo	dB(A)	39 / 35 / 31	42 / 37 / 35	46 / 40 / 36	47 / 41 / 37
Dimension	H x W x D	mm	235 x 1275 x 690	235 x 1590 x 690	235 x 1590 x 690	235 x 1590 x 690
Net weight		kg	33	40	40	40
Outdoor unit			U-71PE1E8A	U-100PE1E8A	U-125PE1E8A	U-140PE1E8A
Power source		V	380 / 400 / 415	380 / 400 / 415	380 / 400 / 415	380 / 400 / 415
Recommended fuse		A	16	16	16	16
Connection indoor / outdoor		mm <sup>2</sup>	2,5	2,5	2,5	2,5
Current	Cool	A	3,00 / 2,90 / 2,80	3,95 / 3,75 / 3,65	5,85 / 5,55 / 5,35	7,30 / 6,95 / 6,70
	Heat	A	3,00 / 2,90 / 2,80	4,05 / 3,85 / 3,75	5,50 / 5,20 / 5,05	6,85 / 6,50 / 6,25
Air volume	Cool / Heat	m <sup>3</sup> /min	60 / 60	110 / 95	130 / 110	135 / 120
Sound pressure	Cool / Heat (Hi)	dB(A)	48 / 50	52 / 52	53 / 53	54 / 55
Dimension	H x W x D	mm	996 x 940 x 340	1416 x 940 x 340	1416 x 940 x 340	1416 x 940 x 340
Net weight		kg	71	98	98	98
Piping connections	Liquid pipe	Inch (mm)	3/8 (9,52)	3/8 (9,52)	3/8 (9,52)	3/8 (9,52)
	Gas pipe	Inch (mm)	5/8 (15,88)	5/8 (15,88)	5/8 (15,88)	5/8 (15,88)
Pipe length range		m	5 - 50	5 - 75	5 - 75	5 - 75
Elevation difference (in/out) <sup>6)</sup>		m	30	30	30	30
Pipe length for additional gas		m	30	30	30	30
Additional gas amount		g/m	50	50	50	50
Refrigerant (R410A)		kg / TCO <sub>2</sub> Eq.	2,35 / 4,9068	3,40 / 7,0992	3,40 / 7,0992	3,40 / 7,0992
Operating range	Cool Min ~ Max	°C	-15 ~ +46	-15 ~ +46	-15 ~ +46	-15 ~ +46
	Heat Min ~ Max	°C	-20 ~ +24	-20 ~ +24	-20 ~ +24	-20 ~ +24

1) EER and COP calculation is based in accordance to EN14511. 2) For models below 12kW, the SEER and SCOP is calculated based on values of EU/626/2011. For models above 12kW, the SEER and SCOP is calculated based on values of EU/2281/2016. 3) The annual energy consumption is calculated in accordance to EU/626/2011. 4) Heating capacity is calculated including defrost factor correction. 5) The sound pressure of the units shows the value measured of a position 1m in front of the main body and 1,5m from the ground. The sound pressure is measured in accordance with Eurovent 6/C/006-97 specification. 6) When installing the outdoor unit at a higher position than the indoor unit. \* Recommended fuse for the indoor 3A.



SEER: For KIT-60PT2E5D. SCOP: For KIT-36PT2E5D and KIT-100PT2E5D. INTERNET CONTROL: Optional. Compatible with all Panasonic connectivity solutions. For detailed information go to the Control Systems section.

Rating Conditions: Cooling Indoor 27°C DB / 19°C WB. Cooling Outdoor 35°C DB / 24°C WB. Heating Indoor 20°C DB. Heating Outdoor 7°C DB / 6°C WB. (DB: Dry Bulb; WB: Wet Bulb) Specifications subject to change without notice. For detailed information about ErP, please visit our websites www.aircon.panasonic.eu or www.gtc.panasonic.eu.

## PACi STANDARD CEILING INVERTER+

### • R410A GAS



Ceiling mounted units provide large and wide air distribution which is good for big rooms. The height and depth of all capacities are the same for unified appearance in mixed installations.

#### Technical focus

- Wide air distribution for large rooms
- Horizontal air flow reaches maximum 9,5m
- Fresh air connection available on the unit
- Slim design with 235mm height fits narrow space
- Silent operation
- Datanavi simple support tool app with remote controller (CZ-RTC5B)
- Twin, Triple and Double-twin split options
- Easy connection and control of external fan or ERV using the connector PAW-FDC on the indoor unit PCB. The external device can be controlled by the remote control of the Panasonic indoor unit

			Single Phase			
			6,00kW	7,10kW	10,00kW	12,50kW
KIT			KIT-60PTY2E5D	KIT-71PTY2E5D	KIT-100PTY2E5D	KIT-125PTY2E5D
Remote controller			CZ-RTC5B	CZ-RTC5B	CZ-RTC5B	CZ-RTC5B
Cooling capacity	Nominal (Min - Max)	kW	6,00 [2,00 - 7,10]	7,10 [2,00 - 7,70]	10,00 [2,70 - 11,50]	12,50 [3,80 - 13,50]
EER <sup>1)</sup>	Nominal (Min - Max)	W/W	3,68 [8,00 - 3,16]	3,21 [8,00 - 2,91]	3,01 [5,09 - 2,65]	3,01 [4,22 - 2,62]
SEER <sup>2)</sup>		W/W	6,70A++	6,10A++	6,10A++	5,26
Pdesign		kW	6,00	7,10	10,00	12,50
Input power cooling	Nominal (Min - Max)	kW	1,63 [0,25 - 2,25]	2,21 [0,25 - 2,65]	3,32 [0,53 - 4,34]	4,15 [0,90 - 5,16]
Annual energy consumption <sup>3)</sup>		kWh/a	313	407	574	—
Heating capacity	Nominal (Min - Max)	kW	6,00 [1,80 - 7,00]	7,10 [1,80 - 8,10]	10,00 [2,10 - 13,80]	12,50 [3,40 - 15,00]
Heating capacity at -7°C / -15°C <sup>4)</sup>		kW	— / —	— / —	9,97 / 8,43	10,97 / 9,03
COP <sup>1)</sup>	Nominal (Min - Max)	W/W	4,35 [9,00 - 4,38]	4,23 [9,00 - 3,77]	3,85 [5,12 - 3,45]	3,85 [4,66 - 3,41]
SCOP <sup>2)</sup>		W/W	4,00A+	4,00A+	3,90A	3,58
Pdesign at -10°C		kW	6,00	6,00	10,00	12,50
Input power heating	Nominal (Min - Max)	kW	1,38 [0,20 - 1,60]	1,68 [0,20 - 2,15]	2,60 [0,41 - 4,00]	3,25 [0,73 - 4,40]
Annual energy consumption <sup>3)</sup>		kWh/a	2100	2100	3590	—
Indoor unit			S-60PT2E5B	S-71PT2E5B	S-100PT2E5B	S-125PT2E5B
Air volume	Hi / Med / Lo	m <sup>3</sup> /min	20,00 / 17,00 / 14,50	21,00 / 18,00 / 15,50	30,00 / 25,00 / 23,00	34,00 / 28,00 / 24,00
Sound pressure <sup>5)</sup>	Hi / Med / Lo	dB(A)	38 / 34 / 30	39 / 35 / 31	42 / 37 / 35	46 / 40 / 36
Dimension	HxWxD	mm	235 x 1275 x 690	235 x 1275 x 690	235 x 1590 x 690	235 x 1590 x 690
Net weight		kg	33	33	40	40
Outdoor unit			U-60PEY2E5	U-71PEY2E5	U-100PEY1E5	U-125PEY1E5
Power source		V	220 / 230 / 240	220 / 230 / 240	220 / 230 / 240	220 / 230 / 240
Recommended fuse		A	—	—	25	30
Connection indoor / outdoor		mm <sup>2</sup>	—	—	4	6
Current	Cool	A	8,00 / 7,60 / 7,30	10,80 / 10,30 / 9,85	15,60 / 15,00 / 14,40	19,70 / 18,90 / 18,10
	Heat	A	6,70 / 6,45 / 6,15	8,20 / 7,85 / 7,50	11,90 / 11,50 / 11,10	15,20 / 14,60 / 13,90
Air volume	Cool / Heat	m <sup>3</sup> /min	38 / 41	44 / 41	110 / 95	80 / 73
Sound pressure	Cool / Heat (Hi)	dB(A)	46 / 48	49 / 49	52 / 52	56 / 56
Dimension	HxWxD	mm	619 x 799 x 299	619 x 799 x 299	996 x 940 x 340	996 x 940 x 340
Net weight		kg	40	40	73	85
Piping connections	Liquid pipe	Inch (mm)	3/8 [9,52]	3/8 [9,52]	3/8 [9,52]	3/8 [9,52]
	Gas pipe	Inch (mm)	5/8 [15,88]	5/8 [15,88]	5/8 [15,88]	5/8 [15,88]
Pipe length range		m	3 ~ 40	3 ~ 40	5 ~ 50	5 ~ 50
Elevation difference (in/out) <sup>6)</sup>		m	30	30	30	30
Pipe length for additional gas		m	30	30	30	30
Additional gas amount		g/m	40	40	50	50
Refrigerant (R410A)		kg/TCO <sub>2</sub> Eq.	1,95 / 4,0716	1,95 / 4,0716	2,60 / 5,4288	3,20 / 6,6816
Operating range	Cool Min ~ Max	°C	-10 ~ +43	-10 ~ +43	-10 ~ +43	-10 ~ +43
	Heat Min ~ Max	°C	-15 ~ +24	-15 ~ +24	-15 ~ +24	-15 ~ +24

#### Accessories

<b>CZ-RTC5B</b>	Wired remote controller with Econavi button and datanavi
<b>CZ-RWS3 + CZ-RWRT3</b>	Wireless remote controller
<b>CZ-RE2C2</b>	Simplified remote controller
<b>PAW-WTRAY</b>	Tray for condenser water compatible with base ground support
<b>PAW-GRDBSE20</b>	Outdoor base ground support for noise and vibration absorption

#### Accessories

<b>PAW-GRDSTD40</b>	Outdoor elevation platform 400 x 900 x 400mm
<b>PAW-WPH7</b>	Wind protection shield for U-100/125/140PE1E5A/8A and U-140PEY1E8
<b>PAW-WPH9</b>	Wind protection shield for U-71PE1E5A/8A and U-100/125PEY1E5/8



PACi Kits

R410A



Further comfort improvement with airflow distribution

Horizontal air flow reaches maximum 9,5m. This is ideal for wide rooms.

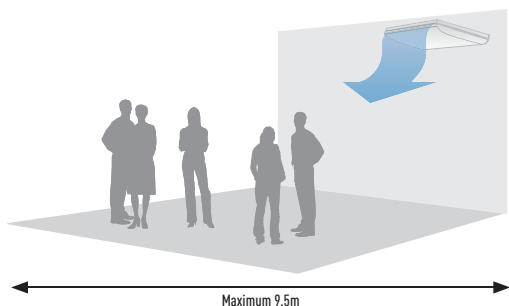

The wide air discharge opening expands the air flow to the left and the right. The unpleasant feeling caused when the air flow directly hits the human body is prevented by the "Draft prevention position", which changes the swing width, so that the degree of comfort is increased.

Air distribution is altered depending on the operational mode of the unit

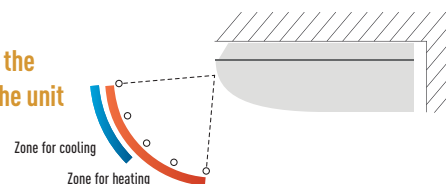

KIT	Three Phase			
	10,00kW	12,50kW	14,00kW	
<b>Remote controller</b>	<b>KIT-100PTY2E8D</b>	<b>KIT-125PTY2E8D</b>	<b>KIT-140PTY2E8D</b>	
	<b>CZ-RTCSB</b>	<b>CZ-RTCSB</b>	<b>CZ-RTCSB</b>	
Cooling capacity	Nominal (Min - Max) kW	10,00 [2,70 - 11,50]	12,50 [3,80 - 13,50]	14,00 [3,30 - 15,00]
EER <sup>1)</sup>	Nominal (Min - Max) W/W	3,01 [5,09 - 2,65]	3,01 [4,22 - 2,62]	2,98 [3,93 - 2,63]
<b>SEER <sup>2)</sup></b>	<b>W/W</b>	<b>6,00 A+</b>	<b>5,24</b>	<b>5,25</b>
Pdesign	kW	10,00	12,50	14,00
Input power cooling	Nominal (Min - Max) kW	3,32 [0,53 - 4,34]	4,15 [0,90 - 5,16]	4,70 [0,84 - 5,70]
Annual energy consumption <sup>3)</sup>	kWh/a	584	—	—
Heating capacity	Nominal (Min - Max) kW	10,00 [2,10 - 13,80]	12,50 [3,40 - 15,00]	14,00 [4,10 - 16,00]
Heating capacity at -7°C / -15°C <sup>4)</sup>	kW	9,97 / 8,43	10,97 / 9,03	13,35 / 12,38
COP <sup>1)</sup>	Nominal (Min - Max) W/W	3,85 [5,12 - 3,45]	3,85 [4,66 - 3,41]	3,88 [4,56 - 3,07]
<b>SCOP <sup>2)</sup></b>	<b>W/W</b>	<b>3,90 A</b>	<b>3,58</b>	<b>3,57</b>
Pdesign at -10°C	kW	10,00	12,50	14,00
Input power heating	Nominal (Min - Max) kW	2,60 [0,41 - 4,00]	3,25 [0,73 - 4,40]	3,61 [0,90 - 5,21]
Annual energy consumption <sup>3)</sup>	kWh/a	3590	—	—
<b>Indoor unit</b>	<b>S-100PT2E5B</b>	<b>S-125PT2E5B</b>	<b>S-140PT2E5B</b>	
Air volume	Hi / Med / Lo m <sup>3</sup> /min	30,00 / 25,00 / 23,00	34,00 / 28,00 / 24,00	35,00 / 29,00 / 25,00
Sound pressure <sup>5)</sup>	Hi / Med / Lo dB(A)	42 / 37 / 35	46 / 40 / 36	47 / 41 / 37
Dimension	H x W x D mm	235 x 1590 x 690	235 x 1590 x 690	235 x 1590 x 690
Net weight	kg	40	40	40
<b>Outdoor unit</b>	<b>U-100PEY1E8</b>	<b>U-125PEY1E8</b>	<b>U-140PEY1E8</b>	
Power source	V	380 / 400 / 415	380 / 400 / 415	380 / 400 / 415
Recommended fuse	A	16	16	16
Connection indoor / outdoor	mm <sup>2</sup>	2,5	2,5	2,5
Current	Cool / Heat A	5,30 / 5,05 / 4,85	6,50 / 6,20 / 6,00	7,40 / 7,00 / 6,80
	A	4,10 / 3,90 / 3,75	5,10 / 4,80 / 4,65	5,65 / 5,35 / 5,15
Air volume	Cool / Heat m <sup>3</sup> /min	76 / 67	80 / 73	135 / 120
Sound pressure	Cool / Heat (Hi) dB(A)	54 / 54	56 / 56	54 / 53
Dimension	H x W x D mm	996 x 940 x 340	996 x 940 x 340	1416 x 940 x 340
Net weight	kg	73	85	98
Piping connections	Liquid pipe Inch (mm)	3/8 [9,52]	3/8 [9,52]	3/8 [9,52]
	Gas pipe Inch (mm)	5/8 [15,88]	5/8 [15,88]	5/8 [15,88]
Pipe length range	m	5 - 50	5 - 50	5 - 50
Elevation difference (in/out) <sup>6)</sup>	m	30	30	30
Pipe length for additional gas	m	30	30	30
Additional gas amount	g/m	50	50	50
Refrigerant (R410A)	kg / TCO <sub>2</sub> Eq.	2,60 / 5,4288	3,20 / 6,6816	3,40 / 7,0992
Operating range	Cool Min ~ Max °C	-10 ~ +43	-10 ~ +43	-10 ~ +43
	Heat Min ~ Max °C	-15 ~ +24	-15 ~ +24	-15 ~ +24

1) EER and COP calculation is based in accordance to EN14511. 2) For models below 12kW, the SEER and SCOP is calculated based on values of EU/626/2011. For models above 12kW, the SEER and SCOP is calculated based on values of EU/2281/2016. 3) The annual energy consumption is calculated in accordance to EU/626/2011. 4) Heating capacity is calculated including defrost factor correction. 5) The sound pressure of the units shows the value measured of a position 1m in front of the main body and 1,5m from the ground. The sound pressure is measured in accordance with Eurovent 6/C/006-97 specification. 6) When installing the outdoor unit at a higher position than the indoor unit.\* Recommended fuse for the indoor 3A.



SEER and SCOP: For KIT-60PTY2E5D. INTERNET CONTROL: Optional. Compatible with all Panasonic connectivity solutions. For detailed information go to the Control Systems section.

Rating Conditions: Cooling Indoor 27°C DB / 19°C WB. Cooling Outdoor 35°C DB / 24°C WB. Heating Indoor 20°C DB. Heating Outdoor 7°C DB / 6°C WB. (DB: Dry Bulb; WB: Wet Bulb) Specifications subject to change without notice. For detailed information about ErP, please visit our websites www.aircon.panasonic.eu or www.gtc.panasonic.eu.

**PACi ELITE HIGH STATIC PRESSURE HIDE AWAY INVERTER+ • R410A GAS**



The ducted systems are the ideal solution for flexible, concealed air conditioning and the optional 200mm spigots ensure simple, hassle-free connection to spiral ductwork.

High heating capacity at -7°C.

**Technical focus**

- High ESP (external static pressure) up to 150 Pa
- Automatic learning function for the required static pressure on site during commissioning (a standard wired remote controller is required)
- Quiet operation from 25dB(A)
- DC FAN for better efficiency and control
- Built in drain pump
- Datanavi simple support tool app with remote controller (CZ-RTC5B)
- Twin, triple and double-twin split options
- Easy connection and control of external fan or ERV using the connector PAW-FDC on the indoor unit PCB. The external device can be controlled by the remote control of the Panasonic indoor unit

			Single Phase						
			3,60kW	5,00kW	6,00kW	7,10kW	10,00kW	12,50kW	14,00kW
KIT			KIT-36PF1E5D	KIT-50PF1E5D	KIT-60PF1E5D	KIT-71PF1E5D	KIT-100PF1E5D	KIT-125PF1E5D	KIT-140PF1E5D
Remote controller			CZ-RTC5B	CZ-RTC5B	CZ-RTC5B	CZ-RTC5B	CZ-RTC5B	CZ-RTC5B	CZ-RTC5B
Cooling capacity	Nominal (Min - Max)	kW	3,60(1,50 - 4,00)	5,00(1,50 - 5,60)	6,00(2,00 - 7,10)	7,10(2,50 - 8,00)	10,00(3,30 - 12,50)	12,50(3,30 - 14,00)	14,00(3,30 - 15,50)
EER <sup>1)</sup>	Nominal (Min - Max)	W/W	4,44(5,17 - 4,00)	3,85(5,17 - 3,50)	3,64(5,97 - 3,02)	3,84(4,72 - 3,02)	4,10(3,93 - 3,38)	3,50(3,93 - 3,04)	3,25(3,93 - 2,58)
SEER <sup>2)</sup>		W/W	<b>5,70A+</b>	<b>5,70A+</b>	<b>6,10A++</b>	<b>6,40A++</b>	<b>5,80A+</b>	<b>5,57</b>	<b>5,41</b>
Pdesign		kW	3,60	5,00	6,00	7,10	10,00	12,50	14,00
Input power cooling	Nominal (Min - Max)	kW	0,81(0,29 - 1,00)	1,30(0,29 - 1,60)	1,65(0,34 - 2,35)	1,85(0,53 - 2,65)	2,44(0,84 - 3,70)	3,57(0,84 - 4,60)	4,31(0,84 - 6,00)
Annual energy consumption <sup>3)</sup>		kWh/a	221	307	344	388	603	—	—
Heating capacity	Nominal (Min - Max)	kW	4,00(1,50 - 5,00)	5,60(1,50 - 6,50)	7,00(1,80 - 8,00)	8,00(2,00 - 9,00)	11,20(4,10 - 14,00)	14,00(4,10 - 16,00)	16,00(4,10 - 18,00)
Heating capacity at -7°C / -15°C <sup>4)</sup>		kW	— / —	— / —	— / —	— / —	— / —	— / —	12,32 / —
COP <sup>1)</sup>	Nominal (Min - Max)	W/W	4,55(6,25 - 4,17)	4,03(6,25 - 3,71)	4,00(6,32 - 3,81)	3,85(4,17 - 3,10)	4,31(4,56 - 3,18)	4,02(4,56 - 3,08)	3,60(4,56 - 3,05)
SCOP <sup>2)</sup>		W/W	<b>3,90A</b>	<b>3,90A</b>	<b>4,00A+</b>	<b>4,00A+</b>	<b>3,80A</b>	<b>3,72</b>	<b>3,63</b>
Pdesign at -10°C		kW	3,60	4,00	6,00	7,10	10,00	12,50	14,00
Input power heating	Nominal (Min - Max)	kW	0,88(0,24 - 1,20)	1,39(0,24 - 1,75)	1,75(0,29 - 2,10)	2,08(0,48 - 2,90)	2,60(0,90 - 4,40)	3,48(0,90 - 5,20)	4,44(0,90 - 5,90)
Annual energy consumption <sup>3)</sup>		kWh/a	1292	1436	2100	2485	3684	—	—
Indoor unit			S-36PF1E5B	S-50PF1E5B	S-60PF1E5B	S-71PF1E5B	S-100PF1E5B	S-125PF1E5B	S-140PF1E5B
External static pressure <sup>5)</sup>	Nominal (Min - Max)	Pa	70(10 - 150)	70(10 - 150)	70(10 - 150)	70(10 - 150)	100(10 - 150)	100(10 - 150)	100(10 - 150)
Air volume	Hi / Med / Lo	m <sup>3</sup> /min	14,00/13,00/10,00	16,00/15,00/12,00	21,00/19,00/15,00	21,00/19,00/15,00	32,00/26,00/21,00	34,00/29,00/23,00	36,00/32,00/25,00
Sound pressure <sup>6)</sup>	Hi / Med / Lo	dB(A)	33/29/25	34/30/26	35/32/26	35/32/26	38/34/31	39/35/32	40/36/33
Dimension	H x W x D	mm	290 x 800 x 700	290 x 800 x 700	290 x 1000 x 700	290 x 1000 x 700	290 x 1400 x 700	290 x 1400 x 700	290 x 1400 x 700
Net weight		kg	28	28	33	33	45	45	45
Outdoor unit			U-36PE2E5A	U-50PE2E5A	U-60PE2E5A	U-71PE1E5A	U-100PE1E5A	U-125PE1E5A	U-140PE1E5A
Power source		V	220/230/240	220/230/240	220/230/240	220/230/240	220/230/240	220/230/240	220/230/240
Recommended fuse		A	—	—	—	20	25	30	16
Connection indoor / outdoor		mm <sup>2</sup>	—	—	—	2,5	4,0	6,0	2,5
Current	Cool	A	3,70/3,50/3,40	5,80/5,60/5,30	7,70/7,40/7,10	8,90/8,60/8,30	11,00/10,60/10,30	16,60/15,90/15,30	20,10/19,30/18,60
	Heat	A	4,05/3,85/3,70	6,30/6,05/5,80	8,25/7,85/7,55	9,90/9,50/9,20	11,60/11,20/10,70	16,30/15,80/15,10	19,90/19,10/18,40
Air volume	Cool / Heat	m <sup>3</sup> /min	38/38	38/41	38/41	60/60	110/95	130/110	135/120
Sound pressure	Cool / Heat (Hi)	dB(A)	45/46	46/48	46/49	48/50	52/52	53/53	54/55
Dimension	H x W x D	mm	619 x 799 x 299	619 x 799 x 299	619 x 799 x 299	996 x 940 x 340	1416 x 940 x 340	1416 x 940 x 340	1416 x 940 x 340
Net weight		kg	39	39	40	69	98	98	98
Piping connections	Liquid pipe	Inch (mm)	1/4(6,35)	1/4(6,35)	3/8(9,52)	3/8(9,52)	3/8(9,52)	3/8(9,52)	3/8(9,52)
	Gas pipe	Inch (mm)	1/2(12,70)	1/2(12,70)	5/8(15,88)	5/8(15,88)	5/8(15,88)	5/8(15,88)	5/8(15,88)
Pipe length range		m	3-40	3-40	3-40	5-50	5-75	5-75	5-75
Elevation difference (in/out) <sup>7)</sup>		m	30	30	30	30	30	30	30
Pipe length for additional gas		m	30	30	30	30	30	30	30
Additional gas amount		g/m	20	20	40	50	50	50	50
Refrigerant (R410A)		kg/TCO <sub>2</sub> Eq.	1,40/2,9232	1,40/2,9232	1,95/4,0716	2,35/4,9068	3,40/7,0992	3,40/7,0992	3,40/7,0992
Operating range	Cool Min ~ Max	°C	-15 ~ +46	-15 ~ +46	-15 ~ +46	-15 ~ +46	-15 ~ +46	-15 ~ +46	-15 ~ +46
	Heat Min ~ Max	°C	-20 ~ +24	-20 ~ +24	-20 ~ +24	-20 ~ +24	-20 ~ +24	-20 ~ +24	-20 ~ +24

Accessories	
<b>CZ-RTC5B</b>	Wired remote controller with Econavi button and datanavi
<b>CZ-RWS3 + CZ-RWRC3</b>	Wireless remote controller
<b>CZ-RE2C2</b>	Simplified remote controller
<b>PAW-WTRAY</b>	Tray for condenser water compatible with base ground support
<b>PAW-GRDBSE20</b>	Outdoor base ground support for noise and vibration absorption
<b>PAW-GRDSTD40</b>	Outdoor elevation platform 400 x 900 x 400mm

Accessories	
<b>CZ-56DAF2</b>	Air Outlet Plenum S...PF1E5B 36, 45 & 50
<b>CZ-90DAF2</b>	Air Outlet Plenum S...PF1E5B 60 & 71
<b>CZ-160DAF2</b>	Air Outlet Plenum S...PF1E5B 100, 125 & 140
<b>CZ-DUMPA90MF2</b>	Air Inlet Plenum S...PF1E5B 60 & 71
<b>CZ-DUMPA160MF2</b>	Air Inlet Plenum S...PF1E5B 100, 125 & 140



Controller. Wired remote controller CZ-RTCSB Compatible with Econavi  
 Optional Controller. Wireless remote controller CZ-RWS3 + CZ-RWRC3  
 Optional Controller. Simplified remote controller CZ-REZC2  
 Optional Econavi Sensor. CZ-CENSC1

Air Outlet Plenum (without regulation adaptor)		
	Diameters	Model
36, 45 & 50	2xØ 200	CZ-56DAF2
60 & 71	3xØ 200	CZ-90DAF2
100, 125 & 140	4xØ 200	CZ-160DAF2

Air Inlet Plenum		
	Diameters	Model
60 & 71	2xØ 250	CZ-DUMPA90MF2
100, 125 & 140	4xØ 200	CZ-DUMPA160MF2

Standardized height of 290mm for all models. Height standardization enables easy and uniform installation for models with different capacities.

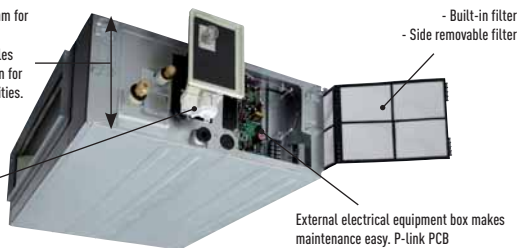

Built-in Drain pump (DC motor pump)

External electrical equipment box makes maintenance easy. P-link PCB

PACi Kits R410A



The static pressure outside the unit can be increased up to 150 Pa

Type		36	45	50	60	71	100	125	140
Standard	Pa	70	70	70	70	70	100	100	100
Maximum available setting	Pa	150	150	150	150	150	150	150	150

More powerful drain pump

Using a high-lift drain pump, drain piping can be elevated up to 785mm from the base of the unit.

			Three Phase			
			7,10kW	10,00kW	12,50kW	14,00kW
KIT			KIT-71PF1E8D	KIT-100PF1E8D	KIT-125PF1E8D	KIT-140PF1E8D
Remote controller			CZ-RTCSB	CZ-RTCSB	CZ-RTCSB	CZ-RTCSB
Cooling capacity	Nominal (Min - Max)	kW	7,10 (3,20 - 8,00)	10,00 (3,30 - 12,50)	12,50 (3,30 - 14,00)	14,00 (3,30 - 15,50)
EER <sup>1)</sup>	Nominal (Min - Max)	W/W	3,84 (5,00 - 3,02)	4,10 (3,93 - 3,38)	3,50 (3,93 - 3,04)	3,25 (3,93 - 2,58)
SEER <sup>2)</sup>		W/W	6,00A+	5,70A+	5,55	5,40
Pdesign		kW	7,10	10,00	12,50	14,00
Input power cooling	Nominal (Min - Max)	kW	1,85 (0,64 - 2,65)	2,44 (0,84 - 3,70)	3,57 (0,84 - 4,60)	4,31 (0,84 - 6,00)
Annual energy consumption <sup>3)</sup>		kWh/a	414	614	—	—
Heating capacity	Nominal (Min - Max)	kW	8,00 (2,80 - 9,00)	11,20 (4,10 - 14,00)	14,00 (4,10 - 16,00)	16,00 (4,10 - 18,00)
Heating capacity at -7°C / -15°C <sup>4)</sup>		kW	— / —	— / —	— / —	12,32 / —
COP <sup>1)</sup>	Nominal (Min - Max)	W/W	3,85 (4,83 - 3,10)	4,31 (4,56 - 3,18)	4,02 (4,56 - 3,08)	3,60 (4,56 - 3,05)
SCOP <sup>2)</sup>		W/W	3,90A	3,80A	3,72	3,63
Pdesign at -10°C		kW	7,10	10,00	12,50	14,00
Input power heating	Nominal (Min - Max)	kW	2,08 (0,58 - 2,90)	2,60 (0,90 - 4,40)	3,48 (0,90 - 5,20)	4,44 (0,90 - 5,90)
Annual energy consumption <sup>3)</sup>		kWh/a	2548	3684	—	—
Indoor unit			S-71PF1E5B	S-100PF1E5B	S-125PF1E5B	S-140PF1E5B
External static pressure <sup>5)</sup>	Nominal (Min - Max)	Pa	70 (10 - 150)	100 (10 - 150)	100 (10 - 150)	100 (10 - 150)
Air volume	Hi / Med / Lo	m <sup>3</sup> /min	21,00 / 19,00 / 15,00	32,00 / 26,00 / 21,00	34,00 / 29,00 / 23,00	36,00 / 32,00 / 25,00
Sound pressure <sup>6)</sup>	Hi / Med / Lo	dB(A)	35 / 32 / 26	38 / 34 / 31	39 / 35 / 32	40 / 36 / 33
Dimension	H x W x D	mm	290 x 1000 x 700	290 x 1400 x 700	290 x 1400 x 700	290 x 1400 x 700
Net weight		kg	33	45	45	45
Outdoor unit			U-71PE1E8A	U-100PE1E8A	U-125PE1E8A	U-140PE1E8A
Power source		V	380 / 400 / 415	380 / 400 / 415	380 / 400 / 415	380 / 400 / 415
Recommended fuse		A	16	16	16	16
Connection indoor / outdoor		mm <sup>2</sup>	2,5	2,5	2,5	2,5
Current	Cool	A	2,75 / 2,65 / 2,60	3,68 / 3,53 / 3,43	5,52 / 5,29 / 5,12	6,69 / 6,42 / 6,18
	Heat	A	3,10 / 3,00 / 2,90	3,86 / 3,70 / 3,58	5,44 / 5,26 / 5,05	6,64 / 6,35 / 6,15
Air volume	Cool / Heat	m <sup>3</sup> /min	60 / 60	110 / 95	130 / 110	135 / 120
Sound pressure	Cool / Heat (Hi)	dB(A)	48 / 50	52 / 52	53 / 53	54 / 55
Dimension	H x W x D	mm	996 x 940 x 340	1416 x 940 x 340	1416 x 940 x 340	1416 x 940 x 340
Net weight		kg	71	98	98	98
Piping connections	Liquid pipe	Inch (mm)	3/8 (9,52)	3/8 (9,52)	3/8 (9,52)	3/8 (9,52)
	Gas pipe	Inch (mm)	5/8 (15,88)	5/8 (15,88)	5/8 (15,88)	5/8 (15,88)
Pipe length range		m	5 - 50	5 - 75	5 - 75	5 - 75
Elevation difference (in/out) <sup>7)</sup>		m	30	30	30	30
Pipe length for additional gas		m	30	30	30	30
Additional gas amount		g/m	50	50	50	50
Refrigerant (R410A)		kg/TCO <sub>2</sub> Eq.	2,35 / 4,9068	3,40 / 7,0992	3,40 / 7,0992	3,40 / 7,0992
Operating range	Cool Min ~ Max	°C	-15 ~ +46	-15 ~ +46	-15 ~ +46	-15 ~ +46
	Heat Min ~ Max	°C	-20 ~ +24	-20 ~ +24	-20 ~ +24	-20 ~ +24

1) EER and COP calculation is based in accordance to EN14511. 2) For models below 12kW, the SEER and SCOP is calculated based on values of EU/626/2011. For models above 12kW, the SEER and SCOP is calculated based on values of EU/2281/2016. 3) The annual energy consumption is calculated in accordance to EU/626/2011. 4) Heating capacity is calculated including defrost factor correction. 5) Medium external static pressure setting from factory. 6) The sound pressure of the units shows the value measured of a position 1m in front of the main body and 1,5m from the ground. The sound pressure is measured in accordance with Eurovent 6/C/006-97 specification. 7) When installing the outdoor unit at a higher position than the indoor unit.\* Recommended fuse for the indoor 3A.



SEER and SCOP: For KIT-71PF1E5D. INTERNET CONTROL: Optional. Compatible with all Panasonic connectivity solutions. For detailed information go to the Control Systems section.

Rating Conditions: Cooling Indoor 27°C DB / 19°C WB. Cooling Outdoor 35°C DB / 24°C WB. Heating Indoor 20°C DB. Heating Outdoor 7°C DB / 6°C WB. (DB: Dry Bulb; WB: Wet Bulb) Specifications subject to change without notice. For detailed information about ErP, please visit our websites www.aircon.panasonic.eu or www.gtc.panasonic.eu.

## PACi STANDARD HIGH STATIC PRESSURE HIDE AWAY INVERTER+ • R410A GAS



The ducted systems are the ideal solution for flexible, concealed air conditioning and the optional 200mm spigots ensure simple, hassle-free connection to spiral ductwork.

### Technical focus

- High ESP (external static pressure) up to 150 Pa
- Automatic learning function for the required static pressure on site during commissioning (a standard wired remote controller is required)
- Quiet operation from 26dB(A)
- DC FAN for better efficiency and control
- Built in drain pump
- Datanavi simple support tool app with remote controller (CZ-RTC5B)
- Twin split options
- Easy connection and control of external fan or ERV using the connector PAW-FDC on the indoor unit PCB. The external device can be controlled by the remote control of the Panasonic indoor unit

			Single Phase			
			6,00kW	7,10kW	10,00kW	12,50kW
KIT			KIT-60PFY1E5D	KIT-71PFY1E5D	KIT-100PFY1E5D	KIT-125PFY1E5D
Remote controller			CZ-RTC5B	CZ-RTC5B	CZ-RTC5B	CZ-RTC5B
Cooling capacity	Nominal (Min - Max)	kW	6,00 [2,00 - 7,10]	7,10 [2,00 - 7,70]	10,00 [2,70 - 11,50]	12,50 [3,80 - 13,50]
EER <sup>1)</sup>	Nominal (Min - Max)	W/W	3,35 [5,97 - 2,85]	2,76 [5,97 - 2,48] D	3,01 [5,09 - 2,74]	3,05 [4,22 - 2,70]
SEER <sup>2)</sup>		W/W	5,50 A	5,40 A	5,40 A	5,11
P <sub>design</sub>		kW	6,00	7,10	10,00	12,50
Input power cooling	Nominal (Min - Max)	kW	1,79 [0,34 - 2,49]	2,57 [0,34 - 3,10]	3,32 [0,53 - 4,20]	4,10 [0,90 - 5,00]
Annual energy consumption <sup>3)</sup>		kWh/a	382	460	648	—
Heating capacity	Nominal (Min - Max)	kW	6,00 [1,80 - 7,00]	7,10 [1,80 - 8,10]	10,00 [2,10 - 13,80]	12,50 [3,40 - 15,00]
Heating capacity at -7°C / -15°C <sup>4)</sup>		kW	— / —	— / —	— / —	11,00 / —
COP <sup>1)</sup>	Nominal (Min - Max)	W/W	4,38 [6,32 - 4,12]	4,10 [6,32 - 3,68]	3,80 [5,12 - 3,45]	3,82 [4,66 - 3,41]
SCOP <sup>2)</sup>		W/W	4,00 A+	4,00 A+	3,80 A	3,60
P <sub>design</sub> at -10°C		kW	6,00	6,00	9,50	12,50
Input power heating	Nominal (Min - Max)	kW	1,37 [0,29 - 1,70]	1,73 [0,29 - 2,20]	2,63 [0,41 - 4,00]	3,27 [0,73 - 4,40]
Annual energy consumption <sup>3)</sup>		kWh/a	2100	2100	3500	—
<b>Indoor unit</b>			<b>S-60PF1E5B</b>	<b>S-71PF1E5B</b>	<b>S-100PF1E5B</b>	<b>S-125PF1E5B</b>
External static pressure <sup>5)</sup>	Nominal (Min - Max)	Pa	70 [10 - 150]	70 [10 - 150]	100 [10 - 150]	100 [10 - 150]
Air volume	Hi / Med / Lo	m <sup>3</sup> /min	21/19/15	21/19/15	32/26/21	34/29/23
Sound pressure <sup>6)</sup>	Hi / Med / Lo	dB(A)	35/32/26	35/32/26	38/34/31	39/35/32
Dimension	H x W x D	mm	290 x 1000 x 700	290 x 1000 x 700	290 x 1400 x 700	290 x 1400 x 700
Net weight		kg	33	33	45	45
<b>Outdoor unit</b>			<b>U-60PEY2E5</b>	<b>U-71PEY2E5</b>	<b>U-100PEY1E5</b>	<b>U-125PEY1E5</b>
Power source		V	220/230/240	220/230/240	220/230/240	220/230/240
Recommended fuse		A	—	—	25	30
Connection indoor / outdoor		mm <sup>2</sup>	—	—	4	6
Current	Cool	A	8,40/8,10/7,75	12,20/11,70/11,20	15,10/14,50/13,90	18,80/18,00/17,20
	Heat	A	6,30/6,05/5,80	8,15/7,80/7,45	11,80/11,20/10,70	14,60/14,00/13,40
Air volume	Cool / Heat	m <sup>3</sup> /min	38/41	44/41	76/67	80/73
Sound pressure	Cool / Heat (Hi)	dB(A)	46/48	49/49	54/54	56/56
Dimension	H x W x D	mm	619 x 799 x 299	619 x 799 x 299	996 x 940 x 340	996 x 940 x 340
Net weight		kg	40	40	73	85
Piping connections	Liquid pipe	Inch (mm)	3/8 (9,52)	3/8 (9,52)	3/8 (9,52)	3/8 (9,52)
	Gas pipe	Inch (mm)	5/8 (15,88)	5/8 (15,88)	5/8 (15,88)	5/8 (15,88)
Pipe length range		m	3 - 40	3 - 40	5 - 50	5 - 50
Elevation difference (in/out) <sup>7)</sup>		m	30	30	30	30
Pipe length for additional gas		m	30	30	30	30
Additional gas amount		g/m	40	40	50	50
Refrigerant (R410A)		kg/TCO <sub>2</sub> Eq.	1,95/4,0716	1,95/4,0716	2,60/5,4288	3,20/6,6816
Operating range	Cool Min ~ Max	°C	-10 ~ +43	-10 ~ +43	-10 ~ +43	-10 ~ +43
	Heat Min ~ Max	°C	-15 ~ +24	-15 ~ +24	-15 ~ +24	-15 ~ +24

### Accessories

<b>CZ-RTC5B</b>	Wired remote controller with Econavi button and datanavi
<b>CZ-RWS3 + CZ-RWRC3</b>	Wireless remote controller
<b>CZ-RE2C2</b>	Simplified remote controller
<b>PAW-WTRAY</b>	Tray for condenser water compatible with base ground support
<b>PAW-GRDBSE20</b>	Outdoor base ground support for noise and vibration absorption
<b>PAW-GRDSTD40</b>	Outdoor elevation platform 400 x 900 x 400mm

### Accessories

<b>CZ-56DAF2</b>	Air Outlet Plenum S...PF1E5B 36, 45 & 50
<b>CZ-90DAF2</b>	Air Outlet Plenum S...PF1E5B 60 & 71
<b>CZ-160DAF2</b>	Air Outlet Plenum S...PF1E5B 100, 125 & 140
<b>CZ-DUMPA90MF2</b>	Air Inlet Plenum S...PF1E5B 60 & 71
<b>CZ-DUMPA160MF2</b>	Air Inlet Plenum S...PF1E5B 100, 125 & 140

PACi Kits

R410A



Controller. Wired remote controller CZ-RTCSB Compatible with Econavi  
 Optional Controller. Wireless remote controller CZ-RWS3 + CZ-RWR3C  
 Optional Controller. Simplified remote controller CZ-REZC2  
 Optional Econavi Sensor. CZ-CENSC1



**Air Outlet Plenum (without regulation adaptor)**

	Diameters	Model
36, 45 & 50	2xØ 200	CZ-56DAF2
60 & 71	3xØ 200	CZ-90DAF2
100, 125 & 140	4xØ 200	CZ-160DAF2

**Air Inlet Plenum**

	Diameters	Model
60 & 71	2xØ 250	CZ-DUMPA90MF2
100, 125 & 140	4xØ 200	CZ-DUMPA160MF2

Standardized height of 290mm for all models. Height standardization enables easy and uniform installation for models with different capacities.

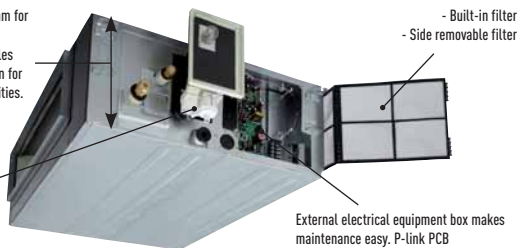

Built-in Drain pump (DC motor pump)

External electrical equipment box makes maintenance easy. P-link PCB

The static pressure outside the unit can be increased up to 150 Pa

Type		36	45	50	60	71	100	125	140
Standard	Pa	70	70	70	70	70	100	100	100
Maximum available setting	Pa	150	150	150	150	150	150	150	150

More powerful drain pump

Using a high-lift drain pump, drain piping can be elevated up to 785mm from the base of the unit.

KIT	Three Phase		
	10,00kW	12,50kW	14,00kW
<b>Remote controller</b>	<b>KIT-100PFY1E8D</b>	<b>KIT-125PFY1E8D</b>	<b>KIT-140PFY1E8D</b>
	<b>CZ-RTCSB</b>	<b>CZ-RTCSB</b>	<b>CZ-RTCSB</b>
Cooling capacity	Nominal (Min - Max) kW	10,00 (2,70 - 11,50)	12,50 (3,80 - 13,50)
EER <sup>1)</sup>	Nominal (Min - Max) W/W	3,01 (5,09 - 2,74)	3,05 (4,22 - 2,70)
<b>SEER <sup>2)</sup></b>	<b>W/W</b>	<b>5,20 A</b>	<b>5,10</b>
Pdesign	kW	10,00	12,50
Input power cooling	Nominal (Min - Max) kW	3,32 (0,53 - 4,20)	4,10 (0,90 - 5,00)
Annual energy consumption <sup>3)</sup>	kWh/a	673	—
Heating capacity	Nominal (Min - Max) kW	10,00 (2,10 - 13,80)	12,50 (3,40 - 15,00)
Heating capacity at -7°C / -15°C <sup>4)</sup>	kW	— / —	11,00 / —
COP <sup>1)</sup>	Nominal (Min - Max) W/W	3,80 (5,12 - 3,45)	3,82 (4,66 - 3,41)
<b>SCOP <sup>2)</sup></b>	<b>W/W</b>	<b>3,80 A</b>	<b>3,60</b>
Pdesign at -10°C	kW	9,50	12,50
Input power heating	Nominal (Min - Max) kW	2,63 (0,41 - 4,00)	3,27 (0,73 - 4,40)
Annual energy consumption <sup>3)</sup>	kWh/a	3500	—
<b>Indoor unit</b>	<b>S-100PF1E5B</b>	<b>S-125PF1E5B</b>	<b>S-140PF1E5B</b>
External static pressure <sup>5)</sup>	Nominal (Min - Max) Pa	100 (10 - 150)	100 (10 - 150)
Air volume	Hi / Med / Lo m <sup>3</sup> /min	32/26/21	34/29/23
Sound pressure <sup>6)</sup>	Hi / Med / Lo dB(A)	38/34/31	39/35/32
Dimension	HxWxD mm	290x1400x700	290x1400x700
Net weight	kg	45	45
<b>Outdoor unit</b>	<b>U-100PEY1E8</b>	<b>U-125PEY1E8</b>	<b>U-140PEY1E8</b>
Power source	V	380/400/415	380/400/415
Recommended fuse	A	16	16
Connection indoor / outdoor	mm <sup>2</sup>	2,5	2,5
Current	Cool A	5,10/4,85/4,70	6,20/5,90/5,70
	Heat A	4,05/3,80/3,65	4,90/4,65/4,50
Air volume	Cool / Heat m <sup>3</sup> /min	76/67	80/73
Sound pressure	Cool / Heat (Hi) dB(A)	54/54	56/56
Dimension	HxWxD mm	996x940x340	996x940x340
Net weight	kg	73	85
Piping connections	Liquid pipe Inch (mm)	3/8 (9,52)	3/8 (9,52)
	Gas pipe Inch (mm)	5/8 (15,88)	5/8 (15,88)
Pipe length range	m	5 - 50	5 - 50
Elevation difference (in/out) <sup>7)</sup>	m	30	30
Pipe length for additional gas	m	30	30
Additional gas amount	g/m	50	50
Refrigerant (R410A)	kg/TCO <sub>2</sub> Eq.	2,60/5,4288	3,20/6,6816
Operating range	Cool Min ~ Max °C	-10 ~ +43	-10 ~ +43
	Heat Min ~ Max °C	-15 ~ +24	-15 ~ +24

1) EER and COP calculation is based in accordance to EN14511. 2) For models below 12kW, the SEER and SCOP is calculated based on values of EU/626/2011. For models above 12kW, the SEER and SCOP is calculated based on values of EU/2281/2016. 3) The annual energy consumption is calculated in accordance to EU/626/2011. 4) Heating capacity is calculated including defrost factor correction. 5) Medium external static pressure setting from factory. 6) The sound pressure of the units shows the value measured of a position 1m in front of the main body and 1,5m from the ground. The sound pressure is measured in accordance with Eurovent 6/C/006-97 specification. 7) When installing the outdoor unit at a higher position than the indoor unit.\* Recommended fuse for the indoor 3A.



SEER and SCOP: KIT-60PFY1E5D. INTERNET CONTROL: Optional. Compatible with all Panasonic connectivity solutions. For detailed information go to the Control Systems section.

Rating Conditions: Cooling Indoor 27°C DB / 19°C WB. Cooling Outdoor 35°C DB / 24°C WB. Heating Indoor 20°C DB. Heating Outdoor 7°C DB / 6°C WB. (DB: Dry Bulb; WB: Wet Bulb) Specifications subject to change without notice. For detailed information about ErP, please visit our websites www.aircon.panasonic.eu or www.gtc.panasonic.eu.

## PACi ELITE LOW STATIC PRESSURE HIDE AWAY INVERTER+ • R410A GAS



The depth of only 250mm provides greater installation flexibility and the unit can be used in more applications. Ideal for sites with narrow ceiling voids.

High heating capacity at -7°C.

Ultra-slim profile: 250mm height for all models.

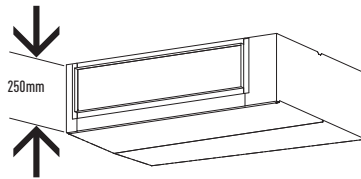

### Technical focus

- Automatic learning function for the required static pressure on site during commissioning (a standard wired remote controller is required. S-60/71/100/125/140PN1E5B models only)
- Compact indoor units without loosing static pressure (only 250mm high)
- 50 Pa static pressure
- Easy maintenance and service via external electrical box
- 3 speed centrifugal fan through wired or wireless remote control
- DC FAN for better efficiency and control
- Easy connection and control of external fan or ERV using the connector PAW-FDC on the indoor unit PCB. The external device can be controlled by the remote control of the Panasonic indoor unit

			Single Phase						
			3,60kW	5,00kW	6,00kW	7,10kW	10,00kW	12,50kW	14,00kW
KIT			KIT-36PN1E5C CZ-RTC5B	KIT-50PN1E5C CZ-RTC5B	KIT-60PN1E5C CZ-RTC5B	KIT-71PN1E5C CZ-RTC5B	KIT-100PN1E5C CZ-RTC5B	KIT-125PN1E5C CZ-RTC5B	KIT-140PN1E5C CZ-RTC5B
Remote controller									
Cooling capacity	Nominal (Min - Max)	kW	3,60(1,50 - 4,00)	5,00(1,50 - 5,60)	6,00(2,00 - 7,10)	7,10(2,50 - 8,00)	10,00(3,30 - 12,50)	12,50(3,30 - 14,00)	14,00(3,30 - 15,50)
EER <sup>1)</sup>	Nominal (Min - Max)	W/W	3,75(4,41 - 3,57)	3,21(4,41 - 2,96)	3,24(5,00 - 2,78)	3,30(4,55 - 2,91)	3,75(3,79 - 3,29)	3,21(3,30 - 2,92)	3,01(3,30 - 2,50)
SEER <sup>2)</sup>		W/W	<b>4,60B</b>	<b>4,60B</b>	<b>5,50A</b>	<b>5,50A</b>	<b>6,00A+</b>	<b>5,44</b>	<b>5,27</b>
Pdesign		kW	3,60	5,00	6,00	7,10	10,00	12,50	14,00
Input power cooling	Nominal (Min - Max)	kW	0,96(0,34 - 1,12)	1,56(0,34 - 1,89)	1,85(0,40 - 2,55)	2,15(0,55 - 2,75)	2,67(0,87 - 3,80)	3,89(1,00 - 4,80)	4,65(1,00 - 6,20)
Annual energy consumption <sup>3)</sup>		kWh/a	274	380	382	452	583	—	—
Heating capacity	Nominal (Min - Max)	kW	4,00(1,50 - 5,00)	5,60(1,50 - 6,50)	7,00(1,80 - 8,00)	8,00(2,00 - 9,00)	11,20(4,10 - 14,00)	14,00(4,10 - 16,00)	16,00(4,10 - 18,00)
Heating capacity at -7°C / -15°C <sup>4)</sup>		kW	— / —	— / —	— / —	7,52	12,04	13,48	14,24
COP <sup>1)</sup>	Nominal (Min - Max)	W/W	4,30(5,17 - 4,00)	3,81(5,17 - 3,49)	3,74(5,14 - 3,64)	3,54(4,00 - 3,08)	3,80(4,18 - 3,11)	3,61(3,90 - 2,96)	3,41(3,90 - 2,95)
SCOP <sup>2)</sup>		W/W	<b>3,80A</b>	<b>3,80A</b>	<b>3,80A</b>	<b>3,70A</b>	<b>3,90A</b>	<b>3,66</b>	<b>3,58</b>
Pdesign at -10°C		kW	3,60	3,80	5,60	6,50	10,00	12,50	14,00
Input power heating	Nominal (Min - Max)	kW	0,93(0,29 - 1,25)	1,47(0,29 - 1,86)	1,87(0,35 - 2,20)	2,26(0,50 - 2,92)	2,95(0,98 - 4,50)	3,88(1,05 - 5,40)	4,69(1,05 - 6,10)
Annual energy consumption <sup>3)</sup>		kWh/a	1326	1478	2061	2458	3590	—	—
<b>Indoor unit</b>			<b>S-36PN1E5B</b>	<b>S-50PN1E5B</b>	<b>S-60PN1E5B</b>	<b>S-71PN1E5B</b>	<b>S-100PN1E5B</b>	<b>S-125PN1E5B</b>	<b>S-140PN1E5B</b>
External static pressure <sup>5)</sup>	Nominal (Min - Max)	Pa	50(10 - 80)	50(10 - 80)	50(10 - 80)	50(10 - 80)	50(10 - 80)	50(10 - 80)	50(10 - 80)
Air volume	Cool / Heat	m <sup>3</sup> /min	14/12/10	16/13/11	22/20/16	22/20/16	36/33/26	38/35/28	40/37/30
Sound pressure <sup>6)</sup>	Hi / Med / Lo	dB(A)	40/38/35	41/39/35	43/41/36	43/41/36	44/42/37	45/43/38	46/44/39
Dimension <sup>7)</sup>	H x W x D	mm	250 x 780 x 650	250 x 780 x 650	250 x 1000 x 650	250 x 1000 x 650	250 x 1200 x 650	250 x 1200 x 650	250 x 1200 x 650
Net weight		kg	29	29	32	32	41	41	41
<b>Outdoor unit</b>			<b>U-36PE2E5A</b>	<b>U-50PE2E5A</b>	<b>U-60PE2E5A</b>	<b>U-71PE1E5A</b>	<b>U-100PE1E5A</b>	<b>U-125PE1E5A</b>	<b>U-140PE1E5A</b>
Power source		V	220/230/240	220/230/240	220/230/240	220/230/240	220/230/240	220/230/240	220/230/240
Recommended fuse		A	—	—	—	20	25	30	16
Connection indoor / outdoor		mm <sup>2</sup>	—	—	—	2,5	4	6	2,5
Current	Cool	A	4,35/4,15/3,95	7,00/6,65/6,35	8,60/8,30/7,90	9,70/9,40/9,20	11,60/11,20/10,90	17,40/16,90/16,40	20,50/20,10/19,50
	Heat	A	4,10/4,00/3,80	6,60/6,30/6,05	8,75/8,35/8,00	10,20/9,90/9,70	12,80/12,50/12,20	17,30/16,80/16,30	20,60/20,20/19,60
Air volume	Cool / Heat	m <sup>3</sup> /min	38/38	38/41	38/41	60/60	110/95	130/110	135/120
Sound pressure	Cool / Heat (Hi)	dB(A)	45/46	46/48	46/49	48/50	52/52	53/53	54/55
Dimension	H x W x D	mm	619 x 799 x 299	619 x 799 x 299	619 x 799 x 299	996 x 940 x 340	1416 x 940 x 340	1416 x 940 x 340	1416 x 940 x 340
Net weight		kg	39	39	40	69	98	98	98
Piping connections	Liquid pipe	Inch (mm)	1/4(6,35)	1/4(6,35)	3/8(9,52)	3/8(9,52)	3/8(9,52)	3/8(9,52)	3/8(9,52)
	Gas pipe	Inch (mm)	1/2(12,70)	1/2(12,70)	5/8(15,88)	5/8(15,88)	5/8(15,88)	5/8(15,88)	5/8(15,88)
Pipe length range		m	3 - 40	3 - 40	3 - 40	5 - 50	5 - 75	5 - 75	5 - 75
Elevation difference (in/out) <sup>8)</sup>		m	30	30	30	30	30	30	30
Pipe length for additional gas		m	30	30	30	30	30	30	30
Additional gas amount		g/m	20	20	40	50	50	50	50
Refrigerant (R410A)		kg/TCO <sub>2</sub> Eq.	1,40/2,9232	1,40/2,9232	1,95/4,0716	2,35/4,9068	3,40/7,0992	3,40/7,0992	3,40/7,0992
Operating range	Cool Min ~ Max	°C	-15 ~ +46	-15 ~ +46	-15 ~ +46	-15 ~ +46	-15 ~ +46	-15 ~ +46	-15 ~ +46
	Heat Min ~ Max	°C	-20 ~ +24	-20 ~ +24	-20 ~ +24	-20 ~ +24	-20 ~ +24	-20 ~ +24	-20 ~ +24

#### Accessories

<b>CZ-RTC5B</b>	Wired remote controller with Econavi button and datanavi
<b>CZ-RWS3 + CZ-RWRC3</b>	Wireless remote controller
<b>CZ-RE2C2</b>	Simplified remote controller
<b>PAW-WTRAY</b>	Tray for condenser water compatible with base ground support
<b>PAW-GRDBSE20</b>	Outdoor base ground support for noise and vibration absorption

#### Accessories

<b>PAW-GRDSTD40</b>	Outdoor elevation platform 400 x 900 x 400mm
<b>PAW-WPH7</b>	Wind protection shield for U-100/125/140PE1E5A/8A and U-140PEY1E8
<b>PAW-WPH9</b>	Wind protection shield for U-71PE1E5A/8A and U-100/125PEY1E5/8



Controller. Wired remote controller CZ-RTCSB Compatible with Econavi  
 Optional Controller. Wireless remote controller CZ-RWS3 + CZ-RWRC3  
 Optional Controller. Simplified remote controller CZ-REZC2  
 Optional Econavi Sensor. CZ-CENSC1

### System Example

An inspection port (450mmx450mm or more) is required at the control-box side of the indoor unit body.

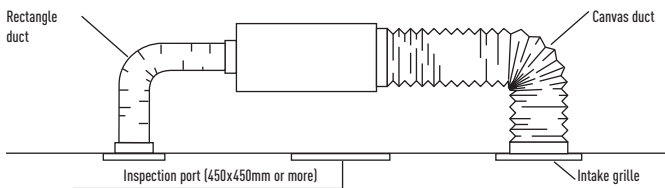

### Cold Drafts Reduction at Heating

Accurate DX Coil temperature measurement by E1 and E2 sensor to reduce cold drafts at heating and increasing efficiency and comfort.

Before spec-in, please consult with an authorized Panasonic dealer.

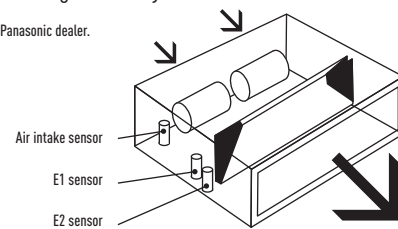

			Three Phase			
			7,10kW	10,00kW	12,50kW	14,00kW
KIT			KIT-71PN1E8C	KIT-100PN1E8C	KIT-125PN1E8C	KIT-140PN1E8C
Remote controller			CZ-RTCSB	CZ-RTCSB	CZ-RTCSB	CZ-RTCSB
Cooling capacity	Nominal (Min - Max)	kW	7,10 (2,50 - 8,00)	10,00 (3,30 - 12,50)	12,50 (3,30 - 14,00)	14,00 (3,30 - 15,50)
EER <sup>1)</sup>	Nominal (Min - Max)	W/W	3,30 (3,79 - 2,91)	3,75 (3,79 - 3,29)	3,21 (3,30 - 2,92)	3,01 (3,30 - 2,50)
SEER <sup>2)</sup>		W/W	5,10 A	5,60 A+	5,44	5,27
Pdesign		kW	7,10	10,00	12,50	14,00
Input power cooling	Nominal (Min - Max)	kW	2,15 (0,66 - 2,75)	2,67 (0,87 - 3,80)	3,89 (1,00 - 4,80)	4,65 (1,00 - 6,20)
Annual energy consumption <sup>3)</sup>		kWh/a	487	621	—	—
Heating capacity	Nominal (Min - Max)	kW	8,00 (2,00 - 9,00)	11,20 (4,10 - 14,00)	14,00 (4,10 - 16,00)	16,00 (4,10 - 18,00)
Heating capacity at -7°C / -15°C <sup>4)</sup>		kW	7,52	12,04	13,48	14,24
COP <sup>1)</sup>	Nominal (Min - Max)	W/W	3,54 (3,33 - 3,00)	3,80 (4,18 - 3,11)	3,61 (3,90 - 2,96)	3,41 (3,90 - 2,95)
SCOP <sup>2)</sup>		W/W	3,80 A	3,80 A	3,66	3,58
Pdesign at -10°C		kW	6,20	10,00	12,50	14,00
Input power heating	Nominal (Min - Max)	kW	2,26 (0,60 - 3,00)	2,95 (0,98 - 4,50)	3,88 (1,05 - 5,40)	4,69 (1,05 - 6,10)
Annual energy consumption <sup>3)</sup>		kWh/a	2284	3684	—	—
Indoor unit			S-71PN1E5B	S-100PN1E5B	S-125PN1E5B	S-140PN1E5B
External static pressure <sup>5)</sup>	Nominal (Min - Max)	Pa	50 (10 - 80)	50 (10 - 80)	50 (10 - 80)	50 (10 - 80)
Air volume	Cool / Heat	m <sup>3</sup> /min	22 / 20 / 16	36 / 33 / 26	38 / 35 / 28	40 / 37 / 30
Sound pressure <sup>6)</sup>	Hi / Med / Lo	dB(A)	43 / 41 / 36	44 / 42 / 37	45 / 43 / 38	46 / 44 / 39
Dimension <sup>7)</sup>	H x W x D	mm	250 x 1000 x 650	250 x 1200 x 650	250 x 1200 x 650	250 x 1200 x 650
Net weight		kg	32	41	41	41
Outdoor unit			U-71PE1E8A	U-100PE1E8A	U-125PE1E8A	U-140PE1E8A
Power source		V	380 / 400 / 415	380 / 400 / 415	380 / 400 / 415	380 / 400 / 415
Recommended fuse		A	16	16	16	16
Connection indoor / outdoor		mm <sup>2</sup>	2,5	2,5	2,5	2,5
Current	Cool	A	3,25 / 3,10 / 3,00	3,95 / 3,75 / 3,60	5,80 / 5,50 / 5,30	6,95 / 6,60 / 6,35
	Heat	A	3,35 / 3,20 / 3,10	4,35 / 4,15 / 4,00	5,80 / 5,50 / 5,30	7,00 / 6,65 / 6,45
Air volume	Cool / Heat	m <sup>3</sup> /min	60 / 60	110 / 95	130 / 110	135 / 120
Sound pressure	Cool / Heat (Hi)	dB(A)	48 / 50	52 / 52	53 / 53	54 / 55
Dimension	H x W x D	mm	996 x 940 x 340	1416 x 940 x 340	1416 x 940 x 340	1416 x 940 x 340
Net weight		kg	71	98	98	98
Piping connections	Liquid pipe	Inch (mm)	3/8 (9,52)	3/8 (9,52)	3/8 (9,52)	3/8 (9,52)
	Gas pipe	Inch (mm)	5/8 (15,88)	5/8 (15,88)	5/8 (15,88)	5/8 (15,88)
Pipe length range		m	5 - 50	5 - 75	5 - 75	5 - 75
Elevation difference (in/out) <sup>8)</sup>		m	30	30	30	30
Pipe length for additional gas		m	30	30	30	30
Additional gas amount		g/m	50	50	50	50
Refrigerant (R410A)		kg/TCO <sub>2</sub> Eq.	2,35 / 4,9068	3,40 / 7,0992	3,40 / 7,0992	3,40 / 7,0992
Operating range	Cool Min ~ Max	°C	-15 ~ +46	-15 ~ +46	-15 ~ +46	-15 ~ +46
	Heat Min ~ Max	°C	-20 ~ +24	-20 ~ +24	-20 ~ +24	-20 ~ +24

1) EER and COP calculation is based in accordance to EN14511. 2) For models below 12kW, the SEER and SCOP is calculated based on values of EU/626/2011. For models above 12kW, the SEER and SCOP is calculated based on values of EU/2281/2016. 3) The annual energy consumption is calculated in accordance to EU/626/2011. 4) Heating capacity is calculated including defrost factor correction. 5) Medium external static pressure setting from factory. 6) The sound pressure of the units shows the value measured of a position 1m in front of the main body and 1,5m from the ground. The sound pressure is measured in accordance with Eurovent 6/C/006-97 specification. 7) Add 100mm for piping part. 8) When installing the outdoor unit at a higher position than the indoor unit.\* Recommended fuse for the indoor 3A.



SEER and SCOP: KIT-100PN1E8C. INTERNET CONTROL: Optional.  
 Compatible with all Panasonic connectivity solutions. For detailed information go to the Control Systems section.

Rating Conditions: Cooling Indoor 27°C DB / 19°C WB. Cooling Outdoor 35°C DB / 24°C WB. Heating Indoor 20°C DB. Heating Outdoor 7°C DB / 6°C WB. (DB: Dry Bulb; WB: Wet Bulb)  
 Specifications subject to change without notice. For detailed information about ErP, please visit our websites www.aircon.panasonic.eu or www.ptc.panasonic.eu.

# PACi STANDARD LOW STATIC PRESSURE HIDE AWAY INVERTER+ • R410A GAS



The depth of only 250mm provides greater installation flexibility and the unit can be used in more applications. Ideal for sites with narrow ceiling voids.

Ultra-slim profile: 250mm height for all models.

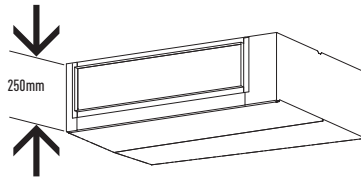

### Technical focus

- Automatic learning function for the required static pressure on site during commissioning (a standard wired remote controller is required. S-60/71/100/125/140PN1E5B models only)
- Compact indoor units without loosing static pressure (only 250mm high)
- 50 Pa static pressure
- Easy maintenance and service via external electrical box
- 3 speed centrifugal fan through wired or wireless remote control
- DC FAN for better efficiency and control
- Easy connection and control of external fan or ERV using the connector PAW-FDC on the indoor unit PCB. The external device can be controlled by the remote control of the Panasonic indoor unit

			Single Phase			
			6,00kW	7,10kW	10,00kW	12,50kW
KIT			KIT-60PNY1E5C	KIT-71PNY1E5C	KIT-100PNY1E5C	KIT-125PNY1E5C
Remote controller			CZ-RTC5B	CZ-RTC5B	CZ-RTC5B	CZ-RTC5B
Cooling capacity	Nominal (Min - Max)	kW	6,00 [2,00 - 7,10]	7,10 [2,00 - 7,70]	10,00 [2,70 - 11,50]	12,50 [3,80 - 13,50]
EER <sup>1)</sup>	Nominal (Min - Max)	W/W	3,21 [5,00 - 2,78]	2,76 [5,00 - 2,48] D	2,81 [4,74 - 2,67]	2,81 [4,00 - 2,60]
SEER <sup>2)</sup>		W/W	4,80 B	5,10 A	5,30 A	4,95
P <sub>design</sub>		kW	6,00	7,10	10,00	12,50
Input power cooling	Nominal (Min - Max)	kW	1,87 [0,40 - 2,55]	2,57 [0,40 - 3,10]	3,56 [0,57 - 4,30]	4,45 [0,95 - 5,20]
Annual energy consumption <sup>3)</sup>		kWh/a	437	487	660	—
Heating capacity	Nominal (Min - Max)	kW	6,00 [1,80 - 7,00]	7,10 [1,80 - 8,10]	10,00 [2,10 - 13,80]	12,50 [3,40 - 15,00]
Heating capacity at -7°C / -15°C <sup>4)</sup>		kW	— / —	— / —	9,97	10,97
COP <sup>1)</sup>	Nominal (Min - Max)	W/W	3,73 [5,14 - 3,78]	3,70 [5,14 - 3,31]	3,41 [4,67 - 3,37]	3,41 [4,36 - 3,26]
SCOP <sup>2)</sup>		W/W	3,80 A	3,80 A	3,80 A	3,52
P <sub>design</sub> at -10°C		kW	5,60	5,60	7,60	12,50
Input power heating	Nominal (Min - Max)	kW	1,61 [0,35 - 1,85]	1,92 [0,35 - 2,45]	2,94 [0,45 - 4,10]	3,67 [0,78 - 4,60]
Annual energy consumption <sup>3)</sup>		kWh/a	2061	2061	2800	—
Indoor unit			S-60PN1E5B	S-71PN1E5B	S-100PN1E5B	S-125PN1E5B
External static pressure <sup>5)</sup>	Nominal (Min - Max)	Pa	50 [10 - 80]	50 [10 - 80]	50 [10 - 80]	50 [10 - 80]
Air volume	Cool / Heat	m <sup>3</sup> /min	22/20/16	22/20/16	36/33/26	38/35/28
Sound pressure <sup>6)</sup>	Hi / Med / Lo	dB(A)	43/41/36	43/41/36	44/42/37	45/43/38
Dimension <sup>7)</sup>	H x W x D	mm	250 x 1000 x 650	250 x 1000 x 650	250 x 1200 x 650	250 x 1200 x 650
Net weight		kg	32	32	41	41
Outdoor unit			U-60PEY2E5	U-71PEY2E5	U-100PEY1E5	U-125PEY1E5
Power source		V	220/230/240	220/230/240	220/230/240	220/230/240
Recommended fuse		A	—	—	25	30
Connection indoor / outdoor		mm <sup>2</sup>	—	—	4	6
Current	Cool	A	8,70/8,40/8,00	12,10/11,60/11,20	16,00/15,30/14,80	20,10/19,30/18,70
	Heat	A	7,40/7,10/6,80	9,00/8,60/8,25	13,00/12,50/12,10	16,50/15,80/15,20
Air volume	Cool / Heat	m <sup>3</sup> /min	38/41	44/41	110/95	80/73
Sound pressure	Cool / Heat (Hi)	dB(A)	46/48	49/49	52/52	56/56
Dimension	H x W x D	mm	619 x 799 x 299	619 x 799 x 299	996 x 940 x 340	996 x 940 x 340
Net weight		kg	40	40	73	85
Piping connections	Liquid pipe	Inch (mm)	3/8 (9,52)	3/8 (9,52)	3/8 (9,52)	3/8 (9,52)
	Gas pipe	Inch (mm)	5/8 (15,88)	5/8 (15,88)	5/8 (15,88)	5/8 (15,88)
Pipe length range		m	3 - 40	3 - 40	5 - 50	5 - 50
Elevation difference (in/out) <sup>8)</sup>		m	30	30	30	30
Pipe length for additional gas		m	30	30	30	30
Additional gas amount		g/m	40	40	50	50
Refrigerant (R410A)		kg/TCO <sub>2</sub> Eq.	1,95/4,0716	1,95/4,0716	2,60/5,4288	3,20/6,6816
Operating range	Cool Min ~ Max	°C	-10 ~ +43	-10 ~ +43	-10 ~ +43	-10 ~ +43
	Heat Min ~ Max	°C	-15 ~ +24	-15 ~ +24	-15 ~ +24	-15 ~ +24

Accessories	
CZ-RTC5B	Wired remote controller with Econavi button and datanavi
CZ-RWS3 + CZ-RWRC3	Wireless remote controller
CZ-RE2C2	Simplified remote controller
PAW-WTRAY	Tray for condenser water compatible with base ground support
PAW-GRDBSE20	Outdoor base ground support for noise and vibration absorption

Accessories	
PAW-GRDSTD40	Outdoor elevation platform 400 x 900 x 400mm
PAW-WPH7	Wind protection shield for U-100/125/140PE1E5A/8A and U-140PEY1E8
PAW-WPH9	Wind protection shield for U-71PE1E5A/8A and U-100/125PEY1E5/8





Controller. Wired remote controller CZ-RTCSB Compatible with Econavi  
 Optional Controller. Wireless remote controller CZ-RWS3 + CZ-RWRC3  
 Optional Controller. Simplified remote controller CZ-REZC2  
 Optional Econavi Sensor. CZ-CENSC1

PACi Kits

R410A



**System Example**

An inspection port (450mmx450mm or more) is required at the control-box side of the indoor unit body.

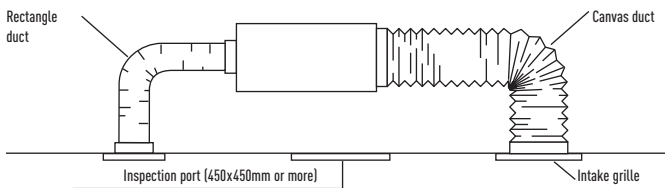

**Cold Drafts Reduction at Heating**

Accurate DX Coil temperature measurement by E1 and E2 sensor to reduce cold drafts at heating and increasing efficiency and comfort.

Before spec-in, please consult with an authorized Panasonic dealer.

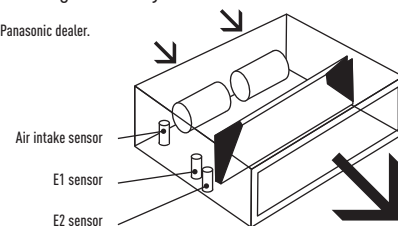

			Three Phase		
			10,00kW	12,50kW	14,00kW
			KIT-100PNY1E8C	KIT-125PNY1E8C	KIT-140PNY1E8C
			CZ-RTCSB	CZ-RTCSB	CZ-RTCSB
<b>KIT</b>					
<b>Remote controller</b>					
Cooling capacity	Nominal (Min - Max)	kW	10,00 (2,70 - 11,50)	12,50 (3,80 - 13,50)	14,00 (3,30 - 15,50)
EER <sup>1)</sup>	Nominal (Min - Max)	W/W	2,81 (4,74 - 2,67)	2,81 (4,00 - 2,60)	2,98 (3,93 - 2,58)
<b>SEER <sup>2)</sup></b>		<b>W/W</b>	<b>5,20 A</b>	<b>4,95</b>	<b>5,18</b>
Pdesign		kW	10,00	12,50	14,00
Input power cooling	Nominal (Min - Max)	kW	3,56 (0,57 - 4,30)	4,45 (0,95 - 5,20)	4,70 (0,84 - 6,00)
Annual energy consumption <sup>3)</sup>		kWh/a	673	—	—
Heating capacity	Nominal (Min - Max)	kW	10,00 (2,10 - 13,80)	12,50 (3,40 - 15,00)	14,00 (4,10 - 16,00)
Heating capacity at -7°C / -15°C <sup>4)</sup>		kW	9,97	10,97	13,35
COP <sup>1)</sup>	Nominal (Min - Max)	W/W	3,41 (4,67 - 3,37)	3,41 (4,36 - 3,26)	3,52 (4,56 - 3,08)
<b>SCOP <sup>2)</sup></b>		<b>W/W</b>	<b>3,80 A</b>	<b>3,52</b>	<b>3,52</b>
Pdesign at -10°C		kW	7,60	12,50	14,00
Input power heating	Nominal (Min - Max)	kW	2,94 (0,45 - 4,10)	3,67 (0,78 - 4,60)	3,88 (1,05 - 5,40)
Annual energy consumption <sup>3)</sup>		kWh/a	2800	—	—
<b>Indoor unit</b>			<b>S-100PN1E5B</b>	<b>S-125PN1E5B</b>	<b>S-140PN1E5B</b>
External static pressure <sup>5)</sup>	Nominal (Min - Max)	Pa	50 (10 - 80)	50 (10 - 80)	50 (10 - 80)
Air volume	Cool / Heat	m <sup>3</sup> /min	36/33/26	38/35/28	40/37/30
Sound pressure <sup>6)</sup>	Hi / Med / Lo	dB(A)	44/42/37	45/43/38	46/44/39
Dimension <sup>7)</sup>	H x W x D	mm	250 x 1200 x 650	250 x 1200 x 650	250 x 1200 x 650
Net weight		kg	41	41	41
<b>Outdoor unit</b>			<b>U-100PEY1E8</b>	<b>U-125PEY1E8</b>	<b>U-140PEY1E8</b>
Power source		V	380/400/415	380/400/415	380/400/415
Recommended fuse		A	16	16	16
Connection indoor / outdoor		mm <sup>2</sup>	2,5	2,5	2,5
Current	Cool	A	5,45/5,20/5,05	6,85/6,50/6,25	7,05/6,50/6,45
	Heat	A	4,45/4,25/4,10	5,55/5,30/5,10	5,90/5,60/5,40
Air volume	Cool / Heat	m <sup>3</sup> /min	76/67	80/73	135/120
Sound pressure	Cool / Heat (Hi)	dB(A)	54/54	56/56	54/53
Dimension	H x W x D	mm	996 x 940 x 340	996 x 940 x 340	1416 x 940 x 340
Net weight		kg	73	85	98
Piping connections	Liquid pipe	Inch (mm)	3/8 (9,52)	3/8 (9,52)	3/8 (9,52)
	Gas pipe	Inch (mm)	5/8 (15,88)	5/8 (15,88)	5/8 (15,88)
Pipe length range		m	5 - 50	5 - 50	5 - 50
Elevation difference (in/out) <sup>8)</sup>		m	30	30	30
Pipe length for additional gas		m	30	30	30
Additional gas amount		g/m	50	50	50
Refrigerant (R410A)		kg/TCO: Eq.	2,60/5,4288	3,20/6,6816	3,40/7,0992
Operating range	Cool Min ~ Max	°C	-10 ~ +43	-10 ~ +43	-10 ~ +43
	Heat Min ~ Max	°C	-15 ~ +24	-15 ~ +24	-15 ~ +24

1) EER and COP calculation is based in accordance to EN14511. 2) For models below 12kW, the SEER and SCOP is calculated based on values of EU/626/2011. For models above 12kW, the SEER and SCOP is calculated based on values of EU/2281/2016. 3) The annual energy consumption is calculated in accordance to EU/626/2011. 4) Heating capacity is calculated including defrost factor correction. 5) Medium external static pressure setting from factory. 6) The sound pressure of the units shows the value measured of a position 1m in front of the main body and 1,5m from the ground. The sound pressure is measured in accordance with Eurovent 6/C/006-97 specification. 7) Add 100mm for piping part. 8) When installing the outdoor unit at a higher position than the indoor unit.\* Recommended fuse for the indoor 3A.



SEER and SCOP: KIT-100PNY1E5C. INTERNET CONTROL: Optional.  
 Compatible with all Panasonic connectivity solutions. For detailed information go to the Control Systems section.

Rating Conditions: Cooling Indoor 27°C DB / 19°C WB. Cooling Outdoor 35°C DB / 24°C WB. Heating Indoor 20°C DB. Heating Outdoor 7°C DB / 6°C WB. (DB: Dry Bulb; WB: Wet Bulb)  
 Specifications subject to change without notice. For detailed information about ErP, please visit our websites www.aircon.panasonic.eu or www.ptc.panasonic.eu.

## BIG PACi HIGH STATIC PRESSURE HIDE AWAY 20,0-25,00kW INVERTER+ • R410A GAS



### Panasonic breaks new ground in offering high performance and power in a small space

- High efficiency: Panasonic compressor
- Better partial load
- More flexible
- Bluefin anti-rust coating
- 0-10V control demand

The light net weight and compact design enables easier installation in any commercial space. The twin fan system saves valuable footprint compared to traditional 20,00-25,00kW systems which are larger and therefore require more space.

### All "A" Functions

- Control demand 0-10V via CZ-CAPBC2
- Schedule peak cut
- Advanced energy saving functionalities available in Elite series
- Compact design
- Suitable for mid, small project: piping design is suitable for light commercial and residential project

The 20,00-25,00kW from Panasonic is ideally suited for large retail applications and other large areas not needing the higher capacities of VRF systems.

### Enlarged heat exchanger surface area with double surface

The heat exchanger features a double-surface construction. Compared to the divided dual-surface construction in current models, there is no division of space and the area for heat exchange is larger. Also, highly efficient piping pattern increases heat exchange performance by 5%.

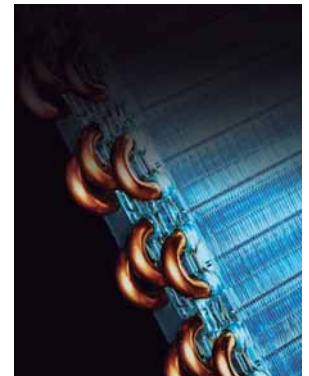

### Bluefin

An air conditioner's performance depends largely on its condenser, which can take a beating from exposure to salty air, wind, dust and other corrosive factors. Panasonic has found a way to expand the life of our condensers, using a layer of our original anti-rust coating. This special coating lets you enjoy more years of reliable comfort plus extra economy over the long run.

### Panasonic Compressor

Panasonic's best inverter control yet with industry leading partial load\* 10%-100%. Compressors that operate with a wider Hz range realize a more efficient operation throughout the year.

\* Compared current model is the unit for European market.

PACi Kits

R410A



Controller. Wired remote controller CZ-RTC5B Compatible with Econavi  
 Optional Controller. Wireless remote controller CZ-RWS3 + CZ-RWRC3  
 Optional Controller. Simplified remote controller CZ-RE2C2  
 Optional Econavi Sensor. CZ-CENSC1



**Panasonic breaks new ground in offering high performance and power in a small space**

The 8-10HP from Panasonic is ideally suited for large retail applications and other large areas not needing the higher capacities of VRF systems. The lightweight and compact design enables easier installation in any commercial space. The twin fan system saves valuable footprint compared to traditional 8-10HP systems which are larger and therefore require more space.

**Technical focus**

- High efficiency:
- Panasonic compressor
- Better partial load
- More flexible
- Bluefin anti-rust coating
- 0-10V control demand

**High heating capacity at -7°C.**

			Three Phase	
			20,00kW	25,00kW
			KIT-200PE2E5D	KIT-250PE2E5D
			CZ-RTC5B	CZ-RTC5B
<b>KIT</b>				
<b>Remote controller</b>				
Cooling capacity	Nominal (Min - Max)	kW	19,50 (5,40 - 22,40)	25,00 (6,30 - 28,00)
EER <sup>1)</sup>		W/W	3,11	2,91
<b>SEER <sup>2)</sup></b>		<b>W/W</b>	<b>5,34</b>	<b>4,83</b>
Pdesign		kW	19,50	25,00
Input power cooling		kW	5,97	8,04
Heating capacity	Nominal (Min - Max)	kW	22,40 (5,60 - 25,00)	28,00 (7,10 - 31,50)
Heating capacity at -7°C / -15°C <sup>3)</sup>		kW	20,00 / 17,00	25,20 / 21,42
COP <sup>1)</sup>		W/W	3,54	3,64
<b>SCOP <sup>2)</sup></b>		<b>W/W</b>	<b>3,55</b>	<b>3,56</b>
Pdesign at -10°C		kW	17,00	20,00
Input power heating		kW	6,02	7,14
<b>Indoor unit</b>			<b>S-200PE2E5</b>	<b>S-250PE2E5</b>
Power source		V / ph / Hz	220 - 230 - 240 / 1 / 50	220 - 230 - 240 / 1 / 50
External static pressure at shipment (with booster cable) <sup>4)</sup>		Pa	60 - 140 - 270	72 - 140 - 270
Air volume	Hi / Med / Lo	m <sup>3</sup> /min	56 / 51 / 44	72 / 63 / 53
Sound pressure <sup>5)</sup>	Hi / Med / Lo	dB(A)	43 / 41 / 38	47 / 45 / 42
Dimension	H x W x D	mm	479 x 1453 x 1205	479 x 1453 x 1205
Net weight		kg	100	104
<b>Outdoor unit</b>			<b>U-200PE2E8A</b>	<b>U-250PE2E8A</b>
Power source		V / ph / Hz	380 - 400 - 415 / 3 / 50	380 - 400 - 415 / 3 / 50
Recommended fuse		A	15	20
Air volume	Cool / Heat	m <sup>3</sup> /min	164	160
Sound pressure <sup>5)</sup>	Cool / Heat (Hi)	dB(A)	60 / 62	61 / 63
Dimension <sup>6)</sup>	H x W x D	mm	1500 x 980 x 370	1500 x 980 x 370
Net weight		kg	127	138
Piping connections	Liquid pipe	Inch (mm)	3/8 (9,52)	1/2 (12,70)
	Gas pipe	Inch (mm)	1 (25,40)	1 (25,40)
Pipe length range		m	5 - 120	5 - 120
Elevation difference (in/out) <sup>7)</sup>		m	30	30
Pipe length for additional gas		m	30	30
Additional gas amount		g/m	50	80
Refrigerant (R410A)		kg/TCO: Eq.	5,60 / 11,6928	6,40 / 13,3632
Operating range	Cool Min ~ Max	°C	-15 ~ +46	-15 ~ +46
	Heat Min ~ Max	°C	-20 ~ +24	-20 ~ +24

**Accessories**

<b>CZ-RTC5B</b>	Wired remote controller with Econavi button and datanavi
<b>CZ-RWS3 + CZ-RWRC3</b>	Wireless remote controller
<b>CZ-RE2C2</b>	Simplified remote controller
<b>PAW-GRDSTD40</b>	Outdoor elevation platform 400 x 900 x 400mm

**Accessories**

<b>CZ-TREMIESPW706</b>	Air Outlet Plenum (suitable for rigid + flexible duct) for S-250PE2E5
<b>CZ-TREMIESPW705</b>	Air Outlet Plenum (suitable for rigid + flexible duct) for S-200PE2E5

1) EER and COP calculation is based in accordance to EN14511. 2) For models below 12kW, the SEER and SCOP is calculated based on values of EU/626/2011. For models above 12kW, the SEER and SCOP is calculated based on values of EU/2281/2016. 3) Heating capacity is calculated including defrost factor correction. 4) Medium external static pressure setting from factory. 5) The sound pressure of the units shows the value measured at a position 1m in front of the main body and 1,5m from the ground. The sound pressure is measured in accordance with Eurovent 6/C/006-97 specification. 6) Add 100mm for indoor unit or 70mm for outdoor unit for piping port. 7) When installing the outdoor unit at a higher position than the indoor unit. \* No filter included.



INTERNET CONTROL: Optional.  
 Compatible with all Panasonic connectivity solutions. For detailed information go to the Control Systems section.

Rating Conditions: Cooling Indoor 27°C DB / 19°C WB. Cooling Outdoor 35°C DB / 24°C WB. Heating Indoor 20°C DB. Heating Outdoor 7°C DB / 6°C WB. (DB: Dry Bulb; WB: Wet Bulb)  
 Specifications subject to change without notice. For detailed information about ErP, please visit our websites www.aircon.panasonic.eu or www.gtc.panasonic.eu.

## PACi SINGLE, TWIN, TRIPLE AND DOUBLE-TWIN SYSTEM • R32 GAS AND • R410A GAS

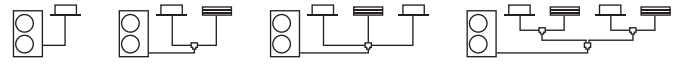

### 1 PACi Standard from 10,00 to 12,50kW

Up to 2 indoor units connectable on the same outdoor. Panasonic's PACi units can be installed as single and twin systems. The indoor units can be combined following the selection table. The operation will always be simultaneous. All the indoor units will work with the same settings.

### 2 PACi Elite from 7,10 to 14,00kW

Up to 4 indoor units can be connected to the same outdoor unit. Panasonic's PACi units 7,10, 10,00, 12,50 and 14,00 can be installed as twin, triple and double-twin systems. The indoor units can be combined as per the selection table. The operation will always be simultaneous. All the indoor units will work with the same settings.

### 3 Big PACi Elite from 20,00 to 25,00kW

Up to 4 indoor units can be connected to the same outdoor unit. Panasonic's PACi units 20,00 and 25,00 can be installed as twin, triple and double-twin systems. The indoor units can be combined as per the selection table. The operation will always be simultaneous. All the indoor units will work with the same settings.

With this system, a single outdoor unit can split capacity for up to 4 indoor areas simultaneously. This makes the system particularly apt for common areas. It reduces noise concentration and enables the same temperature to be reached around the room. A mix of indoor units can be installed (wall, Cassette, duct, ceiling) in one system.

**PACi Standard Single/Simultaneous operation system combinations • R32 GAS and • R410A GAS**

	Outdoor			
Indoor	7,10kW	10,00kW	12,50kW	14,00kW
3,60kW	Twin <sup>1</sup> U-71 S-36 S-36			
5,00kW		Twin U-100 S-50 S-50		
6,00kW			Twin U-125 S-60 S-60	
7,10kW	Single <sup>2</sup> U-71 S-71			Twin U-140 S-71 S-71
10,00kW		Single <sup>2</sup> U-100 S-100		
12,50kW			Single <sup>2</sup> U-125 S-125	
14,00kW				Single <sup>2</sup> U-140 S-140

**PACi Elite from 7,1 to 14,00kW Single/Simultaneous operation system combinations • R32 GAS and • R410A GAS**

	Outdoor			
Indoor	7,10kW	10,00kW	12,50kW	14,00kW
3,60kW	Twin U-71 S-36 S-36	Triple U-100 S-36 S-36 S-36	Double-Twin U-125 S-36 S-36 S-36 S-36	
4,50kW			Triple U-125 S-45 S-45 S-45	
5,00kW		Twin U-100 S-50 S-50		Triple U-140 S-50 S-50 S-50
6,00kW			Twin U-125 S-60 S-60	
7,10kW	Single <sup>2</sup> U-71 S-71			Twin U-140 S-71 S-71
10,00kW		Single <sup>2</sup> U-100 S-100		
12,50kW			Single <sup>2</sup> U-125 S-125	
14,00kW				Single <sup>2</sup> U-140 S-140

**PACi Elite from 20,0 to 25,00kW Single/Simultaneous operation system combinations • R410A GAS**

	Outdoor	
Indoor	20,00kW	25,00kW
5,00kW	Double-Twin U-200 S-50 S-50 S-50 S-50	
6,00kW		Double-Twin U-250 S-60 S-60 S-60 S-60
7,10kW	Triple U-200 S-71 S-71 S-71	
10,00kW	Twin U-200 S-100 S-100	
12,50kW		Twin U-250 S-125 S-125
20,00kW	Single <sup>2</sup> U-200 S-200	
25,00kW		Single <sup>2</sup> U-250 S-250

1. Available for only PZ (R32) model with limitations of main pipe and branch pipe. Please contact an authorized Panasonic dealer. 2. PACi 1x1 Kit solution.

PACi Elite Outdoor Units • R32 GAS

PACi Standard Outdoor Units • R32 GAS



**NEW PACi Elite Outdoor Units • R32 GAS<sup>1</sup>**

			7,10kW	10,00kW	12,50kW	14,00kW
<b>Outdoor unit Single Phase</b>			<b>U-71PZH2E5</b>	<b>U-100PZH2E5</b>	<b>U-125PZH2E5</b>	<b>U-140PZH2E5</b>
<b>Outdoor unit Three Phase</b>			<b>U-71PZH2E8</b>	<b>U-100PZH2E8</b>	<b>U-125PZH2E8</b>	<b>U-140PZH2E8</b>
Cooling capacity	Nominal (Min - Max)	kW				
Heating capacity	Nominal (Min - Max)	kW				
Power source	Single Phase	V	220/230/240	220/230/240	220/230/240	220/230/240
	Three Phase	V	380/400/415	380/400/415	380/400/415	380/400/415
Connection indoor / outdoor		mm <sup>2</sup>	—	—	—	—
Air volume	Cool / Heat	m <sup>3</sup> /min	—	—	—	—
Sound pressure	Cool / Heat (Hi)	dB(A)	48/50	52/52	53/53	54/55
Sound power	Cool / Heat (Hi)	dB	65/67	69/69	70/70	71/71
Dimension	HxWxD	mm	996 x 940 x 340	1416 x 940 x 340	1416 x 940 x 340	1416 x 940 x 340
Net weight		kg	68	101	101	101
Piping connections	Liquid pipe	Inch (mm)	3/8 (9,52)	3/8 (9,52)	3/8 (9,52)	3/8 (9,52)
	Gas pipe	Inch (mm)	5/8 (15,88)	5/8 (15,88)	5/8 (15,88)	5/8 (15,88)
Pipe length range	Min ~ Max	m	5 ~ 50	5 ~ 75	5 ~ 75	5 ~ 75
Elevation difference (in/out)	Max	m	30	30	30	30
Refrigerant (R32)		kg/TCO <sub>2</sub> Eq.	—	—	—	—
Operating range	Cool Min ~ Max	°C	-15 ~ +46	-15 ~ +46	-15 ~ +46	-15 ~ +46
	Heat Min ~ Max	°C	-20 ~ +24	-20 ~ +24	-20 ~ +24	-20 ~ +24

1) These models will be available in Winter 2018.

**NEW PACi Standard Outdoor Units • R32 GAS**

			7,10kW	10,00kW	12,50kW	14,00kW
<b>Outdoor unit Single Phase</b>			<b>U-71PZ2E5</b>	<b>U-100PZ2E5</b>	<b>U-125PZ2E5</b>	<b>U-140PZ2E5</b>
<b>Outdoor unit Three Phase</b>			—	<b>U-100PZ2E8</b>	<b>U-125PZ2E8</b>	<b>U-140PZ2E8</b>
Cooling capacity	Nominal (Min - Max)	kW	7,10	10,00 (3,00 - 11,50)	12,50 (3,20 - 13,50)	14,00 (3,30 - 15,00)
Heating capacity	Nominal (Min - Max)	kW	7,10	10,00 (3,00 - 14,00)	12,50 (3,30 - 15,00)	14,00 (3,40 - 16,00)
Power source	Single Phase	V	220/230/240	220/230/240	220/230/240	220/230/240
	Three Phase	V	—	380/400/415	380/400/415	380/415
Connection indoor / outdoor		mm <sup>2</sup>	—	—	—	—
Air volume	Cool / Heat	m <sup>3</sup> /min	—	76,00/70,00	86,00/78,00	89,00/83,00
Sound pressure	Cool / Heat (Hi)	dB(A)	49 / 49	52/52	55/55	56/56
Sound power	Cool / Heat (Hi)	dB	69 / 69	70/70	73/73	74/74
Dimension	HxWxD	mm	695 x 875 x 320	996 x 980 x 370	996 x 980 x 370	996 x 980 x 370
Net weight		kg	49	90	94	94
Piping connections	Liquid pipe	Inch (mm)	3/8 (9,52)	3/8 (9,52)	3/8 (9,52)	3/8 (9,52)
	Gas pipe	Inch (mm)	5/8 (15,88)	5/8 (15,88)	5/8 (15,88)	5/8 (15,88)
Pipe length range	Min ~ Max	m	3 ~ 40	5 ~ 50	5 ~ 50	5 ~ 50
Elevation difference (in/out)	Max	m	30	30	30	30
Refrigerant (R32)		kg/TCO <sub>2</sub> Eq.	—	2,60/1,755	3,00/2,025	3,00/2,025
Operating range	Cool Min ~ Max	°C	-10 ~ +43	-10 ~ +43	-10 ~ +43	-10 ~ +43
	Heat Min ~ Max	°C	-15 ~ +24	-15 ~ +24	-15 ~ +24	-15 ~ +24

PACi Single, Twin, Triple and Double-Twin System

R410A

PACi Elite Outdoor Units • R410A GAS



PACi Standard Outdoor Units • R410A GAS



PACi Elite Outdoor Units • R410A GAS

			7,10kW	10,00kW	12,50kW	14,00kW	20,00kW	25,00kW
<b>Outdoor unit Single Phase</b>			<b>U-71PE1E5A</b>	<b>U-100PE1E5A</b>	<b>U-125PE1E5A</b>	<b>U-140PE1E5A</b>	—	—
<b>Outdoor unit Three Phase</b>			<b>U-71PE1E8A</b>	<b>U-100PE1E8A</b>	<b>U-125PE1E8A</b>	<b>U-140PE1E8A</b>	<b>U-200PE2E8A</b>	<b>U-250PE2E8A</b>
Cooling capacity	Nominal (Min - Max)	kW	7,10 (2,50 - 8,00)	10,00 (3,30 - 12,50)	12,50 (3,30 - 14,00)	14,00 (3,30 - 15,50)	20,00 (6,00 - 22,40)	25,00 (6,00 - 28,00)
Heating capacity	Nominal (Min - Max)	kW	8,00 (2,00 - 9,00)	11,20 (4,10 - 14,00)	14,00 (4,10 - 16,00)	16,00 (4,10 - 18,00)	21,80 (6,00 - 22,40)	28,00 (6,00 - 31,50)
Power source	Single Phase	V	220/240	220/240	220/240	220/240	—	—
	Three Phase	V	380/415	380/415	380/415	380/415	380/415	380/415
Connection indoor / outdoor		mm <sup>2</sup>	2 x 1,5 or 2,5	2 x 1,5 or 2,5	2 x 1,5 or 2,5	2 x 1,5 or 2,5	—	—
Air volume	Cool / Heat	m <sup>3</sup> /min	60,00/60,00	110,00/95,00	130,00/110,00	135,00/120,00	129,00	118,00
Sound pressure	Cool / Heat (Hi)	dB(A)	48/50	52/52	53/53	54/55	57/57	57/58
Sound power	Cool / Heat (Hi)	dB	65/67	69/69	70/70	71/71	72	73
Dimension	H x W x D	mm	996 x 940 x 340	1416 x 940 x 340	1416 x 940 x 340	1416 x 940 x 340	1500 x 980 x 370	1500 x 980 x 370
Net weight		kg	69	98	98	98	118	128
Piping connections	Liquid pipe	Inch (mm)	3/8 (9,52)	3/8 (9,52)	3/8 (9,52)	3/8 (9,52)	3/8 (9,52)	1/2 (12,70)
	Gas pipe	Inch (mm)	5/8 (15,88)	5/8 (15,88)	5/8 (15,88)	5/8 (15,88)	1 (25,40)	1 (25,40)
Pipe length range	Min - Max	m	5 - 50	5 - 75	5 - 75	5 - 75	5 - 100	5 - 100
Elevation difference (in/out)	Max	m	30	30	30	30	30	30
Refrigerant (R410A)		kg/TCO: Eq.	2,35/4,9068	3,40/7,0992	3,40/7,0992	3,40/7,0992	5,60/11,6928	6,40/13,3632
Operating range	Cool Min ~ Max	°C	-15 ~ +46	-15 ~ +46	-15 ~ +46	-15 ~ +46	-15 ~ +46	-15 ~ +46
	Heat Min ~ Max	°C	-20 ~ +24	-20 ~ +24	-20 ~ +24	-20 ~ +24	-20 ~ +15	-20 ~ +15

PACi Standard Outdoor Units • R410A GAS

			7,10kW	10,00kW	12,50kW	14,00kW
<b>Outdoor unit Single Phase</b>			<b>U-71PEY2E5</b>	<b>U-100PEY1E5</b>	<b>U-125PEY1E5</b>	—
<b>Outdoor unit Three Phase</b>			—	<b>U-100PEY1E8</b>	<b>U-125PEY1E8</b>	<b>U-140PEY1E8</b>
Cooling capacity	Nominal (Min - Max)	kW	7,10 (2,00 - 7,70)	10,00 (2,70 - 11,50)	12,50 (3,80 - 13,50)	14,00 (3,30 - 15,50)
Heating capacity	Nominal (Min - Max)	kW	7,10 (1,80 - 8,10)	10,00 (2,10 - 13,80)	12,50 (3,40 - 15,00)	14,00 (4,10 - 16,00)
Power source	Single Phase	V	220/230/240	220/230/240	220/230/240	—
	Three Phase	V	—	380/400/415	380/400/415	380/415
Connection indoor / outdoor		mm <sup>2</sup>	2,50	4,00	6,00	2,50
Air volume	Cool / Heat	m <sup>3</sup> /min	39,00	76,00/67,00	80,00/73,00	135,00/120,00
Sound pressure	Cool / Heat (Hi)	dB(A)	47/49	54/54	56/56	54/53
Sound power	Cool / Heat (Hi)	dB	70/70	70/70	73/73	71/70
Dimension	H x W x D	mm	619 x 799 x 299	996 x 940 x 340	996 x 940 x 340	1416 x 940 x 340
Net weight		kg	40	73	85	98
Piping connections	Liquid pipe	Inch (mm)	3/8 (9,52)	3/8 (9,52)	3/8 (9,52)	3/8 (9,52)
	Gas pipe	Inch (mm)	5/8 (15,88)	5/8 (15,88)	5/8 (15,88)	5/8 (15,88)
Pipe length range	Min - Max	m	5 - 50	5 - 50	5 - 50	5 - 50
Elevation difference (in/out)	Max	m	30	30	30	30
Refrigerant (R410A)		kg/TCO: Eq.	1,95/4,0716	2,60/5,4288	3,20/6,6816	3,40/7,0992
Operating range	Cool Min ~ Max	°C	-10 ~ +43	-10 ~ +43	-10 ~ +43	-10 ~ +43
	Heat Min ~ Max	°C	-15 ~ +24	-15 ~ +24	-15 ~ +24	-15 ~ +24

R32 R410A PACi Single, Twin, Triple and Double-Twin System



Compatible with all Panasonic connectivity solutions. For detailed information go to the Control Systems section.



NEW Wall	Indoor	Cooling capacity	Heating capacity	Dimension	Sound pressure	Air volume
				H x W x D	Hi / Med / Lo	Hi / Med / Lo
				mm	dB(A)	m <sup>3</sup> /min
3,60kW	S-36PK2E5B	3,60	4,20	302 x 1120 x 236	35/31/27	11,00/9,50/7,50
4,50kW	S-45PK2E5B	4,50	5,20	302 x 1120 x 236	38/34/30	12,00/10,50/8,50
5,00kW	S-50PK2E5B	5,00	5,60	302 x 1120 x 236	40/36/32	14,00/12,00/10,50
6,00kW	S-60PK2E5B	6,00	7,00	302 x 1120 x 236	47/44/40	18,00/14,50/11,50
7,10kW	S-71PK2E5B	7,10	8,00	302 x 1120 x 236	47/44/40	18,00/14,50/11,50
10,00kW	S-100PK2E5B	10,00	11,20	302 x 1120 x 236	47/44/40	19,00/16,50/13,00

4 Way 60x60 Cassette	Indoor	Panel	Cooling capacity	Heating capacity	Dimension Indoor	Panel CZ-KPY3AW	Panel CZ-KPY3BW	Sound pressure	Air volume
					H x W x D	H x W x D	H x W x D	Hi / Med / Lo	Hi / Med / Lo
					mm	mm	mm	dB(A)	m <sup>3</sup> /min
3,60kW	S-36PY2E5B	CZ-KPY3AW/CZ-KPY3BW	3,60	4,20	288 x 583 x 583	31 x 700 x 700	31 x 625 x 625	36/32/26	9,70/9,90
4,50kW	S-45PY2E5B	CZ-KPY3AW/CZ-KPY3BW	4,50	5,20	288 x 583 x 583	31 x 700 x 700	31 x 625 x 625	38/34/28	10,00/10,30
5,00kW	S-50PY2E5B	CZ-KPY3AW/CZ-KPY3BW	5,00	5,60	288 x 583 x 583	31 x 700 x 700	31 x 625 x 625	40/37/33	11,10/11,10

4 Way 90x90 Cassette	Indoor	Panel	Cooling capacity	Heating capacity	Dimension Indoor	Dimension Panel	Sound pressure	Air volume
					H x W x D	H x W x D	Hi / Med / Lo	Hi / Med / Lo
					mm	mm	dB(A)	m <sup>3</sup> /min
3,60kW	S-36PU2E5B	CZ-KPU3/CZ-KPU3A	3,60	4,20	256 x 840 x 840	33,5 x 950 x 950	30/28/27	14,50/13,00/11,50
4,50kW	S-45PU2E5B	CZ-KPU3/CZ-KPU3A	4,50	5,20	256 x 840 x 840	33,5 x 950 x 950	31/28/27	15,50/13,00/11,50
5,00kW	S-50PU2E5B	CZ-KPU3/CZ-KPU3A	5,00	5,60	256 x 840 x 840	33,5 x 950 x 950	32/29/27	16,50/13,50/11,50
6,00kW	S-60PU2E5B	CZ-KPU3/CZ-KPU3A	6,00	7,00	256 x 840 x 840	33,5 x 950 x 950	38/31/28	21,00/16,00/13,00
7,10kW	S-71PU2E5B	CZ-KPU3/CZ-KPU3A	7,10	8,00	256 x 840 x 840	33,5 x 950 x 950	37/31/28	22,00/16,00/13,00
10,00kW	S-100PU2E5B	CZ-KPU3/CZ-KPU3A	10,00	11,20	319 x 840 x 840	33,5 x 950 x 950	45/38/32	36,00/26,00/18,00
12,50kW	S-125PU2E5B	CZ-KPU3/CZ-KPU3A	12,50	14,00	319 x 840 x 840	33,5 x 950 x 950	46/39/33	37,00/27,00/19,00
14,00kW	S-140PU2E5B	CZ-KPU3/CZ-KPU3A	14,00	14,00	319 x 840 x 840	33,5 x 950 x 950	47/40/34	38,00/29,00/20,00

Ceiling	Indoor	Cooling capacity	Heating capacity	Dimension	Sound pressure	Air volume
				H x W x D	Hi / Med / Lo	Hi / Med / Lo
				mm	dB(A)	m <sup>3</sup> /min
3,60kW	S-36PT2E5B	3,60	4,20	235 x 960 x 690	35/32/30	14,00/12,00/10,50
4,50kW	S-45PT2E5B	4,50	5,20	235 x 960 x 690	38/33/30	15,00/12,50/10,50
5,00kW	S-50PT2E5B	5,00	5,60	235 x 960 x 690	38/33/30	15,00/12,50/10,50
6,00kW	S-60PT2E5B	6,00	7,00	235 x 1275 x 690	39/36/33	20,00/17,00/14,50
7,10kW	S-71PT2E5B	7,10	8,00	235 x 1275 x 690	39/36/33	21,00/18,00/15,50
10,00kW	S-100PT2E5B	10,00	11,20	235 x 1590 x 690	42/38/35	30,00/25,00/23,00
12,50kW	S-125PT2E5B	12,50	14,00	235 x 1590 x 690	45/40/37	34,00/28,00/24,00
14,00kW	S-140PT2E5B	14,00	14,00	235 x 1590 x 690	47/41/37	35,00/29,00/25,00

High Static Pressure Hide Away	Indoor	Cooling capacity	Heating capacity	Dimension	External static pressure	Sound pressure	Air volume
				H x W x D	Hi / Med / Lo	Hi / Med / Lo	Hi / Med / Lo
				mm	Pa	dB(A)	m <sup>3</sup> /min
3,60kW	S-36PF1E5B	3,60	4,20	290 x 800 x 700	150/70/10	33/29/25	14,00/13,00/10,00
4,50kW	S-45PF1E5B	4,50	5,20	290 x 800 x 700	150/70/10	34/30/26	14,00/13,00/10,00
5,00kW	S-50PF1E5B	5,00	5,60	290 x 800 x 700	150/70/10	34/30/26	16,00/15,00/12,00
6,00kW	S-60PF1E5B	6,00	7,00	290 x 1000 x 700	150/70/10	35/32/26	21,00/19,00/15,00
7,10kW	S-71PF1E5B	7,10	8,00	290 x 1000 x 700	150/70/10	35/32/26	21,00/19,00/15,00
10,00kW	S-100PF1E5B	10,00	11,20	290 x 1400 x 700	150/100/10	38/34/31	32,00/26,00/21,00
12,50kW	S-125PF1E5B	12,50	14,00	290 x 1400 x 700	150/100/10	39/35/32	34,00/29,00/23,00
14,00kW	S-140PF1E5B	14,00	14,00	290 x 1400 x 700	150/100/10	40/36/33	36,00/32,00/25,00

Low Static Pressure Hide Away	Indoor	Cooling capacity	Heating capacity	Dimension	External static pressure	Sound pressure	Air volume
				H x W x D	Hi / Med / Lo	Hi / Med / Lo	Hi / Med / Lo
				mm	Pa	dB(A)	m <sup>3</sup> /min
3,60kW	S-36PN1E5B	3,60	4,20	250 x 780 x 650	80/50/10	40/38/35	14,00/14,00
4,50kW	S-45PN1E5B	4,50	5,20	250 x 780 x 650	80/50/10	41/39/35	16,00/16,00
5,00kW	S-50PN1E5B	5,00	5,60	250 x 780 x 650	80/50/10	41/39/35	16,00/16,00
6,00kW	S-60PN1E5B	6,00	7,00	250 x 1000 x 650	80/50/10	43/41/36	22,00/22,00
7,10kW	S-71PN1E5B	7,10	8,00	250 x 1000 x 650	80/50/10	43/41/36	22,00/22,00
10,00kW	S-100PN1E5B	10,00	11,20	250 x 1200 x 650	80/50/10	44/42/37	36,00/36,00
12,50kW	S-125PN1E5B	12,50	14,00	250 x 1200 x 650	80/50/10	46/44/39	38,00/38,00
14,00kW	S-140PN1E5B	14,00	14,00	250 x 1200 x 650	80/50/10	46/44/39	40,00/40,00



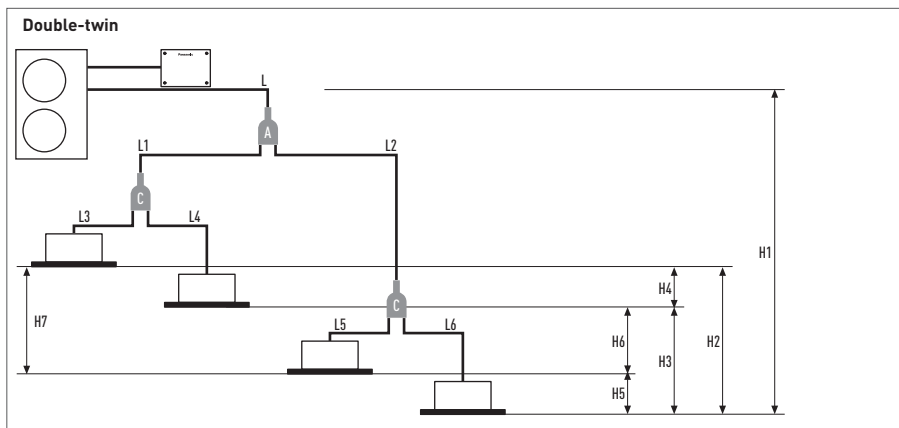
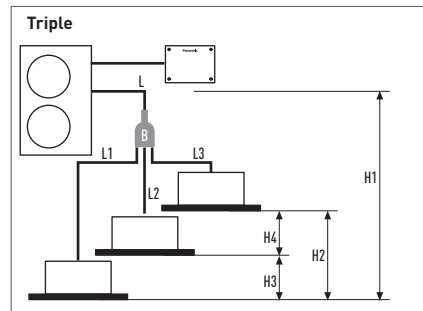
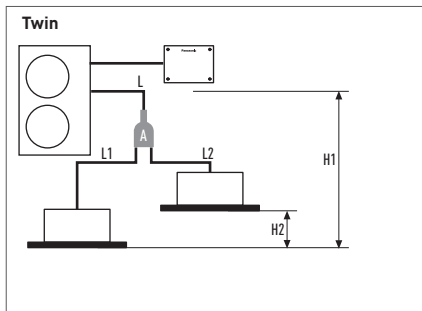
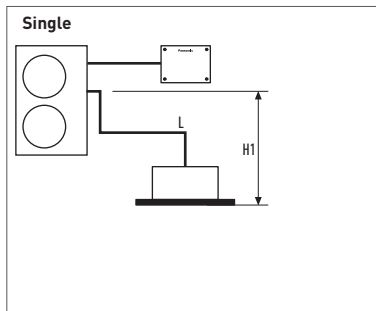

**PACi Standard Twin System from 10,0 to 14,0kW**  
 Joint distribution (sold separately)  
 A= CZ-P224BK2BM

**PACi Elite Twin, Triple and Double-Twin System from 7,1 to 14,0kW**  
 Joint distribution (sold separately)  
 A= CZ-P224BK2BM  
 B= CZ-P3HPC2BM  
 C= CZ-P224BK2BM

**PACi Elite Twin, Triple and Double-Twin System from 20,0 to 25,0kW**  
 Joint distribution (sold separately)  
 A = CZ-P680BK2BM  
 B = CZ-P3HPC2BM  
 C = CZ-P224BK2BM

Twin System	PACi Standard Single and Twin System from 10,00 to 14,0kW			PACi Elite Twin, Triple and Double-Twin System from 7,10 to 25kW					
	Indoor unit combinations (see examples above)		Equivalent lengths and height differences (m) for outdoor unit sizes...	Indoor unit combinations (see examples above)				Equivalent lengths and height differences (m) for outdoor unit sizes from 7,10 to 14,0kW	Equivalent lengths and height differences (m) for outdoor unit sizes from 20,00 to 25,0kW
	Single	Twin		Single	Twin	Triple	Double-Twin		
Total pipe length	L	L + L1 + L2	≤ 50m	L	L + L1 + L2	L + L1 + L2 + L3	L + L1 + L2 + L3 + L4 + L5 + L6	U-60/U-71: ≤ 50m U-100/125/140: ≤ 75m	≤ 100m
Maximum pipe length from outdoor unit to most distant indoor unit	-	-	-	-	L + L1 or L + L2	L + L1 or L + L2 or L + L3	L + L1 + L3 or L + L1 + L4 or L + L2 + L5 or L + L2 + L6	-	≤ 100m
Maximum branch pipe length	-	L1 L2	≤ 15	-	L1 or L2	L1 or L2 or L3	L1 + L3 or L1 + L4 or L2 + L5 or L2 + L6	≤ 15m	≤ 20m
Maximum branch pipe length differences	-	L1 > L2 L1 - L2	≤ 10	-	L1 > L2: L1 - L2	L1 > L2 > L3: L1 - L2 L2 - L3 L1 - L3	L2 + L6 (Max.) L1 + L3 (Min.): [L2 + L6] - (L1 + L3)	≤ 10m	≤ 10m
Maximum pipe length differences after first branch (Double-Twin)	-	-	-	-	-	-	L2 > L1: L2 - L1	≤ 10m	≤ 10m
Maximum pipe length differences after second branch (Double-Twin)	-	-	-	-	-	-	L4 > L3: L4 - L3 L6 > L5: L6 - L5	≤ 10m	≤ 10m
Height difference (outdoor unit located higher)	H1	H1	≤ 30	H1	H1	H1	H1	≤ 30m	≤ 30m
Height difference (outdoor unit located lower)	H1	H1	≤ 15	H1	H1	H1	H1	≤ 15m	≤ 15m
Height difference between indoor units	-	H2	≤ 0,5	-	H2	H2 or H3 or H4	H2 or H3 or H4 or H5 or H6	≤ 0,5m	≤ 0,5m

Twin System	PACi Standard Single and Twin System from 10,00 to 14,0kW				PACi Elite Twin, Triple and Double-Twin System from 7,10 to 14,0kW						PACi Elite Twin, Triple and Double-Twin System from 20,00 to 25,0kW				
	Outdoor unit main pipe diameter (L)		Indoor unit connection tube (L1, L2)		Outdoor unit main pipe diameter (L)		Indoor unit connection pipe diameter (L1, L2, L3, L4) (mm)				Outdoor unit main pipe diameter (L) (mm)		Double-Twin distribution pipe (L1, L2) <sup>1</sup>		Indoor unit connection pipe diameter
Unit type capacity	100	125	50	60	71 - 140	36	45	50	60	71	200	250	100 - 125	50	60 - 125
Liquid pipe (mm)	Ø 9,52	Ø 12,70	Ø 6,35	Ø 9,52	Ø 9,52	Ø 6,35	Ø 6,35	Ø 6,35	Ø 9,52	Ø 9,52	Ø 9,52	Ø 12,70	Ø 9,52	Ø 6,35	Ø 9,52
Gas pipe (mm)	Ø 15,88	Ø 15,88	Ø 12,70	Ø 15,88	Ø 15,88	Ø 12,70	Ø 12,70	Ø 12,70	Ø 15,88	Ø 15,88	Ø 25,40	Ø 25,40	Ø 15,88	Ø 12,70	Ø 15,88
Additional gas amount (g/m)	50	50	20	50	50	20	20	20	50	50	40	80	40	20	40

1. Total capacity of indoor unit connected after the branch

Refrigerant charging: For the twin connection, the amount of refrigerant required for pipe length 30m has been included in this unit at the factory while that required for pipe length 20 m has been included for the Triple / Double-Twin connections. No Additional gas amount is required for the first 30m pipe length in the case of the twin connection and for the first 20m in the case of the Triple / Double-Twin connections. The amount of included refrigerant for each model is listed on NAMA PLATE. Make Additional gas amounts by adding up pipe length in an order of main (L branch pipe), (L1, L2, L3 wide diameter) and then selecting the amount of refrigerant corresponding to the remaining (after 30m for the Twin connection and after 20m for the Triple / Double-Twin connections) liquid side pipe diameter and pipe length from the below table.

Rating Conditions: Cooling Indoor 27°C DB / 19°C WB. Cooling Outdoor 35°C DB / 24°C WB. Heating Indoor 20°C DB. Heating Outdoor 7°C DB / 6°C WB. (DB: Dry Bulb; WB: Wet Bulb) Specifications subject to change without notice. For detailed information about ErP, please visit our websites www.aircon.panasonic.eu or www.ptc.panasonic.eu.

# PANASONIC VENTILATION SOLUTIONS



Panasonic ventilation solutions for maximum savings and easy integration.

**AHU Kit connects PACi outdoor units to Air Handling Units system<sup>1</sup>**

Heat exchanger, Fan & Fan motor to be mounted in AHU Kit shall be provided in the field.

AHU connection Kit (field supplied) AHU Kit system. (Contents of kit: Control for PCB, expansion valve, sensors).



Application: Hotels, offices, server rooms or all large buildings where air quality control such as humidity control and fresh air and is needed.

AHU Kit combines air conditioning and fresh air in just one solution. The Panasonic AHU Kits offer a wealth of connectivity possibilities so can be easily integrated into many systems.

Besides the advantages in terms of indoor air quality, air conditioning offers also an energy saving potential. For example, while uncontrolled ventilation through open windows leads to large amounts of heat being lost to the outside during the heating season or gained from the outside during the cooling season, air conditioning systems provide possibilities to utilize the extra "free" energy in heat recovery modules so that overall operating costs will be reduced.

The larger the area of the comfort range, the better the energy saving opportunities.

<sup>1</sup>) Connectable to R32 or R410A. Compatible with R32 models. Special setting is required.

**Air Curtain with DX Coil<sup>1</sup>**

**Highly efficient heating effect**

The combined air stream, which has a desirable low air current induction factor (mixing factor), can carry the selected initial temperature effect over long distances, and will reach the floor area while still at room temperature. This is necessary to avoid cooling down the interior spaces.



The Panasonic range of air curtains is designed for smooth operation and efficient performance. Air curtains produce a continuous stream of air blown from the top to the bottom of an open doorway and create a barrier that people and products can flow across, but air can't. Designed to improve energy efficiency, minimise heat loss from a building, and to allow retailers to keep doors open to encourage customers, our Air Curtains are suitable for connection to both VRF and PACi Systems.

Heating capacity comparison: Electrical air curtain / Panasonic air curtain

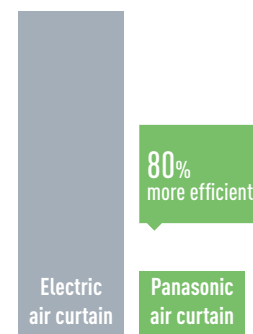

\* With the U-100PE1E5A on the PAW-20PAIRC-MS. Calculation method: Taking as consideration SCOP of the Panasonic combination of 6.0. If 100 is the energy needed for a air curtain, Panasonic Air curtain will need 1/(1-6)\*100=20.

**NEW ELECTRIC AIR CURTAIN**

**1 Newly designed to maximize performance**

High Air volume upgraded 145% compared to conventional model (in the case of FY-3009U1).

**2 Comprehensive product line up**

1,5m wide model added in the line up.

**3 Easier installation & maintenance**

Simple structure for easy installation & maintenance.



		FY-3009U1	FY-3012U1	FY-3015U1
Width	mm	900	1200	1500
Voltage	V	220	220	220
Air volume	Hi / Lo m <sup>3</sup> /h	1100 / 920	1400 / 1270	2000 / 1800
Consumption	Hi / Lo W	76 / 70	94 / 85	131 / 110
Current	Hi / Lo A	0,35 / 0,32	0,43 / 0,40	0,59 / 0,50
Air speed	Hi / Lo m/s	10,50 / 8,50	9,50 / 8,00	10,50 / 9,50
Dimension	H x W x D mm	900 x 231,5 x 212	1200 x 231,5 x 212	1500 x 231,5 x 212
Weight	kg	12,0	14,5	18,0
Sound pressure	dB(A)	48,5 / 45,0	48,5 / 44,5	51,5 / 48,0

# AIR HANDLING UNIT KIT 10-25kW FOR PACi. COMPATIBLE WITH R32 OR R410A OUTDOOR UNITS



## Panasonic AHU Kit, 10-25kW connected to PACi outdoor unit

The Air Handling Unit Kit has been developed to better meet customer demand: IP 65 Box in order to be installed outside, 0-10V demand control\* and easy control by BMS

\* Only available with Elite PACi, up to from 6kW to 14kW.

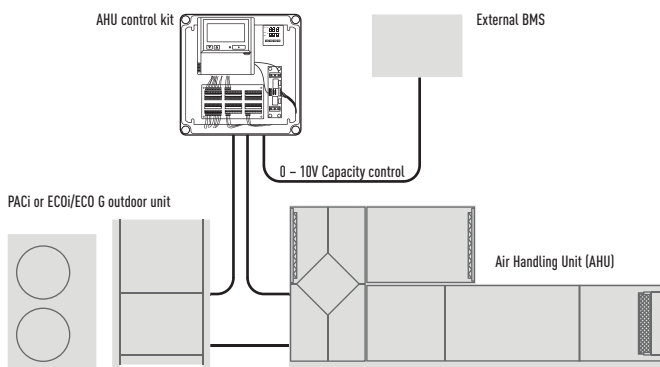

Demand control on the outdoor unit managed by external 0-10 V signal.

### Control option 1: PAW-280PAH2L

- The system's control is simple: control of actual suction temperature vs. set point
- Control works in the same way as that of any indoor unit
- Fan signal issued by the PCB (OFF while defrosting, for instance)

### Control option 2: PAW-280PAH2

- System control by probe located at air intake. Sensor works as a 0-10V control thermostat which manages the set point temperature. Control to prevent cold draughts.

• All signals as per standard

### Control option 3: PAW-280PAH2

- System control by external environment probe. Sensor works as a 0-10V control thermostat which manages the set point temperature. Enhances efficiency by adjusting capacity to the ambient temperature and enhances comfort as well.

• All signals as per standard

### Control option 4: PAW-280PAH2

- System control by a 0-10V control working from an external BMS that manages the set point for the temperature or the capacity. Enhances efficiency by adjusting capacity to the ambient temperature and enhances comfort as well.

• All signals as per standard

## Main components of mechanical ventilation systems

The main components of a mechanical ventilation system are the following: Air Handling Unit (AHU), air ducts and air distribution elements.

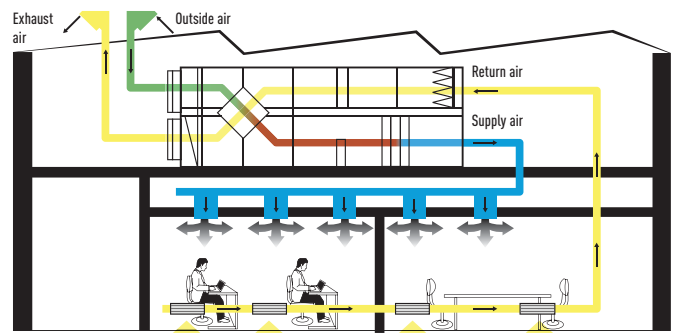

## 0-10V control

With the 0-10 v demand control the capacity of the outdoor unit can be controlled by 20 steps.

### With the included resistance. 0-10V control scheme with 10V= maximum capacity

Input Voltage* (V)	0 - 0,55	1,1	1,65	2,2	2,8	3,35	3,9	4,45	5,0	5,55	6,1	6,65	7,2	7,8	8,35	8,9	9,45	10,0
Demand (% of nominal current)	Stop <sup>1</sup>	40	45	50	55	60	65	70	75	80	85	90	95	100	105	110	115	No limit / Full capacity <sup>3</sup>

### When you remove the resistance. 0-10V control scheme with 10V= Thermo-Off

Input Voltage* (V)	0 - 0,5	1,0	1,5	2,0	2,5	3,0	3,5	4,0	4,5	5,0	5,5	6,0	6,5	7,0	7,5	8,0	8,5	9,0	9,5 - 10,0
Demand (% of nominal current)	Stop <sup>1</sup>	40	45	50	55	60	65	70	75	80	85	90	95	100	105	110	115	No limit <sup>2</sup>	Thermo-Off <sup>3</sup>

\* If a voltage range (0 - 0,5 or 9,5 - 10,0V) is indicated, the applied voltage must be within the given limits.

However, if a single value (e.g. 1,0V) is indicated, the applied voltage must be within +/-0,1V of the given value to achieve the assigned demand setting.

Examples: "Stop" can be achieved with any analogue input value greater than 0V and less than or equal to 0,5 V; 40% demand can be achieved with any analogue input value greater than or equal to 0,9V and less than or equal to 1,1V etc.

1) Stop: AHU system / indoor unit is completely switched off.

2) No Limit: No restrictions applied by BMS to AHU system / indoor unit performance (equivalent to "full-load operation" of AHU system / indoor unit).

3) Thermo-Off: No cooling / heating operation (compressor is switched off; however, the fans may still be operating). For example, forced Thermostat-Off mode can be used for free cooling.

AHU Kit connects PACi outdoor units to Air Handling Units system.  
 The Panasonic AHU Kits offer a wealth of connectivity possibilities so can be easily integrated into many systems.  
 Application: Hotels, offices, server rooms or all large buildings where air quality control such as humidity control and fresh air and is needed.

**3 types of AHU Kit: Deluxe, Medium and Light.**

Model Code	IP 65	0-10V demand control*	Outdoor temperature shift compensation. Cold draft prevention
PAW-280PAH2	Yes	Yes	Yes
PAW-280PAH2M	Yes	Yes	No
PAW-280PAH2L	Yes	No	No

\* With CZ-CAPBC2.

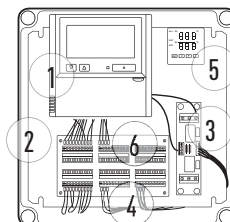

1. Remote control CZ-RTC4
2. New plastic IP 65 Box
3. PAW-T10 PCB for dry contact
4. 0-10V demand control PCB
5. Intelligent thermostat for:
  - Cold draft prevention
  - Outdoor temperature shift compensation
6. Terminal base for sensors and power supply

**System & regulations. System overview**

1. AHU Kit equipment (Field supplied)
2. AHU Kit system controller (Field supplied)
3. AHU Kit controller box (with control PCB)
4. Thermistor for Gas pipe (E2)
5. Thermistor for Liquid pipe (E1)
6. Thermistor for Suction air
7. Inter-unit wiring
8. Outdoor unit

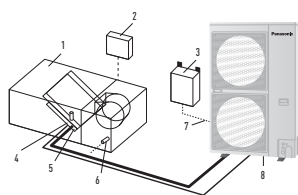

**AHU Connection Kit**



PCB, Power trans, Terminal block



Thermistor x2 (Refrigerant: E1, E2)



Thermistor (Air: TA; 1 sensor)



Standard wired remote controller.

**Optional parts: Following functions are available by using different control accessories:**

**CZ-RTC4 Timer remote controller.**

- Operation-ON/OFF
- Mode select
- Temperature setting

\* Fan operation signal can be taken from the PCB.

**PAW-OCT, DC12 V outlet. OPTION terminal.**

- Output signal= Cooling/Heating/Fan status
- Defrost
- Thermostat-ON

**CZ-CAPBC2 Mini seri-para I/O unit (advanced version only).**

- Easy integration in external AHU control systems and BMS
- Demand control: 40 to 115 % [5 % steps] of nominal current by 0-10 V input signal\*
- Target temperature setting by 0-10 V or 0-140 Ω input signal\*
- Room supply air temperature output by 4-20 mA signal
- Mode select or/and ON/OFF control
- Fan operation control
- Operation status output/ Alarm output
- Thermostat ON/OFF control

\* Demand control by external BMS cannot be combined with the demand control or target temperature setting accomplished by the thermostat. However, if simultaneous demand control and target temperature setting is needed, this can only be achieved by using a second (optional) CZ-CAPBC2 interface.

**CZ-T10 terminal / PAW-T10 PCB to connect to T10 connector.**

- A Dry contact PCB has been developed to easily control the unit
- Input signal operation ON/OFF
- Remote control prohibition
- Output signal Operation ON status maximum 230 V 5 A (NO/NC)
- Output signal alarm status max. 230 V 5 A (NO/NC)
- Alarm output (by DC12V)
- Additional available contacts:
  - External humidifier control (ON/OFF) 230 VAC 3 A
  - External fan control (ON/OFF) 12V DC
  - External filter status signal potential free
  - External float switch signal potential free
  - External leakage detection sensor or TH. OFF contact potential free (possible usage for external blow out temperature control)

AHU PACi Elite	Cooling capacity	Heating capacity	Air volume	Dimensions	Piping length	Elevation difference (in/out)
	Nominal kW	Nominal kW	High / Low m³/min	HxBxD mm	Min / Max m	Min / Max m
PAW-280PAH2	6,00 / 25,00	7,00 / 28,00	8,00 / 74,00	404x425x78	5 / 30*	10
PAW-280PAH2+PAW-280PAH2	50,00	56,00	38,00 / 148,00	404x425x78	5 / 30*	10

\* For U-200PEZE8A and U-250PEZE8A.

AHU connection kit / System combination	Outdoor unit capacity	AHU	Air volume	Dimensions	Piping length	Elevation difference (in/out)	Piping connections	
			High / Low m³/min	HxBxD mm	Min / Max m	Min / Max m	Liquid pipe Tum (mm)	Gas pipe Tum (mm)
<b>5,00kW</b>	PAW-280PAH2	PAW-280PAH2	8,00 / 13,00	404x425x78	5/30	10	1/4 (6,35)	1/2 (12,70)
<b>6,00kW</b>	PAW-280PAH2	PAW-280PAH2	9,00 / 16,00	404x425x78	5/30	10	3/8 (9,62)	5/8 (15,88)
<b>7,5kW</b>	PAW-280PAH2	PAW-280PAH2	12,00 / 25,00	404x425x78	5/30	10	3/8 (9,62)	5/8 (15,88)
<b>10,00kW</b>	PAW-280PAH2	PAW-280PAH2	14,00 / 33,00	404x425x78	5/30	10	3/8 (9,62)	5/8 (15,88)
<b>12,50kW</b>	PAW-280PAH2	PAW-280PAH2	19,00 / 35,00	404x425x78	5/30	10	3/8 (9,62)	5/8 (15,88)
<b>14,00kW</b>	PAW-280PAH2	PAW-280PAH2	19,00 / 35,00	404x425x78	5/30	10	3/8 (9,62)	5/8 (15,88)
<b>20,00kW</b>	PAW-280PAH2	PAW-280PAH2	28,00 / 66,00	404x425x78	5/70	10	3/8 (9,62)	1 (25,40)
<b>25,00kW</b>	PAW-280PAH2	PAW-280PAH2	38,00 / 74,00	404x425x78	5/70	10	1/2 (12,70)	1 (25,40)

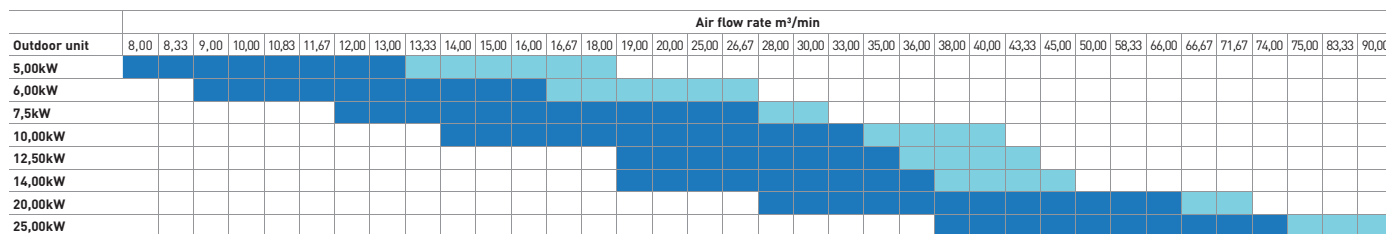

Standard condition in cooling mode intake air temperature. Rating Conditions: Cooling Indoor 27°C DB / 19°C WB.

Maximum condition in cooling mode intake air restriction temperature Min18°C DB / 13°C WB Max 32°C DB / 23°C WB

## AIR CURTAIN WITH DX COIL, CONNECTED TO THE VRF OR PACi SYSTEMS. COMPATIBLE WITH R32 OR R410A OUTDOOR UNITS

### Highly efficient heating effect

The combined air stream, which has a desirable low air current induction factor (mixing factor), can carry the selected initial temperature effect over long distances, and will reach the floor area while still at room temperature. This is necessary to avoid cooling down the interior spaces. Available in different lengths to suit requirements between 1 and 2,5m, both air curtains have outlet grilles that can be adjusted to five different positions. The jet flow model can be installed up to a height of 3,5m with the standard model up to 3,0m. The outlet grilles can be easily adjusted into five positions to suit different installation requirements and the air filter can be accessed without the need for specialist tools.

- High performance with EC fan motor (40% lower running costs compared to a standard AC fan motor)
- Easy Cleaning and Servicing
- Can be connected to either Panasonic VRF or PACi systems
- Built-in drain for cooling operation
- Standard and Jet Flow air curtains can be controlled via Panasonic's range of remote internet controls

The standard and jet-flow models are ideal for connection to a ECOi or PACi system. With simple "plug and play" installation, both are fitted with an EC fan motor for a smooth operation and efficient performance. This fan guarantees 40% lower running cost than with a standard AC fan motor. Air curtains run approximately 12 hours per day at shops, and efficient performance contributes to energy savings.

### Internet Control

An app added to your tablet or smartphone or via the Internet allows you to control and manage the system remotely. There is also the option to integrate into existing BMS systems by using other Panasonic interfaces.

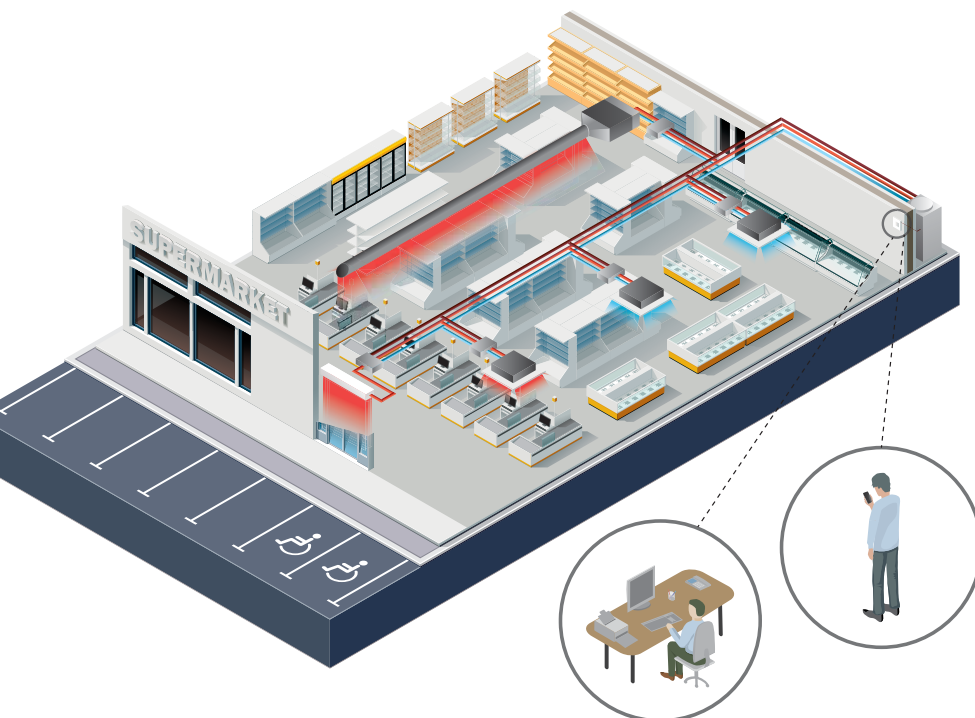

### Intelligent Operation

Our air curtains combine airflow and heating / cooling technology to ensure optimum comfort and energy efficiency whilst also creating an effective barrier between indoor and outdoor environments. Design and installation is key to achieving the correct height / temperature settings to achieve optimum performance. Our air curtains are designed to answer the demands of the retail, commercial and industrial markets.

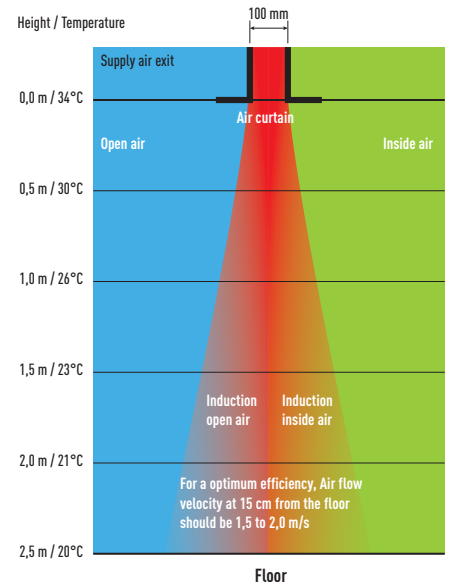

### How does it work?

Stale air from the room is taken in and ejected near the door. This creates a 'roll of air' that shields the door area, mixing with the colder incoming air. It then turns away from the door, back into the room and toward the intake screen, where it is partly drawn in again. This flow of air helps to create a barrier for heat loss yet at the same time refreshes room air

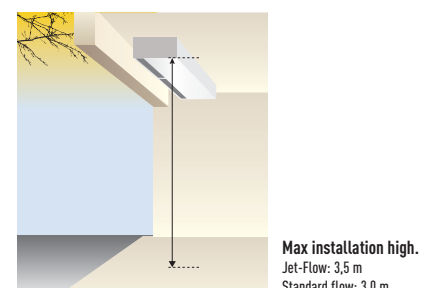



High efficiency air curtain connected to your VRF installation. EC Fan motor for a smooth operation and efficient performance. 2 types of air flow available: Jet-Flow and Standard. Easy cleaning and servicing.

**Technical focus**

- Save up to 40% energy costs by use of the integrated EC fan technology (higher efficiency than conventional AC fan, soft start and longer motor duration)
- 3 lengths of air curtains Jet-Flow, from 1,0 to 2,0 m and 2 lengths of air curtains Standard, 1,0 and 2,0 m
- Installation height up to 3,5 m (Jet-Flow) and 3,0 m (Standard)
- Outlet grilles can be adjusted in five positions, to suite different indoor and installation requirements (Jet-Flow)
- Control with Panasonic remote control systems (optional)
- Direct integration to BMS by optional Panasonic interfaces
- Drain included for cooling operation

**Features**

**Comfort.**

- Easy redirection of Airflow by means of manual deflector (Jet-Flow)

**Ease of use.**

- Speed selector (high and low) on the unit itself

**Easy installation and maintenance.**

- Easy installation
- Compact dimensions improve installation and positioning (Jet-Flow)
- Easy cleaning of grid without opening of the unit

**Optimised airflow velocity**

1. Energy losses, no air curtain installed
2. Too low velocity air curtain – air curtain not efficient
3. Optimum results with the Tekadood air curtain connected to Panasonic VRF
4. Too high velocity air curtain – considerable turbulence, energy lost to the outside, air curtain not efficient

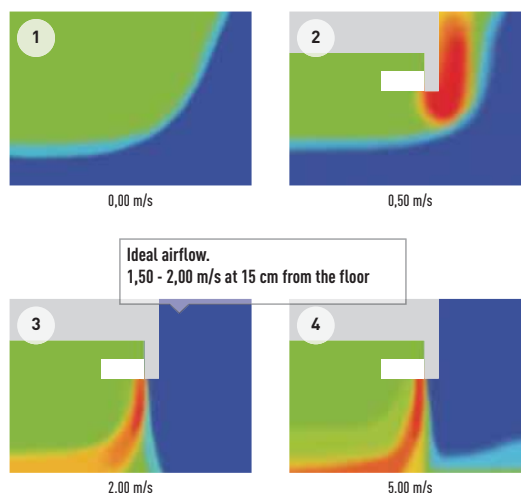

HP			4HP	6HP	8HP	4HP	8HP
Air Curtain			PAW-10PAIRC-MJ	PAW-15PAIRC-MJ	PAW-20PAIRC-MJ	PAW-10PAIRC-MS	PAW-20PAIRC-MS
Air Flow type			Jet-Flow			Standard	
Air Flow length (A)	m		1,0	1,5	2,0	1,0	2,0
Air volume	High / Medium / Low	m <sup>3</sup> /min	30,00/25,00/20,00	45,00/38,30/31,70	60,00/50,00/41,70	30,00/25,00/20,00	45,00/38,30/31,70
Cooling capacity 1		kW	9,2	17,5	23,1	9,2	17,5
Heating capacity with air in 20°C, air out 40 / 35 / 30°C		kW	11,90/8,90/5,90	17,90/13,40/8,90	23,90/17,90/11,90	11,90/8,90/5,90	17,90/13,40/8,90
Max installation height	Good / Normal / Bad	m	3,50/3,10/2,70	3,50/3,10/2,70	3,50/3,10/2,70	3,00/2,70/2,40	3,00/2,70/2,40
Refrigerant			R410A	R410A	R410A	R410A	R410A
Liquid pipe		Inch (mm)	3/8(9,52)	3/8(9,52)	3/8(9,52)	3/8(9,52)	3/8(9,52)
Gas pipe		Inch (mm)	5/8(15,88)	3/4(19,05)	7/8(22,22)	5/8(15,88)	7/8(22,22)
Fan			230V/50Hz/1/N/PE	230V/50Hz/1/N/PE	230V/50Hz/1/N/PE	230V/50Hz/1/N/PE	230V/50Hz/1/N/PE
Fan type			EC	EC	EC	EC	EC
Currency	High / Med / Low	A	2,10/0,80/0,30	2,80/1,10/0,40	4,20/1,60/0,60	2,10/0,80/0,30	4,20/1,60/0,60
Electrical Consumption	High / Med / Low	kW	0,44/0,17/0,06	0,59/0,23/0,08	0,89/0,34/0,12	0,44/0,17/0,06	0,89/0,34/0,12
Protecting Fuse		A	M16A	M16A	M16A	M16A	M16A
Noise		dB(A)	40-55	40-56	40-57	40-55	40-57
Dimension / Net weight	H x W x D	mm / kg	260 x 1210 x 590 / 70	260 x 1710 x 590 / 100	260 x 2210 x 590 / 138	260 x 1210 x 490 / 60	260 x 2210 x 490 / 128
PACi Elite with air out 40°C			10,00kW	14,00kW	20,00kW	10,00kW	14,00kW
PACi Standard with air out 40°C			10,00kW	—	—	10,00kW	—
PACi Elite with air out 35°C			7,10kW	10,00kW	14,00kW	7,10kW	10,00kW
PACi Standard with air out 35°C			10,00kW	10,00kW	—	10,00kW	10,00kW
PACi Elite with air out 30°C			5,00kW	10,00kW	10,00kW	5,00kW	10,00kW
PACi Standard with air out 30°C			6,00kW	10,00kW	10,00kW	6,00kW	10,00kW

All combinations under rated conditions: Heating Outdoor +7°C DB/+6°C WB Indoor +20°C DB. In case of lower outdoor temperatures a higher capacity outdoor unit model may be necessary. 1) Rated Conditions Cooling Outdoor +35°C DB Indoor +27°C DB/+19°C WB, Discharge temperature 3 16°C.



# PANASONIC PACi ELITE CAN COOL ROOMS DOWN TO 8°C



**SPECIAL  
APPLICATION  
SUCH AS WINE  
CELLARS**

## Solutions for refrigeration rooms. Set the room temperature to 8°C

There is a complete range, from 3,60 to 23,20kW. This unique solution is perfect for:  
Wine cellars, ice cream factories, flower shops, supermarkets, grain stores, food storage, food processing, food distribution, lunchrooms, vegetable processing... Just like all the indoor units in the PACi range, these units can be monitored via the Internet, generating an alarm if there is a breakdown.







**Alternative controller.**  
Wired remote control.  
CZ-RTC5B

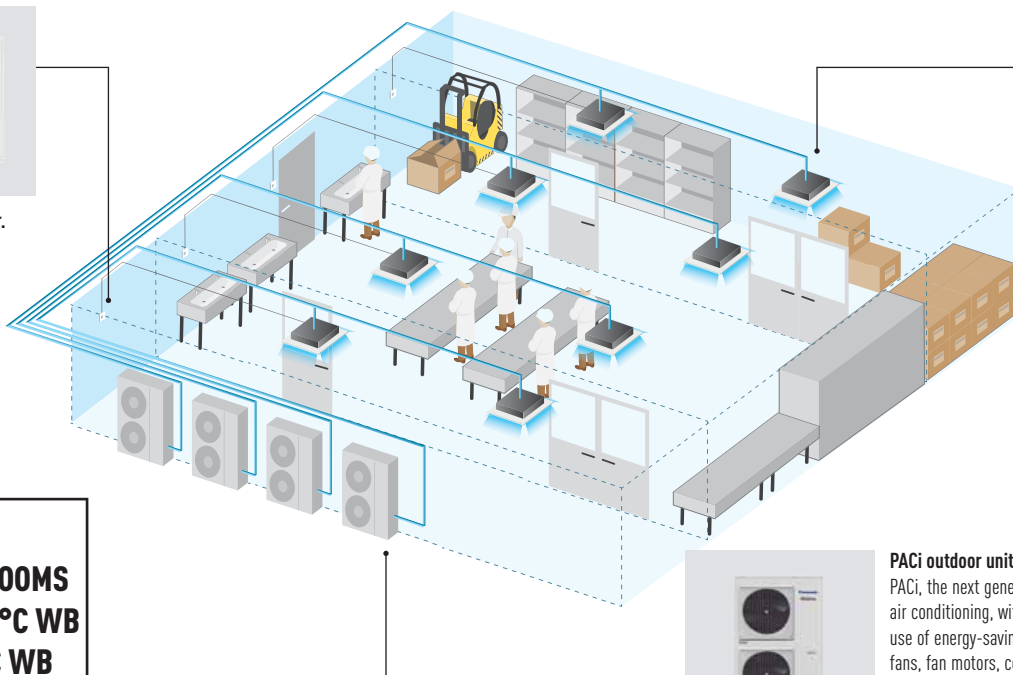

**Wide range of indoor units.**  
To meet your company's needs

**COOLING ROOMS  
BETWEEN 8°C WB  
AND 24°C WB**



**PACi outdoor unit.**  
PACi, the next generation of developed commercial air conditioning, with an energy-saving concept. The use of energy-saving designs in the construction of fans, fan motors, compressors and heat exchangers has resulted in a high COP value.

**Wine cellars and special low temperature rooms**

One of the main features of the PACi series is the possibility of adjusting the product for special applications, not just for regular heating and cooling applications. The purpose of this product information is to explain in detail these special applications that need a cooling operation to maintain the room temperature at +8 ~ +24°C WB (or +10 ~ +30°C DB). In order to do this in terms of enthalpy, the indoor unit needs to be oversized and certain parameters need to be adjustable.

Temperature range – temperature range for wine cellar

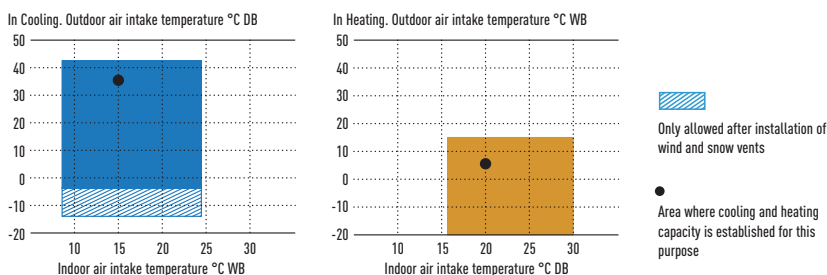

Temperature range for wine cellar

	Indoor	Outdoor
Cooling operation	+8 ~ +24°C WB	-5 (-15) ~ 43°C DB

**Examples of installations:**

To avoid the growth of bacteria and to increase food safety: Wine cellars, ice cream factories, flower shops, broiler factories, pantries in hotels, supermarkets, grain stores, food storage, food processing, food distribution, lunchrooms, salad processing ...

Application	Single						Twin		
	3,50kW	4,90kW	5,80kW	6,90kW	9,30kW	11,60kW	13,60kW	18,50kW	23,20kW
Cooling capacity	U-36PE2E5A	U-50PE2E5A	U-60PE2E5A	U-71PE1E5A U-71PE1E8A	U-100PE1E5A U-100PE1E8A	U-125PE1E5A U-125PE1E8A	U-140PE1E5A U-140PE1E8A	U-200PE2E8A	U-250PE2E8A
PACi outdoor units									
PACi indoor units									
	S-60PT2E5B	S-71PT2E5B	S-100PT2E5B	S-125PT2E5B	S-140PT2E5B	S-140PT2E5B	S-100PT2E5B + S-100PT2E5B	S-125PT2E5B + S-125PT2E5B	S-140PT2E5B + S-140PT2E5B
	S-60PF1E5B	S-71PF1E5B	S-100PF1E5B	S-125PF1E5B	S-140PF1E5B	S-140PF1E5B	S-100PF1E5B + S-100PF1E5B	S-125PF1E5B + S-125PF1E5B	S-140PF1E5B + S-140PF1E5B
	S-60PN1E5B	S-71PN1E5B	S-100PN1E5B	S-125PN1E5B	S-140PN1E5B	S-140PN1E5B	S-100PN1E5B + S-100PN1E5B	S-125PN1E5B + S-125PN1E5B	S-140PN1E5B + S-140PN1E5B

\* Above combinations require a special field setting. Please contact authorized Panasonic dealer.

# R22 RENEWAL FAST, EASY TO INSTALL AND COST EFFECTIVE



An important drive to further reduce the potential damage to our ozone  
It is often said that legislation is ruling our lives but sometimes it is there to help save  
lives. R22 phase out can be described as one of these and from Jan 1st 2010 the use of  
Virgin (new) R22 refrigerant was banned within the European Union.

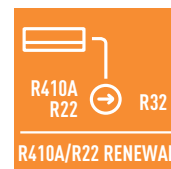

### Panasonic is doing its part

We at Panasonic are also doing our part – recognising that all finances are under pressure at the moment. Panasonic has developed a clean and cost effective solution to enable this latest legislation to offer less financial impact on your business.

The Panasonic renewal system allows good quality existing R22 pipe work to be re-used whilst installing new high efficiency R410A / R32 systems. By bringing a simple solution to the problem Panasonic can renew all Split Systems and PACi systems; and depending upon certain restrictions we don't even limit the manufacturer's equipment we are replacing. By installing a new high efficiency Panasonic R410A / R32 system you can benefit from around 30% running cost saving compared to the R22 system.

Yes...

1. Check the capacity of the system you wish to replace
  2. Select from the Panasonic range the best system to replace it with
  3. Follow the procedure detailed in the brochure and technical data
- Simple...



### Why renewal?

**Unique R22 Renewal from Panasonic: Fast, easy to install and cost effective.**

- Panasonic refrigerant oil doesn't react to the most common oil types used in air-conditioning systems. This ensures the mix of oil does not damage the units. Therefore installations are easier

- All Panasonic PACi units can be installed in R22 pipings, no specific models are available
- Up to 33 Bar! When there is any doubt about the strength of the piping, the maximum working pressure can be reduced to 33 Bar with a setting in the software of the outdoor unit

### Reuse of existing piping (renewal design & installation)

#### Notes on reuse of existing refrigerant piping.

It is possible for each series of PE1 / PE2 type and PEY2 an PZ type outdoor unit to reuse the existing refrigerant piping without cleaning when obtained under certain conditions. Make sure that the requirements under the section "Notes on reuse of existing refrigerant piping", "Measurement procedure for renewal" and "Refrigerant piping size and allowable piping length" will be satisfied in order to carry out.

Also, check the items with regard to section "Safety" and "Cleaning".

#### 1. Prerequisite

- If the refrigerant used for the existing unit is other than R22, R407C and R410A / R32, the existing refrigerant piping cannot be used.
- If the existing unit has another use than air conditioning, then existing refrigerant piping cannot be used.

#### 2. Safety

- If there is a hollow, crack or corrosion on the piping, make sure to install new piping.
- If the existing piping is other than capable of reuse of piping as shown in the flowchart, make sure to install new piping.

- In case of multiple operation, use our genuine branch piping for refrigerant R410A / R32.

A local supplier shall assume responsibility for the defects and hollows on the reuse of existing piping surface and recognition of reliability of the piping strength. There is no guarantee that we take responsibility for such damages. The operational pressure of the refrigerant R410A / R32 becomes higher compared to R22. In the worst case, a lack of compressive strength may lead to piping explosion.

#### 3. Cleaning

- When the refrigerant oil used for the existing unit is other than the listed below, make sure to install new piping or wash it thoroughly before reusing it.  
[Mineral Oil] SUNISO, FIORE S, MS  
[Synthesized oil] alkyl benzene oil (HAB, parallel freeze), ester oil, ether oil (PVE only)

If the existing unit is GHP type, it is necessary to wash the piping thoroughly.

- If the existing pipes in the outdoor and indoor units remain disconnected, make sure to install a new piping or wash it thoroughly before reusing it.
- If the discoloured oil or residue remains in the existing piping, make sure to install a new piping or wash it thoroughly before reusing it. See "Deterioration Criteria for Refrigerant Oil" in table 3.
- If the compressor of the existing air conditioner has a failure history, make sure to install a new piping or wash it through thoroughly before reusing it.

When reusing the existing piping as it is without removing dirt and dust, inadequate piping could result a renewal appliance in failure.

**Notes on renewal for simultaneous operation of multiple units**

Only main pipe is applicable for using the different diameter size.  
 In case of different diameter size for the branch pipes, a new installation work for a standard size is necessary.  
 Be sure to use our genuine branch piping for refrigerant R410A / R32.

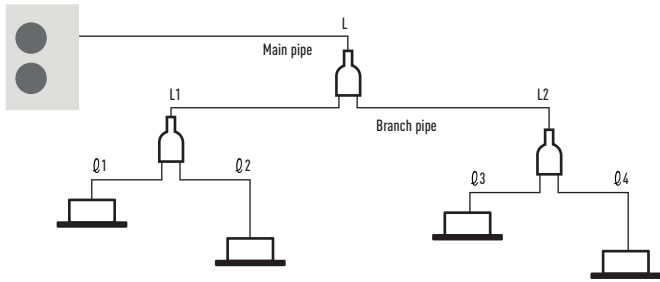

**Notes on renewal for simultaneous operation of multiple units**

Capacity class	Standard liquid pipe size	Standard gas pipe size
Type 50	∅ 6,35	∅ 12,70
Type from 60 to 140	∅ 9,52	∅ 15,88
Type 200	∅ 9,52	∅ 25,40
Type 250	∅ 12,70	

- Only the main pipe L can be used among different diameter's existing piping
- Installation work as a standard size is capable for L1, L2, l1 - l4 piping
- Be sure to use our genuine branch piping for refrigerant R410A / R32

1. In case of single unit:  
 It is not necessary to charge with additional refrigerant until the chargeless pipe length in the table 2.  
 If the pipe length is exceeding the charge less pipe length, charge with additional refrigerant amount per 1m according to the equivalent length.
2. In case of simultaneous operation of multiple units:  
 Calculate the refrigerant charging amount according to the calculating method of the standard piping diameter.  
 As to the additional refrigerant charging amount per 1m, refer to the additional amount in the table 2.

**Measurement procedure for Renewal**

Observe the following procedure when reusing the existing piping or carrying out renewal installation work.  
 Flowchart of existing piping measures criteria for PE1 Type and PEY1 type outdoor unit.

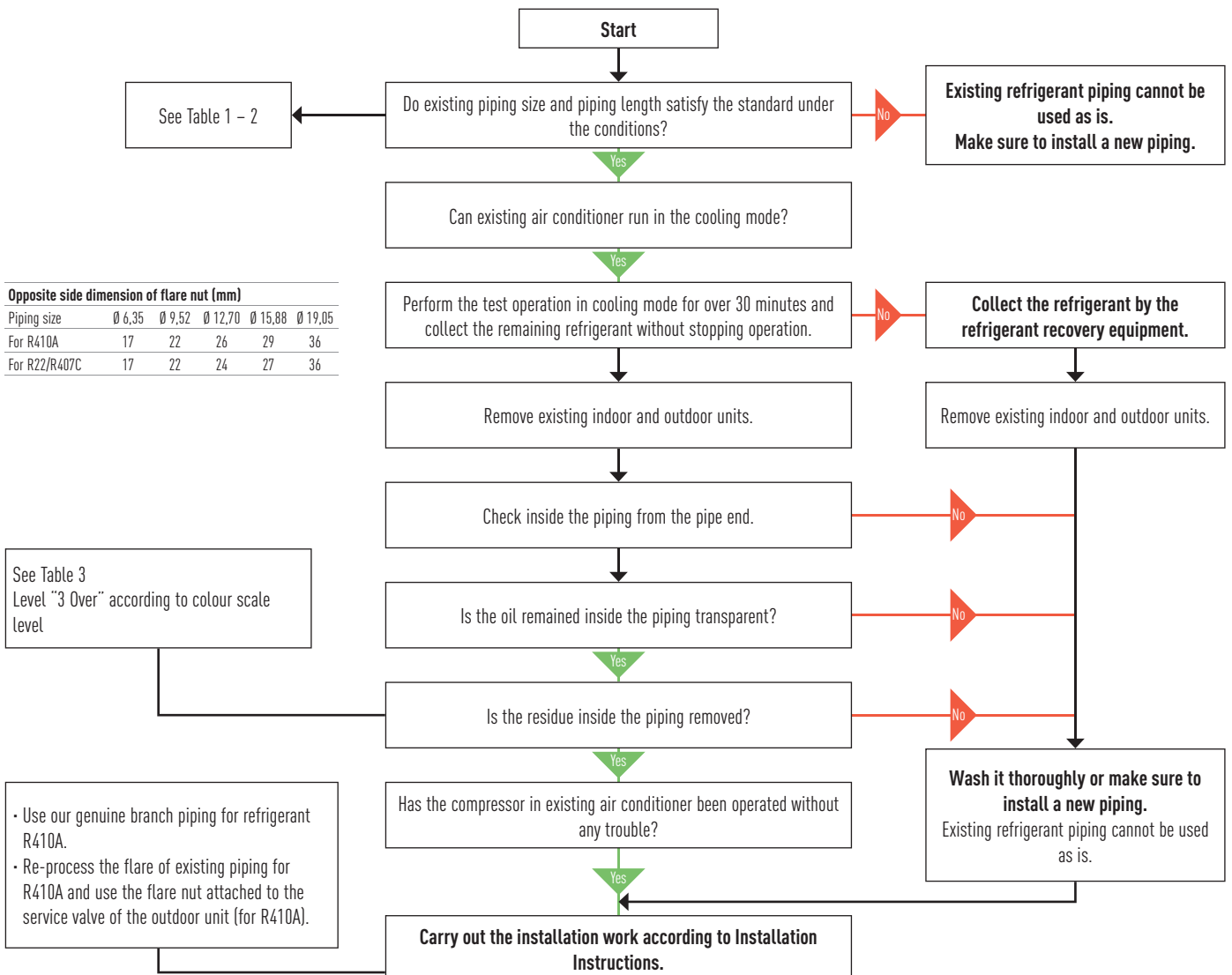

**Opposite side dimension of flare nut (mm)**

Piping size	∅ 6,35	∅ 9,52	∅ 12,70	∅ 15,88	∅ 19,05
For R410A	17	22	26	29	36
For R22/R407C	17	22	24	27	36

See Table 3  
 Level "3 Over" according to colour scale level

- Use our genuine branch piping for refrigerant R410A.
- Re-process the flare of existing piping for R410A and use the flare nut attached to the service valve of the outdoor unit (for R410A).

### Refrigerant piping size and allowable piping length

Check if reuse of existing refrigerant piping is possible based on the following chart.

The standards other than this one (difference of elevation, etc.) are identical to the requirements of ordinary refrigerant piping.

**Table 1 Reusable existing piping (mm)**

Material	0				1/2 H, H*			
External diameter	Ø 6,35	Ø 9,52	Ø 12,70	Ø 15,88	Ø 19,05	Ø 22,22	Ø 25,40	Ø 28,58
Thickness	0,80	0,80	0,80	1,00	1,00	1,00	1,00	1,00

\* It is impossible to reuse the size of Ø 19.05, Ø 22.22, Ø 25.4 and Ø 28.58 for material 0. Change to material 1/2H or material H.

**Table 2 - 1 Refrigerant piping size: 3,6 - 14,0 kW type (mm)**

Liquid pipe		Ø 6,35			Ø 9,52			Ø 12,70	
Gas pipe		Ø 9,52	Ø 12,70	Ø 15,88	Ø 12,70	Ø 15,88	Ø 19,05	Ø 15,88	Ø 19,05
PE / PZH	Type 50	✗	Standard 40 m (30 m)	⊙ 40 m (30 m)	□ 20 m (15 m)	□ 20 m (15 m)	✗	✗	✗
	Type 60 Type 71	✗	▽ 10 m (10 m)	□ 10 m (10 m)	▽ 30 m (20 m)	Standard 50 m (20 m)	✗	□ 25 m (10 m)	✗
Additional refrigerant charging amount per 1 m		20 g/m			40 g/m			80 g/m	
PE / PZH	Type 60 Type 71	✗	▽ 10 m (10 m)	□ 10 m (10 m)	▽ 30 m (30 m)	Standard 50 m (30 m)	✗	□ 25 m (15 m)	✗
	Type 100 Type 125 Type 140	✗	✗	✗	✗	Standard 75 m (30 m)	⊙ 75 m (30 m)	□ 35 m (15 m)	□ 35 m (15 m)
PEY / PZ	Type 100 Type 125 Type 140	✗	✗	✗	✗	Standard 50 m (30 m)	⊙ 50 m (30 m)	□ 25 m (15 m)	□ 25 m (15 m)
	Additional refrigerant charging amount per 1 m		20 g/m			50 g/m			80 g/m

How to see table definition (example):

In case of type 71, standard size is liquid pipe Ø 9,52 / gas pipe Ø 15,88,

There is a limitation to liquid pipe Ø 9,52 / gas pipe Ø 12,70 and to liquid pipe Ø 12,70 / gas pipe Ø 15,88,

However, they are applicable for different diameter's pipes.

**Table 2 - 2 Refrigerant piping size: 20,0 - 25,0 kW type (mm)**

Liquid pipe		Ø 9,52			Ø 12,70			Ø 15,88		
Gas pipe		Ø 22,22	Ø 25,40	Ø 28,58	Ø 22,22	Ø 25,40	Ø 28,58	Ø 22,22	Ø 25,40	Ø 28,58
PE	Type 200	▽ 80 m (30 m)	Standard 100 m (30 m)	⊙ 100 m (30 m)	▽ 50 m (15 m)	□ 50 m (15 m)	□ 50 m (15 m)	✗	✗	✗
	Type 250	✗	✗	✗	▽ 80 m (30 m)	Standard 100 m (30 m)	⊙ 100 m (30 m)	▽ 65 m (20 m)	□ 65 m (20 m)	□ 65 m (20 m)
Additional refrigerant charging amount per 1 m		40 g/m			80 g/m			120 g/m		

- ⊙ Allowable
- ▽ Cooling capacity down
- Limited piping length
- ✗ Unallowable
- 50 m Maximum piping length
- (50 m) Charge less piping length in a single connection

**Table 3 Deterioration Criteria for Refrigerant Oil**

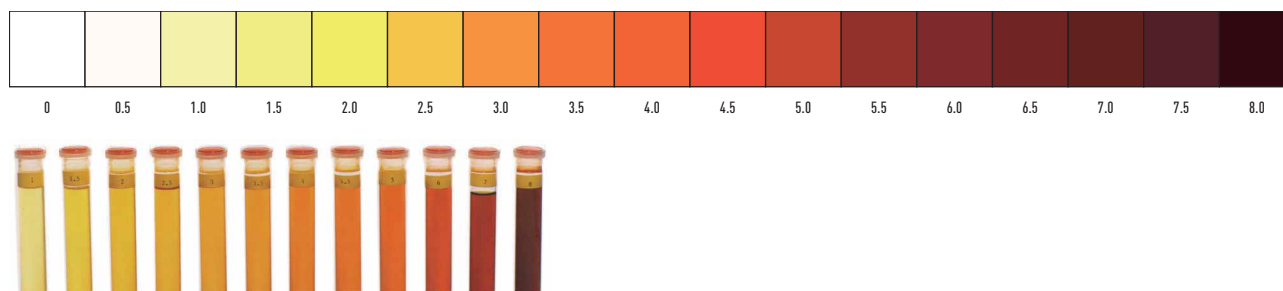

# ACCESSORIES & CONTROL

## Panels



**CZ-KPU3**  
Normal panel for 90x90 Cassette PU2.



**CZ-KPU3A**  
Econavi panel for 90x90 Cassette PU2.



**CZ-KPY3AW**  
Panel for 60x60 Cassette size 700x700mm.



**CZ-KPY3BW**  
Panel for 60x60 Cassette size 625x625mm.

## Other Accessory



**CZ-CNEXU1**  
nanoe™ X air purifying system for 90x90 Cassette PU2.



**CZ-CENSC1**  
Econavi energy savings sensor.

## Outdoor accessories



**PAW-WTRAY**  
Tray for condenser water compatible with base ground support.



**PAW-GRDSTD40**  
Outdoor elevation platform 400x900x400mm.



**PAW-GRDBSE20**  
Outdoor base ground support for noise and vibration absorption (600 x 95 x 130mm, 500kg).



**PAW-WPH9**  
Wind protection shield for U-71PZH2E5/8, U-71PE1E5A/8A and U-100/125PEY1E5/8.



**PAW-WPH7**  
Wind protection shield for U-100/125/140PZH2E5/8, U-100/125/140PE1E5A/8A and U-140PEY1E8.

## Branch Pipes, Header

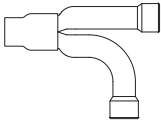

**CZ-P155BK1**  
Branch pipe (capacity after distribution is 16,00kW or less).

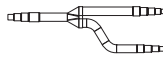

**CZ-P224BK2BM**  
Branch pipe (capacity after distribution is 22,4kW or less).

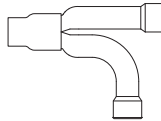

**CZ-P680BK2BM**  
Branch pipe (from 22,4kW to 68kW).

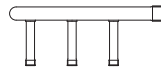

**CZ-P3HPC2BM**  
Header.

## Plenums



**CZ-DUMPA160MF2**  
Air Inlet Plenum S . .PF1E5B 100, 125 & 140.

**CZ-160DAF2**  
Air Outlet Plenum S . .PF1E5B 100, 125 & 140.

**CZ-56DAF2**  
Air Outlet Plenum S . .PF1E5B 36, 45 & 50.

**CZ-TREMIESPW705**  
Air Outlet Plenum S-200PE2E5.

**CZ-90DAF2**  
Air Outlet Plenum S . .PF1E5B 60 & 71.

**CZ-TREMIESPW706**  
Air Outlet Plenum S-250PE2E5.

## Individual Controls



**CZ-RTC5B**  
Design wired remote controller with Econavi button and datanavi.



**CZ-RTC4**  
Remote controller for maintenance setting.



**CZ-RWS3 + CZ-RWRU3**  
Wireless remote control for 4 Way 90x90 Cassette.



**CZ-RWS3**  
Wireless remote control for Wall Mounted and 4 Way 60x60 (with CZ-KPY3AW).

## Controller for Hotels with Dry Contacts



**PAW-RE2C3-WH**  
Stand-Alone with I/O White frame.

**PAW-RE2C3-MOD-WH**  
Modbus RS-485 with I/O White frame.

**PAW-RE2C3-LON-WH**  
LonWorks TP/FT-10 with I/O White frame.

**PAW-RE2C3-GR**  
Stand-Alone with I/O Grey Frame.

**PAW-RE2C3-MOD-GR**  
Modbus RS-485 with I/O Grey frame.

**PAW-RE2C3-LON-GR**  
LonWorks TP/FT-10 with I/O Grey frame.



**CZ-RWS3 + CZ-RWRU3**  
Wireless remote control for Ceiling.



**CZ-RWS3 + CZ-RWRU3**  
Wireless remote control for all indoor units.



**CZ-RE2C2**  
Simplified remote control.



**CZ-CSRC3**  
Temperature Remote sensor.

## Centralised Controls



**CZ-64ESMC3**  
System Controller with Schedule timer. Operation with various function from center station.



**CZ-ANC3**  
Central On/Off controller, up to 16 groups, 64 indoor units.



**CZ-256ESMC3**  
Simplified load distribution ratio (LDR) for each tenant. Intelligent Controller (Touch screen panel).

Centralised Controls. BMS System. PC Base



**CZ-CSWKC2**  
PAIMS Basic software.

**CZ-CFUNC2**  
Communication adaptor.



**CZ-CSWAC2**  
PAIMS Consumption calculation control.

**CZ-CSWBC2**  
PAIMS - BACnet interface.

**CZ-CSWGC2**  
PAIMS - Layout display.

**CZ-CSWWC2**  
PAIMS - Web application.

Centralised Controls. Connection with 3rd Party Controller



**CZ-CAPDC2**  
Serial parallel device controlling outdoor units, up to 4 units.



**CZ-CAPC3**  
Adaptor for On/off control of external devices.



**CZ-CAPBC2**  
Mini series parallel device controlling indoor units, maximum 1 group and 8 indoor unit.



**CZ-CFUNC2**  
Communication Adaptor. Up to 128 groups. Controls 128 units.

VRF Smart Connectivity



**SER8150R0B1194**  
Remote Controller Panasonic Net Con, RH, No PIR, R1/R2.



**SER8150R5B1194**  
Remote Controller Panasonic Net Con, RH, PIR, R1/R2.



**VCM8000V5094P**  
Wireless Zigbee Pro module / Green Com card.



**SED-WDC-G-5045**  
Door / window wireless sensor.



**SED-MTH-G-5045**  
Wall / ceiling (motion) wireless sensor.



**SED-CO2-G-5045**  
CO<sub>2</sub> sensor.

Accessories Interfaces



**PAW-RC2-WIFI-1**  
Interface for Inteshome for PACi and ECOi.



**PAW-RC2-KNX-1i**  
KNX Interface.



**PAW-RC2-MBS-4**  
Modbus interface to control 4 indoor/groups.



**PAW-RC2-MBS-1**  
Modbus Interface.



**CZ-CFUSCC1**  
Panasonic AC Smart Cloud. Cloud internet control. Up to 128 groups. Controls 128 units.

**PAW-MVNOAC-V**  
**PAW-MVNOAC-K**  
3G communication package (SIM Card included). V, K: Depending on countries.



**PAW-MBS-TCP2RTU**  
ModBus RTU Slave devices.



**PAW-RC2-BAC-1**  
BACnet Interface.



**CZ-CAPRA1**  
Domestic with CZ-CNT port integration to PACi and ECOi.

Accessories PCB



**PAW-T10**  
All T10 functions.

**PAW-T10V**  
All T10 functions + powermonitoring.

**PAW-T10H**  
ON/OFF; Prohibit 5VDC & 230VAC.

**PAW-T10HW**  
ON/OFF; Prohibit 5VDC.



**PAW-PACR3**  
Redundancy of 2 or 3 systems; for PACi and ECOi.



**PAW-SERVER-PKEA**  
Redundancy of 2 units TKEA / PKEA.

Accessories Cables



**CZ-T10**  
Cable for all the T10 functions.



**PAW-FDC**  
Cable to operate external EC fan.



**PAW-OCT**  
Cable for all option monitoring signals.

**PAW-EXCT**  
Cable with force Thermo OFF/leakage Detection.



**CZ-CAPE2**  
Option monitoring signals wo. Fan.

# PANASONIC INDUSTRIAL VRF SYSTEMS





Professional solutions for all types of projects.

The new Panasonic VRF system is specifically designed for energy saving, easy installation and high efficiency performance, with a wide choice of outdoor and indoor unit models and unique features which are designed for the most demanding offices and big buildings.



# VRF HIGHLIGHTED FEATURES



Panasonic provides an extensive range of solutions for medium-sized and large buildings. Combining the best option to satisfy all needs and site restrictions.

Uniquely, you can choose from both Electrical VRF and Gas-powered VRF systems from Panasonic, delivering best choice that really makes a difference to our customers.

Providing a large choice in indoor units, you can also connect water heat exchangers, air handling units and ventilation units with or without a heat exchanger. And all managed from a simple and powerful stand-alone remote control, new centralised controls or cloud connection with 3G embedded.

This cutting edge control technology is called VRF Smart Connectivity, combining the expertise of VRF communication and a leading BEMS company to maximise comfort and efficiency while also reducing installation costs.

	ECOi. Electrical VRF			ECO G. Gas Powered VRF	
	2-Pipe Mini ECOi	2-Pipe ECOi EX	3-Pipe ECOi EX	2-Pipe ECO G GE3	3-Pipe ECO G GF3
Capacity range	4-10HP	8-80HP	8-48HP	16-60HP	16-25HP
Extreme temperatures operation	-20°C	-25°C	-20°C	-21°C	-21°C
Number of indoor units	15	64	52	64	24
Simultaneity ratio	50 ~ 130%	200%	150%	—	50 ~ 200%
Indoor units	All (check restrictions)				
Controls	All				
Other ranges integration	PACi full control integration + Domestic integration by accessory				

Energy saving



The Inverter range provides greater efficiency, more comfort, more precise temperature control, without highs and lows, and keeps the ambient temperature constant with lower energy consumption and a significant reduction in noise and vibration levels.



Multiple large-capacity all inverter compressors (more than 14HP). Two independently controlled inverter compressors achieve high efficiency. Redesigned components in the body provide performance improvement especially in the rated cooling condition and EER performance.



Intelligent Human Activity Sensor and new Sunlight Sensor technologies that can detect and reduce waste by optimising air conditioner operation according to room conditions. With just one touch of a button, you can save energy.



ECO G technology offers the best in energy efficiency. ECO G gas VRF is specially designed for buildings where the electricity is restricted or CO<sub>2</sub> emissions must be reduced.



High efficiency models performs higher COP than standard units and standard combinations.

High performance



The ECOi EX system works in heating mode with performance data at outdoor temperature down to -25°C.



The ECOi EX system works in cooling mode with performance data at outdoor temperature up to 52°C.

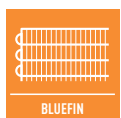

Panasonic has extended the life of its condensers with an original anti-rust coating.



Self-diagnosing function. By using electronic control valves past warnings are stored. This makes it easier to diagnose malfunctions, reducing service labour and therefore costs.



Automatic fan operation. Convenient microprocessor control automatically adjusts fan speed to High, Medium or Low, corresponding to room sensor and maintains comfortable airflow throughout the room.



By intermittent control of compressor and indoor unit's fan, "Mild Dry" gives you comfort. It realizes efficient dehumidification according to room temperature.



Comfortable auto-flap control. When the unit is first turned on, flap position is automatically adjusted in accordance with the cooling or heating operation.



Automatic restart function for power failure. Even when power failure occurs, preset programmed operation can be reactivated once power is resumed.



Air Sweep. The air sweep function moves the flap up and down in the air outlet, directing air in a "sweeping" motion around the room and providing comfort in every corner.



Built-in drain pump. Maximum head 50cm (or 75cm for U type) from the bottom of the unit.



The Panasonic renewal system allows good quality existing R22 pipe work to be re-used whilst installing new high efficiency R410A systems.



5 Years Warranty. We guarantee the outdoor unit compressors for five years.

High connectivity



The new AC Smart Cloud from Panasonic allows you to have complete control of all your installations. In a simple click, all your units from several locations, receive status updates in real-time of all your installations, preventing breakdowns and optimizing costs.



Internet Control is a next generation system providing a user-friendly remote control of air conditioning or heat pump units from everywhere, using a simple Android or iOS smartphone, tablet or PC via internet.

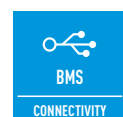

The communication port is integrated into the indoor unit and provides easy connection to, and control of, your Panasonic heat pump to your home or building management system.

# PANASONIC: DELIVERING TOP ENERGY EFFICIENCIES FOR MANY YEARS



Particularly suitable for retail, hotels and office applications

Outstanding efficiency at part load conditions:

Panasonic ECOi EX model covers up to 30% part load with extremely high efficiency.

Load %	100%	80%	60%	50%	40%	30%
18HP High Efficiency model	4,54	5,30	6,37	7,12	8,23	6,93
18HP Space saving model	3,38	3,97	4,75	5,25	5,13	4,97

Conditions: Outdoor temperature 35°C DB, Room temperature 19°C WB.

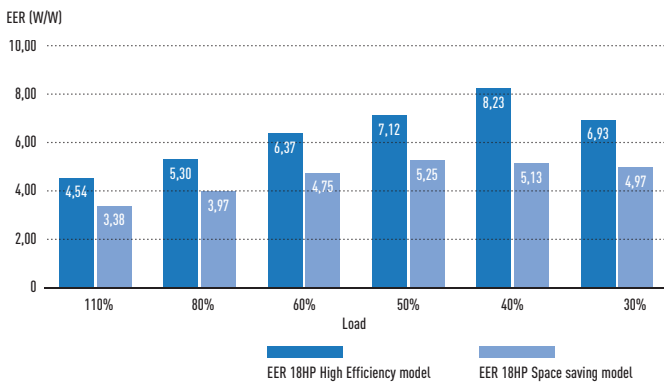

\* Data from Panasonic official technical data book.

Load %	100%	80%	60%	50%	40%	30%
18HP High Efficiency model	3,89	5,42	6,90	6,94	6,59	6,11
18HP Space saving model	3,43	4,90	6,36	6,59	6,33	5,92

Conditions: Outdoor temperature 0°C WB, Room temperature 20°C DB.

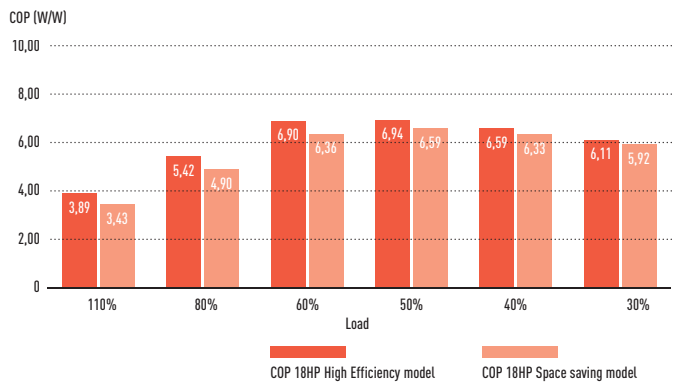

Excellent SEER and SCOP values for VRF 2 and 3-Pipe

Panasonic have a extremely high SEER and SCOP values following LOT21 (seasonal space cooling/heating energy efficiency by COMMISSION REGULATION (EU) 2016/2281).

	Mini ECOi					2-Pipe					3-Pipe						
	4HP	5HP	6HP	8HP	10HP	8HP	10HP	12HP	14HP	16HP	18HP	20HP	8HP	10HP	12HP	14HP	16HP
SEER	7,85	7,48	7,25	6,27	6,37	7,43	6,83	6,65	7,23	6,43	7,56	7,03	7,02	7,05	6,39	6,69	6,02
SCOP	4,87	4,40	4,24	4,24	4,31	4,79	4,26	4,72	4,28	4,05	4,29	4,09	4,85	4,25	4,27	4,13	3,81

ESEER calculation corresponds with below conditions and the input power of indoor units is not included.

- Indoor temperature: 27°C DB / 19°C WB
- Outdoor temperature conditions

Part load ratio	25%	50%	75%	100%
Outdoor air temperature (°C DB)	20	25	30	35
Weighting coefficients	0,23	0,41	0,33	0,03

• Formula: 0,23 x EER25% + 0,41 x EER50% + 0,33 x EER75% + 0,03 x EER100%.

Efficient defrost operation

Panasonic uses the second unit to defrost the first unit. This makes the system more efficient during defrost and does not affect comfort.

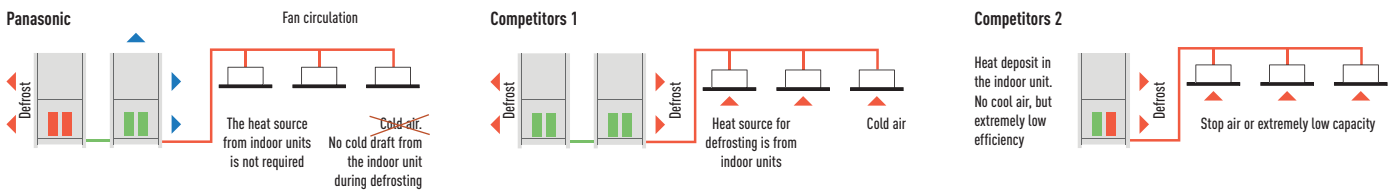

Panasonic ECOi operates at as low as -25°C

This unique feature demonstrate the supremacy of Panasonic ECOi Ex Series.

Panasonic use the second unit to defrost the first unit. This makes the system more efficient during defrost and does not affect the comfort.

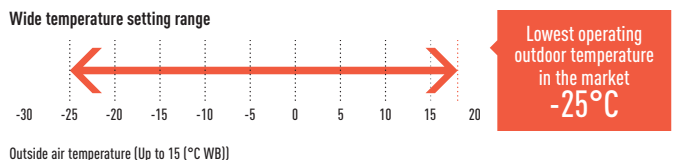

# PANASONIC VRF: TOP IN COMFORT



Since 2006, all Panasonic VRF systems have included special VET technology, with variable coolant temperature, as standard.

**Variable Evaporation and Condensation Temperature**

Our 'smart logic' system checks the temperature every 30 seconds, automatically adjusting coolant temperature according to actual demand and outdoor conditions. This ensures better energy performance at all times.

**Temperature varies from 16 °C to 3 °C.**

Similarly, the condensation temperature is also variable and is adjusted to the room thermal load, within a range of 33–55 °C.

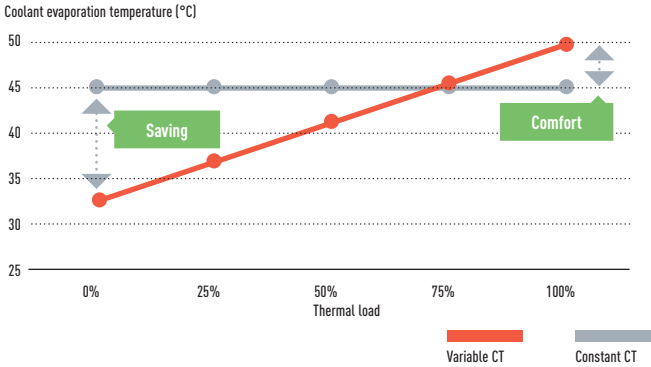
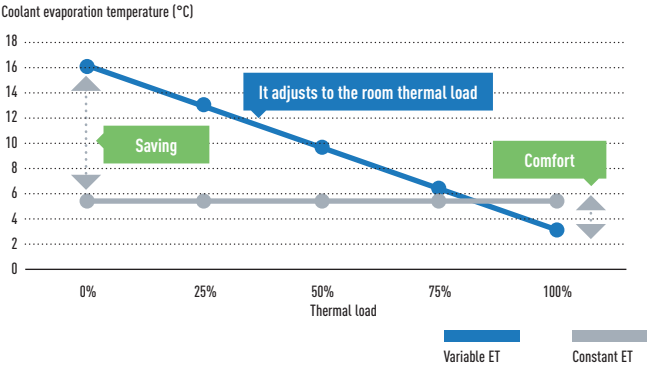

Example of cooling mode (heating mode is also available)

**Technical focus Variable temperatures**

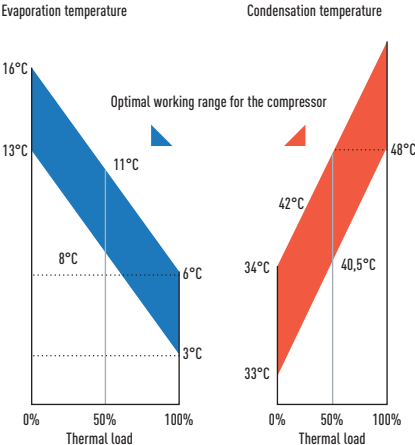

**Control of the discharge temperature**

This special function is available in all of Panasonic VRF systems' indoor units to guarantee maximum comfort for the end user. For example, in cooling mode, if the temperature of the discharged air was below 10 °C, the user may feel discomfort, just as he would do in heating mode if the temperature was far too high. With the Panasonic control of the discharge air temperature, this can be adjusted within a cooling range of 7–22 °C.

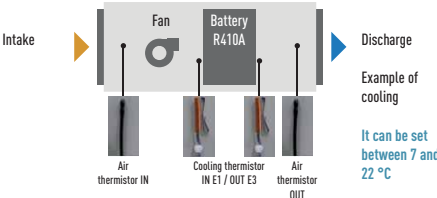

- Benefits**
- The air will never be too cold or too warm
  - Cooling and Heating function
  - Comfort
  - Energy saving
  - It prevents the formation of condensation within ducts and vents, improving levels of hygiene.

# SOLUTIONS FOR RESTAURANTS

## Full heating, cooling and DHW solutions for Restaurants

### Highly efficient at part load conditions.

Panasonic has solutions for optimising the installation of cooling, heating and DHW production in restaurants. While the kitchen needs cooling, heating is needed for DHW and also for heating the public area, with the advantage of 100% fresh air that removes odours. Combining all these needs smartly with Panasonic technology results in a simple and flexible system adaptable to any restaurant requests, with lower utility bills. Additionally, Panasonic is the unique offering solution for areas where electric power is limited, using ECO G, VRF units powered mainly by Natural Gas or Propane, bringing comfort and DHW anywhere.

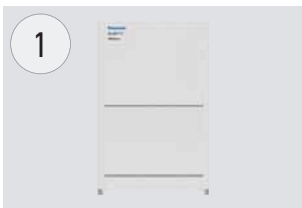

**ECOi (Electric VRF).**  
ECOi electrical VRF is specifically designed for the most demanding hotels. High efficiency system. Extended operating range to provide heating at outdoor temperature as low as -20°C. Suitable for refurbishment projects.



**TKEA outdoor unit for server room.**  
Steady cooling, nonstop, even at -20°C and still with high efficiency. Ready for continuous operation and easy to connect 2 systems to automatically alternate and ensure server rooms are kept cool.

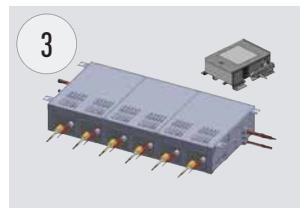

**3-Pipe control box kit.**  
New Heat Recovery box to connect multiple indoor units with just one box, 4, 6 and up to 8 indoor units or groups. This is good advantage specially in hotels applications, where space for connecting several boxes is limited.



**Aquarea T-CAP.**  
Ideal for heating, cooling and for production of big quantities of hot water at 65°C, Aquarea have an extremely quick return on investment and a low CO<sub>2</sub> footprint.

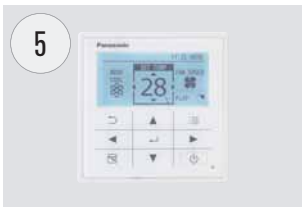

**Control your way.**  
Wide variety of controls, from simple user control to full system control via remote access functionality. Touch panel, web server, consumption control, smartphone control... everything is possible.

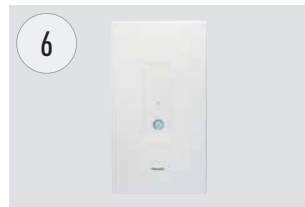

**Hydrokit for ECOi. Water at 45°C.**  
Producing LT hot water, compatible with both ECOi, heat pump and heat recovery outdoors.

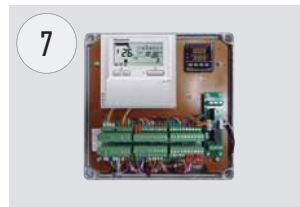

**Air Handling Unit kits for efficient ventilation.**  
The new AHU kit is specially designed to improve the efficiency of the pre-heating or pre-cooling process of the ventilation.

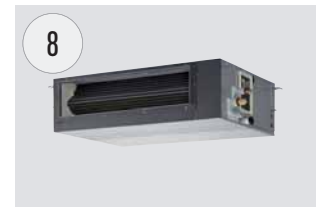

**Hide Away, for power and efficiency.**  
Super silent units deliver the ideal air supply. Units available from 1,5kW providing precise temperature control even in small rooms. Two models available: slim unit for height restricted areas (MM unit only 200mm deep), another which allows 100% fresh air (MF).

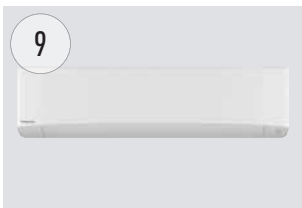

**Wall Mounted.**  
The K2 Type wall mounted unit has a stylish smooth panel which not only looks good but is also easy to clean. The unit is also smaller, lighter and substantially quieter than previous models making it ideal for small offices and other commercial applications.



**Air Curtain with DX Coil.**  
The Panasonic range of air curtains is designed for smooth operation and efficient performance.



**Protocol friendly.**  
Great flexibility for integration into your KNX / Modbus / LonWorks / BACnet projects allows fully bi-directional monitoring and control of all the functioning parameters. Range of solutions to control locally or remotely the full system in bi-directional mode.



**Panasonic AC Smart Cloud.**  
Taking your business under control. New service function makes maintenance works simpler.



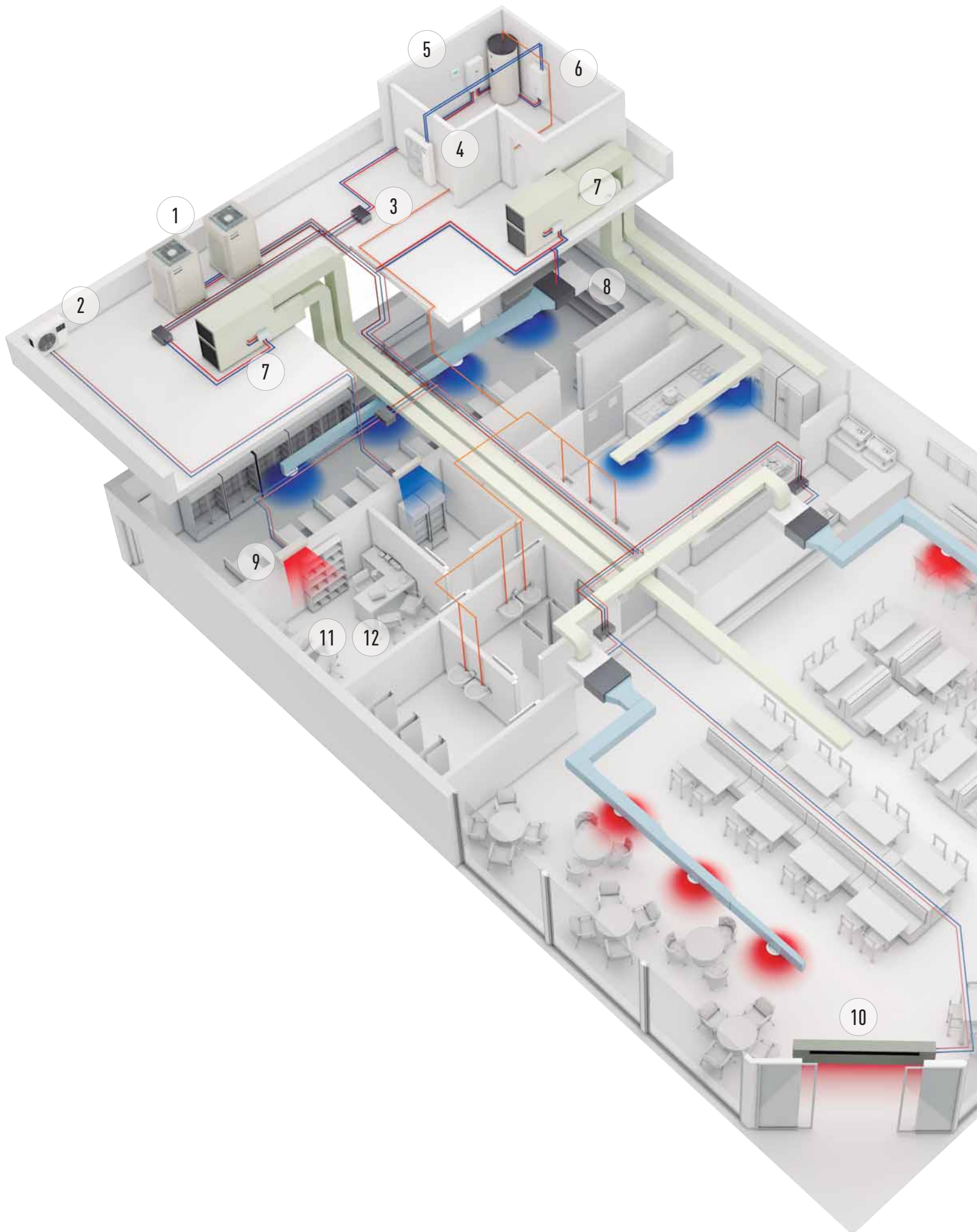

# YOUR ENTIRE HOTEL WITH SUPERIOR COMFORT, CONTROL AND SAVINGS TOO



**Hybrid system.**  
Gas + Electricity Hybrid system. Taking advantage of Gas and Electricity to achieve the most efficient performance and maximum energy savings.

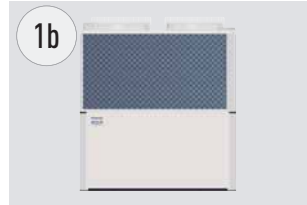

**ECO G (Gas heat pump).**  
ECO G gas VRF is designed for buildings where the electricity is restricted or CO<sub>2</sub> emissions must be reduced. Sanitary hot water is produced for free, all year round.



**TKEA outdoor unit for server room.**  
Steady cooling, nonstop, even at -20°C and still with high efficiency. Ready for continuous operation and easy to connect 2 systems to automatically alternate and ensure server rooms are kept cool.

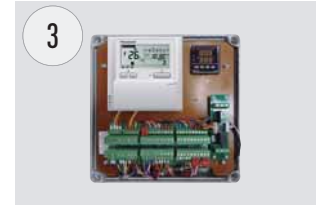

**Air Handling Unit kits for efficient ventilation.**  
The new AHU kit is specially designed to improve the efficiency of the pre-heating or pre-cooling process of the ventilation.

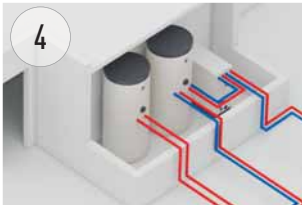

**Domestic Hot Water production and buffer tanks.**  
Panasonic has developed a wide range of efficient domestic hot water tanks and buffer tanks.

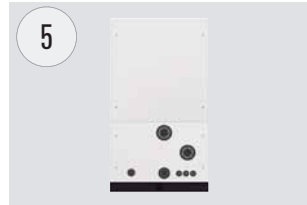

**Hydronic units.**  
For obtaining hot and cold water for heating and refrigeration (Aqueara Air radiators, underfloor heating, radiators...)

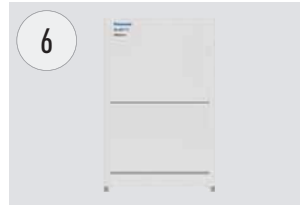

**ECOi (Electric VRF).**  
ECOi electric VRF is specifically designed for the most demanding hotels. High efficiency system. Extended operating range to provide heating at outdoor temperature as low as -20°C.

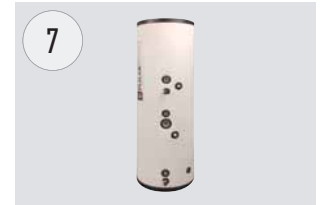

**High temperature DHW tank.**  
DHW tank with maximum outlet temperature 65°C. Ideal solution for high demand of hot water such as shower, spa, swimming pool.

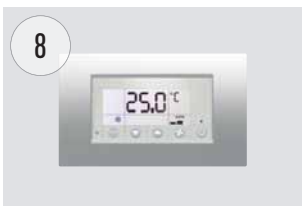

**Control your way.**  
Wide variety of controls, from simple user control to full system control via remote access functionality. Touch panel, web server, consumption control, smartphone control... everything is possible.

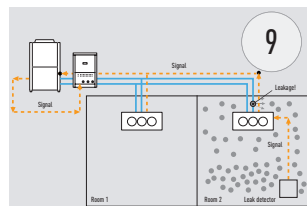

**Direct leak detection method for the safety.**  
Panasonic Pump Down System meets requirements by the Safety of Building Occupant (BS-EN378). The safest solution for hotel rooms.



**Wide range of indoor units.**  
Complete range of indoor units that fits any need. All units provided with supply air temperature sensor and low operation sound level to guarantee maximum guests comfort. From 1,50kW up to 30kW.



**Panasonic AC Smart Cloud.**  
Take control of all your premises around the world from a single device. Centralise control of your business premises, from wherever you are, 24/7.



**Protocol friendly.**  
Great flexibility for integration into your KNX / Modbus / LonWorks / BACnet projects allows fully bi-directional monitoring and control of all the functioning parameters.



**Air Curtain with DX Coil.**  
The Panasonic range of air curtains is designed for smooth operation and efficient performance.



**Maximum savings on hot water production.**  
Hot water for swimming pool, spa and laundry for free thanks to the residual heat generated by the ECO G units.

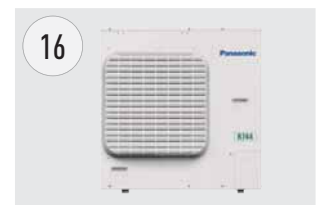

**Condensing unit with natural refrigerant.**  
Panasonic CO<sub>2</sub> unit is the natural choice for an energy saving and environmentally friendly solution.

Panasonic offers the widest range in HVAC, DHW and ventilation available. That enables us to offer the most suitable solution 24 hours a day, 365 days a year. Panasonic Solutions ensure not only a higher customer satisfaction but also a lower energy bill.

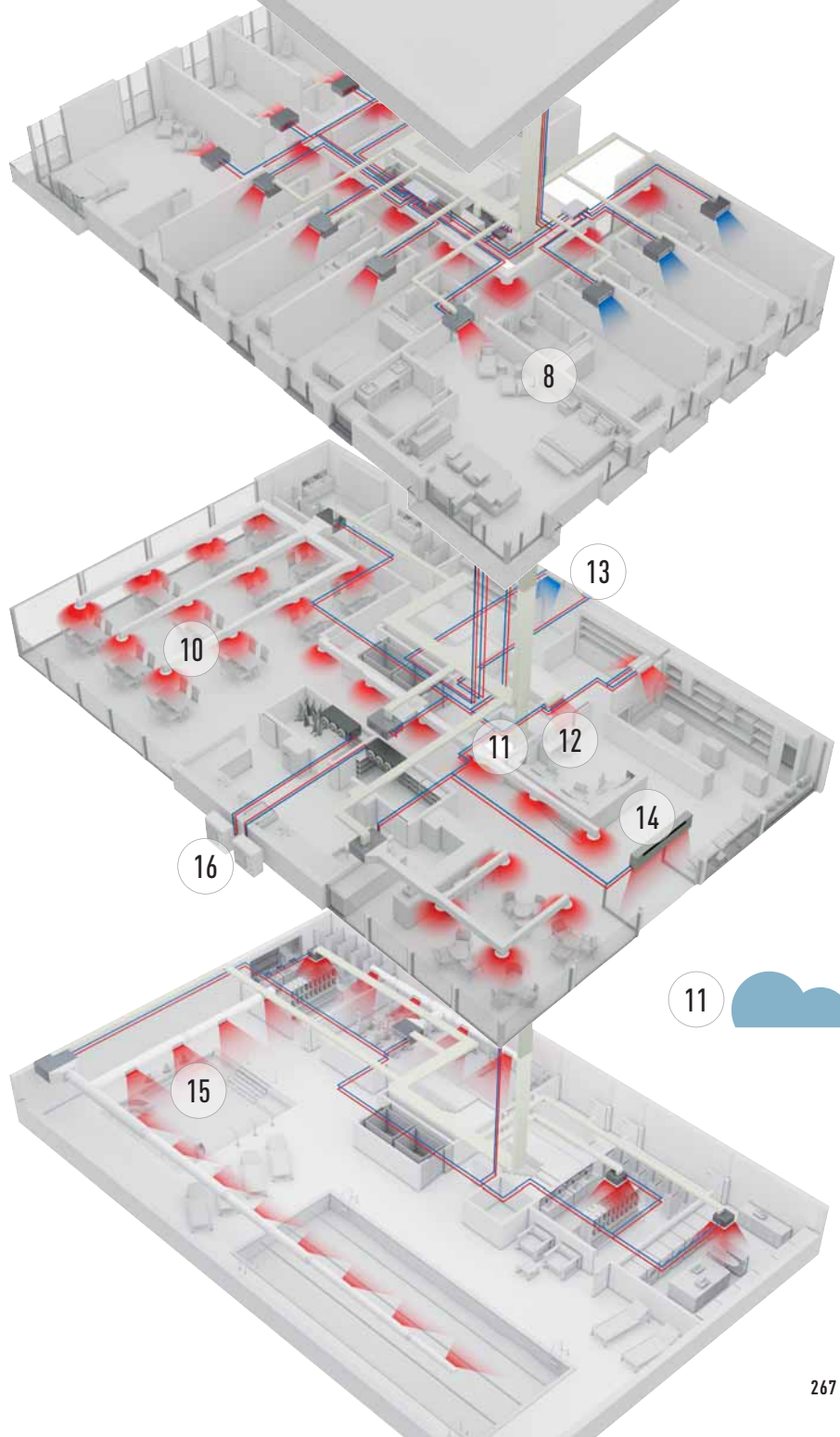
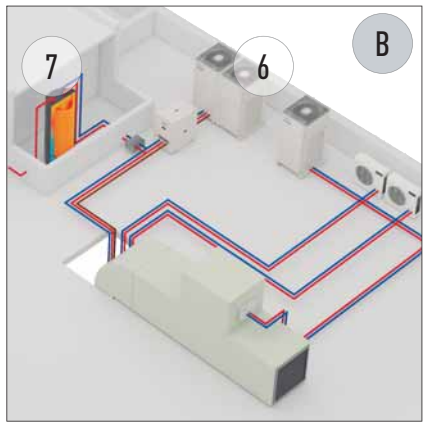
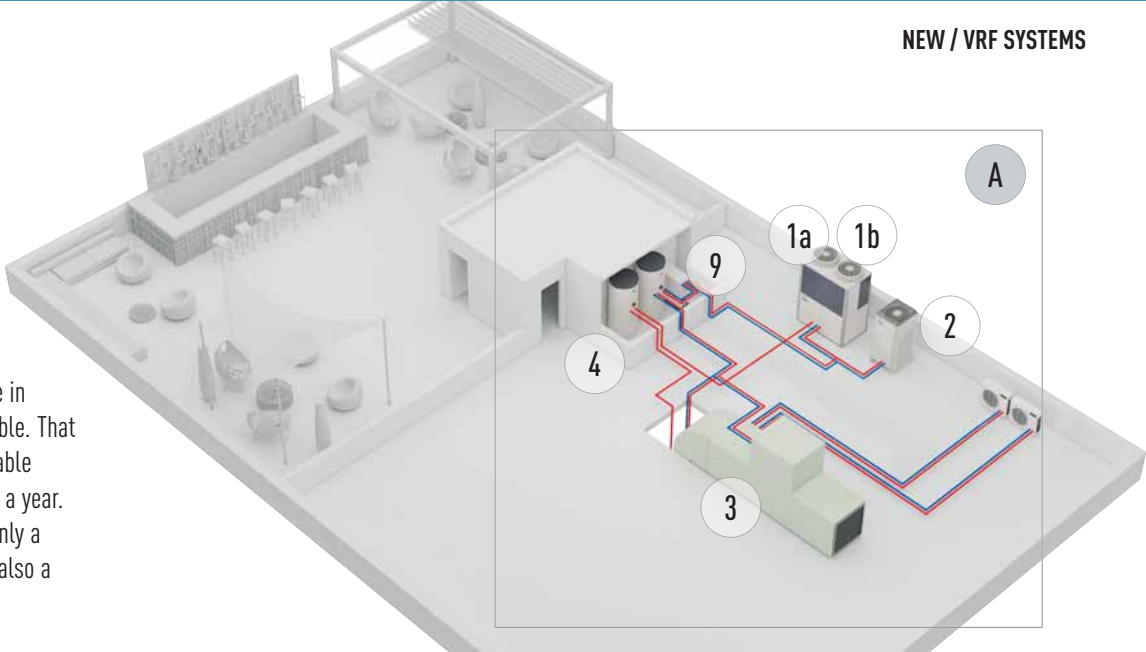

**A**

**Option A: Hybrid Solution. Gas + Electric: When large quantities of hot/cold water is needed.**

- ECO G (Gas heat pump)
- Water heat exchanger
- Aquarea HT to produce hot water up to 65°C
- Air Handling Unit kit to connect the ECO G to the Air Handling Unit
- TKEA wall mounted to cool the server rooms efficiently

**B**

**Option B: Full Electric Solution 2 and 3-Pipe. When flexibility is needed and electricity power availability is not an issue.**

- ECOi (Electric VRF)
- Direct expansion indoor units
- Air Handling Unit (AHU) kit to connect the ECOi to the AHU
- TKEA wall mounted to cool the server rooms efficiently
- Panasonic Pump Down System

# INNOVATIVE SOLUTIONS FOR RETAIL

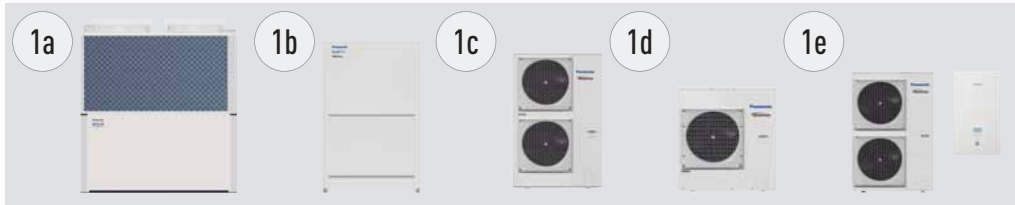

**Multi energy solutions, gas or electric.**

The Multi energy solution (Gas and Electric) from Panasonic provides the best choice in energy saving and on the flexibility of the installation. Panasonic solutions can be connect to direct expansion systems, water chiller installations and ventilation systems as air handling units.

- 1a: Gas VRF. ECO G
- 1b: Electric VRF. ECOi
- 1c: Electric VRF. Mini ECOi
- 1d: Electric 1x1. PACi
- 1e: Electric A2W. Aquarea



**TKEA outdoor unit for server room.**

Steady cooling, nonstop, even at -20°C and still with high efficiency. Ready for continuous operation and easy to connect 2 systems to automatically alternate and ensure server rooms are kept cool with maximum operating guaranteed.



**Control your way.**

Wide variety of controls, from simple user control to full system control via remote access functionality. Touch panel, web server, consumption control, smartphone control... everything is possible.



**Econavi Sensor.**

The Econavi Sensor detects presence in the room, and quietly adapts the PACi or VRF air conditioning system in order to improve comfort and energy savings.



**Wide range of indoor units.**

Complete range of indoor units that fits any need. All units provided with supply air temperature sensor and low operation sound level to guarantee guests comfort. From 1,50kW up to 30kW.



**Hide Away, for power and efficiency.**

Super silent units deliver the ideal air supply. Units available from 1,50kW providing precise temperature control even in small rooms. Two models available: slim unit for height restricted areas (MM unit only 200mm deep), another which allows 100% fresh air (MF).



**Air Curtain with DX Coil.**

The Panasonic range of air curtains is designed for smooth operation and efficient performance.



**Protocol friendly.**

Great flexibility for integration into your KNX / Modbus / LonWorks / BACnet projects allows fully bi-directional monitoring and control of all the functioning parameters. Range of solutions to control locally or remotely the full system in bi-directional mode.



**Air Handling Unit kits for efficient ventilation.**

The new AHU kit is specially designed to improve the efficiency of the pre-heating or pre-cooling process of the ventilation.

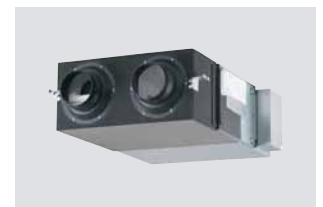

**Energy Recovery unit for high efficiency of the system.**

Panasonic Energy Recovery Ventilators can reduce the outside air load because they efficiently recover the heat lost by ventilation during the heat recovery process.

### Heating and cooling solutions for retail applications







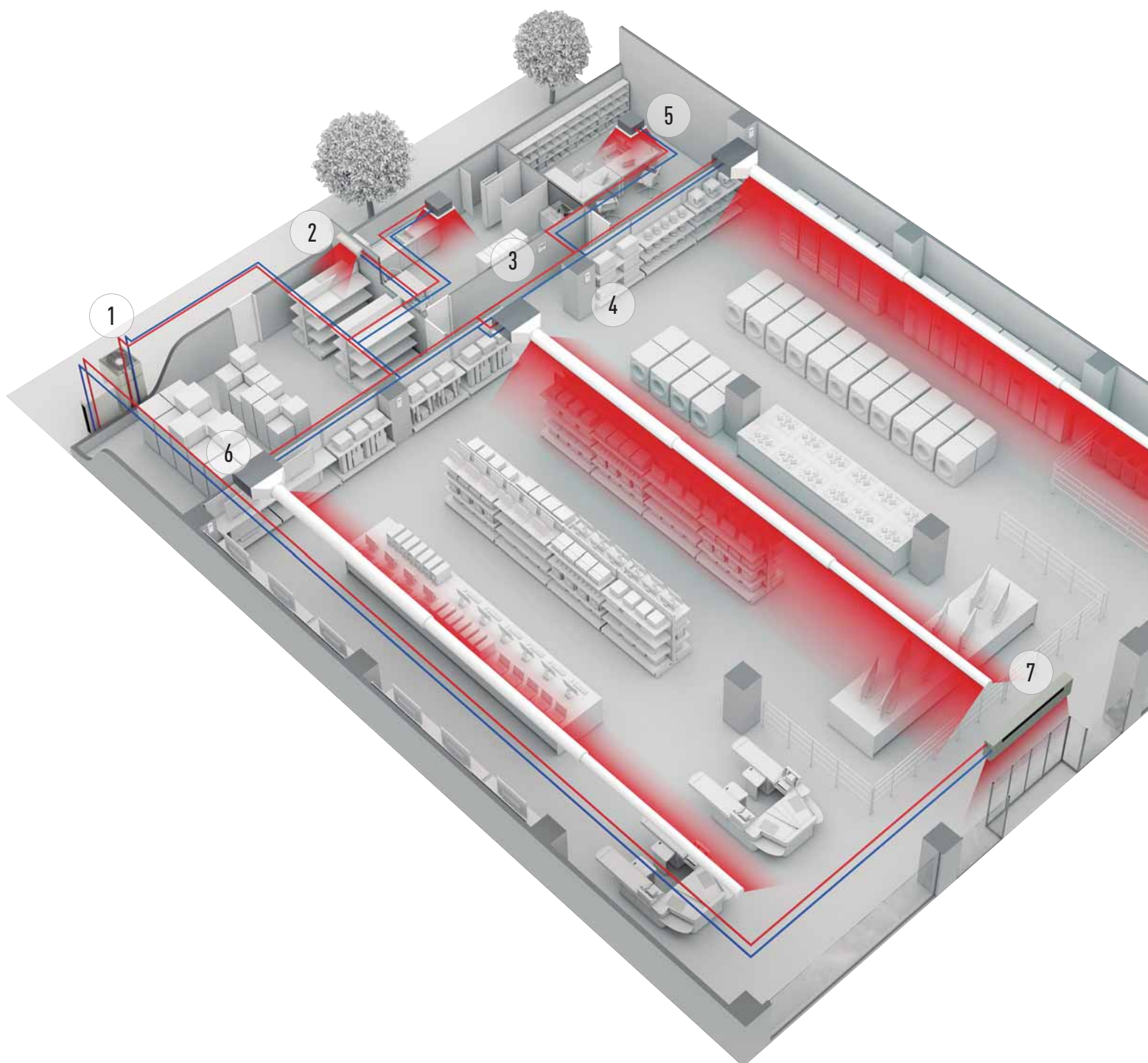







Panasonic has developed solutions for retail applications and office applications where return on investment is a key factor! The comfort inside the shop is key for a good customer experience in the shop. From local control or from Panasonic new cloud control system, a detail status of the heating and cooling system can be displayed, analysed and optimised in order to improve the efficiency, reduce the running time and increase the life time of the units.

### 8 reason why Panasonic is the best solution for your Retail:

- Complete solution
- Flexibility and adaptation
- Go green retail: low CO<sub>2</sub> emissions
- Comfort - high customer satisfaction
- Future expansion
- Panasonic offers efficient systems meeting expectations over the years
- High quality of service with Panasonic pro-partner installation team
- The system will still operate up to 25% of the connected indoor units. System will not stop when up to 25% of indoor units have power supply breakdown when they are on mode



# RANGE OF VRF OUTDOOR UNITS

Page	Outdoor units	4HP	5HP	6HP	8HP	10HP	12HP
P. 274	Mini ECOi LE2 / LE1 Series						
		U-4LE2E5 / U-4LE2E8	U-5LE2E5 / U-5LE2E8	U-6LE2E5 / U-6LE2E8	U-8LE1E8	U-10LE1E8	
P. 286	2-Pipe ECOi EX ME2 Series High Efficiency Model						
					U-8ME2E8	U-10ME2E8	U-12ME2E8
P. 286	2-Pipe ECOi EX ME2 Series Space Saving Model						
					U-8ME2E8	U-10ME2E8	U-12ME2E8
P. 296	<b>NEW</b> 3-Pipe ECOi EX MF3 Series						
					U-8MF3E8	U-10MF3E8	U-12MF3E8
P. 302	2-Pipe ECO G GE3 Series						
P. 310	3-Pipe ECO G GF3 Series						

14HP

16HP

18HP

20HP

25HP

30HP



U-14ME2E8



U-16ME2E8



U-14ME2E8



U-16ME2E8



U-18ME2E8



U-20ME2E8



U-14MF3E8



U-16MF3E8



U-16GE3E5



U-20GE3E5



U-25GE3E5



U-30GE3E5



U-16GF3E5



U-20GF3E5



U-25GF3E5

# BEST EFFICIENCY ECOi SERIES FROM PANASONIC





The ECOi series is designed for energy savings, easy installation, and high efficiency. Always continuing to evolve, Panasonic uses advanced technologies to meet the requirements of diverse situations and contribute to the creation of comfortable living spaces.

### Mini ECOi LE Series



The 2-Pipe heat pump small VRF system specifically designed for the European market.

### 2-Pipe ECOi EX ME2 Series



The VRF system delivering energy-saving performance, powerful operation, reliability and comfort surpassing anything previously possible.

### ECOi EX

### New 3-Pipe ECOi EX MF3 Series

### ECOi EX



The VRF system that offers high-efficiency and performance for simultaneous heating and cooling.

#### Lower running and life cycle costs.

Panasonic ECOi systems are highly efficient VRF systems on the market, offering COPs in excess of 4,0 at full load conditions. The system is also designed to make sure that we reduce the running cost of each system by using our unique road map control routine to ensure that the efficient combination of compressors are running at any one time. Improved defrost sequencing also reduces running costs by defrosting each outdoor coil in turn when conditions allow.

Up to 64 indoor units can be connected up to a capacity of 200% indexed indoor unit loads, enabling the system to be used effectively on highly

diversified building loads: this large connectivity feature makes it an easy-to-design solution for schools, hotels, hospitals and other large buildings. Up to 1000m in pipe length enables the VRF ECOi series to be used in very large buildings, with maximum design flexibility. The ECOi system is also easy to control. It has more than 8 types of control from standard wired remote controls to touch screen panels or web access interfaces.

**DC-inverter control technology for rapid and powerful cooling & heating. The ever-evolving Panasonic ECOi series.**

#### ECOi Series benefits

##### Ease of installation.

R410A has a higher operating pressure with a lower pressure loss than previous refrigerants. This enables smaller pipe sizes to be used and allows reduced refrigerant charges.

##### Simple to design.

Panasonic recognise that designing, selecting and preparing a professional VRF quotation can be a time consuming and costly process, especially as it is often also a speculative exercise. So we have designed proprietary software which is quick and easy to use and produces a full schematic layout of pipework and controls, as well as a full materials list and performance data.

##### Easy to control.

A wide variety of control options are available to ensure that the ECOi system provides the user with the degree of control that they desire, from simple room controllers through to state of the art BMS controls.

##### Simple to commission.

Simple set-up procedure including automatic addressing of connected indoor units. Configuration settings can be made from an outdoor unit or via a remote controller.

##### Easy to position.

The compact design of the ECOi outdoor units means that sizes 4HP to 10HP fit into a standard lift and are easy to handle and position when on site. The small footprint and modular appearance of the units ensure a cohesive appearance to an installation.

##### Wide selection and connectivity.

With 17 indoor model styles available, ECOi systems are the ideal choice for multiple small capacity indoor unit installations, with the ability to connect up to 40 indoor units to systems of 24HP or greater for 3-Pipe ECOi EX MF3 Series.

##### Easy to maintain.

Each system allows the use of prognostic and diagnostic controls routines, from refrigerant charge control through to complex fault code diagnostics, all designed to reduce the speed of maintenance calls and unit down time.

##### Lower running and life cycle costs.

Panasonic ECOi system are also designed to make sure that we reduce the running cost of each system by using our unique road map control routine to ensure that the most efficient combination of compressors are running at any one time. Improved defrost sequencing also reduces running costs by defrosting each outdoor coil in turn when conditions allow.

# MINI ECOi LE SERIES FOR LIGHT COMMERCIAL & RESIDENTIAL USE

**NEW  
COMPACT  
DESIGN**

Mini ECOi with extraordinary energy-saving performance and high external static pressure (35Pa).

Advantages of Mini ECOi LE Series used for medium sized buildings.

## 1 Efficiency energy control

Upgraded outdoor units deliver high efficiency rating and reduced energy costs.

## 2 Space saving

Ideal for commercial locations with limited space such as banks and shops.  
Compact units integrate easily and discreetly into building design.

## 3 Flexible installation

Reduced installation time thanks to compact units and extra long piping without additional refrigeration charge. High external static pressure 35Pa and small chassis increase installation options.



**7,85** | **4,87\***  
**SEER** | **SCOP**  
**INDUSTRY LEADING  
EFFICIENCY**



**6,37\***  
**SEER**  
**4,31**  
**SCOP**

### New compact design: LE2 Series - 4 / 5 / 6HP

- Extraordinary energy saving: 7,85 SEER and 4,87 SCOP (4HP)\*
- 50 m piping length without additional refrigerant charge
- Quiet operation mode with 4 levels
- High COP mode option

\* SEER/SCOP is calculated based on the seasonal space cooling/heating efficiency "η<sub>1</sub>" values of the COMMISSION REGULATION (EU) 2016/2281. SEER, SCOP = (η<sub>1</sub> + Correction) × PEF.

### LE1 Series - 8 / 10HP

- 60% smaller than ECOi ME2 8 / 10HP with vertical flow type
- Flexible piping length (Total: 300m, Furthest: 150m)
- Maximum number of connectable indoor units: 15

### Key features for LE2 / LE1.

- High external static pressure 35Pa
- Full range of ECOi indoor units and controllers
- Variable evaporation temperature control as standard
- Connectable maximum indoor / outdoor capacity ratio up to 130%
- Auto restart from outdoor units
- Demand response (Peak cut) by optional parts
- Suitable for R22 renewable projects

# INSTALLATION FLEXIBLE, EASY AND HASSLE-FREE

## High external static pressure 35Pa

- High air pressure
- New blade shape
- Good for high class condominiums

When unit is installed on a narrow balcony and exposed to the sun, the barrier at the front side would restrict hot air from being discharged. Heat accumulated in an enclosure can cause over-heating. This could potentially result in damage or shorten the product's life span. A high external static pressure sends the air further away from the outdoor unit and through the barrier. This provides better air circulation and distribution.

And a high air pressure of 35Pa discharges the hot air a sufficient distance.

### Previous Model - Low Pressure

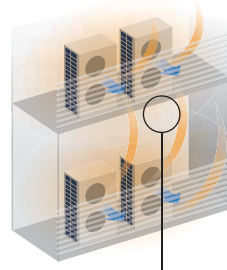

**Heat Accumulated.**  
When the pressure is low, hot air will accumulate in the unit thus affecting its work performance and that of unit above it as well.



Previous fan

### LE Series - High Pressure

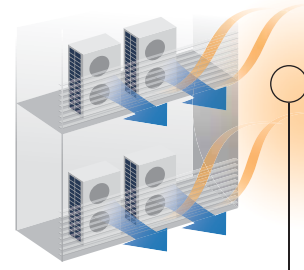

**Heat Discharged.**  
But with a high pressure of 35Pa, hot air is sent further away preventing overheating inside the outdoor unit enclosure.



New LE2's fan

## Long piping design length for greater design flexibility

LE1: Maximum total piping length: 300m.

LE2: Maximum total piping length: 180m.

Maximum height difference between outdoor unit and indoor unit:

**50m\***

Maximum height difference between indoor units:

**15m**

Actual piping length

**150m**

(Equivalent piping length 175m)

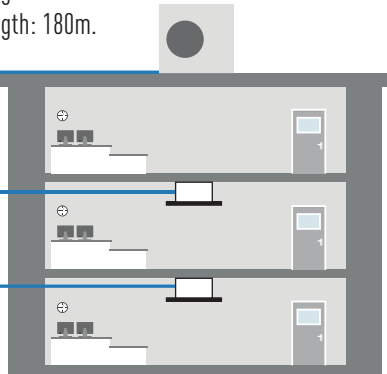

\* 40m if the outdoor unit is below the indoor unit.

- Compact space-saving design
- High external static pressure 35Pa
- Long piping length for flexible installation
- No refrigeration charge up to 50m
- 130% ratio for connectable indoor capacity units

## Compact design

**Mini ECOi LE Series is a single unit.**

Perfect for installations with limited space and easy to hide within a modern building. Flexible space-saving options compared to single split system.

**LE2 short height of 996mm.**

New LE2 Series is 25% smaller in height than conventional model.

## Plug & Play concept

- 50m piping length free of charge
- A 50m pipe length is sufficient for most residential and small business buildings

**FREE OF CHARGE**  
**50m**

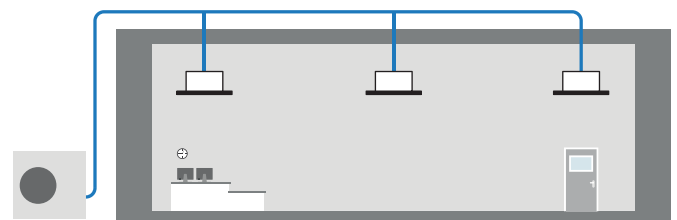

## Up to 15 indoor units connectable

An expansion from Panasonic VRF line up, the mini ECOi is compatible with the same indoor units and controls as the rest of the ECOi range.

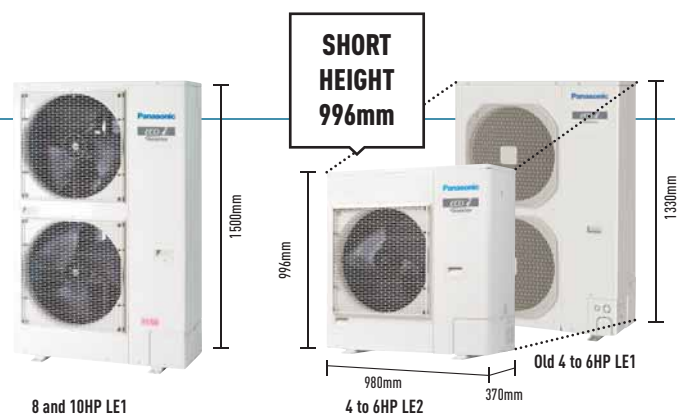

# ENERGY CONTROL & RELIABILITY

## Energy savings design

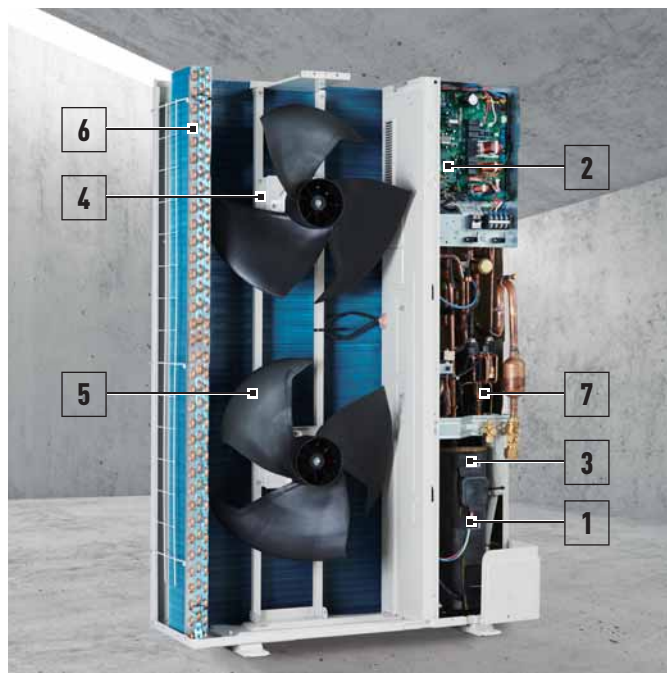

- 1. Panasonic Inverter Compressor.** A large-capacity inverter compressor has been adopted. The inverter compressor is superior in performance with improved partial-load capacity.
- 2. Printed Circuit Board.** The number of PCB is 2 pieces for making maintenance easier.
- 3. Accumulator.** A large accumulator has been adopted to maintain compressor reliability because of the increased refrigerant quantity, which allows an extended maximum piping length.
- 4. DC Fan Motor.** Checking load and outside temperature, the DC motor is controlled for optimum air volume.
- 5. Newly Designed Fan.** The newly designed fan blades have been developed to inhibit air turbulence and to increase efficiency. As fan diameter has been increased its size, the air volume has been increased whilst maintaining a same sound level.
- 6. Heat Exchanger & Copper Tubes.** The heat exchanger size and the copper tube sizes in the heat exchanger have been redesigned to increase efficiency.
- 7. Oil Separator.** A centrifugal separator has been adopted to improve oil separation efficiency and reduce refrigerant pressure loss.

## Bluefin condenser: High durability outdoor unit

The anti-corrosion Bluefin treatment of the heat exchanger provides greater resistance against corrosion. All models are equipped with Bluefin condenser and corrosion-resistance treated for high resistance to rust and salty air to assure long-lasting performance.

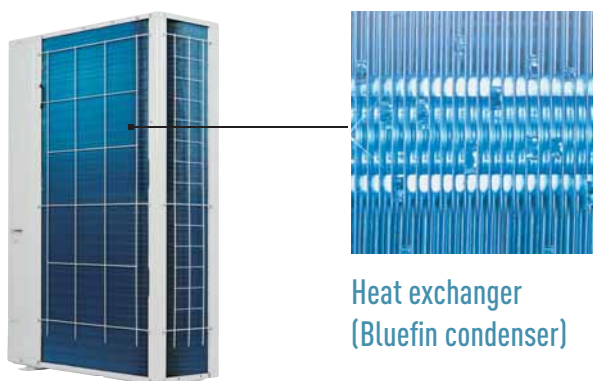

The new Mini ECOi system delivering energy-saving performance, powerful operation, reliability and comfort surpassing anything previously possible.

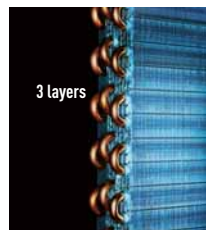

**Powerful heat exchanger.**  
3 layers of heat exchanger for all LE series. LE Series features the same heat exchange volume as conventional model even though it is 15% smaller in size.

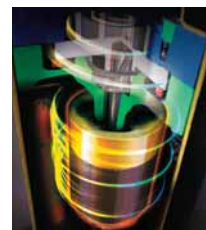

**Panasonic twin Rotary Compressor.**  
A large capacity inverter compressor has been adopted. This new compressor features wider and 0,1Hz step inverter control.



**New design fan.**  
Fan blades have been redesigned to inhibit air resistance and to increase efficiency. The larger fan increases air volume while maintaining low noise levels.

## Superior seasonal energy efficiency (SEER/SCOP follows LOT21\*)

The operation efficiency has been improved using highly efficient R410A refrigerant, a DC Inverter compressor, DC motor and a heat exchanger design.

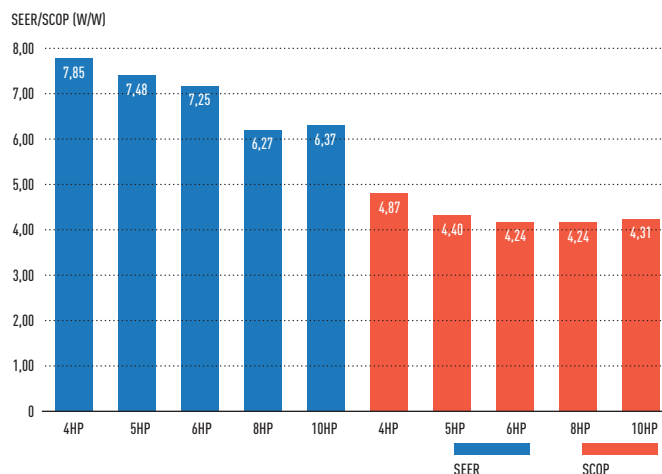

\* SEER/SCOP is calculated based on the seasonal space cooling/heating efficiency "η" values of the COMMISSION REGULATION (EU) 2016/2281. SEER, SCOP = (η + Correction) × PEF.

## Maximum comfort with quiet operation mode

- Quiet operation mode reduces outdoor unit operating sound by 7dB(A)
- 4-step set point is available
- Silent mode 1 maintains rated cooling capacity

\* Timer setting of quiet operation mode is available in High-spec remote controller.

Silent mode options	Sound pressure level
Silent mode 1	-1,5dB(A)
Silent mode 2	-3dB(A)
Silent mode 3	-5dB(A)
Silent mode 4	-7dB(A)

# MINI ECOi LE2 SERIES HIGH EFFICIENCY 4 TO 6HP



Panasonic Mini ECOi. Extraordinary energy-saving. The most compact ECOi system ever.

### For light commercial use

Mini ECOi allows easier installation in condominiums and medium sized buildings with limited spaces. Utilising R410A and DC inverter technology, Panasonic offers VRF to a new and growing market.

### Short height of 996m

In addition to raising efficiency, the outdoor unit has been designed to be as compact as possible. It can now be installed in places that were previously too small.

### Technical focus

- Outstanding SEER and SCOP
- Better efficiency even compared to 2 fan outdoor units
- 50m piping length free of refrigeration charge
- 35Pa high static pressure
- High COP mode selectable with maintenance remote controller
- Selectable silent mode

HP			4HP	5HP	6HP	4HP	5HP	6HP
Outdoor Units			U-4LE2E5	U-5LE2E5	U-6LE2E5	U-4LE2E8	U-5LE2E8	U-6LE2E8
Power supply	Voltage	V	220/230/240	220/230/240	220/230/240	380/400/415	380/400/415	380/400/415
	Phase		Single Phase	Single Phase	Single Phase	Three Phase	Three Phase	Three Phase
	Frequency	Hz	50	50	50	50	50	50
Cooling capacity		kW	12,10	14,00	15,50	12,10	14,00	15,50
EER <sup>1)</sup>		W/W	4,50	4,06	3,73	4,50	4,06	3,73
SEER <sup>2)</sup>		W/W	<b>7,85</b>	<b>7,48</b>	<b>7,25</b>	<b>7,85</b>	<b>7,48</b>	<b>7,25</b>
Running current cooling		A	13,30/12,70/12,20	16,30/15,60/17,00	20,30/19,40/18,60	4,39/4,17/4,02	5,58/5,30/5,11	6,71/6,37/6,14
Input power cooling		kW	2,69	3,45	4,15	2,69	3,45	4,15
Heating capacity		kW	12,50	16,00	16,5	12,50	16,00	16,50
COP <sup>1)</sup>		W/W	5,19	4,60	4,27	5,19	4,60	4,27
SCOP <sup>2)</sup>		W/W	<b>4,87</b>	<b>4,40</b>	<b>4,24</b>	<b>4,87</b>	<b>4,40</b>	<b>4,24</b>
Running current heating		A	12,20/11,60/11,20	17,60/16,80/16,10	19,10/18,20/17,50	3,98/3,78/3,64	5,62/5,34/5,14	6,24/5,93/5,71
Input power heating		kW	2,41	3,48	3,86	2,41	3,48	3,86
Starting current		A	1,00	1,00	1,00	1,00	1,00	1,00
Maximum current		A	17,30	24,30	27,40	7,90	10,10	10,70
Maximum input power		kW	3,50/3,66/3,82	4,92/5,14/5,37	5,61/5,86/6,12	4,34/5,09/5,28	6,25/6,55/6,82	6,62/6,97/7,23
Maximum number of connectable indoor units			7(10) <sup>3)</sup>	8(10) <sup>3)</sup>	9(12) <sup>3)</sup>	7(10) <sup>3)</sup>	8(10) <sup>3)</sup>	9(12) <sup>3)</sup>
External static pressure		Pa	0~35	0~35	0~35	0~35	0~35	0~35
Air volume		m <sup>3</sup> /min	69	72	74	69	72	74
Sound pressure	Cool	dB(A)	52	53	54	52	53	53
	Cool (Silent 1/2/3/4)	dB(A)	50,5/49/47/45	51,5/50/48/46	52,5/51/48/46	50,5/49/49/47	48,5/50/48/46	48,5/50/48/46
	Heat	dB(A)	54	56	56	54	56	56
Sound power	Cool / Heat	dB	69/72	71/75	73/75	69/72	71/75	73/75
Dimension	H x W x D	mm	996 x 980 x 370	996 x 980 x 370	996 x 980 x 370	996 x 980 x 370	996 x 980 x 370	996 x 980 x 370
Net weight		kg	106	106	106	106	106	106
Piping connections	Liquid pipe	Inch (mm)	3/8(9,52)	3/8(9,52)	3/8(9,52)	3/8(9,52)	3/8(9,52)	3/8(9,52)
	Gas pipe	Inch (mm)	5/8(15,88)	5/8(15,88)	5/8(15,88)	5/8(15,88)	5/8(15,88)	5/8(15,88)
Maximum piping length (total)		m	150(180)	150(180)	150(180)	150(180)	150(180)	150(180)
Elevation difference (in/out)		m	50(Outdoor unit upper)/ 40(Outdoor unit lower)	50(Outdoor unit upper)/ 40(Outdoor unit lower)	50(Outdoor unit upper)/ 40(Outdoor unit lower)	50(Outdoor unit upper)/ 40(Outdoor unit lower)	50(Outdoor unit upper)/ 40(Outdoor unit lower)	50(Outdoor unit upper)/ 40(Outdoor unit lower)
	Refrigerant (R410A)	kg/TCO <sub>2</sub> Eq.	6,70(14,40)/ 13,9896	6,70(14,40)/ 13,9896	6,70(14,40)/ 13,9896	6,70(14,40)/ 13,9896	6,70(14,40)/ 13,9896	6,70(14,40)/ 13,9896
Maximum allowable indoor / outdoor capacity ratio		%	50~130	50~130	50~130	50~130	50~130	50~130
Operating range	Cool Min ~ Max	°C	-10~+46	-10~+46	-10~+46	-10~+46	-10~+46	-10~+46
	Heat Min ~ Max	°C	-20~+18	-20~+18	-20~+18	-20~+18	-20~+18	-20~+18

1) EER and COP calculation is based in accordance to EN14511. 2) SEER/SCOP is calculated based on the seasonal space cooling/heating efficiency "η" values of the COMMISSION REGULATION (EU) 2016/2281. SEER, SCOP = (η + Correction) × PEF. 3) In case of 1,50kW indoor unit's connection, able to connect maximum 12 indoor units.



INTERNET CONTROL: Optional.

## MINI ECOi LE1 SERIES HIGH EFFICIENCY 8 AND 10HP



Prepare to be blown away by Panasonic's New Mini VRF system. The Mini VRF compact system is the ideal solution for minimum outdoor space. Panasonic extends the Mini VRF range by 8 and 10HP units.

### Increase external static pressure

When unit is installed on a narrow balcony, the fence at front side will be the obstacle. High external static pressure will overcome this obstacle and maintain operation capacity.

### High ambient temperature performance

Cooling operation range up to 46°C. The system can maintain the rated (100%) capacity up to 40°C by 8HP model & up to 37°C by 10HP model.

### Technical focus

- Piping flexibility with 150m maximum length
- High efficiency
- 15 indoor units connectable
- Quiet operation mode (one of the lowest in the market)
- High ambient temp performance
- High static pressure 35Pa

HP			8HP		10HP	
Outdoor Units			U-8LE1E8		U-10LE1E8	
Power supply	Voltage	V	380/400/415		380/400/415	
	Phase		Three Phase		Three Phase	
	Frequency	Hz	50		50	
Cooling capacity		kW	22,40		28,00	
EER <sup>1)</sup>		W/W	3,80		3,11	
<b>SEER<sup>2)</sup></b>		<b>W/W</b>	<b>6,27</b>		<b>6,37</b>	
Running current cooling		A	9,60/9,15/8,80		14,70/14,00/13,50	
Input power cooling		kW	5,89		9,00	
Heating capacity		kW	25,00		28,00	
COP <sup>1)</sup>		W/W	4,02		3,93	
<b>SCOP<sup>2)</sup></b>		<b>W/W</b>	<b>4,24</b>		<b>4,31</b>	
Running current heating		A	10,20/9,65/9,30		11,60/11,10/10,70	
Input power heating		kW	6,22		7,13	
Starting current		A	1,00		1,00	
Maximum current		A	13,70		19,60	
Maximum input power		kW	9,16		13,10	
Maximum number of connectable indoor units			15 <sup>3)</sup>		15 <sup>3)</sup>	
External static pressure		Pa	0~35		0~35	
Air volume		m <sup>3</sup> /min	150		160	
Sound pressure	Cool	dB(A)	60		63	
	Cool(Silent 1/2/3/4)	dB(A)	57/55/53		60/58/56	
	Heat	dB(A)	64		65	
Sound power	Cool / Heat	dB	81/85		84/86	
Dimension	H x W x D	mm	1500 x 980 x 370		1500 x 980 x 370	
Net weight		kg	132		133	
Piping connections	Liquid pipe	Inch (mm)	3/8(9,52) <sup>4)</sup> 1/2(12,70) <sup>5)</sup>		3/8(9,52) <sup>4)</sup> 1/2(12,70) <sup>5)</sup>	
	Gas pipe	Inch (mm)	3/4(19,05) <sup>4)</sup> 7/8(22,22) <sup>5)</sup>		7/8(22,22) <sup>4)</sup> 1(25,40) <sup>5)</sup>	
Maximum piping length (total)		m	7,5~150 (7,5~300)		7,5~150 (7,5~300)	
Elevation difference (in/out)		m	50 (Outdoor unit upper) / 40 (Outdoor unit lower)		50 (Outdoor unit upper) / 40 (Outdoor unit lower)	
Refrigerant (R410A)		kg / TCO <sub>2</sub> Eq.	6,30 (24,00) / 13,1544		6,60 (24,00) / 13,7808	
Maximum allowable indoor / outdoor capacity ratio		%	50~130		50~130	
Operating range	Cool Min ~ Max	°C	-10~+46		-10~+46	
	Heat Min ~ Max	°C	-20~+18		-20~+18	

1) EER and COP calculation is based in accordance to EN14511. 2) SEER/SCOP is calculated based on the seasonal space cooling/heating efficiency "η" values of the COMMISSION REGULATION (EU) 2016/2281. SEER, SCOP = (η<sub>1</sub> + Correction) × PEF. 3) If the heating utilized, it is necessary to increase 1 size with respect to the main liquid pipe, depending on the combination of the indoor unit. 4) Under 90m for ultimate indoor unit. 5) Over 90m for ultimate indoor unit. If the longest piping equivalent length exceeds 90m, increase the sizes of the main tubes by 1 rank for gas and liquid pipes.



INTERNET CONTROL: Optional.

# ECOi EX THE GAME CHANGER





VRF with outstanding energy-saving performance and powerful operation SEER 7,56 (2-Pipe 18HP model).



A game-changing VRF system delivering energy-saving performance, powerful operation, reliability and comfort surpassing anything previously possible. It represents a true paradigm shift in air conditioning solutions. Taking quality to the extreme — that's the Panasonic challenge.

## 1 High performance at extreme conditions

ECOi EX is highly reliable, with strong cooling & heating power, even when operating at extreme ambient temperatures. The units can operate at 100% of capacity at 43°C, reaching a great cooling operation up to 52°C and in heating -25°C\*.

Also, the ECOi EX features include Bluefin in newly designed heat exchanger improving efficiency as well in marine ambient. A silicone coated PCB (Printed Circuit Board) protects the unit from being damaged by environmental factors such as moisture and dust.

## 2 Outstanding efficiency and comfort

The new ECOi EX system is designed to increase energy efficiency by delivering high SEER rating, as well as high efficiency for part-load operations. The system has reduced energy costs thanks to "All-Inverter Compressors", with independent control to deliver highly flexible performance. Also, the ECOi EX features an enlarged heat exchanger with triple surfaces that allow for improved heat transfer and a newly designed curved air discharge bell-mouth for better aerodynamics. The three-stage oil recovery design makes it able to minimise the frequency of forced oil recovery, leading to reduced energy costs and sustained comfort.

## 3 Superior flexibility

With its up to 1000\* meters of pipeline, its maximum 30 meters height difference between indoor units and its 200 meters length, the design possibilities have grown exponentially making the new ECOi EX the ideal air conditioning option for long haul buildings, such as train stations, airports, schools or hospitals. These advantages are enhanced with the wide range of indoor unit models and capacities facilitating the perfect adaptation to all kind of projects. The careful selection of controls and peripherals such as the Pump Down, the AHU or/and the chiller, enables an optimum system use. Connectable maximum allowable indoor / outdoor capacity ratio up to 200%\*.

\* Conditions of 2-Pipe ECOi EX ME2 Series.



# TOP EFFICIENCY AND COMFORT

Remarkable improvement on key components: extraordinary energy-saving performance and redesigned for smooth and better air discharge.

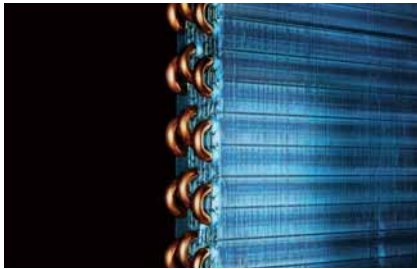

Enlarged heat exchanger surface area with triple surface.

\* For 8 & 10HP unit, the heat exchanger is 2 row design.



Multiple large-capacity all inverter compressors (more than 14HP).



Newly designed curved air discharge bell mouth for better aerodynamics.

## Improvements on refrigerant circuit

### Compressor.

Redesigned components in the body provide performance improvement especially in the rated cooling condition and AEER performance.



### Accumulator.

New oil returning circuit with control valve makes efficient oil recovery to compressor.

### Oil separator.

Modified tank design makes efficient oil separation with less pressure drop.



### Receiver tank less design

Improved refrigerant control program recovers the remaining refrigerant gas in the system back to the accumulator tank effectively.



## Smooth exhaust flow by new bell-mouth

The new curved shape with integrated top and bottom assure smooth exhaust flow. This gives more air-volume with same sound level, less input power at same air volume.

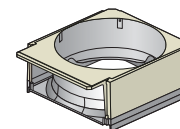

Conventional model (ME1)

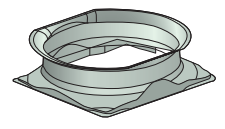

New model (ME2)

Sound pressure dB(A)

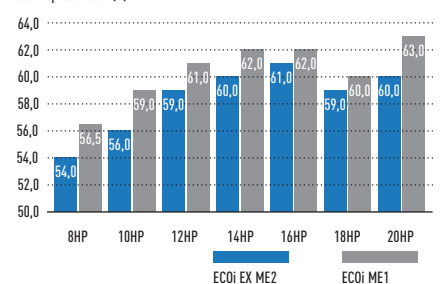

## Combined 3 surface heat exchanger

The highly efficient piping pattern increases heat exchange performance by 5%. The new heat exchanger features a 3 surface construction.

Compared to the divided dual-surface construction in current models, there is no divided space and the face area of heat exchanger becomes larger.



Conventional model (ME1)



New model (ME2)

# OIL RECOVERY INTELLIGENT CONTROL

## Intelligent 3-stage Oil Management System

In a VRF system, where lengthy piping and a large number of indoor units need to be controlled collectively, the key to maintaining the system's reliability is to ensure an appropriate amount of oil is secured in the compressors. In order to avoid oil shortage in the compressor, maximum operation is normally forcibly conducted at regular intervals to recover oil from indoor units. This method, typically employed in a standard VRF, causes the system to overheat or overcool and thus waste energy. In Panasonic VRF systems, a sensor for detecting oil levels is mounted in each compressor. In installations with multiple outdoor units, a shortage of oil in one compressor can be compensated for by recovering oil either from another compressor in the same unit, from a compressor in an adjacent outdoor unit, or from a connected indoor unit. Panasonic VRF systems provide users with a comfortable environment whilst saving energy.

## Oil recovery intelligent control advantages:

1. Higher efficiency
2. Durability
3. Comfort:
  - Continuous operation
  - Low noise
  - Low vibration

## Features of oil recovery design

### Oil sensors installed in each compressor.

Oil sensors installed in each Panasonic compressor precisely monitor oil levels, eliminating unnecessary oil recovery.

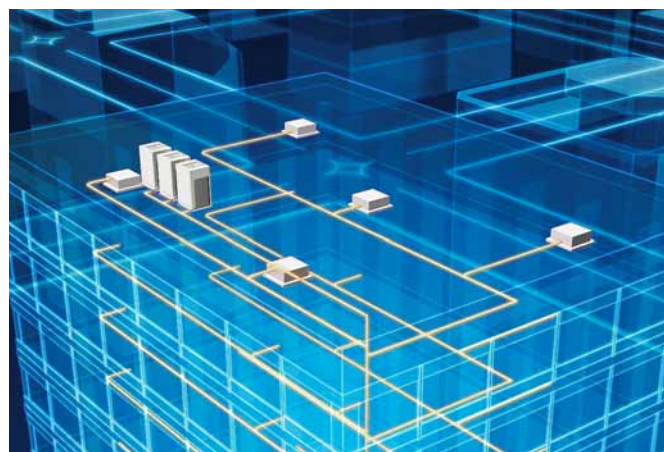
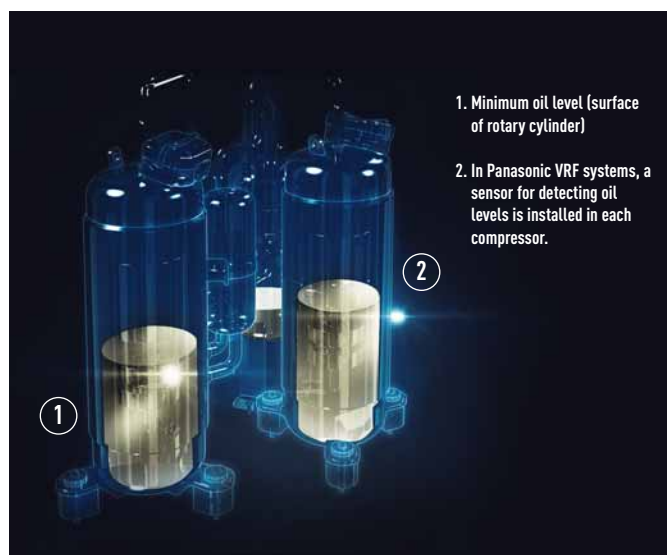

**The Panasonic system efficiently manages oil recovery in three stages; minimising the frequency of forced oil recovery while reducing energy cost and maintaining comfort.**

**STAGE-1:** Panasonic compressors are equipped with sensors which monitor oil levels precisely at all times. If oil levels fall, oil can be transferred from other compressors within the same outdoor unit.

**STAGE-2:** If oil levels in all compressors within the outdoor unit fall, oil can be replenished from adjacent outdoor units.

**STAGE-3:** Forced oil recovery is implemented only if oil levels become insufficient in spite of above measures. The Panasonic system's design concept is radically different from conventional oil systems.

### Highly functional oil separator.

Thanks to extended separate piping, oil recovery efficiency reaches 90%, minimising the oil to be discharged from the compressor.



# TWIN ROTARY INVERTER COMPRESSOR

## New twin rotary inverter compressor

Two independently controlled inverter compressors achieve high efficiency. Redesigned components in the body provide performance improvement especially in the rated cooling condition and EER performance.

- Wider and flexible control on Inverter compressor
- Better oil lubrication
- Smooth start up



## Extraordinary energy-saving performance

Designed for Actual Operation Performance. Panasonic builds air conditioning systems not only with a high EER for rated operation, but also with Seasonal-EER appropriate to the customer's actual environment of use. For instance, with rated operation, outdoor temperature is constant at 35°C, but in reality the outdoor temperature is continuously changing. Consequently, required air conditioning performance also changes. That's why Panasonic implements the following kind of proprietary control.

1. Set temperature is rapidly attained; full-load operating time is kept to a minimum.
2. The frequency of forced oil recovery is minimised. The volume of oil within the compressors is monitored precisely by sensors, so forced oil recovery under full-load operation is conducted only when necessary. Since this suppresses noise due to oil recovery, comfort is maintained.
3. Panasonic pursues a high EER, of course, as well as high EER in part load, for energy saving performance under a broad range of loads. Panasonic's design concept contributes to substantial energy cost reductions.

## Compressor efficiency electric system VRF.

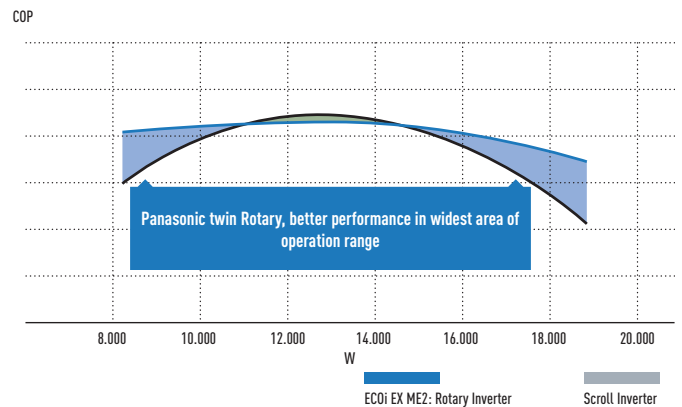

## Number of Inverter compressors

Size	2-Pipe ECOi EX ME2				3-Pipe ECOi EX MF3							
	Small		Medium		Medium		Large					
HP	8HP	10HP	12HP	14HP	16HP	18HP	20HP	8HP	10HP	12HP	14HP	16HP
Number	1 pc.		1 pc.	2 pcs.	2 pcs.	1 pc.		2 pcs.				

## Actual operation data graph of Panasonic VRF

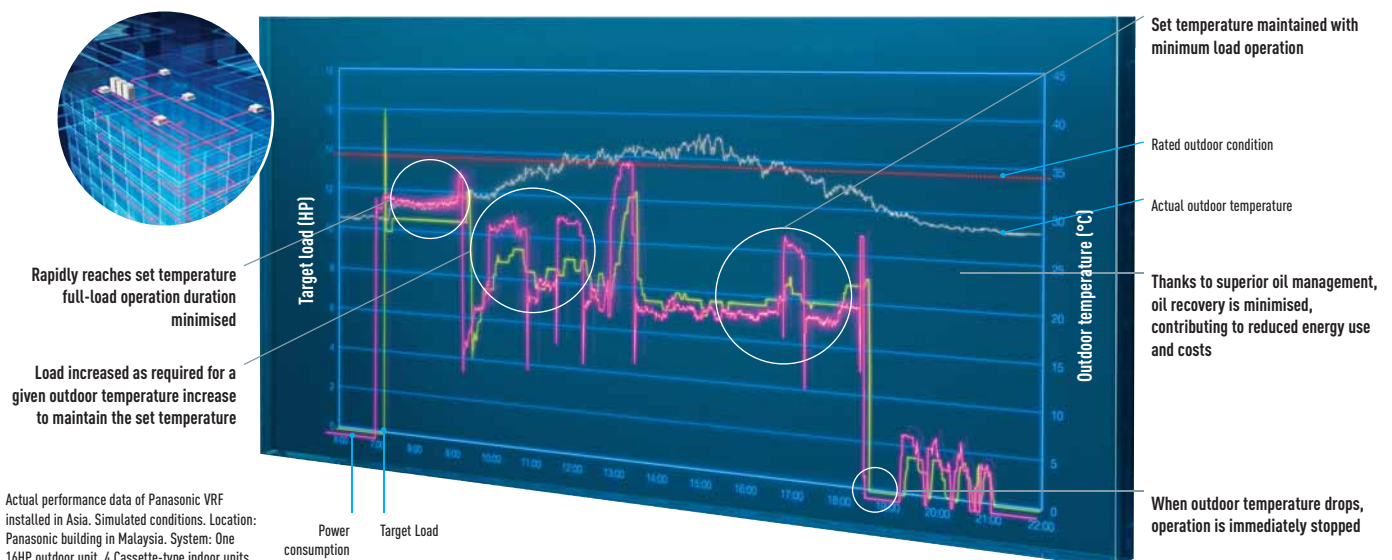

Actual performance data of Panasonic VRF installed in Asia. Simulated conditions. Location: Panasonic building in Malaysia. System: One 16HP outdoor unit, 4 Cassette-type indoor units.

# SUPERIOR QUALITY, RELIABILITY AND DURABILITY

## High safety operation in case of breakdown!

### Automatic Back-Up operation. Ensures heating and cooling.

It is possible for the system to keep working, even if the compressors, fan motor and the temperature sensor are damaged (even when a compressor fails in single unit with 2 compressors inside).

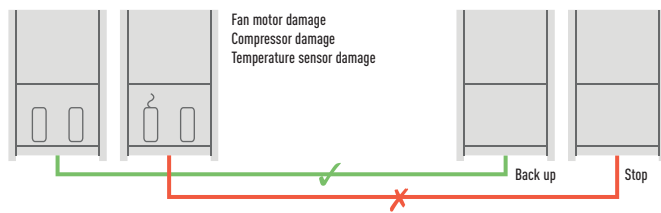

### The system will still operate up to 25% of the connected indoor units.

System will not stop when up to 25% of indoor units have power supply breakdown when they are ON Mode.

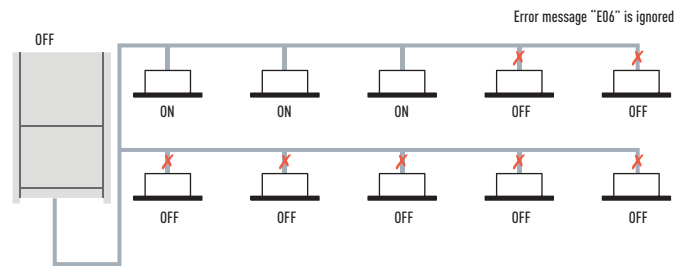

## Hi-durability outdoor unit

Treated for high resistance to corrosion (rust and salty air) to ensure long-lasting performance.

Note: Selecting this unit does not completely eliminate the possibility of rust developing. For details concerning unit installation and maintenance, please consult an authorised dealer.

### Specially protected parts.

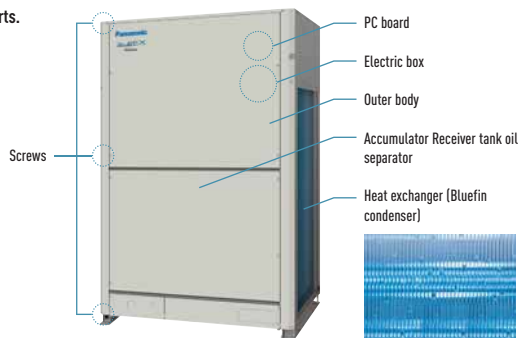

## Extended compressor life by uniform compressor operation time

The total run-time of compressors are monitored by a built-in microcomputer, which ensures that operation times of all compressors within the same refrigerant circuit are balanced.

Compressors with histories showing shorter run times are selected first, ensuring equal wear and tear across all units and extending the working life of the system.

### System example.

A,C: DC inverter compressor  
B,D: Constant speed compressor

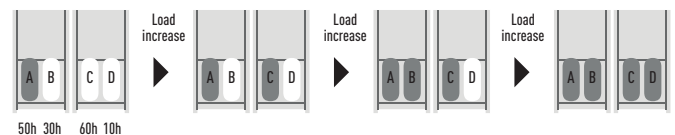

\* Depend on accumulated operation time of each compressors.  
\* Compressor priority has possibility to be changed.  
(e.g) Case 1: A→C→B→D, Case 2: C→A→D→B, Case 3: A→C→D→B, Case 4: C→A→B→D  
\* Also other cases available.

## A large number of indoor unit models can be connected



# 2-PIPE ECOi EX ME2 SERIES EXTRAORDINARY PARTIAL LOAD AND SEER/SCOP

## Efficiency in VRF systems

The only way to compare so far, was the nominal efficiency at outdoor ambient temperature of 35°C (EER) in Cooling and at 7°C in heating (COP). With new EN-14825 seasonal efficiency will be shown, the result will be SEER and SCOP. New ECOi EX is reaching excellent performance without using any additional saving functions.

## The highest EER/COP rating in most capacities

### Compared to conventional model ECOi (ME1)

The ECOi EX marks a revolutionary step forward in VRF efficiency. A look at the incredible EER/COP value clearly indicates that. What's more, this high EER/COP value is achieved even during part load operation. This shows the extraordinary energy-saving performance the ECOi EX is capable of providing.

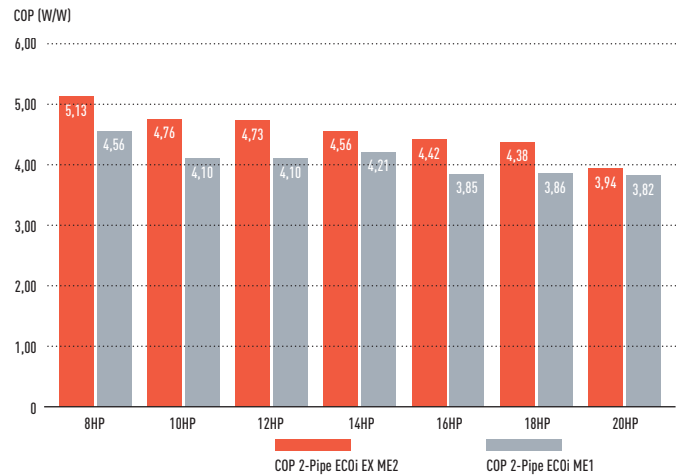
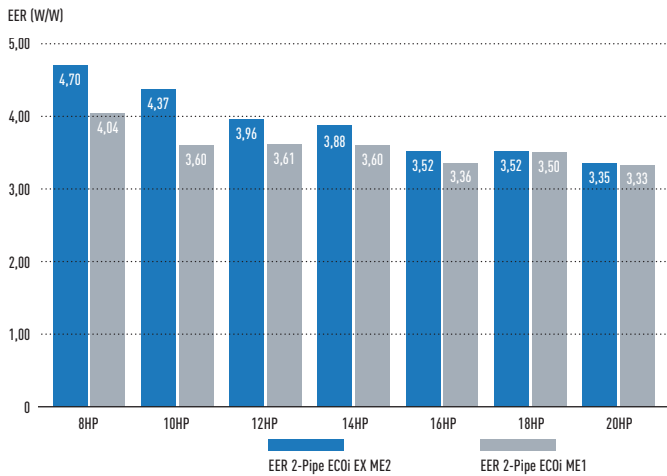

## Partial load for seasonal and real system efficiency

VRF units are designed to adapt to the heating and cooling demand, adapting its performance to different outdoor conditions. When compressor runs at lower than 100% capacity, the system is working at partial load. A wider compressor operating range results in better system performance both at full load and partial load conditions. Panasonic ECOi EX partial load is excellent, reaching a minimum of 15% of compressor capacity.

## Excellent efficiency at any condition and partial load

In both heating and cooling mode, Panasonic ECOi EX is reaching exceptional levels of efficiency.

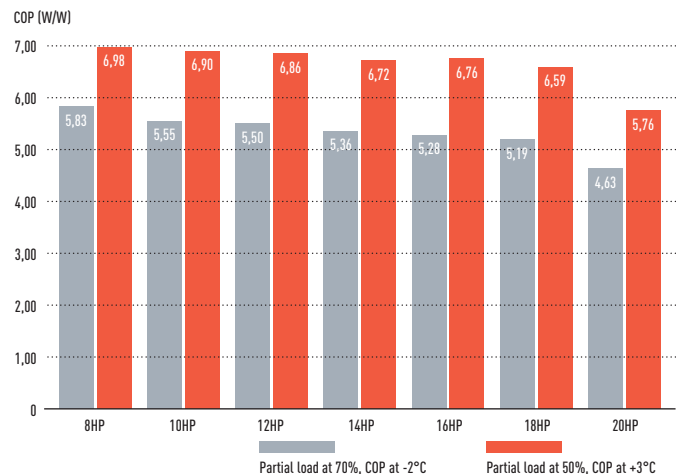
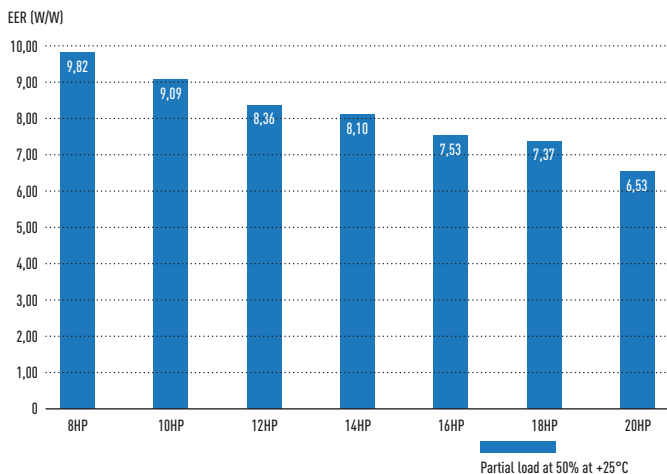

### SEER and SCOP following to EN-14825

When better partial load, better efficiency is achieved in real operation. New EN-14825 is showing the way to calculate considering full year operation hours at different conditions. New Panasonic ECOi EX is designed to save energy in any partial load conditions. Most of operation hours system is under partial load conditions, 80% of total operation hours is less than 70% of full load. In below graphs is the example for average ambient conditions, this uses Strasbourg ambient conditions for calculation.

Outside temperature distribution

Time distribution (hours / year)

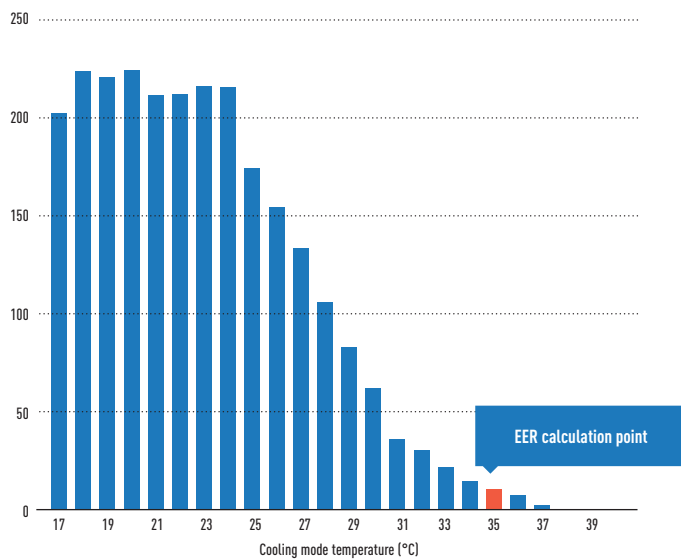

Outside temperature distribution

Time distribution (hours / year)

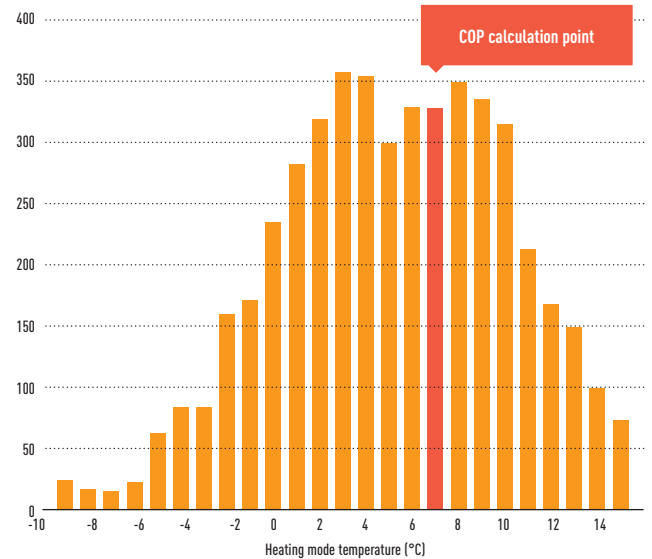

In the characteristics EER and COP only a single temperature for the assessment of the efficiency is taken as a basis in each case. Data calculated under EN-14825 conditions, not additional saving function considered for this calculation. Compressor frequency according to ambient temperature and building design.

### SEER and SCOP values

ECOi EX models have superior seasonal space cooling/heating efficiency following not only EN 14825 but also COMMISSION REGULATION (EU) 2016/2281. This regulation requires to use "η" values in the technical documents from January 2018.

Please visit our websites [www.aircon.panasonic.eu](http://www.aircon.panasonic.eu) or [www.ptc.panasonic.eu](http://www.ptc.panasonic.eu).

SEER/SCOP (W/W)

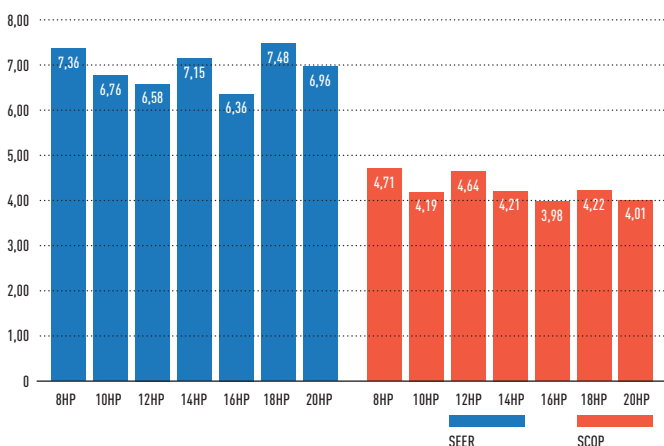

However, if it was necessary by setting on commissioning Panasonic, can increase efficiency additionally by "20%" increasing evaporation refrigerant temperature range, for a higher efficiency and lower energy consumption.

ESEER (W/W)

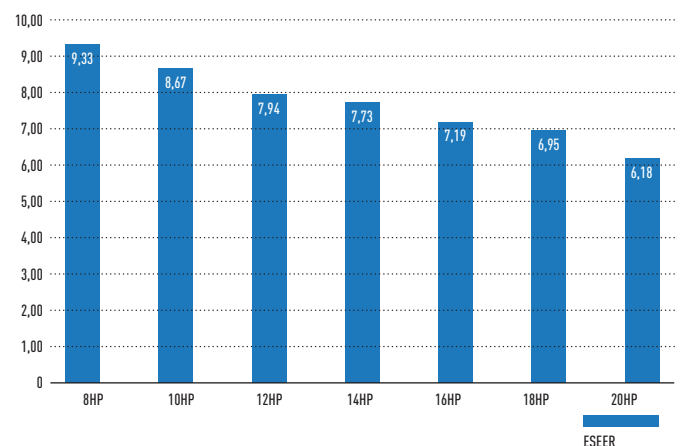

# 2-PIPE ECOi EX ME2 SERIES HIGH PERFORMANCE AT EXTREME CONDITIONS

The ECOi EX can still operate at 100% capacity when the outside temperature is as high as 43°C. This high power capability enables reliable operation even under extremely high temperature conditions.

## Extremely high capacity at -20°C and unique heating capacity at -25°C

Heating capacity (kW)

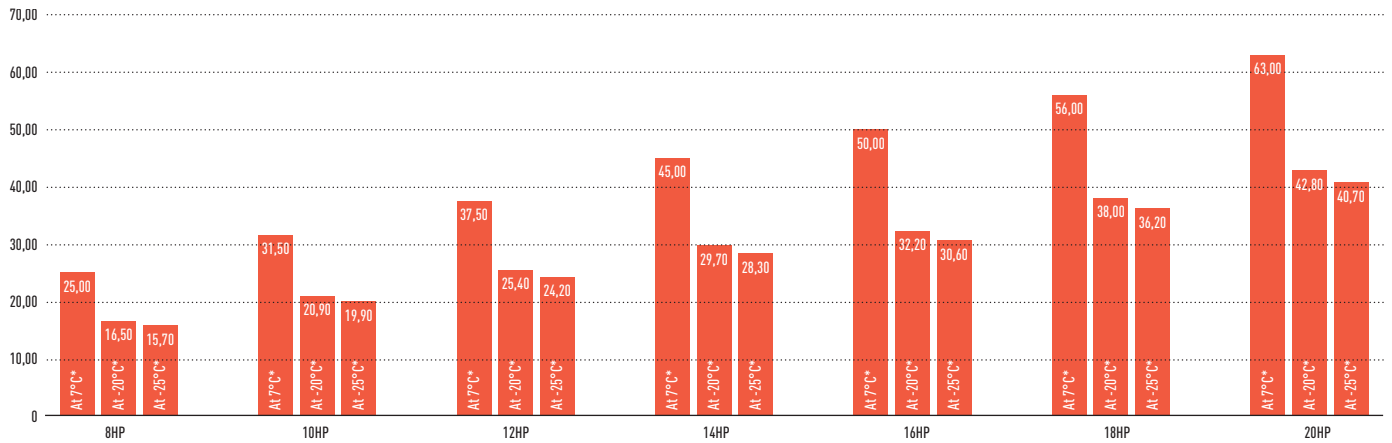

\* Outdoor air temperature [°C WB].

## Trusted reliability even under high and low temperature conditions

Designed to be durable enough to withstand extreme heat, 2-Pipe ECOi EX ME2 Series ensures reliable cooling operation over an extended operation range up to 52°C, and heating operation also at minus -25°C.

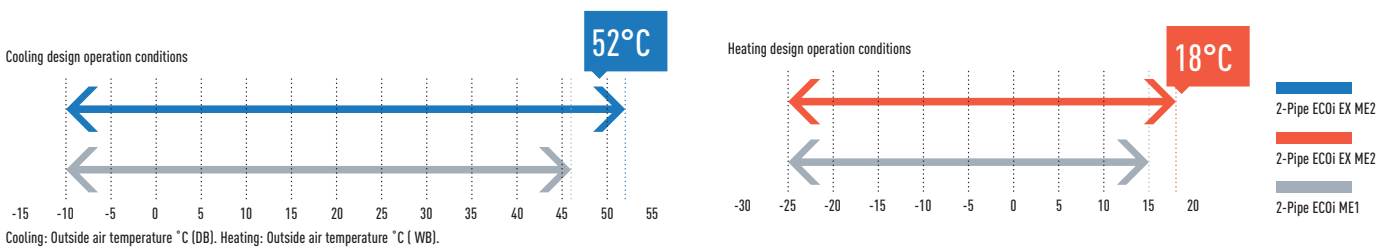



# 2-PIPE ECOi EX ME2 SERIES SUPERIOR FLEXIBILITY

## Connectable maximum allowable indoor / outdoor capacity ratio up to 200%\*

ECOi EX attain maximum indoor unit connection capacity of up to 130% of the unit's connection range. This limit can be overpassed and reach up to 200% if some conditions are satisfied. With this feature, ECOi EX provides an ideal air conditioning solution for locations where full cooling/heating are not always required in all spaces at same time.

System ( HP)	8	10	12	14	16	18	20	22	24	26	28	30	32	34	36	38	40	42	44	46	48	50	52	54	56	58	60	62	64	66	68	70	72	74	76	78	80
Connectable indoor units: 130%	13	16	19	23	26	29	33	36	40	43	46	50	53	56	59															64							
Connectable indoor units: 200%	20	25	30	35	40	45	50	55	60											64																	

Note: If more than 100% indoor units are operated with a high load, the units may not perform at the rated capacity. For the details, please consult with an authorised Panasonic dealer. \* If the following conditions are satisfied, the effective range is above 130% up to 200%. Obey the limited number of connectable indoor units. The lower limit of operating range for heating outdoor temperature is limited to -10°C WB (standard -25°C WB). Simultaneous operation is limited to less than 130% of connectable indoor units. 1.50kW capacity of Indoor Units are included.

## Increased piping lengths and design flexibility

Adaptable to various building types and sizes. Actual piping length: 200m. Maximum piping length: 1.000m.

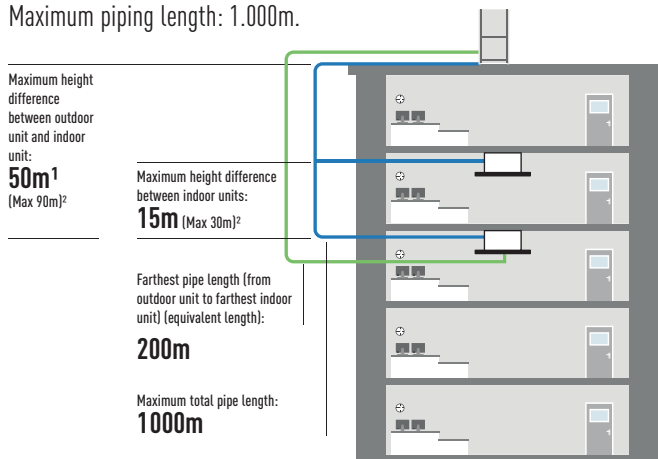

1. 40m if the outdoor unit is below the indoor unit.
2. Setting change is necessary. Please contact an authorized Panasonic dealer in the case of conditions below:  
50 < Height difference between OU and IU ≤ 90 or 15 < Height difference between IUs ≤ 30.

## Up to 50m length difference between the longest and the shortest piping from the first branch

Flexible piping layout makes it easier to design systems for locations such as train stations, airports, schools and hospitals.

- Up to 64 units can be connected to one system
- Difference between maximum and minimum pipe runs after first branch can be a maximum of 50m
- Larger pipe runs can be up to 200m

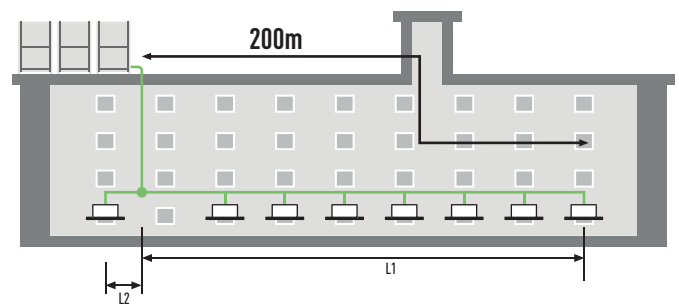

L1 = Longest pipe run. L2 = Shortest pipe run. L1 - L2 = Maximum 50m.

## Compact design

The ME2 series has reduced the installation space required with up to 20HP available in a single chassis. 8 - 10HP are able to fit inside a lift for easy handling on site.

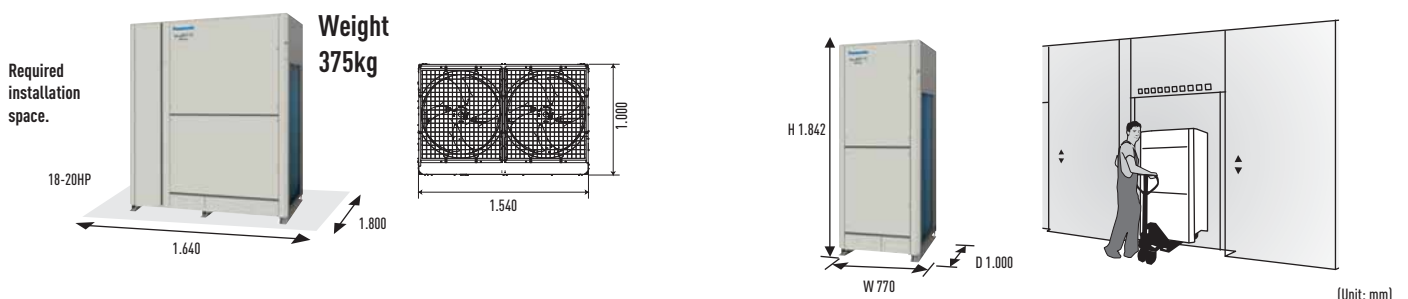

(Unit: mm)

# 2-PIPE ECOi EX ME2 SERIES PIPING DESIGN

Select installation locations so that the lengths and sizes of refrigerant piping are within the allowable ranges shown in the figure below.

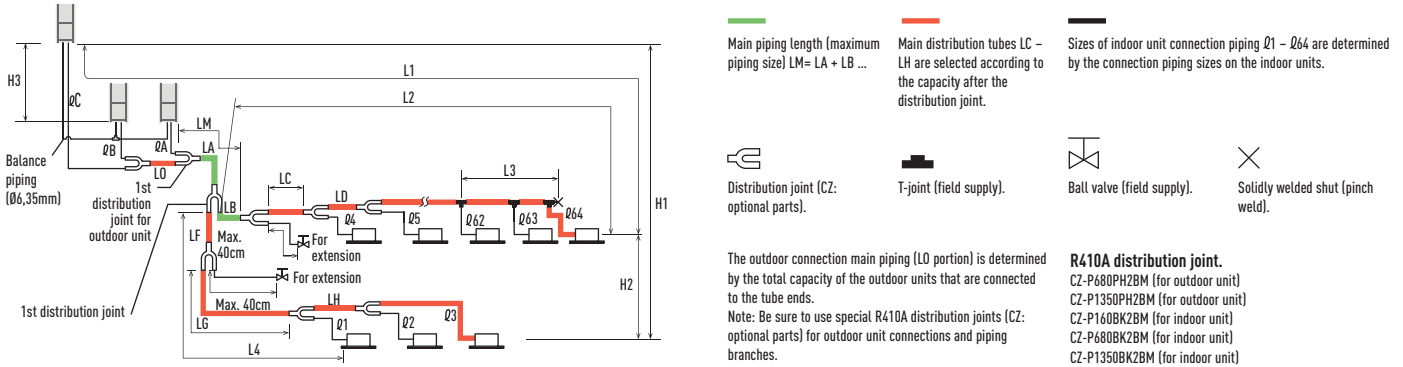

## Ranges that apply to refrigerant piping lengths and to differences in installation heights

Items	Mark	Contents	Length (m)
Allowable piping length	L1	Maximum piping length	Actual length ≤200 <sup>1)</sup> Equivalent length ≤210 <sup>1)</sup>
	Δ L (L2-L4)	Difference between maximum length and minimum length from the 1st distribution joint	≤50 <sup>2)</sup>
	LM	Maximum length of main piping (at maximum size) * Even after 1st distribution joint, LM is allowed if at maximum piping length.	— <sup>3)</sup>
	Q1, Q2- Q64	Maximum length of each distribution tube	≤50 <sup>4)</sup>
	L1+ Q1+ Q2- Q51+ QA+QB+LF+LG+LH	Total maximum piping length including length of each distribution tube (only liquid piping)	≤1000
Allowable elevation difference	QA, QB+LO, QC+LO	Maximum piping length from outdoor's 1st distribution joint to each outdoor unit	≤10
	H1	When outdoor unit is installed higher than indoor unit	≤50
	H2	When outdoor unit is installed lower than indoor unit	≤40
	H3	Maximum difference between indoor units	≤15 <sup>5)</sup>
Allowable length of joint piping	L3	T-joint piping (field-supply); Maximum piping length between the first T-joint and solidly welded-shut end point	≤2

L = Length, H = Height

1) If the longest piping length (L1) exceeds 90m (equivalent length), increase the sizes of the main tubes (LM) by 1 rank for gas tubes and liquid tubes. Use a field supply reducer. Select the tube size from the table of main piping sizes (Table 3) and from the table of refrigerant piping sizes (Table 8). 2) When the piping length exceeds 40m, increase a longer liquid or gas piping by 1 rank. Refer to the Technical Data for the details. 3) If the longest main piping length (LM) exceeds 50m, increase the main piping size at the portion before 50m by 1 rank for the gas tubes. Use a field supply reducer. Determine the length less than the limitation of allowable maximum piping length. For the portion that exceeds 50m, set based on the main piping size (LA) listed in Table 3. 4) If any of the piping length exceeds 30m, increase the size of the liquid and gas tubes by 1 rank. 5) If the total distribution piping length exceeds 500m, maximum allowable elevation difference (H2) between the indoor units is calculated by the following formula. Make sure the indoor unit's actual elevation difference should fall within the figure calculated as follows. Unit of account (meter):  $15 \times 2 - \text{total piping length (m)} \div 500$ .

\* The outdoor connection main piping (LO portion) is determined by the total capacity of the outdoor units that are connected to the tube ends. If the size of the existing piping is already larger than the standard piping size, it is not necessary to further increase the size.  
 \*\* If the existing piping is used, and the amount of on-site refrigerant charge exceeds the value listed below, then change the size of the piping to reduce the amount of refrigerant. Total amount of refrigerant for the system with 1 outdoor unit: 50kg. Total amount of refrigerant for the system with 2 outdoor units: 80kg. Total amount of refrigerant for the system with 3 outdoor units or 4 outdoor units: 105kg.

## Necessary amount of additional refrigerant charge per outdoor unit.

U-8ME2E8	U-10ME2E8	U-12ME2E8	U-14ME2E8	U-16ME2E8
5,5kg	5,5kg	7,0kg	7,0kg	7,0kg

## System limitations.

Maximum number allowable connected outdoor units	4 <sup>1)</sup>
Maximum capacity allowable connected outdoor units	224kW (80HP)
Maximum connectable indoor units	64 <sup>2)</sup>
Maximum allowable indoor / outdoor capacity ratio	50-130% <sup>3)</sup>

1) Up to 4 units can be connected if the system has been extended.  
 2) In the case of 38HP or smaller units, the number is limited by the total capacity of the connected indoor units.  
 3) If the following conditions are satisfied, the effective range is above 130% and below 200%.  
 A) Obey the limited number of connectable indoor units. B) The lower limit of operating range for heating outdoor temperature is limited to -10°C WB (standard -25°C WB). C) Simultaneous operation is limited to less than 130% of connectable indoor units.

## Additional refrigerant charge.

Liquid piping size Inch (mm)	Amount of refrigerant charge/m (g/m)
1/4 (6,35)	26
3/8 (9,52)	56
1/2 (12,70)	128
5/8 (15,88)	185
3/4 (19,05)	259
7/8 (22,22)	366
1 (25,40)	490

## Refrigerant piping (existing piping can be used).

Piping size (mm)				Material Temper - 1/2 H, H									
Material Temper - O				Material Temper - 1/2 H, H									
ø6,35	t 0,8	ø12,7	t 0,8	ø19,05	t 1,2	ø22,22	t 1,0	ø28,58	t 1,0	ø38,1	over t 1,35	ø44,45	over t1,55
ø9,52	t 0,8	ø15,88	t 1,0			ø25,4	t 1,0	ø31,75	t 1,1	ø41,28	over t 1,45	ø44,45	over t1,55

\* When bending the tubes, use a bending radius that is at least 4 times the outer diameter of the tubes. In addition, take sufficient care to avoid crushing or damaging the tubes when bending them.

## 2-PIPE ECOi EX ME2 SERIES



A VRF system delivering energy-saving performance, powerful operation, reliability and comfort surpassing anything previously possible. It represents a true paradigm shift in air conditioning solutions.

VRF with outstanding energy-saving performance and powerful operation SEER 7,56 (18HP model).

### Technical focus

- New twin rotary inverter compressor
- High performance at extreme conditions
- Outstanding efficiency and comfort
- Extraordinary partial load and SEER/SCOP
- SEER and SCOP following to EN-14825
- Oil recovery intelligent control
- Top comfort
- Superior flexibility
- Bluefin full line up EX
- Extremely high capacity at -20°C and unique heating capacity at -25°C
- Smooth exhaust flow by new bell-mouth

			8HP	10HP	12HP	14HP	16HP	18HP	20HP
Outdoor Units			U-8ME2E8	U-10ME2E8	U-12ME2E8	U-14ME2E8	U-16ME2E8	U-18ME2E8	U-20ME2E8
Power supply	Voltage	V	380/400/415	380/400/415	380/400/415	380/400/415	380/400/415	380/400/415	380/400/415
	Phase		Three Phase	Three Phase	Three Phase	Three Phase	Three Phase	Three Phase	Three Phase
	Frequency	Hz	50	50	50	50	50	50	50
Cooling capacity		kW	22,40	28,00	33,50	40,00	45,00	50,00	56,00
EER <sup>1)</sup>		W/W	4,70	4,37	3,96	3,88	3,52	3,52	3,35
ESEER		W/W	9,33	8,67	7,94	7,73	7,19	6,95	6,18
SEER <sup>2)</sup>		W/W	<b>7,43</b>	<b>6,83</b>	<b>6,65</b>	<b>7,23</b>	<b>6,43</b>	<b>7,56</b>	<b>7,03</b>
Running current cooling		A	7,40/7,14	10,20/9,80	13,00/12,50	16,50/15,90	20,10/19,40	22,00/21,20	25,40/24,50
Input power cooling		kW	4,77	6,41	8,47	10,30	12,80	14,20	16,70
Heating capacity		kW	25,00	31,50	37,50	45,00	50,00	56,00	63,00
COP <sup>1)</sup>		W/W	5,13	4,76	4,73	4,56	4,42	4,38	3,94
SCOP <sup>2)</sup>		W/W	<b>4,79</b>	<b>4,26</b>	<b>4,72</b>	<b>4,28</b>	<b>4,05</b>	<b>4,29</b>	<b>4,09</b>
Running current heating		A	7,56/7,29	10,50/11,10	12,30/11,80	15,80/15,20	17,90/17,30	20,10/19,40	24,60/23,70
Input power heating		kW	4,87	6,62	7,92	9,86	11,30	12,80	16,00
Starting current		A	1,00	1,00	1,00	2,00	2,00	2,00	2,00
External static pressure (Max)		Pa	80	80	80	80	80	80	80
Air volume		m <sup>3</sup> /min	224	224	232	232	232	405	405
Sound pressure	Normal mode	dB(A)	54	56	59	60	61	59	60
	Silent mode	dB(A)	51	53	56	57	58	56	57
Sound power	Normal mode	dB	75	77	80	81	82	80	81
Dimension	H x W x D	mm	1842x770 x1000	1842x770 x1000	1842x1180 x1000	1842x1180 x1000	1842x1180 x1000	1842x1540 x1000	1842x1540 x1000
Net weight		kg	210	210	270	315	315	375	375
Piping connections <sup>3)</sup>	Liquid pipe	Inch (mm)	3/8(9,52)/ 1/2(12,70)	3/8(9,52)/ 1/2(12,70)	1/2(12,70)/ 5/8(15,88)	1/2(12,70)/ 5/8(15,88)	1/2(12,70)/ 5/8(15,88)	5/8(15,88)/ 3/4(19,05)	5/8(15,88)/ 3/4(19,05)
	Gas pipe	Inch (mm)	3/4(19,05)/ 7/8(22,22)	7/8(22,22)/ 1(25,40)	1(25,40)/ 1-1/8(28,58)	1(25,40)/ 1-1/8(28,58)	1-1/8(28,58)/ 1-1/4(31,75)	1-1/8(28,58)/ 1-1/4(31,75)	1-1/8(28,58)/ 1-1/4(31,75)
	Balance pipe	Inch (mm)	1/4(6,35)	1/4(6,35)	1/4(6,35)	1/4(6,35)	1/4(6,35)	1/4(6,35)	1/4(6,35)
Refrigerant (R410A)		kg/TCO <sub>2</sub> Eq.	5,60/11,6928	5,60/11,6928	8,30/17,3304	8,30/17,3304	8,30/17,3304	9,50/19,836	9,50/19,836
Maximum allowable indoor / outdoor capacity ratio % <sup>4)</sup>			50 ~ 130(200)	50 ~ 130(200)	50 ~ 130(200)	50 ~ 130(200)	50 ~ 130(200)	50 ~ 130(200)	50 ~ 130(200)
Operating range	Cool Min ~ Max	°C	-10 ~ +52	-10 ~ +52	-10 ~ +52	-10 ~ +52	-10 ~ +52	-10 ~ +52	-10 ~ +52
	Heat Min ~ Max	°C	-25 ~ +18	-25 ~ +18	-25 ~ +18	-25 ~ +18	-25 ~ +18	-25 ~ +18	-25 ~ +18

1) EER and COP calculation is based in accordance to EN14511. 2) SEER/SCOP is calculated based on the seasonal space cooling/heating efficiency "η<sub>s</sub>" values of the COMMISSION REGULATION (EU) 2016/2281. SEER, SCOP = (η<sub>s</sub> + Correction) × PEf. 3) Pipe diameter under 90m for ultimate indoor unit / over 90m for ultimate indoor unit (if the longest piping equivalent length exceeds 90m, increase the sizes of the main tubes by 1 rank for gas tubes and liquid tubes). 4) If the following conditions are satisfied, the effective range is above 130% and below 200%: A. Obey the limited number of connectable indoor units. B. The lower limit of operating range for heating outdoor temperature is limited to -10°C WB (standard -25°C WB). C. Simultaneous operation is limited to less than 130% of connectable indoor units.



## 2-PIPE ECOi EX ME2 SERIES HIGH EFFICIENCY MODEL COMBINATION FROM 18 TO 64HP

### Combination from 18 to 28HP

			18HP	20HP	22HP	24HP	26HP	28HP
Model name			U-8ME2E8 U-10ME2E8	U-10ME2E8 U-10ME2E8	U-10ME2E8 U-12ME2E8	U-12ME2E8 U-12ME2E8	U-10ME2E8 U-16ME2E8	U-12ME2E8 U-16ME2E8
Power supply	Voltage	V	380/400/415	380/400/415	380/400/415	380/400/415	380/400/415	380/400/415
	Phase		Three Phase	Three Phase	Three Phase	Three Phase	Three Phase	Three Phase
	Frequency	Hz	50	50	50	50	50	50
Cooling capacity		kW	50,00	56,00	61,50	68,00	73,00	78,50
EER <sup>1)</sup>		W/W	4,55	4,38	4,13	3,93	3,80	3,69
Running current cooling		A	17,30/16,60	20,30/19,60	23,10/22,30	26,60/25,60	30,10/29,00	33,10/31,90
Input power cooling		kW	11,00	12,80	14,90	17,30	19,20	21,30
Heating capacity		kW	56,00	63,00	69,00	76,50	81,50	87,50
COP <sup>1)</sup>		W/W	4,96	4,77	4,76	4,69	4,55	4,56
Running current heating		A	17,70/17,10	20,90/20,20	22,70/21,90	25,30/24,40	28,40/27,40	30,10/29,00
Input power heating		kW	11,30	13,20	14,50	16,30	17,90	19,20
Starting current		A	2,00	2,00	2,00	2,00	3,00	3,00
External static pressure [Max]		Pa	80	80	80	80	80	80
Air volume		m <sup>3</sup> /min	448	448	456	464	456	464
Sound pressure	Normal / Silent mode	dB(A)	58,50/55,50	59,00/56,00	61,00/58,00	62,00/59,00	62,50/59,50	63,50/60,50
Sound power	Normal mode	dB	79,50	80,00	82,00	83,00	83,50	84,50
Dimension / Net weight	H x W x D	mm / kg	1842 x 1600 x 1000 / 420	1842 x 1600 x 1000 / 420	1842 x 2010 x 1000 / 480	1842 x 2420 x 1000 / 540	1842 x 2010 x 1000 / 535	1842 x 2420 x 1000 / 585
Piping connections <sup>2)</sup>	Liquid pipe	Inch (mm)	5/8(15,88)/ 3/4(19,05)	5/8(15,88)/ 3/4(19,05)	5/8(15,88)/ 3/4(19,05)	5/8(15,88)/ 3/4(19,05)	3/4(19,05)/ 7/8(22,22)	3/4(19,05)/ 7/8(22,22)
	Gas pipe	Inch (mm)	1-1/8(28,58)/ 1-1/4(31,75)	1-1/8(28,58)/ 1-1/4(31,75)	1-1/8(28,58)/ 1-1/4(31,75)	1-1/8(28,58)/ 1-1/4(31,75)	1-1/4(31,75)/ 1-1/2(38,10)	1-1/4(31,75)/ 1-1/2(38,10)
	Balance pipe	Inch (mm)	1/4(6,35)	1/4(6,35)	1/4(6,35)	1/4(6,35)	1/4(6,35)	1/4(6,35)
Refrigerant (R410A)		kg/TCO <sub>2</sub> Eq.	11,20/23,3856	11,20/23,3856	13,90/29,0232	16,60/34,6608	13,90/29,0232	16,60/34,6608
Maximum allowable indoor / outdoor capacity ratio % <sup>3)</sup>			50 ~ 130(200)	50 ~ 130(200)	50 ~ 130(200)	50 ~ 130(200)	50 ~ 130(200)	50 ~ 130(200)
Operating range	Cool / Heat Min ~ Max	°C	-10 ~ +52 / -25 ~ +18	-10 ~ +52 / -25 ~ +18	-10 ~ +52 / -25 ~ +18	-10 ~ +52 / -25 ~ +18	-10 ~ +52 / -25 ~ +18	-10 ~ +52 / -25 ~ +18

### Combination from 30 to 40HP

			30HP	32HP	34HP	36HP	38HP	40HP
Model name			U-14ME2E8 U-16ME2E8	U-16ME2E8 U-16ME2E8	U-10ME2E8 U-12ME2E8 U-12ME2E8	U-12ME2E8 U-12ME2E8 U-12ME2E8	U-10ME2E8 U-12ME2E8 U-16ME2E8	U-12ME2E8 U-12ME2E8 U-16ME2E8
Power supply	Voltage	V	380/400/415	380/400/415	380/400/415	380/400/415	380/400/415	380/400/415
	Phase		Three Phase	Three Phase	Three Phase	Three Phase	Three Phase	Three Phase
	Frequency	Hz	50	50	50	50	50	50
Cooling capacity		kW	85,00	90,00	96,00	101,00	107,00	113,00
EER <sup>1)</sup>		W/W	3,68	3,52	4,05	3,95	3,84	3,75
Running current cooling		A	36,60/35,30	40,20/38,70	36,80/35,50	39,30/37,90	43,80/42,20	46,70/45,00
Input power cooling		kW	23,10	25,60	23,70	25,60	27,90	30,10
Heating capacity		kW	95,00	100,00	108,00	113,00	119,00	127,00
COP <sup>1)</sup>		W/W	4,48	4,42	4,72	4,73	4,61	4,57
Running current heating		A	33,60/32,40	35,80/34,60	35,90/34,60	37,10/35,80	40,50/39,00	43,60/42,00
Input power heating		kW	21,20	22,60	22,90	23,90	25,80	27,80
Starting current		A	4,00	4,00	3,00	3,00	4,00	4,00
External static pressure [Max]		Pa	80	80	80	80	80	80
Air volume		m <sup>3</sup> /min	464	464	688	696	688	696
Sound pressure	Normal / Silent mode	dB(A)	63,50/60,50	64,00/61,00	63,00/60,00	64,00/61,00	64,00/61,00	64,50/61,50
Sound power	Normal mode	dB	84,50	85,00	84,00	85,00	85,00	85,50
Dimension / Net weight	H x W x D	mm / kg	1842 x 2420 x 1000 / 630	1842 x 2420 x 1000 / 630	1842 x 3250 x 1000 / 750	1842 x 3660 x 1000 / 810	1842 x 3250 x 1000 / 795	1842 x 3660 x 1000 / 855
Piping connections <sup>2)</sup>	Liquid pipe	Inch (mm)	3/4(19,05)/ 7/8(22,22)	3/4(19,05)/ 7/8(22,22)	3/4(19,05)/ 7/8(22,22)	3/4(19,05)/ 7/8(22,22)	3/4(19,05)/ 7/8(22,22)	3/4(19,05)/ 7/8(22,22)
	Gas pipe	Inch (mm)	1-1/4(31,75)/ 1-1/2(38,10)	1-1/4(31,75)/ 1-1/2(38,10)	1-1/4(31,75)/ 1-1/2(38,10)	1-1/2(38,10)/ 1-5/8(41,28)	1-1/2(38,10)/ 1-5/8(41,28)	1-1/2(38,10)/ 1-5/8(41,28)
	Balance pipe	Inch (mm)	1/4(6,35)	1/4(6,35)	1/4(6,35)	1/4(6,35)	1/4(6,35)	1/4(6,35)
Refrigerant (R410A)		kg/TCO <sub>2</sub> Eq.	16,60/34,6608	16,60/34,6608	22,20/46,3536	24,90/51,9912	22,20/46,3536	24,90/46,3536
Maximum allowable indoor / outdoor capacity ratio % <sup>3)</sup>			50 ~ 130(200)	50 ~ 130(200)	50 ~ 130(200)	50 ~ 130(200)	50 ~ 130(200)	50 ~ 130(200)
Operating range	Cool / Heat Min ~ Max	°C	-10 ~ +52 / -25 ~ +18	-10 ~ +52 / -25 ~ +18	-10 ~ +52 / -25 ~ +18	-10 ~ +52 / -25 ~ +18	-10 ~ +52 / -25 ~ +18	-10 ~ +52 / -25 ~ +18

Data is for reference. 1) EER and COP calculation is based in accordance to EN14511. 2) Pipe diameter under 90m for ultimate indoor unit / over 90m for ultimate indoor unit (if the longest piping equivalent length exceeds 90m, increase the sizes of the main tubes by 1 rank for gas tubes and liquid tubes). 3) If the following conditions are satisfied, the effective range is above 130% and below 200%: A. Obey the limited number of connectable indoor units. B. The lower limit of operating range for heating outdoor temperature is limited to -10°C WB (standard -25°C WB). C. Simultaneous operation is limited to less than 130% of connectable indoor units.



### Combination from 42 to 52HP

			42HP	44HP	46HP	48HP	50HP	52HP
Model name			U-10ME2E8 U-16ME2E8 U-16ME2E8	U-12ME2E8 U-16ME2E8 U-16ME2E8	U-14ME2E8 U-16ME2E8 U-16ME2E8	U-16ME2E8 U-16ME2E8 U-16ME2E8	U-10ME2E8 U-12ME2E8 U-16ME2E8	U-12ME2E8 U-12ME2E8 U-16ME2E8
Power supply	Voltage	V	380/400/415	380/400/415	380/400/415	380/400/415	380/400/415	380/400/415
	Phase		Three Phase	Three Phase	Three Phase	Three Phase	Three Phase	Three Phase
	Frequency	Hz	50	50	50	50	50	50
Cooling capacity		kW	118,00	124,00	130,00	135,00	140,00	145,00
EER <sup>1)</sup>		W/W	3,69	3,62	3,62	3,52	3,87	3,82
Running current cooling		A	50,20/48,40	53,20/51,30	56,90/54,90	60,20/58,10	56,20/54,20	59,00/56,80
Input power cooling		kW	32,00	34,30	35,90	38,40	36,20	38,00
Heating capacity		kW	132,00	138,00	145,00	150,00	155,00	160,00
COP <sup>1)</sup>		W/W	4,49	4,50	4,46	4,42	4,65	4,66
Running current heating		A	46,60/44,90	48,20/46,40	51,50/49,70	53,80/51,80	52,20/50,40	53,80/51,90
Input power heating		kW	29,40	30,70	32,50	33,90	33,30	34,30
Starting current		A	5,00	5,00	6,00	6,00	5,00	5,00
External static pressure (Max)		Pa	80	80	80	80	80	80
Air volume		m <sup>3</sup> /min	688	696	696	696	920	928
Sound pressure	Normal / Silent mode	dB(A)	65,00/62,00	65,50/62,50	65,50/62,50	66,00/63,00	65,50/62,50	66,00/63,00
Sound power	Normal mode	dB	86,00	86,50	86,50	87,00	86,50	87,00
Dimension / Net weight	H x W x D	mm / kg	1842 x 3250 x 1000/840	1842 x 3660 x 1000/900	1842 x 3660 x 1000/945	1842 x 3660 x 1000/945	1842 x 4490 x 1000/1065	1842 x 4900 x 1000/1125
Piping connections <sup>2)</sup>	Liquid pipe	Inch (mm)	3/4(19,05)/ 7/8(22,22)	3/4(19,05)/ 7/8(22,22)	3/4(19,05)/ 7/8(22,22)	3/4(19,05)/ 7/8(22,22)	3/4(19,05)/ 7/8(22,22)	3/4(19,05)/ 7/8(22,22)
	Gas pipe	Inch (mm)	1-1/2(38,10)/ 1-5/8(41,28)	1-1/2(38,10)/ 1-5/8(41,28)	1-1/2(38,10)/ 1-5/8(41,28)	1-1/2(38,10)/ 1-5/8(41,28)	1-1/2(38,10)/ 1-5/8(41,28)	1-1/2(38,10)/ 1-5/8(41,28)
	Balance pipe	Inch (mm)	1/4(6,35)	1/4(6,35)	1/4(6,35)	1/4(6,35)	1/4(6,35)	1/4(6,35)
Refrigerant (R410A)		kg/TCO <sub>2</sub> Eq.	22,20/51,9912	24,90/51,9912	24,90/51,9912	24,90/51,9912	30,50/63,6840	33,20/69,3216
Maximum allowable indoor / outdoor capacity ratio % <sup>3)</sup>			50 ~ 130(200)	50 ~ 130(200)	50 ~ 130(200)	50 ~ 130(200)	50 ~ 130(200)	50 ~ 130(200)
Operating range	Cool / Heat Min - Max	°C	-10 ~ +52/-25 ~ +18	-10 ~ +52/-25 ~ +18	-10 ~ +52/-25 ~ +18	-10 ~ +52/-25 ~ +18	-10 ~ +52/-25 ~ +18	-10 ~ +52/-25 ~ +18

### Combination from 54 to 64HP

			54HP	56HP	58HP	60HP	62HP	64HP
Model name			U-10ME2E8 U-12ME2E8 U-16ME2E8 U-16ME2E8	U-12ME2E8 U-16ME2E8 U-16ME2E8	U-10ME2E8 U-16ME2E8 U-16ME2E8	U-12ME2E8 U-16ME2E8 U-16ME2E8	U-14ME2E8 U-16ME2E8 U-16ME2E8	U-16ME2E8 U-16ME2E8 U-16ME2E8
Power supply	Voltage	V	380/400/415	380/400/415	380/400/415	380/400/415	380/400/415	380/400/415
	Phase		Three Phase	Three Phase	Three Phase	Three Phase	Three Phase	Three Phase
	Frequency	Hz	50	50	50	50	50	50
Cooling capacity		kW	151,00	156,00	162,00	168,00	174,00	180,00
EER <sup>1)</sup>		W/W	3,75	3,71	3,65	3,60	3,60	3,52
Running current cooling		A	63,20/60,90	65,30/63,00	69,70/67,10	73,30/70,60	75,80/73,00	80,30/77,40
Input power cooling		kW	40,30	42,10	44,40	46,70	48,30	51,20
Heating capacity		kW	169,00	175,00	182,00	189,00	195,00	201,00
COP <sup>1)</sup>		W/W	4,56	4,56	4,47	4,47	4,45	4,42
Running current heating		A	58,80/56,70	60,20/58,10	64,60/62,20	67,10/64,70	69,50/67,00	72,20/69,60
Input power heating		kW	37,10	38,40	40,70	42,30	43,80	45,50
Starting current		A	6,00	6,00	7,00	7,00	8,00	8,00
External static pressure (Max)		Pa	80	80	80	80	80	80
Air volume		m <sup>3</sup> /min	920	928	920	928	928	928
Sound pressure	Normal / Silent mode	dB(A)	66,00/63,00	66,50/63,50	66,50/63,50	67,00/64,00	67,00/64,00	67,00/64,00
Sound power	Normal mode	dB	87,00	87,50	87,50	88,00	88,00	88,00
Dimension / Net weight	H x W x D	mm / kg	1842 x 4490 x 1000/1110	1842 x 4900 x 1000/1170	1842 x 4490 x 1000/1155	1842 x 4900 x 1000/1215	1842 x 4900 x 1000/1260	1842 x 4900 x 1000/1260
Piping connections <sup>2)</sup>	Liquid pipe	Inch (mm)	3/4(19,05)/ 7/8(22,22)	3/4(19,05)/ 7/8(22,22)	3/4(19,05)/ 7/8(22,22)	3/4(19,05)/ 7/8(22,22)	3/4(19,05)/ 7/8(22,22)	3/4(19,05)/ 7/8(22,22)
	Gas pipe	Inch (mm)	1-1/2(38,10)/ 1-5/8(41,28)	1-1/2(38,10)/ 1-5/8(41,28)	1-1/2(38,10)/ 1-5/8(41,28)	1-1/2(38,10)/ 1-5/8(41,28)	1-5/8(41,28)/ 1-3/4(44,45)	1-5/8(41,28)/ 1-3/4(44,45)
	Balance pipe	Inch (mm)	1/4(6,35)	1/4(6,35)	1/4(6,35)	1/4(6,35)	1/4(6,35)	1/4(6,35)
Refrigerant (R410A)		kg/TCO <sub>2</sub> Eq.	30,50/63,6840	33,20/69,3216	30,50/63,6840	33,20/69,3216	33,20/69,3216	33,20/69,3216
Maximum allowable indoor / outdoor capacity ratio % <sup>3)</sup>			50 ~ 130(200)	50 ~ 130(200)	50 ~ 130(200)	50 ~ 130(200)	50 ~ 130(200)	50 ~ 130(200)
Operating range	Cool / Heat Min - Max	°C	-10 ~ +52/-25 ~ +18	-10 ~ +52/-25 ~ +18	-10 ~ +52/-25 ~ +18	-10 ~ +52/-25 ~ +18	-10 ~ +52/-25 ~ +18	-10 ~ +52/-25 ~ +18

Data is for reference. 1) EER and COP calculation is based in accordance to EN14511. 2) Pipe diameter under 90m for ultimate indoor unit / over 90m for ultimate indoor unit (if the longest piping equivalent length exceeds 90m, increase the sizes of the main tubes by 1 rank for gas tubes and liquid tubes). 3) If the following conditions are satisfied, the effective range is above 130% and below 200%: A. Obey the limited number of connectable indoor units. B. The lower limit of operating range for heating outdoor temperature is limited to -10°C WB (standard -25°C WB). C. Simultaneous operation is limited to less than 130% of connectable indoor units.

## 2-PIPE ECOi EX ME2 SERIES SPACE SAVING MODEL COMBINATION FROM 22 TO 80HP

### Combination from 22 to 34HP

			22HP	24HP	26HP	28HP	30HP	32HP	34HP
Model name			U-10ME2E8 U-12ME2E8	U-12ME2E8 U-12ME2E8	U-10ME2E8 U-16ME2E8	U-12ME2E8 U-16ME2E8	U-14ME2E8 U-16ME2E8	U-16ME2E8 U-16ME2E8	U-14ME2E8 U-20ME2E8
Power supply	Voltage	V	380/400/415	380/400/415	380/400/415	380/400/415	380/400/415	380/400/415	380/400/415
	Phase		Three Phase	Three Phase	Three Phase	Three Phase	Three Phase	Three Phase	Three Phase
	Frequency	Hz	50	50	50	50	50	50	50
Cooling capacity		kW	61,50	68,00	73,00	78,50	85,00	90,00	96,00
EER <sup>1)</sup>		W/W	4,13	3,93	3,80	3,69	3,68	3,52	3,56
Running current cooling		A	23,10/22,30	26,60/25,60	30,10/29,00	33,10/31,90	36,60/35,30	40,20/38,70	41,90/40,40
Input power cooling		kW	14,90	17,30	19,20	21,30	23,10	25,60	27,00
Heating capacity		kW	69,00	76,50	81,50	87,50	95,00	100,00	108,00
COP <sup>1)</sup>		W/W	4,76	4,69	4,55	4,56	4,48	4,42	4,17
Running current heating		A	22,70/21,90	25,30/24,40	28,40/27,40	30,10/29,00	33,60/32,40	35,80/34,60	40,60/39,20
Input power heating		kW	14,50	16,30	17,90	19,20	21,20	22,60	25,90
Starting current		A	2,00	2,00	3,00	3,00	4,00	4,00	4,00
External static pressure [Max]		Pa	80	80	80	80	80	80	80
Air volume		m <sup>3</sup> /min	456	464	456	464	464	464	637
Sound pressure	Normal / Silent mode	dB(A)	61,00/58,00	62,00/59,00	62,50/59,50	63,50/60,50	63,50/60,50	64,00/61,00	63,00/60,00
Sound power	Normal mode	dB	82,00	83,00	83,50	84,50	84,50	85,00	84,00
Dimension / Net weight	H x W x D	mm / kg	1842 x 2010 x 1000/480	1842 x 2420 x 1000/540	1842 x 2010 x 1000/525	1842 x 2420 x 1000/585	1842 x 2420 x 1000/630	1842 x 2420 x 1000/630	1842 x 2780 x 1000/690
Piping connections <sup>2)</sup>	Liquid pipe	Inch (mm)	5/8(15,88)/ 3/4(19,05)	5/8(15,88)/ 3/4(19,05)	3/4(19,05)/ 7/8(22,22)	3/4(19,05)/ 7/8(22,22)	3/4(19,05)/ 7/8(22,22)	3/4(19,05)/ 7/8(22,22)	3/4(19,05)/ 7/8(22,22)
	Gas pipe	Inch (mm)	1-1/8(28,58)/ 1-1/4(31,75)	1-1/8(28,58)/ 1-1/4(31,75)	1-1/4(31,75)/ 1-1/2(38,10)	1-1/4(31,75)/ 1-1/2(38,10)	1-1/4(31,75)/ 1-1/2(38,10)	1-1/4(31,75)/ 1-1/2(38,10)	1-1/4(31,75)/ 1-1/2(38,10)
	Balance pipe	Inch (mm)	1/4(6,35)	1/4(6,35)	1/4(6,35)	1/4(6,35)	1/4(6,35)	1/4(6,35)	1/4(6,35)
Refrigerant (R410A)		kg/TCO <sub>2</sub> Eq.	13,90/23,3856	16,60/34,6608	13,90/29,0232	16,60/34,6608	16,60/34,6608	16,60/34,6608	17,80/37,1664
Maximum allowable indoor / outdoor capacity ratio % <sup>3)</sup>			50 ~ 130(200)	50 ~ 130(200)	50 ~ 130(200)	50 ~ 130(200)	50 ~ 130(200)	50 ~ 130(200)	50 ~ 130(200)
Operating range	Cool Min ~ Max	°C	-10 ~ +52	-10 ~ +52	-10 ~ +52	-10 ~ +52	-10 ~ +52	-10 ~ +52	-10 ~ +52
	Heat Min ~ Max	°C	-25 ~ +18	-25 ~ +18	-25 ~ +18	-25 ~ +18	-25 ~ +18	-25 ~ +18	-25 ~ +18

### Combination from 36 to 48HP

			36HP	38HP	40HP	42HP	44HP	46HP	48HP
Model name			U-16ME2E8 U-20ME2E8	U-18ME2E8 U-20ME2E8	U-20ME2E8 U-20ME2E8	U-10ME2E8 U-16ME2E8 U-16ME2E8	U-12ME2E8 U-16ME2E8 U-16ME2E8	U-14ME2E8 U-16ME2E8 U-16ME2E8	U-16ME2E8 U-16ME2E8
Power supply	Voltage	V	380/400/415	380/400/415	380/400/415	380/400/415	380/400/415	380/400/415	380/400/415
	Phase		Three Phase	Three Phase	Three Phase	Three Phase	Three Phase	Three Phase	Three Phase
	Frequency	Hz	50	50	50	50	50	50	50
Cooling capacity		kW	101,00	107,00	113,00	118,00	124,00	130,00	135,00
EER <sup>1)</sup>		W/W	3,42	3,42	3,34	3,69	3,62	3,62	3,52
Running current cooling		A	45,30/43,70	48,10/46,30	51,40/49,50	50,20/48,40	53,20/51,30	56,90/54,90	60,20/58,10
Input power cooling		kW	25,9	31,3	33,8	32,0	34,3	35,9	38,4
Heating capacity		kW	113,00	119,00	127,00	132,00	138,00	145,00	150,00
COP <sup>1)</sup>		W/W	4,14	4,13	3,92	4,49	4,50	4,46	4,42
Running current heating		A	42,40/40,80	44,70/43,10	49,80/48,00	46,60/44,90	48,20/46,40	51,50/49,70	53,80/51,80
Input power heating		kW	27,30	28,80	32,40	29,40	30,70	32,50	33,90
Starting current		A	4,00	4,00	4,00	5,00	5,00	6,00	6,00
External static pressure [Max]		Pa	80	80	80	80	80	80	80
Air volume		m <sup>3</sup> /min	637	810	810	688	696	696	696
Sound pressure	Normal / Silent mode	dB(A)	63,50/60,50	62,50/59,50	63,00/60,00	65,00/62,00	65,50/62,50	65,50/62,50	66,00/63,00
Sound power	Normal mode	dB	84,50	83,50	84,00	86,00	86,50	86,50	87,00
Dimension / Net weight	H x W x D	mm / kg	1842 x 2780 x 1000/690	1842 x 3140 x 1000/750	1842 x 3140 x 1000/750	1842 x 3250 x 1000/840	1842 x 3660 x 1000/900	1842 x 3660 x 1000/945	1842 x 3660 x 1000/945
Piping connections <sup>2)</sup>	Liquid pipe	Inch (mm)	3/4(19,05)/ 7/8(22,22)	3/4(19,05)/ 7/8(22,22)	3/4(19,05)/ 7/8(22,22)	3/4(19,05)/ 7/8(22,22)	3/4(19,05)/ 7/8(22,22)	3/4(19,05)/ 7/8(22,22)	3/4(19,05)/ 7/8(22,22)
	Gas pipe	Inch (mm)	1-1/2(38,10)/ 1-5/8(41,28)	1-1/2(38,10)/ 1-5/8(41,28)	1-1/2(38,10)/ 1-5/8(41,28)	1-1/2(38,10)/ 1-5/8(41,28)	1-1/2(38,10)/ 1-5/8(41,28)	1-1/2(38,10)/ 1-5/8(41,28)	1-1/2(38,10)/ 1-5/8(41,28)
	Balance pipe	Inch (mm)	1/4(6,35)	1/4(6,35)	1/4(6,35)	1/4(6,35)	1/4(6,35)	1/4(6,35)	1/4(6,35)
Refrigerant (R410A)		kg/TCO <sub>2</sub> Eq.	17,80/37,1664	19,00/39,672	19,00/39,672	22,20/46,3536	24,90/51,9912	24,90/51,9912	24,90/51,9912
Maximum allowable indoor / outdoor capacity ratio % <sup>3)</sup>			50 ~ 130(200)	50 ~ 130(200)	50 ~ 130(200)	50 ~ 130(200)	50 ~ 130(200)	50 ~ 130(200)	50 ~ 130(200)
Operating range	Cool Min ~ Max	°C	-10 ~ +52	-10 ~ +52	-10 ~ +52	-10 ~ +52	-10 ~ +52	-10 ~ +52	-10 ~ +52
	Heat Min ~ Max	°C	-25 ~ +18	-25 ~ +18	-25 ~ +18	-25 ~ +18	-25 ~ +18	-25 ~ +18	-25 ~ +18

1) EER and COP calculation is based in accordance to EN14511. 2) Pipe diameter under 90m for ultimate indoor unit / over 90m for ultimate indoor unit (if the longest piping equivalent length exceeds 90m, increase the sizes of the main tubes by 1 rank for gas tubes and liquid tubes). 3) If the following conditions are satisfied, the effective range is above 130% and below 200%: A. Obey the limited number of connectable indoor units. B. The lower limit of operating range for heating outdoor temperature is limited to -10°C WB (standard -25°C WB). C. Simultaneous operation is limited to less than 130% of connectable indoor units.



**Combination from 50 to 64HP**

			50HP	52HP	54HP	56HP	58HP	60HP	62HP	64HP
Model name			U-14ME2E8 U-16ME2E8 U-20ME2E8	U-16ME2E8 U-16ME2E8 U-20ME2E8	U-14ME2E8 U-20ME2E8 U-20ME2E8	U-16ME2E8 U-20ME2E8 U-20ME2E8	U-18ME2E8 U-20ME2E8 U-20ME2E8	U-20ME2E8 U-20ME2E8 U-20ME2E8	U-14ME2E8 U-16ME2E8 U-16ME2E8	U-16ME2E8 U-16ME2E8 U-16ME2E8
Power supply	Voltage	V	380/400/415	380/400/415	380/400/415	380/400/415	380/400/415	380/400/415	380/400/415	380/400/415
	Phase		Three Phase	Three Phase	Three Phase	Three Phase	Three Phase	Three Phase	Three Phase	Three Phase
	Frequency	Hz	50	50	50	50	50	50	50	50
Cooling capacity		kW	140,00	145,00	151,00	156,00	162,00	168,00	174,00	180,00
EER <sup>1)</sup>		W/W	3,55	3,46	3,49	3,41	3,40	3,35	3,60	3,52
Running current cooling		A	61,10/58,90	65,00/62,70	66,50/64,10	70,30/67,80	73,10/70,40	76,10/73,40	75,80/73,00	80,30/77,40
Input power cooling		kW	39,40	41,90	43,30	45,80	47,60	50,10	48,30	51,20
Heating capacity		kW	155,00	160,00	169,00	175,00	182,00	189,00	195,00	201,00
COP <sup>1)</sup>		W/W	4,29	4,27	4,11	4,08	4,06	3,94	4,45	4,42
Running current heating		A	56,60/54,60	58,80/56,70	63,80/61,50	66,60/64,20	69,50/67,00	73,70/71,00	69,50/67,00	72,20/69,60
Input power heating		kW	36,10	37,50	41,10	42,90	44,80	48,00	43,80	45,50
Starting current		A	6,00	6,00	6,00	6,00	6,00	6,00	8,00	8,00
External static pressure (Max)		Pa	80	80	80	80	80	80	80	80
Air volume		m <sup>3</sup> /min	869	869	1042	1042	1215	1215	928	928
Sound pressure	Normal / Silent mode	dB(A)	65,50/62,50	65,50/62,50	65,00/62,00	65,50/62,50	64,50/61,50	65,00/62,00	67,00/64,00	67,00/64,00
Sound power	Normal mode	dB	86,50	86,50	86,00	86,50	85,50	86,00	88,00	88,00
Dimension / Net weight	HxWxD	mm / kg	1842x4020 x1000/1005	1842x4020 x1000/1005	1842x4380 x1000/1065	1842x4380 x1000/1065	1842x4740 x1000/1125	1842x4740 x1000/1125	1842x4900 x1000/1260	1842x4900 x1000/1260
Piping connections <sup>2)</sup>	Liquid pipe	Inch (mm)	3/4(19,05)/ 7/8(22,22)	3/4(19,05)/ 7/8(22,22)	3/4(19,05)/ 7/8(22,22)	3/4(19,05)/ 7/8(22,22)	3/4(19,05)/ 7/8(22,22)	3/4(19,05)/ 7/8(22,22)	3/4(19,05)/ 7/8(22,22)	3/4(19,05)/ 7/8(22,22)
	Gas pipe	Inch (mm)	1-1/2(38,10)/ 1-5/8(41,28)	1-1/2(38,10)/ 1-5/8(41,28)	1-1/2(38,10)/ 1-5/8(41,28)	1-1/2(38,10)/ 1-5/8(41,28)	1-1/2(38,10)/ 1-5/8(41,28)	1-1/2(38,10)/ 1-5/8(41,28)	1-5/8(41,28)/ 1-3/4(44,45)	1-5/8(41,28)/ 1-3/4(44,45)
	Balance pipe	Inch (mm)	1/4(6,35)	1/4(6,35)	1/4(6,35)	1/4(6,35)	1/4(6,35)	1/4(6,35)	1/4(6,35)	1/4(6,35)
Refrigerant (R410A)		kg/TCO <sub>2</sub> Eq.	26,10/54,4968	26,10/54,4968	27,30/57,0024	27,30/57,0024	28,50/59,508	28,50/59,508	33,20/69,3216	33,20/69,3216
Maximum allowable indoor / outdoor capacity ratio % <sup>3)</sup>			50 ~ 130(200)	50 ~ 130(200)	50 ~ 130(200)	50 ~ 130(200)	50 ~ 130(200)	50 ~ 130(200)	50 ~ 130(200)	50 ~ 130(200)
Operating range	Cool Min ~ Max	°C	-10 ~ +52	-10 ~ +52	-10 ~ +52	-10 ~ +52	-10 ~ +52	-10 ~ +52	-10 ~ +52	-10 ~ +52
	Heat Min ~ Max	°C	-25 ~ +18	-25 ~ +18	-25 ~ +18	-25 ~ +18	-25 ~ +18	-25 ~ +18	-25 ~ +18	-25 ~ +18

**Combination from 66 to 80HP**

			66HP	68HP	70HP	72HP	74HP	76HP	78HP	80HP
Model name			U-10ME2E8 U-16ME2E8 U-20ME2E8 U-20ME2E8	U-12ME2E8 U-16ME2E8 U-20ME2E8 U-20ME2E8	U-10ME2E8 U-20ME2E8 U-20ME2E8 U-20ME2E8	U-16ME2E8 U-16ME2E8 U-20ME2E8 U-20ME2E8	U-16ME2E8 U-18ME2E8 U-20ME2E8 U-20ME2E8	U-16ME2E8 U-20ME2E8 U-20ME2E8 U-20ME2E8	U-18ME2E8 U-20ME2E8 U-20ME2E8 U-20ME2E8	U-20ME2E8 U-20ME2E8 U-20ME2E8 U-20ME2E8
Power supply	Voltage	V	380/400/415	380/400/415	380/400/415	380/400/415	380/400/415	380/400/415	380/400/415	380/400/415
	Phase		Three Phase	Three Phase	Three Phase	Three Phase	Three Phase	Three Phase	Three Phase	Three Phase
	Frequency	Hz	50	50	50	50	50	50	50	50
Cooling capacity		kW	185,00	190,00	196,00	202,00	208,00	213,00	219,00	224,00
EER <sup>1)</sup>		W/W	3,52	3,49	3,47	3,42	3,42	3,39	3,38	3,35
Running current cooling		A	80,80/77,80	83,70/80,70	86,80/83,60	90,60/87,30	93,40/90,00	96,60/93,10	98,30/94,70	101,50/97,80
Input power cooling		kW	52,60	54,50	56,50	59,00	60,80	62,90	64,70	66,80
Heating capacity		kW	207,00	213,00	219,00	226,00	233,00	239,00	245,00	252,00
COP <sup>1)</sup>		W/W	4,16	4,18	4,05	4,14	4,12	4,03	4,03	3,94
Running current heating		A	77,10/74,30	79,20/76,30	83,10/80,10	84,70/81,70	87,70/84,50	92,00/88,70	93,40/90,00	98,30/94,70
Input power heating		kW	49,70	51,00	54,10	54,60	56,50	59,30	60,80	64,00
Starting current		A	7,00	7,00	7,00	8,00	8,00	8,00	8,00	8,00
External static pressure (Max)		Pa	80	80	80	80	80	80	80	80
Air volume		m <sup>3</sup> /min	1266	1274	1439	1274	1447	1447	1620	1620
Sound pressure	Normal / Silent mode	dB(A)	66,00/63,00	66,50/63,50	65,50/62,50	66,50/63,50	66,50/63,50	66,50/63,50	66,00/63,00	66,00/63,00
Sound power	Normal mode	dB	87,00	87,50	86,50	87,50	87,50	87,50	87,00	87,00
Dimension / Net weight	HxWxD	mm / kg	1842x5210x 1000/1275	1842x5620x 1000/1335	1842x5570x 1000/1335	1842x5620x 1000/1380	1842x5980x 1000/1440	1842x5980x 1000/1440	1842x6340x 1000/1500	1842x6340x 1000/1500
Piping connections <sup>2)</sup>	Liquid pipe	Inch (mm)	3/4(19,05)/ 7/8(22,22)	7/8(22,22)/ 1(25,04)	7/8(22,22)/ 1(25,04)	7/8(22,22)/ 1(25,04)	7/8(22,22)/ 1(25,04)	7/8(22,22)/ 1(25,04)	7/8(22,22)/ 1(25,04)	7/8(22,22)/ 1(25,04)
	Gas pipe	Inch (mm)	1-5/8(41,28)/ 1-3/4(44,45)	1-5/8(41,28)/ 1-3/4(44,45)	1-5/8(41,28)/ 1-3/4(44,45)	1-3/4(44,45)/ 2(50,80)	1-3/4(44,45)/ 2(50,80)	1-3/4(44,45)/ 2(50,80)	1-3/4(44,45)/ 2(50,80)	1-3/4(44,45)/ 2(50,80)
	Balance pipe	Inch (mm)	1/4(6,35)	1/4(6,35)	1/4(6,35)	1/4(6,35)	1/4(6,35)	1/4(6,35)	1/4(6,35)	1/4(6,35)
Refrigerant (R410A)		kg/TCO <sub>2</sub> Eq.	32,90/68,6952	35,60/74,3328	34,10/19,836	35,80/68,6952	36,80/19,836	36,80/76,8384	38,00/79,344	38,00/79,344
Maximum allowable indoor / outdoor capacity ratio % <sup>3)</sup>			50 ~ 130(200)	50 ~ 130(200)	50 ~ 130(200)	50 ~ 130(200)	50 ~ 130(200)	50 ~ 130(200)	50 ~ 130(200)	50 ~ 130(200)
Operating range	Cool Min ~ Max	°C	-10 ~ +52	-10 ~ +52	-10 ~ +52	-10 ~ +52	-10 ~ +52	-10 ~ +52	-10 ~ +52	-10 ~ +52
	Heat Min ~ Max	°C	-25 ~ +18	-25 ~ +18	-25 ~ +18	-25 ~ +18	-25 ~ +18	-25 ~ +18	-25 ~ +18	-25 ~ +18

1) EER and COP calculation is based in accordance to EN14511. 2) Pipe diameter under 90m for ultimate indoor unit / over 90m for ultimate indoor unit (if the longest piping equivalent length exceeds 90m, increase the sizes of the main tubes by 1 rank for gas tubes and liquid tubes). 3) If the following conditions are satisfied, the effective range is above 130% and below 200%: A. Obey the limited number of connectable indoor units. B. The lower limit of operating range for heating outdoor temperature is limited to -10°C WB (standard -25°C WB). C. Simultaneous operation is limited to less than 130% of connectable indoor units.

# NEW 3-PIPE ECOi EX MF3 SERIES

## Simultaneous heating and cooling VRF System

The new Panasonic 3-Pipe ECOi EX MF3 series offers the ideal solution to meet customer's demand.

### Upgraded energy efficiency utilized ECOi EX technology.

- SEER / SCOP improved in full capacities from 8 to 16HP
- SEER / SCOP follows LOT21 from started from January 2018
- EER / COP is certified in Eurovent

### Design flexibility.

- High reliability even under tough temperature condition
- Maximum 52 indoor units connectable
- Slim heat recovery box with just 200 height
- Farthest piping length between indoor units and outdoor units: 200m

### Excellent seasonal energy saving.

SEER / SCOP (W/W)

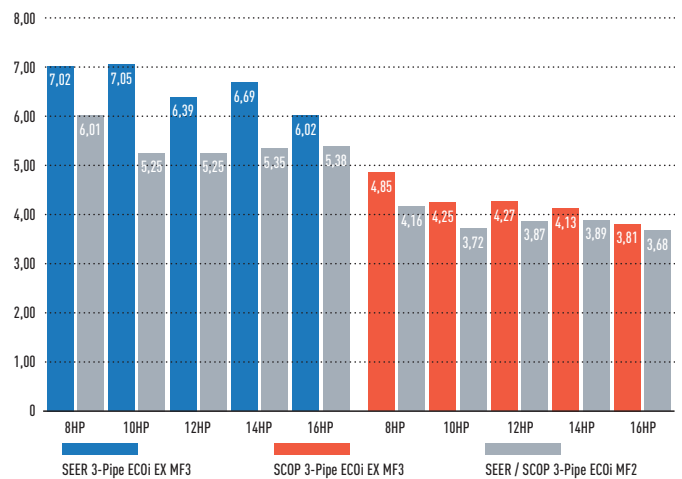

## Extended design operation conditions

Cooling design operation conditions: The cooling operation range has been extended to -10°C ~ 52°C by changing the outdoor fan to an Inverter type. Heating design operation conditions: Stable heating operation even with an outside air temperature of -20°C. The heating operation range has been extended to -20°C by use of a compressor with a high-pressure vessel.

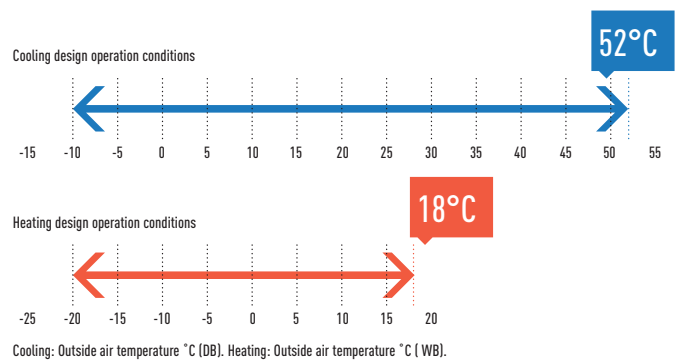

## Wide temperature setting range

Wired remote control heating temperature setting range is 16 to 30°C.

## Increased maximum number of connectable indoor units

Maximum 48HP with 52 indoor units can be set up according to user needs. Connectable indoor/outdoor unit capacity ratio up to 150%.

System ( HP)	8	10	12	14	16	18	20	22	24	26	28	30	32	34	36	38	40	42	44	46	48
Connectable indoor units*: 150 %	19	24	29	34	39	43	48	52				52									

\*Depending on indoor units types. Please check service manuals.

## Power suppression control for energy saving (Demand control)<sup>1</sup>

The 3-Pipe ECOi EX MF3 Series has a built-in demand function which uses the inverter characteristics. With this demand function, the power consumption can be set in three steps, and operation<sup>2</sup> at optimum performance is performed according to the setting and the power consumption. This function is useful to reduce the annual power consumption and to save electricity costs while maintaining comfort.

<sup>1</sup> An outdoor Seri-Para I/O unit is required for demand input.

<sup>2</sup> Setting is possible as 0% or in the range from 40 to 100% (in steps of 5%). At the time of shipping, setting has been done to the three steps of 0%, 70%, and 100%.



Simultaneous heating and cooling VRF system.  
The new 3-Pipe ECOi EX MF3 Series offers the solution for the most demanding customers.



**Slim 3-Pipe Control Box Kit / Multiple connection type**

**New Heat Recovery Box to connect multiple indoor units with just one box, 4, 6 and up to 8 indoor units or groups.**  
The height is only 200mm. This is good advantage specially in hotel applications, where space for connecting several boxes is limited.

**Individual control of multiple indoor units with solenoid valve kits.**

- Any design and layout can be used in a single system.
- Cooling operation is possible up to an outdoor temperature of -10°C.

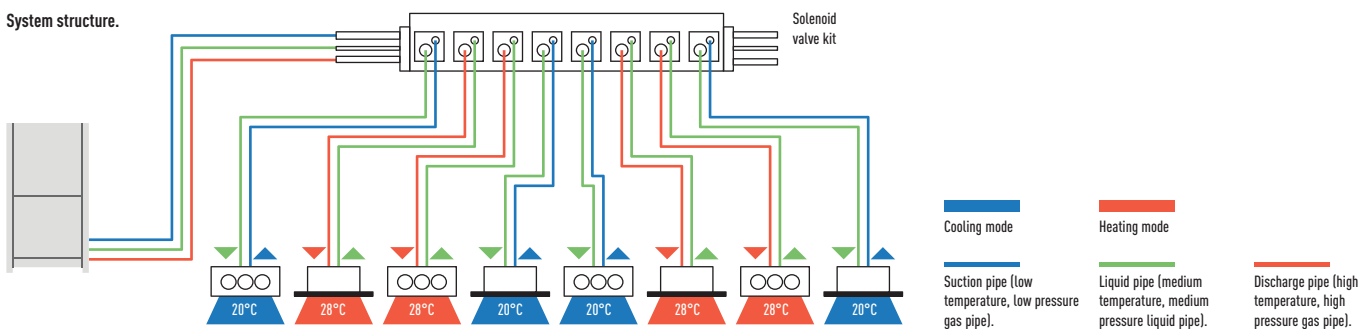

	1 port	4 port	6 port	8 port
56 type	CZ-P56HR3	CZ-P456HR3	CZ-P656HR3	CZ-P856HR3
160 type	CZ-P160HR3	CZ-P4160HR3	—	—

**Solenoid valve kit / wiring work**

**Current model / single connection type**

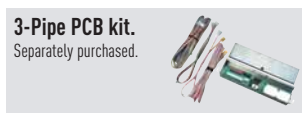
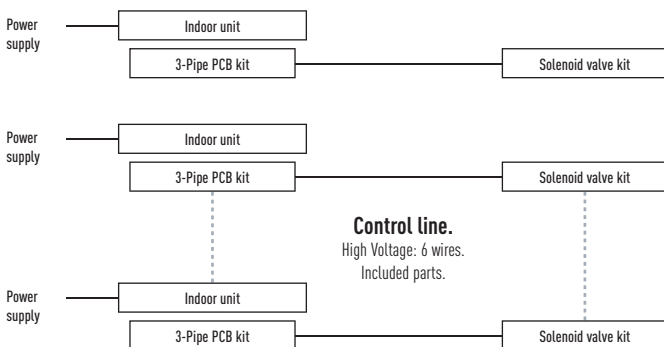

**New model / multiple connection type**

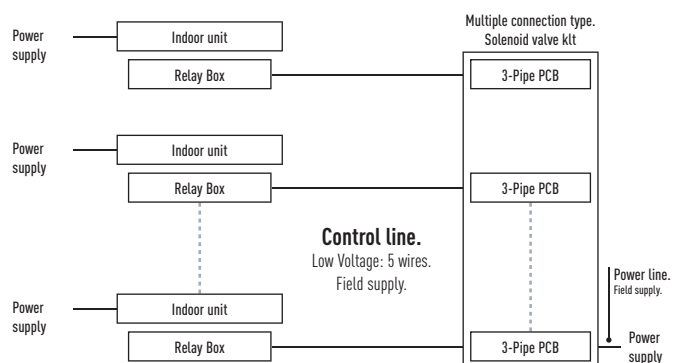

# NEW 3-PIPE ECOi EX MF3 SERIES SUPERIOR FLEXIBILITY

## Increased piping lengths and design flexibility

Adaptable to various building types and sizes. Actual piping length: 200m.  
Maximum piping length: 500m.

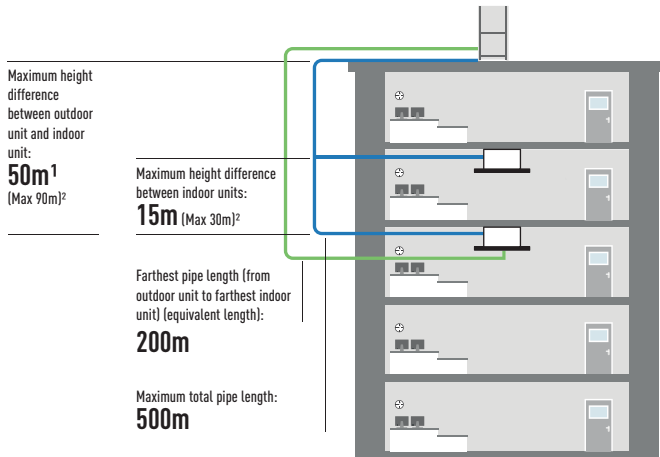

1. 40m if the outdoor unit is below the indoor unit.  
2. Setting change is necessary. Please contact an authorized Panasonic dealer in the case of conditions below:  
50 < Height difference between OU and IU ≤ 90 or 15 < Height difference between IUs ≤ 30.

## Excellent cost saving and smaller piping size

By using R410A with low pressure loss, pipe sizes for discharge, suction and liquid are all reduced. This makes it possible to aim for reduced piping space, improved workability at the site, and reduction of the piping material costs.

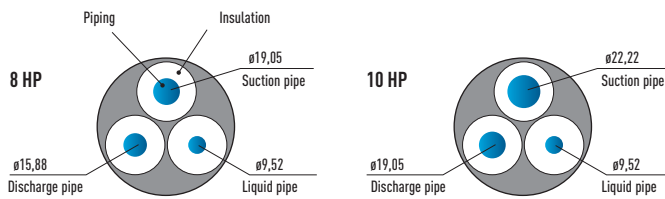

## Up to 40m piping after first branch

Up to 52 units can be connected to one system. Flexible piping layout makes it easier to design systems for locations such as train stations, airports, schools and hospitals.

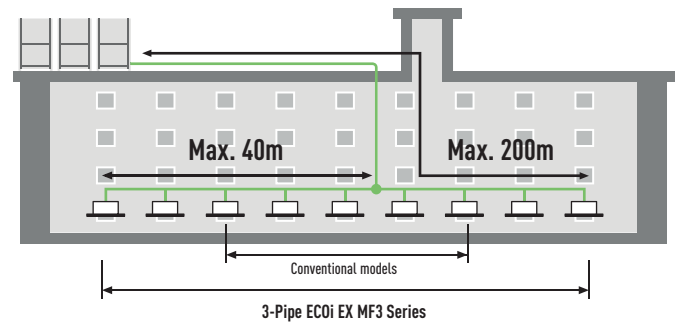

## High external static pressure on condensers

With a newly designed fan, fan guard, motor, and casing, new models can be custom-installed on-site to provide up to 80 Pa of external static pressure. An air discharge duct prevents shortages of air circulation, allowing outdoor units to be installed on every floor of a building.

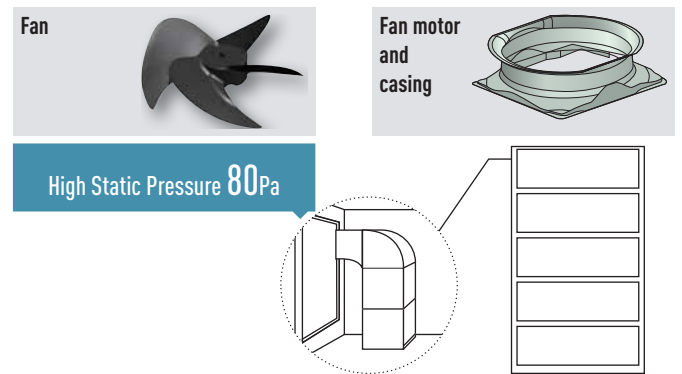

# NEW 3-PIPE ECOi EX MF3 SERIES PIPING DESIGN

Select the installation location so that the length and size of refrigerant tubing are within the allowable range shown in the figure below.

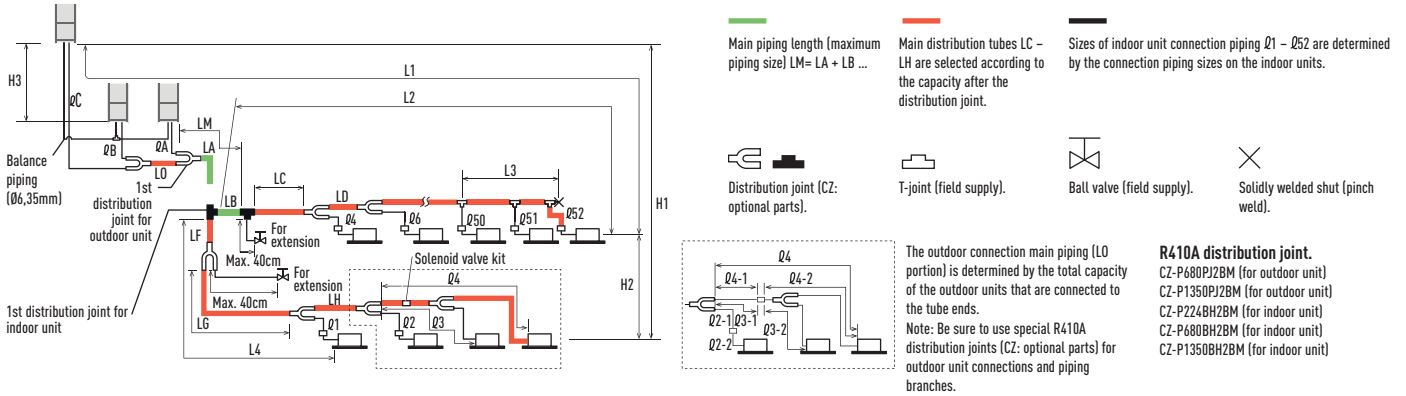

## Ranges that apply to refrigerant piping lengths and to differences in installation heights

Items	Mark	Contents	Length (m)
Allowable piping length	L1	Maximum piping length	Actual length ≤200 <sup>1)</sup> Equivalent length ≤210 <sup>1)</sup>
	Δ L (L2-L4)	Difference between maximum length and minimum length from the 1st distribution joint	≤50 <sup>2)</sup>
	LM	Maximum length of main piping [at maximum size] * Even after 1st distribution joint, LM is allowed if at maximum piping length.	— <sup>3)</sup>
	Ø1, Ø2~ Ø52	Maximum length of each distribution tube	≤50 <sup>4)</sup>
	L1+ Ø1+ Ø2~ Ø51+ ØA+ØB+LF+LG+LH	Total maximum piping length including length of each distribution tube (only liquid piping)	≤500
	ØA, ØB+LO, ØC+LO	Maximum piping length from outdoor's 1st distribution joint to each outdoor unit	≤10
Allowable elevation difference	Ø1-2, Ø2-2 ~ Ø52-2	Maximum length between solenoid valve kit and indoor unit	≤30
	H1	When outdoor unit is installed higher than indoor unit	≤50
	H2	When outdoor unit is installed lower than indoor unit	≤40
Allowable length of joint piping	H3	Maximum difference between outdoor units	≤15 <sup>5)</sup>
	L3	T-joint piping (field-supply); Maximum piping length between the first T-joint and solidly welded-shut end point	≤2

L = Length, H = Height

1) If the longest piping length (L1) exceeds 90m (equivalent length), increase the sizes of the main pipes (LM) by 1 rank for suction pipes, discharge pipes and liquid pipes. Use a field supply reducer. Select the pipe size from the table of main piping sizes (Table 3) and from the table of refrigerant piping sizes (Table 8). 2) If the longest main piping length (LM) exceeds 50m, increase the main piping size at the portion before 50 m by 1 rank for the suction pipes and discharge pipes. Use a field supply reducer. Determine the length less than the limitation of allowable maximum piping length. For the portion that exceeds 50m, set based on the main piping size (LA) listed in Table 3. 3) If the piping length marked "L" (L2-L4) exceeds 40m, increase the piping size at the portion after the 1st distribution joint by 1 rank for the liquid pipe, suction pipe and discharge pipe. Refer to the Technical Data for the details. 4) If any of the piping length exceeds 30m, increase the size of the suction pipes, discharge pipes and liquid pipes by 1rank.

\* The outdoor connection main piping (LO portion) is determined by the total capacity of the outdoor units that are connected to the pipe ends.

## System limitations.

Maximum number allowable connected outdoor units	3
Maximum capacity allowable connected outdoor units	135kW (48HP)
Maximum connectable indoor units	52
Maximum allowable indoor / outdoor capacity ratio	50-150%

1) In the case of 24 HP (type 68kW) or smaller units, the number is limited by the total capacity of the connected indoor units.

2) Up to 3 units can be connected if the system has been extended.

3) It is strongly recommended that you choose the unit so the load can become between 50 and 130%.

## Additional refrigerant charge.

Liquid piping size Inch (mm)	Amount of refrigerant charge/m (g/m)
1/4 (6,35)	26
3/8 (9,52)	56
1/2 (12,70)	128
5/8 (15,88)	185
3/4 (19,05)	259
7/8 (22,22)	366

## Necessary amount of additional refrigerant charge per meter, according to discharge piping size.

Discharge piping size	Inch (mm)	1/2 (12,70)	5/8 (15,88)	3/4 (19,05)	7/8 (22,22)	1 (25,40)	1-1/8 (28,58)	1-1/4 (31,75)	1-1/2 (38,10)
Additional amount	g/m	12	21	31	41	55	71	89	126

## Refrigerant piping.

Piping size Inch (mm)	Material Temper - 0	Material Temper - 1/2 H, H
1/4 (6,35)	t 0,8	7/8 (22,22) t 1,0
3/8 (9,52)	t 0,8	1 (25,40) t 1,0
1/2 (12,70)	t 0,8	1-1/8 (28,58) t 1,0
5/8 (15,88)	t 1,0	1-1/4 (31,75) t 1,1
3/4 (19,05)	t 1,2	1-1/2 (38,10) t 1,15
		1-1/5 41,28 t 1,20

\* When bending the tubes, use a bending radius that is at least 4 times the outer diameter of the tubes. In addition, take sufficient care to avoid crushing or damaging the tubes when bending them.

# NEW 3-PIPE ECOi EX MF3 SERIES

**4,85**  
SCOP

NEW  
18



## Simultaneous heating and cooling operation with heat recovery type.

New 3-Pipe ECOi EX MF3 Series is one of the most advanced VRF systems. Not only high-efficient performance for simultaneous heating and cooling, but also sophisticated installation and maintenance available.

- Achieving SCOP 4,77 as the top class in the industry (LOT21 Seasonal heating efficiency value for 8HP outdoor unit)
- Simultaneous cooling and heating operation with up to 39 indoor units
- Slim heat recovery boxes with just 200mm height fit with the ceiling space limited in hotel applications
- Rotation operation function and back-up operation function provided

## Technical focus

- High SEER/SCOP at full Load capacity (Follows LOT21)
- EER, COP: Eurovent certified
- Standardisation of outdoor unit to one compact casing size
- The constant-speed compressor adopts a high-performance internal high-pressure scroll
- Up to 52 indoor units connectable
- High external static pressure 80 Pa with a newly designed fan, fan guard, motor, and casing
- Silent outdoor unit operation: Minimum 54dB(A) for 8HP
- Bluefin condenser outdoor unit

			8HP	10HP	12HP	14HP	16HP
Outdoor Units			U-8MF3E8	U-10MF3E8	U-12MF3E8	U-14MF3E8	U-16MF3E8
Power supply	Voltage	V	380/400/415	380/400/415	380/400/415	380/400/415	380/400/415
	Phase		Three Phase	Three Phase	Three Phase	Three Phase	Three Phase
	Frequency	Hz	50	50	50	50	50
Cooling capacity		kW	22,40	28,00	33,50	40,00	45,00
EER <sup>1)</sup>		W/W	5,11	4,72	3,91	3,70	3,49
SEER <sup>2)</sup>		W/W	<b>7,02</b>	<b>7,05</b>	<b>6,39</b>	<b>6,69</b>	<b>6,02</b>
Running current cooling		A	7,16/6,80/6,55	9,90/9,41/9,07	3,19/13,20/12,70	18,20/17,30/16,70	21,30/20,20/19,50
Input power cooling		kW	4,38	5,93	8,57	10,80	12,90
Heating capacity		kW	25,00	31,50	37,50	45,00	50,00
COP <sup>1)</sup>		W/W	5,25	5,17	4,51	4,21	4,17
SCOP <sup>2)</sup>		W/W	<b>4,85</b>	<b>4,25</b>	<b>4,27</b>	<b>4,13</b>	<b>3,81</b>
Running current heating		A	7,78/7,39/7,12	10,20/9,66/9,31	13,40/12,80/12,30	18,10/17,20/16,50	20,00/19,00/18,30
Input power heating		kW	4,76	6,09	8,32	10,70	12,00
Starting current		A	1,00	1,00	1,00	2,00	2,00
External static pressure (Max)		Pa	80	80	80	80	80
Air volume		m/min	210	220	232	232	232
Sound pressure	Normal mode	dB(A)	54,00	57,00	60,00	61,00	62,00
	Silent mode 1 / 2	dB(A)	51,00/49,00	54,00/52,00	57,00/55,00	58,00/56,00	59,00/57,00
Sound power	Normal mode	dB	76,00	78,00	81,00	82,00	82,00
Dimension	H x W x D	mm	1842x1180x1000	1842x1180x1000	1842x1180x1000	1842x1180x1000	1842x1180x1000
Net weight		kg	261	262	286	334	334
Piping connections <sup>3)</sup>	Liquid pipe	Inch (mm)	3/8(9,52)/1/2(12,70)	3/8(9,52)/1/2(12,70)	1/2(12,70)/5/8(15,88)	1/2(12,70)/5/8(15,88)	1/2(12,70)/5/8(15,88)
	Discharge pipe	Inch (mm)	5/8(15,88)/3/4(19,05)	3/4(19,05)/7/8(22,22)	3/4(19,05)/7/8(22,22)	7/8(22,22)/1(25,40)	7/8(22,22)/1(25,40)
	Suction pipe	Inch (mm)	3/4(19,05)/7/8(22,22)	7/8(22,22)/1(25,40)	1(25,40)/1-1/8(28,58)	1(25,40)/1-1/8(28,58)	1-1/8(28,58)/1-1/4(31,75)
	Balance pipe	Inch (mm)	1/4(6,35)	1/4(6,35)	1/4(6,35)	1/4(6,35)	1/4(6,35)
Refrigerant [R410A]		kg/TCO <sub>2</sub> Eq.	6,80/14,1984	6,80/14,1984	8,30/17,3304	8,30/17,3304	8,30/17,3304
Maximum allowable indoor / outdoor capacity ratio %			50 ~ 150	50 ~ 150	50 ~ 150	50 ~ 150	50 ~ 150
Operating range	Cool Min ~ Max	°C	-10 ~ +52	-10 ~ +52	-10 ~ +52	-10 ~ +52	-10 ~ +52
	Heat Min ~ Max	°C	-20 ~ +18	-20 ~ +18	-20 ~ +18	-20 ~ +18	-20 ~ +18
	Simultaneous op.	°C	-10 ~ +24	-10 ~ +24	-10 ~ +24	-10 ~ +24	-10 ~ +24

### Solenoid valve kit

KIT-P56HR3	KIT-P56HR3	3-Pipe control Solenoid valve kit (up to 5,60kW)
	CZ-P56HR3	Solenoid valve kit (up to 5,60kW)
	CZ-CAPE2	3-Pipe control PCB
KIT-P160HR3	KIT-P160HR3	3-Pipe control Solenoid valve kit (from 5,6 to 10,60kW)
	CZ-P160HR3	Solenoid valve kit (up to 16,00kW)
CZ-CAPEK2	CZ-CAPE2	3-Pipe control PCB
		3-Pipe control PCB for wall mounted

### 3-Pipe control box kit

CZ-P456HR3	4 ports 3 pipe box (up to 5,60kW)
CZ-P656HR3	6 ports 3 pipe box (up to 5,60kW)
CZ-P856HR3	8 ports 3 pipe box (up to 5,60kW)
CZ-P4160HR3	4 ports 3 pipe box (up to 16,00kW)

1) EER and COP calculation is based in accordance to EN14511. 2) SEER/SCOP is calculated based on the seasonal space cooling/heating efficiency "η" values of the COMMISSION REGULATION (EU) 2016/2281. SEER, SCOP = (η + Correction) × PE. 3) Pipe diameter under 90m for ultimate indoor unit / over 90m for ultimate indoor unit (if the longest piping equivalent length exceeds 90m, increase the sizes of the main tubes by 1 rank for gas tubes and liquid tubes).



# NEW 3-PIPE ECOi EX MF3 SERIES COMBINATION FROM 18 TO 48HP



HP	18HP		20HP		22HP		24HP		26HP		28HP		30HP		32HP	
Model name	U-8MF3E8		U-8MF3E8		U-10MF3E8		U-12MF3E8		U-10MF3E8		U-12MF3E8		U-14MF3E8		U-16MF3E8	
	U-10MF3E8		U-12MF3E8		U-12MF3E8		U-12MF3E8		U-16MF3E8		U-16MF3E8		U-16MF3E8		U-16MF3E8	
Power supply	Voltage	V	380/400/415		380/400/415		380/400/415		380/400/415		380/400/415		380/400/415		380/400/415	
	Phase		Three Phase		Three Phase		Three Phase		Three Phase		Three Phase		Three Phase		Three Phase	
	Frequency	Hz	50		50		50		50		50		50		50	
Cooling capacity	kW		50,00		56,00		61,50		68,00		73,00		78,50		85,00	
EER <sup>1)</sup>	W/W		4,90		4,31		4,24		3,89		3,88		3,65		3,59	
Running current cooling	A		16,80/16,00/15,40		21,00/20,00/19,20		23,70/22,50/21,70		28,30/26,90/25,90		31,00/29,50/28,40		35,10/33,40/32,20		39,60/37,60/36,20	
Input power cooling	kW		10,20		13,00		14,50		17,50		18,80		21,50		23,70	
Heating capacity	kW		56,00		63,00		69,00		76,50		81,50		87,50		95,00	
COP <sup>1)</sup>	W/W		5,23		4,77		4,79		4,47		4,50		4,31		4,19	
Running current heating	A		17,70/16,80/16,20		21,30/20,30/19,50		23,50/22,30/21,50		27,60/26,30/25,30		30,20/28,70/27,70		33,50/31,80/30,70		37,90/36,00/34,70	
Input power heating	kW		10,70		13,20		14,40		17,10		18,10		20,30		22,70	
Starting current			2,00		2,00		2,00		2,00		3,00		3,00		4,00	
External static pressure (Max)			80		80		80		80		80		80		80	
Air volume	m <sup>3</sup> /min		430		442		452		464		452		464		464	
Sound pressure	Normal mode	dB(A)	59,00		61,00		62,00		63,00		63,50		64,50		65,00	
	Silent mode 1 / 2	dB(A)	56,00/54,00		58,00/56,00		59,00/57,00		60,00/58,00		60,50/58,50		61,50/59,50		62,00/60,00	
Sound power	Normal mode	dB	81,50		84,00		84,50		86,00		84,50		86,00		86,00	
Dimension	H x W x D	mm	1842 x 2360 (+60) x 1000		1842 x 2360 (+60) x 1000		1842 x 2360 (+60) x 1000		1842 x 2360 (+60) x 1000		1842 x 2360 (+60) x 1000		1842 x 2360 (+60) x 1000		1842 x 2360 (+60) x 1000	
Net weight	kg		523		547		548		574		596		620		668	
Piping connections <sup>2)</sup>	Liquid pipe	Inch (mm)	5/8(15,88)/ 3/4(19,05)		5/8(15,88)/ 3/4(19,05)		5/8(15,88)/ 3/4(19,05)		5/8(15,88)/ 3/4(19,05)		3/4(19,05)/ 7/8(22,22)		3/4(19,05)/ 7/8(22,22)		3/4(19,05)/ 7/8(22,22)	
	Discharge pipe	Inch (mm)	7/8(22,22)/ 1(25,40)		7/8(22,22)/ 1(25,40)		1-1/8(28,58)		1-1/8(28,58)		1-1/8(28,58)		1-1/8(28,58)/ 1-1/4(31,75)		1-1/8(28,58)/ 1-1/4(31,75)	
	Suction pipe	Inch (mm)	1-1/8(28,58)/ 1-1/4(31,75)		1-1/8(28,58)/ 1-1/4(31,75)		1-1/8(28,58)/ 1-1/4(31,75)		1-1/8(28,58)/ 1-1/4(31,75)		1-1/4(31,75)/ 1-1/2(38,10)		1-1/4(31,75)/ 1-1/2(38,10)		1-1/4(31,75)/ 1-1/2(38,10)	
	Balance pipe	Inch (mm)	1/4(6,35)		1/4(6,35)		1/4(6,35)		1/4(6,35)		1/4(6,35)		1/4(6,35)		1/4(6,35)	
Refrigerant (R410A)	kg/TCO <sub>2</sub> Eq.		13,60/28,3968		15,10/31,5288		15,10/31,5288		16,60/34,6608		15,10/31,5288		16,60/34,6608		16,60/34,6608	
Maximum allowable indoor / outdoor capacity ratio %			50 ~ 150		50 ~ 150		50 ~ 150		50 ~ 150		50 ~ 150		50 ~ 150		50 ~ 150	
Operating range	Cool Min ~ Max	°C	-10 ~ +52		-10 ~ +52		-10 ~ +52		-10 ~ +52		-10 ~ +52		-10 ~ +52		-10 ~ +52	
	Heat Min ~ Max	°C	-20 ~ +18		-20 ~ +18		-20 ~ +18		-20 ~ +18		-20 ~ +18		-20 ~ +18		-20 ~ +18	
	Simultaneous op.	°C	-10 ~ +24		-10 ~ +24		-10 ~ +24		-10 ~ +24		-10 ~ +24		-10 ~ +24		-10 ~ +24	

HP	34HP		36HP		38HP		40HP		42HP		44HP		46HP		48HP	
Model name	U-8MF3E8		U-8MF3E8		U-10MF3E8		U-8MF3E8		U-10MF3E8		U-12MF3E8		U-14MF3E8		U-16MF3E8	
	U-10MF3E8		U-12MF3E8		U-12MF3E8		U-16MF3E8		U-16MF3E8		U-16MF3E8		U-16MF3E8		U-16MF3E8	
Power supply	Voltage	V	380/400/415		380/400/415		380/400/415		380/400/415		380/400/415		380/400/415		380/400/415	
	Phase		Three Phase		Three Phase		Three Phase		Three Phase		Three Phase		Three Phase		Three Phase	
	Frequency	Hz	50		50		50		50		50		50		50	
Cooling capacity	kW		96,00		101,00		107,00		113,00		118,00		124,00		130,00	
EER <sup>1)</sup>	W/W		4,10		3,90		3,88		3,72		3,72		3,58		3,55	
Running current cooling	A		38,60/36,70/35,40		42,30/40,20/38,70		45,60/43,30/41,70		50,20/47,70/46,00		52,40/49,70/47,90		56,50/53,70/51,80		61,10/58,10/56,00	
Input power cooling	kW		23,40		25,90		27,60		30,40		31,70		34,60		36,60	
Heating capacity	kW		108,00		113,00		119,00		127,00		132,00		138,00		145,00	
COP <sup>1)</sup>	W/W		4,64		4,48		4,51		4,31		4,36		4,25		4,18	
Running current heating	A		38,90/37,00/35,60		41,60/39,50/38,10		43,60/41,40/39,90		49,30/46,80/45,10		50,60/48,10/46,30		53,70/51,00/49,10		57,90/55,00/53,00	
Input power heating	kW		23,30		25,20		26,40		29,50		30,30		32,50		34,70	
Starting current			4,00		4,00		4,00		5,00		5,00		5,00		6,00	
External static pressure (Max)			80		80		80		80		80		80		80	
Air volume	m <sup>3</sup> /min		662		674		684		674		684		696		696	
Sound pressure	Normal mode	dB(A)	64,00		64,50		65,00		65,50		66,00		66,50		67,00	
	Silent mode 1 / 2	dB(A)	61,00/59,00		61,50/59,50		62,00/60,00		62,50/60,50		63,00/61,00		63,50/61,50		64,00/62,00	
Sound power	Normal mode	dB	84,50		85,50		85,50		85,50		86,00		86,50		87,00	
Dimension	H x W x D	mm	1842 x 3540 (+120) x 1000		1842 x 3540 (+120) x 1000		1842 x 3540 (+120) x 1000		1842 x 3540 (+120) x 1000		1842 x 3540 (+120) x 1000		1842 x 3540 (+120) x 1000		1842 x 3540 (+120) x 1000	
Net weight	kg		857		881		882		929		930		954		1002	
Piping connections <sup>3)</sup>	Liquid pipe	Inch (mm)	3/4(19,05)/ 7/8(22,22)		3/4(19,05)/ 7/8(22,22)		3/4(19,05)/ 7/8(22,22)		3/4(19,05)/ 7/8(22,22)		3/4(19,05)/ 7/8(22,22)		3/4(19,05)/ 7/8(22,22)		3/4(19,05)/ 7/8(22,22)	
	Discharge pipe	Inch (mm)	1-1/8(28,58)/ 1-1/4(31,75)		1-1/8(28,58)/ 1-1/4(31,75)		1-1/4(31,75)/ 1-1/2(38,10)		1-1/4(31,75)/ 1-1/2(38,10)		1-1/4(31,75)/ 1-1/2(38,10)		1-1/4(31,75)/ 1-1/2(38,10)		1-1/4(31,75)/ 1-1/2(38,10)	
	Suction pipe	Inch (mm)	1-1/4(31,75)/ 1-1/2(38,10)		1-1/2(38,10)/ 1-5/8(41,28)		1-1/2(38,10)/ 1-5/8(41,28)		1-1/2(38,10)/ 1-5/8(41,28)		1-1/2(38,10)/ 1-5/8(41,28)		1-1/2(38,10)/ 1-5/8(41,28)		1-1/2(38,10)/ 1-5/8(41,28)	
	Balance pipe	Inch (mm)	1/4(6,35)		1/4(6,35)		1/4(6,35)		1/4(6,35)		1/4(6,35)		1/4(6,35)		1/4(6,35)	
Refrigerant (R410A)	kg/TCO <sub>2</sub> Eq.		21,90/45,72719		23,40/48,85919		23,40/48,85919		23,40/48,85919		23,40/48,85919		24,90/46,3536		24,90/51,9912	
Maximum allowable indoor / outdoor capacity ratio %			50 ~ 150		50 ~ 150		50 ~ 150		50 ~ 150		50 ~ 150		50 ~ 150		50 ~ 150	
Operating range	Cool Min ~ Max	°C	-10 ~ +52		-10 ~ +52		-10 ~ +52		-10 ~ +52		-10 ~ +52		-10 ~ +52		-10 ~ +52	
	Heat Min ~ Max	°C	-20 ~ +18		-20 ~ +18		-20 ~ +18		-20 ~ +18		-20 ~ +18		-20 ~ +18		-20 ~ +18	
	Simultaneous op.	°C	-10 ~ +24		-10 ~ +24		-10 ~ +24		-10 ~ +24		-10 ~ +24		-10 ~ +24		-10 ~ +24	

Rating Conditions: Cooling Indoor 27°C DB / 19°C WB. Cooling Outdoor 35°C DB. Heating Indoor 20°C DB. Heating Outdoor 7°C DB / 6°C WB. (DB: Dry Bulb; WB: Wet Bulb)  
Specifications subject to change without notice. For detailed information about ErP, please visit our websites [www.aircon.panasonic.eu](http://www.aircon.panasonic.eu) or [www.ptc.panasonic.eu](http://www.ptc.panasonic.eu).

# ECO G, THE GAS DRIVEN VRF

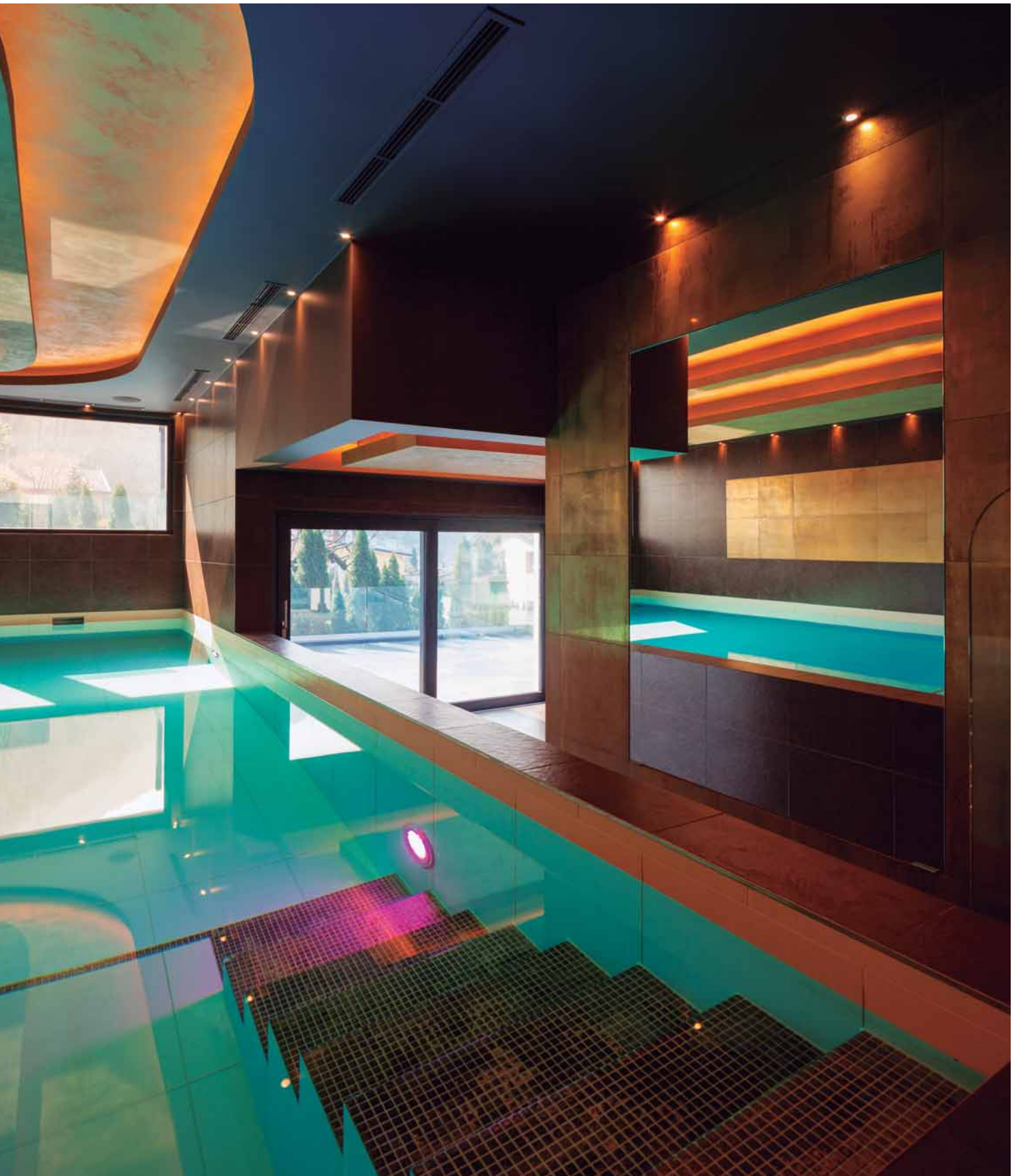

The advanced Gas Driven VRF system offers increased efficiency and performance across the range. Improvements include increased part load performance, reduced gas consumption with a Miller-cycle engine and reduced electrical consumption by using DC-Fan motors.

## 1 Limited electric supply

Electric consumption of ECO G is only 9% compared to ECOi because gas engine is utilized for the compressor driving source.

## 2 High demand of DHW with heating and cooling cogeneration

DHW is produced effectively thanks to heat from engine exhaust during heating and cooling.

## 3 Open and flexible design

ECO G system is designed to connect various Indoor units and controllers which is available for ECOi system. With new GE3 series, Pump sown system has been also implemented to answer commercial needs.

## 4 Quick start up in heating at low ambient temperature

Gas heat pump systems make your building comfortably warm by a quick start up with waste heat from engine. Heating mode works from -21°C of ambient temperature.

Comparison of heating capacity.

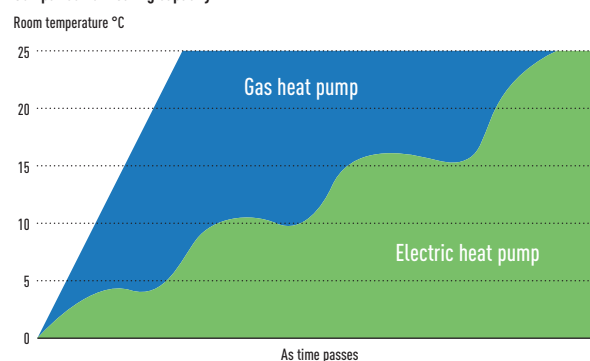

### 2-Pipe ECO G GE3 Series

Designed for better energy efficiency. SEER has been increased by maximum 120%.



### NEW 3-Pipe ECO G GF3 Series

Domestic hot water can be supplied by effectively using waste heat generated by heating & cooling.

### GE3/GF3 connectable indoor units

Type	Model number reference	2-Pipe ECO G GE3 Series	NEW 3-Pipe ECO G GF3 Series
Standard AZA indoor units	—	Yes <sup>1</sup>	Yes <sup>1</sup>
Water Heat Exchanger	PAW-WX4E5N/5N2	Yes <sup>2</sup>	No
High Static Pressure Hide Away	S-ME2E5	Yes	No
Heat Recovery with DX Coil	PAW-ZDX3N	Yes	Yes
Air Curtain with DX Coil	PAW-EAIRC-MJ/MS	Yes	Yes <sup>3</sup>
AHU Connection Kit	PAW-MAH2/M/L	Yes	Yes <sup>3</sup>

1) Except for 1,50kW capacity. 2) Allowed 1:1 and also mixed. If mixed, not operate at the same time WHE + DX only operate separately. 3) Smaller capacity than 16kW only.

# ECO G, THE GAS DRIVEN VRF

**200.000**  
GHP outdoor units  
were sold in all over  
the world

ECO G satisfies special requirement for your application and environmentally friendly solution by Panasonic professional technology.

Reliable quality by long development history since 1985.

Our ECO G VRF range of commercial systems is leading the industry in the development of efficient and flexible systems



## What is GHP? The Gas Heat Pump (GHP)

Panasonic Gas Heat Pump is a direct expansion system with compressor as same as VRF system. Gas engine is used as driving source of compressor instead of electric motor. This gas engine compressor drive has 2 advantages:

1. Waste heat from the gas engine available
  2. No need for motor power consumption thanks to gas engine
- GHP is the natural choice for commercial projects, especially for those projects where power restrictions apply.

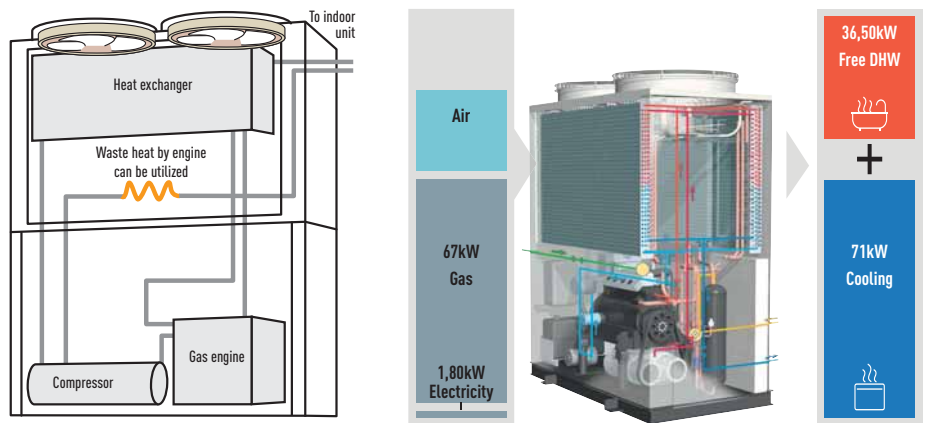

\* Regarding a 25HP model.

## Power supply problems?

If you are short of electric power, our ECO G is a perfect solution.

- Runs on natural gas or LPG and just needs single phase supply
- Enables the building's electrical power supply to be used for other critical electrical demands
- Reduces capital cost to upgrade power substations to run heating and cooling systems
- Reduces power loadings within a building especially during peak periods
- Electricity supply freed up for other uses such as IT servers, commercial refrigeration, manufacturing, lighting, etc...

### Limited electricity area.

Comparison of electrical consumption on a 71kW outdoor unit.

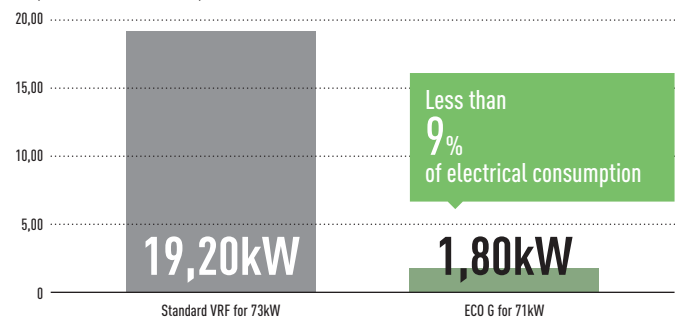

## High demand of Domestic Hot Water in heating and cooling

The rejected heat from the engine is available for DHW production and can supply up to 46kW of hot water at 65°C. DHW at 65°C is also ready to use in heating without additional electric heaters.

### Application example: Hotel

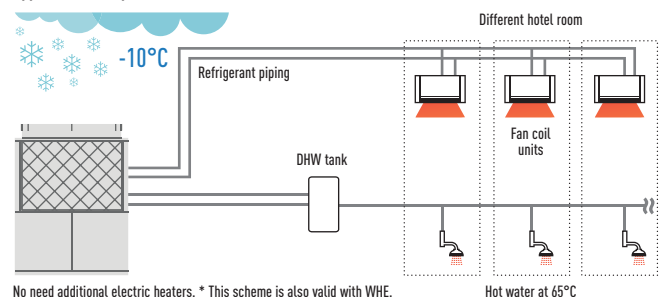



**Quick start up and great heating capacity at low ambient temperature**

Waste heat from gas engine is utilized to raise temperature quicker than electric VRF system. This contributes great heating capacity at extremely low ambient temperature.

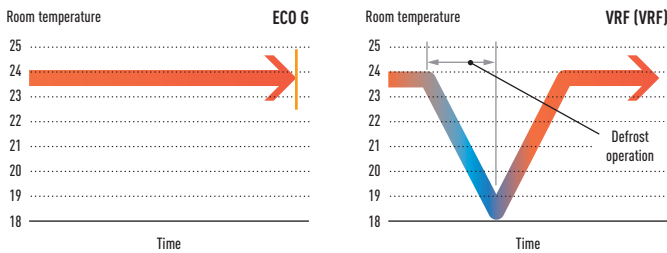

**Lowest nitrogen oxide emissions.**

The ECO G VRF systems have low nitrogen oxide emissions. In a pioneering development, the Panasonic ECO G features a brand new lean-burn combustion system that utilizes air fuel ratio feedback control to reduce NOx emissions to an all time low.

**Water chiller option.**

Our ECO G system is also available with a water chiller option, which can be combined with individual outdoor units or as part of a DX chilled water mix of indoor units. The system can be operated via a BMS system or a Panasonic supplied control panel, with chilled water set points from -15°C ~ +15°C and heating set points 35°C ~ +55°C.

**Application**

Application	Condition	ECO G
Hotel	High DHW demand	✓
Hotel	Needs to warm up swimming pool	Energy recovery of ECO G system can fulfill different requirement
Office	Quick start up is necessary	✓
Winery	1) Outlet water demand at specific temperature 2) Needs high amount of power temporary (not every month)	✓ 1) Chiller application with hydro module (ECO G + WHE) can make this special process 2) Running cost can be saved since fixed Gas tariff per month is cheaper than fixed electric tariff.
Any building	In a city with power restriction	✓ - No need an additional power transformer - Space and cost can be saved
	At extremely low ambient condition	✓ Heating capacity is kept up to -20°C without defrost process

**Project Case Studies**



**Savills HQ Dublin & Google Block R. Ireland.**

ECO G 3-way units with a 243kW load. The project has been such a success that it has recently been awarded a Panasonic PRO Award for Best Contribution of efficient projects within Europe.



**Thomas Cook's Sunprime Atlantic View resort.**

A holiday resort in the Canaries. Spain. 229 rooms plus full spa and swimming pool facility.



**CAPITA call centre. UK.**

11 ECO G 3-way units. Over 150 indoor units in meeting rooms and open-plan areas. Intelligent touch screen controller, the CZ-256ESMC2.



**French winery Gennevilliers, France.**

ECO G 3-way units. One of the best solution utilized our ECO G solution for wine production process.

# ECO G 3 SERIES

## Improvement in blast efficiency

### New 3-blades fan.

Propeller shape with 3 blades is more efficient  
Max. 30% of fan electrical consumption is saved compared to conventional fan.

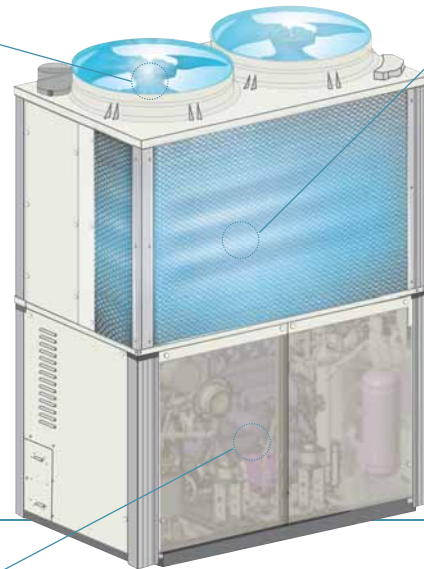
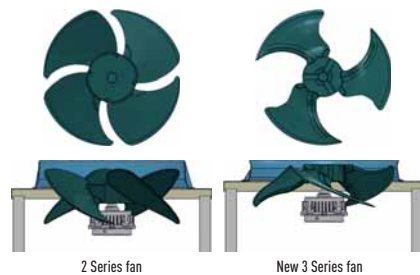

## New "L" type heat exchanger

Heat exchanger surface area is included by 25% compared to conventional model to optimize efficiency.

Heat exchanger surface area **25% up**

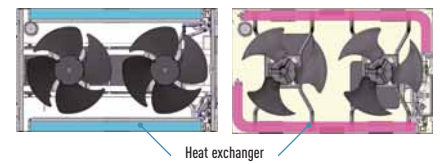

## Better partial load control

Reduce start / stop loss has reduced by expanding the are where continuous operation is possible. Annual operation efficiency has further improved by better efficiency at lower partial load.

## Compressor.

- Amount of internal leakage has reduced by the reduction of clearance, the compressor efficiency in the low load and low rotation region has been greatly improved.  
Moreover, efficiency of high speed and high load is also improved by reduction of suction pressure loss due to expansion of suction path
- Optimize compressor capacity

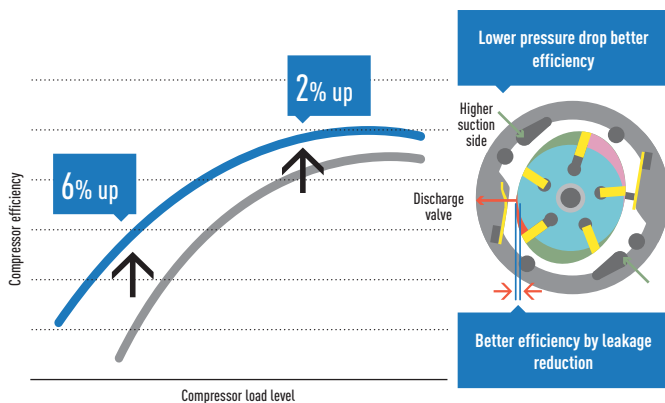

## Engine.

- Continuous operation area has expanded at lower partial load by expanding operation area of lower speed
- Engine efficiency has improved by shifting output points to higher torque side

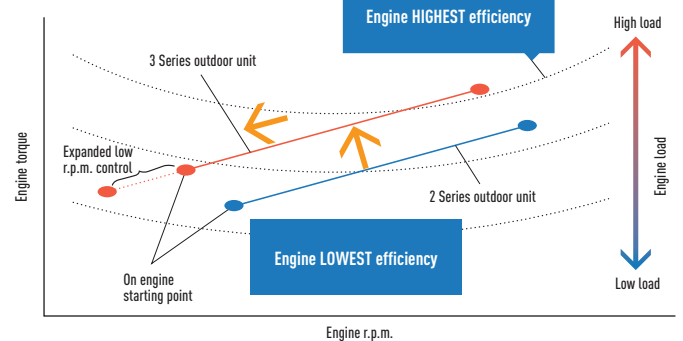

## Engine pulley.

- Bigger diameter of engine pulley contributes the optimization of the compressor rotation speed ratio with engine speed  
Higher engine pulley diameter giving better performance at partial load and reducing ON/OFF operation.

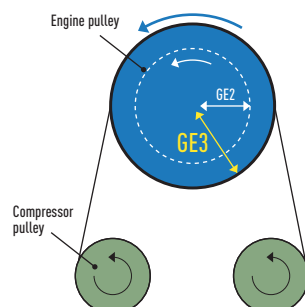

## Line up of GE3 2-Pipe W-Multi

- For new or renewal
- Available for water heat exchanger
- Maximum 60HP combination

Introducing new ECO G 3 Series.  
Optimized energy saving with reliable Panasonic technologies.

**The highest seasonal performance in all capacity ranges**

**High power efficiency of W-Multi system.**

ECO G 3 Series system offers seasonal efficiency which has been drastically improved with new heat exchanger design, blast efficiency, partial load control.

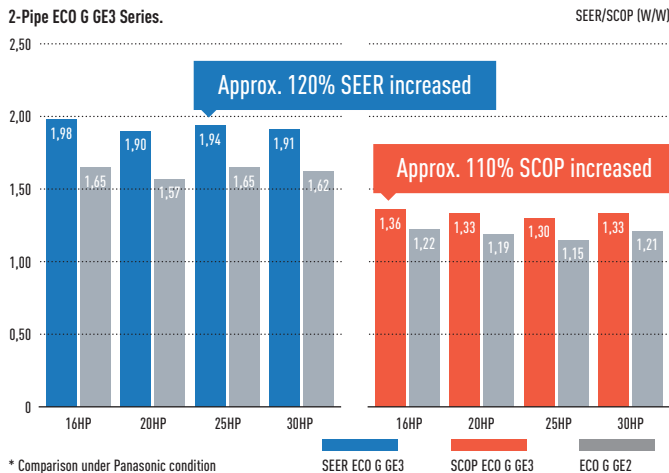

**Compared to conventional model ECO G 2 Series.**

All models are newly developed and have maximum 25% of SEER, 15% of SCOP better than conventional model.

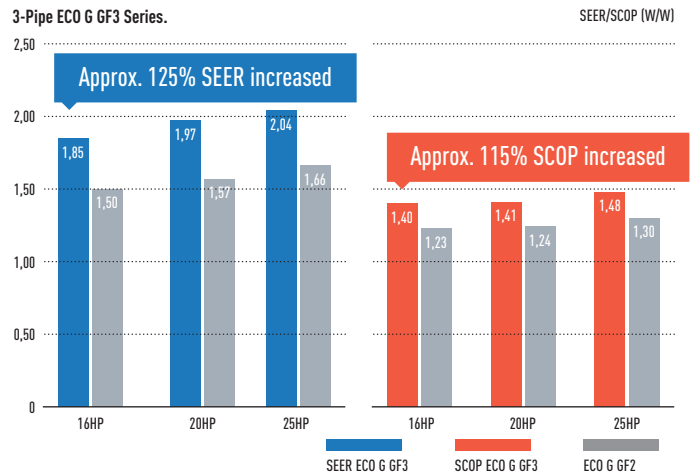

**Heating design operation conditions (GE3)**

Operating range in heating has been expanded up to 24°C (WB) for air to water system to meet the demand of swimming pool application.

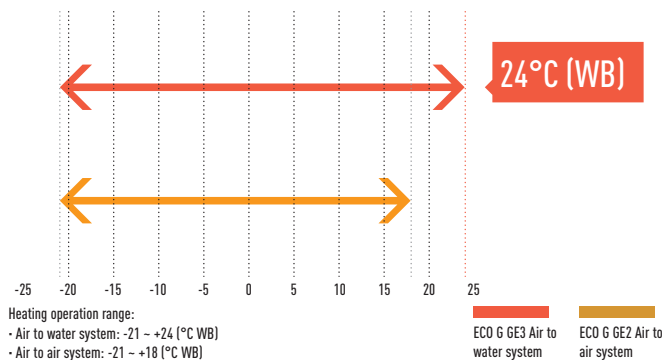

**DHW priority mode setting in heating (GE3)**

Ambient temperature range for DHW production is expandable by setting depending on DHW needs. Hot water at 65°C is available in heating without additional electric heaters.

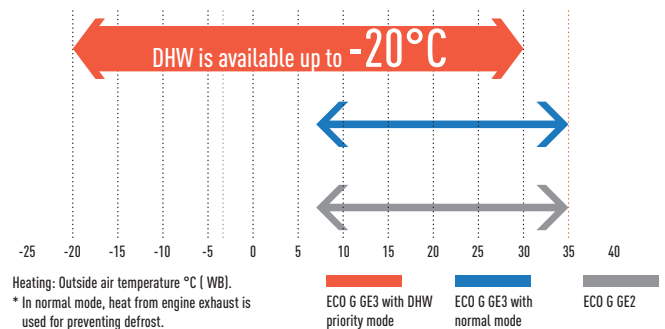

**No defrost requirement (GE3 / GF3)**

No defrost mode is selectable to get higher capacity under low ambient temperature.

**Flexible design with wide line up of indoor units**

The advanced GE3 series can connect up to 64 indoor units.

Series	16HP	20HP	25HP	30HP	32HP	36HP	40HP	45HP	50HP	55HP	60HP
2-Pipe ECO G GE3 Series	26	33	41	50	52	59	64	64	64	64	64
3-Pipe ECO G GF3 Series	24	24	24	—	—	—	—	—	—	—	—

## 2-PIPE ECO G GE3 SERIES



The new GE3 Series has a top level of seasonal efficiency in this category. In addition, this product fits with special needs for commercial application thanks to DHW priority setting and Auto pump down functions.

### Technical focus

- Superior seasonal energy efficiency, maximum 240,1%
- DHW priority setting
- Operating range in heating down to -21°C and up to +24°C for air to water system
- No defrost cycle
- Capacity ratio 50 ~ 200%<sup>1</sup>
- 0-10V control demand by a connection with 3rd party controllers (CZ-CAPBC2 required)
- Option of DX or chilled water for indoor heat exchange
- Maximum total piping length: 780m

<sup>1</sup>) 50 ~ 200% only when one outdoor unit is installed. In other cases 50 ~ 130%.

HP			16HP	20HP	25HP	30HP
Model			U-16GE3E5	U-20GE3E5	U-25GE3E5	U-30GE3E5
Power supply	Voltage	V	220/230/240	220/230/240	220/230/240	220/230/240
	Phase		Single Phase	Single Phase	Single Phase	Single Phase
	Frequency	Hz	50	50	50	50
Cooling capacity		kW	45,00	56,00	71,00	85,00
Refrigeration load Pdesign		kW	45,00	56,00	71,00	85,00
$\eta_{sc}$ (LOT21) <sup>1</sup>		%	<b>220,60</b>	<b>219,30</b>	<b>240,10</b>	<b>229,30</b>
Input power cooling		kW	1,17	1,12	1,80	1,80
Hot water in cooling mode (at 65°C outlet)		kW	23,60	29,10	36,40	46,00
Max COP in hot water		W/W	1,55	1,55	1,49	1,47
Gas consumption cooling		kW	41,10	52,10	67,20	84,10
Heating capacity	Standard	kW	50,00	63,00	80,00	95,00
	Low temperature	kW	53,00	67,00	78,00	90,00
Refrigeration load Pdesign		kW	37,00	53,00	60,00	65,00
$\eta_{sh}$ (LOT21) <sup>1</sup>		%	<b>150,60</b>	<b>143,70</b>	<b>146,90</b>	<b>151,30</b>
Input power heating		kW	0,56	1,05	0,91	1,75
Gas consumption heating	Standard	kW	38,00	51,10	68,60	75,30
	Low temperature	kW	45,40	62,70	60,70	73,90
Starter amperes		A	30	30	30	30
External static pressure		Pa	10	10	10	10
Air volume		m <sup>3</sup> /min	370	420	460	460
Sound power		dB	80/77	80/77	84/81	84/81
Dimension	H x W x D	mm	2255 x 1650 x 1000	2255 x 1650 x 1000	2255 x 2026 x 1000	2255 x 2026 x 1000
Net weight		kg	765	765	870	880
Piping connections	Liquid pipe	Inch (mm)	1/2 (12,70)	5/8 (15,88)	5/8 (15,88)	3/4 (19,05)
	Gas pipe	Inch (mm)	1-1/8 (28,58)	1-1/8 (28,58)	1-1/8 (28,58)	1-1/4 (31,75)
	Balance pipe	Inch (mm)	—	—	—	—
Elevation difference (in/out)			50	50	50	50
Refrigerant (R410A)		kg/TCO <sub>2</sub> Eq.	11,50/24,00	11,50/24,00	11,50/24,00	11,50/24,00
Maximum number of connectable indoor units			26	33	41	50
Operating range	Cool Min ~ Max	°C (DB)	-10 ~ +43	-10 ~ +43	-10 ~ +43	-10 ~ +43
	Heat Min ~ Max	°C (WB)	-21 ~ +18	-21 ~ +18	-21 ~ +18	-21 ~ +18

<sup>1</sup>) SEER/SCOP is calculated based on the seasonal space cooling/heating efficiency “ $\eta_1$ ” values of the COMMISSION REGULATION (EU) 2016/2281.

Hot water take out function added, EU safety regulation standard cleared. 25HP chassis enlarged due to specification improvement. Pre-coat corrosion fin. Auto pump down function.



## 2-PIPE ECO G GE3 SERIES COMBINATION



The new GE3 Series has a top level of seasonal efficiency in this category. In addition, this product fits with special needs for commercial application thanks to DHW priority setting and Auto pump down functions.

### Technical focus

- Maximum 60HP combination
- Superior seasonal energy efficiency, maximum 240,1%
- DHW priority setting
- Operating range in heating down to -21°C and up to +24°C for air to water system
- No defrost cycle
- 0-10V control demand by a connection with 3rd party controllers (CZ-CAPBC2 required)
- Option of DX or chilled water for indoor heat exchange
- Maximum total piping length: 780m

HP			32HP	36HP	40HP	45HP	50HP	55HP	60HP
Model			U-16GE3E5 U-16GE3E5	U-16GE3E5 U-20GE3E5	U-20GE3E5 U-20GE3E5	U-20GE3E5 U-25GE3E5	U-25GE3E5 U-25GE3E5	U-25GE3E5 U-30GE3E5	U-30GE3E5 U-30GE3E5
Power supply	Voltage	V	220/230/240	220/230/240	220/230/240	220/230/240	220/230/240	220/230/240	220/230/240
	Phase		Single Phase	Single Phase	Single Phase	Single Phase	Single Phase	Single Phase	Single Phase
	Frequency	Hz	50	50	50	50	50	50	50
Cooling capacity		kW	90,00	101,00	112,00	127,00	142,00	156,00	170,00
Input power cooling		kW	2,34	2,29	2,24	2,92	3,60	3,60	3,60
Hot water in cooling mode (at 65°C outlet)		kW	47,20	52,70	58,20	65,50	72,80	82,40	92,00
Max COP in hot water		W/W	1,55	1,55	1,55	1,52	1,49	1,48	1,47
Gas consumption cooling		kW	82,20	93,20	104,20	119,30	134,40	151,30	168,20
Heating capacity	Standard	kW	100,00	113,00	126,00	143,00	160,00	175,00	190,00
	Low temperature	kW	106,00	120,00	134,00	145,00	156,00	168,00	180,00
Input power heating		kW	1,12	1,61	2,10	1,96	1,82	2,66	3,50
Gas consumption heating	Standard	kW	76,00	89,10	102,20	119,70	137,20	143,90	150,60
	Low temperature	kW	90,80	108,10	125,40	123,40	121,40	134,60	147,80
Starter amperes		A	30	30	30	30	30	30	30
External static pressure		Pa	10	10	10	10	10	10	10
Air volume		m <sup>3</sup> /min	370/370	370/420	420/420	420/460	460/460	460/460	460/460
Sound power		dB	83/80	83/80	83/80	86/83	87/84	87/84	87/84
Dimension	Height	mm	2255	2255	2255	2255	2255	2255	2255
	Width	mm	1650 + 100 + 1650	1650 + 100 + 1650	1650 + 100 + 1650	1650 + 100 + 2026	2026 + 100 + 2026	2026 + 100 + 2026	2026 + 100 + 2026
	Depth	mm	1000	1000	1000	1000	1000	1000	1000
Net weight		kg	1530 (765 + 765)	1530 (765 + 765)	1530 (765 + 765)	1635 (765 + 870)	1740 (870 + 870)	1750 (870 + 880)	1760 (880 + 880)
Piping connections	Liquid pipe	Inch (mm)	3/4 (19,05)	3/4 (19,05)	3/4 (19,05)	3/4 (19,05)	3/4 (19,05)	7/8 (22,22)	7/8 (22,22)
	Gas pipe	Inch (mm)	1-1/4 (31,75)	1-1/4 (31,75)	1-1/2 (38,10)	1-1/2 (38,10)	1-1/2 (38,10)	1-1/2 (38,10)	1-1/2 (38,10)
	Balance pipe	Inch (mm)	—	—	—	—	—	—	—
Elevation difference (in/out)			50	50	50	50	50	50	50
Refrigerant (R410A)		kg/TCO <sub>2</sub> Eq.	2x 11,50/24,00	2x 11,50/24,00	2x 11,50/24,00	2x 11,50/24,00	2x 11,50/24,00	2x 11,50/24,00	2x 11,50/24,00
Maximum number of connectable indoor units			52	59	64	64	64	64	64
Operating range	Cool Min ~ Max	°C	-10 ~ +43	-10 ~ +43	-10 ~ +43	-10 ~ +43	-10 ~ +43	-10 ~ +43	-10 ~ +43
	Heat Min ~ Max	°C	-21 ~ +18	-21 ~ +18	-21 ~ +18	-21 ~ +18	-21 ~ +18	-21 ~ +18	-21 ~ +18

Data is for reference. Hot water take out function added, EU safety regulation standard cleared. 25HP chassis enlarged due to specification improvement. Pre-coat corrosion fin. Auto pump down function.



# NEW 3-PIPE ECO G GF3 SERIES



## Power supply problems?

If you are short of electrical power, our gas heat pump could be the perfect solution:

- Runs on natural gas or LPG and just needs Single Phase supply
- Enables the building's electrical power supply to be used for other critical electrical demands
- Reduces capital cost to upgrade power substations to run heating and cooling systems
- Reduces power loadings within a building especially during peak periods
- Electricity supply freed up for other uses such as IT servers, commercial refrigeration, manufacturing, lighting etc.

## ECO G Outdoor Heat Exchanger.

- Integrated DX and hot water coil
- No defrost required
- Faster reaction to demand for heating

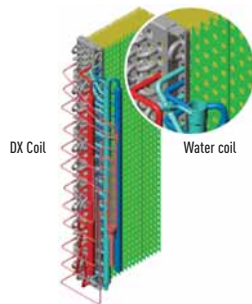

## DHW production in heating and cooling

Free DHW is available 365 days a year, in all seasons. Hot water is produced effectively from waste heat from engine. Perfect solution for hotel projects required high demand of hot water.

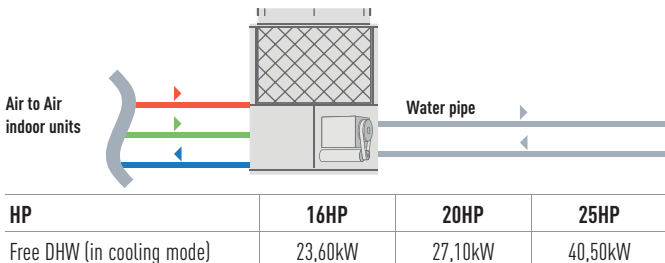

## Excellent performance and free Domestic Hot Water

Panasonic 3-Pipe Multi system is capable of simultaneous heating/cooling and individual operation of each indoor unit by only one outdoor unit. As a result, efficient individual air conditioning is possible in buildings having diverse room temperatures.

In addition, Domestic Hot Water is created for free in cooling mode without additional boilers or electric heaters.

### System example.

Improved maintenance intervals. The unit only needs to be serviced every 10,000 hours. This is the best in the industry.

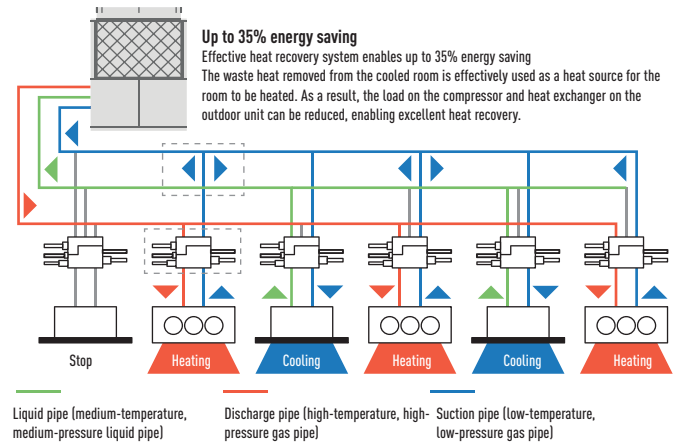

## Solenoid valve kit.

To be fitted on all 'zones' to allow simultaneous heating and cooling. Up to 24 indoor units are capable of simultaneous heating/cooling operation. Oil-recovery operation to gives more stable comfort air-conditioning control.

### 3-Pipe control Solenoid valve kit



**CZ-P56HR3**  
Up to 5,60kW  
**CZ-P160HR3**  
Up to 16,00kW

**KIT-P56HR3**  
(CZ-P56HR3+CZ-CAPE2)  
**KIT-P160HR3**  
(CZ-P160HR3+CZ-CAPE2)

### 3-Pipe control PCB



**CZ-CAPE2\***  
3-Pipe control PCB

\* For wall mounted. Must be added to the CZ-P56HR3 or CZ-P160HR3.

**HOT WATER  
AT 65°C  
OUTLET FOR  
FREE**



## NEW 3-PIPE ECO G GF3 SERIES

NEW  
18



### New 3-Pipe ECO G GF3 Series.

#### DHW available in all seasons

Domestic hot water can be taken out from waste heat of engine effectively in heating & cooling - all year round.

#### Outstanding seasonal energy efficiency, maximum 204,9%

- Capacity ratio 50 ~ 200%
- No defrost cycle
- Maximum total piping length: 780m

#### Flexible installation

- Full heating capacity down to -21°C (WB)
- DHW production for all the year
- Maximum 24 indoor units connectable

HP			16HP	20HP	25HP
Model			U-16GF3E5	U-20GF3E5	U-25GF3E5
Power supply	Voltage	V	220/230/240	220/230/240	220/230/240
	Phase		Single Phase	Single Phase	Single Phase
	Frequency	Hz	50	50	50
Cooling capacity		kW	45,00	56,00	71,00
Refrigeration load Pdesign		kW	45,00	56,00	71,00
$\eta_{sc}$ (LOT21) <sup>1</sup>		%	<b>185,20</b>	<b>198,80</b>	<b>204,90</b>
Input power cooling		kW	1,17	1,40	1,80
Hot water in cooling mode (at 65°C outlet)		kW	23,60	27,10	40,50
Gas consumption cooling		kW	45,80	54,80	73,70
Heating capacity	Standard	kW	50,00	63,00	80,00
	Low temperature	kW	53,00	67,00	78,00
Refrigeration load Pdesign		kW	38,00	52,00	60,00
$\eta_{sh}$ (LOT21) <sup>1</sup>		%	<b>139,20</b>	<b>140,20</b>	<b>150,90</b>
Input power heating		kW	0,56	1,05	0,91
Gas consumption heating	Standard	kW	42,20	51,10	68,60
Starter amperes		A	30	30	30
Air volume		m <sup>3</sup> /min	370	400	460
Sound power		dB	80/77	81/78	84/81
Dimension	HxWxD	mm	2255x1650x1000	2255x1650x1000	2255x2026x1000
Net weight		kg	775	775	880
Piping connections	Gas	Inch (mm)	1 1/8 (28,58)	1 1/8 (28,58)	1 1/8 (28,58)
	Liquid	Inch (mm)	3/4 (19,05)	3/4 (19,05)	3/4 (19,05)
	Discharge	Inch (mm)	7/8 (22,22)	1 (25,40)	1 (25,40)
	Fuel gas		R3/4	R3/4	R3/4
	Exhaust drain port	mm	25	25	25
Elevation difference (in/out)		m	50	50	50
Refrigerant (R410A)		kg/TCO <sub>2</sub> Eq.	11,50/24,00	11,50/24,00	11,50/24,00
Maximum number of connectable indoor units			24	24	24
Operating range	Cool Min ~ Max	°C	-10 ~ +43	-10 ~ +43	-10 ~ +43
	Heat Min ~ Max	°C	-21 ~ +18	-21 ~ +18	-21 ~ +18

#### Solenoid valve kit

KIT-P56HR3	KIT-P56HR3	3-Pipe control Solenoid valve kit (up to 5,60kW)
	CZ-P56HR3	Solenoid valve kit (up to 5,60kW)
	CZ-CAPE2	3-Pipe control PCB
KIT-P160HR3	KIT-P160HR3	3-Pipe control Solenoid valve kit (from 5,6 to 10,60kW)
	CZ-P160HR3	Solenoid valve kit (up to 16,00kW)
	CZ-CAPE2	3-Pipe control PCB
CZ-CAPEK2		3-Pipe control PCB for wall mounted

#### 3-Pipe control box kit

CZ-P456HR3	4 ports 3 pipe box (up to 5,60kW)
CZ-P656HR3	6 ports 3 pipe box (up to 5,60kW)
CZ-P856HR3	8 ports 3 pipe box (up to 5,60kW)
CZ-P4160HR3	4 ports 3 pipe box (up to 16,00kW)



1) SEER/SCOP is calculated based on the seasonal space cooling/heating efficiency "η" values of the COMMISSION REGULATION (EU) 2016/2281.  
Hot water take out function added, EU safety regulation standard cleared. 25HP chassis enlarged due to specification improvement. Pre-coat corrosion fin. Auto pump down function.

# NEW PANASONIC GHP/EHP HYBRID SYSTEM. FIRST INTELLIGENT TECHNOLOGY

GHP + EHP  
**HYBRID**  
VRF SYSTEM





Taking advantage of Gas and Electricity to achieve better energy saving ever.



- Master unit GHP**
- Load calculation of GHP&EHP
  - Operation in accordance with the upper limit setting.
  - Individual capacity control
  - Device control
  - Special control (Defrost, Oil recovery, 4Way-valve matching / Abnormality processing)
- Slave Unit EHP**
- Intelligent controller**
- Demand monitoring
  - Indoor/Total load calculation
  - Operation Ratio Indication upper limit setting of MAP according to:
    - Energy unit price
    - Electric power demand
    - Air conditioning load

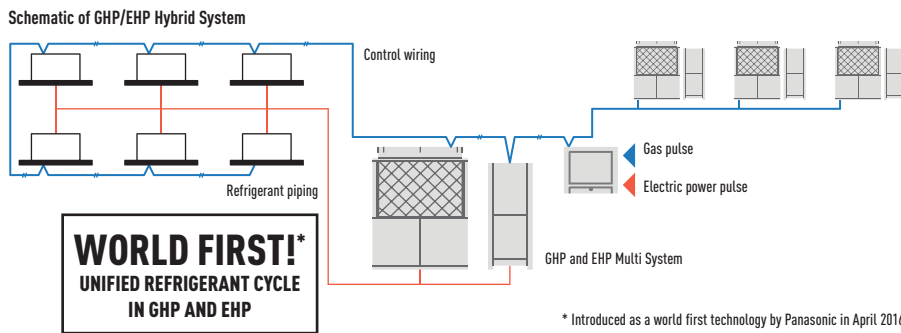

\* Introduced as a world first technology by Panasonic in April 2016.

### 1 Peak cut of electricity consumption

Electrical peak demand is significantly reduced thanks to GHP system consuming less than 10% of electricity of EHP system.

\* Image of Hotel project.

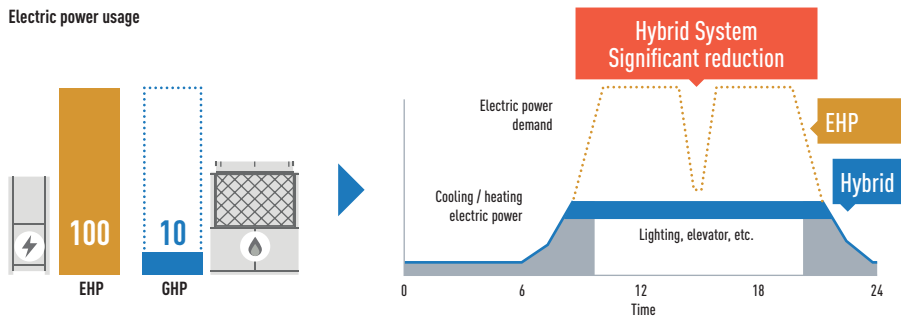

### 2 Optimal control to maximize energy saving

Switching the operation between GHP and EHP system on the basis of usage, energy demand, part load.

\* Specification is tentative.

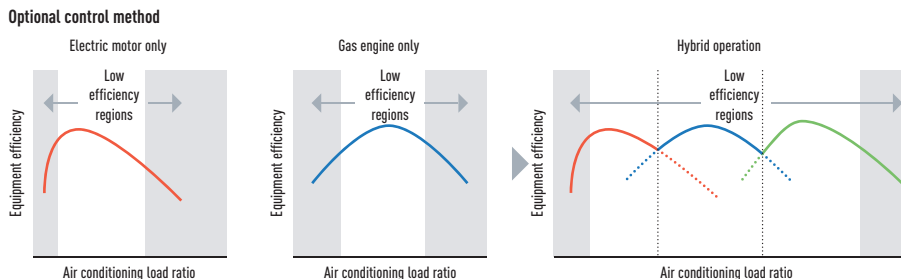

### 3 Free Hot Water production by GHP system

Hot water is effectively produced from waste heat of engine.

\* Specification is tentative.

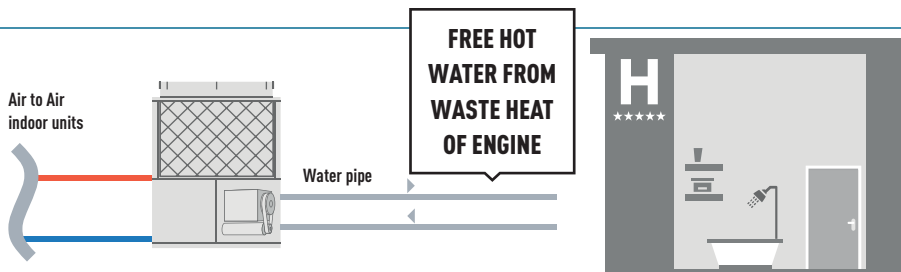

# GHP/EHP HYBRID SYSTEM

It is time to save energy utilising the advantages from gas and electricity by Panasonic reliable ECO G / ECOi technology

New hybrid system can offer intelligent operation logic for better economy and efficiency by taking the best of ECO G and ECOi. This is like a hybrid car in heating and cooling system.

## How smartly operate GHP and EHP system depending on your needs?

4 different mode settings are available with the intelligent controller. Switch the operation between GHP and EHP or operating both units together to maximise the effect for different requirement such as economy and efficiency.



### Economy mode

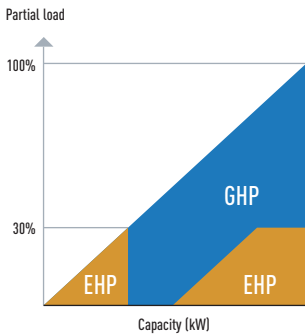

### Efficiency mode

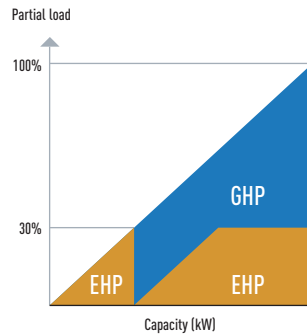

### GHP first mode

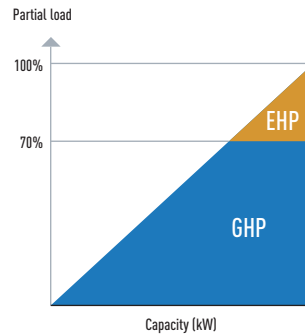

### EHP first mode

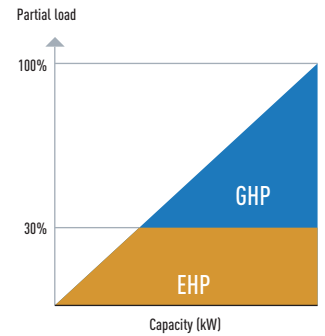

## Optimal control example: Economy mode

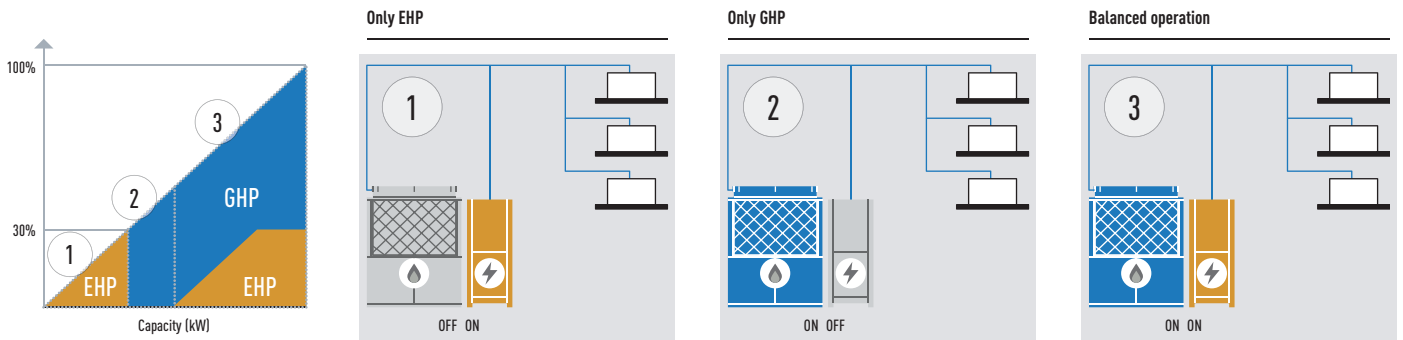

## DHW priority mode in Hybrid + WHE System

When DHW is demanded during cooling operation by EHP, EHP is automatically turned "OFF" and GHP is turned "ON" to produce DHW for free.

### High efficiency mode

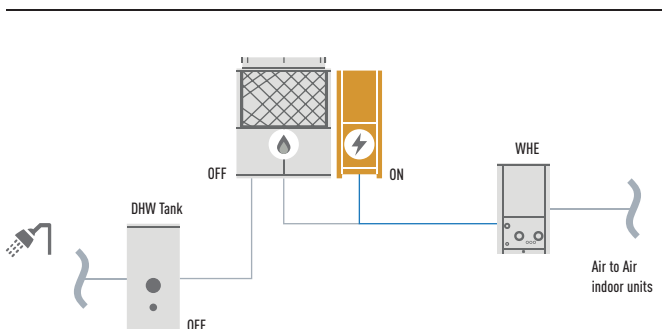

### DHW priority mode

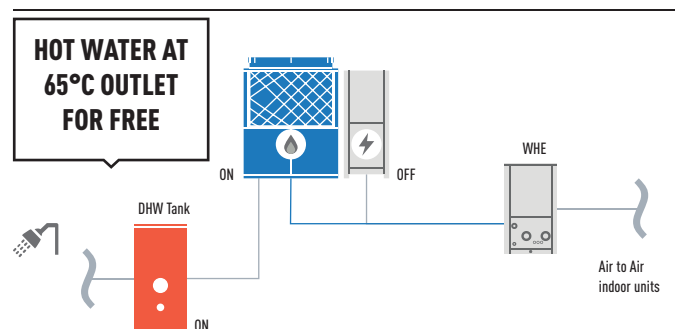

## 2-PIPE HYBRID GHP/EHP



- Extended lifespan with intelligent energy management.  
The goal is for the EHP and GHP to work at optimal speeds
- Low energy cost
- Low emissions

### Technical focus

- 4 different setting (Economy, Efficiency, GHP first mode, EHP first mode)
- DHW energy recovery 26,2kW (at 65°C) by waste heat of engine
- Unified refrigerant cycle in GHP and EHP for easy installation
- DHW priority mode with WHE system
- Up to 48 indoor units connectable

			Hybrid GHP	Hybrid EHP
			20HP	10HP
			U-20GES3E5	U-10MES2E8
<b>HP</b>				
<b>Outdoor Units</b>				
Power supply	Voltage	V	220/230/240	220/230/240
	Phase		Single Phase	Three Phase
	Frequency	Hz	50	50
Cooling capacity		kW	56,00	28,0
$\eta_{sh}$ (LOT21) <sup>1</sup>		%	<b>211,80</b>	<b>275,40</b>
Running current cooling		A	5,18	10,70/10,20/9,80
Input power cooling		kW	1,12	6,41
Hot water in cooling mode (at 65°C outlet)		kW	26,20	—
Gas consumption cooling		kW	52,10	—
Heating capacity		kW	63,00	31,50
$\eta_{sh}$ (LOT21) <sup>1</sup>		%	<b>143,20</b>	<b>167,60</b>
Running current heating		A	4,79	11,10/10,50/10,10
Input power heating		kW	1,05	6,62
Gas consumption heating	Standard	kW	51,10	—
Starting current		A	30	1
Air volume		m <sup>3</sup> /min	420	224
Sound pressure	Normal mode	dB(A)	58	56
Sound power	Normal mode	dB	80	77
Dimension	H x W x D	mm	2255 x 1650 x 1000	1842 x 770 x 1000
Net weight		kg	765	210
Piping connections <sup>2)</sup>	Liquid pipe	Inch (mm)	5/8 (15,88)	3/8 (9,52)
	Gas pipe	Inch (mm)	1 1/8 (28,58)	7/8 (22,22)
	Balance pipe	Inch (mm)	1/4 (6,35)	1/4 (6,35)
Drain heater		W	40	—
Refrigerant (R410A)		kg/TCO <sub>2</sub> Eq.	11,05/23,0724	5,60/11,6928
Maximum allowable indoor / outdoor capacity ratio %			50 ~ 130	50 ~ 130
Operating range	Cool Min ~ Max	°C	-10 ~ +43	-10 ~ +43
	Heat Min ~ Max	°C	-21 ~ +18	-21 ~ +18

1) SEER/SCOP is calculated based on the seasonal space cooling/heating efficiency " $\eta_{sh}$ " values of the COMMISSION REGULATION (EU) 2016/2281.

2) Please refer service manual when the maximum piping length exceeds 90 meters (equivalent length).



# WATER HEAT EXCHANGER FOR HYDRONIC APPLICATIONS



## Chiller replacement. Chilled water supply to fan coils

### Chiller replacement.

When some old chillers needed replacing at the end of their operational lifetime, ECO Gs with Water Heat Exchangers enabled the project to be carried out in stages whilst still utilising the existing water pipe work and fan coils. This enabled the project to be delivered on time, to a restricted budget and avoided all issues regarding refrigerant in confined spaces.



When a top London restaurant opened, it needed large volumes of fresh air to ensure the optimum dining environment. ECO G units connected to the cooling coils within the air handling equipment ensured the air was introduced in the right condition in both summer and winter.

Connection to 'close control' computer equipment

Computer room applications.

When all available electrical power needed to be utilised for the IT equipment for a leading international bank, the cooling load of over 450kW had to be powered by gas. The outdoor units were connected via Water Heat Exchangers to cooling coils inside the 'close control' units thereby maintaining a conditioned environment for temperature and humidity. By utilising the hot water function over 100kW of hot water are supplied to the building and therefore the additional benefit of considerable CO<sub>2</sub> savings is ensured.

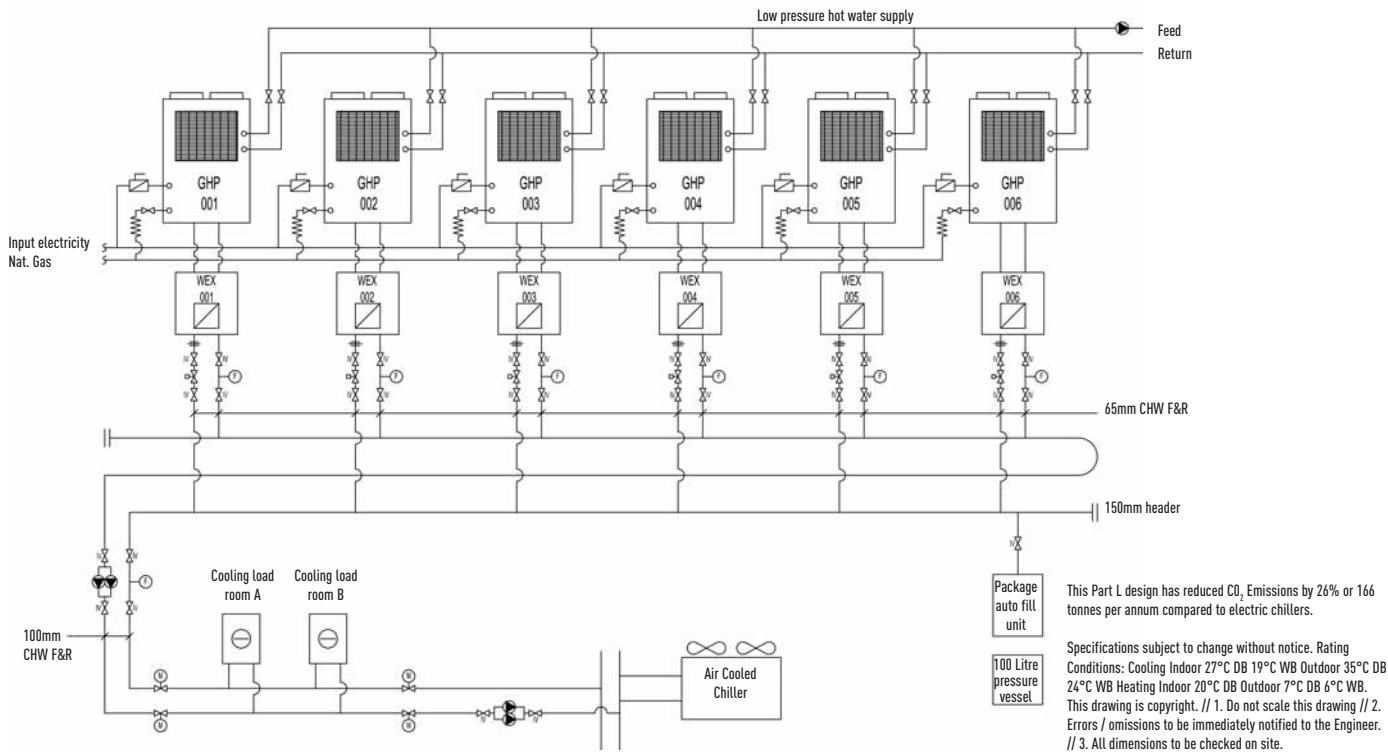

ECOi Water Heat Exchanger

Electrical VRF with Water Heat Exchanger

- With this easy to install Water Heat Exchanger unit, you can now cover projects up to 51kW hot water demand or 44kW on chilled application on a efficient way and cost effective

System example.

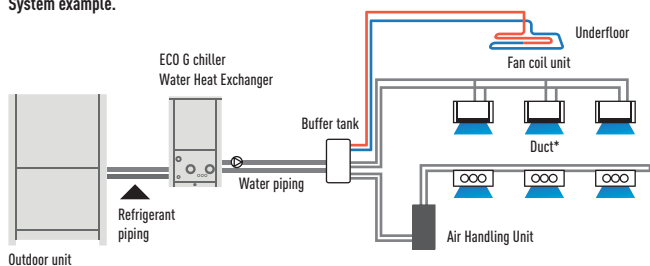

A Buffer tank of minimum 280L for 28kW and 500L for 50kW is always needed.

Example of Hotel renewal of existing Chiller and Boiler system with Panasonic ECO G and Aquarea mixed solution.

ECO G and Aquarea are the smart solution for renewal Chiller/Boiler applications with annual running cost savings around 13.600€.

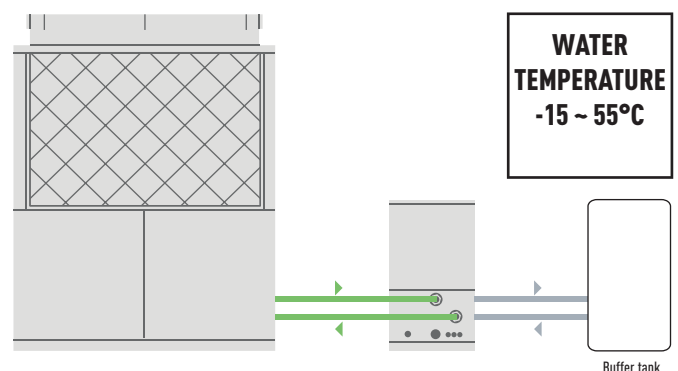

# NEW 2-PIPE ECOi WITH WATER HEAT EXCHANGER FOR CHILLED AND HOT WATER PRODUCTION



## New generation of Water Heat Exchanger (WHE) for hydronic applications

WHE for ECOi system controlled by a timer remote control CZ-RTC5B. Energy-efficient capacity control with superior external static pressure is now ready.

Availability of easy vertical stacking allows installations in a limited space (up to 3 units)\*.

Stainless steel plate heat exchanger with anti-freeze protection control. Change over between heating and cooling operation.

\* Stacking kit (PAW-3WSK) is necessary.

### Technical focus

- Heating, cooling and DHW
- A class water pump included (only in P model)
- Flexible modularity from 25kW
- Better partial load vs standard chiller system
- Compatible with all centralized controllers
- Maximum distance between outdoor unit and WHE: 170m
- Maximum hot water outlet temperature: 45°C
- Minimum chilled water outlet temperature: 5°C
- Outdoor temperature range in heating mode: -11°C to +15°C (with low temperature kit -25°C)

Hydrokit with A class water pump		PAW-250WP5G	PAW-500WP5G	
Hydrokit without pump		PAW-250W5G	PAW-500W5G	
Cooling capacity at 35°C, water outlet 7°C	kW	25,00	50,00	
Heating capacity	kW	28,00	56,00	
Heating capacity at +7°C, heating water temperature at 45°C	kW	28,00	56,00	
COP at +7°C with heating water temperature at 45°C	W/W	2,97	3,10	
<b>Heating Energy Efficiency class at 35°C<sup>1)</sup></b>		<b>A+</b>	<b>A++</b>	
η <sub>sh</sub> (LOT21) <sup>2)</sup>	%	<b>164,00</b>	<b>158,00</b>	
Dimension	H x W x D	1000 x 575 x 1110	1000 x 575 x 1110	
Net weight	kg	135 (140 with pump)	155 (165 with pump)	
Water pipe connector		Rp2 Female Thread (50A)	Rp2 Female Thread (50A)	
Heating water flow (ΔT=5 K, 35°C)	m <sup>3</sup> /h	5,16	10,32	
Capacity of integrated electric heater	kW	Not equipped	Not equipped	
Flow switch		Equipped	Equipped	
Water filter		Equipped	Equipped	
Input power	kW	0,329 (with A class water pump) / 0,024 (without pump)	0,574 (with A class water pump) / 0,024 (without pump)	
Maximum current	A	1,43 (with A class water pump) / 0,10 (without pump)	2,50 (with A class water pump) / 0,10 (without pump)	
Outdoor unit		U-100ME2E8	U-20ME2E8	
Sound pressure	dB(A)	56	60	
Dimension	H x W x D	1842 x 770 x 1000	1842 x 770 x 1000	
Net weight	kg	210	375	
Piping connections	Liquid pipe	Inch (mm)	3/8 (9,52)	5/8 (15,88)
	Gas pipe	Inch (mm)	7/8 (22,22)	1-1/8 (28,58)
Refrigerant (R410A)	kg	5,6 *Need Additional gas amount at site	9,5 *Need Additional gas amount at site	
Pipe length range / Elevation difference (in/out)	m	170 / 50 (OD above) 35 (OD below)	170 / 50 (OD above) 35 (OD below)	
Pipe length for nominal capacity	m	7,5	7,5	
Pipe length for additional gas / Additional gas amount (R410A)	m / g/m	0 < / Refer to manual	0 < / Refer to manual	
Operation range	Heat Min ~ Max	°C	-11 ~ +15 <sup>3)</sup>	-11 ~ +15 <sup>3)</sup>
Water outlet temperature range	Cool Min ~ Max	°C	+5 ~ +15	+5 ~ +15
	Heat Min ~ Max	°C	+35 ~ +45	+35 ~ +45

### Accessories

**PAW-3WSK** Stacking kit for vertical stacking (4 sets in the Kit)

1) Unit efficiency energy level: Scale from A++ to G. 2) Seasonal space cooling/heating energy efficiency following COMMISSION REGULATION (EU) 813/2013. 3) With accessory low temperature kit -25 ~ +15°C.

Performance calculation in agreement with Eurovent. Sound pressure measured at 1m from the outdoor unit and at 1,5m height.

### Stacking kit PAW-3WSK.

It is possible to stack up to 3 units. When stacking units, always anchor the bottom unit to the ground using the anchor holes.

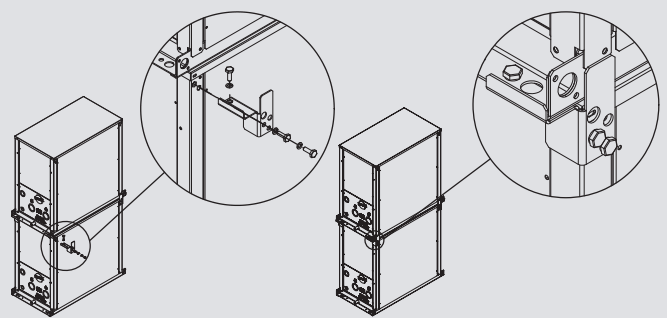

# NEW 2-PIPE ECO G WITH WATER HEAT EXCHANGER FOR CHILLED AND HOT WATER PRODUCTION

NEW  
18



## New generation of Water Heat Exchanger (WHE) for hydronic applications

WHE for ECO G system controlled by a timer remote control CZ-RTC5B. Energy-efficient capacity control with superior external static pressure is now ready.

Availability of easy vertical stacking allows installations in a limited space (up to 3 units)\*.

Stainless steel plate heat exchanger with anti-freeze protection control. Change over between heating and cooling operation.

\* Stacking kit (PAW-3WSK) is necessary.

## Technical focus

- Heating, cooling and DHW
- A class water pump included (only in P model)
- No cascade installation up to 80kW
- Free DHW from waste heat of engine
- Compatible with all centralized controllers
- Maximum distance between outdoor unit and WHE: 170m
- Hot water outlet temperatures from 35°C to 55°C
- Chilled water outlet temperatures from -15°C to +15°C
- Minimum outdoor temperature in heating mode: -21°C

Hydrokit with A class water pump			PAW-500WP5G	PAW-710WP5G
Hydrokit without pump			PAW-500W5G	PAW-710W5G
Heating capacity	kW		60,00	80,00
Heating capacity at +7°C, heating water temperature at 35°C	kW		60,90	81,20
COP at +7°C with heating water temperature at 35°C	W/W		1,15	1,18
Heating capacity at +7°C, heating water temperature at 45°C	kW		60,00	80,00
COP at +7°C with heating water temperature at 45°C	W/W		1,02	1,04
Heating capacity at -7°C, heating water temperature at 35°C	kW		48,20	50,80
COP at -7°C, heating water temperature at 35°C	W/W		0,80	0,80
Heating capacity at -15°C, heating water temperature at 35°C	kW		46,30	50,00
COP at -15°C with heating water temperature at 35°C	W/W		0,80	0,80
Refrigeration load Pdesign	kW		48,00	—
Heating Energy Efficiency class at 35°C <sup>1)</sup>			A+	—
ηsh (LOT21) <sup>2)</sup>	%		130,04	127,94
Cooling capacity	kW		—	—
Cooling capacity at +35°C, outlet temperature 7°C, inlet temperature 12°C	kW		50,00	67,00
EER at +35°C, outlet temperature 7°C, inlet temperature 12°C	W/W		0,78	0,89
Dimension	H x W x D	mm	1000 x 575 x 1110	1000 x 575 x 1110
Net weight		kg	155 (165 with pump)	160 (175 with pump)
Water pipe connector			Rp2 Female Thread (50A)	Rp2 Female Thread (50A)
Heating water flow (ΔT=5 K, 35°C)	m <sup>3</sup> /h		10,32	13,76
Capacity of integrated electric heater	kW		Not equipped	Not equipped
Flow switch			Equipped	Equipped
Water filter			Equipped	Equipped
Input power	kW		0,574 (with A class water pump) / 0,024 (without pump)	0,824 (with A class water pump) / 0,024 (without pump)
Maximum current	A		2,50 (with A class water pump) / 0,10 (without pump)	3,60 (with A class water pump) / 0,10 (without pump)
<b>Outdoor Unit</b>			<b>U-20GE3E5</b>	<b>U-30GE3E5</b>
Sound power	Normal / Silent	dB	80 / 77	84 / 81
Dimension	H x W x D	mm	2255 x 1650 x 1000	2255 x 2026 x 1000
Net weight		kg	765	880
Piping connections	Liquid pipe	Inch (mm)	5/8 (15,88)	3/4 (19,05)
	Gas pipe	Inch (mm)	1-1/8 (28,58)	1-1/4 (31,75)
Pipe length / Pipe length for nominal capacity		m	7 / 170	7 / 170
Elevation difference (in/out)		m	50 (OD above) 35 (OD below)	50 (OD above) 35 (OD below)
Operation range	Heat Min - Max	°C	-21 ~ +24 (until outlet temperature 45)	-21 ~ +24 (until outlet temperature 45)
Water outlet temperature range	Cool Min - Max	°C	-15 ~ +15	-15 ~ +15
	Heat Min - Max	°C	+35 ~ +55	+35 ~ +55

### Accessories

**PAW-3WSK** Stacking kit for vertical stacking (4 sets in the Kit)

1) Unit efficiency energy level: Scale from A++ to G. 2) Seasonal space cooling/heating energy efficiency following COMMISSION REGULATION (EU) 813/2013.

Performance calculation in agreement with Eurovent. Sound pressure measured at 1m from the outdoor unit and at 1,5m height.



# LEAK DETECTION AND AUTOMATIC REFRIGERANT PUMP DOWN



## Improving safety and the environment

Panasonic has developed an innovative solution to detect refrigerant leaks that offer complete assurance and protection for end users, building occupiers and the environment. Panasonic's Pump Down System is ideal for hotels, offices and public buildings where safety for occupants and the building owners is of utmost importance.

The system monitors refrigerant leakage continually and provides a warning before refrigerant leaks, preventing major refrigerant loss and potentially damaging the system's efficiency. The new system can improve potential refrigerant loss to approximately 90%.

As well as ensuring safe and reliable operation, Panasonic's Pump Down System contributes to a building qualifying for additional BREEAM points and enables compliance with current EN378 2008 standards, covering applications where refrigeration concentration levels exceed practical safety limits of 0,44 kg/m<sup>3</sup>.

Panasonic has developed two detection methods that can operate simultaneously to offer complete protection for owners, building occupiers and the environment.

## Pump Down system

**This innovative pump down system can be connected in two ways:**

- With sensor leakage
- Without sensor leakage, using only an innovative algorithm

### Basic pump down function:

- Detect the leakage
- Activate pump down process
- Collect the gas in the tank
- Close the valves to isolate the gas

### Key points:

- Comply with legislation
- Protect personnel
- Protect the environment
- Save on operating costs

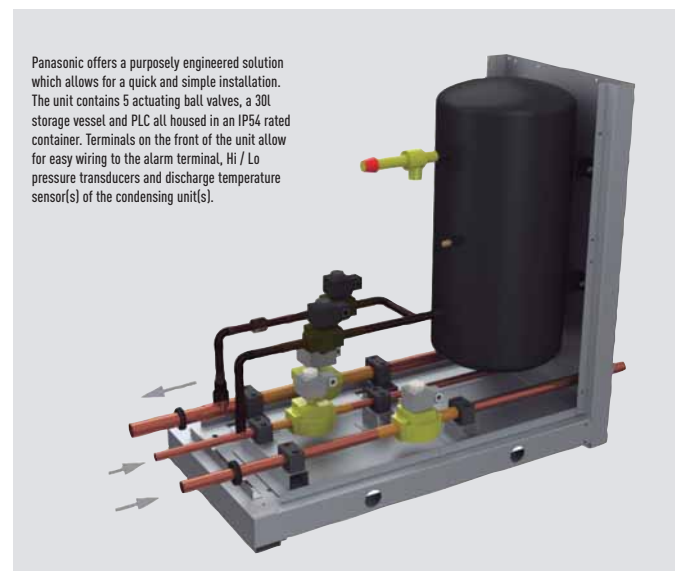

Panasonic offers a purposely engineered solution which allows for a quick and simple installation. The unit contains 5 actuating ball valves, a 30l storage vessel and PLC all housed in an IP54 rated container. Terminals on the front of the unit allow for easy wiring to the alarm terminal, Hi / Lo pressure transducers and discharge temperature sensor(s) of the condensing unit(s).

## R22 Renewal

Panasonic's advanced technology enables the system to work with previously installed pipe work by managing the working pressure within the system down to R22 (33 bar) levels, this ensures the system works safely and efficiently without loss of capacity.

The new equipment can offer increased COP/EER by using state of the art inverter compressor and heat exchanger technology.

Having contacted your Panasonic supplier regarding pipe work restrictions

and gained approval to use the Panasonic Renewal System there are three main tests that have to be carried out to ensure that the system can be used effectively. Firstly a thorough inspection of the pipe work must be carried out and any damage must be repaired. Secondly an oil test has to be carried out to ensure that the system has not been subject to a compressor burnout during its lifetime. Lastly a VRF Renewal Kit (CZ-SLK2) has to be installed within the pipe work to ensure that the system is cleaned of any remnants of oil.





# DESIGN SUPPORT SOFTWARE FOR VRF



Features the unique **Mounting Scheme** function providing more thorough spec-in and tender quotation support for easier, faster completion of work

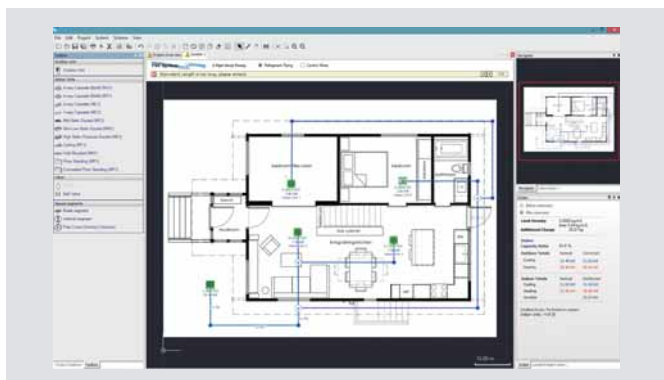

**The Panasonic VRF Designer software can be used for all Panasonic VRF ME2, LE and MF3.**

Panasonic has identified the importance of ever-increasing demands for fast and accurate responses to customer requests in our industry. More and more emphasis is being placed upon energy-efficiency in our marketplace. The ability to calculate cooling/heating loads and produce information of actual design conditions is a major advantage to any architect, consultant, contractor or end user.

Panasonic understands the time-poor and demanding industry we are in and we are pleased to announce the launch of the next generation of our system design software program.

The Panasonic VRF Designer software has been customised to make the selection and design process as quick and easy as possible.

The design package utilises system wizards and import tools to enable both simple and complex systems to be created. In addition, the system will allow outdoor and indoor units to be dragged on an interactive desktop. This allows users to create everything from realistic floor plans with detailed piping and wiring schematics to send out with quotations, through to installation guidance drawings.

## Features include:

- Mounting scheme. Design selection from building floor drawing
- Any kind of drawing format. (dxf, jpg, png..etc.)
- Conventional principal scheme
- Easy to use system wizards
- Auto piping and wiring features
- Converted duties for conditions and pipework
- Auto(CAD) (dxf), Excel and PDF export
- Detailed wiring and pipework diagrams
- Automatic price quotation
- Automatic tender document assist
- SEER, SCOP
- ESEER

**Panasonic's Advanced VRF software with AutoCAD® compatibility makes design easier than ever**

Panasonic provides bespoke software helping system designers, installers and dealers to very quickly design and size systems, create wiring diagrams and issue bills of quantities at the push of a button.



## Panasonic VRF Service Checker

Panasonic will make available to installers and commissioning companies the VRF Service Checker as a communication interface to Panasonic VRF systems. This easy to manage tool checks all parameters of the system.

### The VRF Service Checker allows:

- On ECOi and Mini ECOi connect anywhere on the P-Link
- Search the P-Link to validate systems that are connected
- Monitor all indoor and outdoor units simultaneously on 1 screen
- Monitor all Temperature data, Pressure data, Valve position, and alarm status on 1 screen
- Data can be viewed in Graph or number format
- Controlling the indoor unit ON/OFF, MODE, SET POINT, FAN, and TEST mode
- Switching between various systems on same communication P-Link (ECOi only)
- Monitor and record at a set interval time
- Record and review the data at a later date
- Update software as ROM flash writer

This Panasonic VRF Service Checker is available from your service partner.

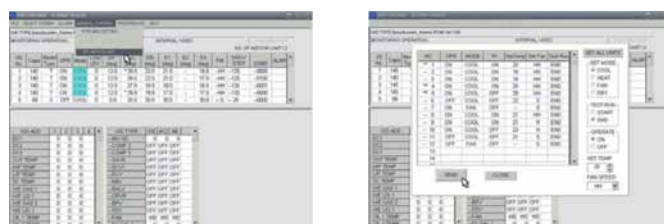





























Interface Box



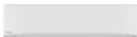



# NEW VRF SYSTEMS INDOOR UNITS





# ECOi AND ECO G SYSTEMS INDOOR UNITS RANGE

Page		1,50kW	2,20kW	2,80kW	3,00kW	3,60kW	4,00kW	4,50kW
P. 326	U2 Type 4 Way 90x90 Cassette							
			S-22MU2E5A	S-28MU2E5A		S-36MU2E5A		S-45MU2E5A
P. 328	Y2 Type 4 Way 60x60 Cassette							
		S-15MY2E5A	S-22MY2E5A	S-28MY2E5A		S-36MY2E5A		S-45MY2E5A
P. 329	L1 Type 2 Way Cassette							
			S-22ML1E5	S-28ML1E5		S-36ML1E5		S-45ML1E5
P. 330	D1 Type 1 Way Cassette							
				S-28MD1E5		S-36MD1E5		S-45MD1E5
P. 331	F2 Type Variable Static Pressure Hide Away							
		S-15MF2E5A	S-22MF2E5A	S-28MF2E5A		S-36MF2E5A		S-45MF2E5A
P. 332	M1 Type Slim Variable Static Pressure Hide Away							
		S-15MM1E5A	S-22MM1E5A	S-28MM1E5A		S-36MM1E5A		S-45MM1E5A
P. 333	E2 Type High Static Pressure Hide Away							
P. 334	Heat Recovery with DX Coil							
					PAW-500ZDX3N	PAW-800ZDX3N	PAW-01KZDX3N	
P. 335	T2 Type Ceiling							
						S-36MT2E5A		S-45MT2E5A
P. 336	K2 Type Wall Mounted							
		S-15MK2E5A	S-22MK2E5A	S-28MK2E5A		S-36MK2E5A		S-45MK2E5A
P. 337	P1 Type Floor Standing							
			S-22MP1E5	S-28MP1E5		S-36MP1E5		S-45MP1E5
P. 338	R1 Type Concealed Floor Standing							
			S-22MR1E5	S-28MR1E5		S-36MR1E5		S-45MR1E5
P. 339	Hydrokit for ECOi, water at 45°C							

Page		16,00kW	28,00kW	56,00kW	84,00kW	112,00kW	140,00kW	168,00kW
P. 344	AHU Connection Kit 16, 28 and 56kW							
		PAW-160MAH2/M/L	PAW-280MAH2/M/L	PAW-560MAH2/M/L	PAW-280MAH2/M/L + PAW-560MAH2/M/L	PAW-560MAH2/M/L x2	PAW-280MAH2/M/L + PAW-560MAH2/M/L x2	PAW-560MAH2/M/L x3

Page		250m³/h	350m³/h	500m³/h	800m³/h	1000m³/h
P. 348	Energy Recovery Ventilation					
		FY-250ZDY8R	FY-350ZDY8R	FY-500ZDY8R	FY-800ZDY8R	FY-01KZDY8R

5,60kW    6,00kW    7,30kW    9,00kW    10,60kW    14,00kW    16,00kW    22,40kW    28,00kW



S-56MU2E5A    S-60MU2E5A    S-73MU2E5A    S-90MU2E5A    S-106MU2E5A    S-140MU2E5A    S-160MU2E5A



S-56MY2E5A



S-56ML1E5



S-73ML1E5



S-56MD1E5



S-73MD1E5



S-56MF2E5A



S-60MF2E5A



S-73MF2E5A



S-90MF2E5A



S-106MF2E5A



S-140MF2E5A



S-160MF2E5A



S-56MM1E5A



S-224ME2E5



S-280ME2E5



S-56MT2E5A



S-73MT2E5A



S-106MT2E5A



S-140MT2E5A



S-56MK2E5A



S-73MK2E5A



S-106MK2E5A



S-56MP1E5



S-71MP1E5



S-56MR1E5



S-71MR1E5



S-80MW1E5



S-125MW1E5

Page

11,40kW

25,00kW

31,50kW

37,50kW

P. 346

Air Curtain Jet-Flow  
with DX Coil



PAW-10EAIRC-MJ



PAW-15EAIRC-MJ



PAW-20EAIRC-MJ



PAW-25EAIRC-MJ

P. 346

Air Curtain Standard  
with DX Coil



PAW-10EAIRC-MS



PAW-20EAIRC-MS

## U2 TYPE 4 WAY 90x90 CASSETTE

Large capacity VRF. Trusted power and high efficiency. These Cassettes offer upgraded Econavi and nanoe™ X purification systems as accessories for making application space more comfortable, healthy and efficient.

Thanks to advances in design and technology such as the new high performance turbo fan which is more efficient and silent, and nanoe™ X air purification, for total healthy and the floor temperature & humidity sensor to more control, the new U2 Panasonic 4 Way 90x90 Cassette offers healthy and comfort.

### Always fresh and clean air with nanoe™ X

New nanoe™ X is available with the advanced technology of room air conditioning.

- Purifying operation can work simultaneously or independently from heating/cooling operation.
- Inhibiting certain viruses, bacteria & deodorisation (bacteria, fungus, pollen, virus and cigarette smoke). OH radicals in nanoe™ X pull bacteria's hydrogen out to effectively deodorise and sterilise
- Clean inside by nanoe™ X + Dry control: inside of indoor unit can be cleaned by short operation circuit with nanoe™ X and drying

CZ-RTC5B and optional accessory CZ-CNEXU1 are required to use nanoe™ X function.



### Econavi intelligent sensor

Human activity sensor and floor temperature sensor can reduce waste of energy by optimising air conditioner operation.



#### Advanced Econavi functions.

2 sensors (movement and floor temperature) can find waste of energy and control effectively. Floor temperature can detect up to 5m ceiling height.

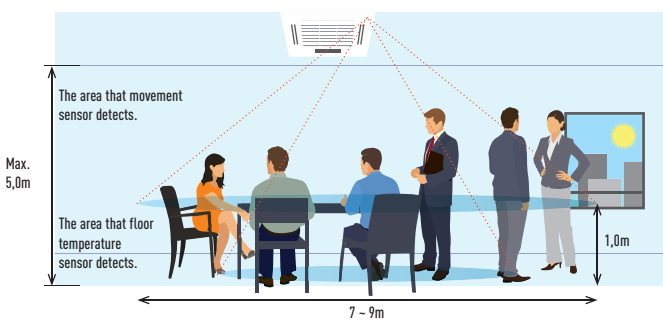

#### Econavi exclusive panel. Optional (CZ-KPU3A)



**Floor temperature sensor.**  
This sensor detects average floor temperature and operates circulation if floor temperature is low.

**Movement sensor.**  
This sensor detects the amount of human activity, and operates effectively.



Wired remote controller CZ-RTC5B is required.

### Humidity sensor.

New Humidity sensor has air suction function, and realises comfort and energy saving based on temperature and humidity.

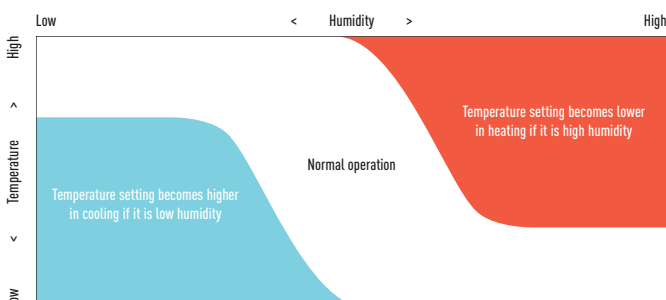

### Group control, circulation function.

Circulating operation is activated when a room is unoccupied to evenly distribute air and minimize temperature gaps in both heating and cooling operation.

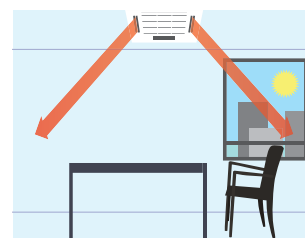

Circulation by Detecting no movement (10min.)

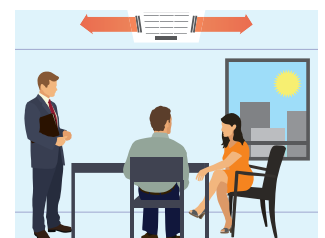

Indirect air flow by detecting movement

ECOi and ECO G Systems Indoor units



The new U2 Panasonic 4 Way 90x90 Cassettes with new panel design and 2 types of body with height difference.

2 types of body with height difference (same as current ones)  
25,6cm and 31,9cm.

Technical focus

- New high performance turbo fan, new path system for heat exchanger
- Lower noise in slow fan operation
- Ceiling height up to 5,0m
- Industry top light weight, easy piping
- Econavi: Floor temperature and humidity sensor added. Activity amount detection and new circulator
- nanoe™ X: The first 10x for CAC (10 times more purification power). Inside cleaning by 10x nanoe™ X + dry control
- Powerful drain pump gives 850mm lift
- Fresh air knockout
- Branch duct connection
- Optional air-intake plenum CZ-FDU2

Panasonic introduces a new modern flat panel design to blend into any space. These Cassettes have been developed to satisfy today's customer needs such as high energy saving, comfort and healthier air.

The drain pipe can be raised to a maximum height of 850mm from the bottom of the ceiling

Do not attempt to raise it higher than 850mm. Doing so will result in water leakage.

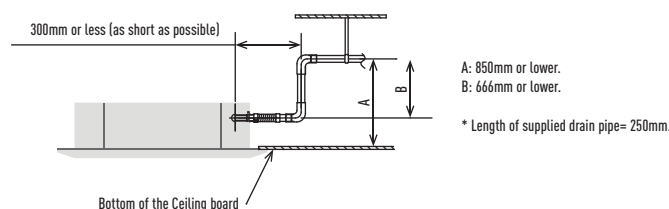

New Panel design

Flat design, well-matched with interior, building. Position of 4 air wings can be set individually.



Optional Controller. Control for hotel application PAW-RE2C3



Optional Controller. Wired remote controller CZ-RTCSB Compatible with Econavi and nanoe™ X



Optional Controller. Wireless remote controller CZ-RWS3 + CZ-RWRU3



Optional Controller. Simplified remote controller CZ-RE2C2



Optional nanoe™ X kit: CZ-CNEXU1 (CZ-RTCSB is required)

Model		S-22MU2E5A	S-28MU2E5A	S-36MU2E5A	S-45MU2E5A	S-56MU2E5A	S-60MU2E5A	S-73MU2E5A	S-90MU2E5A	S-106MU2E5A	S-140MU2E5A	S-160MU2E5A	
Cooling capacity	kW	2,20	2,80	3,60	4,50	5,60	6,00	7,30	9,00	10,60	14,00	16,00	
Input power cooling	W	20,00	20,00	20,00	20,00	25,00	35,00	40,00	40,00	95,00	100,00	115,00	
Current (cool)	A	0,19	0,19	0,19	0,19	0,22	0,31	0,33	0,36	0,71	0,76	0,89	
Heating capacity	kW	2,50	3,20	4,20	5,00	6,30	7,10	8,00	10,00	11,40	16,00	18,00	
Input power heating	W	20,00	20,00	20,00	20,00	25,00	35,00	40,00	40,00	85,00	100,00	105,00	
Current (heat)	A	0,17	0,17	0,17	0,17	0,20	0,30	0,32	0,34	0,65	0,73	0,80	
Fan type		Turbo fan	Turbo fan	Turbo fan	Turbo fan	Turbo fan	Turbo fan	Turbo fan	Turbo fan	Turbo fan	Turbo fan	Turbo fan	
Air volume	Hi/Med/Lo	m <sup>3</sup> /min	14,50/13,00/11,50	14,50/13,00/11,50	14,50/13,00/11,50	15,50/13,00/11,50	17,00/13,50/11,50	21,00/16,00/13,00	22,50/16,00/13,00	23,00/18,50/14,00	35,00/26,00/21,50	36,00/27,00/21,50	37,00/29,00/25,00
Sound pressure	Hi/Med/Lo	dB(A)	30/29/28	30/29/28	30/29/28	31/29/28	33/30/28	36/32/29	37/32/29	38/35/32	44/38/34	45/39/35	46/40/38
Sound power	Hi/Med/Lo	dB	45/44/43	45/44/43	45/44/43	46/44/43	48/45/43	51/47/44	52/47/44	53/50/47	59/53/49	60/54/50	61/55/53
Dimension	Indoor	mm	256 x 840 x 840	256 x 840 x 840	256 x 840 x 840	256 x 840 x 840	256 x 840 x 840	256 x 840 x 840	256 x 840 x 840	319 x 840 x 840	319 x 840 x 840	319 x 840 x 840	
	Panel	mm	33,5 x 950 x 950	33,5 x 950 x 950	33,5 x 950 x 950	33,5 x 950 x 950	33,5 x 950 x 950	33,5 x 950 x 950	33,5 x 950 x 950	33,5 x 950 x 950	33,5 x 950 x 950	33,5 x 950 x 950	
Net weight (Panel)		kg	21 (5)	21 (5)	21 (5)	21 (5)	21 (5)	21 (5)	21 (5)	25 (5)	25 (5)	25 (5)	
Piping	Liquid	Inch (mm)	1/4 (6,35)	1/4 (6,35)	1/4 (6,35)	1/4 (6,35)	1/4 (6,35)	3/8 (9,52)	3/8 (9,52)	3/8 (9,52)	3/8 (9,52)	3/8 (9,52)	
	Gas	Inch (mm)	1/2 (12,70)	1/2 (12,70)	1/2 (12,70)	1/2 (12,70)	1/2 (12,70)	5/8 (15,88)	5/8 (15,88)	5/8 (15,88)	5/8 (15,88)	5/8 (15,88)	

\* Sound pressure with no refrigerant flow.



ECONAVI AND INTERNET CONTROL: Optional.



Panel CZ-KPU3 (standard panel) CZ-KPU3A (Econavi exclusive panel)

Rating Conditions: Cooling Indoor 27°C DB / 19°C WB. Cooling Outdoor 35°C DB / 24°C WB. Heating Indoor 20°C DB. Heating Outdoor 7°C DB / 6°C WB. (DB: Dry Bulb; WB: Wet Bulb) Specifications subject to change without notice. For detailed information about ErP, please visit our websites www.aircon.panasonic.eu or www.gtc.panasonic.eu.

## Y2 TYPE 4 WAY 60x60 CASSETTE



Designed to fit exactly into a 600 x 600mm ceiling grid without the need to alter the bar configuration, the Y2 is ideal for small commercial and retrofit applications. In addition, the improvements to efficiency make this one of the most advanced units in the industry.

### A drain height of approximately 850mm from the ceiling surface

The drain height can be increased by approximately 350mm over the conventional value by using a high-lift drain pump, and long horizontal piping is possible.

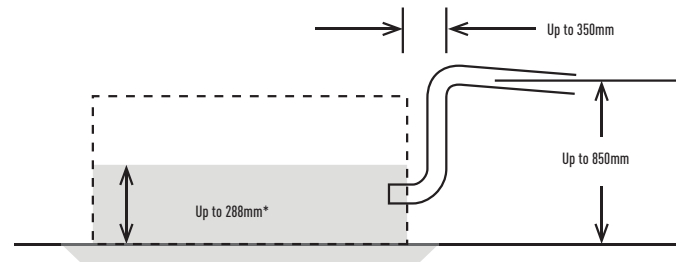

A lightweight unit at 18,4kg the unit is also very slim with a height of only 288mm, making installation possible even in narrow ceilings.

### Technical focus

- Mini Cassette fits into a 600 x 600mm ceiling grid
- Fresh air distribution
- Multidirectional airflow
- Powerful drain pump gives 850mm lift
- Turbo fans and heat exchanger fins with improved design
- DC-Fan motors with variable speed, new heat exchangers, etc. ensure an efficient power consumption



Optional Controller. Control for hotel application PAW-RE2C3



Optional Controller. Wired remote controller CZ-RTCSB Compatible with Econavi and datanavi



Optional Econavi Sensor. CZ-CENSC1



Optional Controller. Wireless remote controller CZ-RWS3



Optional Controller. Simplified remote controller CZ-RE2C2

Model		S-15MY2E5A	S-22MY2E5A	S-28MY2E5A	S-36MY2E5A	S-45MY2E5A	S-56MY2E5A
Cooling capacity	kW	1,50	2,20	2,80	3,60	4,50	5,60
Input power cooling	W	35,00	35,00	35,00	40,00	40,00	45,00
Operating current cooling	A	0,30	0,30	0,30	0,30	0,32	0,35
Heating capacity	kW	1,70	2,50	3,20	4,20	5,00	6,30
Input power heating	W	30,00	30,00	30,00	35,00	35,00	40,00
Operating current heating	A	0,25	0,25	0,30	0,30	0,30	0,30
Fan type		Centrifugal fan	Centrifugal fan	Centrifugal fan	Centrifugal fan	Centrifugal fan	Centrifugal fan
Air volume	Cool	m <sup>3</sup> /min	8,90/8,20/5,60	9,10/8,20/5,60	9,30/8,40/5,60	9,70/8,70/6,00	10,00/9,30/8,20
	Heat	m <sup>3</sup> /min	9,10/8,40/5,60	9,30/8,40/5,60	9,60/8,70/5,60	9,90/9,10/6,00	10,30/9,60/8,20
Sound pressure	Hi / Med / Lo	dB(A)	34/31/25	35/31/25	35/31/25	36/32/26	38/34/28
Sound power	Hi / Med / Lo	dB	49/46/40	50/46/40	50/46/40	51/47/41	53/49/43
Dimension (HxWxD)	Indoor	mm	288 x 583 x 583	288 x 583 x 583	288 x 583 x 583	288 x 583 x 583	288 x 583 x 583
	Panel 3A	mm	31 x 700 x 700	31 x 700 x 700	31 x 700 x 700	31 x 700 x 700	31 x 700 x 700
	Panel 3B	mm	31 x 625 x 625	31 x 625 x 625	31 x 625 x 625	31 x 625 x 625	31 x 625 x 625
Net weight		kg	20,4 (18+2,4)	20,4 (18+2,4)	20,4 (18+2,4)	20,4 (18+2,4)	20,4 (18+2,4)
Piping connections	Liquid pipe	Inch (mm)	1/4 (6,35)	1/4 (6,35)	1/4 (6,35)	1/4 (6,35)	1/4 (6,35)
	Gas pipe	Inch (mm)	1/2 (12,70)	1/2 (12,70)	1/2 (12,70)	1/2 (12,70)	1/2 (12,70)



ECONAVI and INTERNET CONTROL: Optional.



Panel CZ-KPY3AW (size 700 x 700mm) CZ-KPY3BW (size 625 x 625mm)



ECOi and ECO G Systems Indoor units

# L1 TYPE 2 WAY CASSETTE

Slim, compact and lightweight units. Remarkable size and weight reductions have been achieved by improvement of the design around the fan, the weight of all models now being 30kg.

### Technical focus

- Airflow and distribution is automatically altered depending on the operational mode of the unit
- Drain up is possible up to 500mm from the drain port
- Simple maintenance

### Simple maintenance

The drain pan is equipped with site wiring and can be removed. The fan case has a split construction, and the fan motor can be removed easily when the lower case is removed.



### Auto flap control

Airflow and distribution is automatically altered depending on the operational mode of the unit.

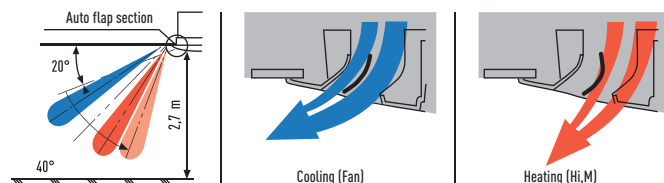

### Drain up is possible up to 500mm from the drain port

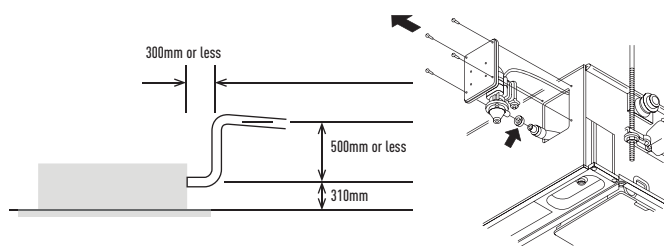

Maintenance of the drain pump is possible from two sides, from the left side (piping side) and from the inside of the unit.



Optional Controller. Control for hotel application PAW-RE2C3



Optional Controller. Wired remote controller CZ-RTCSB Compatible with Econavi and datanavi



Optional Econavi Sensor. CZ-CENSC1



Optional Controller. Wireless remote controller CZ-RWS3 + CZ-RWRL3



Optional Controller. Simplified remote controller CZ-RE2C2

Model		S-22ML1E5	S-28ML1E5	S-36ML1E5	S-45ML1E5	S-56ML1E5	S-73ML1E5
Cooling capacity	kW	2,20	2,80	3,60	4,50	5,60	7,30
Input power cooling	W	90,00	92,00	93,00	97,00	97,00	145,00
Operating current cooling	A	0,45	0,45	0,45	0,45	0,45	0,65
Heating capacity	kW	2,50	3,20	4,20	5,00	6,30	8,00
Input power heating	W	58,00	60,00	61,00	65,00	65,00	109,00
Operating current heating	A	0,29	0,29	0,29	0,29	0,29	0,48
Fan type		Sirocco fan	Sirocco fan	Sirocco fan	Sirocco fan	Sirocco fan	Sirocco fan
Air volume	Hi / Med / Lo	m <sup>3</sup> /min	8,00/7,00/6,00	9,00/8,00/7,00	9,70/8,70/7,70	11,00/9,00/8,00	19,00/16,00/14,00
Sound pressure	Hi / Med / Lo	dB(A)	30/27/24	33/29/26	34/31/28	35/33/29	38/35/33
Dimension (HxWxD)	Indoor	mm	350 x 840 x 600	350 x 840 x 600	350 x 840 x 600	350 x 840 x 600	350 x 1140 x 600
	Panel	mm	8 x 1060 x 680	8 x 1060 x 680	8 x 1060 x 680	8 x 1060 x 680	8 x 1360 x 680
Net weight (Panel)		kg	23(5,5)	23(5,5)	23(5,5)	23(5,5)	30(9)
Piping connections	Liquid pipe	Inch (mm)	1/4(6,35)	1/4(6,35)	1/4(6,35)	1/4(6,35)	3/8(9,52)
	Gas pipe	Inch (mm)	1/2(12,70)	1/2(12,70)	1/2(12,70)	1/2(12,70)	5/8(15,88)



ECONAVI and INTERNET CONTROL, Optional.



Panel CZ-02KPL2 CZ-03KPL2 (for S-73ML1E5)

# D1 TYPE 1 WAY CASSETTE



Designed for installation within the ceiling void, the D1 range of slimline 1 way blow Cassettes feature powerful yet quiet fans for up to 4,2m.

### Technical focus

- Ultra-Slim
- Suitable for standard and high ceilings
- Built-in drain pump provides 590mm lift
- Easy to install and maintain
- Hanging height can be easily adjusted
- Uses a DC-Fan motor to improve energy-efficiency

### Drain height

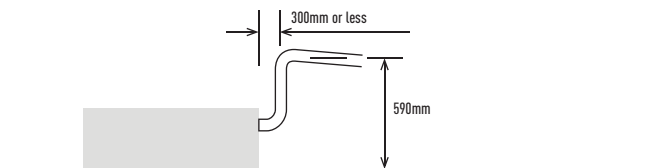

With 3 types of air-blow systems, the units can be used in various ways



**1. One-direction "down-blow" system.**  
Powerful one-direction "down-blow" system reaches the floor even from high ceilings (up to 4,2m).



**2. Two-direction ceiling-mounted system.**  
"Down-blow" and "front-blow" systems are combined in a ceiling-mounted unit to blow air over a wide area.



**3. One-direction ceiling-mounted system.**  
This powerful ceiling-mounted "front-blow" system efficiently air-conditions the space in front of the unit. (Additional accessories required)



Optional Controller. Control for hotel application PAW-RE2C3



Optional Controller. Wired remote controller CZ-RTCSB Compatible with Econavi and datanavi



Optional Econavi Sensor. CZ-CENSC1



Optional Controller. Wireless remote controller CZ-RWS3 + CZ-RWRD3



Optional Controller. Simplified remote controller CZ-RE2C2

Model		S-28MD1E5	S-36MD1E5	S-45MD1E5	S-56MD1E5	S-73MD1E5
Cooling capacity	kW	2,80	3,60	4,50	5,60	7,30
Input power cooling	W	51,00	51,00	51,00	60,00	87,00
Operating current cooling	A	0,39	0,39	0,39	0,46	0,70
Heating capacity	kW	3,20	4,20	5,00	6,30	8,00
Input power heating	W	40,00	40,00	40,00	48,00	76,00
Operating current heating	A	0,35	0,35	0,35	0,41	0,65
Fan type		Sirocco fan	Sirocco fan	Sirocco fan	Sirocco fan	Sirocco fan
Air volume	Hi / Med / Lo	m <sup>3</sup> /min	12,00/10,00/9,00	12,00/10,00/9,00	12,00/11,00/10,00	13,00/11,50/10,00
Sound pressure	Hi / Med / Lo	dB(A)	36/34/33	36/34/33	36/35/34	38/36/34
Dimension (HxWxD)	Indoor	mm	200 x 1000 x 710	200 x 1000 x 710	200 x 1000 x 710	200 x 1000 x 710
	Panel	mm	20 x 1230 x 800	20 x 1230 x 800	20 x 1230 x 800	20 x 1230 x 800
Net weight (Panel)		kg	21 (5,5)	21 (5,5)	21 (5,5)	22 (5,5)
Piping connections	Liquid pipe	Inch (mm)	1/4 (6,35)	1/4 (6,35)	1/4 (6,35)	3/8 (9,52)
	Gas pipe	Inch (mm)	1/2 (12,70)	1/2 (12,70)	1/2 (12,70)	5/8 (15,88)



ECONAVI and INTERNET CONTROL: Optional.



Panel CZ-KPD2

ECOi and ECO G Systems Indoor units

# F2 TYPE VARIABLE STATIC PRESSURE HIDE AWAY

The new F2 type is designed specifically for applications requiring fixed square ducting. The internal filter is equipped as standard.

### Technical focus

- Industry-leading low sound levels from 25dB(A)
- Built-in drain pump provides 785mm lift
- Easy to install and maintain
- Air OFF sensor avoids cold air dumping
- Configurable air temperature control

### More powerful drain pump

Using a high-lift drain pump, drain piping can be elevated up to 785mm from the base of the unit.

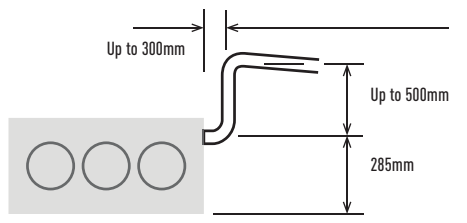

### F2 Advantages

Automatic learning function for the required static pressure, to be activated easily by the standard wired timer remote controller. Possible to increase the sensible cooling capacity by adjusting the air volume flow in order to almost completely eliminate latent losses. This is possible due to the outstanding big heat exchanger surface in combination with increasing the air volume flow by a manual selection of higher fan speed curves through the standard wired remote controller when commissioning the system together with the default active off-coil temperature control and the room load based variable evaporation temperature control.

### Diagram 1 S-22MF2E5A

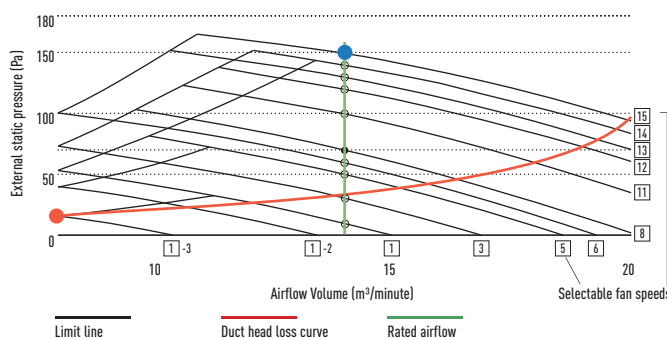

Optional Controller. Control for hotel application PAW-RE2C3



Optional Controller. Wired remote controller CZ-RTCS5B Compatible with Econavi and datanavi



Optional Econavi Sensor. CZ-CENSC1



Optional Controller. Wireless remote controller CZ-RWS3 + CZ-RWRC3



Optional Controller. Simplified remote controller CZ-RE2C2

Model	S-15MF2E5A	S-22MF2E5A	S-28MF2E5A	S-36MF2E5A	S-45MF2E5A	S-56MF2E5A	S-60MF2E5A	S-73MF2E5A	S-90MF2E5A	S-106MF2E5A	S-140MF2E5A	S-160MF2E5A	
Cooling capacity	kW	1,50	2,20	2,80	3,60	4,50	5,60	6,00	7,30	9,00	10,60	14,00	16,00
Input power cooling	W	70,00	70,00	70,00	70,00	70,00	70,00	120,00	120,00	135,00	195,00	215,00	225,00
Current (cool)	A	0,57	0,57	0,57	0,57	0,57	0,74	0,89	0,89	0,97	1,30	1,44	1,50
Heating capacity	kW	1,70	2,50	3,20	4,20	5,00	6,30	7,10	8,00	10,00	11,40	16,00	18,00
Input power heating	W	70,00	70,00	70,00	70,00	70,00	100,00	120,00	120,00	135,00	200,00	210,00	225,00
Current (heat)	A	0,57	0,57	0,57	0,57	0,57	0,74	0,89	0,89	0,97	1,34	1,42	1,50
Fan type		Sirocco fan	Sirocco fan	Sirocco fan	Sirocco fan	Sirocco fan	Sirocco fan	Sirocco fan	Sirocco fan	Sirocco fan	Sirocco fan	Sirocco fan	Sirocco fan
Air volume <sup>1</sup>	Hi / Med / Lo m³/min	14,00/13,00/9,00	14,00/13,00/9,00	14,00/13,00/9,00	14,00/13,00/9,00	14,00/13,00/10,00	16,00/15,00/12,00	21,00/19,00/15,00	21,00/19,00/15,00	25,00/23,00/19,00	32,00/26,00/21,00	34,00/29,00/23,00	36,00/32,00/25,00
External static pressure	Pa	70 (10-150)	70 (10-150)	70 (10-150)	70 (10-150)	70 (10-150)	70 (10-150)	70 (10-150)	70 (10-150)	70 (10-150)	100 (10-150)	100 (10-150)	100 (10-150)
Sound pressure <sup>2</sup>	Hi / Med / Lo dB(A)	33/29/22	33/29/22	33/29/22	33/29/22	34/32/25	34/32/25	35/32/26	35/32/26	37/34/28	38/34/31	39/35/32	40/36/33
Sound power <sup>2</sup>	Hi / Med / Lo dB	55/51/44	55/51/44	55/51/44	55/51/44	56/54/47	56/54/47	57/54/48	57/54/48	59/56/50	60/56/53	61/57/54	62/58/55
Dimension	H x W x D mm	290 x 800 x 700	290 x 800 x 700	290 x 800 x 700	290 x 800 x 700	290 x 800 x 700	290 x 800 x 700	290 x 1000 x 700	290 x 1000 x 700	290 x 1000 x 700	290 x 1400 x 700	290 x 1400 x 700	290 x 1400 x 700
Net weight	kg	29	29	29	29	29	29	34	34	34	46	46	46
Piping connections	Liquid / Gas	Inch (mm) 1/4 (6,35) / Inch (mm) 1/2 (12,70)	Inch (mm) 1/4 (6,35) / Inch (mm) 1/2 (12,70)	Inch (mm) 1/4 (6,35) / Inch (mm) 1/2 (12,70)	Inch (mm) 1/4 (6,35) / Inch (mm) 1/2 (12,70)	Inch (mm) 1/4 (6,35) / Inch (mm) 1/2 (12,70)	Inch (mm) 1/4 (6,35) / Inch (mm) 1/2 (12,70)	3/8 (9,52) / 5/8 (15,88)	3/8 (9,52) / 5/8 (15,88)	3/8 (9,52) / 5/8 (15,88)	3/8 (9,52) / 5/8 (15,88)	3/8 (9,52) / 5/8 (15,88)	3/8 (9,52) / 5/8 (15,88)

1) Value referred to standard settings at shipment (H curve 8, M curve 5, L curve 1). 2) Sound pressure without refrigerant flow.

ECONAVI 28%

FILTER INCLUDED

SELF-DIAGNOSING

AUTOMATIC FAN

HUMIDITY CONTROL

MILD DRY

AUTOMATIC RESTART

BUILT-IN DRAIN PUMP

INTERNET CONTROL

BMS CONNECTIVITY

ECONAVI and INTERNET CONTROL: Optional.

# M1 TYPE SLIM VARIABLE STATIC PRESSURE HIDE AWAY CONCEALED DUCT



The ultra slim M1 type is one of the leading products of its type in the industry. With a depth of only 200mm it provides greater flexibility and can be used in far more applications. In addition, its high-efficiency and extremely quiet sound levels make it very popular with many users, including hotels and small offices.

### Ultra-slim profile for all models

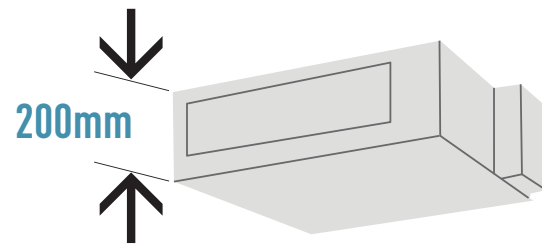

### Technical focus

- Ultra-slim profile: 200mm for all models
- DC-Fan motor greatly reduces power consumption
- Ideal for hotel application with very narrow false ceilings
- Easy maintenance and service by external electrical box
- 40Pa static pressure enables ductwork to be fitted.
- Includes drain pump

### Drain pump with increased power!

By adoption of a high-lift drain pump, the drain piping rise height can be increased to 785mm from the lower surface of the body.

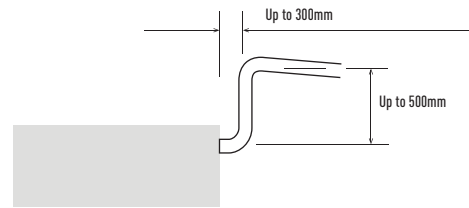

### Air Outlet & Inlet Plenum

S-...MM1E5A	Diameters	Air Outlet Plenum	Diameters	Air Inlet Plenum
22, 28 & 36	2 x Ø200	CZ-DUMPA22MMS2	2 x Ø200	CZ-DUMPA22MMR2
45 & 56	3 x Ø160	CZ-DUMPA45MMS3	2 x Ø200	CZ-DUMPA22MMR3



Optional Controller. Control for hotel application PAW-RE2C3



Optional Controller. Wired remote controller CZ-RTCSB Compatible with Econavi and datanavi



Optional Econavi Sensor. CZ-CENSC1



Optional Controller. Wireless remote controller CZ-RWS3 + CZ-RWRC3



Optional Controller. Simplified remote controller CZ-RE2C2

Model		S-15MM1E5A	S-22MM1E5A	S-28MM1E5A	S-36MM1E5A	S-45MM1E5A	S-56MM1E5A	
Cooling capacity	kW	1,50	2,20	2,80	3,60	4,50	5,60	
Input power cooling	W	36,00	36,00	40,00	42,00	49,00	64,00	
Operating current cooling	A	0,26	0,26	0,30	0,31	0,37	0,48	
Heating capacity	kW	2,80	2,50	3,20	4,20	5,00	6,30	
Input power heating	W	26,00	26,00	30,00	32,00	39,00	54,00	
Operating current heating	A	0,23	0,23	0,27	0,28	0,34	0,45	
Fan type		Sirocco fan	Sirocco fan	Sirocco fan	Sirocco fan	Sirocco fan	Sirocco fan	
Air volume	Hi / Med / Lo	m <sup>3</sup> /min	8,00/7,00/6,00	8,00/7,00/6,00	8,50/7,50/6,50	9,00/8,00/7,00	10,50/9,50/8,00	12,50/11,50/10,00
External static pressure		Pa	10(30)	10(30)	15(30)	15(40)	15(40)	
Sound pressure	Hi / Med / Lo <sup>1)</sup>	dB(A)	28/27/25 (30/29/27)	28/27/25 (30/29/27)	30/29/27 (32/31/29)	32/30/28 (34/32/30)	34/32/30 (36/34/32)	35/33/31 (37/35/32)
Sound power	Hi / Med / Lo	dB	43/42/40	43/42/40	45/44/42	47/45/43	49/47/45	50/48/46
Dimension	H x W x D	mm	200 x 750 x 640	200 x 750 x 640	200 x 750 x 640	200 x 750 x 640	200 x 750 x 640	
Net weight		kg	19	19	19	19	19	
Piping connections	Liquid pipe	Inch (mm)	1/4(6,35)	1/4(6,35)	1/4(6,35)	1/4(6,35)	1/4(6,35)	
	Gas pipe	Inch (mm)	1/2(12,70)	1/2(12,70)	1/2(12,70)	1/2(12,70)	1/2(12,70)	

1) With booster cable using short circuit connection.



ECONAVI and INTERNET CONTROL: Optional.

## E2 TYPE HIGH STATIC PRESSURE HIDE AWAY

High pressure duct and 100% Fresh air duct function. The E2 range of ducted units offers improved design flexibility for extended duct layouts as a result of their increased external static pressures and reduces energy consumption.

### Technical focus

- No need of rap valve
- 100% Fresh air duct function
- DC-Fan motor for more savings
- Complete flexibility for ductwork design
- Can be located into a weatherproof housing for external sitting
- Air OFF sensor avoids cold air dumping
- Configurable air temperature control

### System example

An inspection port (450 x 450mm or more) is required at the lower side of the indoor unit body (field supply).

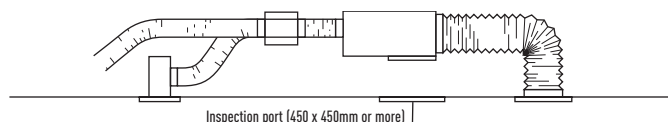

Optional Controller.  
Control for hotel  
application  
PAW-RE2C3



Optional Controller.  
Wired remote  
controller CZ-RTCS5B  
Compatible with  
Econavi and datanavi



Optional Econavi  
Sensor.  
CZ-CENSC1



Optional Controller.  
Wireless remote  
controller CZ-RWS3 +  
CZ-RWRC3



Optional Controller.  
Simplified remote  
controller CZ-RE2C2

Model	100% Fresh air duct function (by using Kit for 100% Fresh air)								High pressure duct		
	S-224ME2E5		S-280ME2E5		S-224ME2E5		S-280ME2E5				
	Cooling	Heating	Cooling	Heating	Cooling	Heating	Cooling	Heating	Cooling	Heating	
Capacity	kW	22,40	21,20	28,00	26,50	22,40	25,00	28,00	31,50		
Input power	W	290,00	290,00	350,00	350,00	440,00	440,00	715,00	715,00		
Operating current	A	1,85	1,85	2,20	2,20	2,45	2,45	3,95	3,95		
Air volume	Hi / Med / Lo	m <sup>3</sup> /min		28,30 / — / —		35,00 / — / —		56,00 / 51,00 / 44,00		72,00 / 63,00 / 53,00	
External static pressure	Pa	200		200		140 (60 - 270) <sup>1</sup>		140 (72 - 270) <sup>1</sup>			
Sound pressure <sup>2</sup>	Hi / Med / Lo	dB(A)		43 / — / —		44 / — / —		45 / 43 / 41		49 / 47 / 43	
Sound power	Hi / Med / Lo	dB		75 / — / —		76 / — / —		77 / 75 / 73		81 / 79 / 75	
Dimension	H x W x D	mm		479 x 1453 x 1205		479 x 1453 x 1205		479 x 1453 x 1205		479 x 1453 x 1205	
Net weight	kg	102		106		102		106			
Piping connections	Liquid pipe	Inch (mm)		3/8 (9,52)		3/8 (9,52)		3/8 (9,52)		3/8 (9,52)	
	Gas pipe	Inch (mm)		3/4 (19,05)		7/8 (22,22)		3/4 (19,05)		7/8 (22,22)	

Rating Conditions for 100% Fresh air duct function: Cooling Outdoor 33°C DB / 28°C WB. Heating Outdoor 0°C DB / -2,9°C WB. 1) Available to select the setting by initial setup. 2) Values with 140Pa setting. \* No filter included. No compatible with 3-Pipe ECO G GF3.



ECONAVI and INTERNET CONTROL: Optional.

Rating Conditions: Cooling Indoor 27°C DB / 19°C WB. Cooling Outdoor 35°C DB / 24°C WB. Heating Indoor 20°C DB. Heating Outdoor 7°C DB / 6°C WB. (DB: Dry Bulb; WB: Wet Bulb) Specifications subject to change without notice. For detailed information about ErP, please visit our websites [www.aircon.panasonic.eu](http://www.aircon.panasonic.eu) or [www.gtc.panasonic.eu](http://www.gtc.panasonic.eu).



### 100% Fresh air duct function

The New E2 duct with 100% fresh air duct function have exceptional discharge temperature.

	Discharge Range		
	Min	Max	Default
Cooling	15°C	24°C	18°C
Heating	17°C	45°C	40°C

### Plenums

#### Air Outlet Plenum (suitable for rigid + flexible duct)

	Number of exits with diameters	Model
S-224ME1E5A / S-280ME1E5	1 x 500mm	CZ-TREMIESPW706

### Kit for 100% Fresh air function

For 2-Pipe systems		For 3-Pipe systems	
2x CZ-P160RVK2	Rap valve kit	2x CZ-P160HR3	3-Pipe valve kit
2x CZ-CAPE2	3-Pipe control PCB	2x CZ-CAPE2	3-Pipe control PCB
CZ-P680BK2	Distribution Joint kit	CZ-P680BH2	Distribution Joint kit
1x Remote control		1x Remote control	

# HEAT RECOVERY WITH DX COIL



Motorised heat recovery by-pass device automatically controlled by unit control to use fresh air free-cooling when convenient.

- Galvanized steel self-supporting panels, internally and externally insulated
- Counterflow air-to-air heat recovery device, made of sheets of special paper with special sealing to keep airflows separate and only permeable to water vapour. Total heat exchange with temperature efficiency up to 70% and enthalpy efficiency up to 67%, also at high level during summer season
- G4 efficiency class filters with synthetic cleanable media, both on fresh air and return air intake
- Removable side panel to access filters and heat recovery in the event of scheduled maintenance
- Low consumption, high efficiency & low noise direct driven fans
- Supply section complete with DX Coil (R410A) fitted with solenoid control valve, freon filter, contact temperature sensors on liquid and gas line, NTC sensors upstream and downstream airflow
- Built-in electric box equipped with PCB to control internal fan speed and to interconnect outdoor/indoor units
- Duct connection by circular plastic collars
- CZ-RTC5B Timer remote controller (option)

## Balanced Ventilation

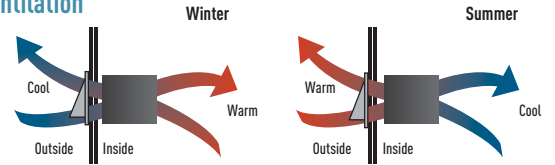

## Interconnection to outdoor/indoor units

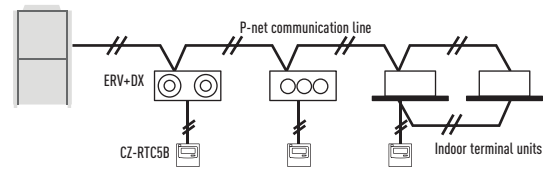

## Characteristic curves

The following curves show the unit external static pressure at maximum fan speed for each model.

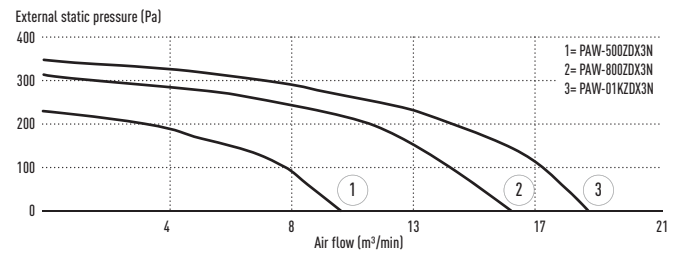

Model	PAW-500ZDX3N		PAW-800ZDX3N		PAW-01KZDX3N		
Power source	Voltage	V	230	230	230	230	
	Phase		Single Phase	Single Phase	Single Phase	Single Phase	
	Frequency	Hz	50	50	50	50	
Air volume		m³/min	8,33	13,33	16,66	16,66	
External static pressure <sup>1</sup>		Pa	90	120	115	115	
Maximum current	Total full load	A	0,6	1,4	2,1	2,1	
Input power		W	150	320	390	390	
Sound pressure <sup>2</sup>		dB(A)	39	42	43	43	
Piping connections	Liquid / Gas pipe	Inch (mm)	1/4(6,35) / 1/2(12,70)	1/4(6,35) / 1/2(12,70)	1/4(6,35) / 1/2(12,70)	1/4(6,35) / 1/2(12,70)	
<b>Heat recovery</b>			<b>Cooling</b>	<b>Heating</b>	<b>Cooling</b>	<b>Heating</b>	
Temperature efficiency	%		76	76	76	76	
Enthalpy efficiency	%		63	67	63	62	
Saved power summer mode or winter mode*	kW		1,70	4,30(4,80)	2,50	6,50(7,30)	3,20
<b>DX Coil</b>							
Total / Sensible capacity	kW		3,00/2,10	2,50/2,70	5,10/3,50	4,40/4,80	5,80/4,10
Off temperature	°C		15,9	30,1(29,2)	17,9	27,5(26,5)	18,6
Off relative humidity	%		90	16(15)	90	14(13)	89

Nominal summer conditions: Outside air: 32°C DB, RH 50%. Ambient air: 26°C DB, RH 50%. Nominal winter conditions: Outside air: -5°C DB, RH 80%. Ambient air: 20°C DB, RH 50%. Cooling mode air inlet condition: 28,5°C DB, RH 50%; evaporating temperature 7°C. Heating mode air inlet condition: 13°C DB, RH 40% (11°C DB, RH 45%); condensating temperature 40°C. DB: Dry Bulb; RH: Relative Humidity.

1) Referred to the nominal air flow after filter and plate heat exchanger. 2) Sound pressure level calculated at 1m far from: ducted supply exhaust air ducted return - first air intake / service side, at normal condition. \* Tentative data.



ECONAVI and INTERNET CONTROL: Optional.

ECOi and ECO G Systems Indoor units

## T2 TYPE CEILING

The T2 TYPE ceiling mounted units feature a DC-Fan motor for increased efficiency and reduced operating sound levels. All the units are the same height and depth for a uniform appearance in mixed installations and feature a fresh air knockout for improved air quality.

### Technical focus

- Low sound levels
- New design, all units just 235mm high
- Large and wide air distribution
- Easy to install and maintain
- Fresh air knockout

### Further comfort improvement

The wide air discharge opening widens the airflow to the left and the right, so that a comfortable temperature is obtained in the entire room. The unpleasant feeling caused when the airflow directly hits the human body is prevented by the "Draft prevention position", which changes the swing width, so that the degree of comfort is increased.

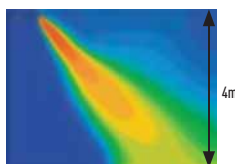

### Further comfort improvement with airflow distribution

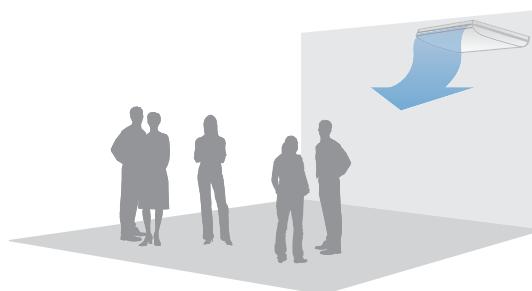

### Air distribution is automatically altered depending on the operational mode

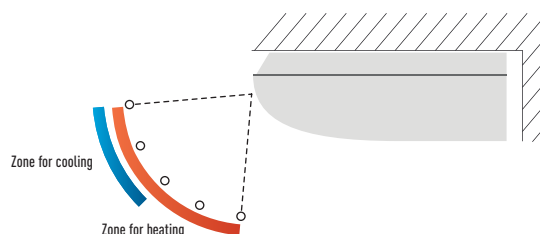

Optional Controller. Control for hotel application PAW-RE2C3



Optional Controller. Wired remote controller CZ-RTCS5B Compatible with Econavi and datanavi



Optional Econavi Sensor. CZ-CENSC1



Optional Controller. Wireless remote controller CZ-RWS3 + CZ-RWRT3



Optional Controller. Simplified remote controller CZ-RE2C2

Model		S-36MT2E5A	S-45MT2E5A	S-56MT2E5A	S-73MT2E5A	S-106MT2E5A	S-140MT2E5A	
Cooling capacity	kW	3,60	4,50	5,60	7,30	10,60	14,00	
Input power cooling	W	35,00	40,00	40,00	55,00	80,00	100,00	
Operating current cooling	A	0,36	0,38	0,38	0,44	0,67	0,79	
Heating capacity	kW	4,20	5,00	6,30	8,00	11,40	16,00	
Input power heating	W	35,00	40,00	40,00	55,00	80,00	100,00	
Operating current heating	A	0,36	0,38	0,38	0,44	0,67	0,79	
Fan type		Sirocco fan	Sirocco fan	Sirocco fan	Sirocco fan	Sirocco fan	Sirocco fan	
Air volume	Hi / Med / Lo	m <sup>3</sup> /min	14,00/12,00/10,50	15,00/12,50/10,50	15,00/12,50/10,50	21,00/18,00/15,50	30,00/25,00/23,00	32,00/28,00/24,00
Sound pressure	Hi / Med / Lo	dB(A)	36/32/30	37/33/30	37/33/30	39/35/33	42/37/36	46/40/37
Sound power	Hi / Med / Lo	dB	54/50/48	55/51/48	55/51/48	57/53/51	60/55/54	62/58/55
Dimension	H x W x D	mm	235 x 960 x 690	235 x 960 x 690	235 x 960 x 690	235 x 1275 x 690	235 x 1590 x 690	235 x 1590 x 690
Net weight		kg	27	27	27	33	40	40
Piping connections	Liquid pipe	Inch (mm)	1/4(6,35)	1/4(6,35)	1/4(6,35)	3/8(9,52)	3/8(9,52)	3/8(9,52)
	Gas pipe	Inch (mm)	1/2(12,70)	1/2(12,70)	1/2(12,70)	5/8(15,88)	5/8(15,88)	5/8(15,88)

\* Tentative data.



ECONAVI and INTERNET CONTROL. Optional.

## K2 TYPE WALL MOUNTED

The Wall mounted unit has a stylish smooth panel that looks good and easy to clean. The unit is also smaller, lighter and substantially quieter than previous models making it ideal for small offices and other commercial applications.

### Technical focus

- Closed discharge port
- Lighter and smaller units make the installation easy
- Quiet operation
- Smooth and durable design
- Piping outlet in three directions
- Air distribution is automatically altered depending on the operational mode

### Closed discharge port

When the unit is turned OFF, the flap closes completely to prevent entry of dust into the unit and to keep the equipment clean. Lighter and smaller units make the installation easy. The width has been decreased by 17% and the units are lighter.

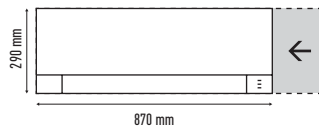

Air distribution is automatically altered depending on the operational mode of the unit

### Quiet operation

These units are among the quietest in the industry, making them ideal for hotels and hospitals.

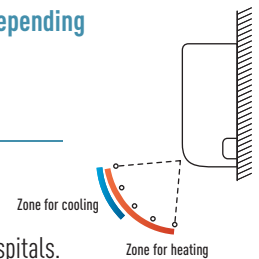

### Smooth and durable design

The smooth cover means these units match most modern interiors. Their compact size enables them to blend in, even in small spaces.

### Piping outlet in six directions

Piping outlet is possible in the six directions of right, right rear, right bottom, left, left rear and left bottom, making the installation work easier.



### External valve (Optional)

CZ-P56SVK2 (model sizes 15 to 56)  
CZ-P160SVK2 (model sizes 73 to 106)



Model		S-15MK2E5A	S-22MK2E5A	S-28MK2E5A	S-36MK2E5A	S-45MK2E5A	S-56MK2E5A	S-73MK2E5A	S-106MK2E5A	
Cooling capacity	kW	1,50	2,20	2,80	3,60	4,50	5,60	7,30	10,60	
Input power cooling	W	25,00	25,00	25,00	30,00	30,00	35,00	55,00	80,00	
Operating current cooling	A	0,20	0,21	0,23	0,25	0,32	0,35	0,51	0,70	
Heating capacity	kW	1,70	2,50	3,20	4,20	5,00	6,30	8,00	11,40	
Input power heating	W	25,00	25,00	25,00	30,00	30,00	35,00	55,00	80,00	
Operating current heating	A	0,20	0,21	0,23	0,25	0,32	0,35	0,51	0,70	
Fan type		Cross flow	Cross flow	Cross flow	Cross flow	Cross flow	Cross flow	Cross flow	Cross flow	
Air volume	Cool	m <sup>3</sup> /min	7,90/7,40/6,50	9,00/7,50/6,50	9,50/8,30/6,50	10,90/9,00/6,50	14,50/12,50/10,00	16,00/14,00/12,00	19,50/17,00/14,00	21,50/18,50/15,00
	Hi / Med / Lo		9,00/7,70/6,80	9,20/8,30/6,80	9,70/8,50/6,80	11,20/9,50/6,80	14,50/12,50/10,00	16,00/14,00/12,00	19,50/17,00/14,00	21,50/18,50/15,00
Sound pressure	Hi / Med / Lo	dB(A)	34/32/29	36/33/29	37/34/29	40/36/29	38/35/33	40/37/35	47/44/40	49/46/42
Sound power	Hi / Med / Lo	dB	49/47/44	51/48/44	52/49/44	55/51/44	53/50/48	55/52/50	62/59/55	64/61/57
Dimension	H x W x D	mm	290 x 870 x 214	290 x 870 x 214	290 x 870 x 214	290 x 870 x 214	302 x 1120 x 236	302 x 1120 x 236	302 x 1120 x 236	302 x 1120 x 236
Net weight		kg	9	9	9	9	13	13	14	14
Piping connections	Liquid pipe	Inch (mm)	1/4(6,35)	1/4(6,35)	1/4(6,35)	1/4(6,35)	1/4(6,35)	3/8(9,52)	3/8(9,52)	
	Gas pipe	Inch (mm)	1/2(12,70)	1/2(12,70)	1/2(12,70)	1/2(12,70)	1/2(12,70)	5/8(15,88)	5/8(15,88)	



ECONAVI and INTERNET CONTROL: Optional.



ECOi and ECO G Systems Indoor units

# P1 TYPE FLOOR STANDING

The compact floor standing P1 units are the ideal solution for providing perimeter air conditioning. The standard wired controller can be incorporated into the body of the unit.

### Technical focus

- Pipes can be connected to either side of the unit from the bottom or rear
- Easy to install
- Front panel opens fully for easy maintenance
- Removable air discharge grille gives flexible airflow
- Room for condensate pump
- For build-in remote control, only CZ-RTC2 is suitable



### Effective perimeter handling

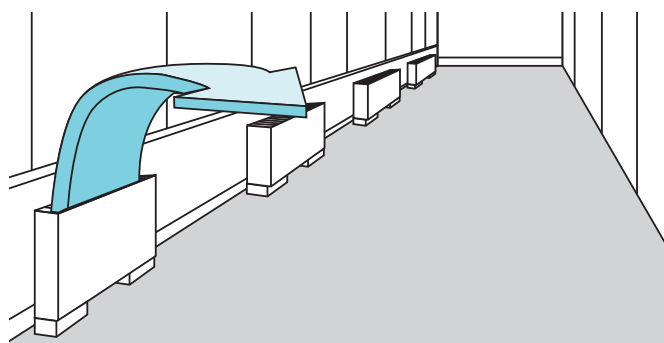

### Effective perimeter handling



Model		S-22MP1E5	S-28MP1E5	S-36MP1E5	S-45MP1E5	S-56MP1E5	S-71MP1E5	
Cooling capacity	kW	2,20	2,80	3,60	4,50	5,60	7,10	
Input power cooling	W	56,00	56,00	85,00	126,00	126,00	160,00	
Operating current cooling	A	0,25	0,25	0,38	0,56	0,56	0,72	
Heating capacity	kW	2,50	3,20	4,20	5,00	6,30	8,00	
Input power heating	W	40,00	40,00	70,00	91,00	91,00	120,00	
Operating current heating	A	0,18	0,18	0,31	0,41	0,41	0,54	
Fan type		Sirocco fan	Sirocco fan	Sirocco fan	Sirocco fan	Sirocco fan	Sirocco fan	
Air volume	Hi / Med / Lo	m <sup>3</sup> /min	7,00/6,00/5,00	7,00/6,00/5,00	9,00/7,00/6,00	12,00/9,00/8,00	15,00/13,00/11,00	17,00/14,00/12,00
Sound pressure	Hi / Med / Lo	dB(A)	33/30/28	33/30/28	39/35/29	38/35/31	39/36/31	41/38/35
Dimension	H x W x D	mm	615 x 1065 x 230	615 x 1065 x 230	615 x 1065 x 230	615 x 1380 x 230	615 x 1380 x 230	
Net weight		kg	29	29	29	39	39	
Piping connections	Liquid pipe	Inch [mm]	1/4 [6,35]	1/4 [6,35]	1/4 [6,35]	1/4 [6,35]	3/8 [9,52]	
	Gas pipe	Inch [mm]	1/2 [12,70]	1/2 [12,70]	1/2 [12,70]	1/2 [12,70]	5/8 [15,88]	



ECONAVI and INTERNET CONTROL: Optional.

Rating Conditions: Cooling Indoor 27°C DB / 19°C WB. Cooling Outdoor 35°C DB / 24°C WB. Heating Indoor 20°C DB. Heating Outdoor 7°C DB / 6°C WB. (DB: Dry Bulb; WB: Wet Bulb) Specifications subject to change without notice. For detailed information about ErP, please visit our websites www.aircon.panasonic.eu or www.ptc.panasonic.eu.

# R1 TYPE CONCEALED FLOOR STANDING



At just 229mm deep, the R1 unit can be easily concealed in perimeter areas to provide powerful and effective air conditioning.

## Perimeter air conditioning with high interior quality

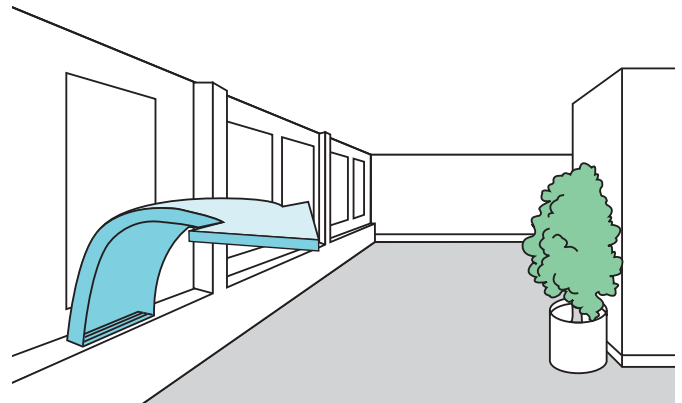

### Technical focus

- Chassis unit for discreet installation
- Complete with removable filters
- Pipes can be connected to either side of the unit from the bottom or rear
- Easy to install



Optional Controller. Control for hotel application PAW-RE2C3



Optional Controller Timer remote controller CZ-RTC2



Optional Controller. Wired remote controller CZ-RTC5B Compatible with Econavi and datanavi



Optional Econavi Sensor. CZ-CENSC1



Optional Controller. Wireless remote controller CZ-RWS3 + CZ-RWRC3



Optional Controller. Simplified remote controller CZ-RE2C2

Model		S-22MR1E5	S-28MR1E5	S-36MR1E5	S-45MR1E5	S-56MR1E5	S-71MR1E5
Cooling capacity	kW	2,20	2,80	3,60	4,50	5,60	7,10
Input power cooling	W	56,00	56,00	85,00	126,00	126,00	160,00
Operating current cooling	A	0,25	0,25	0,38	0,56	0,56	0,72
Heating capacity	kW	2,50	3,20	4,20	5,00	6,30	8,00
Input power heating	W	40,00	40,00	70,00	91,00	91,00	120,00
Operating current heating	A	0,18	0,18	0,31	0,41	0,41	0,54
Fan type		Sirocco fan	Sirocco fan	Sirocco fan	Sirocco fan	Sirocco fan	Sirocco fan
Air volume	Hi / Med / Lo	m <sup>3</sup> /min 7,00/6,00/5,00	7,00/6,00/5,00	9,00/7,00/6,00	12,00/9,00/8,00	15,00/13,00/11,00	17,00/14,00/12,00
Sound pressure	Hi / Med / Lo	dB(A) 33/30/28	33/30/28	39/35/29	38/35/31	39/36/31	41/38/35
Dimension	H x W x D	mm 616 x 904 x 229	616 x 904 x 229	616 x 904 x 229	616 x 1219 x 229	616 x 1219 x 229	616 x 1219 x 229
Net weight	kg	21	21	21	28	28	28
Piping connections	Liquid pipe	Inch (mm) 1/4 (6,35)	1/4 (6,35)	1/4 (6,35)	1/4 (6,35)	1/4 (6,35)	3/8 (9,52)
	Gas pipe	Inch (mm) 1/2 (12,70)	1/2 (12,70)	1/2 (12,70)	1/2 (12,70)	1/2 (12,70)	5/8 (15,88)



ECONAVI and INTERNET CONTROL: Optional.

## HYDROKIT FOR ECOi WATER AT 45°C



Connect the Hydrokit to your VRF system, together with other indoor units.

### Basic principle & advantage

Hydrokit module provides hot water by using waste heat that is recovered from standard air-conditioning indoor unit in cooling mode. Total system performs high energy efficiency by this heat recovering operation, and it gives an advantage for sustainability related assessment methods, such as BREEAM in UK.

### Hydrokit control function / CZ-RTC5B

- CZ-RTC5B is updated version from CZ-RTC3. It can be used for hydrokit and also normal indoor unit. CZ-RTC5B checks the type of connected unit and switch hydrokit or air conditioner style of display automatically
- Operating mode on hydrokit style to be set at initial setting of the system from following modes: tank mode or air conditioning mode

### Technical focus

- Only with 3-Pipe ECOi EX MF3 Series outdoor units
- Remote controller CZ-RTC5B common use with DX Coil indoor units ECOi and PACi

### Overview: hydromodule in VRF system

- Multiple hydromodule connection in same circuit is available
- Each module can be set different operation mode either hot water supply mode or space heating mode (both operation modes are not able to set at 1 hydromodule)
- 3-Pipe control solenoid valve kit is necessary for each indoor unit and hydromodule

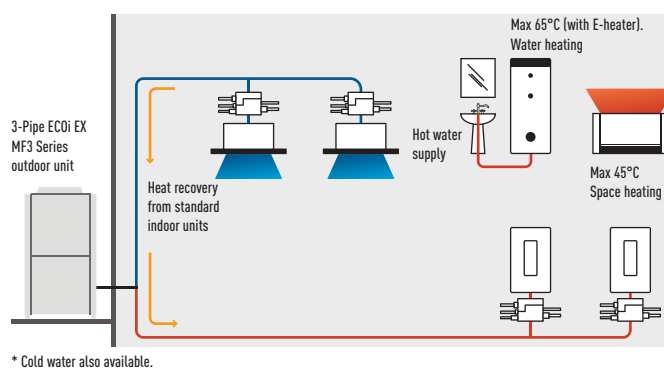

Optional Controller.  
Control for hotel  
application  
PAW-RE2C3



Optional Controller.  
Wired remote  
controller CZ-RTC5B  
Compatible with  
Econavi and datanavi



Optional Econavi  
Sensor.  
CZ-CENSC1

Model*	S-80MW1E5			S-125MW1E5		
Power source	230V / Single Phase / 50 Hz			230V / Single Phase / 50 Hz		
Cooling capacity	kW	8,00		12,50		
Heating capacity	kW	9,00		14,00		
Maximum temperature	°C	~45 / ~65 <sup>1</sup>		~45 / ~65 <sup>1</sup>		
Dimension	H x W x D	mm		892 x 502 x 353		
Water pipe connector	Inch	R 1 ¼		R 1 ¼		
Water pump (built-in)		DC motor (A class)		DC motor (A class)		
Water flow rate	Cool	L/min	22,90	35,80		
	Heat	L/min	25,80	40,10		
Piping connections	Liquid pipe	Inch (mm)	3/8(9,52)	3/8(9,52)		
	Gas pipe	Inch (mm)	5/8(15,88)	5/8(15,88)		
	Drain piping		15 ~ 17mm (inner size)	15 ~ 17mm (inner size)		
Operation range	Cool	Ambient / Water	°C	+10 ~ +43 / +5 ~ +20		
	Heat	Ambient / Water	°C	-20 ~ +32 / +25 ~ +45		
Connectable system	3-Pipe (heat recovery type) VRF system (system capable up to 48HP)					
Maximum Indoor ratio (connectable hydrokit module capacity ratio)	Total indoor unit + Hydrokit capacity: up to 130% (** ~ **% vs total outdoor unit capacity)					

1) Max 45°C by refrigerant circuit (heat pump cycle), over 45°C is provided by electric heater operation. \* Tentative Data.



ECONAVI: Optional.

# AQUAREA AIR RADIATORS. FAN COILS FOR HEAT PUMP APPLICATION

AQUAREA  
AIR



## New line up of Super low temperature radiators for Heat Pump application: Aquarea Air 200/700/900 with radiating effect

The slimline Panasonic Aquarea Air radiators deliver high efficiency climate control.

With a depth of just under 13cm they are at the cutting edge of the market. Blending easily into the home, Aquarea Air's elegant design and product refinements are clear to see in every detail. Exceptional ventilation efficiency means the motor uses considerably less energy (low wattage). The fan speed is continuously modulated by the temperature controller with proportional integral logic, with undoubted advantages for regulating the temperature and humidity in summer mode.



With standard cast radiators.

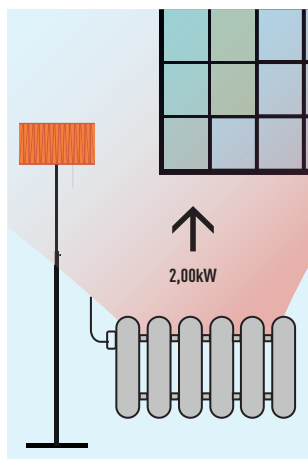

Water at 65°C needed.

With Aquarea Air.

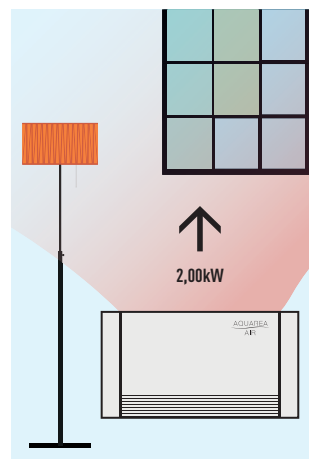

Water at 35°C needed.

### Technical focus:

- Front panel heating with radiant effect
- High heating capacity (without main fan running)
- 4 fan speeds and capacities
- Exclusive design
- Extremely compact (only 12,9cm deep)
- Cooling and dehumidification functions possible (drain is needed)
- 3-way valve included (no overflow valve needed on the installation if more than 3 radiators installed)
- Touch screen thermostat

All temperature curves and capacity are available on [www.panasonicproclub.com](http://www.panasonicproclub.com)

Fan Coils for Heat Pump application		PAW-AAIR-200-1					PAW-AAIR-700-1					PAW-AAIR-900-1				
Total heating capacity	W	138,00	160,00	217,00	470,00	570,00	223,00	360,00	708,00	1032,00	1188,00	273,00	475,00	886,00	1420,00	1703,00
Water flow	kg/h	23,70	27,50	37,30	80,80	98,00	38,40	61,90	121,80	177,50	204,30	47,00	81,70	152,40	244,20	292,90
Water pressure drop	kPa	0,10	0,20	0,40	2,00	2,90	0,10	0,10	0,30	0,80	1,00	0,10	0,20	0,50	1,60	2,20
	m <sup>3</sup> /min	0,50	0,60	0,90	1,90	2,70	0,70	1,40	2,60	4,20	5,30	0,90	1,80	4,10	6,10	7,70
Air flow	Speed	Main	Super	Min	Med	Max	Main	Super	Min	Med	Max	Main	Super	Min	Med	Max
		Fan Off	Min				Fan Off	Min				Fan Off	Min			
Maximum input power	W	2,00	5,00	7,00	9,00	13,00	3,00	9,00	14,00	18,00	22,00	3,00	11,00	16,00	20,00	24,00
Sound pressure	dB(A)	17,60	18,80	24,70	33,20	39,40	18,40	19,60	25,80	34,10	40,20	18,40	22,30	26,20	34,40	42,20
Inlet water temperature	°C	35	35	35	35	35	35	35	35	35	35	35	35	35	35	35
Outlet water temperature	°C	30	30	30	30	30	30	30	30	30	30	30	30	30	30	30
Inlet air temperature	°C	19	19	19	19	19	19	19	19	19	19	19	19	19	19	19
Outlet air temperature	°C	34,50	32,60	38,90	32,00	30,00	34,90	32,40	33,30	31,80	30,60	34,80	32,50	30,20	31,10	30,60
Dimension (H x W x D)	mm	579 x 735 x 129					579 x 935 x 129					579 x 1135 x 129				
Net weight	kg	17					20					23				
3 ways valve included		Yes					Yes					Yes				
Touch screen thermostat		Yes					Yes					Yes				

## NEW VERSATILE AND EFFICIENT FAN COIL RANGE. FAN COIL COMPATIBLE WITH AQUAREA AND VRF SYSTEMS

NEW  
18

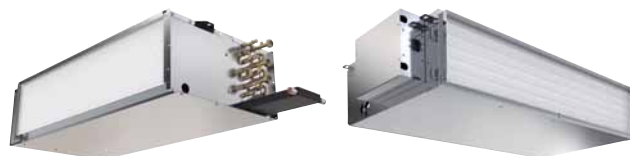

### New range of Fan Coil units

Easy to install, improvement in sounds levels and performances, are the key developments carried on our Fan Coil units. The Fan Coil is issued from that development striving to meet customers' wishes and advices.

New Fan Coil range consist on one compact ducted range ideal for residential and commercial use and one model with high static pressure for commercial applications. The range certified by Eurovent includes drain pan and filter and are equipped with a low consumption fan motor. Easy maintenance and access.

### 1 Innovation for an optimum comfort

New range of Fan Coil for heating and cooling with 6 capacities from 2,4 to 14,80kW in cooling and from 3,0 to 19,90kW in heating. It can bring full year comfort together with an Aquarea system or VRF systems.

### 2 Low energy consumption fan

5 Speed level. The units are fitted with a fan-motor assembly of which the fan is composed of double inlet forward curved centrifugal wheel dynamically balanced and specially designed for an optimal air flow.

### 3 Quality and efficient Coil

Made of staggered copper tubes, mechanically expanded into aluminium fins, assuring maximum heat transfer efficiency. Equipped with a main chilled water coil with 3 rows.

### 4 Easy and flexible installation

- Suction G2 air filter from both sides and for the bottom
- Includes drain pan

Model	Compact units							High Static Pressure
			PAW-FC-D24	PAW-FC-D40	PAW-FC-D55	PAW-FC-D65	PAW-FC-D90	PAW-FC-H150
Total Cooling capacity	Med / S-Hi	kW	2,00/2,40	3,10/4,10	4,20/5,50	5,80/6,60	6,70/9,10	11,90/14,80
Sensible cooling	Med / S-Hi	kW	1,70/2,10	2,20/3,00	3,00/4,00	4,30/5,00	4,90/7,00	9,60/12,90
Heating capacity	Med / S-Hi	kW	2,40/3,00	3,90/5,40	4,00/5,30	7,40/8,70	9,30/12,60	14,90/19,90
Power consumption	S-Lo / Med / S-Hi	W	24/50/81	33/57/86	39/76/112	60/114/161	90/112/188	180/421/675
Fuse rating		A	2,00	2,00	2,00	2,00	2,00	3,17
Dimensions	H x W x D	mm	220 x 624 x 430	220 x 994 x 430	220 x 1179 x 430	220 x 994 x 530	220 x 1250 x 530	356 x 1380 x 798
Dimensions (including pan and electrical box)	H x W x D	mm	220 x 862 x 430	220 x 1232 x 430	220 x 1417 x 430	220 x 1232 x 530	220 x 1463 x 530	356 x 1600 x 798
Weight (without water content)		kg	15,5	24	28	29	43	63
Sound power global	S-Lo / Med / S-Hi	dB(A)	31/45/53	36/48/57	40/52/58	46/59/63	52/57/66	52/64/71
Static pressure	Max	Pa	50	70	70	70	70	110
Airflow <sup>1</sup>	Med / S-Hi	m <sup>3</sup> /h	388/483	486/716	640/933	989/1064	936/1397	2112/3176
Water pressure drop	Med / S-Hi	kPa	9,9/14,3	13,0/22,4	25,2/42,2	13,9/17,9	22,6/40,3	19,8/26,1
Fan speeds			3 speeds	3 speeds	3 speeds	3 speeds	3 speeds	3 speeds
Fan motor and total speeds			AC 5 speeds	AC 5 speeds	AC 5 speeds	AC 5 speeds	AC 5 speeds	AC 5 speeds
Drain pan			Included	Included	Included	Included	Included	Included
Air filter			Included	Included	Included	Included	Included	Included
Water connections		Inch	1/2	1/2	1/2	1/2 (1/4 cooling)	1/2	1

<sup>1</sup>) Airflow at 0Pa of static pressure.

Performances based on: Summer air 27°C /19°C (wet Bulb and chilled water 7/12°C - Winter air 20°C, entering water temperature 50°C.

# PANASONIC VENTILATION SOLUTIONS



For maximum savings and easy integration.

**AHU connection kit 16kW, 28kW and 56kW**

AHU connection kit contains: IP65 box with PCBs and terminal connections mounted inside, expansion valve and sensors.

Heat exchanger, fan & fan motor to be mounted in the AHU itself shall be provided in the field.

Application: Hotels, offices, server rooms or all large buildings where air quality control such as humidity control and fresh air and is needed.



**AHU Kit combines air conditioning and fresh air in just one solution.**

New AHU Kits connect ECOi systems to air handling unit systems, using the same refrigerant circuit as the VRF system. Large connectivity possibilities mean the Panasonic AHU Kit can be easily integrated.

**3 types of AHU Kit: Deluxe, Medium and Light.**

Model Code	IP 65	0-10V demand control*	Outdoor temperature shift compensation. Cold draft prevention
PAW-160MAH2 / PAW-280MAH2 / PAW-560MAH2	Yes	Yes	Yes
PAW-160MAH2M / PAW-280MAH2M / PAW-560MAH2M	Yes	Yes	No
PAW-160MAH2L / PAW-280MAH2L / PAW-560MAH2L	Yes	No	No

\* With CZ-CAPBC2.

**Heat Recovery With DX Coil**

**Motorised heat recovery by-pass device automatically controlled by unit control to use fresh air free-cooling when convenient.**



- Galvanized steel self-supporting panels, internally and externally insulated
- Counterflow air-to-air heat recovery device, made of sheets of special paper with special sealing to keep airflows separate and only permeable to water vapour. Total heat exchange with temperature efficiency up to 77% and enthalpy efficiency up to 63%, also at high level during summer season
- G4 efficiency class filters with synthetic cleanable media, both on fresh air and return air intake
- Removable side panel to access filters and heat recovery in the event of scheduled maintenance
- Low consumption, high efficiency & low noise direct driven fans with 3-speed EC motors
- Supply section complete with DX Coil (R410A) fitted with solenoid control valve, freon filter, contact temperature sensors on liquid and gas line, NTC sensors upstream and downstream airflow

**Air Curtain with DX Coil**

**Highly efficient heating effect.**

The combined air stream, which has a desirable low air current induction factor (mixing factor), can carry the selected initial temperature effect over long distances, and will reach the floor area while still at room temperature. This is necessary to avoid cooling down the interior spaces.



The Panasonic range of air curtains is designed for smooth operation and efficient performance. Air curtains produce a continuous stream of air blown from the top to the bottom of an open doorway and create a barrier that people and products can flow across, but air can't. Designed to improve energy efficiency, minimise heat loss from a building, and to allow retailers to keep doors open to encourage customers, our Air Curtains are suitable for connection to both VRF and PACi Systems.

Heating capacity comparison: Electrical air curtain / Panasonic air curtain

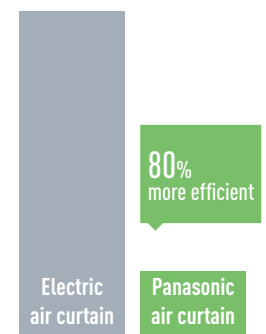

\* With the U-100PE1E5A on the PAW-20PAIRC-MS. Calculation method: Taking as consideration SCOP of the Panasonic combination of 6.0. If 100 is the energy needed for a air curtain, Panasonic Air curtain will need 1/(1-6)\*100=20.

**Energy Recovery Ventilation**

**Panasonic Energy Recovery Ventilators help you with your comfort and energy-saving plan.**



Panasonic Energy Recovery

Ventilators can reduce the outside air load because they efficiently recover the heat lost by ventilation during the heat recovery process. This results in energy-saving ventilation and lower running costs for air-conditioning and heating equipment. Furthermore, by designing our current models with an counter-flow heat-exchange element, we achieved products with slim body shapes and quiet operation that create a comfortable and pleasant air-conditioned environment while saving energy.

- Dramatic energy savings achieved through adoption of a high-efficiency counter-flow heat-exchange element
- Counter-flow heat exchange element used for reduced noise and slimmer, more compact body shape
- All maintenance can be performed through a single inspection hole
- Straight air supply / exhaust system used for easier installation

When a regular ventilation fan is used<sup>1</sup> When a Energy Recovery Ventilator is used<sup>2</sup>

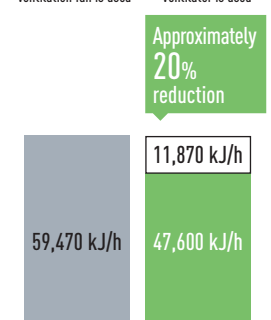

1) Two FY-27FPK7 units. 2) One FY-500ZY6R unit.

# AHU CONNECTION KIT 16, 28 AND 56kW FOR ECOi AND ECO G



## Panasonic AHU Kit, 16-56kW connected to ECOi or ECO G

PCB, Transformer, Solenoid Control Valve, Thermistor x 4 pcs, Terminal Base and Electrical Component Box.

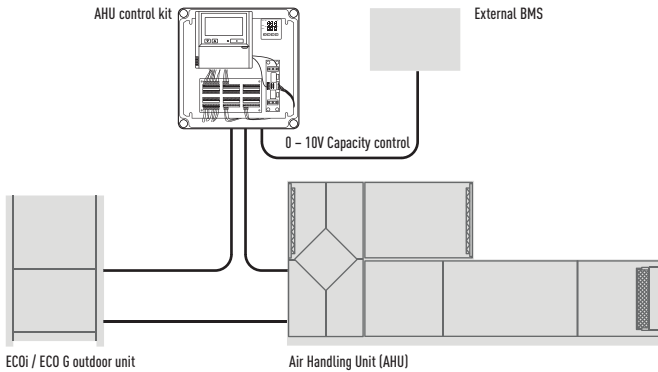

Demand control on the outdoor unit managed by external 0-10 V signal.

**System example for large capacity (more than 56kW)**  
 3 x [PCB, Transformer, Solenoid Control Valve, Thermistor x 4 pcs, Terminal Base and Electrical Component Box].  
 Example 140kW system

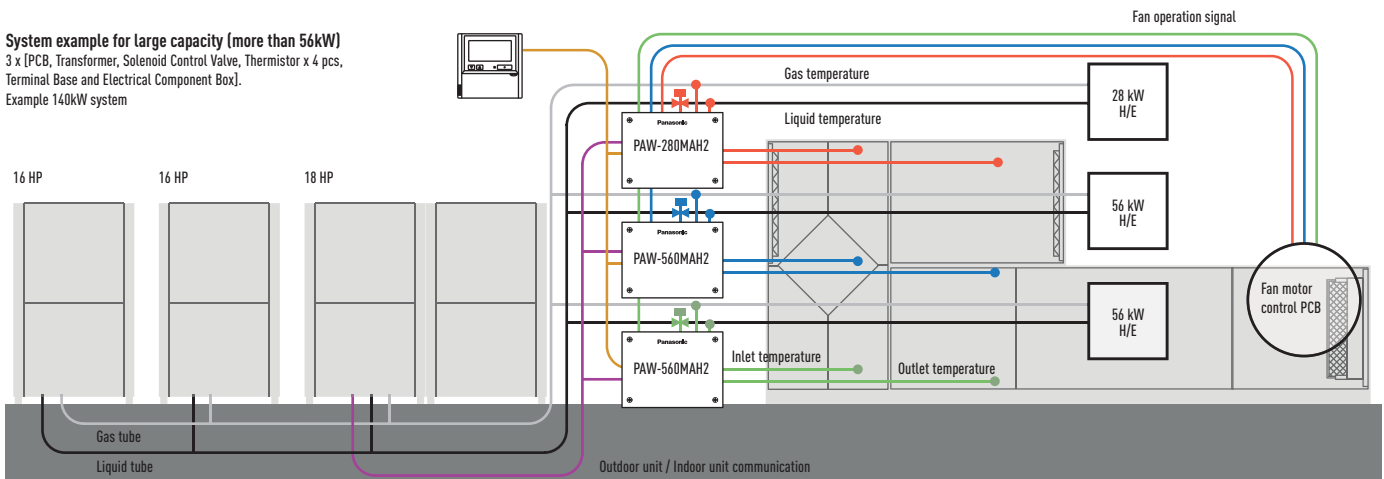

## Main components of mechanical ventilation systems

The main components of a mechanical ventilation system are the following: Air Handling Unit (AHU), air ducts and air distribution elements.

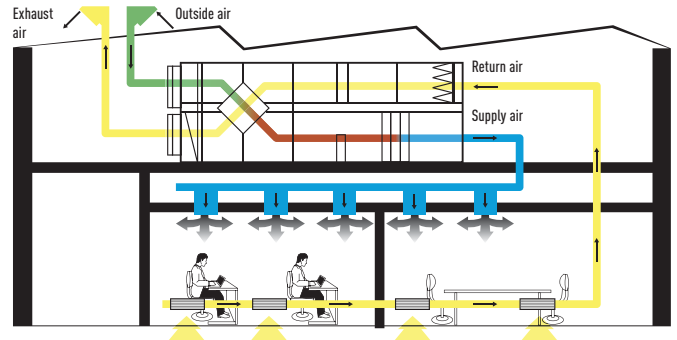

## Optional parts: Following functions are available by using different control accessories:

### CZ-RTC4 Timer remote controller.

- Operation-ON/OFF
- Mode select
- Temperature setting

\* Fan operation signal can be taken from the PCB.

### CZ-T10 terminal.

- Input signal= Operation ON/OFF
- Remote controller prohibition
- Output signal= Operating-ON status
- Alarm output (by DC12V)

### PAW-OCT, DC12 V outlet. OPTION terminal.

- Output signal= Cooling/Heating/Fan status
- Defrost
- Thermostat-ON

### CZ-CAPBC2 Mini seri-para I/O unit.

- Demand control 40% to 120% (5% steps) by 0-10V input signal
- Temperature setting by 0-10V or 0-140 Ω input signal
- Room (inlet air) temp outlet by 4-20mA
- Mode select or/and ON/OFF control
- Fan operation control
- Operation status output/ Alarm output
- Thermostat ON/OFF control

### PAW-T10 PCB to connect to T10 connector.

- A Dry contact PCB has been developed to easily control the unit
- Input signal operation ON/OFF
- Remote control prohibition
- Output signal Operation ON status maximum 230V 5A (NO/NC)
- Output signal alarm status max. 230 V 5 A (NO/NC)
- Additional available contacts:
  - External humidifier control (ON/OFF) 230 VAC 3A
  - External fan control (ON/OFF) 12V DC
  - External filter status signal potential free
  - External float switch signal potential free
  - External leakage detection sensor or TH. OFF contact potential free (possible usage for external blow out temperature control)



ECOi and ECO G Systems Ventilation units

ECOi 2-Pipe Series outdoor unit shall be used for AHU Connection Kit. 3 models for VRF system: 5HP (PAW-160MAH2/M/L), 10HP (PAW-280MAH2/M/L) and 20HP (PAW-560MAH2/M/L).

**With ECO G outdoor units**

- One AHU kit may be used for one ECO G unit (2-Pipe, 56kW). Multiple AHU kits cannot be used
- Mixed with standard indoor units is not allowed
- Power specifications are Single Phase 220V to 240V

**Technical focus**

- Maximum capacity/system: 60HP (168kW)
- Maximum piping length: 100m (120m equivalent)
- Elevation difference (indoor unit / indoor unit): 4m
- In/Out capacity ratio: 50~100%
- Maximum indoor unit number: 3 units\*
- Outdoor temperature range in heating: -20 ~ +15°C
- Available temperature range for the suction air at AHU Kit: cool: +18 ~ +32°C / heat: +16 ~ +30°C

\* To be simultaneous operation controlled by one remote controller sensor.

- The systems is controlled by the suction air (or room return air) temperature (same as standard indoor unit). (Selectable mode: Automatic / Cooling / Heating / Fan / Dry (but same as Cool)
- The discharge air temperature is also controlled to prevent too-low air discharge in cooling or too-high air discharge in heating (in case of VRF)
- Demand control (Forcible thermostat-OFF control by operating current)
- Defrost operation signal, Thermo-ON/OFF states output
- Drain pump control (Drain-pump and the float switch to be supplied in local)
- External target temperature setting via Indoor/Outdoor signal interface is available with CZ-CAPBC2 (Ex. 0 – 10V)
- Demand control 40% to 120% (5% steps) by 0-10V input signal
- Connectable with P-Link system. Special care for electrical noise may be necessary depending on the on-side system
- Fan control signal from the PCB can be used for control the air volume (high/mid/low and LL for Th-OFF). Need to change the fan control circuit wiring at field

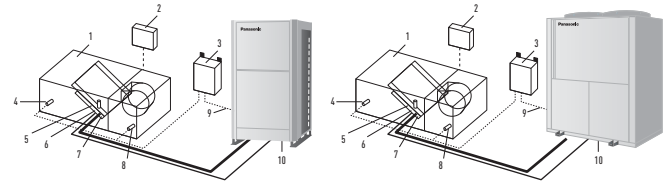

System & regulations. System overview.

1. AHU Unit equipment (field supplied)
2. AHU Unit system controller field supplied)
3. AHU Kit controller box (with control PCB)
4. Thermistor for discharge air
5. Electronic expansion valve
6. Thermistor for gas pipe (E3)
7. Thermistor for liquid pipe (E1)
8. Thermistor for suction air
9. Inter-unit wiring
10. Outdoor unit

HP		5HP	10HP	20HP	30HP	40HP	50HP	60HP
		PAW-160MAH2/M/L	PAW-280MAH2/M/L	PAW-560MAH2/M/L	PAW-280MAH2/M/L	PAW-560MAH2/M/L	PAW-560MAH2/M/L	PAW-560MAH2/M/L
					PAW-560MAH2/M/L	PAW-560MAH2/M/L	PAW-560MAH2/M/L	PAW-560MAH2/M/L
							PAW-280MAH2/M/L	PAW-560MAH2/M/L
Nominal cooling capacity @ 50Hz	kW	14,00	28,0	56,0	84,0	112,0	140,0	168,0
Nominal heating @ 50Hz	kW	16,00	31,5	63,0	95,0	127,0	155,0	189,0
Cooling airflow	Hi / Lo m³/min	2600/1140	5000/3500	10000/7000	15000/10500	20000/14000	25000/17500	30000/21000
Bypass factor		0,9 (recommended)	0,9 (recommended)	0,9 (recommended)	0,9 (recommended)	0,9 (recommended)	0,9 (recommended)	0,9 (recommended)
Dimensions	H x W x D mm	303 x 232 x 110	404 x 425 x 78	404 x 425 x 78	404 x 425 x 78	404 x 425 x 78	404 x 425 x 78	404 x 425 x 78
Weight	kg	3,2	6,3	6,3	6,3	6,3	6,3	6,3
Piping length	Min / Max m	10/100	10/100	10/100	10/100	10/100	10/100	10/100
Elevation difference (in/out)	Max m	10	10	10	10	10	10	10
Piping connections	Liquid pipe Inch (mm)	3/8 (9,52)	3/8 (9,52)	5/8 (15,88)	3/4 (19,05)	3/4 (19,05)	3/4 (19,05)	3/4 (19,05)
	Gas pipe Inch (mm)	5/8 (15,88)	7/8 (22,22)	1 1/8 (28,58)	1 1/4 (31,75)	1 1/2 (38,15)	1 1/2 (38,15)	1 1/2 (38,15)
Intake temperature of AHU Kit	Cool Min ~ Max °C	+18 ~ +32 (+13 ~ +23)	+18 ~ +32 (+13 ~ +23)	+18 ~ +32 (+13 ~ +23)	+18 ~ +32 (+13 ~ +23)	+18 ~ +32 (+13 ~ +23)	+18 ~ +32 (+13 ~ +23)	+18 ~ +32 (+13 ~ +23)
	Heat Min ~ Max °C	+16 ~ +30	+16 ~ +30	+16 ~ +30	+16 ~ +30	+16 ~ +30	+16 ~ +30	+16 ~ +30
Ambient temperature of outdoor unit	Cool Min ~ Max °C	-10 ~ +43	-10 ~ +43	-10 ~ +43	-10 ~ +43	-10 ~ +43	-10 ~ +43	-10 ~ +43
	Heat Min ~ Max °C	-20 ~ +15	-20 ~ +15	-20 ~ +15	-20 ~ +15	-20 ~ +15	-20 ~ +15	-20 ~ +15

**AHU connection kit / System combination**

Capacity (HP)	Outdoor unit combination	AHU kit combination
28kW (10HP)	U-10ME2E81	PAW-280MAH2
56kW (20HP)	U-20ME2E81	PAW-560MAH2
84kW (30HP)	U-16ME2E81 U-14ME2E81	PAW-560MAH2 PAW-280MAH2
112kW (40HP)	U-20ME2E81 U-20ME2E81	PAW-560MAH2 PAW-560MAH2
140kW (50HP)	U-18ME2E81 U-16ME2E81 U-16ME2E81	PAW-560MAH2 PAW-560MAH2 PAW-280MAH2
168kW (60HP)	U-20ME2E81 U-20ME2E81 U-20ME2E81	PAW-560MAH2 PAW-560MAH2 PAW-560MAH2
56kW (20HP)	U-20GE3E5	PAW-560MAH2

## AIR CURTAIN WITH DX COIL, CONNECTED TO THE VRF OR PACi SYSTEMS

### Highly efficient heating effect

The combined air stream, which has a desirable low air current induction factor (mixing factor), can carry the selected initial temperature effect over long distances, and will reach the floor area while still at room temperature. This is necessary to avoid cooling down the interior spaces.

Available in different lengths to suit requirements between 1,0 and 2,5m, both air curtains have outlet grilles that can be adjusted to five different positions. The jet flow model can be installed up to a height of 3,5m with the standard model up to 3,0m. The outlet grilles can be easily adjusted into five positions to suit different installation requirements and the air filter can be accessed without the need for specialist tools.

- High performance with EC fan motor (40% lower running costs compared to a standard AC fan motor)
- Easy Cleaning and Servicing
- Can be connected to either Panasonic VRF or PACi systems
- Built-in drain for cooling operation
- Standard and Jet Flow air curtains can be controlled via Panasonic's range of remote internet controls

The new standard and jet-flow models are ideal for connection to a ECOi or PACi system. With simple "plug and play" installation, both are fitted with an EC fan motor for a smooth operation and efficient performance. This new fan guarantees 40% lower running cost than with a standard AC fan motor. Air curtains run approximately 12 hours per day at shops, and efficient performance contributes to energy savings.

### Internet Control

An app added to your tablet or smartphone or via the Internet allows you to control and manage the system remotely. There is also the option to integrate into existing BMS systems by using other Panasonic interfaces.

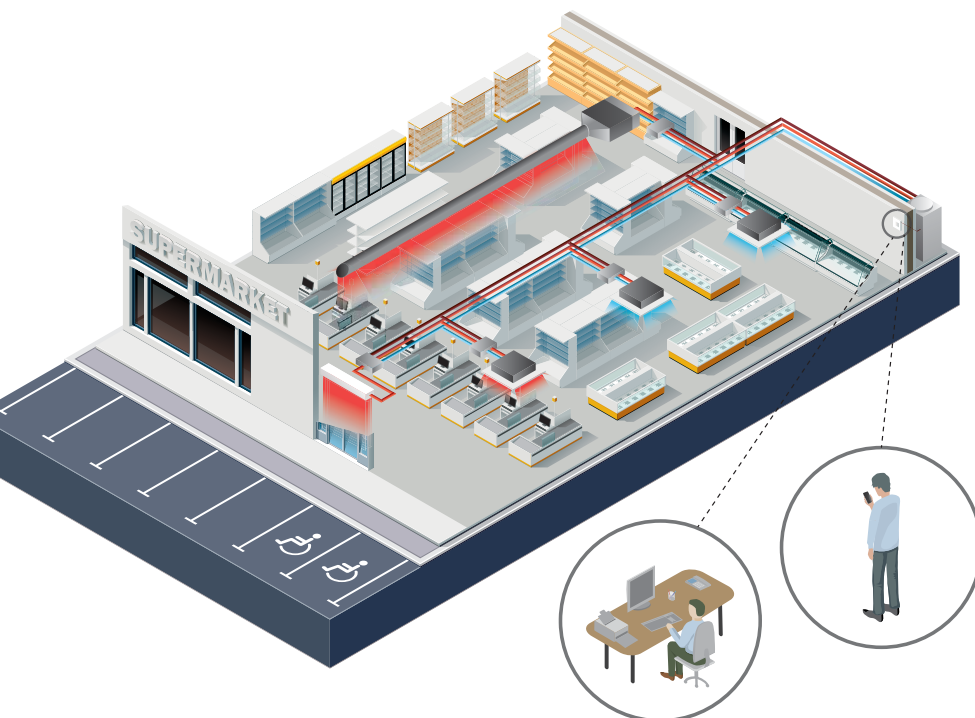

### Intelligent Operation

Our air curtains combine airflow and heating / cooling technology to ensure optimum comfort and energy efficiency whilst also creating an effective barrier between indoor and outdoor environments. Design and installation is key to achieving the correct height / temperature settings to achieve optimum performance. Our air curtains are designed to answer the demands of the retail, commercial and industrial markets.

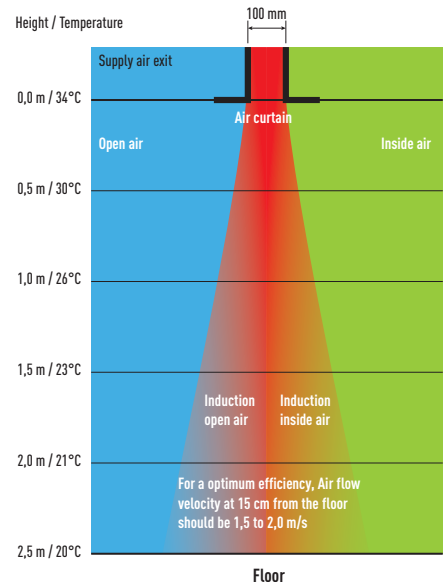

### How does it work?

Stale air from the room is taken in and ejected near the door. This creates a 'roll of air' that shields the door area, mixing with the colder incoming air. It then turns away from the door, back into the room and toward the intake screen, where it is partly drawn in again. This flow of air helps to create a barrier for heat loss yet at the same time refreshes room air

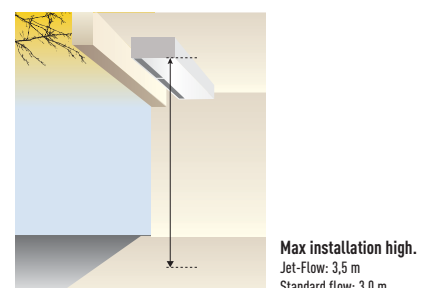



High efficiency air curtain connected to your VRF installation. EC Fan motor for a smooth operation and efficient performance. 2 types of air flow available: Jet-Flow and Standard. Easy cleaning and servicing.

### Technical focus

- Save up to 40% energy costs by use of the integrated EC fan technology (higher efficiency than conventional AC fan, soft start and longer motor duration)
- 3 lengths of air curtains Jet-Flow, from 1,0 to 2,0m and 2 lengths of air curtains Standard, 1,0 and 2,0m
- Installation Height up to 3,5m (Jet-Flow) and 3,0m (Standard)
- Outlet grilles can be adjusted in five positions, to suite different indoor and installation requirements (Jet-Flow)
- Control with Panasonic remote control systems (optional)
- Direct integration to BMS by optional Panasonic interfaces
- Drain included for cooling operation

### Features

#### Comfort.

- Easy redirection of Airflow by means of manual deflector (Jet-Flow)

#### Ease of use.

- Speed selector (high and low) on the unit itself

#### Easy installation and maintenance.

- Easy installation
- Compact dimensions improve installation and positioning (Jet-Flow)
- Easy cleaning of grid without opening of the unit

### Optimised airflow velocity

1. Energy losses, no air curtain installed
2. Too low velocity air curtain – air curtain not efficient
3. Optimum results with the Tekadoor air curtain connected to Panasonic VRF
4. Too high velocity air curtain – considerable turbulence, energy lost to the outside, air curtain not efficient

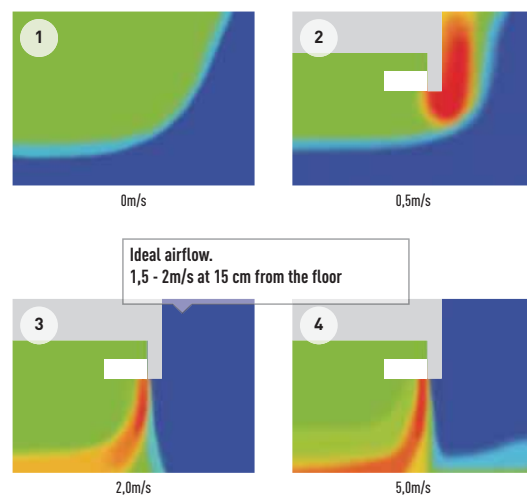

HP			4HP	6HP	8HP	14HP	4HP	8HP
Air Curtain			PAW-10EAIRC-MJ	PAW-15EAIRC-MJ	PAW-20EAIRC-MJ	PAW-25EAIRC-MJ	PAW-10EAIRC-MS	PAW-20EAIRC-MS
Air flow type			Jet-Flow				Standard	
Air Flow Length (A)	m		1,00	1,50	2,00	2,50	1,00	2,00
Air volume	Hi / Med / Lo	m <sup>3</sup> /min	30,00/25,00/20,00	45,00/38,30/31,70	60,00/50,00/41,70	75,00/63,30/51,70	30,00/25,00/20,00	45,00/38,30/31,70
Cooling capacity nominal <sup>2</sup>		kW	9,20	17,50	23,10	24,40	9,20	17,50
Heating capacity nominal		kW	11,40	25,00	31,50	31,50	11,40	31,50
Heating capacity with air in 20°C, air out 40 / 35 / 30°C		kW	11,90/8,90/5,90	17,90/13,40/8,90	23,90/17,90/11,90	29,90/22,40/14,90	11,90/8,90/5,900	17,90/13,40/8,90
Max installation height	Good / Normal / Bad	m	3,5/3,1/2,7	3,5/3,1/2,7	3,5/3,1/2,7	3,5/3,1/2,7	3/2,7/2,4	3/2,7/2,4
Piping connections	Liquid pipe	Inch (mm)	3/8(9,52)	3/8(9,52)	3/8(9,52)	3/8(9,52)	3/8(9,52)	3/8(9,52)
	Gas pipe	Inch (mm)	5/8(15,88)	3/4(19,05)	7/8(22,22)	7/8(22,22)	5/8(15,88)	7/8(22,22)
Noise		dB(A)	40-55	40-56	40-57	40-58	40-55	40-57
Dimension	W x H x D	mm	260 x 1210 x 590	260 x 1710 x 590	260 x 2210 x 590	260 x 2710 x 590	260 x 1210 x 490	260 x 2210 x 490
Net weight		kg	70	100	138	160	60	128
Mini ECOi with air out 40°C			U-4LE2E5/8 <sup>1</sup>	U-6LE2E5/8 <sup>1</sup>	—	—	U-4LE2E5/8 <sup>1</sup>	U-6LE2E5/8 <sup>1</sup>
Mini ECOi with air out 35°C			U-4LE2E5/8 <sup>1</sup>	U-4LE2E5/8 <sup>1</sup>	U-6LE2E5/8 <sup>1</sup>	—	U-4LE2E5/8 <sup>1</sup>	U-4LE2E5/8 <sup>1</sup>
Mini ECOi with air out 30°C			U-4LE2E5/8 <sup>1</sup>	U-4LE2E5/8 <sup>1</sup>	U-4LE2E5/8 <sup>1</sup>	U-5LE2E5/8 <sup>1</sup>	U-4LE2E5/8 <sup>1</sup>	U-4LE2E5/8 <sup>1</sup>
ECOi with air out 40°C			All models	All models	All models	All models without 8HP	All models	All models
ECOi with air out 30°C or 35°C			All models	All models	All models	All models	All models	All models
ECO G all temperatures			All models	All models	All models	All models	All models	All models

All combinations under rated conditions: Heating Outdoor +7°C DB/+6°C WB Indoor +20°C DB. In case of lower outdoor temperatures a higher capacity outdoor unit model may be necessary. 1) Or bigger size. 2) Rated Conditions Cooling Outdoor +35°C DB Indoor +27°C DB/+19°C WB, Discharge temperature <sup>3</sup> 16°C.



## ENERGY RECOVERY VENTILATION

### Energy efficiency and ecology

Energy consumption is dramatically reduced by using a counter-flow heat-exchange element. Air conditioning load is reduced by approximately 20%, resulting in significant energy savings.

### Comparison of former and current elements

With the cross-flow element, air moves in a straight line across the element; with the counter-flow element, air flows through the element for a longer time (longer distance), so the heat-exchange effect remains unchanged even if the element is made thinner.

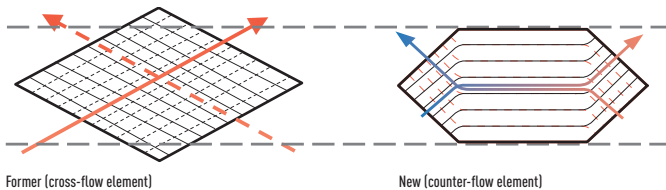

### Heat exchange ventilation and normal ventilation

Energy-saving ventilation can be achieved through the proper use of heat-exchange ventilation and normal ventilation.

#### Heat exchange ventilation.

When a room is cooled or heated, the exhausted cooling / heating energy is recovered by heat-exchange ventilation.

#### Normal ventilation.

This is used in the spring and autumn, when rooms are not cooled or heated, that is, when there is little difference between the indoor and outdoor air conditions. In addition, at night during the hot season, when the outside air temperature drops the outside air is drawn inside without heat exchange, alleviating the load on the air conditioning equipment. The heat exchanger is made up of a membrane manufactured from a special material covered in resin for optimal heat transmission. The nylon/polyester fibre filter offers high dust retention capacity. We have also redesigned the air ducts to obtain a long-lasting heat exchange system which does not need periodic cleaning.

### Heat exchanger

With the cross-flow element, air moves in a straight line across the element. With the counter-flow element, airflows through the element for a longer time (longer distance), so the heat-exchange effect remains unchanged even if the element is made thinner.



### More comfort

#### Quiet operation

Low noise operation results in noticeably quieter units. All models with capacities below 500m<sup>3</sup>/h run at noise levels below 32dB (High setting) and even our largest 1.000m<sup>3</sup>/h-capacity model runs at only 37,5dB (High setting).

### Long service life of heat-exchange element

We used a nonwoven cloth filter with a high dust collection efficiency and redesigned the air flow passages to achieve a durable heat-exchange element that requires no periodic cleaning.

Changes in airflow resistance based on number of years in service.

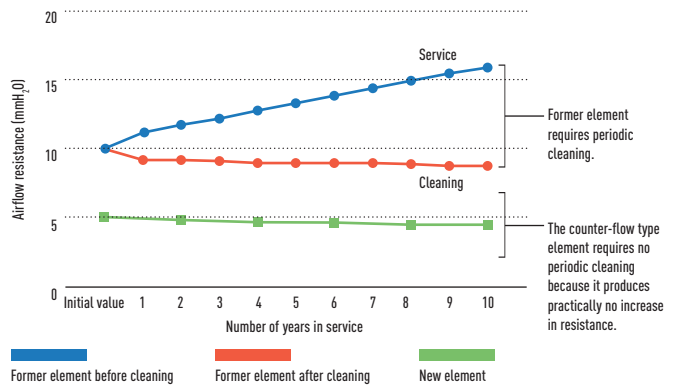

### Easy installation and maintenance

#### Slim shape and easier installation.

Counter-flow heat exchange element used for reduced noise and slimmer, more compact body shape.

270mm Height: FY-250ZDY8R // FY-350ZDY8R // FY-500ZDY8R

388mm Height: FY-800ZDY8R // FY-01KZDY8R

#### Reverse mountable direct air supply / exhaust system.

Adoption of straight air supply / exhaust system: Duct design is simplified because the air supply / exhaust ducts are straight.

Since each unit can be mounted in reverse position, only one inspection hole is needed for two units: Two units can share one inspection hole so duct work is easier and more flexible.

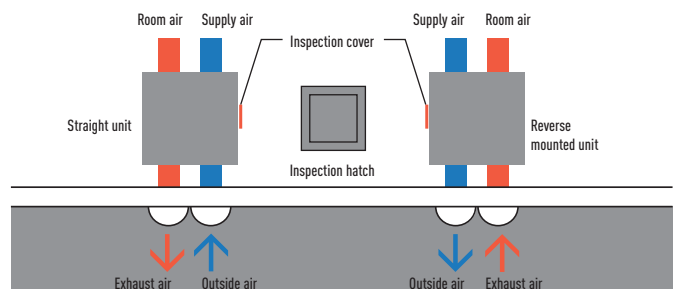

ECOi and ECO G Systems Ventilation units

Suppresses indoor temperature changes while providing fresh air. Recovers up to 77% of the heat in the outgoing air, for an ecological and energy efficient building.

Features

Energy efficiency and ecology.

- Up to 20% energy saving in the installation
- Recovers up to 77% of the heat in the outgoing air

Comfort.

- Cleaning reduced due to the revolutionary structure (every 6 months)
- Ideal for indoor spaces without windows

Easy installation and maintenance.

- 5 models for easier selection
- Reduced system height (270mm and 388mm)
- Side opening for cleaning (inspection of filter, motor and other parts)
- Installation can be reversed to share an inspection opening between 2 machines
- Easy connection to the air conditioning unit (without additional elements)
- Installation in false ceilings
- Units operate at 220 - 240V
- High static pressure for easier installation

Technical focus

- High energy saving, up to 20%
- Counter Cross Flow technology for better efficiency
- Long life element core
- Easy installation and 20% less thickness
- Easy connection to air conditioning units
- Silent units

Balanced ventilation

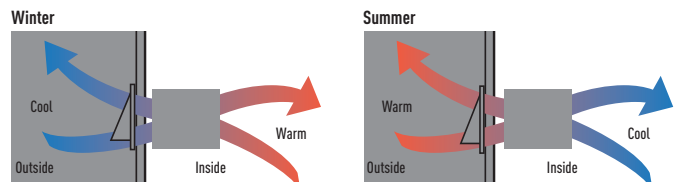

A new intuitive & stylish control

- Included as a standard control
- Compact and flat panel
- Filter cleaning support
  - Signal alert for clearing
  - Filter usage condition by 1/2/3/4 months
- Size (W x H x D) 116 x 120 x 40mm



Rated flow rate	250m³/h			350m³/h			500m³/h			800m³/h			1000m³/h					
Models	FY-250ZDY8R			FY-350ZDY8R			FY-500ZDY8R			FY-800ZDY8R			FY-01KZDY8R					
	<b>E-High</b>	<b>High</b>	<b>Low</b>	<b>E-High</b>	<b>High</b>	<b>Low</b>	<b>E-High</b>	<b>High</b>	<b>Low</b>	<b>E-High</b>	<b>High</b>	<b>Low</b>	<b>E-High</b>	<b>High</b>	<b>Low</b>			
Power source	220V / 240V / 50Hz			220V / 240V / 50Hz			220V / 240V / 50Hz			220V / 240V / 50Hz			220V / 240V / 50Hz					
<b>Heat exchange ventilation</b>	<b>E-High</b>	<b>High</b>	<b>Low</b>	<b>E-High</b>	<b>High</b>	<b>Low</b>	<b>E-High</b>	<b>High</b>	<b>Low</b>	<b>E-High</b>	<b>High</b>	<b>Low</b>	<b>E-High</b>	<b>High</b>	<b>Low</b>			
Input power	112,00/128,00	108,00/123,00	87,00/96,00	182,00/190,00	178,00/185,00	175,00/168,00	263,00/289,00	204,00/225,00	165,00/185,00	387,00/418,00	360,00/378,00	293,00/295,00	437,00/464,00	416,00/432,00	301,00/311,00			
Air volume	250	250	190	350	350	240	500	500	440	800	800	630	1000	1000	700			
External static pressure	105	95	45	140	60	45	120	60	35	140	110	55	105	80	75			
Sound power	30,00/31,50	29,50/30,50	23,50/26,50	32,50/33,00	30,50/31,00	22,50/25,50	36,50/37,50	34,50/35,50	31,00/32,50	37,00/37,50	36,50/37,00	33,50/34,50	39,50/38,50	39,00/37,50	35,50/34,50			
Temperature exchange efficiency	75	75	77	75	75	78	75	75	76	75	75	76	75	75	79			
<b>Normal ventilation</b>	<b>E-High</b>	<b>High</b>	<b>Low</b>	<b>E-High</b>	<b>High</b>	<b>Low</b>	<b>E-High</b>	<b>High</b>	<b>Low</b>	<b>E-High</b>	<b>High</b>	<b>Low</b>	<b>E-High</b>	<b>High</b>	<b>Low</b>			
Input power	112,00/128,00	108,00/123,00	87,00/96,00	182,00/190,00	178,00/185,00	175,00/168,00	263,00/289,00	204,00/225,00	165,00/185,00	387,00/418,00	360,00/378,00	293,00/295,00	437,00/464,00	416,00/432,00	301,00/311,00			
Air volume	250	250	190	350	350	240	500	500	440	800	800	630	1000	1000	700			
External static pressure	105	95	45	140	60	45	120	60	35	140	110	55	105	80	75			
Sound power	30,00/31,50	29,50/30,50	23,50/26,50	32,50/33,00	30,50/31,00	22,50/25,50	37,50/38,50	37,00/38,00	31,00/32,50	37,00/37,50	36,50/37,00	33,50/34,50	39,50/40,50	39,00/39,50	35,50/36,50			
Temperature exchange efficiency	—	—	—	—	—	—	—	—	—	—	—	—	—	—	—			
Dimension	H x W x D	mm		270 x 882 x 599			317 x 1050 x 804			317 x 1090 x 904			388 x 1322 x 884			388 x 1322 x 1134		
Net weight	kg	29		49			57			71			83					

This noise of the product is the value which was measured at the acoustic room. Actually, in the established condition, that undergo influence by the echoing of the room and so that become bigger than the display numerical value. The input, the current and the exchange efficiency are values at the time of the mentioned air volume. The noise level shall be measured 1,5m below the centre of the unit. The temperature exchange efficiency averages that of when cooling and when heating.

## HEAT RECOVERY WITH DX COIL

Panasonic launches an heat recovery solution for greater energy efficiency.

Panasonic's heat recovery solution performs well in extreme weather conditions and can achieve up to 77% efficiency (63% in enthalpy efficiency).

The counter-flow heat exchanger reduces the air conditioning load, enabling customers – typically owners of hotels, restaurants and other large commercial buildings – to reduce their energy consumption and save on the cost of maintaining comfortable room temperatures.

### Energy efficiency

As the latest example of Panasonic's continued commitment to developing unbeatable, energy-efficient air conditioning technologies for commercial applications, the company has introduced a heat recovery device.

The unit features a DX Coil designed to recover up to 77% of the heat from outgoing air, and a air purifying system which helps to improve air quality.

In even the most demanding commercial applications, business owners will benefit from the unit's ability to by-pass the heat exchange process when the outside air temperature is cool enough for fresh air to be drawn directly inside (free cooling).

This alleviates the load on the air conditioning equipment and consequently reduces energy bills.



### Supply section complete

The supply section comes complete with the DX coil (using R410A refrigerant) – fitted with a solenoid control valve, freon filter, contact temperature sensors on the liquid and gas line, and NTC sensors on the upstream and downstream airflows. The built-in electric box is equipped with a PCB to control the internal fan speed and to interconnect the outdoor and indoor units, and the ducts are connected by circular plastic collars.

### Characteristic curves

The following curves show the unit external static pressure at maximum fan speed for each model.

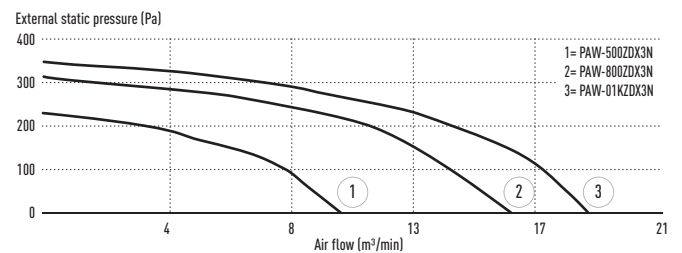

### Balanced Ventilation

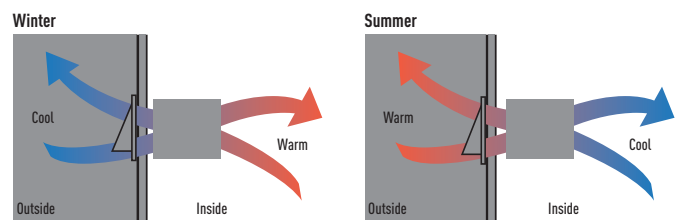

ECOi and ECO G Systems Ventilation units

**Interconnection**

This ventilation unit is connected to an ECOi indoor unit (3,00kW, 4,00kW or 4,50kW) and can be controlled by the easy-to-use ECOi remote controller CZ-RTC5B.

This capability makes the system an excellent choice for hotels, offices (large and small), educational settings and other buildings requiring different temperatures in multiple rooms. The system also integrates easily with building management systems.

**Technical focus**

- Motorised heat recovery by-pass device automatically controlled by unit control to use fresh air free-cooling when convenient

**General characteristics**

- Galvanized steel self-supporting panels, internally and externally insulated
- Counterflow air-to-air heat recovery device, made of sheets of special paper with special sealing to keep airflows separate and only permeable to water vapour. Total heat exchange with temperature efficiency up to 70% and enthalpy efficiency up to 67%, also at high level during summer season

- G4 efficiency class filters with synthetic cleanable media, both on fresh air and return air intake
- Removable side panel to access filters and heat recovery in the event of scheduled maintenance
- Low consumption, high efficiency & low noise direct driven fans
- Supply section complete with DX Coil (R410A) fitted with solenoid control valve, freon filter, contact temperature sensors on liquid and gas line, NTC sensors upstream and downstream airflow
- Built-in electric box equipped with PCB to control internal fan speed and to interconnect outdoor/indoor units
- Duct connection by circular plastic collars
- CZ-RTC5B Timer remote controller (option)

**Interconnection to outdoor/indoor units**

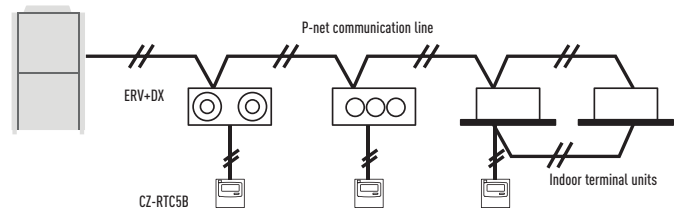

Model	PAW-500ZDX3N		PAW-800ZDX3N		PAW-01KZDX3N		
Power source	Voltage	V	230	230	230	230	
	Phase		Single Phase	Single Phase	Single Phase	Single Phase	
	Frequency	Hz	50	50	50	50	
Air volume		m <sup>3</sup> /min	8,33	13,33	16,66	16,66	
External static pressure <sup>1</sup>		Pa	90	120	115	115	
Maximum current	Total full load	A	0,6	1,4	2,1	2,1	
Input power		W	150	320	390	390	
Sound pressure <sup>2</sup>		dB(A)	39	42	43	43	
Piping connections	Liquid pipe	Inch (mm)	1/4 (6,35)	1/4 (6,35)	1/4 (6,35)	1/4 (6,35)	
	Gas pipe	Inch (mm)	1/2 (12,70)	1/2 (12,70)	1/2 (12,70)	1/2 (12,70)	
<b>Heat recovery</b>			<b>Cooling</b>	<b>Heating</b>	<b>Cooling</b>	<b>Heating</b>	
Temperature efficiency	%		76	76	76	76	
Enthalpy efficiency	%		63	67	63	62	
Saved power summer mode or winter mode*	kW		1,70	4,30 (4,80)	2,50	6,50 (7,30)	3,20
<b>DX Coil</b>							
Total / Sensible capacity	kW		3,00/2,10	2,50/2,70	5,10/3,50	4,40/4,80	5,80/4,10
Off temperature	°C		15,9	30,1 (29,2)	17,9	27,5 (26,5)	18,6
Off relative humidity	%		90	16 (15)	90	14 (13)	89

Nominal summer conditions: Outside air: 32°C DB, RH 50%. Ambient air: 26°C DB, RH 50%. Nominal winter conditions: Outside air: -5°C DB, RH 80%. Ambient air: 20°C DB, RH 50%. Cooling mode air inlet condition: 28,5°C DB, RH 50%; evaporating temperature 7°C. Heating mode air inlet condition: 13°C DB, RH 40% (11°C DB, RH 45%); condensating temperature 40°C. DB: Dry Bulb; RH: Relative Humidity.

1) Referred to the nominal air flow after filter and plate heat exchanger. 2) Sound pressure level calculated at 1m far from: ducted supply exhaust air ducted return - first air intake / service side, at normal condition. \* Tentative data.



ECONAVI and INTERNET CONTROL: Optional.

# DIMENSIONS AND TUBE SIZES OF BRANCHES AND HEADERS FOR ECOi 2-PIPE SYSTEMS

## Optional Distribution Joint Kits

See the installation instructions packaged with the distribution joint kit for the installation procedure.

Model name	Cooling capacity after distribution	Remarks
1. CZ-P680PH2BM	68,00kW or less	For outdoor unit
2. CZ-P1350PH2BM	From 68,00kW to 168,00kW	For outdoor unit
3. CZ-P224BK2BM	22,40kW or less	For indoor unit
4. CZ-P680BK2BM	From 22,40kW to 68,00kW	For indoor unit
5. CZ-P1350BK2BM	From 68,00kW to 168,00kW	For indoor unit

## Tube size (with thermal insulation)

1. CZ-P680PH2BM: For outdoor unit side (Capacity after distribution joint is 68,00kW or less).

Gas tubing

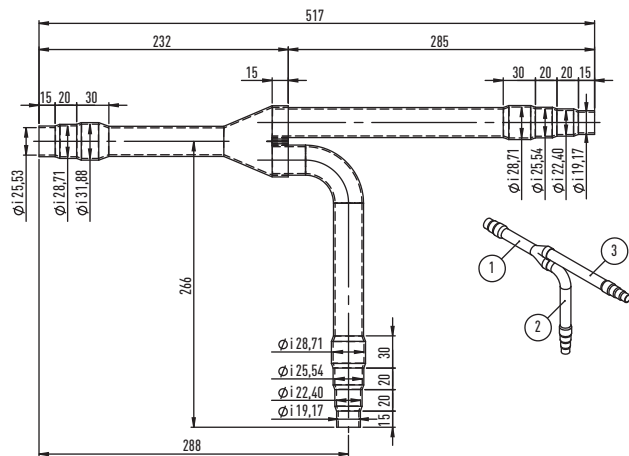

Liquid tubing

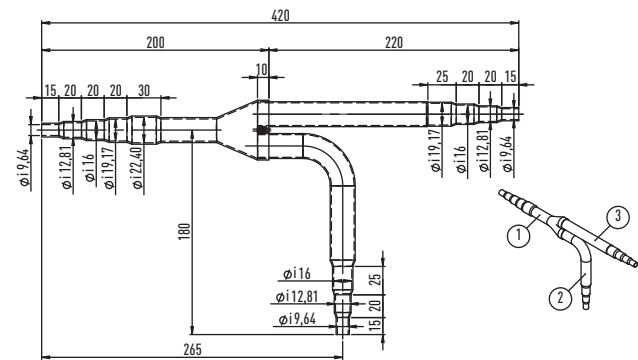

Unit: mm

2. CZ-P1350PH2BM: For outdoor unit side (Capacity after distribution joint is greater than 68,00kW and no more than 168,00kW).

Gas tubing

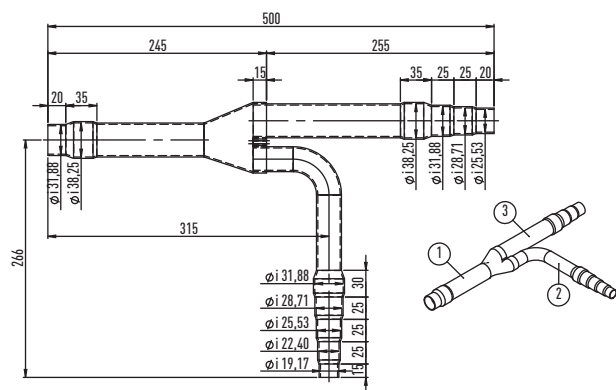

Liquid tubing

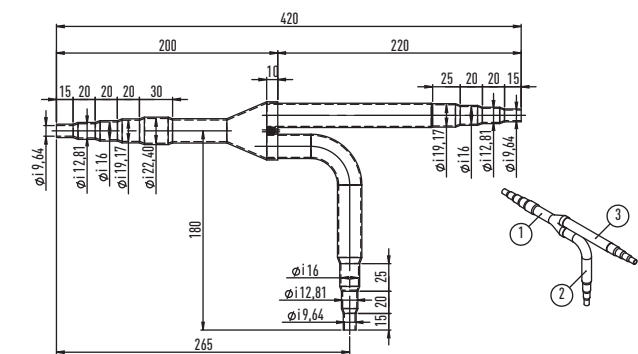

Unit: mm

3. CZ-P224BK2BM: For indoor unit side (Capacity after distribution joint is 22,40kW or less).

Gas tubing

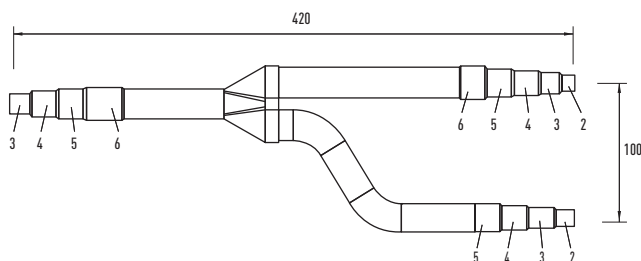

Liquid tubing

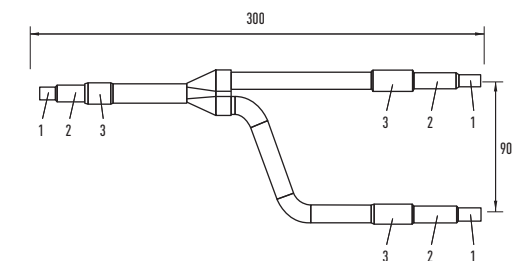

Unit: mm



**4. CZ-P680BK2BM:** For indoor unit side (Capacity after distribution joint is greater than 22,40kW and no more than 68,00kW).

Gas tubing

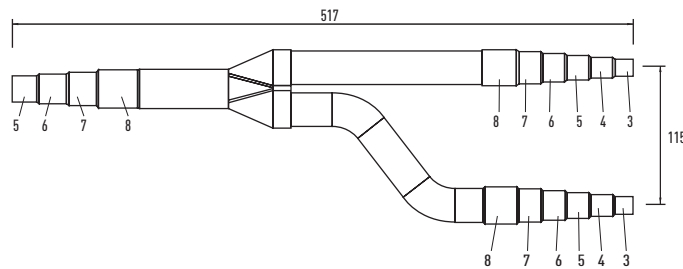

Liquid tubing

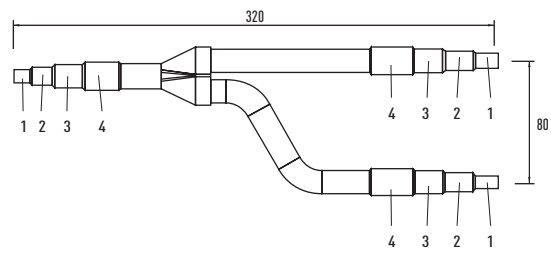

Unit: mm

**5. CZ-P1350BK2BM:** For indoor unit side (Capacity after distribution joint is greater than 68,00kW and no more than 168,00kW).

Gas tubing

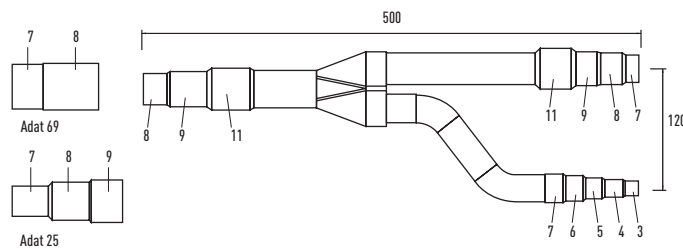

Liquid tubing

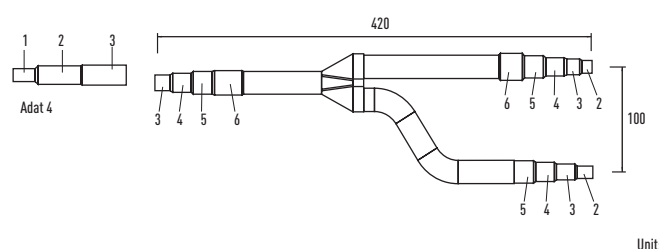

Unit: mm

Diameters		Diameters		Diameters	
1	6,35 mm 1/4"	6	22,40 mm 7/8"	11	38,10 mm 1 1/2"
2	9,52 mm 3/8"	7	25,40 mm 1"	12	41,28 mm 1 5/8"
3	12,70 mm 1/2"	8	28,57 mm 1 1/8"	13	44,45 mm 1 3/4"
4	15,88 mm 5/8"	9	31,75 mm 1 1/4"	14	50,80 mm 2"
5	19,05 mm 3/4"	10	34,92 mm 1 3/8"		

**Header pipe set for ECOi 2-Pipe system**

**CZ-P4HP4C2BM:** Header pipe models for 2-Pipe systems.

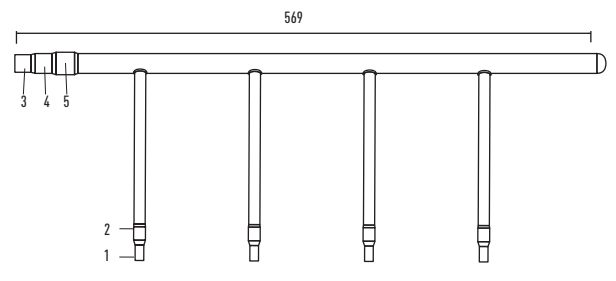
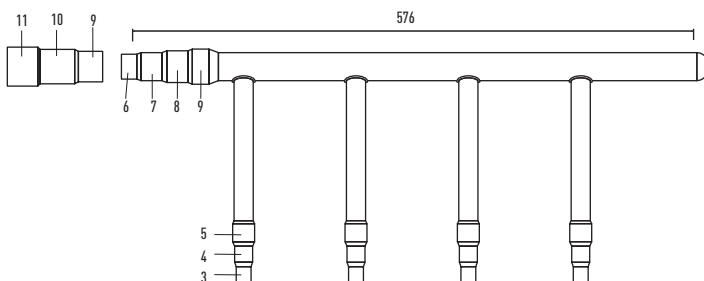

Diameters		Diameters		Diameters	
1	6,35 mm 1/4"	5	19,05 mm 3/4"	9	31,75 mm 1 1/4"
2	9,52 mm 3/8"	6	22,40 mm 7/8"	10	34,92 mm 1 3/8"
3	12,70 mm 1/2"	7	25,40 mm 1"	11	38,10 mm 1 1/2"
4	15,88 mm 5/8"	8	28,57 mm 1 1/8"		

# BRANCHES AND HEADERS FOR 3-PIPE ECOi AND MINI ECOi

## Optional distribution joint Kits for 3-Pipe ECOi EX MF3 Series

See the installation instructions packaged with the distribution joint kit for the installation procedure.

\* In case the total capacity of indoor units connected after distribution exceeds the total capacity of the outdoor units, select the distribution piping size for the total capacity of the outdoor units.

Model name	Cooling capacity after distribution	Remarks
1. CZ-P680PJ2BM	68,00kW or less	For outdoor unit
2. CZ-P1350PJ2BM	Greater than 68,00kW and no more than 135,00kW	For outdoor unit
3. CZ-P224BH2BM	22,40kW or less	For indoor unit
4. CZ-P680BH2BM	Greater than 22,40kW and no more than 68,00kW	For indoor unit
5. CZ-P1350BH2BM	Greater than 68,00kW and no more than 135,00kW	For indoor unit

## Piping size for 3-Pipe ECOi EX MF3 Series

### 1. CZ-P680PJ2BM

For outdoor unit side (capacity after distribution joint is 68,00kW or less).

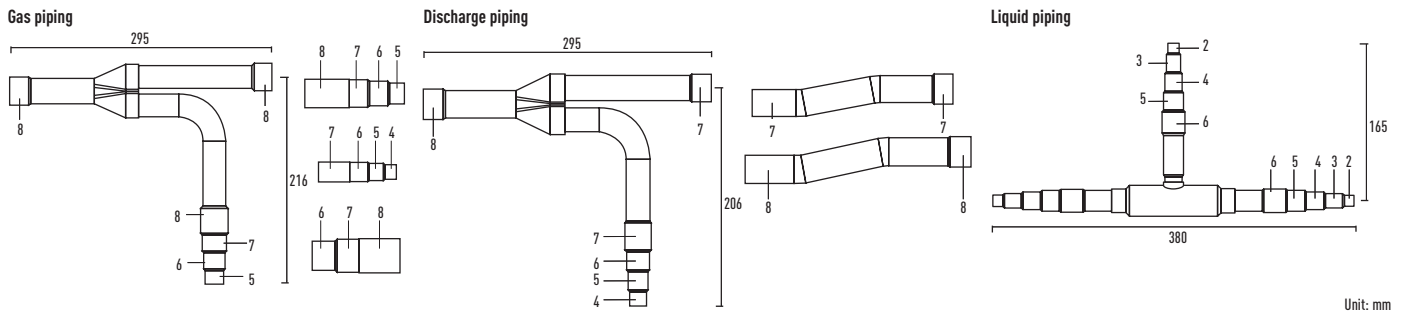

### 2. CZ-P1350PJ2BM

For outdoor unit side (capacity after distribution joint is greater than 68,00kW and no more than 135,00kW).

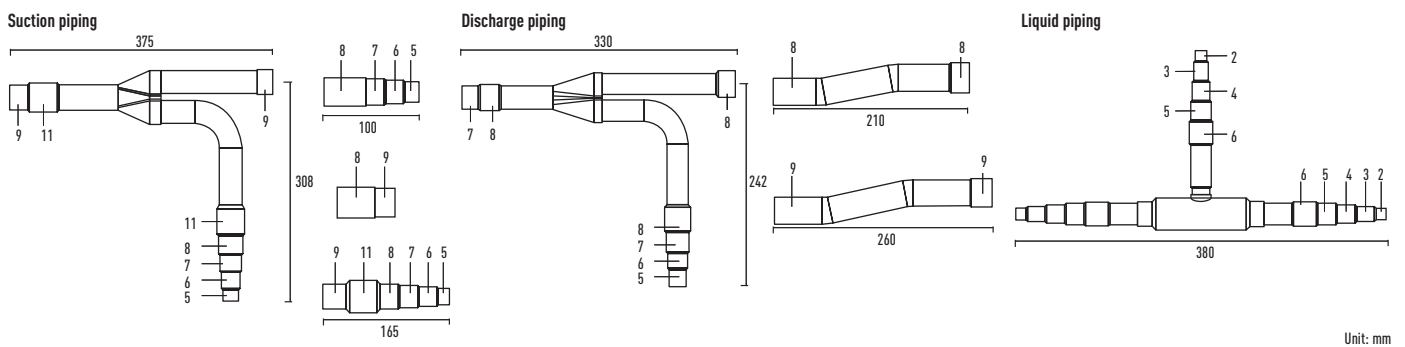

### 3. CZ-P224BH2BM

For indoor unit side (capacity after distribution joint is 22,40kW or less).

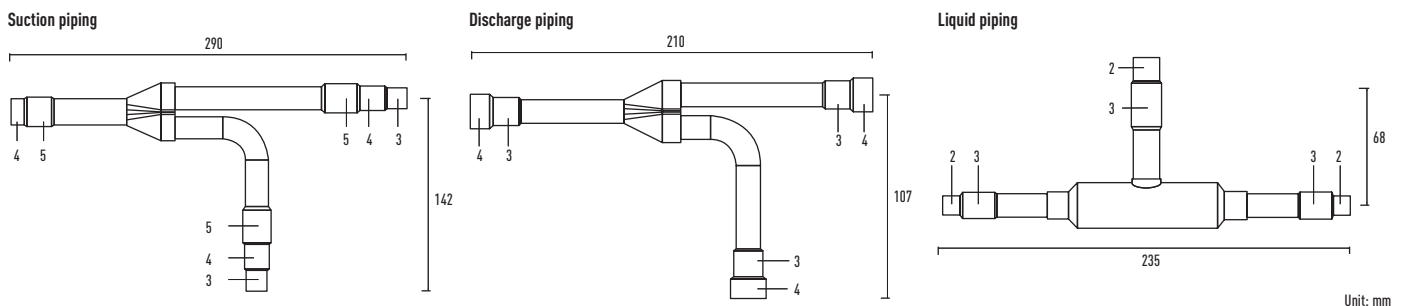

## Size of connection point on each part (shown are inside diameters of piping)

Size	Part 1	Part 2	Part 3	Part 4	Part 5	Part 6	Part 7	Part 8	Part 9	Part 10	Part 11	Part 12	Part 13	Part 14	
Dimension	mm	6,35	9,52	12,70	15,88	19,05	22,40	25,40	28,57	31,75	34,92	38,10	41,28	44,45	50,80
	Inches	1/4	3/8	1/2	5/8	3/4	7/8	1	1 1/8	1 1/4	13/8	11/2	15/8	13/4	2

**4. CZ-P680BH2BM**

For indoor unit side (capacity after distribution joint is greater than 22,40kW and no more than 68,00kW).

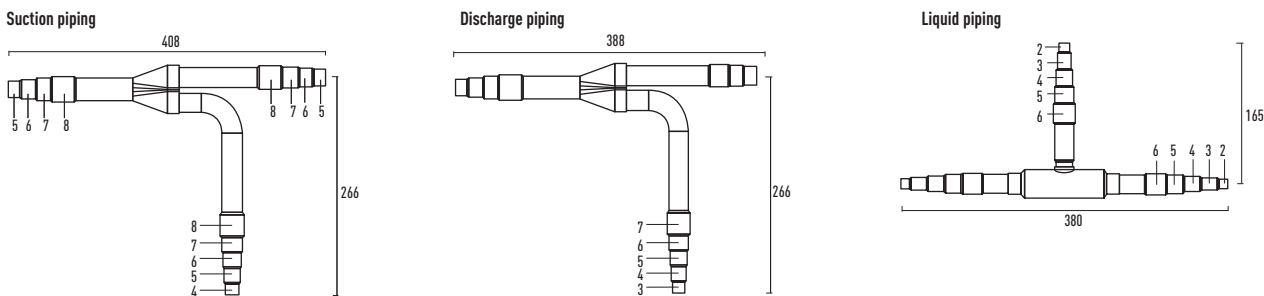

Unit: mm

**5. CZ-P1350BH2BM**

For indoor unit side (capacity after distribution joint is greater than 68,00kW and no more than 135,00kW).

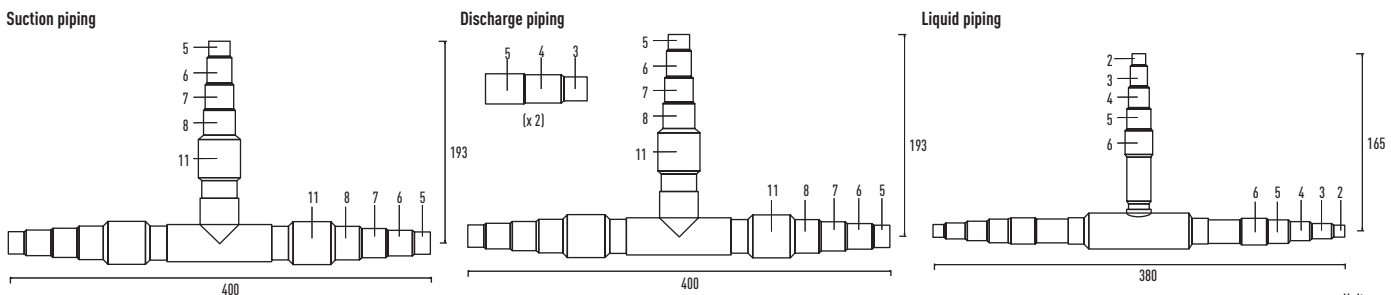

Unit: mm

**Header pipe set for 3-Pipe ECOi EX MF3 Series**

**CZ-P4HP3C2BM**

Header pipe model for 3-Pipe systems.

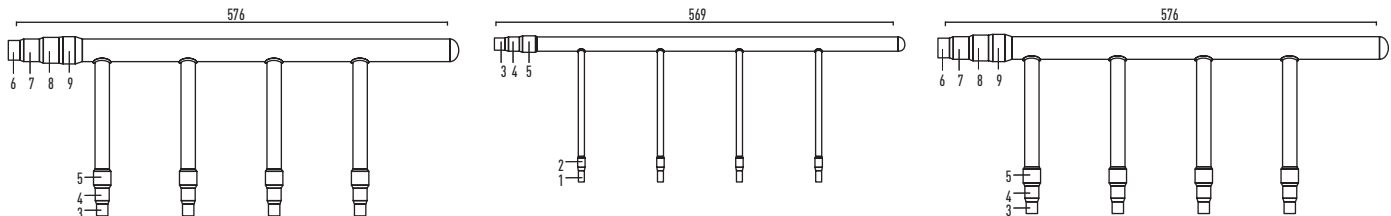

Size of connection point on each part (shown are inside diameters of piping)

Size		Part 1	Part 2	Part 3	Part 4	Part 5	Part 6	Part 7	Part 8	Part 9	Part 10	Part 11
Dimension	mm	6,35	9,52	12,70	15,88	19,05	22,40	25,40	28,57	31,75	34,92	38,10
	Inches	1/4	3/8	1/2	5/8	3/4	7/8	1	1 1/8	1 1/4	13/8	11/2

**Distribution joint Kits for Mini ECOi LE Series**

**CZ-P160BK2**

For indoor unit (capacity after distribution joint is 22,40kW or less).

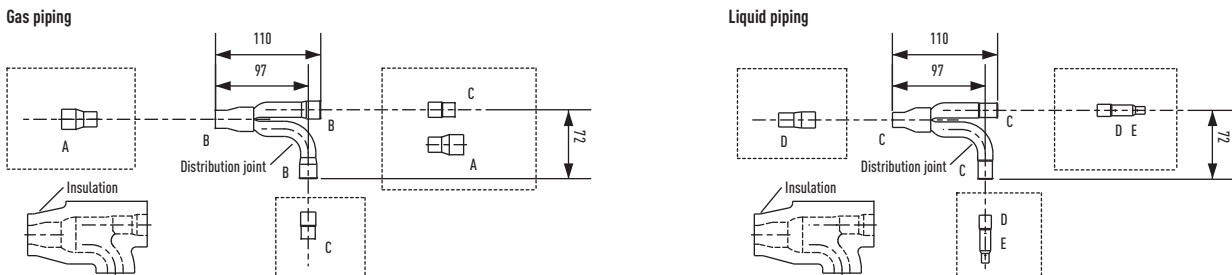

Unit: mm

Size of connection point on each part (shown are inside diameters of piping)

Size		Part A	Part B	Part C	Part D	Part E
Dimension	mm	19,05	15,88	12,70	9,52	6,35
	Inches	3/4	5/8	1/2	3/8	1/4

# ACCESSORIES & CONTROL

## Distribution Joint Kits

### CZ-P680PH2BM

2-Pipe ME2 Series distribution joint kit for outdoor unit (68,00kW or less).

### CZ-P1350PH2BM

2-Pipe ME2 Series distribution joint kit for outdoor unit (more than 68,00kW).

### CZ-P160BK2BM

2-Pipe ME2 Series and Mini ECOi LE Series distribution joint kit for indoor unit (22,40kW or less\*).

### CZ-P680BK2BM

2-Pipe ME2 Series distribution joint kit for indoor unit (68,00kW or less\*).

### CZ-P1350BK2BM

2-Pipe ME2 Series distribution joint kit for indoor unit (more than 68,00kW\*).

### CZ-P680PJ2BM

3-Pipe ECOi EX MF3 Series distribution joint kit for outdoor unit (68,00kW or less).

### CZ-P1350PJ2BM

3-Pipe ECOi EX MF3 Series distribution joint kit for outdoor unit (greater than 68,00kW and no more than 135,00kW).

### CZ-P224BH2BM

3-Pipe ECOi EX MF3 Series distribution joint kit for indoor unit (22,40kW or less).

### CZ-P680BH2BM

3-Pipe ECOi EX MF3 Series distribution joint kit for indoor unit (greater than 22,40kW and no more than 68,00kW).

### CZ-P1350BH2BM

3-Pipe ECOi EX MF3 Series distribution joint kit for indoor unit (greater than 68,00kW and no more than 135,00kW).

### CZ-P4HP3C2BM

3-Pipe ECOi EX MF3 Series header pipe.

\* In case the total capacity of indoor units connected after distribution exceeds the total capacity of the outdoor units, select the distribution piping size for the total capacity of the outdoor units.

## Heat Recovery Box

### KIT-P56HR3

Box recovery kit up to 5,60kW (CZ-P56HR3 + CZ-CAPE2).



### KIT-P160HR3

Box recovery kit from 5,60kW (CZ-P160HR3 + CZ-CAPE2).

### CZ-P56HR3

Heat recovery box up to 5,60kW.

### CZ-CAPE2

Heat recovery PCB.



### CZ-P160HR3

Solenoid valve kit up to 10,60kW.

### CZ-P456HR3

4 ports 3 pipe box up to 5,60kW.

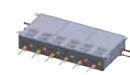

### CZ-P4160HR3

4 ports 3 pipe box up to 16,00kW.

### CZ-P656HR3

6 ports 3 pipe box up to 5,60kW.

### CZ-P856HR3

8 ports 3 pipe box up to 5,60kW.

## Individual Controls



### CZ-RTC5B

Design wired remote controller with Econavi button and datanavi.



### CZ-RTC2

Standard wired remote controller for Floor Standing (MP1).



### CZ-RWS3 + CZ-RWRU3

Wireless remote control for 4 Way 90x90 Cassette.



### CZ-RWS3

Wireless remote control for Wall Mounted and 4 Way 60x60 (with CZ-KPY3AW).



### CZ-RWS3 + CZ-RWRL3

Wireless remote controller for 2 Way Cassette.



### CZ-RWS3 + CZ-RWRD3

Wireless remote controller for 1 Way Cassette.



### CZ-RWS3 + CZ-RWRT3

Wireless remote control for Ceiling.



### CZ-RWS3 + CZ-RWRC3

Wireless remote control for all indoor units.



### CZ-CSRC3

Temperature remote sensor.



### CZ-RE2C2

Simplified remote control.

## Controller for Hotels with Dry Contacts



**PAW-RE2C3-WH**  
Stand-Alone with I/O White frame.

**PAW-RE2C3-MOD-WH**  
Modbus RS-485 with I/O White frame.

**PAW-RE2C3-LON-WH**  
LonWorks TP/FT-10 with I/O White frame.

**PAW-RE2C3-GR**  
Stand-Alone with I/O Grey Frame.

**PAW-RE2C3-MOD-GR**  
Modbus RS-485 with I/O Grey frame.

**PAW-RE2C3-LON-GR**  
LonWorks TP/FT-10 with I/O Grey frame.

## Centralized Controllers



**CZ-64ESMC3**  
System Controller with Schedule timer. Operation with various function from center station.



**CZ-ANC3**  
Central On/Off controller, up to 16 groups, 64 indoor units.



**CZ-256ESMC3**  
Simplified load distribution ratio (LDR) for each tenant. Intelligent Controller (Touch screen panel).

## Centralised Controls. BMS System. PC Base



**CZ-CSWK2**  
PAIMS Basic software.



**CZ-CSWAC2**  
PAIMS Consumption calculation control.

**CZ-CSWGC2**  
PAIMS - Layout display.



**CZ-CAPDC2**  
Serial parallel device controlling outdoor units, up to 4 units.



**CZ-CAPC3**  
Adaptor for On/off control of external devices.



**CZ-CAPBC2**  
Mini series parallel device controlling indoor units, maximum 1 group and 8 indoor unit.



**CZ-CFUNC2**  
Communication Adaptor. Up to 128 groups. Controls 128 units.

**CZ-CFUNC2**  
Communication adaptor.

**CZ-CSWBC2**  
PAIMS - BACnet interface.

**CZ-CSWWC2**  
PAIMS - Web application.

## Centralised Controls. Connection with 3rd Party Controller

Panasonic AC Smart Cloud



**CZ-CFUSCC1**  
Panasonic AC Smart Cloud. Cloud internet control. Up to 128 groups. Controls 128 units.

**PAW-MVNOAC-V**  
**PAW-MVNOAC-K**  
3G communication package (SIM Card included). V, K. Depending on countries.

VRF Smart Connectivity



**SER8150R0B1194**  
Remote Controller  
Panasonic Net Con, RH, No PIR, R1/R2.

**SER8150R5B1194**  
Remote Controller  
Panasonic Net Con, RH, PIR, R1/R2.

**VCM8000V5094P**  
Wireless Zigbee Pro module / Green Com card.



**SED-WDC-G-5045**  
Door / window wireless sensor.



**SED-MTH-G-5045**  
Wall / ceiling (motion) wireless sensor.



**SED-CO2-G-5045**  
CO<sub>2</sub> sensor.



Accessories Cables



**CZ-T10**  
Cable for all the T10 functions.



**PAW-FDC**  
Cable to operate external EC fan.



**PAW-OCT**  
Cable for all option monitoring signals.

**PAW-EXCT**  
Cable with force Thermo OFF/leakage Detection.

Accessories PCB



**PAW-T10**  
All T10 functions.



**PAW-PACR3**  
Redundancy of 2 or 3 systems; for PACi and ECOi.

**PAW-ECF**  
PCB for fan speed control of external EC Fan.

Accessories Interfaces



**PAW-RC2-KNX-1i**  
KNX Interface.

**PAW-AC-KNX-64**  
KNX Interface for 64 indoors.

**PAW-AC-KNX-128**  
KNX Interface for 128 indoors.



**PAW-AC-BAC-1**  
BACnet Interface for 1 unit.

**PAW-AC-BAC-64**  
BACnet Interface for 64 indoor units.

**PAW-AC-BAC-128**  
BACnet Interface for 128 indoor units.



**PAW-RC2-MBS-1**  
Modbus Interface.

**PAW-AC-MBS-64**  
Modbus Interface for 64 indoors.

**PAW-TM-MBS-RTU-64**  
Modbus Interface for 64 indoors.



**PAW-RC2-MBS-4**  
Modbus interface to control 4 indoor/groups.

**PAW-AC-MBS-128**  
Modbus Interface for 128 indoors.

**PAW-TM-MBS-TCP-128**  
Modbus Interface for 128 indoors.



**PAW-MBS-TCP2RTU**  
ModBus RTU Slave devices.



**CZ-CAPRA1**  
RAC interface adapter for integration into P Link.



**PAW-RC2-ENO-1i**  
EnOcean Interface.



**CZ-CLNC2**  
Lonworks® Interface controls up to 16 groups and 64 indoor units.



**PA-RC2-WIFI-1**  
Interface for IntesisHome for PACi and ECOi.

Pump Down System



**PAW-PUDME1A-3**  
ECOi 2-Pipe Pump down for 3 outdoor units system.

**PAW-PUDMF2A-1**  
ECOi 3-Pipe Pump down for 1 outdoor unit system.

**PAW-PUDME1A-1**  
ECOi 2-Pipe Pump down for 1 outdoor unit system.

**PAW-PUDMF2A-2**  
ECOi 3-Pipe Pump down for 2 outdoor units system.

**PAW-PUDME1A-2**  
ECOi 2-Pipe Pump down for 2 outdoor units system.

**PAW-PUDMF2A-3**  
ECOi 3-Pipe Pump down for 3 outdoor units system.

**PAW-PUDME1A-1R**  
ECOi 2-Pipe Pump down for 1 outdoor unit system + Receiver Kit 30L.

**PAW-PUDME1A-2R**  
ECOi 2-Pipe Pump down for 2 outdoor units system + Receiver Kit 30L.

**PAW-PUDME1A-3R**  
ECOi 2-Pipe Pump down for 3 outdoor units system + Receiver Kit 30L.

**PAW-PUDMF2A-1R**  
ECOi 3-Pipe Pump down for 1 outdoor unit system + Receiver Kit 30L.

**PAW-PUDMF2A-2R**  
ECOi 3-Pipe Pump down for 2 outdoor units system + Receiver Kit 30L.

**PAW-PUDMF2A-3R**  
ECOi 3-Pipe Pump down for 3 outdoor units system + Receiver Kit 30L.

**PAW-PUDRK30L**  
Receiver Kit 30L.

R-22 Replacement Kit

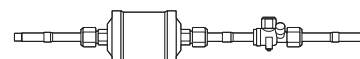

**CZ-SLK2**  
Replacement kit for R-22.

Other Accessory



**CZ-CENSC1**  
Econavi energy savings sensor.

Fan coil Controller



**PAW-FC-303TC**  
Fan coil control.

# CONTROL AND CONNECTIVITY

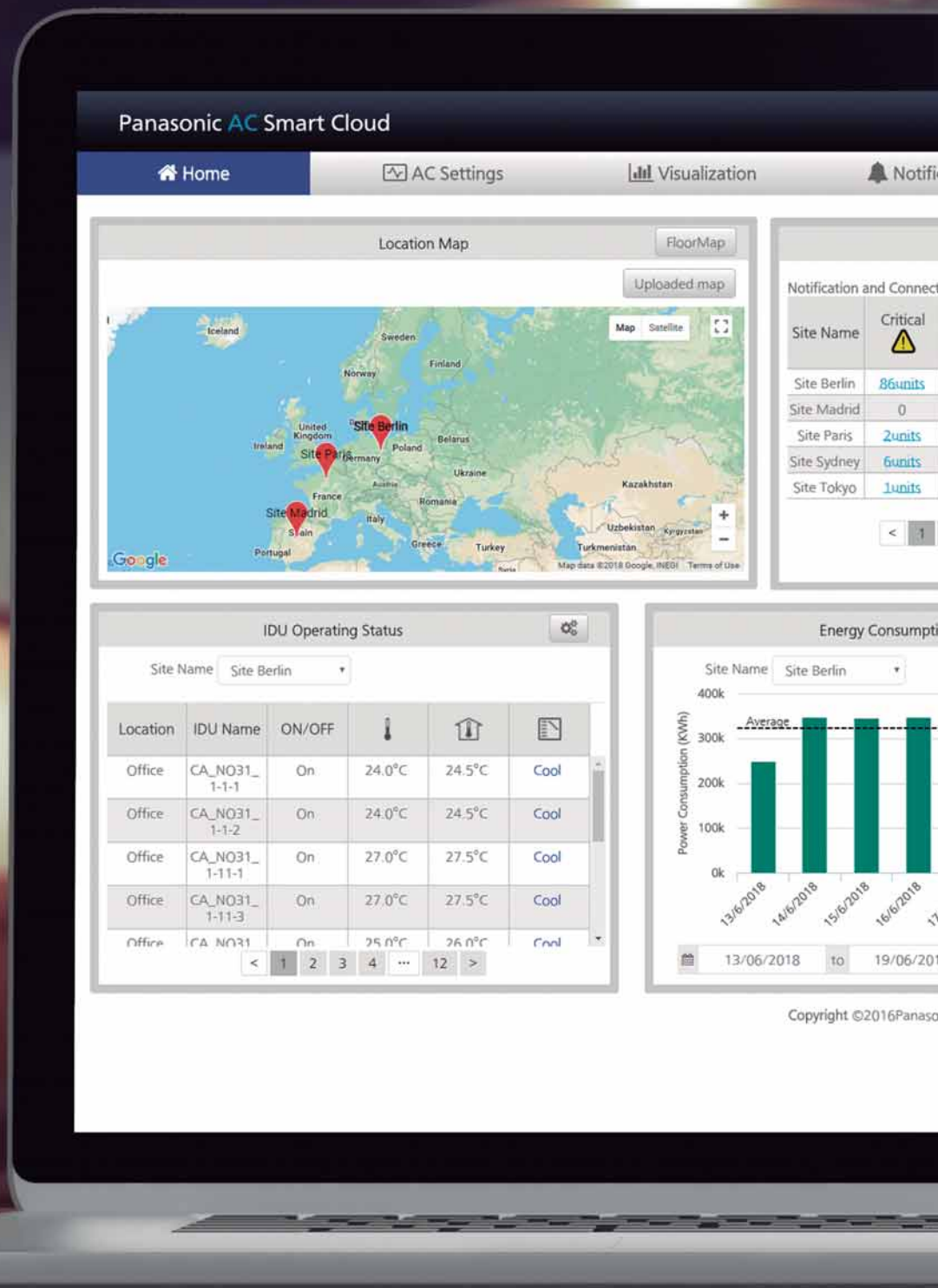

**Panasonic AC Smart Cloud**

Home | AC Settings | Visualization | Notification

---

**Location Map** FloorMap Uploaded map

Map Satellite

**Notification and Connect**

Site Name	Critical
Site Berlin	86units
Site Madrid	0
Site Paris	2units
Site Sydney	6units
Site Tokyo	1units

---

**IDU Operating Status**

Site Name: Site Berlin

Location	IDU Name	ON/OFF	🌡️	🏠	📄
Office	CA_NO31_1-1-1	On	24.0°C	24.5°C	Cool
Office	CA_NO31_1-1-2	On	24.0°C	24.5°C	Cool
Office	CA_NO31_1-11-1	On	27.0°C	27.5°C	Cool
Office	CA_NO31_1-11-3	On	27.0°C	27.5°C	Cool

---

**Energy Consumption**

Site Name: Site Berlin

Power Consumption (KWh)

13/6/2018 to 19/6/2018

Average: 300k

Copyright ©2016Panaso

Panasonic has developed the largest range of control systems to offer the best option for commercial need.

From the individual remote control for the residential single units up to the newest technology to control each your buildings around the world from an easy to use software in the cloud by your portable device.



User\_0001, Customer-

Notification

Notification Status

Non-Critical	IDU Connection	
44 units	110	2
4 units	8	0
2 units	7	0
2 units	4	0
0	0	0

New Notification (Today & Yesterday)

Occured time	Site Name	Location	Device Name	Alarm Code	View in Map
20/06/2018 04:25	Site Berlin	Shop	CA_NO22_1-19-17	C17	-
20/06/2018 04:25	Site Berlin	Shop	CA_NO22_1-30-1	C17	-
20/06/2018 04:25	Site Berlin	Shop	CA_NO22_1-29-1	C17	-
20/06/2018 04:25	Site Berlin	Shop	CA_NO22_1-27-1	C17	-

Hourly Consumption (Today vs Yesterday)

Site Name: Site Berlin | VRF

Power Consumption (KWH)

20k, 15k, 10k, 5k, 0k

Today (blue bars), Yesterday (red bars)

8 | Compare

micCorporation

# VRF SMART CONNECTIVITY+

Life Is On





Through thorough energy management, Panasonic's VRF Smart Connectivity is a completely new, state-of-the-art solution providing energy saving and comfort as well as simple installation, operation and running.

VRF Smart Connectivity+ offers efficient energy management and a new air conditioning control solution with high IAQ (Indoor Air Quality).

<p><b>Energy Management System for Rooms</b></p>	<p>Each room is monitored by high-precision sensors, making it possible to make every room's temperature comfortable without wasting energy.</p>
<p><b>Management System for the Entire Building</b></p>	<p>A Building Energy Management System (BEMS) can also be connected for Plug &amp; Play centralised control of the building's entire energy consumption.</p>

### Advantages



#### Dramatic Reduction of OpEx with Outstanding IAQ.

- 3 Built-in sensors: Temperature, RH and Occupancy
- ZigBee wireless sensors: CO<sub>2</sub> / Temperature / RH%, window / door, ceiling / wall



#### User-/Owner-friendly.

- Colour touch screen
- Ease and simply of use
- 22 Languages
- Easy-to-understand error description



#### Ultimate Customisation.

- Background colour customisable
- Custom display/icons, messages
- Programmable logic (also stand alone)
- Various controls and various external connection devices



#### Easy Design and Plug and Play to Reduce CapEx.

- Simple Plug & Play VRF connection to Building Energy Management System (BEMS)
- Stand alone or BEMS connected
- Easy Installation of ZigBee Sensors

### VRF Smart Connectivity+: New SE8000.

#### 1 Quality Air Control

Optimum IAQ is realized using the CO<sub>2</sub> and humidity sensors. The interior remains comfortable, while heating and cooling costs are minimized.

The CO<sub>2</sub> sensor controls ventilation systems which contributes to improving the room's air quality.

#### 2 Room Key Card or Key Cardless Solutions for Hotels

Solutions are provided that meet the needs of various regions and hotel grades.

Whilst the previous model's automatic detection function offered optimal air conditioning with or without a hotel room key card, the latest model enables conventional key cards to control air conditioners and other devices coordinately. The increase in the types of devices that can be connected enables customized control of any hotel room.



#### 3 Other Equipment Control

One room controller manages various devices including lighting and the blinds.

A ventilation system and other external connection devices (dry contact input) can be connected by HRC or TE2 devices so that various control is possible with this controller alone, even without BEMS.

# ENERGY MANAGEMENT SYSTEM FOR ROOMS

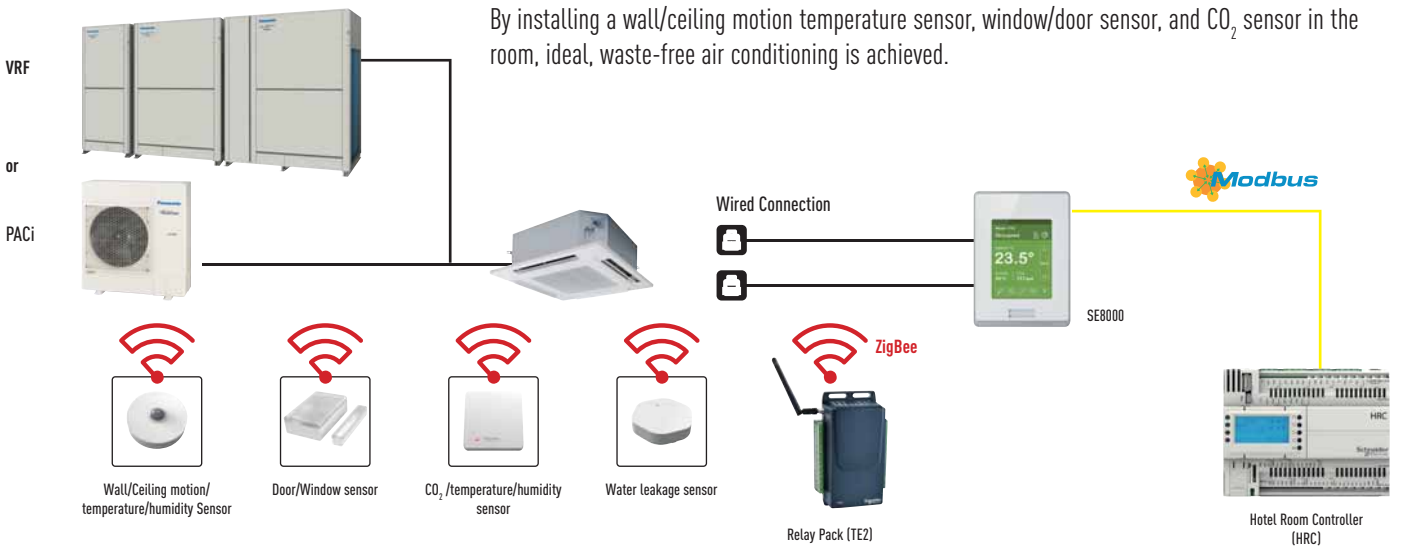

## Sensing & Control technology

Using sensors from Schneider Electric, high-quality occupancy control and automatic IAQ control were realised. The sensors detect the presence or absence of occupants, and the opening and closing of doors and windows to achieve the most efficient energy management for exceptional air-conditioned comfort.

Flexible installation is possible to match different applications and building features such as walls, ceilings and proximity to doors and windows. No wiring means extra installation versatility.

Batteries last for up to five years (10-year battery for CO<sub>2</sub> sensor) and are easy to install and replace.

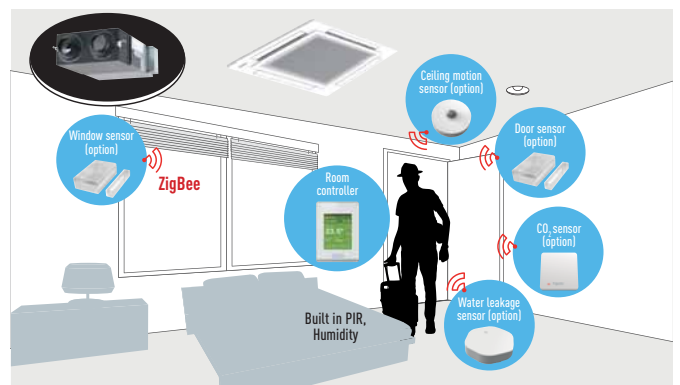

**Door/Window sensor**  
Door and window contact detection sensor to monitor opening and closing.

**Wall/Ceiling motion/temperature/humidity Sensor**  
Wall and ceiling sensor to detect the presence or absence of occupants.

**CO<sub>2</sub>/temperature/humidity sensor**  
Monitor indoor air quality, review data on interfacing devices, and control fresh air inside customizable zones.

**Water leakage sensor**  
Two sensing pads under the body activate when water is present between the two pads. Detecting the water, the sensor reports the event to the controller.

**Relay Pack (TE2)**  
Wireless programmable terminal equipment controllers for HVAC equipment and pulse counting. Includes local memory to store fail safe control sequence.

**Hotel Room Controller (HRC)**  
The Hotel Room Controller controls connected guest room devices and aggregates data, making it visible to guest room and property management systems.

# MANAGEMENT SYSTEM FOR THE ENTIRE BUILDING

The smarter solution to simplify energy management, optimise building efficiency and drive savings.

## Plug and Play BEMS connection

With the SE8000, connection to BEMS is extremely easy. Better still, a remote controller is all that's needed to enable use as a stand-alone system. In addition to dramatically reducing the burden on system integrators, this cuts costs.

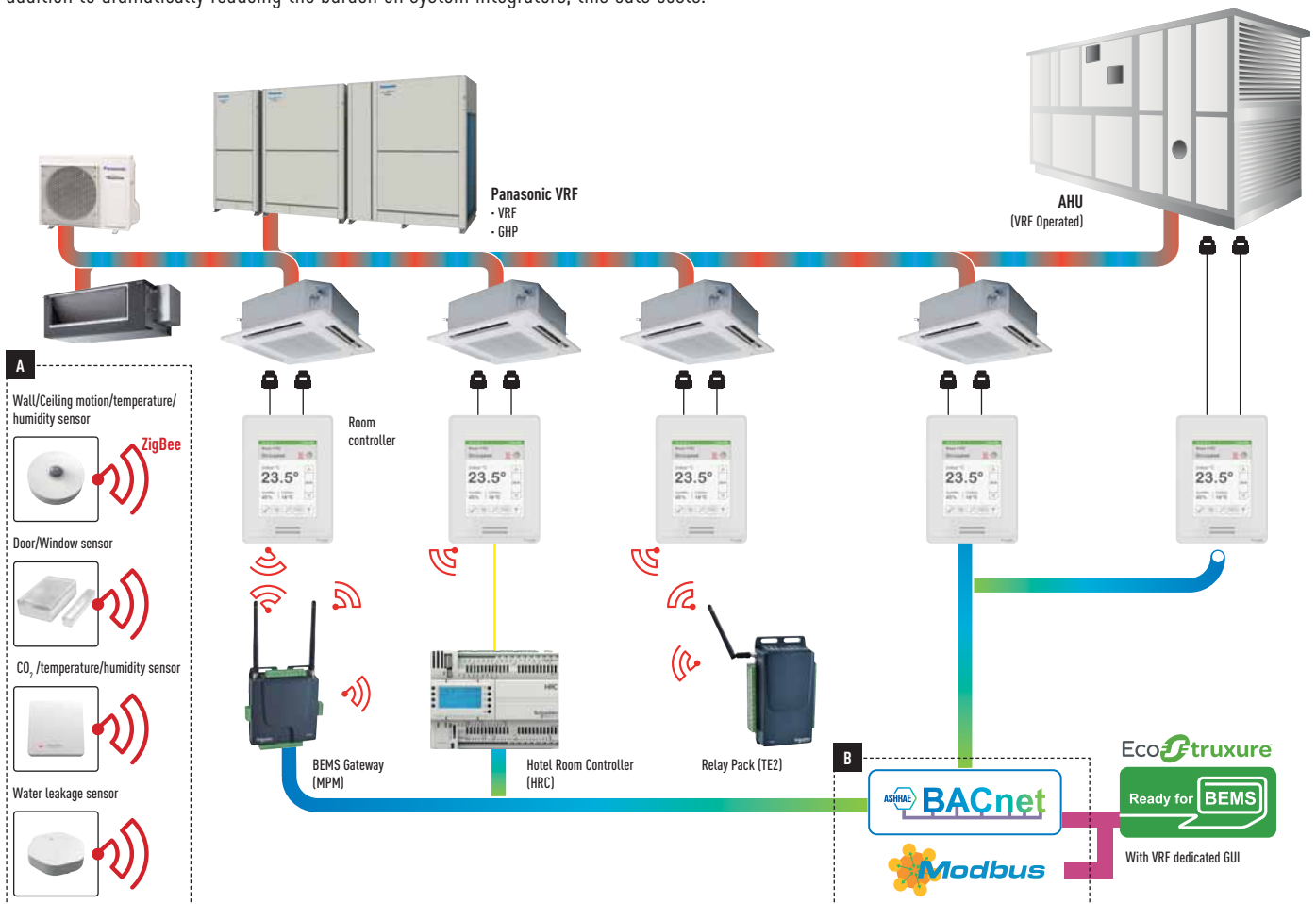

**A** SE8000 smart controller with direct hub to ZigBee® Pro sensors. Great Occupancy and IAQ control. Ex: Hotel room occupancy check by PIR sensor, IAQ by CO<sub>2</sub> sensor, Door / Window contacts.

**B** BACnet MS/TP and Modbus RTU are embedded.

**C** For Schneider Electric BEMS connection, Panasonic VRF widgets enable easy Plug and Play. Better understanding for VRF as a chiller system.

**BEMS Gateway (MPM)**  
Multi-Purpose Management devices enable the control, monitoring, and management of entire sites via Schneider Electric's BMS system.

**BEMS Widget (Exclusive)**

\* Graphic shows combination of products from Panasonic, Schneider Electric and others. Please consult authorised dealer for more details.

Reference	Description
SER8150R081194	Pana Net Con, RH, No PIR, SE Brand, R1R2
SER8150R5B1194	Pana Net Con, RH, PIR, SE Brand, R1R2
VCM8000V5094P	Wireless ZigBee Pro communication card
<b>TE2*</b>	
SEC-TEA-R-230-5045	Smart Terminal Controller ZigBee Pro High Power, External Antenna, 4U/4AO/5DO, 220-240VAC
SEC-TEA-R-24-5045	Smart Terminal Controller ZigBee Pro High Power, External Antenna, 4U/4AO/5DO, 24VAC

Reference	Description
<b>MPM*</b>	
MPM-UN-014-5045	Universal network controller with Building Expert and StruXureWare integration, High Power, 6 I /6O, Modbus
MPM-RAEC-5045	Universal network controller Cable extension
<b>HRC*</b>	
HRCEP14R	Hotel Room Expansion Module 14IO
HRCPB628R	Hotel Room Controller 28IO
HRCPD642R	Hotel Room Controller w/Display 42IO

Reference	Description
<b>ZigBee Sensors</b>	
SED-CO2-G-5045	Sensor with room CO <sub>2</sub> , temperature and humidity
SED-TRH-G-5045	Sensor with room temperature and humidity
SED-WDC-G-5045	Door/window sensor
SED-MTH-G-5045	Wall/ceiling motion/temperature/humidity sensor
SED-WLS-G-5045	Water leakage sensor

\* Those accessories require system integrator support on site.

# SMART MANAGEMENT SOLUTIONS

## 1 Hotels

### Room Key Card or Key Cardless Solutions for Hotels.

The SE8000 and ZigBee Sensor automatic detection function offer optimal air conditioning regardless of whether there is a hotel room key or not. Sensors detect the presence or absence of occupants and the opening and closing of doors and windows for the optimum air-conditioned environment guests expect. Automatic control ensures the most efficient operation when guests are away or when windows are open. This contributes to an appreciable reduction in operation costs.



#### 1. Remote sensing & IAQ control.

In addition to detecting a room's temperature, humidity and CO<sub>2</sub> concentration, ZigBee remote sensors detect the opening/closing of windows and doors, and the presence/absence of people in a room. Various IAQ controls and detailed energy savings are possible by using TE2 (Relay Pack) based on this detected information.

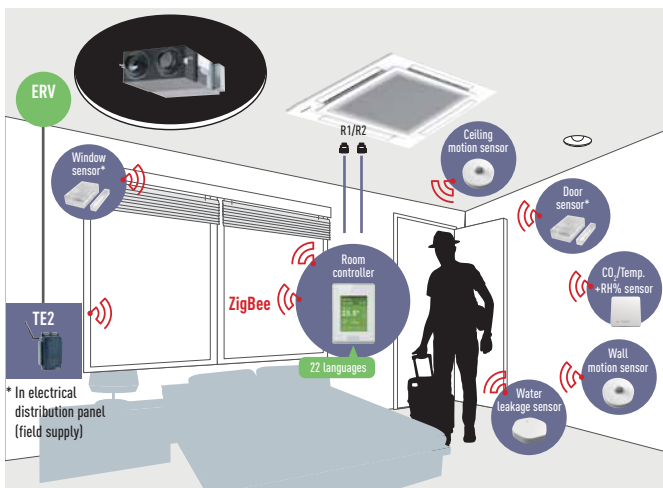

#### 2. BEMS Connectivity.

With MPM as the BEMS gateway and by setting HRC as the guestroom controller, sensing, control and BEMS connection can be realized in coordination with SE8000!

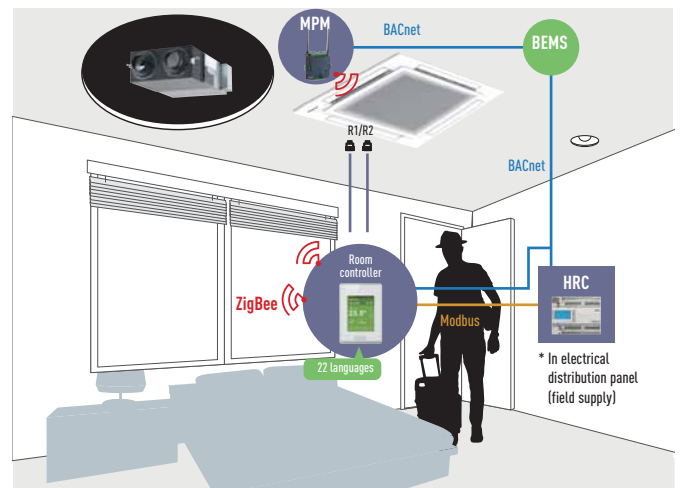

#### 3. Key Cardless control.

The introduction of TE2 and HRC enables conventional wired keycards to be connected to the system so that it is possible to meet the specific requirements of various hotel and room types.

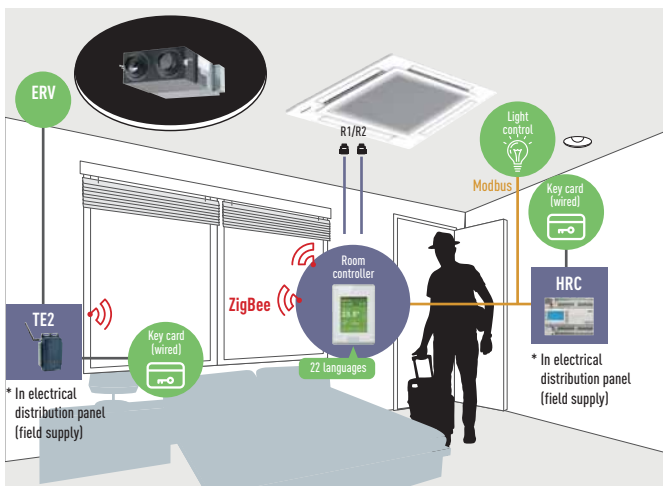

#### 4. Other control

The introduction of TE2, HRC and MPM enables the on/off control of devices having dry contact input, such as ventilation, lighting and blinds.

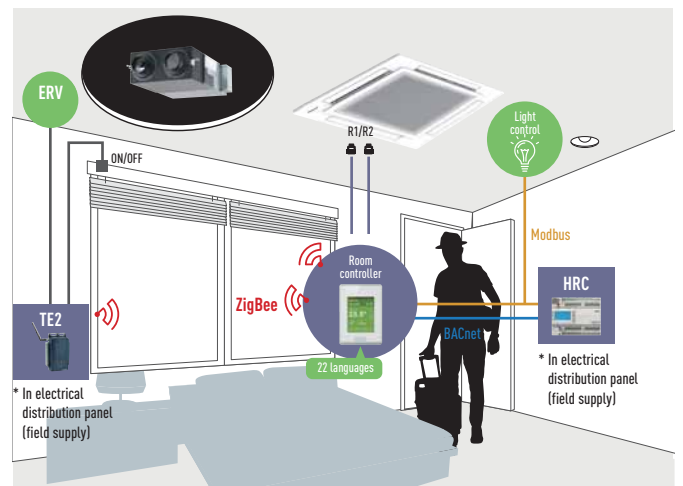

## 2 Small and medium offices

### CO<sub>2</sub> sensors (option) and Humidity sensors.

CO<sub>2</sub> sensors (option) take measurements in units of ppm, and humidity sensors enable fine air quality control. This creates the most comfortable space for occupants while contributing to improved employee satisfaction.



## 3 Super markets

### Humidity sensors.

Humidity sensors enable automatic dehumidification for the optimum IAQ regardless of climatic conditions. This creates an even more comfortable environment for customers, employees, and products themselves.



### Innovative and unrivalled advantages

#### Colour and design to match office interiors.

Colour combinations and design can be set to match different facilities.



#### Easy-to-understand error description.

Error description during an emergency is easy to understand, enabling staff to respond quickly.



#### Customisation in 22 languages possible.

The display can be customised to match the native languages of guests to enable smooth, stress-free communication for hospitality at its finest.



#### Programmable logic.

Full customisation of remote control logic possible, and updating to match conditions.

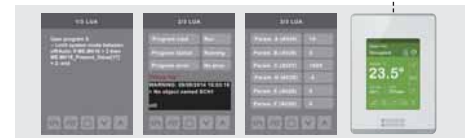

### Smart connectivity devices

	<b>SED-WDC-G-5045</b> Door/window sensor		<b>SED-MTH-G-5045</b> Wall/ceiling motion/temperature/humidity sensor
	<b>SED-CO2-G-5045</b> CO <sub>2</sub> temperature/humidity sensor		<b>SED-WLS-G-5045</b> Water leakage sensor

ZigBee communication card  
VCM

Schneider Electric brand - SE8000

\*With optional VCM communication card.

### Features

- Up to 5-year battery life batteries included
- Battery life of CO<sub>2</sub> sensor up to 10-year.
- Battery level is a point
- Sensor points visible when SE8000 is integrated via BACnet MS/TP
- Sensor status and battery level visible when SE8150 is integrated via ZigBee® Pro
- Integration to BMS only recommended when each MPM is connected to Ethernet and set as a ZigBee® Coordinator node

# PANASONIC AC SMART CLOUD



## Flexible solution and scalable solution

- Energy saving
- Zero downtime
- Site(s) management

Centralize control of your business premises, from wherever you are, 24/7/365. It doesn't matter how many sites you have, or where they are! The AC Smart Cloud system from Panasonic allows you to have complete control of all your installations, from your tablet or from your computer. In a simple click, all your units from several locations, receive status updates in real-time of all your installations, preventing breakdowns and optimizing costs.

## Flexible solution for your business.



Every time



Everywhere



Multiplatform



Internet browser

## Scalable solution for your business.



Small to large



1 to multi sites



Upgrade features\*



PACi / ECOi / ECO G

\*Customized to meet user demand / Upgraded new functions / Upgraded by new products / IT smart management.

## Panasonic AC Smart Cloud offers continuous improvement always thinking about users

### New update from July 2018.

#### Home Screen



- 3 blocks can be set with preferred information by users on home screen
- Home screen meets your needs well and this screen keeps as customized for you

#### Schedule function



- Simple and intuitive page transition to make schedule setting easier
- Quick user guide for quick understanding

#### Location map display

Site location with online map service.

#### Floor map edit

Uploading new floor map. Edit floor maps.

#### Selectable zone. 3 preferred elements can be selected in 7 options.

1. IDU Operating Status
2. Energy Consumption graph
3. Weather information
4. Power usage vs target
5. Consumption figure vs yesterday
6. Efficiency
7. ECO-friendly Building Graph

With Panasonic AC Smart Cloud, have your business under control, and start saving!



**Key functions and uniqueness**

**Multi site monitoring.**

- It doesn't matter how many sites you have, easy to manage, operate, compare per sites, locations, rooms.



**Powerful statistics for energy savings.**

- Power consumption, capacity, efficiency level can be compared per different parameters (Yearly / monthly / weekly/ daily bases)



**Schedule setting.**

- Weekly / holiday timer setting as you want
- One setting can be copied to other sites
- Quick manual is available



**Maintenance notification.**

- Error notification by email and with floor layout
- Maintenance notification of ECOi / ECO G outdoor units
- **NEW!** Remote service checker function



**User customization.**

Site administrator can create users as desired and assign customized profiles.

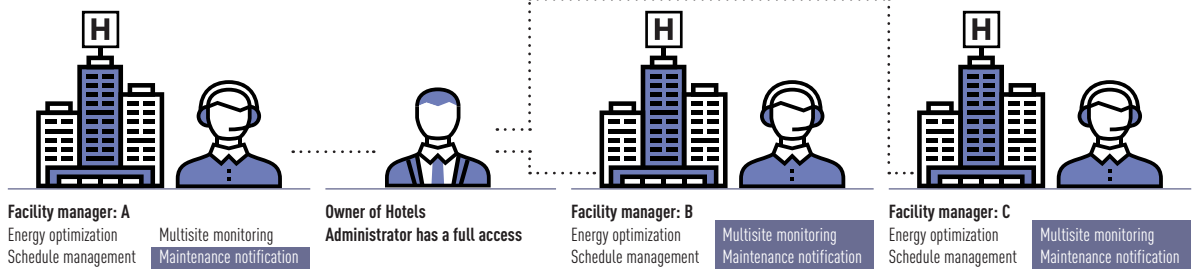

**One of our uniqueness is "Stable and secured communication package"**

- Connectivity is included in the stable service. Customers do not have to take time to find and prepare suitable connectivity.
- With an all inclusive service offering, the customer has peace of mind and a one stop shop for all AC Smart Cloud issues they may face including connectivity



**New remote service checker function**



**Zero down time**

- Quick analysis & response
- Time & Cost saving for service maintenance task

**Recording service checker parameters from wherever you are!**

- Data duration: Max. 120 minutes
- Data frequency: 10 – 90 seconds
- Mode selection: With test run or Without test run
- Count down schedule setting available

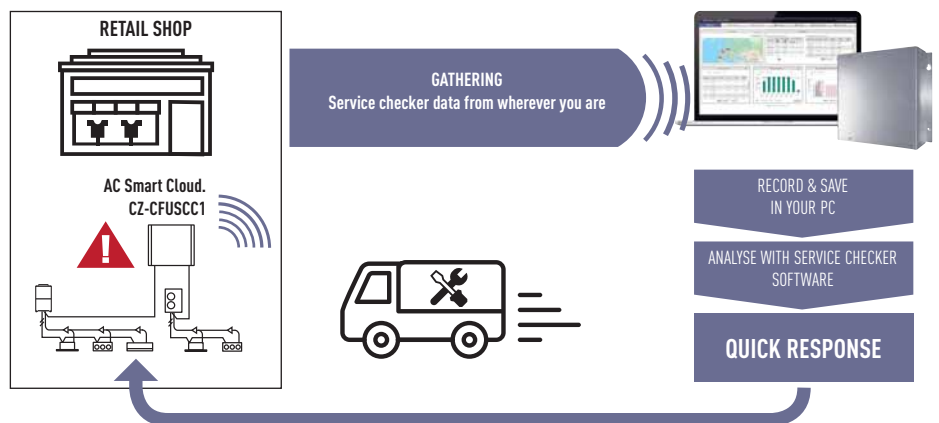

**Panasonic AC Smart Cloud parts lists**

\* Cloud service fee is additionally required. Please contact an authorized Panasonic dealer.

<b>CZ-CFUSCC1</b>	AC Smart Cloud communication adaptor. Up to 128 groups. 128 units control
<b>PAW-MVNOAC-V</b>	3G communication package (SIM Card included). V, K: Depending on countries <sup>1</sup>
<b>PAW-MVNOAC-K</b>	

<sup>1</sup>) Please contact an authorized Panasonic dealer.

# REMOTE CONTROLLER WITH ECONAVI





Easy to use, attractive, clear design, with new demand control functions and energy consumption display! This useful feature makes this remote control unique!

**Design**

The new CZ-RTC5B wired remote control is ideal for integration into the most demanding interior architectures. The touch panel features a very sleek and easy to use display, which with its compact display is only 120 x 120 x 16mm.

**Display of information**

The information is mainly based on pictograms to ensure easy understanding. The minimal amount of text is available in 6 languages (English / German / French / Spanish / Italian / Polish). The screen is back lit to enable reading even during the night.

**Easy Access to the menus.**

With the new pictograms, the navigation, the selection and the settings are simple and easy to follow.

**Key Functions**

- Easy setup of the timer and settings of the indoor unit
- Energy consumption display (for all R32 PACi line-up)
- Limitation of the energy consumption (Demand control) by timer.

**Basic function (Operation display & indication)**

All functions are easily available on the remote controller.

- OFF/ON timer • Weekly timer • Quiet operation • Remote control sensor • Operation prohibit • Filter sign • Energy saving • Centralized control indication • Mode change prohibit • Automatic temperature return • Temperature range limitation • OFF remind • Schedule demand control • Ventilation • Out Function

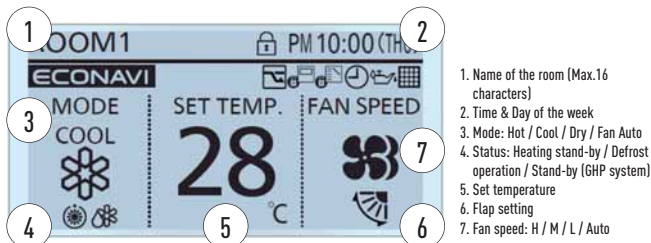

**Easy operation and quick access to all menus**

1. Set temperature will be selected, when any arrow button is touched
2. Select the item (Mode or Fan speed) by left/right ◀▶ key
3. Change the setting by up/down ▲▼ key

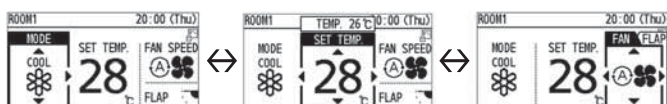

**Backup control by using CZ-RTC5B**

Group wiring of 2 systems of PACi can do auto individual control.

- Rotation operation
- Backup operation
- Support operation

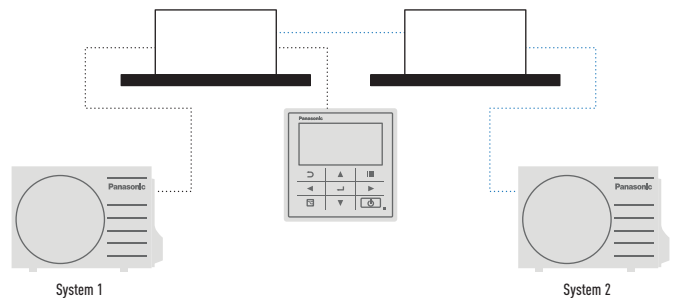

**Example of easy access to the functions: Air direction setting**

1. Select "Air direction" and press "determine" key
2. Select the unit number by up/down key
3. Select the flap position by up/down key
4. Press "Return" key to go back the Menu display

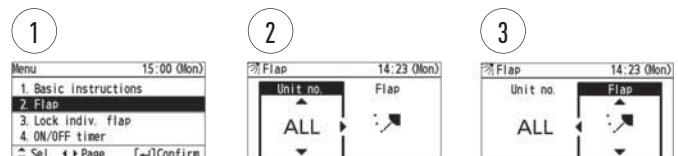

**Functions available on the CZ-RTC5B**

Control item	Controllability	Indoor Units		
		PACi Standard	PACi Elite	All VRF
Basic Operation	Operation, Mode, Temperature setting, Airflow volume, Airflow direction	✓	✓	✓
	Time display	✓	✓	✓
Timer function	Easy ON/OFF timer	✓	✓	✓
	Weekly Program timer	✓	✓	✓
Energy saving	Outing function	✓	✓	✓
	Temperature auto return	✓	✓	✓
	Temperature setting range limitation	✓	✓	✓
	OFF remind	✓	✓	✓
	Energy saving mode	✓	✓	✓
Maintenance	Schedule demand control	—	✓	✓
	Energy monitoring - R32	✓	✓	—
	System failure information	✓	✓	✓
	Service contact registration	✓	✓	✓
	Filter sign (rest time display) & Reset	✓	✓	✓
	Auto-address, Test run	✓	✓	✓
	Sensor value monitor	✓	✓	✓
	Simple / Detail setting mode	✓	✓	✓
	Key lock	✓	✓	✓
	Ventilation fan control	✓	✓	✓
Others	Display contrast adjustment	✓	✓	✓
	Remote controller sensor	✓	✓	✓
	Quiet operation mode	—	✓	—
	Prohibit setting control from Central controller	✓	✓	✓

All specifications subject to change without notice.

# NEW DATANAVI



Datanavi, a new way to connect.  
Simple and easy support tool with your smartphone.



<b>FAST AND INTUITIVE</b>	<b>EASY ACCESS TO MANUAL DATABASE</b>	<b>ACCURATE SERVICE DATA ON YOUR SMARTPHONE</b>
-----------------------------------	---	---

**Overview of datanavi system**

Just holding up your smartphone to the LED display on a remote controller (CZ-RTC5B) to receive useful AC system information super fast by Panasonic Light ID Technology. Datanavi also connects to Panasonic Cloud Server for the quick view of manuals, saving data received by Light ID.



**What is the Light ID technology developed by Panasonic?**  
Visible light transmission technology, which enables to transmit information by high-speed and invisible flashing of an LED light source.

**User / Administrator (person in charge of AC) functions**

- **Fast and intuitive.** Regular operation data, Energy consumption data display
- **Easy access to data base.** Getting manuals related on demand
- **No idea what to do when an error happens?** You can share error information and contact service easily



**Installer / Service company functions**

- **Getting technical data depends on your need**  
Service manual, Q & A list, Test run information
- **Accurate error information**



**Regular operation**

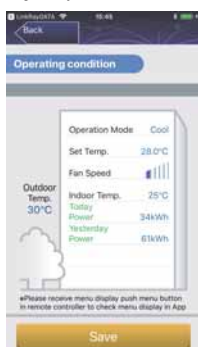

**Energy management**



**Malfunction notice**



**Operating manual**



**Test run info**

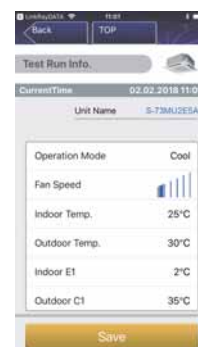

**Service data**



\* User interface image may be updated without notification.

Download free apps, try datanavi!  
2 free apps are necessary to use datanavi.

# ECONAVI SENSOR



The all Econavi Sensor detects presence in the room, and quietly adapts the PACi or VRF air conditioning system in order to improve comfort and energy savings.

- Detects human activity and adjusts temperature by 2 degrees (up or down) to optimize comfort and efficiency
- If there is no activity detected for a set time, the Econavi will stop the unit or move to a new temperature previously set
- The Econavi device is installed independently of the indoor unit, and is located in the area best suited for detection

**Applications**

Saving Energy for Offices: if the air conditioning is left on after the last employee leaves the office, Econavi will automatically react, reducing or stopping the system.  
 Increased comfort in hotel rooms: when presence is detected in the room, the temperature is automatically adjusted to achieve best comfort.

**Key points**

- Compatible with Cassette, Wall Mounted, Hide Away and Ceiling
- Improves efficiency
- Better Comfort
- Can be installed in the best place of the room for detection purposes

**Sensor location image**

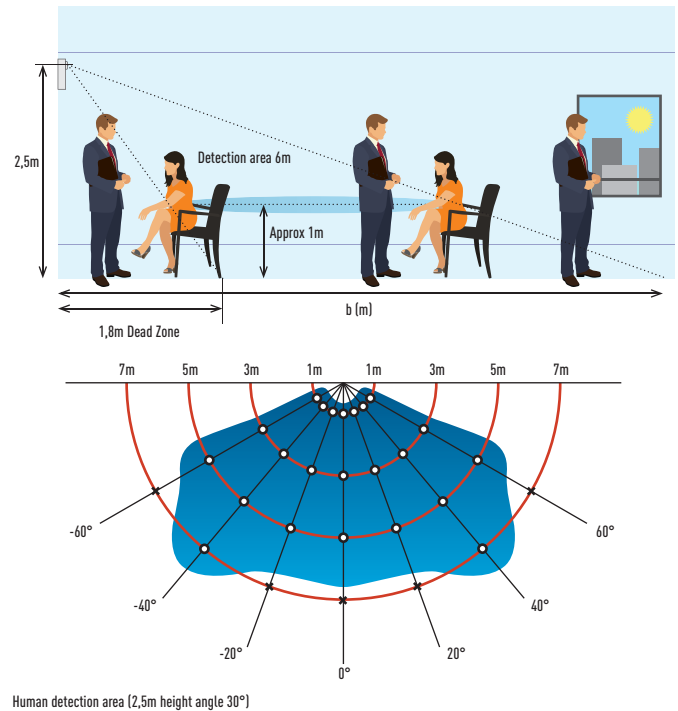

Providing outstanding energy-saving performance, Panasonic's Inverter system can be connected to Econavi to detect when energy is being wasted. Econavi senses the presence or absence of people and the level of activity in each area of an office. When unnecessary heating or cooling is detected, indoor units are individually controlled to match office conditions for energy-saving operation.

**Detection of the level of activity enables precise power saving.**

Presence or absence of people at their desks and the level of activity in the office are detected in real time. Set temperature is automatically adjusted to optimise the lower power consumption.



**Remote Econavi sensor allows optimum energy operation.**

Pillars, walls, cabinets and other fittings obstruct the sensor, reducing the area of detection and lowering the energy-saving effect. Taking into consideration blind spots, Panasonic enables the optimum layout for sensors in any office.



**In the morning.**  
Thorough cooling when there is a high level of activity

**In the afternoon.**  
Reduced cooling when there are fewer people

**At night.**  
Automatic Thermo Off depending on conditions at the end of the day

# INTELLIGENT CONTROLLER

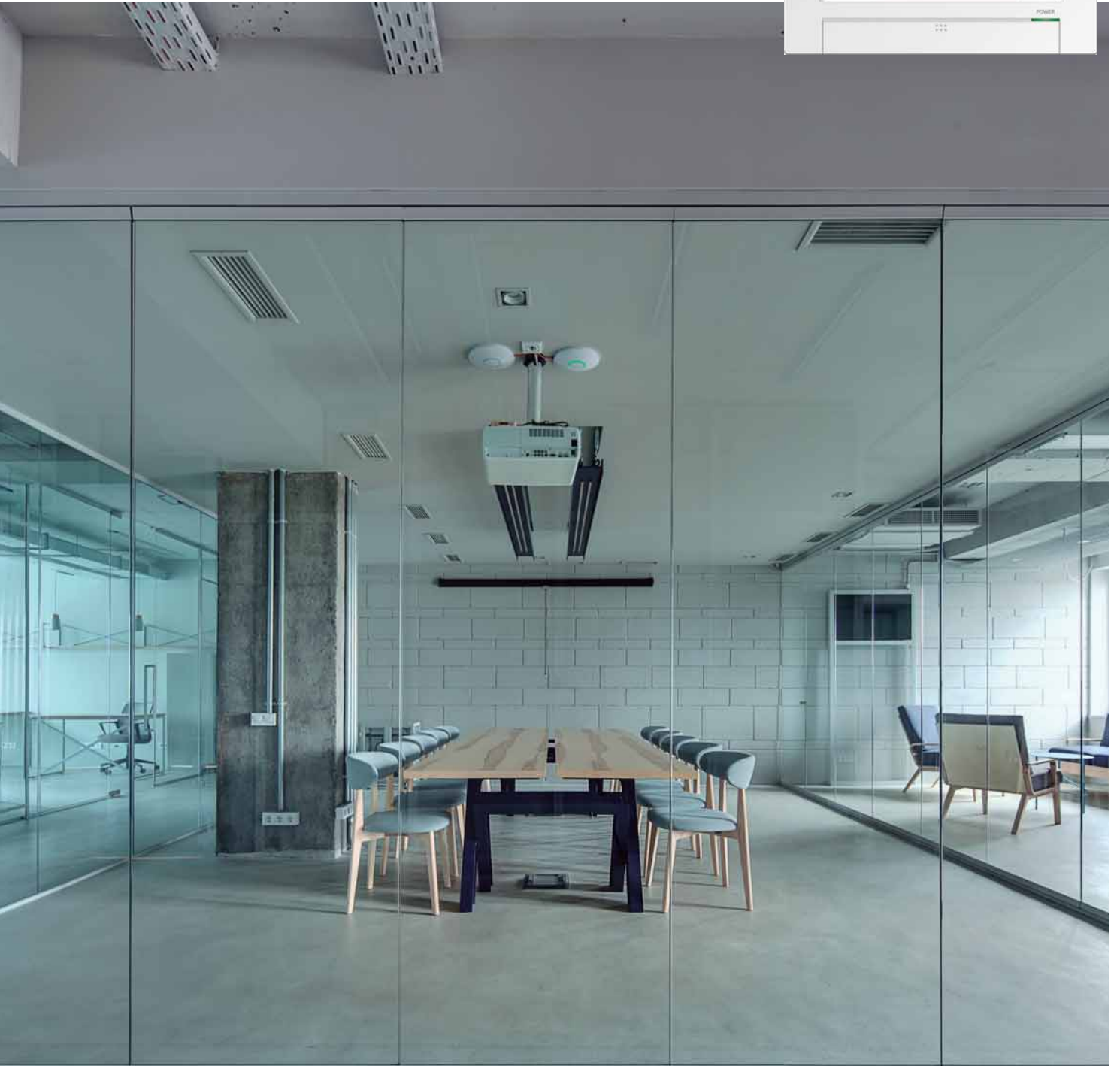

This controller is the smart solution for your advanced requirement in buildings.

**Intuitive operation**

The screens used for operations all follow a common pattern, with the screens being easy to read and easy to use.

- Enlarged screen (10,4 inch) with colour LDC
- Smartphone-like operations (Swiping, flicking)

Large screen display. Enlarged by 60%.



Easy Swipe or flick operation.

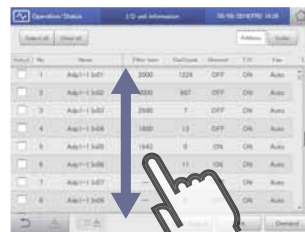

**Swipe.**  
This is an operation where the finger is slid in a direction (up or down) on the touch panel. This is used to scroll slowly.

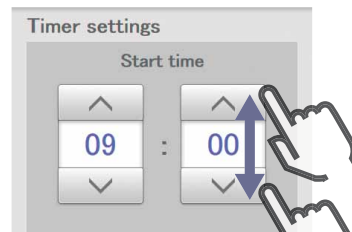

**Select.**  
This is an up and down movement of the finger touching the screen, used to pick settings in elements such as spin boxes.



**Pull out.**  
This is an operation where the finger on the touch panel is flicked in a direction (up or down). This is used to scroll quickly.

**Enhanced functions for energy saving as standards**

- Set temperature auto return settings, Auto shutoff, Set temperature range limit settings
- Demand control function

Screen of Set temperature auto return setting.

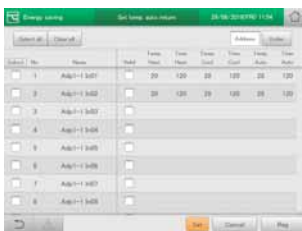

Auto shutoff.



Screen of Outdoor demand control.



- Outdoor demand input and timer settings possible
- Indoor can be set at  $\pm 1^\circ\text{C}$ / $\pm 2^\circ\text{C}$  or thermostat OFF
- Indoor units controlled in sequence at 10-minute intervals

**Energy Visualization**

- Energy-saving plans are supported with graph display function
- Displays electricity & gas usage distribution

Screen of graph display.



Useful parameters are shown for your better energy saving.  
Ex.) Bar graph:

- Indoor unit: Total operating time, thermostat ON operation time (Min.)  
Amount used (electricity, gas)  
Electricity or gas charges
- Outdoor unit: Outdoor unit operation cycles (# cycles)  
Engine time in operation (Hrs.)  
Cumulative Inverter power output  
Cumulative PV power output

Pulse value selection per different data intervals 1 hour/1 day/ 1 month compared with last year.

**Main function**

Gesture function (Flick, Swipe)	✓
Graph display (Trends, comparisons)	✓
Web functions (Max. 64 users)	✓
Recipient setting for warning email	✓ (Maximum 8)
Automatic return to setting temperature	✓
Limitation of setting temperature range	✓
Left-on prevention	✓
Quiet operation of outdoor unit	✓
Occupant sensor linkage	✓
Demand function	✓
Charge calculation	✓
Log display	Warning 10.000 items Status change 50.000 items
Linked control	✓
Event definition 50 events, Input: 32, Output: 32	✓
Under maintenance (Under inspection registration)	✓

# CONTROL FOR HOTEL APPLICATION





More easier to install, cheaper to integrate one only control to integrate all devices. Nice, easy and cost effective!  
Panasonic has developed an innovative line up of remote controls specially designed for Hotel applications.

- Easy to install
- Cost effective installation as all electrical cable are centralized on this remote
- Architect inspired attractive design
- Direct connection to the Indoor unit with most of the functions of the indoor unit
- 3 options available: Stand-Alone, Modbus or LonWorks communication
- 2 frame colours: White and aluminium

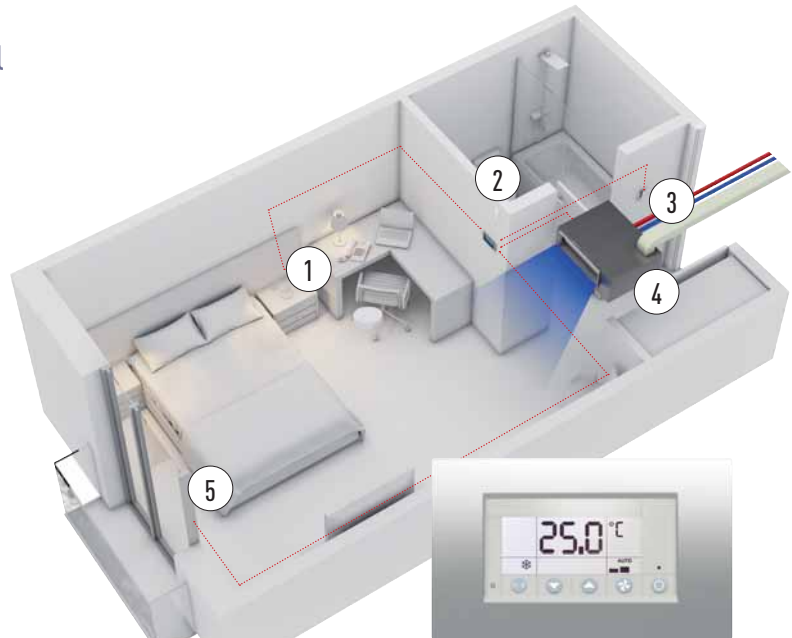

**From this remote control:** The lighting, card contact, motion detector, window contact and the air conditioning are controlled.

**Energy saving functions included on the device:** Turns Off air conditioning and lighting when room is unoccupied. Disables air conditioning when window is open. Maximum/minimum setpoint temperature configurable

**Easy remote control:** The hotel customer will have access to limited functions to control the air conditioning: ON/OFF, Temperature (under a certain limit fixed during the start up) and Fan speed

**Easy set up:** Stand-Alone model with easy configuration menu to access all parameters. The installation is simplified as all the cables should arrive to the remote control. A pre-define scenario can be uploaded on the remote control connected to a computer to make installation on site plug and play (only on the Modbus and LonWorks models).

**Control to integrate all room hotel needs in one device:**

Card switch. Heating and cooling control. Light control. Window control. Possible to connect to Modbus



Lighting control.

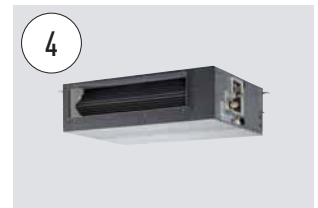

Indoor unit. Variable static pressure hide away.

- 3. Room card switch\*
- 2. Human sensor

- 5. Window contact\*
- \* Field supply

**Four preconfigured systems (option 1 to 4)**

The remote control have a 4 preconfigured systems in order to easily integrate it.

**4 options available I/O configurations: Inputs.**

Configurations	Digital 1-2	Digital 3-4	Digital 5-6	Analog 7-8
Option 1	Card	Window	Lighting	Temperature
Option 2	Card	Window	Blinds up	Blinds down
Option 3	Motion sensor	Window	Door contact	Temperature
Option 4	Lighting	Window	Blinds up	Blinds down

**Available I/O Configurations: Outputs.**

Configurations	Relay 15-16	Relay 13-14	Relay 11-12	Relay 9-10
Option 1	Courtesy	Lighting	Not used	Valve actuator
Option 2	Courtesy	Lighting	Blinds up	Blinds down
Option 3	Courtesy	Lighting	Not used	Valve actuator
Option 4	Not used	Lighting	Blinds up	Blinds down

**I/O Definitions: Inputs.**

Description	Functionality
Card	Occupancy room status. Enable HVAC Control and automatically switches ON Courtesy and Lighting outputs
Window	Temporary disables HVAC System
Lighting	Push button to turn ON/OFF Lighting Output when room occup.
Temperature	Analog input for Valve Actuator output control on 2nd zone
Blinds up	Push button for Blind Up motor output control
Blinds down	Push button for Blind Down motor output control
Motion sensor	In combination with Door Contact, enables HVAC Control and automatically switches ON Courtesy and Lighting outputs
Door contact	In combination with Motion Sensor, enables HVAC Control and automatically switches ON Courtesy and Lighting outputs

**I/O Definitions: Outputs.**

Description	Functionality
Courtesy	Automatically turns ON when room changes to occupied or unoccupied mode. It turns to OFF after a configurable time-out
Lighting	Automatically turns ON/OFF when room changes to occupied/unoccupied. Manual override with Lighting input
Valve actuator	HVAC Control for a 2nd zone
Blinds up	Output for Blind Up motor control
Blinds down	Output for Blind Down motor control

**Example I/O: Wiring configuration for Option 2.**

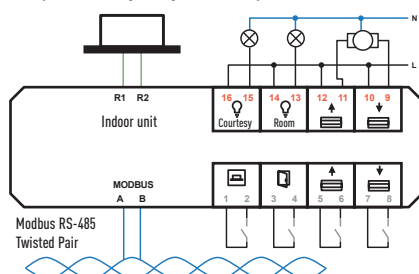

**Example I/O: Option 2.**

Terminals	Description	Type
A, b	Modbus RS-485	Bi-directional
R1, r2	Indoor unit	Bi-directional
1, 2	Card contact	Digital input
3, 4	Window contact	Digital input
5, 6	Blinds up	Digital input
7, 8	Blinds down	Analog input
9, 10	Blinds down	Relay output
11, 12	Blinds up	Relay output
13, 14	Lighting room	Relay output
15, 16	Lighting courtesy	Relay output

**Panasonic Reference.**

PAW-RE2C3-WH	Stand-Alone with I/O White frame
PAW-RE2C3-GR	Stand-Alone with I/O Grey Frame
PAW-RE2C3-MOD-WH	Modbus RS-485 with I/O White frame
PAW-RE2C3-MOD-GR	Modbus RS-485 with I/O Grey frame
PAW-RE2C3-LON-WH	LonWorks TP/FT-10 with I/O White frame
PAW-RE2C3-LON-GR	LonWorks TP/FT-10 with I/O Grey frame

# CONTROL AND CONNECTIVITY

## Centralized Control Systems

### BMS System. PC Base.



P-AIMS. Basic Software  
Up to 1024 groups. Controls 1024 units.  
CZ-CSWKC2

### Connection with 3rd Party Controller.



Seri-Para I/O unit for outdoor unit.  
Up to 4 outdoor units.  
CZ-CAPDC2



Local adaptor for ON/OFF control.  
Controls 1 to 8 units.  
CZ-CAPC3



Mini Seri-Para I/O Unit 0 - 10V.  
Controls 1 to 8 units.  
CZ-CAPBC2



Communication Adaptor.  
Up to 128 groups. Controls 128 units.  
CZ-CFUNC2

### AC Smart Cloud.



Cloud internet control.  
Up to 128 groups. Controls 128 units.  
CZ-CFUSCC1

## Domestic integration to P-Line - CZ-CAPRA1

Can connect all ranges to P-Line. Full control is now possible.

### Integrates any unit in big system control.

- TKEA Server room integration
- Small offices with Domestic indoors
- Tender for refurbishment (old system Domestic and VRF in one installation)

**Centralized Control Systems: 64 Indoor Units**

**Intelligent Controller / Web Server: 256 Indoor Units**

**P-AIMS: 1.024 Indoor Units**

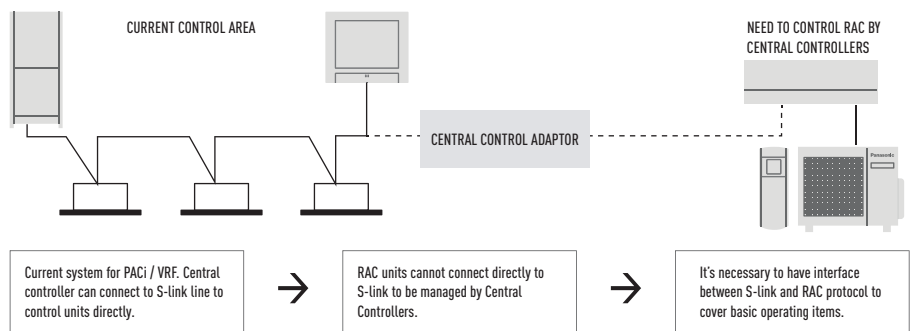

#### Basic operation items

ON/OFF	✓
Mode select	✓
Temperature setting	✓
Fan speed	✓
Flap setting	✓
Remote control prohibit	✓
Econavi ON/OFF	✓

#### External input

ON/OFF control signal	✓
Abnormal stop signal	✓

#### External output for Relay<sup>1)</sup>

Operation status (ON/OFF)	✓
Alarm status output	✓







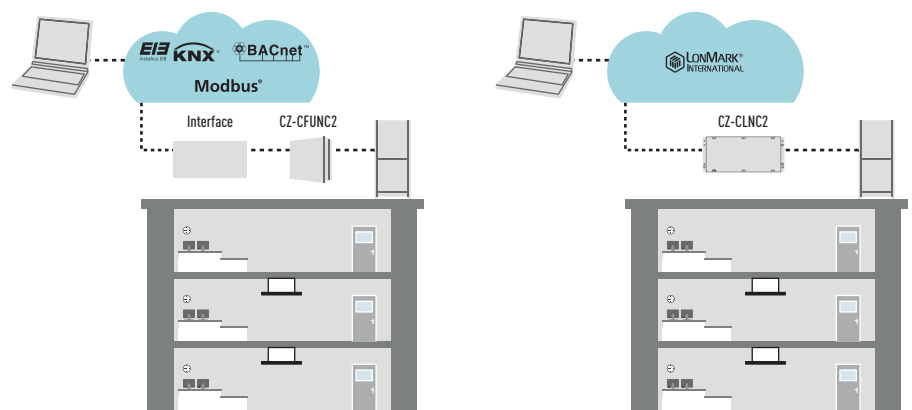

1) Because current CN-CNT connector can not provide the power for external output relay, additional Input power for external relay is necessary.

## Easy connection to KNX, Modbus, LonWorks and BACnet

Great flexibility for integration into your KNX / Modbus / LonWorks / BACnet projects allows fully bi-directional monitoring and control of all the functioning parameters.

For more information, contact Panasonic.



			Econavi control	Built-in thermostat	Indoor units which can be controlled	Use limitations	Function ON/OFF	Mode setting	Fan speed setting	Temperature setting	Air flow direction	Permit/Prohibit switching	Weekly program	BMS protocol
<b>Individual Controllers</b>														
Control for hotel application. Intelligent Controller		PAW-RE2C3-WH /-GR PAW-RE2C3-MOD-WH /-GR PAW-RE2C3-LON-WH /-GR White / Grey	-	✓	1 indoor unit	-	✓	✓	✓	✓	-	✓	-	Stand alone Modbus or LonWorks
Wired remote controller. Design wired remote controller		CZ-RTCSB	✓	✓	1 group, 8 units	• Up to 2 controllers can be connected per group	✓	✓	✓	✓	✓	-	✓	-
Wired remote controller. Normal operation		CZ-RTC2 (for Floor Standing (MP1) indoor units)	-	✓	1 group, 8 units	• Up to 2 controllers can be connected per group	✓	✓	✓	✓	✓	-	✓	-
Wireless remote controller		CZ-RWS3 + CZ-RWRU3 / CZ-RWS3 / CZ-RWS3 + CZ-RWRL3 / CZ-RWS3 + CZ-RWRD3 / CZ-RWS3 + CZ-RWRT3 / CZ-RWS3 + CZ-RWRC3	-	✓	1 group, 8 units	• Up to 2 controllers can be connected per group	✓	✓	✓	✓	✓ <sup>1</sup>	-	-	-
Quick and easy operation Simplified remote controller		CZ-RE2C2	-	✓	1 group, 8 units	• CZ-RE2C2: up to 2 controllers can be connected per group	✓	✓	✓	✓	✓ <sup>1</sup>	-	-	-
<b>Centralized Controllers</b>														
Central controller with weekly timer		CZ-64ESMC3	✓	-	64 groups, maximum 64 units	• Up to 10 controllers, can be connected to one system • Main unit/sub unit (1 main unit + 1 sub unit) connection is possible • Use without remote controller is possible	✓	✓	✓	✓	✓ <sup>1</sup>	✓	✓	-
Only ON/OFF operation from center station. ON/OFF Controller		CZ-ANC3	-	-	16 groups, maximum 64 units	• Up to 8 controllers (4 main units + 4 sub units) can be connected to one system • Use without remote controller is impossible	✓	-	-	-	-	✓	-	-
Simplified load distribution ratio (LDR) for each tenant. Intelligent Controller (Touch screen panel)		CZ-256ESMC3	✓	-	Main unit: 128. Up to 256 units can be expanded	• Communication adaptor CZ-CFUNC2 is necessary for connection with more than 128 units	✓	✓	✓	✓	✓ <sup>1</sup>	✓	✓	-

1. Setting is not possible when a remote control unit is present (use the remote control for setting). \* All specifications subject to change without notice.

# INDIVIDUAL CONTROLLERS

## Control for hotel application. Intelligent Controller (for VRF)



**PAW-RE2C3-WH // PAW-RE2C3-GR //**  
**PAW-RE2C3-MOD-WH // PAW-RE2C3-MOD-GR //**  
**PAW-RE2C3-LON-WH // PAW-RE2C3-LON-GR**

- Easy to install
- Cost effective installation as all electrical cable are centralized on this remote
- Architect inspired attractive design
- Direct connection to the Indoor unit with most of the functions of the indoor unit
- 3 options available: Stand-Alone, Modbus or LonWorks communication
- 2 frame colours: white and aluminium

### From this remote control.

The lighting, card contact, motion detector, window contact and the air conditioning are controlled.

### Energy saving functions included on the device.

- Turns Off air conditioning and lighting when room is unoccupied
- Disables air conditioning when window is open
- Maximum/minimum setpoint temperature configurable

## Wired remote controller. Design wired remote controller



### CZ-RTC5B

- Power consumption monitor (only for PACi)
- Flat face design & Touch sensor switch for stylish design and operating usability
- New functions such as for Energy saving & monitoring and for Service use are available on the Full dot LCD (3,5" display)
- Improved illumination
- White LED backlit
- Blink when alarm occurs

### datanavi

- Scan & Save AC system info
- Easy access to manual database
- Commissioning, F gas check data history

\* Panasonic app is required on your smartphone.

### Basic Operation.

- Operation • Mode • Temperature setting • Airflow volume
- Airflow direction

### Timer function.

- Outing function • Weekly Program timer • Easy ON/OFF timer
- Time display

### Energy saving.

- Outing function • Temperature setting range limitation
- Temperature auto return • OFF remind • Schedule demand control • Energy saving mode • Energy monitoring

### Others.

- Key lock • Ventilation fan control • Display contrast adjustment
- Remote controller sensor • Quiet operation mode • Prohibit setting control from Central controller • Rotation / Back up control

\* Several functions can not use on some outdoor unit. Ex. Power consumption monitor is not available for PACi Standard, Backup/Rotation control for PACi system.

## Wired remote controller. Normal operation (for Floor Standing (MP1) indoor units)



### CZ-RTC2

- Time Function 24 hours real time clock (week day indicator)
- Weekly programme function (a maximum of 6 actions can be programmed for each day)
- Sleeping function (this function controls the room temperature for comfortable sleeping)
- Maximum 8 indoor units can be controlled from one remote controller
- Remote control by main remote controller and sub controller is possible (maximum 2 remote controllers (main remote controller and sub controller) can be installed for one indoor unit)
- Possible to connect to the outdoor unit using PAW-MRC cable for servicing purposes

- Outing function (this function can prevent the room temperature from dropping or rising when the occupants are out for a long time)

### Basic remote controller ON/OFF.

- Operation mode changeover (Cooling, Heating, Dry, Auto, Fan)
- Temperature setting (Cooling / Dry: 18-30°C Heating: 16-30°C)
- Fan speed setting High / Medium / Low and Auto
- Air flow direction adjustment
- Dimensions (H x W x D): 120 x 120 x 16mm

**New Wireless remote controller**

NEW  
18



CZ-RWS3 + CZ-RWRU3  
For 4 Way 90x90 Cassette.



CZ-RWS3  
For Wall Mounted and 4 Way 60x60  
(with CZ-KPY3AW).



CZ-RWS3 + CZ-RWRL3  
Wireless remote controller for 2 Way  
Cassette.



CZ-RWS3 + CZ-RWRD3  
Wireless remote controller for 1 Way  
Cassette.



CZ-RWS3 + CZ-RWRT3  
For Ceiling.



CZ-RWS3 + CZ-RWRC3  
For all indoor units.

**CZ-RWS3 + CZ-RWRU3 // CZ-RWS3 // CZ-RWS3 + CZ-RWRL3 // CZ-RWS3 + CZ-RWRD3 // CZ-RWS3 + CZ-RWRT3 // CZ-RWS3 + CZ-RWRC3**

- Easy installation for the 4 Way cassette type simply by replacing the corner part
- 24 hour timer function
- Remote control by main remote controller and sub controller is possible (Max. 2 remote controllers (main remote controller and sub controller) can be installed for one indoor unit)

- When CZ-RWSC3 is used, wireless control becomes possible for all indoor units (1: when a separate receiver is set up in a different room, control from that room also becomes possible. 2: automatic operation by means of the emergency operation button is possible even when the remote controller has been lost or the batteries have been exhausted)
- Operation of separate energy recovery ventilators (When commercial ventilation fans or heat-exchange ventilation fans have been installed, they can be operated with this remote control (interlocked operation with the indoor unit or independent ventilation ON/OFF))

**Simplified remote controller. Quick and easy operation**

**CZ-RE2C2. A remote controller with simple functions and basic operation.**

- Suitable for open rooms or hotels where detailed functions are not required
- ON/OFF, operation mode switching, temperature setting, air speed switching, air flow direction setting, alarm display, and remote controller self-diagnosis can be performed

- Batch group control for up to 8 indoor units
- Remote control by main remote controller and sub controller is possible with a simplified remote controller or a wired remote controller (up to two units)
- Dimensions (H x W x D): 120 x 70 x 16mm



**Remote sensor**

**CZ-CSRC3**

- This remote sensor can be connected to any indoor unit. Please use it to detect the room temperature when no remote controller sensor or body sensor is used (connection to a system without a remote controller is possible)
- For joint use with a remote control switch, use the remote control switch as main remote controller
- Batch group control for up to 8 indoor units

- Appearance design based on simplified remote controller chassis
- Dimensions (H x W x D): 120 x 70 x 17mm
- Weight: 70g
- Temperature/Humidity range: 0°C to 40°C / 20 % to 80 % (no condensation) (indoor use only)
- Power Source: DC16V (supplied from indoor unit)
- Maximum number of connectable indoor units: Up to 8 units



Control contents	Part name, model No.	Quantity
Standard Control	Timer remote controller: CZ-RTC5B Wired remote controller: CZ-RE2C2 Wireless remote controller: CZ-RWS3 + CZ-RWRU3 // CZ-RWS3 + CZ-RWRL3 // CZ-RWS3 // CZ-RE2C2	1 unit each
(1) Group control	Timer remote controller: CZ-RTC5B Wired remote controller: CZ-RE2C2 Wireless remote controller: CZ-RWS3 + CZ-RWRU3 // CZ-RWS3 + CZ-RWRL3 // CZ-RWS3 // CZ-RE2C2	1 unit
(2) Main/sub remote control	Main or sub. Timer remote controller: CZ-RTC5B Wireless remote controller: CZ-RWS3 + CZ-RWRU3 // CZ-RWS3 + CZ-RWRL3 // CZ-RWS3 // CZ-RE2C2	As required

# CENTRALISED CONTROLLERS

## System Controller with Schedule timer. Operation with various function from center station



Sample display image /  
Operation status display

Operation Status ALL



Operation Status ZONE



Operation Status GROUP



### CZ-64ESMC3

#### Panasonic unveils state-of-the-art digital controller

Panasonic has launched its latest controller, an innovative and easy to use interface that offers full functionality with an integrated schedule timer and system controller, making managing heating and cooling systems easier than ever before. The CZ-64ESMC3 includes Panasonic's popular schedule timer, which gives users full flexibility over when they want their property heated or cooled. Users can adjust the system for holidays, pausing operations for long periods of time so that energy isn't wasted heating or cooling an empty home or office. The controller also allows six operations per day to be programmed.

#### Mix of current 2 controllers: System controller + Schedule timer.

System controller will be designed by taking priority on these 2 operations with following technical key points:

- Same operation feeling as wired remote controller by touch-key panel
- High visibility and usability by Full-dot LCD
- Based on High wired remote controller
- Maximum 64 group of indoor units, Individual control for 64 units
- 4 zone control; 1 zone = Maximum 16 groups
- Several energy saving function (based on CZ-RTC5B)
- 6 timer program per day for 1 week (7 days) operation (Total 6 x 7 = 42 programs)
- Basic setting items (Temperature, Mode, Fan speed, Flap position) can be set by same manner as CZ-RTC5B

#### Function list:

From CZ-64ESMC2 System controller:

- Central control / individual setting
- Start-stop prohibition for remote controller
- Start-stop / Mode change / Temperature setting prohibition for remote controller
- Mode change / Temperature setting prohibition for remote controller
- Mode change prohibition for remote controller
- Select items for prohibition

- Filter information
- Filter sign
- Filter sign reset
- Ventilation setting

From CZ-ESWC2 Schedule timer:

- Weekly Timer
- Timer setting Enable / Disable
- Copy of Timer setting
- Maintenance
- External signal (Start / Stop) (Demand control)
- Centralized control master-slave setting
- Alarm history
- Initial setting
- Clock

From CZ-RTC5B

- Energy-saving control
- Econavi On/Off
- Filter information
- Filter sign and Hour counter display
- Maintenance
- Service contact
- Initial setting
- Clock display setting
- Name Setting
- Operation lock setting
- Operation sound setting
- LCD contrast setting
- LCD backlight setting
- Select displayed language (EN / FR / IT / ES / DE)
- Administrator password
- Setting information list

## ON/OFF Controller. Only ON/OFF operation from center station

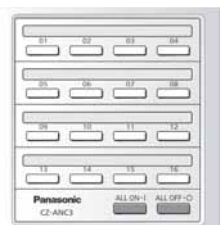

### CZ-ANC3

- 16 groups of indoor units can be controlled
- Collective control and individual group (unit) control can also be performed
- Up to 8 ON/OFF controller (4 main, 4 sub) can be installed in one link system
- The operation status can be determined immediately
- Dimensions (H x W x D): 121 x 122 x 14 + 52mm (embedding dimension)

Power supply: AC 220 to 240V.

I/O part: Remote input (effective voltage: within DC 24V): All ON/OFF.

Remote output (allowable voltage: within DC 30V): All ON, All alarm.

Note: As operation mode and temperature settings are not possible with the ON/OFF controller, it must be used together with a remote controller, a system controller etc.

## Intelligent Controller (Touch screen panel). Simplified load distribution ratio (LDR) for each tenant



### CZ-256ESMC3

Dimensions (H x W x D): 240 x 280 x 20 (+60)mm.  
 Power supply: Single Phase 100-240V ~ 50/60Hz.  
 Maximum number of connectable indoor units: 256 units (maximum per link: 64 units).  
 Maximum number of connectable outdoor units: 120 units (maximum per link: 30 units).  
 • Central control device: Up to 10 units  
 Enlarged Display Screen: 10,4 inch Touch-panel colour LCD.  
 Pursuing visibility, ease of use. Retrieve data from USB memory: Place the USB port inside the panel (USB memory available in stores). Communication adaptor: CZ-CFUNC2.

- Calculated data is stored as a CSV type file
- Data from the last 365 days is stored

### Web application. Web access & control from remote station.

- Accessing from remote PC
- You can monitor/operate system by using Web browser



### Remote control.

The LAN terminal on this unit enables you connect it to a network. Connecting to Internet will enable you to operate the unit and check the status using a PC from a remote location.

### Functions:

- Graph display (trends, comparisons)
- Econavi ON/OFF
- Outdoor unit quiet operation ON/OFF
- Energy-saving functions: Set temperature auto return settings, Auto shutoff, Set temperature range limit settings, Energy saving for PAC current value, etc.
- Event control (such as equipment linkage)
- Performs closing at end of any period

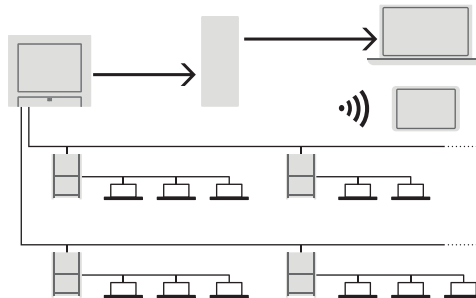

### Operation and status.

You can check to operational status (ON/OFF, operating mode, alarms, etc.) of all indoor units and outdoor units in real time. You can also select indoor units to change their settings.

### Back up tool to save your commissioning time.

Various data such as distribution, setting, log history etc. can be saved by CSV file.

Setting data of CSV file is available to edit and import to the controller again.

You can save time for commissioning and change setting flexibly and easily by your PC.

- Customize data
  - Data recovery
- Data can be imported again by general USB.

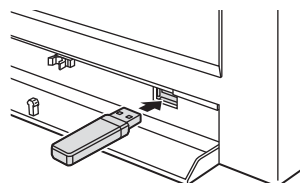

### Operation scheduling.

You can register daily operation schedules (ON/OFF time, operating modes, set temperatures, etc.) for individual indoor units or groups of indoor units.

Operations can be schedule for up to 2 years in advance.

### Load distribution calculation for each tenant.

- Air-conditioner load distribution ratio is calculated for each unit (tenant) with used energy consumption data (m<sup>3</sup>, kWh)

### System Configuration Example.

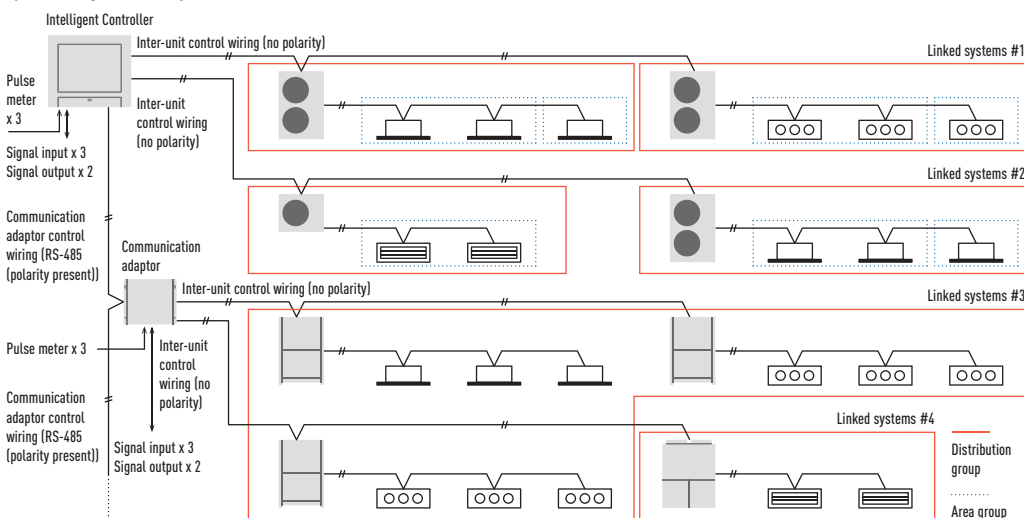

# CENTRALISED CONTROLLERS

## P-AIMS. Panasonic Total Air Conditioning Management System



### CZ-CSWKC2 / P-AIMS Basic software.

Up to 1024 indoor units can be controlled by one PC.

#### Functions of basic software.

- Standard remote control for all indoor units.
- Many timer schedule programs can be set on the calendar.
- Detailed information display for alarms.
- CSV file output with alarm history, operating status.
- Automatic data backup to HDD.

P-AIMS is suitable for large shopping centers and universities with many areas/ buildings. 1 "P-AIMS" PC can have 4 independent systems at once.

Each system can have maximum 8 C/A units, and control maximum 512 units. In total, 1024 indoor units can be controlled by 1 "P-AIMS" PC.

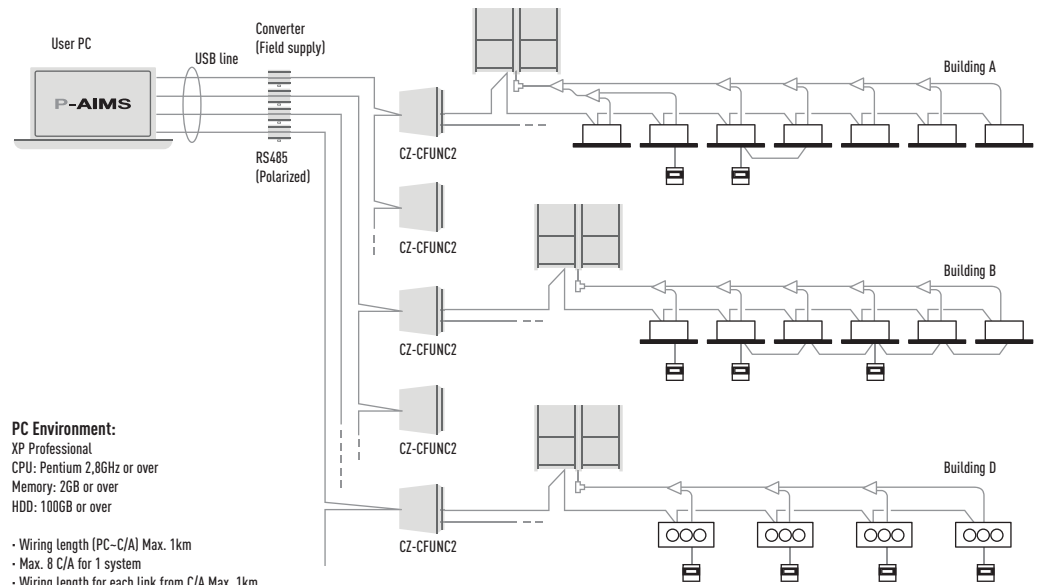

#### PC Environment:

XP Professional  
 CPU: Pentium 2,8GHz or over  
 Memory: 2GB or over  
 HDD: 100GB or over

- Wiring length (PC-C/A) Max. 1km
- Max. 8 C/A for 1 system
- Wiring length for each link from C/A Max. 1km

### P-AIMS optional software CZ-CSWAC2 for Load distribution. Load distribution calculation for each tenant.

- Air-conditioner load distribution ratio is calculated for each unit (tenant) with used energy consumption data (m<sup>3</sup>, kWh)
- Calculated data is stored as a CSV type file
- Data from the last 365 days is stored

### P-AIMS optional software CZ-CSWGC2 for Object layout display. Whole system can be controlled visually.

- Operating status monitor is available on the layout display
- Object's layout and indoor unit's location can be checked at once
- Each unit can be controlled by virtual remote controller on the display
- Max. 4 layout screens are shown at once

### P-AIMS optional software CZ-CSWWC2 for Web application.

#### Web access & control from remote station.

- Accessing P-AIMS software from remote PC
- You can monitor/operate ECOi 6N system by using Web browser (Internet Explorer)

### P-AIMS optional software CZ-CSWBC2 for BACnet software interface. Connectable to BMS system.

- Can communicate with other equipment by BACnet protocol
- ECOi 6N system can be controlled by both BMS and P-AIMS
- Max. 255 indoor units can be connected to 1 PC (that has P-AIMS basic & BACnet software).

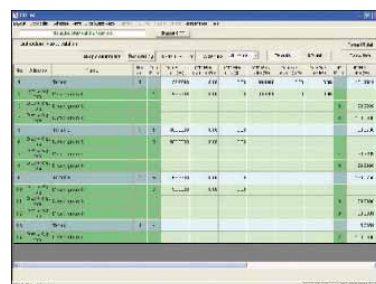

With 4 upgrade packages the basic software can be upgraded to suit individual requirements.



### Seri-Para I/O unit for outdoor unit. Connection with 3rd Party Controller

#### CZ-CAPDC2 for ECOi / CZ-CAPDC3 for Mini ECOi and PACi.

- This unit can control up to 4 outdoor units
- From the central control device, mode changing and batch operation/batch stop are possible
- Required for demand control

Dimensions (H x W x D): 80 x 290 x 260mm.

Power supply: Single Phase 100/200V (50/60Hz), 18W.

Input: Batch operation/Batch stop (non-voltage contact/DC 24 V, pulse signal). Cooling/Heating (non-voltage contact/static signal). Demand 1/2 (non-voltage contact/static signal) (Local stop by switching).

Output: Operation output (non-voltage contact). Alarm output (non-voltage contact).  
Wiring length: Indoor/Outdoor operation lines: Total length 1km.  
Digital signal: 100m or shorter.

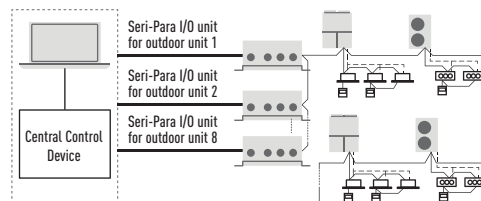

### Local adaptor for ON/OFF control. Connection with 3rd Party Controller

#### CZ-CAPC3

- Control and status monitoring is possible for individual indoor unit (or any external electrical device up to 250 V AC, 10 A) by contact signal

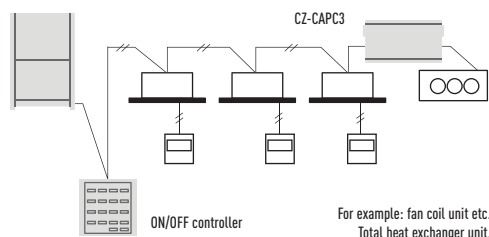

### MINI Seri-Para I/O Unit 0-10V. Connection with 3rd Party Controller

#### CZ-CAPBC2

- Control and status monitoring is possible for individual indoor unit (1 group)
- In addition to operation and stop, there is a digital input function for air speed and operation mode
- Temperature setting and measuring of the indoor suction temperature can be performed from central monitoring
- Power is supplied from the CZ-T10 terminal of the indoor units
- The analog input for demand of the outdoor capacity by 20 steps (from 40% to 120%) by 0-10V

- The analog input for temperature setting is 0 to 10V, or 0 to 140 Ohm
- Separate power supply also is possible (in case of suction temperature measuring)

\* Ask to your distributor.

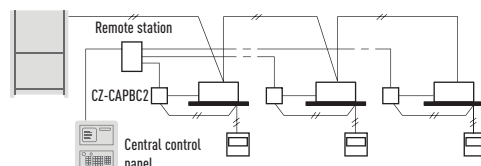

### Communication adaptor for VRF Connectivity

#### CZ-CFUNC2

This communication interface is required to connect a ECOi and GHP systems to a BMS. An additional interface is needed to convert the information into KNX/Modbus/Bacnet language. CZ-CFUNC2 is very easy to operate and to connect to the Panasonic P-Link, which is the ECOi bus. From the CZ-CFUNC2, all

the indoor and outdoor units of the installation can be easily control. Two linked wiring systems can be connected to one CZ-CFUNC2.

Dimensions (H x W x D): 260 x 200 x 68mm

\* As this is not a splash-proof design, it must be installed indoors or in the control panel, etc.



# PACi AND VRF CONNECTIVITY & CONTROL



Controls and connectivities are the key to offer better comfort and price. Panasonic offers its customers cutting-edge technology, specially designed to ensure our air conditioning systems deliver optimal performance. You can properly manage the air conditioning and perform comprehensive monitoring and control, with all of the features the remote control provides at home, from anywhere in the world thanks to the internet applications Panasonic has created for you.



### Panasonic PACi and ECOi protocol room controllers and Interfaces

Type of connection	Number of units	RC or IF	Gateway required	Modbus	KNX	BacNet	LonWorks
ECOi / PACi Indoor Units	1 unit/group	Room controller	—	PAW-RE2C3-MOD-GR		SER8150R0B1194	PAW-RE2C3-LON-GR
				PAW-RE2C3-MOD-WH		SER8150R5B1194	PAW-RE2C3-LON-WH
	4 units/groups	Interfaces	—	SER8150R0B1194			
				SER8150R5B1194			
ECOi P-Link	64 indoors	Interfaces	—	PAW-RC2-MBS-1	PAW-RC2-KNX-1i	PAW-AC-BAC-1	
		Interfaces	—	PAW-RC2-MBS-4			
	128 indoors	Interfaces	—				CZ-CLNC2 <sup>1</sup>
		Interfaces	CZ-CFUNC2	PAW-AC-MBS-64	PAW-AC-KNX-64	PAW-AC-BAC-64	
		Interfaces	CZ-CFUNC2	PAW-AC-MBS-128	PAW-AC-KNX-128	PAW-AC-BAC-128	

1) 16 groups of maximum 8 indoor units, in total maximum 64 indoor units.

### ECOi and GHP Connectivity

#### Plug and play interface connected directly to the P-Link.

The interface has been designed specifically for Panasonic and provides complete monitoring, control and full functionality of the line-up from IntesisHome, KNX, EnOcean, Modbus, BacNet and LonWorks installations.

This connectivity solution is made by a third party company, please contact Panasonic for more information.

1) Interface Modbus RTU/TCP is needed in case if Modbus TCP connection. PAW-MBS-TCP2RTU (ModBus RTU Slave devices).  
2) Interface CZ-CFUNC2 needed.

	Model name	Interface	Maximum number of indoor units connected
ECOi / PACi Indoor Units	PAW-RC2-KNX-1i	KNX	1 (1 Group of Indoor units)
	PAW-RC2-MBS-1	Modbus RTU <sup>1</sup>	1 (1 Group of Indoor units)
	PAW-RC2-MBS-4	Modbus	4 indoor/groups
	PA-RC2-WIFI-1	IntesisHome	1 (1 Group of Indoor units)
ECOi P-Link	PAW-AC-KNX-64	KNX <sup>2</sup>	64
	PAW-AC-KNX-128	KNX <sup>2</sup>	128
	PAW-AC-MBS-64	Modbus	64
	PAW-AC-MBS-128	Modbus	128
	PAW-TM-MBS-RTU-64	Modbus RTU <sup>2</sup>	64
	PAW-TM-MBS-TCP-128	Modbus TCP <sup>2</sup>	128
	PAW-AC-BAC-1	Bacnet	1
	PAW-AC-BAC-64	Bacnet <sup>2</sup>	64
	PAW-AC-BAC-128	Bacnet <sup>2</sup>	128
	CZ-CLNC2	LonWorks	16 groups of maximum 8 indoor units, in total maximum 64 indoor units

### Airzone. Control of the PACi Hide Aways

Airzone has developed interfaces to easily connect to Panasonic PACi Hide Away units. Ensuring optimum performance, comfort and energy savings, the new system is efficient and easy to install.

#### Airzone full range of accessories for any duct project.



Different type of outlets



Also plenum automatic doors



Full range of RC (wired/wireless, ...)

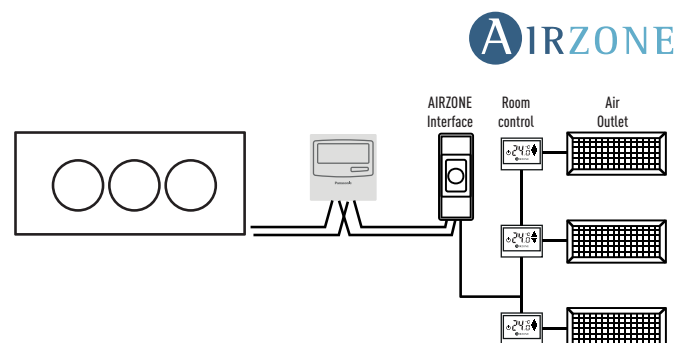

# ECOi, ECO G AND PACi CONNECTIVITY INDOOR UNITS

## PCB's and cables for ECOi, ECO G and PACi indoor units

Name of the cables	Function	Comment
CZ-T10	All T10 functions	Requires field supplied accessory
PAW-FDC	Operate external fan	Requires field supplied accessory
PAW-OCT	All option monitoring signals	Requires field supplied accessory
CZ-CAPE2	Option monitoring signals wo. fan	Requires additional wires from spare part supply
PAW-EXCT	Forced Thermo OFF/Leakage D.	Requires field supplied accessory
Name of the PBC	Function	Comment
PAW-T10	All T10 functions	Allows easy connection "Plug & Play"
PAW-T10V	All T10 functions + powermonitoring	Same like PAW-T10 + monitoring the power supply of indoor unit
PAW-T10H	ON/OFF; Prohibit 5VDC & 230VAC	Specials for single hotel card or window contact
PAW-T10HW	ON/OFF; Prohibit 5VDC	For hotel card + window contact at same time
PAW-PACR3	Redundancy of 2 or 3 systems; for ECOi and PACi	Redundancy of 2 or 3 ECOi or PACi systems including temperature monitoring, error indication, backup, alternative run
PAW-SERVER-PKEA	Redundancy of 2 units PKEA	Redundancy of 2 units PKEA including temperature monitoring, error indication, backup, alternative run

## T10 connector (CN015)



### CZ-T10

Panasonic has developed an optional accessory (consisting of plug + wires) called CZ-T10 to enable an easy connection to this T10 connector.

Connecting an ECOi indoor unit to an external device is easy. The T10 terminal featured in the electronic circuit board of all indoor units enables digital connection to external devices.

### T10 terminal Specification (T10: CN015 at indoor unit PCB).

- Control items: 1. Start/stop input
- 2. Remote controller prohibit input
- 3. Start signal output
- 4. Alarm signal output

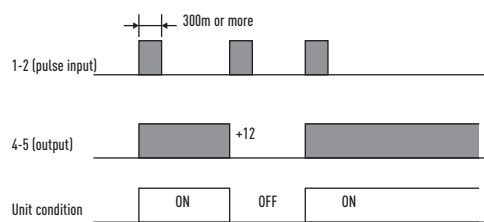

NOTE: The wire length from indoor unit to the Relay must be within 2,0m. Pulse signal changeable to static with JP cutting. (Refer to JP001)

### Condition

- 1-2 (Pulse input): Unit ON/OFF condition switching with a pulse signal. (1 pulse signal: shortage status more than 300msec. or more)
- 2-3 (Static input): Open / Operation with Remote is permitted (Normal condition) Close / Remote controller is prohibited
- 3-4 (Static output): 12V output during the unit ON / No output at OFF
- 4-5 (Static output): 12V output when some errors occur / No output at normal

### Example of wiring

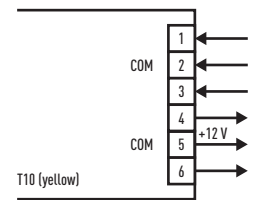

### Usage Example.

#### Forced OFF control.

Term 1 & 2: Free contact for ON/OFF signal (cut \*JP1\* for static signal) when the hotel card is it connected the contact must be close (the unit can be used).

Term 2 & 3: Free contact to prohibit all function in the remote controller install in the room when the hotel card is it removed the contact must be closed (the unit can not work).

#### Terminal = T10

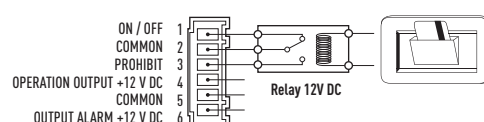

### Operation ON/OFF signal output.

#### Condition:

4-5 (Static output): 12V output during the unit ON / No output at OFF

#### Example of wiring

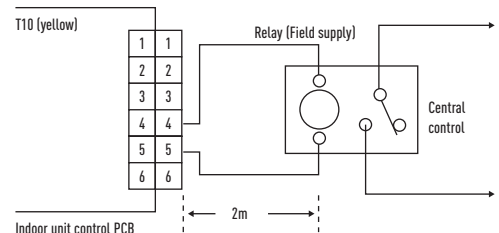

NOTE: The wire length from indoor unit to the Relay must be within 2,0m. Pulse signal changeable to static with JP cutting. (Refer to JP001)

### Fan Drive Connector (CN032)

#### PAW-FDC

Panasonic has developed an optional accessory (consisting of plug + wires) called PAW-FDC to enable an easy connection to this Fan Drive Connector (CN032).

- Operating the ventilation fan from the remote controller
- Start / stop of external ventilation and total heat exchanger fans
  - Works even if indoor unit is stopped
  - In case of group control → all fans will operate; no individual control

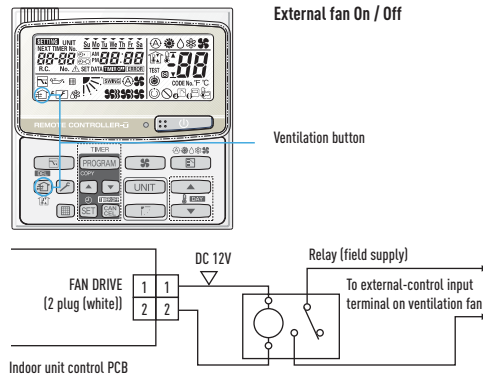

### Option Connector (CN060) Output external signals

#### PAW-OCT

Panasonic has developed an optional accessory (consisting of plug + wires) called PAW-OCT to enable an easy connection to this Option Connector (CN060).

**With the combination of the T10 and the option CN060 an external control of the indoor units is possible!**

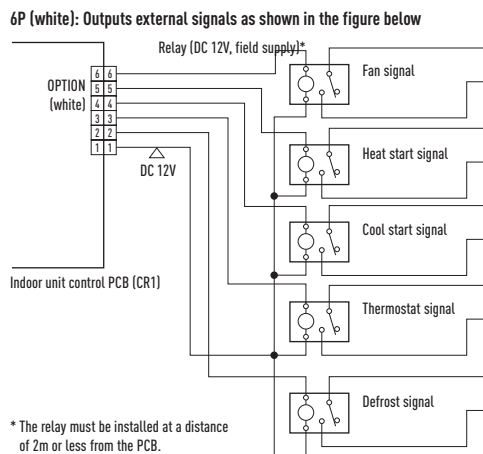

\* The relay must be installed at a distance of 2m or less from the PCB.

### EXCT Connector (CN009)

#### PAW-EXCT

Panasonic has developed an optional accessory (consisting of plug + wires) called PAW-EXCT to enable an easy connection to this EXCT Connector (CN009).

#### A) With static input.

##### → STATIC INPUT → THERMO OFF → ENERGY SAVING

2P plug (red): Can be used for demand control. When input is present, forces the unit to operate with the thermostat OFF.

Note: The length of the wiring from the indoor unit control PCB to the relay must be 2m or less.  
\* Lead wire with 2P plug (special—order part: WIRE K/854 05280 75300)

#### • Examples of wiring:

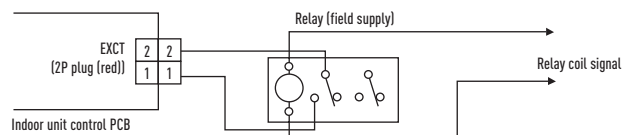

#### B) Example: In connection with a refrigerant sensor.

- Signal from leakage detector: non voltage, static.
- Indoor unit setting: Code 0b → 1
- Connector for leak detector: EXCT
- Outdoor unit setting:
  - Code C1 → 1 power output if alarm from O2 connector 230V
  - Code C1 → 2 power output if alarm from O2 connector 0V
- Displayed alarm message P14

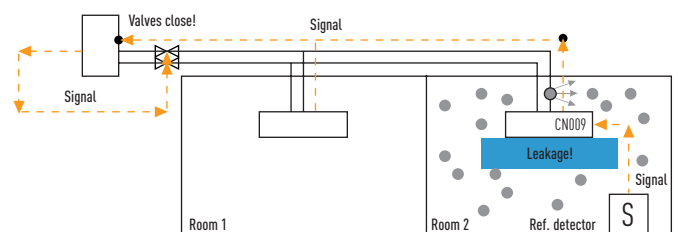

# PANASONIC CONDENSING UNITS WITH NATURAL REFRIGERANT



Panasonic is now introducing the new environmentally friendly CO<sub>2</sub> condensing units for commercial refrigeration.

With Panasonic condensing units you can expect:

- Energy savings
- Low noise levels
- Light weight
- Low refrigerant charge
- Low installation cost
- Low costs on servicing



# CHOOSE THE GREEN SOLUTION BY PANASONIC

## Why CO<sub>2</sub>? : Natural refrigerant

Carbon dioxide (R-744) is regaining its place in the refrigeration world. Driven by environmental concerns, legislation is requiring increased adoption of 'alternative' refrigerants, of which CO<sub>2</sub> is one. CO<sub>2</sub> is a very attractive refrigerant from an environmental perspective. Zero ODP and "GWP" (Global Warming Potential)=1 means natural substance in the atmosphere. In Europe a step-by-step HFC reduction has been in place since the F Gas regulation was introduced in 2015. In fact, not only in Europe but also other countries all over the world have actively been preparing to enact the necessary domestic legislation to implement the agreement for reducing the use of HFCs. Panasonic is now able to provide a solution in Europe with CO<sub>2</sub> refrigeration systems to prevent global warming and to support environment-friendly retail operations. The following table shows how well R744 (CO<sub>2</sub>) performs regarding environmental impact and safety.

**ODP (Ozone Depletion Potential) = 0 - GWP (Global Warming Potential) = 1.**

	Next generation refrigerant			Current refrigerant	
	CO <sub>2</sub>	Ammonia	Isobutane	R410A	R404A
ODP	0	0	0	0	0
GWP	1	0	4	2090	3920
Flammability	Non flammable	Light flammable	Flammable	Non flammable	Non flammable
Toxicity	No	Yes	No	No	No

## Comparison of CO<sub>2</sub> emissions

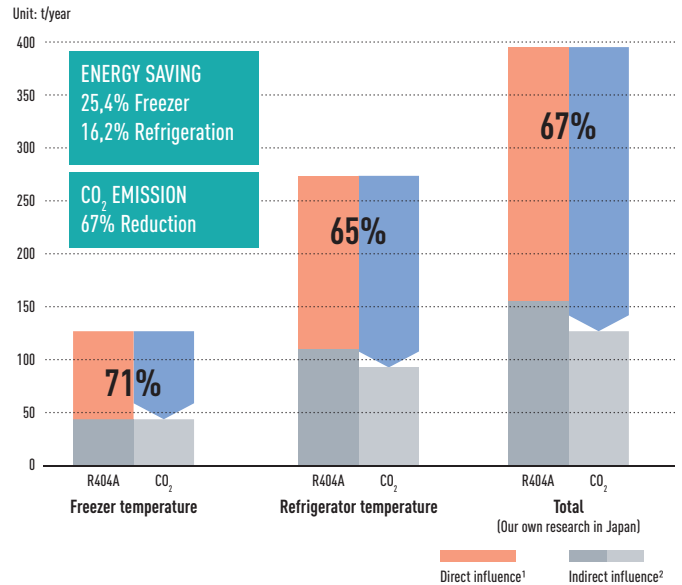

1) Direct influence presents the effect of refrigerant leakage comparing R744 (CO<sub>2</sub>) with R404A.  
 2) Indirect influence presents CO<sub>2</sub> emissions linked to power consumption of CO<sub>2</sub> unit and conventional units. By Panasonic research in Japan. Comparing 6 shops average for R404 inverter multi condensing unit.





Reliability is our main target and therefore we offer compressor warranties of 5 years, and 2 year warranties on other components!

### CO<sub>2</sub> transcritical condensing units VF Series

- Set-points at medium or low temperature available depending on applications (200VF5: ET -45 ~ -5°C, 1000VF8: ET -20 ~ -5°C)
- High COP at high ambient temperature thanks to Panasonic's 2-stage compression CO<sub>2</sub> rotary compressor
- Compact and extremely quiet. Noise level is minimal, only 35,5 dB(A) (200VF5 model)
- Transfer Pressure control for stable expansion valve control in showcases (1000VF8 model only)

\*SEPR values has been tested at 3-part laboratory

**HIGH PRESSURE TYPE  
BOTH MT OR LT  
4,00kW / 2HP**

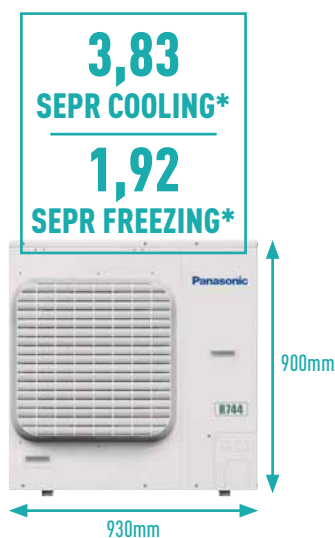

**TRANSFER PRESSURE  
CONTROL TYPE  
MULTIPLE EVAPORATOR  
15,00kW / 10HP**



### Superior cooling capacity at each evaporating temperature

CO<sub>2</sub> Transcritical Condensing units have a high cooling capacity at each set point.

CO<sub>2</sub> 2-stage compression rotary compressor developed by Panasonic is designed to compress CO<sub>2</sub> refrigerant twice; it reduces load in operation by half compared with 1-stage refrigerant compression and delivers better durability and reliability.

#### 4,00kW: OCU-CR200VF5(SL)

This compact unit provides flexibility to adapt to changing needs of refrigeration depending on the install setting.

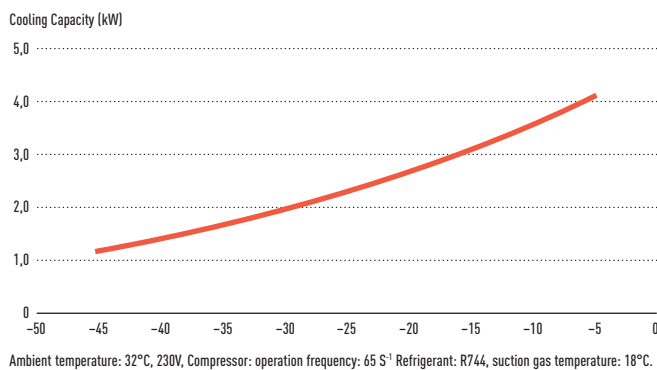

Units can be set to run at low and medium temperatures with four initial settings. These settings can then be modified by turning a simple and user friendly rotary switch to further enhance energy savings. (200 VF5 model only).

#### 15,00kW: OCU-CR1000VF8(SL)

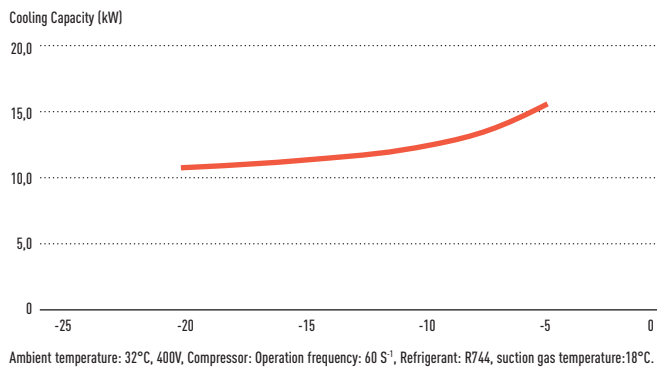

Panasonic condensing units with natural refrigerant:  
The environmentally friendly and reliable solution for  
convenience stores, supermarket, gas stations and cold rooms.

Cold chain applications

Panasonic's VF Series of CO<sub>2</sub> condensing units provide the ideal solution for supermarkets, convenience stores and gas stations. Keeping food always fresh at right temperature in showcases or cold rooms is a very critical point. And one of the biggest challenges for those retailers has been the expensive effects of refrigeration breakdowns which can result in costly product wastage. Panasonic's reliable CO<sub>2</sub> solution helps address the above issue by having a stable and reliable all year-round system to help maximise energy efficiency.

Showcases

Convenience stores, supermarket, gas stations.



CO <sub>2</sub> Model	Showcase type example
4,0 kW / OCU-CR200VF5	Reach in Freezer
15,0 kW / OCU-CR1000VF8	Open Showcase (Total width 850cm) / Dessert Showcase / Walk-in Refrigerator (6 or 7 doors)

\*Showcases are local supply

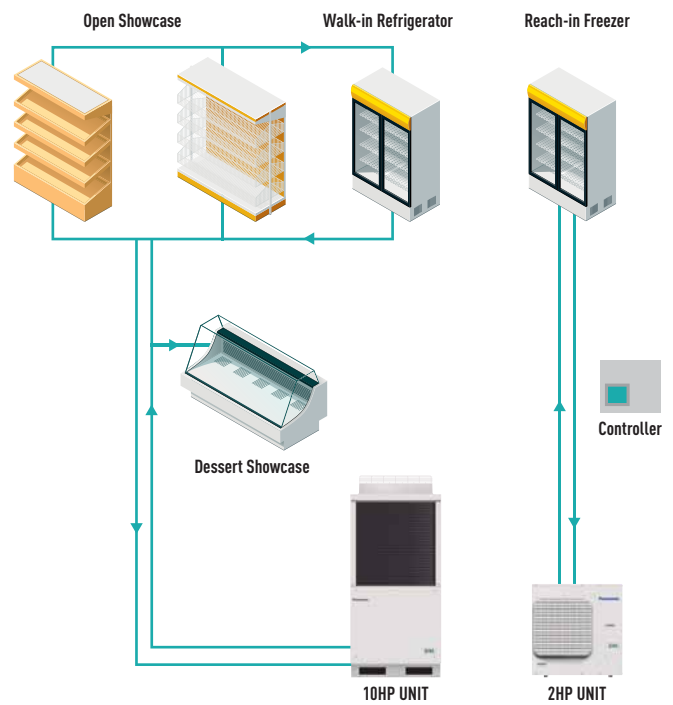

Cold room application to keep food fresh

Hotel, school, hospital.

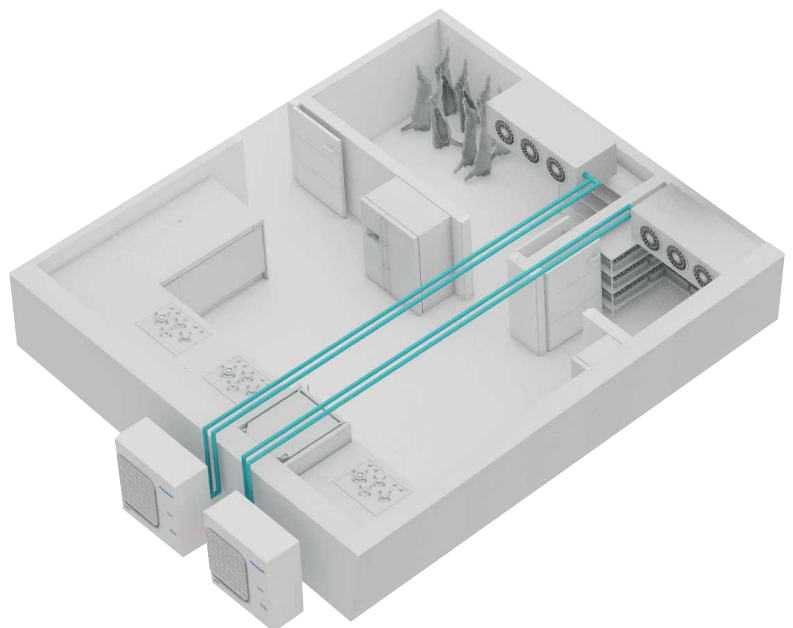

CO <sub>2</sub> Model		4,0 kW / OCU-CR200VF5		15,0 kW / OCU-CR1000VF8	
Cold room	Eva. temperature	-30 °C	-10 °C	-30 °C	-10 °C
	Room size example*	10 m <sup>3</sup>	40 m <sup>3</sup>	NA	200 m <sup>3</sup>

\* Room size is reference. Please contact to authorized Panasonic dealer for calculation.



## Saving installation time with Plug & Play kit

To ensure a quick and easy install of the product, Panasonic has designed a one box solution that includes the condensing unit, a panel pre-programmed controller, expansion valve and sensors in addition to providing easy to understand instructions.



### Plug & Play kit



Valve for superheat control  
(included with PAW-CO2-PANEL).



PAW-CO2-PANEL  
Intelligent controller programmed specially  
for storage rooms and show cases.

## Reliable CO<sub>2</sub> technology by Panasonic

- Reliable Quality: Made in Japan
- Experience: 8.500 units sold and installed in 3.100 retail operations such a convenience stores and supermarkets in Japan\*
- Excellent quality control established by skilled factory team
- Panasonic offers 5 year warranties on compressor and 2 years on components
- The 5 year compressor warranty matches the products long lifetime

\*As of the end of March 18.



Model			OCU-CR200VF5	OCU-CR200VF5SL	OCU-CR1000VF8	OCU-CR1000VF8SL
Description			4 kW unit standard version	4 kW CO <sub>2</sub> + anti corrosion coating	15 kW unit standard version	15 kW CO <sub>2</sub> + anti corrosion coating
Cooling capacity at -35 °C	Nominal	kW	1,80	1,80	N/A	N/A
Cooling capacity at -10 °C	Nominal	kW	3,70	3,70	14,0	14,0
Evaporation temperature	Min - Max	°C	-45 ~ -5	-45 ~ -5	-20 ~ -5	-20 ~ -5
Power supply	Voltage	V	220/230/240	220/230/240	380/400/415	380/400/415
	Phase		Single Phase	Single Phase	Three Phase	Three Phase
Refrigerant	Frequency	Hz	50	50	50	50
			R744	R744	R744	R744
Design pressure liquid line		Mpa	12	12	8/12	8/12
Design pressure suction line		Mpa	8	8	8	8
Compressor type			2- stage rotary	2- stage rotary	2- stage rotary	2- stage rotary
Dimensions	H x W x D	mm	930 x 900 x 437	930 x 900 x 437	1941 x 890 x 890	1941 x 890 x 890
Weight		Kg	70	70	293	293
Ambient temperature	Min - Max	°C	-15 ~ +43	-15 ~ +43	-15 ~ +43	-15 ~ +43
Connection piping	Suction pipe	Inch (mm)	3/8 (9,52)	3/8 (9,52)	3/4 (19,05)	3/4 (19,05)
	Liquid pipe	Inch (mm)	1/4 (6,35)	1/4 (6,35)	5/8 (15,88)	5/8 (15,88)
Length of connection piping		m	25	25	100	100
	Ambient temperature	°C	32	32	32	32
Standard performance	Evaporating temperature	°C	-10	-35	-10	-35
	Cooling capacity	kW	3,70	1,80	3,70	1,80
	Power consumption	kW	1,79	1,65	1,79	1,65
	Nominal load ampere	A	7,94	7,26	7,94	7,26
	Sound pressure level	dB(A)	35,5 <sup>1</sup>	35,5 <sup>1</sup>	35,5 <sup>1</sup>	35,5 <sup>1</sup>
					36,0 <sup>2</sup>	36,0 <sup>2</sup>

### Accessories

<b>PAW-CO2-PANEL</b>	Room and superheat control including both Panel + expansion valve
<b>PAW-CO2-FILTER-1</b>	Filter, liquid line

### Accessories

<b>SPK-TU125</b>	Filling pipe
<b>S-008T<sup>3)</sup></b>	Suction Filter
<b>PAW-CO2-WPH-2HP</b>	Snow protection

SPK-TU125: Connector Jig



1) ET -10°C, 65 S<sup>-1</sup>, 10m from product. 2) ET -10°C, 60 S<sup>-1</sup>, 10m from product. 3) For 15,00kW model.

# DIMENSIONS

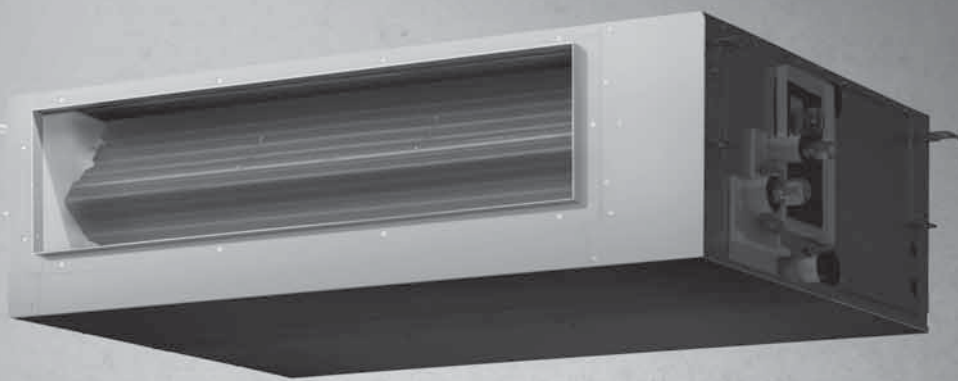

All in One H Generation

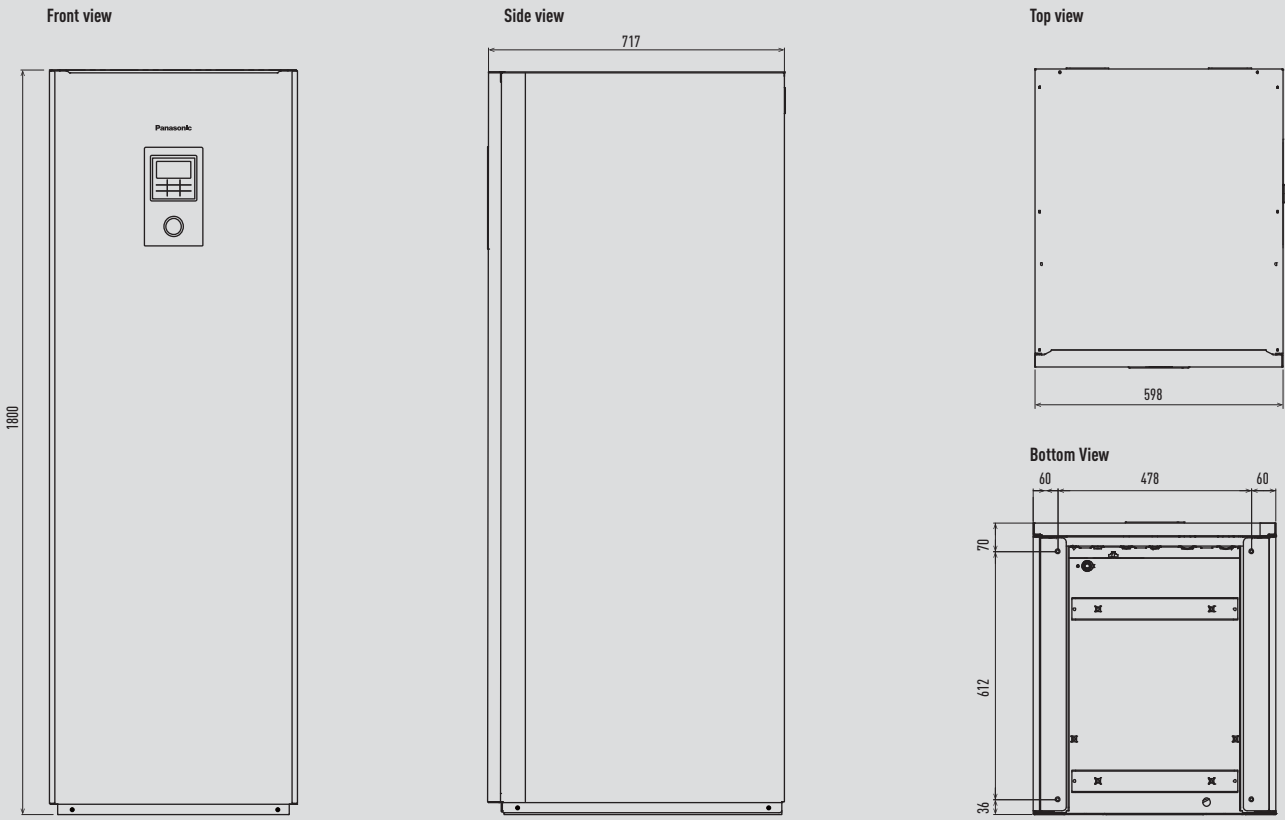

Unit: mm

Hydraulic Module H Generation

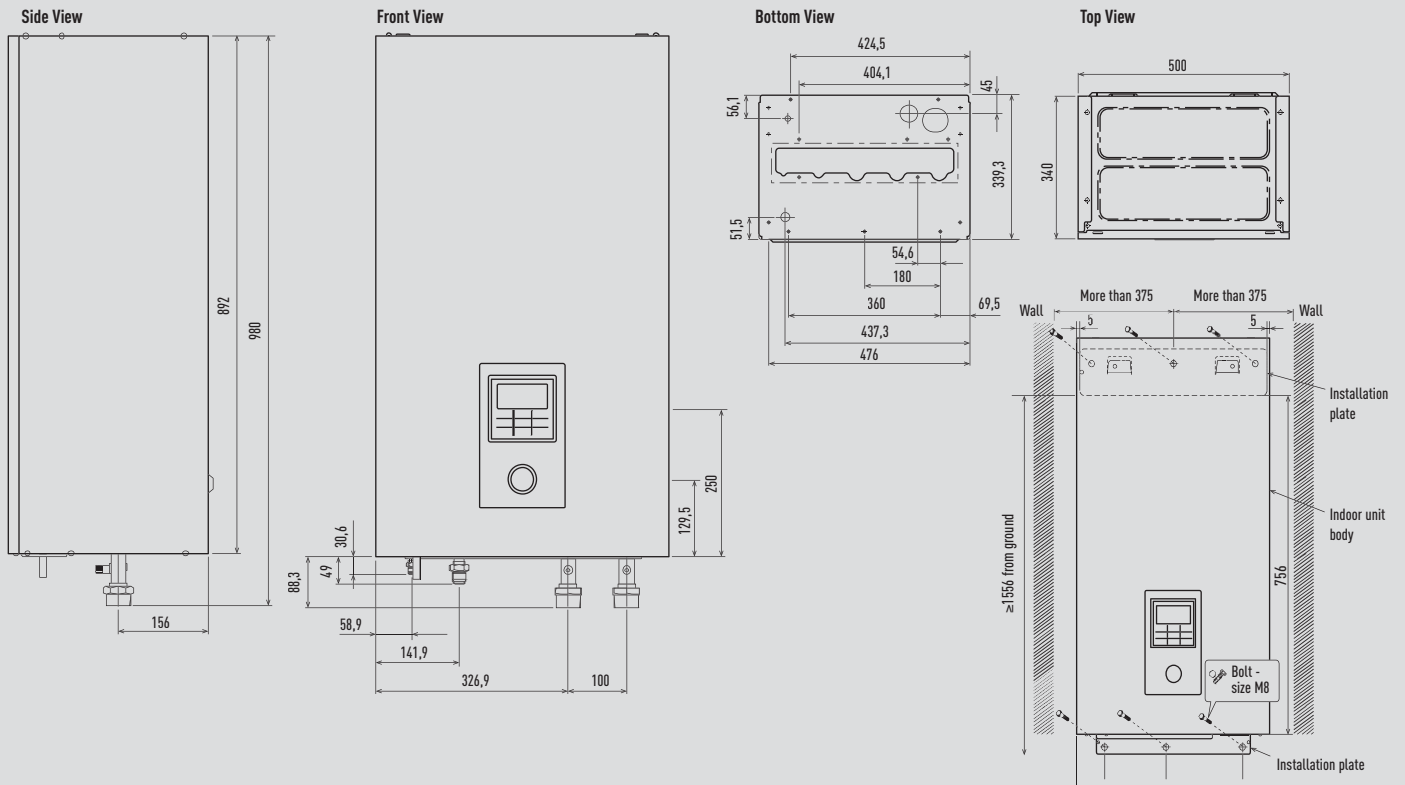

Unit: mm

Hydraulic Module F Generation

Side View

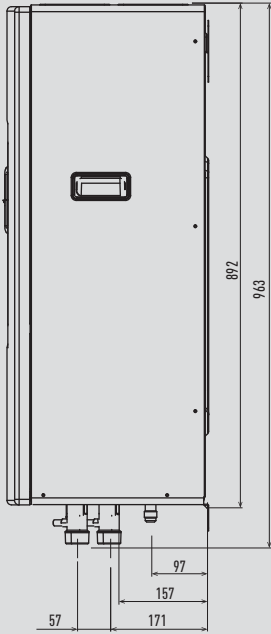

Front View

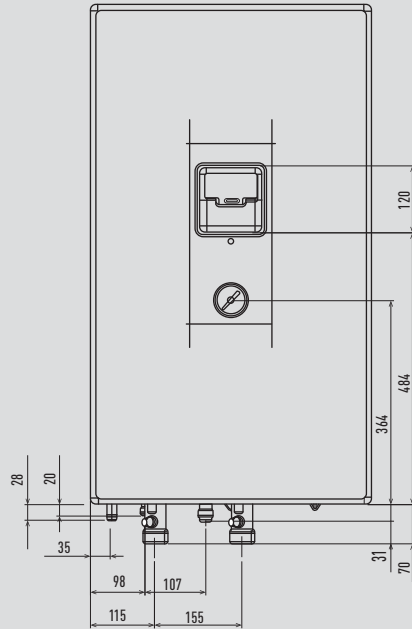

Bottom View

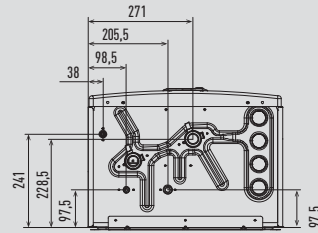

Relative position between the indoor unit and the installation plate Front View

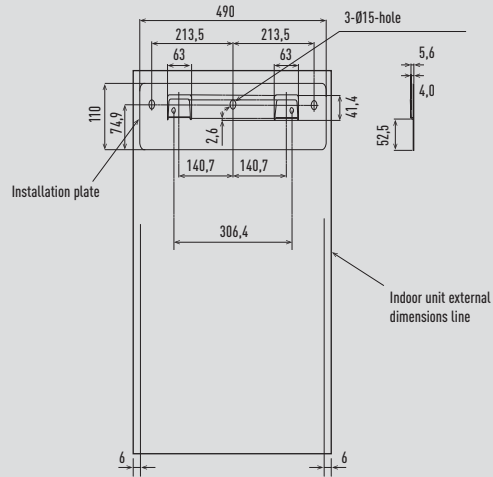

Top View

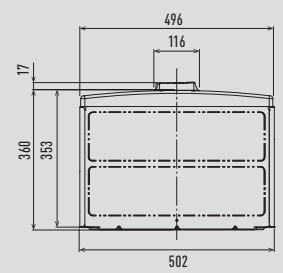

Unit: mm

Bi-bloc outdoor unit 3 and 5kW

Space necessary for installation

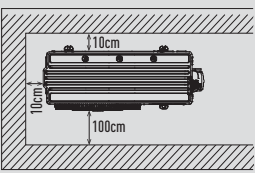

Anchor bolt pitch 355 x 260

Top View

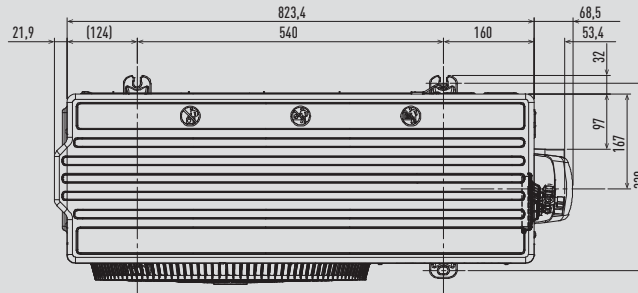

Side View

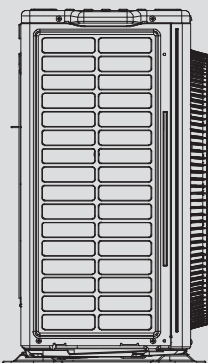

Front View

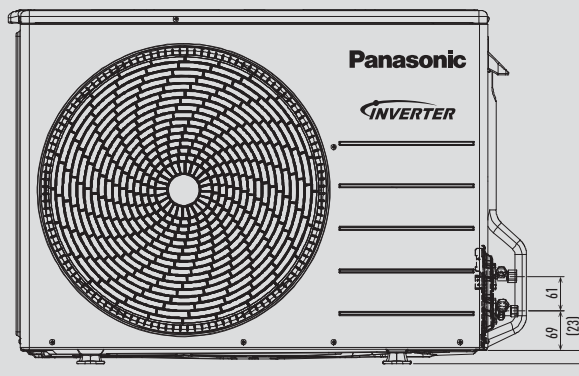

Side View

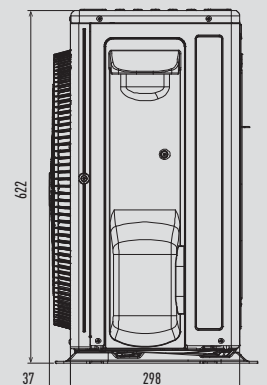

Unit: mm

Bi-bloc outdoor unit 7 and 9kW

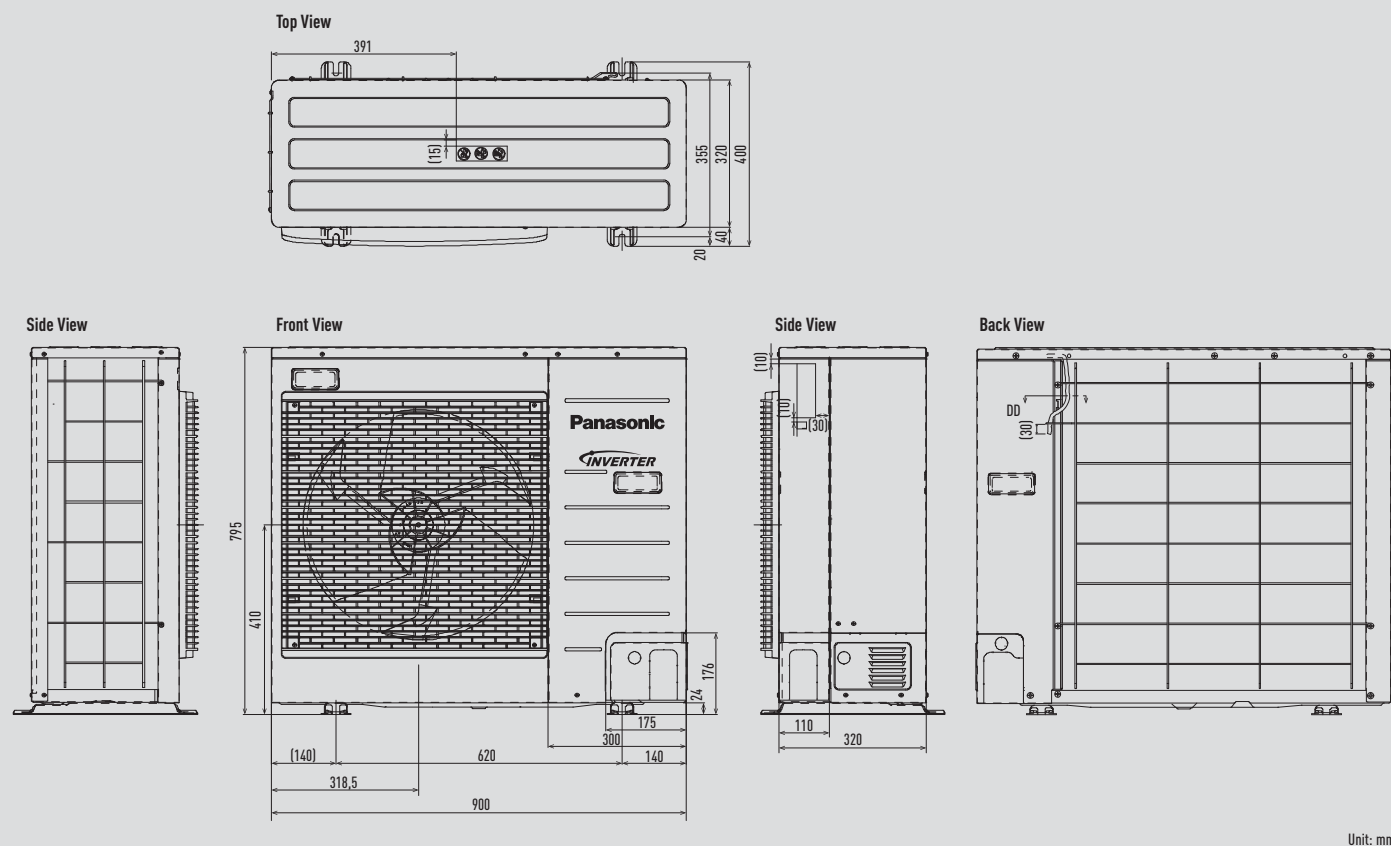

Bi-bloc outdoor unit from 9 to 16kW

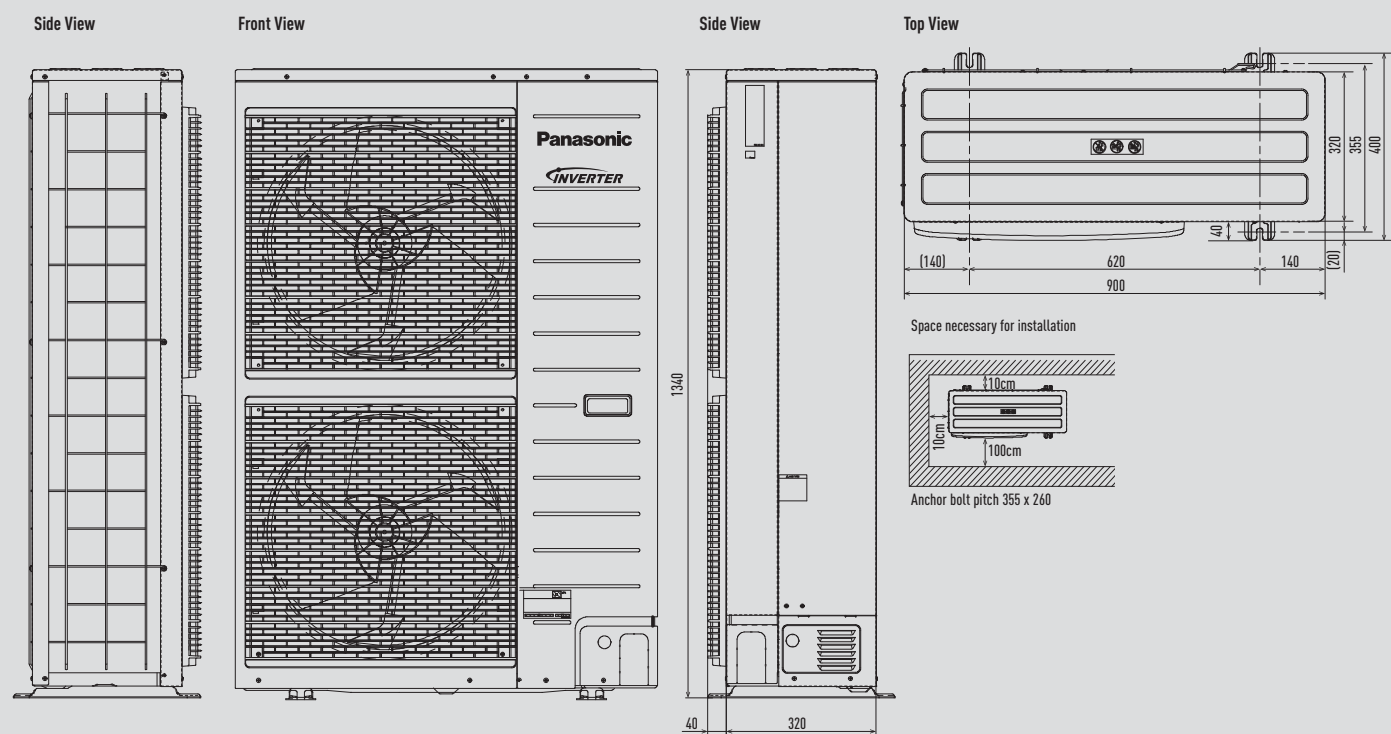

Mono-bloc outdoor unit from 5 to 9kW

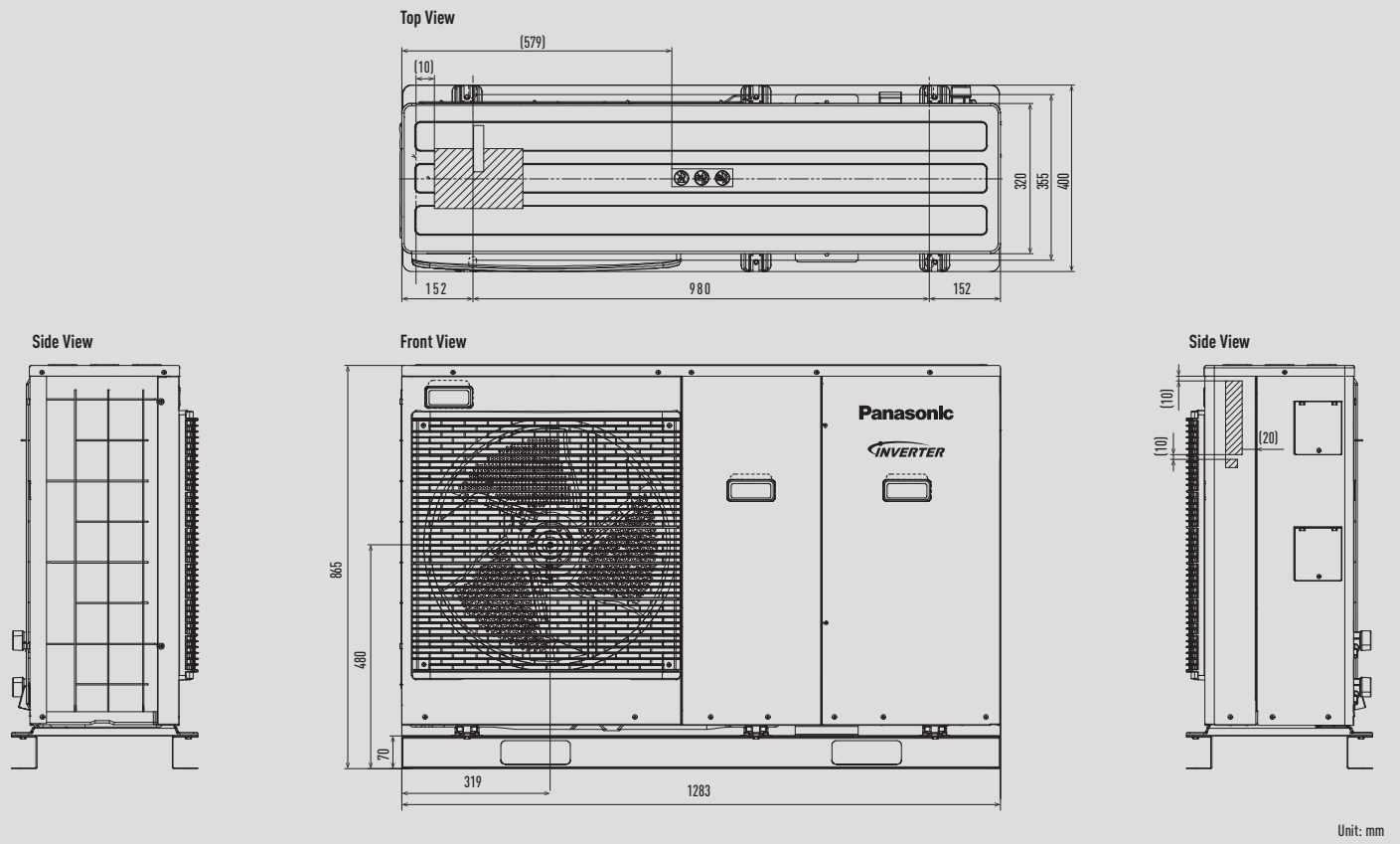

Bi-bloc Super Quiet outdoor unit and Mono-bloc outdoor unit from 9 to 16kW

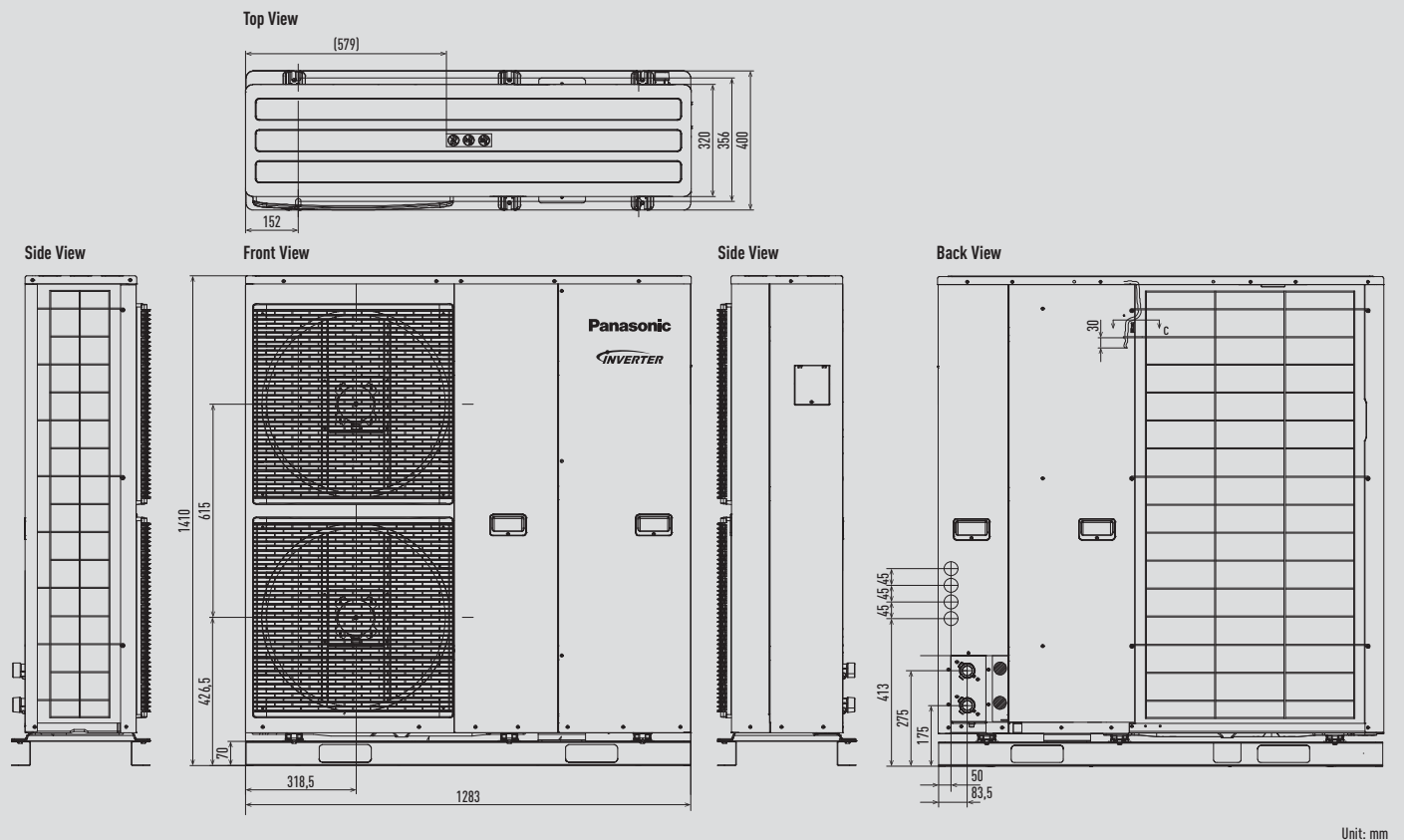



### Fan Coil Compact

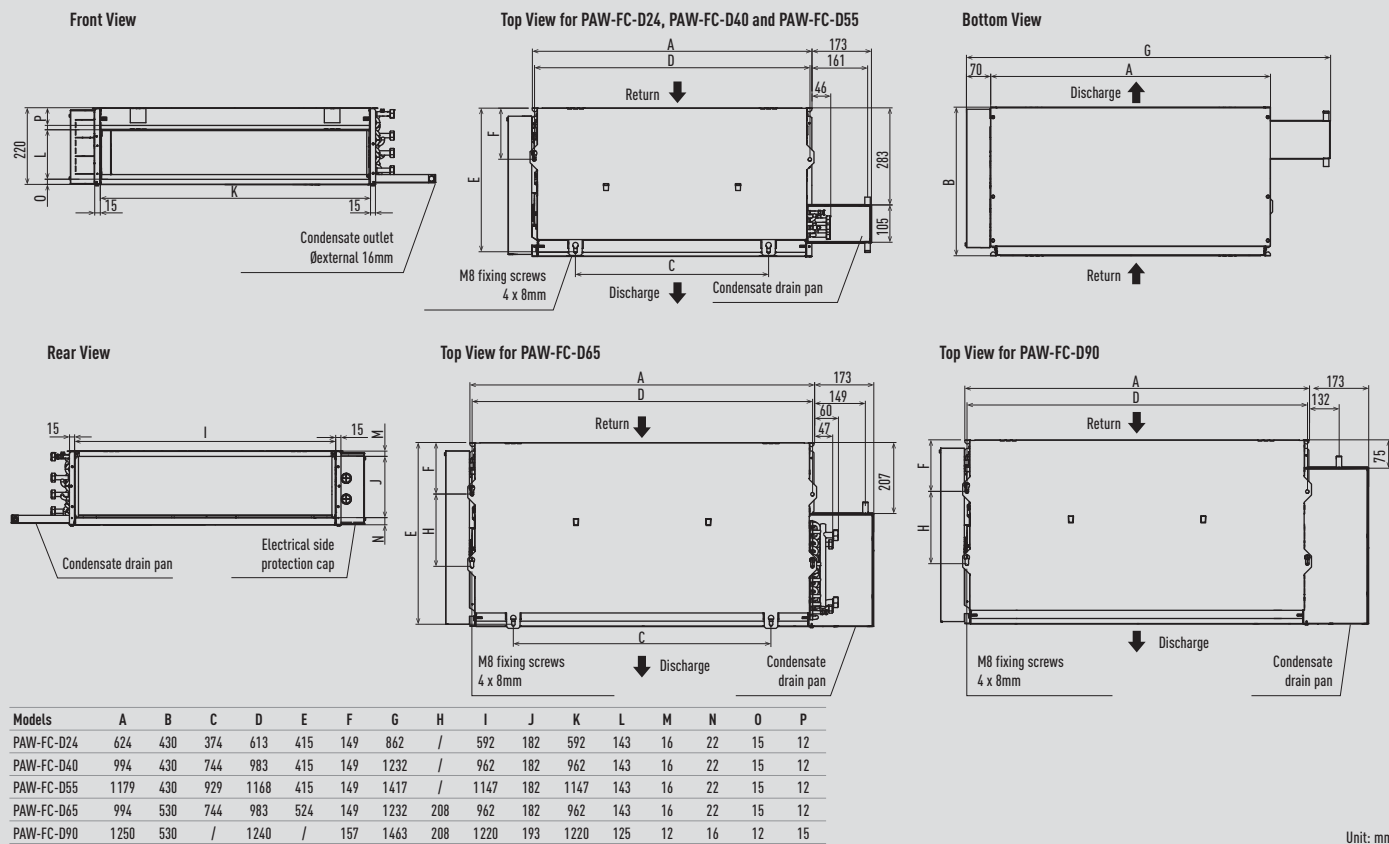

Unit: mm

### Fan Coil High Static Pressure

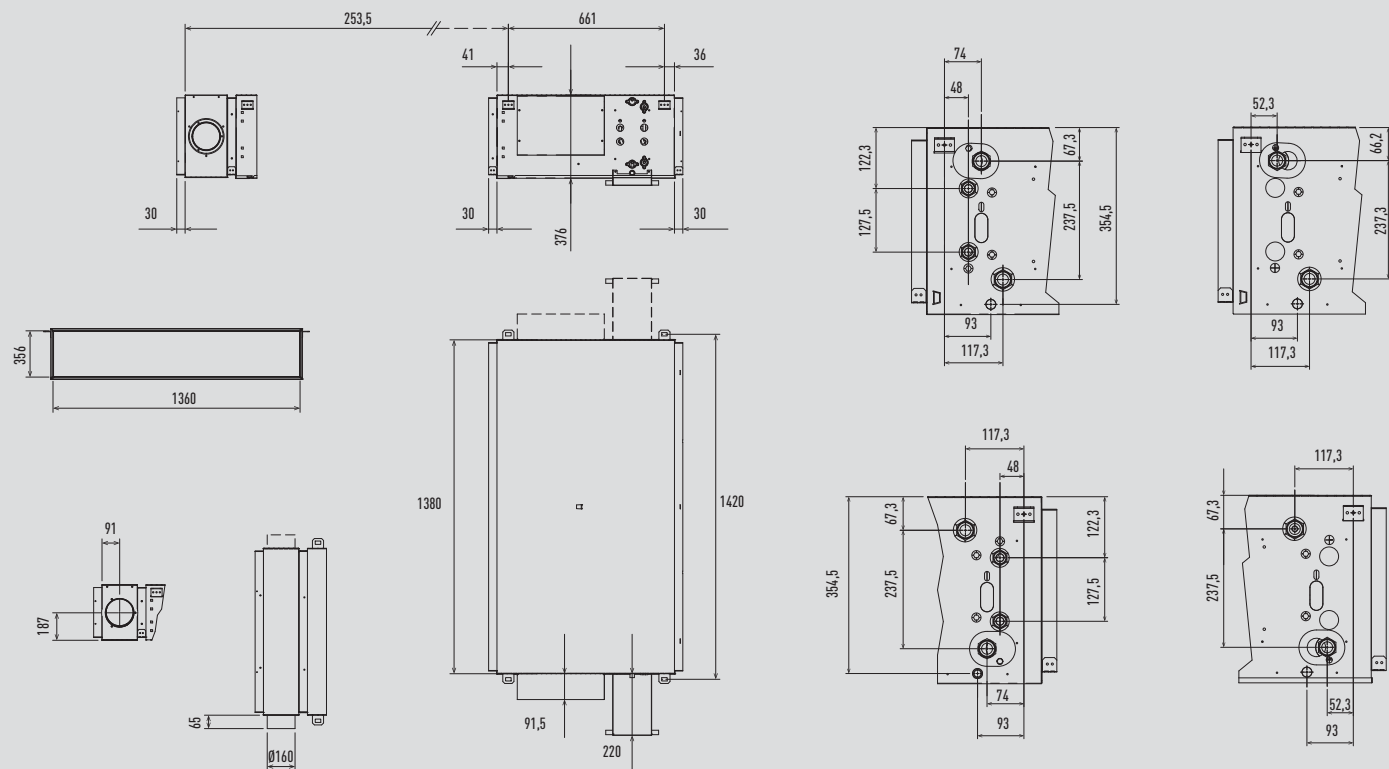

Unit: mm

Aquarea DHW Floor standing

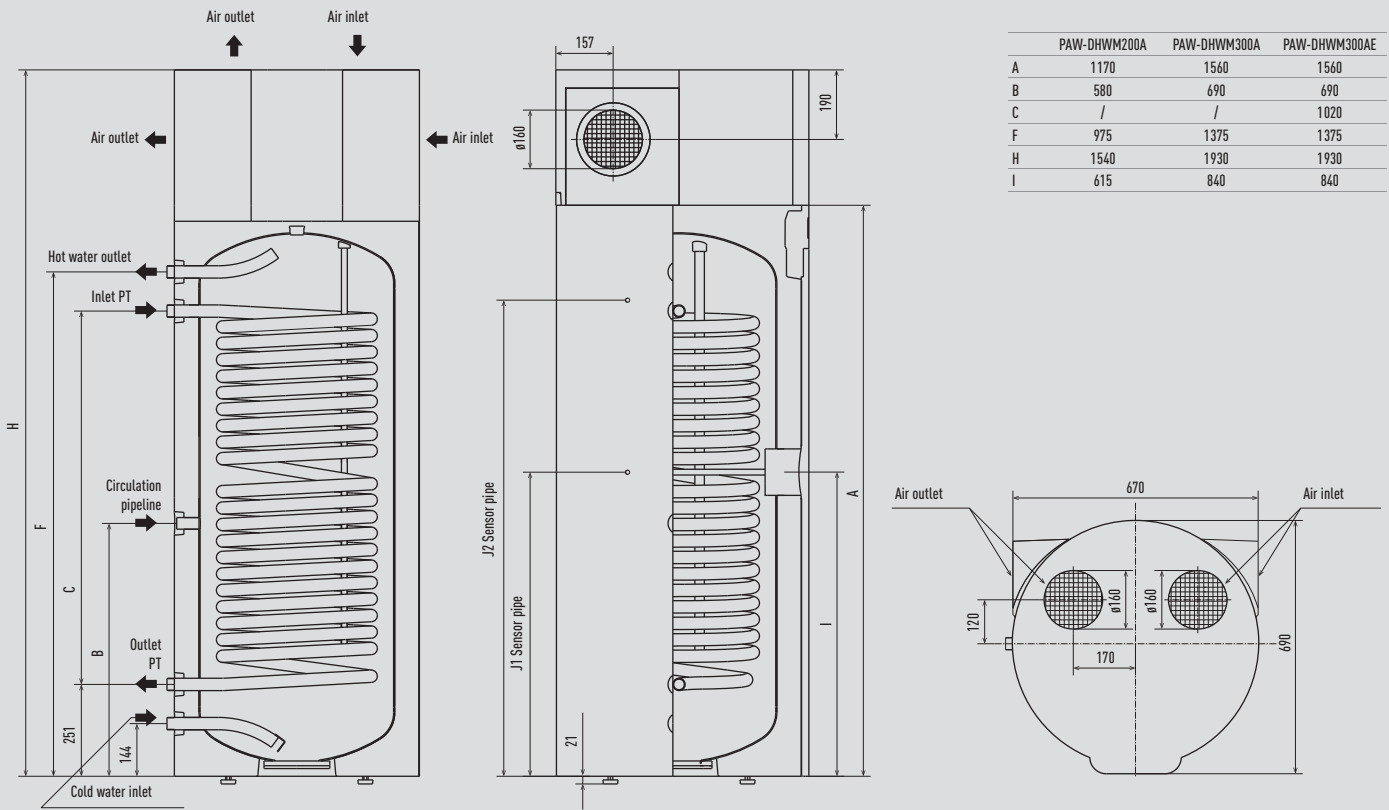

	PAW-DHWM200A	PAW-DHWM300A	PAW-DHWM300AE
A	1170	1560	1560
B	580	690	690
C	/	/	1020
F	975	1375	1375
H	1540	1930	1930
I	615	840	840

Unit: mm

Aquarea DHW Wall mounted

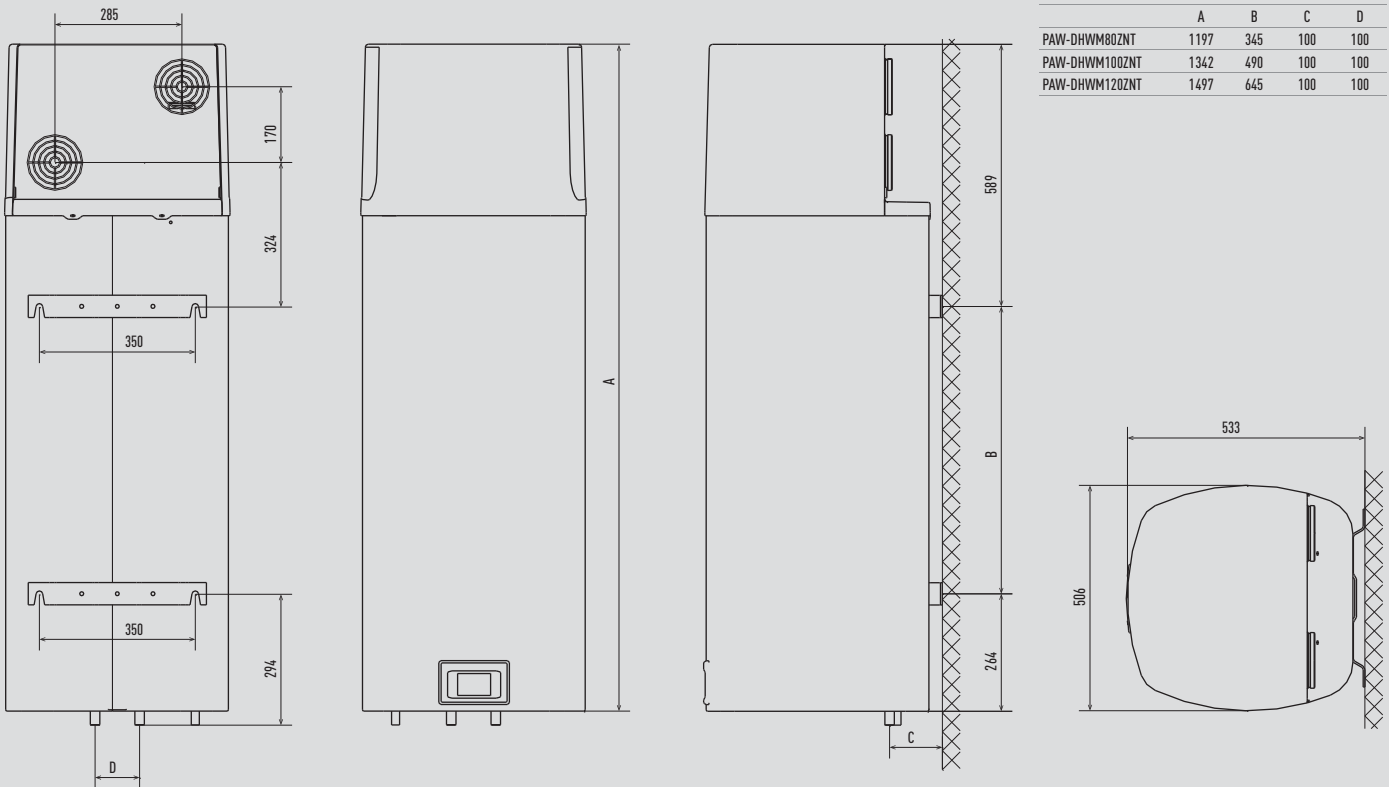

	A	B	C	D
PAW-DHWM80ZNT	1197	345	100	100
PAW-DHWM100ZNT	1342	490	100	100
PAW-DHWM120ZNT	1497	645	100	100

Unit: mm

Wall Mounted TKEA

CS-Z25TKEA / CS-Z35TKEA

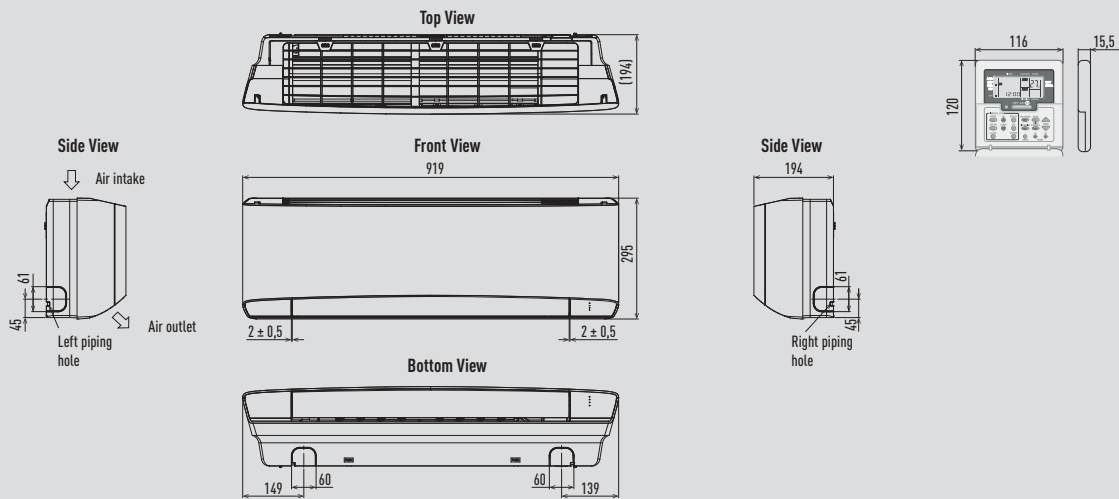

CS-Z42TKEA / CS-Z50TKEA / CS-Z71TKEA

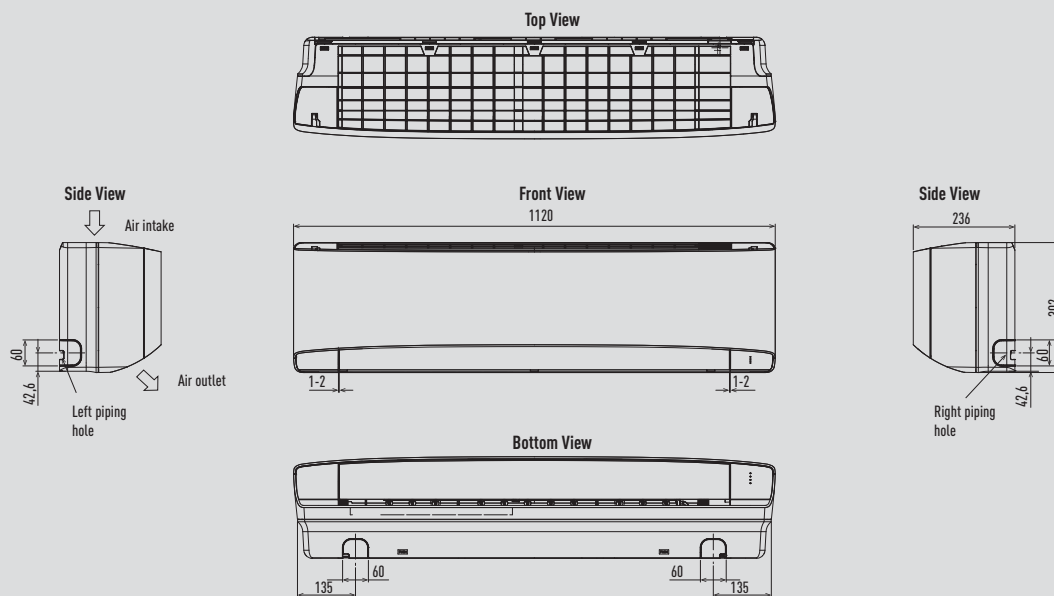

CU-Z25TKEA / CU-Z35TKEA / CU-Z42TKEA

CU-Z50TKEA / CU-Z71TKEA

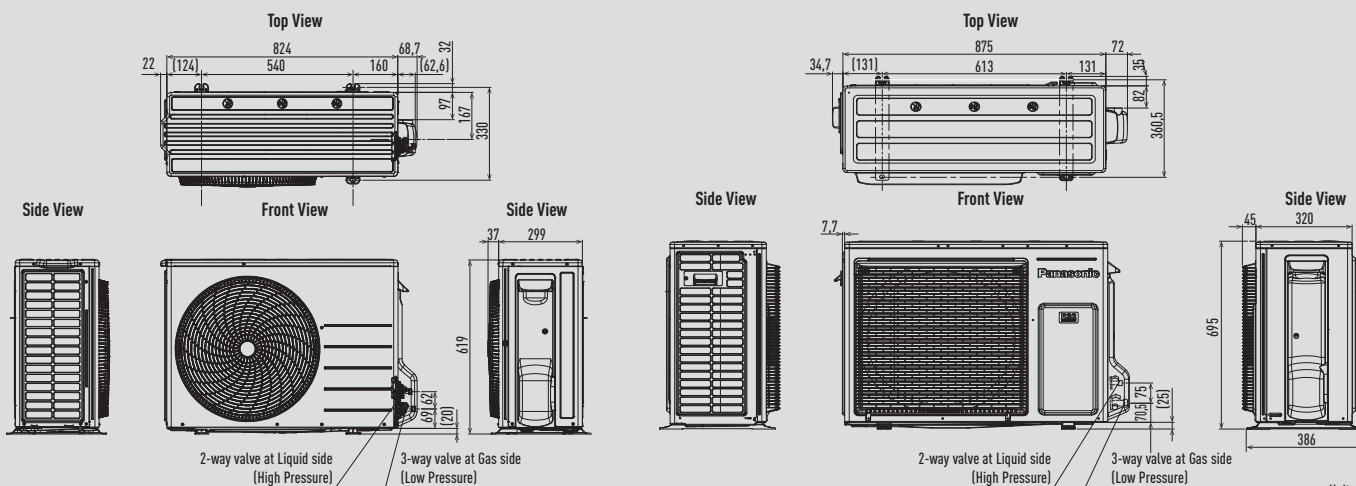

Unit: mm

Wall Mounted PKEA

CS-E9PKEA / CS-E12PKEA

CS-E15PKEA / CS-E18PKEA

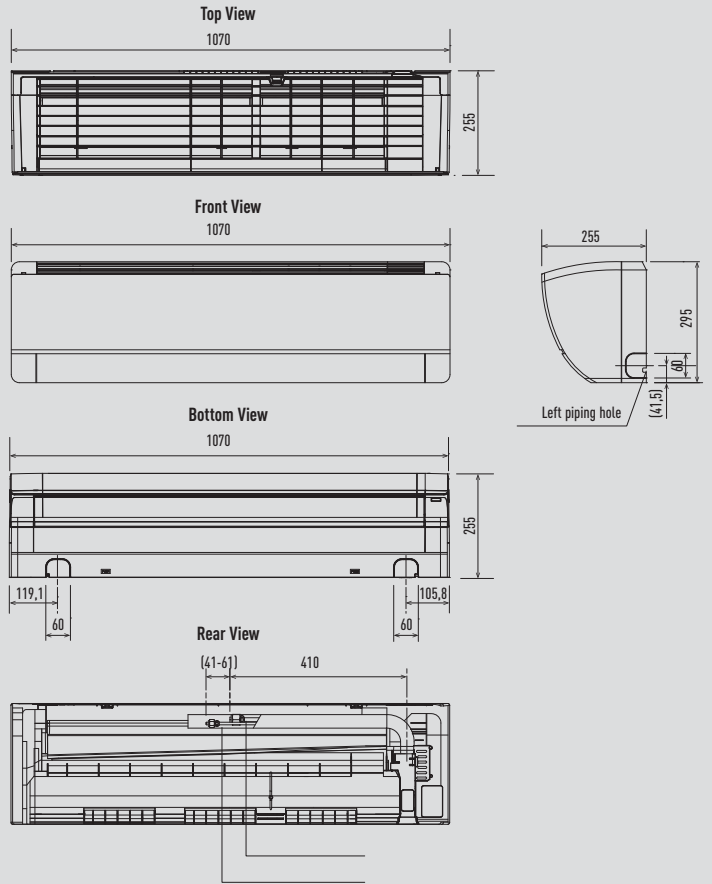
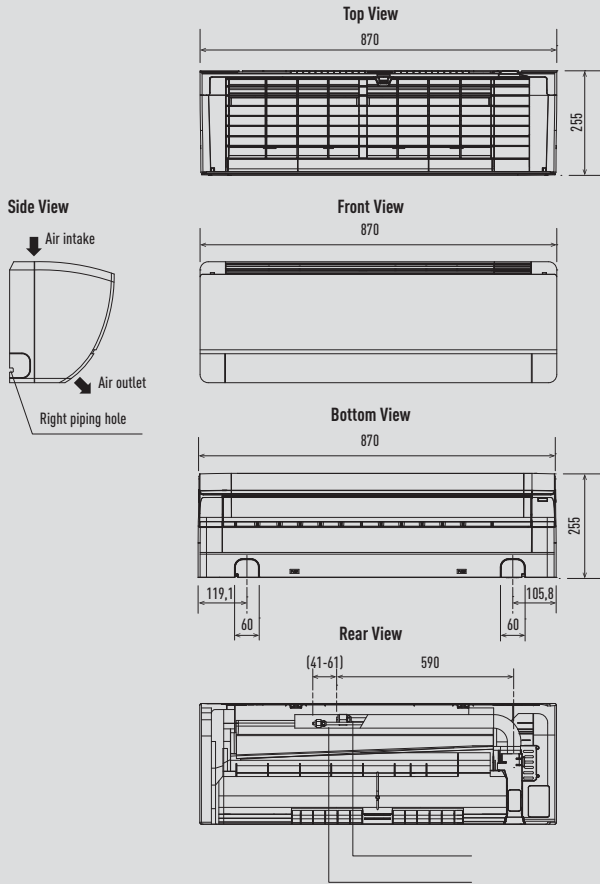

CU-E9PKEA / CU-E12PKEA

CU-E15PKEA / CU-E18PKEA

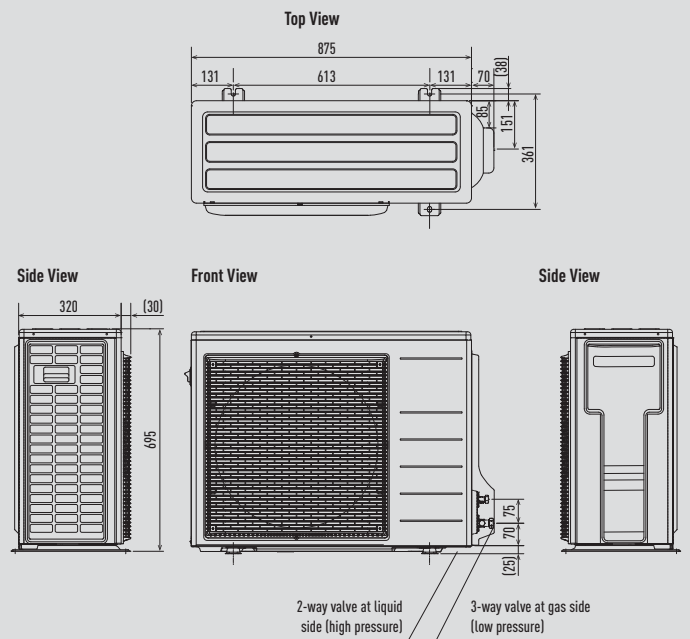
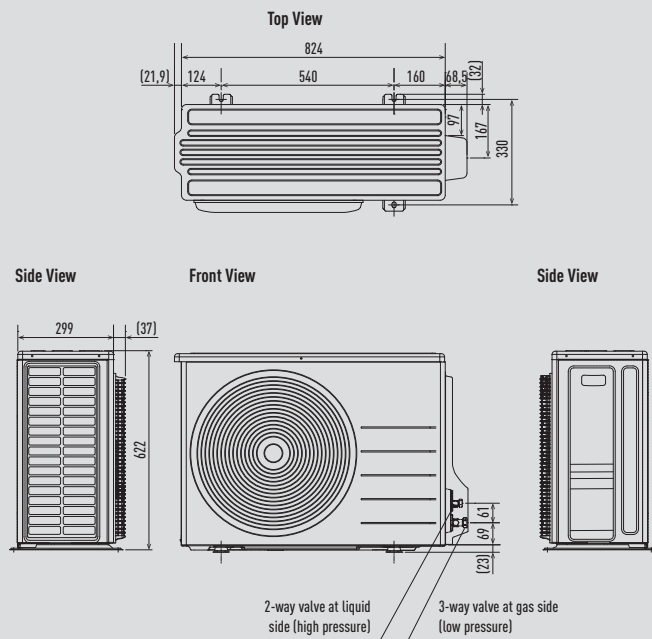

PACi Wall Mounted

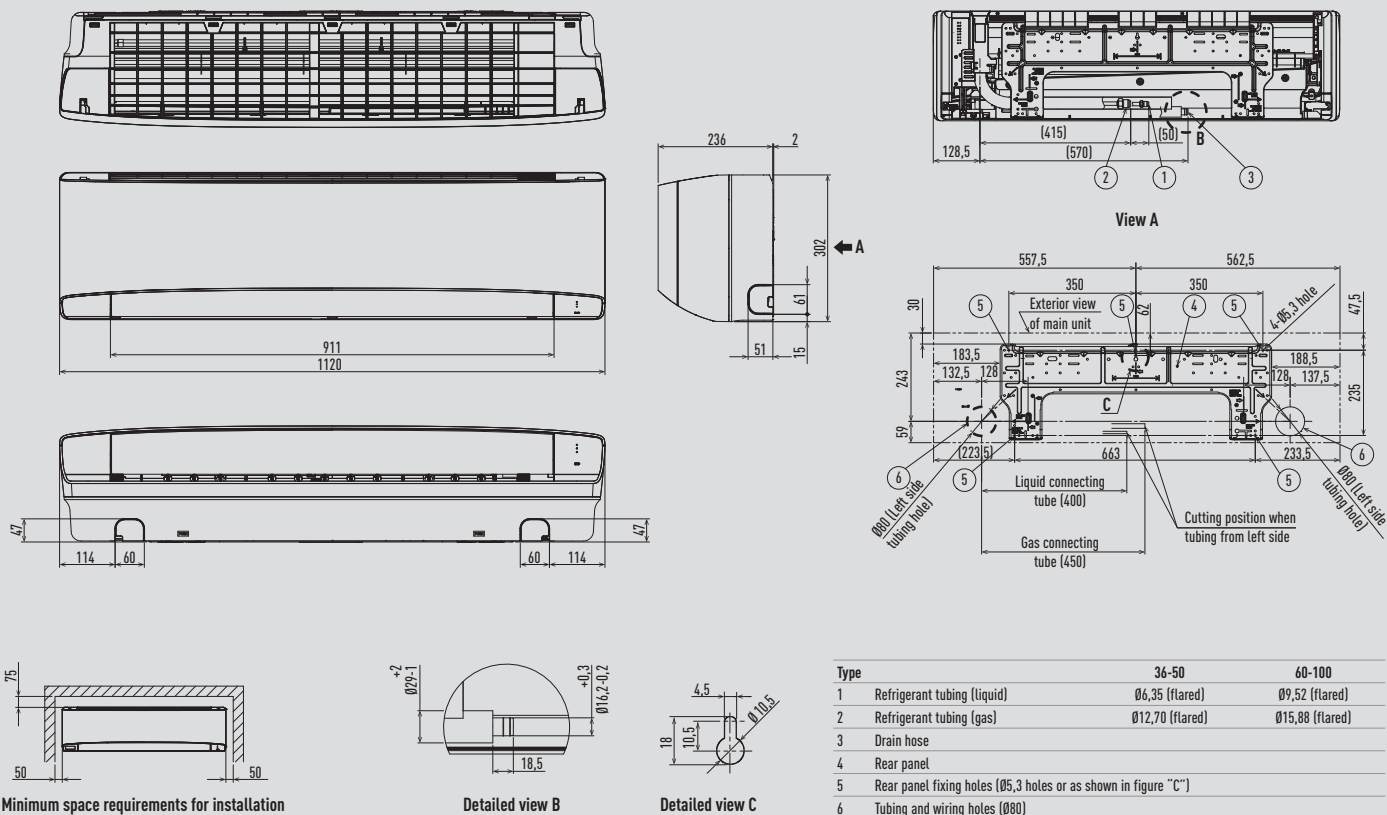

PACi 4-Way 60x60 Cassette

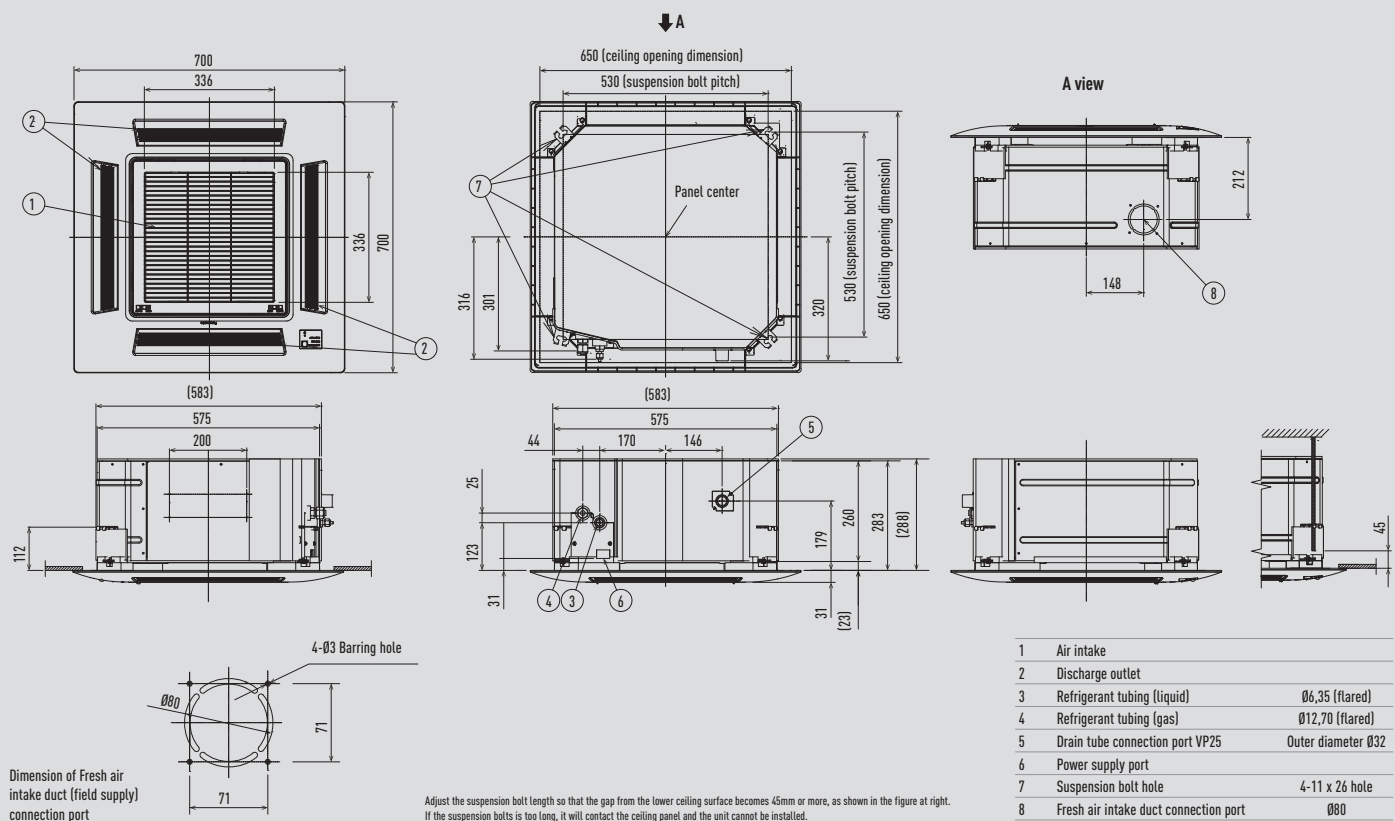

PACi 4 Way 90x90 Cassette

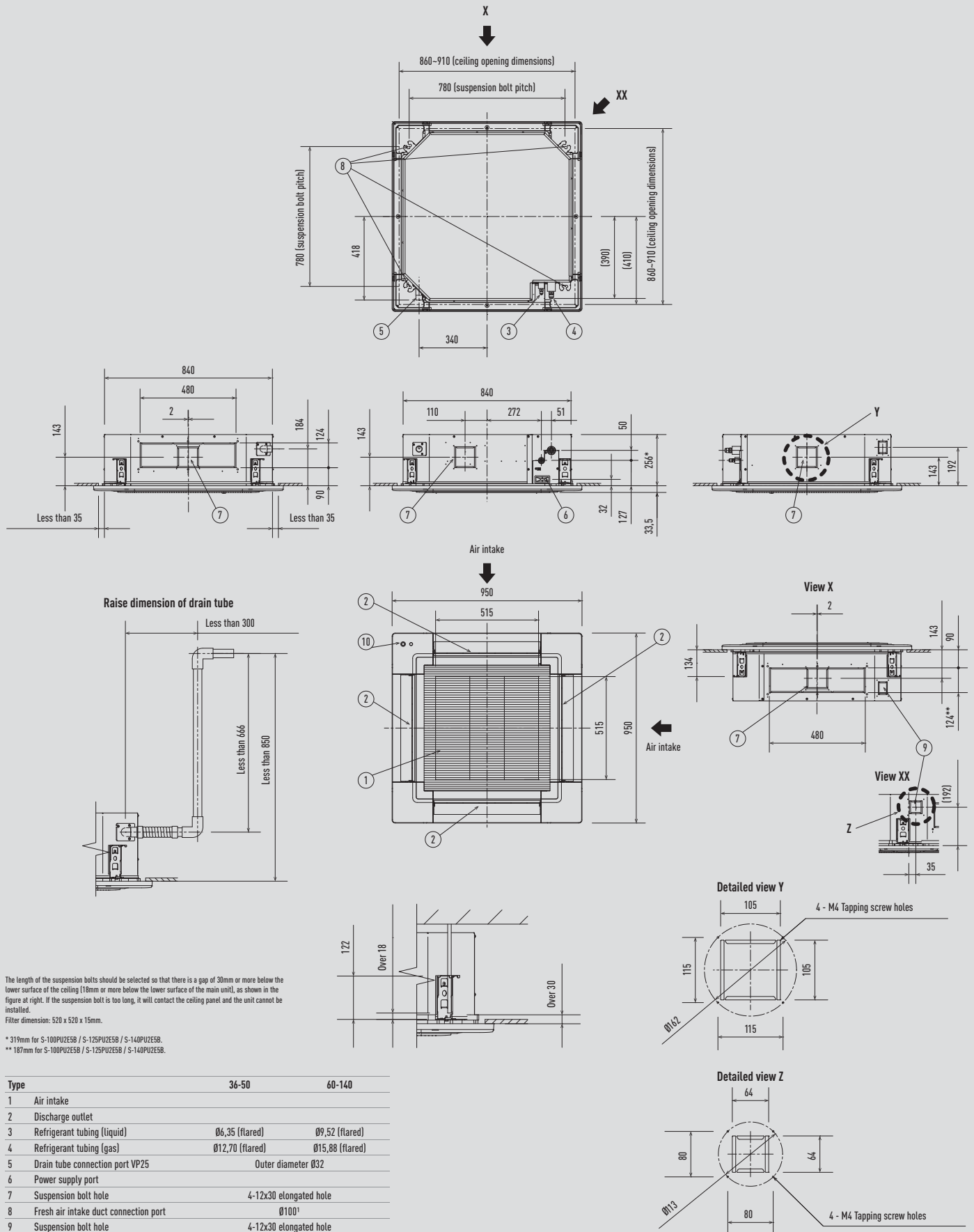

The length of the suspension bolts should be selected so that there is a gap of 30mm or more below the lower surface of the ceiling (18mm or more below the lower surface of the main unit), as shown in the figure at right. If the suspension bolt is too long, it will contact the ceiling panel and the unit cannot be installed.  
Filter dimension: 520 x 520 x 15mm.

\* 319mm for S-100PUZE5B / S-125PUZE5B / S-140PUZE5B.  
\*\* 187mm for S-100PUZE5B / S-125PUZE5B / S-140PUZE5B.

Type	36-50	60-140
1 Air intake		
2 Discharge outlet		
3 Refrigerant tubing (liquid)	Ø6,35 (flared)	Ø9,52 (flared)
4 Refrigerant tubing (gas)	Ø12,70 (flared)	Ø15,88 (flared)
5 Drain tube connection port VP25	Outer diameter Ø32	
6 Power supply port		
7 Suspension bolt hole	4-12x30 elongated hole	
8 Fresh air intake duct connection port	Ø100 <sup>1)</sup>	
9 Suspension bolt hole	4-12x30 elongated hole	
10 Econavi sensor (Only CZ-KPU3A)		

1) Necessary to attach duct connecting flange(field supplied).

Unit: mm

PACi Ceiling

S-36PT2E5B / S-45PT2E5B / S-50PT2E5B

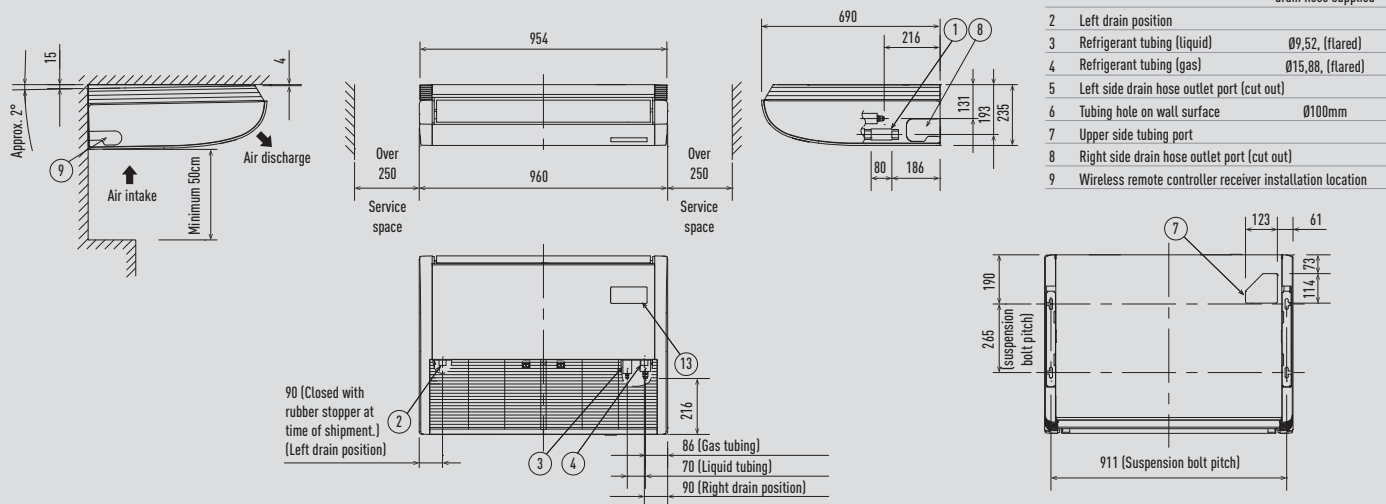

S-60PT2E5B / S-71PT2E5B

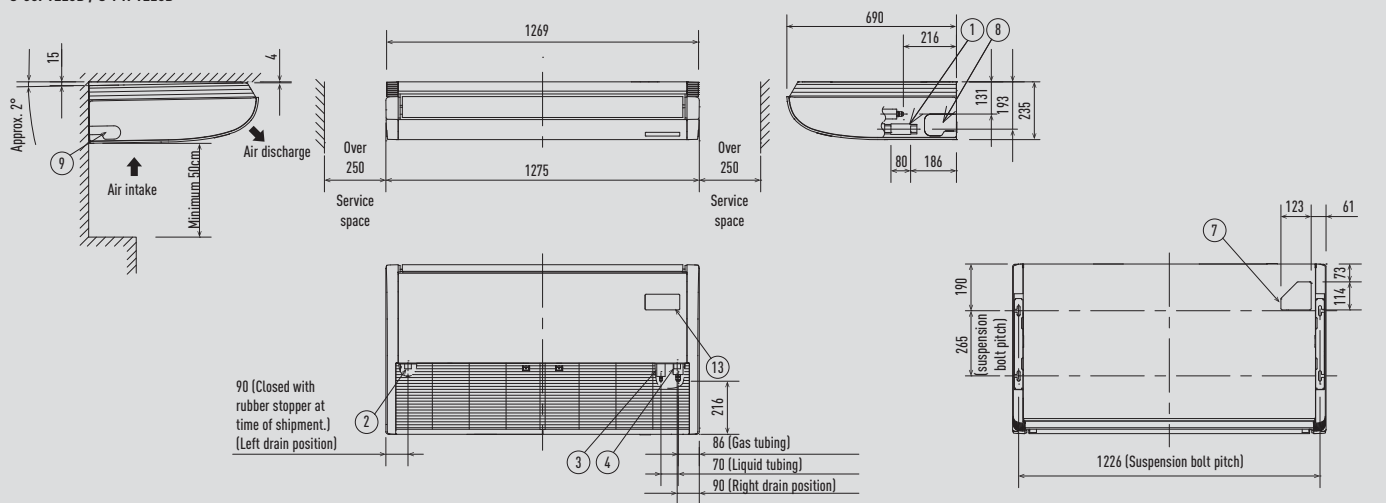

S-100PT2E5B / S-125PT2E5B / S-140PT2E5B

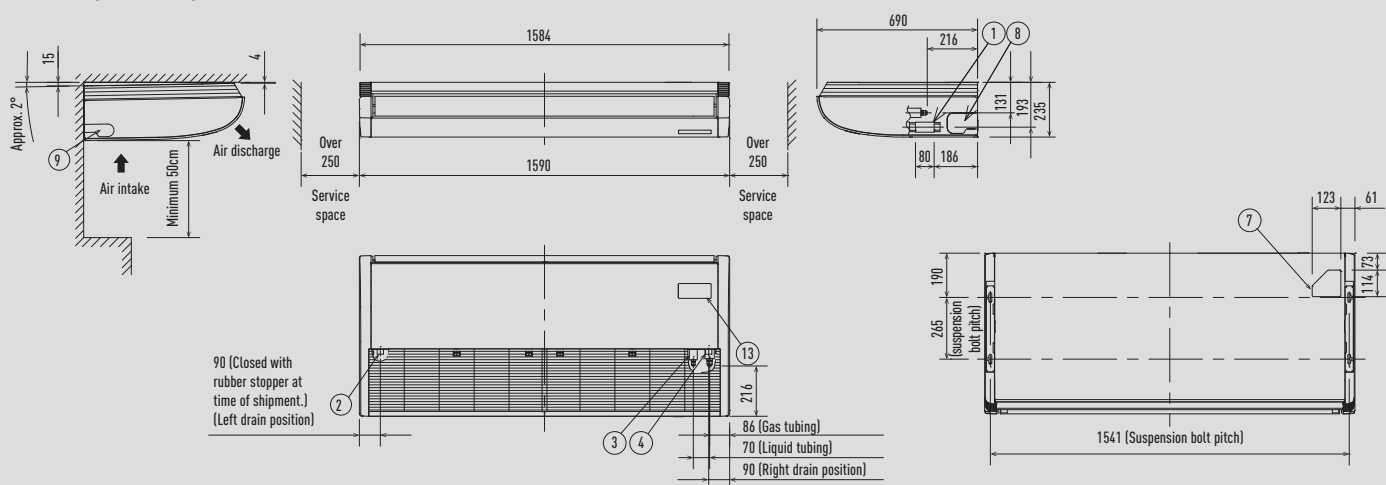

PACi High Static Pressure Hide Away

S-36PF1E5B / S-45PF1E5B / S-50PF1E5B

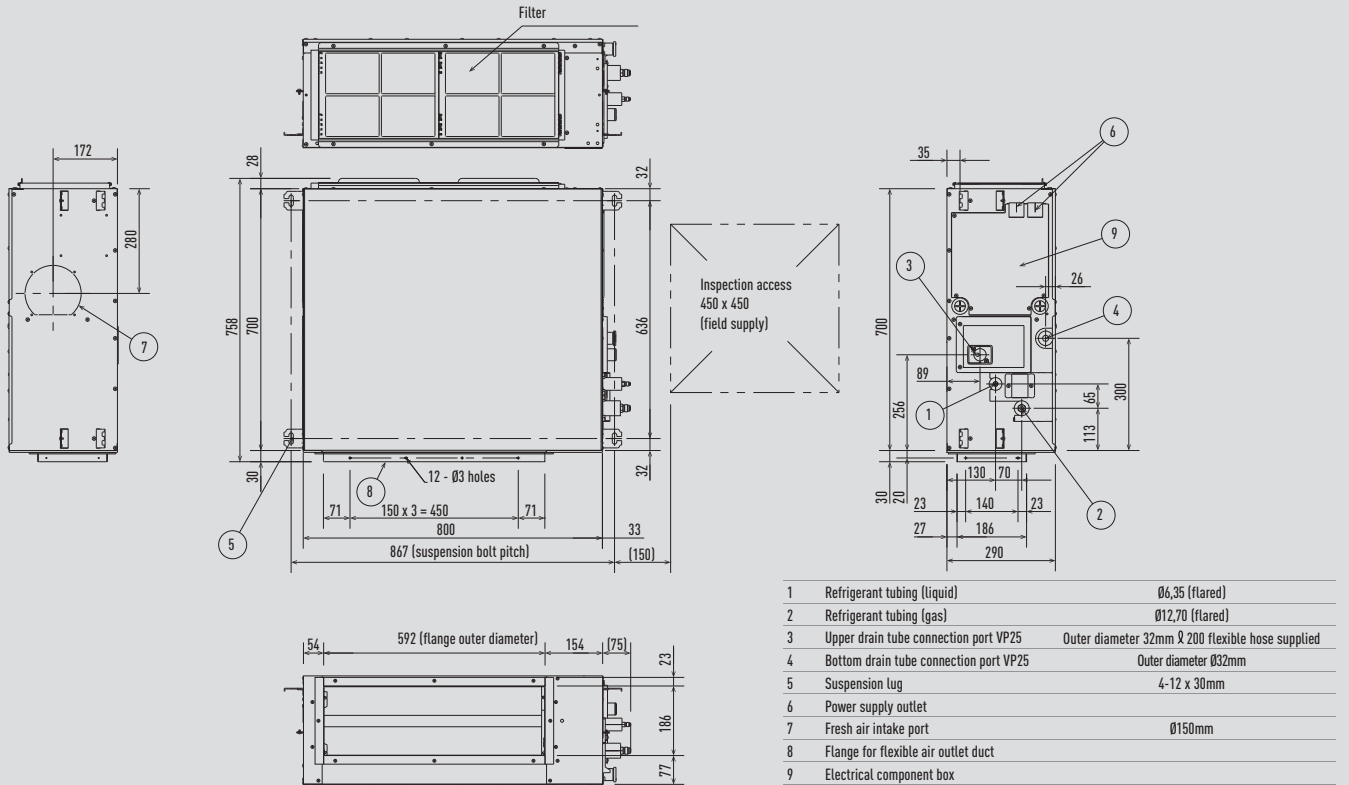

S-60PF1E5B / S-71PF1E5B

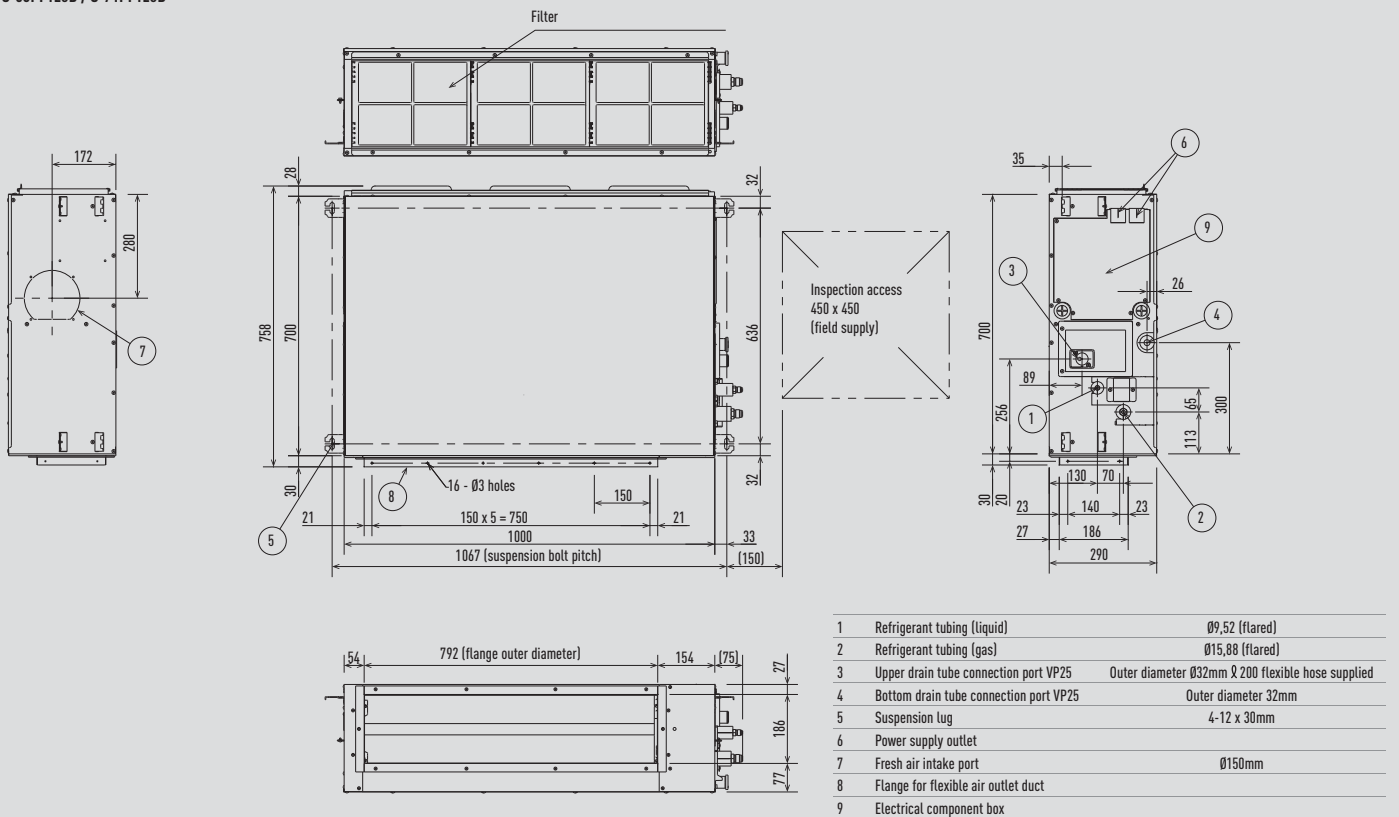



### High Static Pressure Hide Away (Cont.)

S-100PF1E5B / S-125PF1E5B / S-140PF1E5B

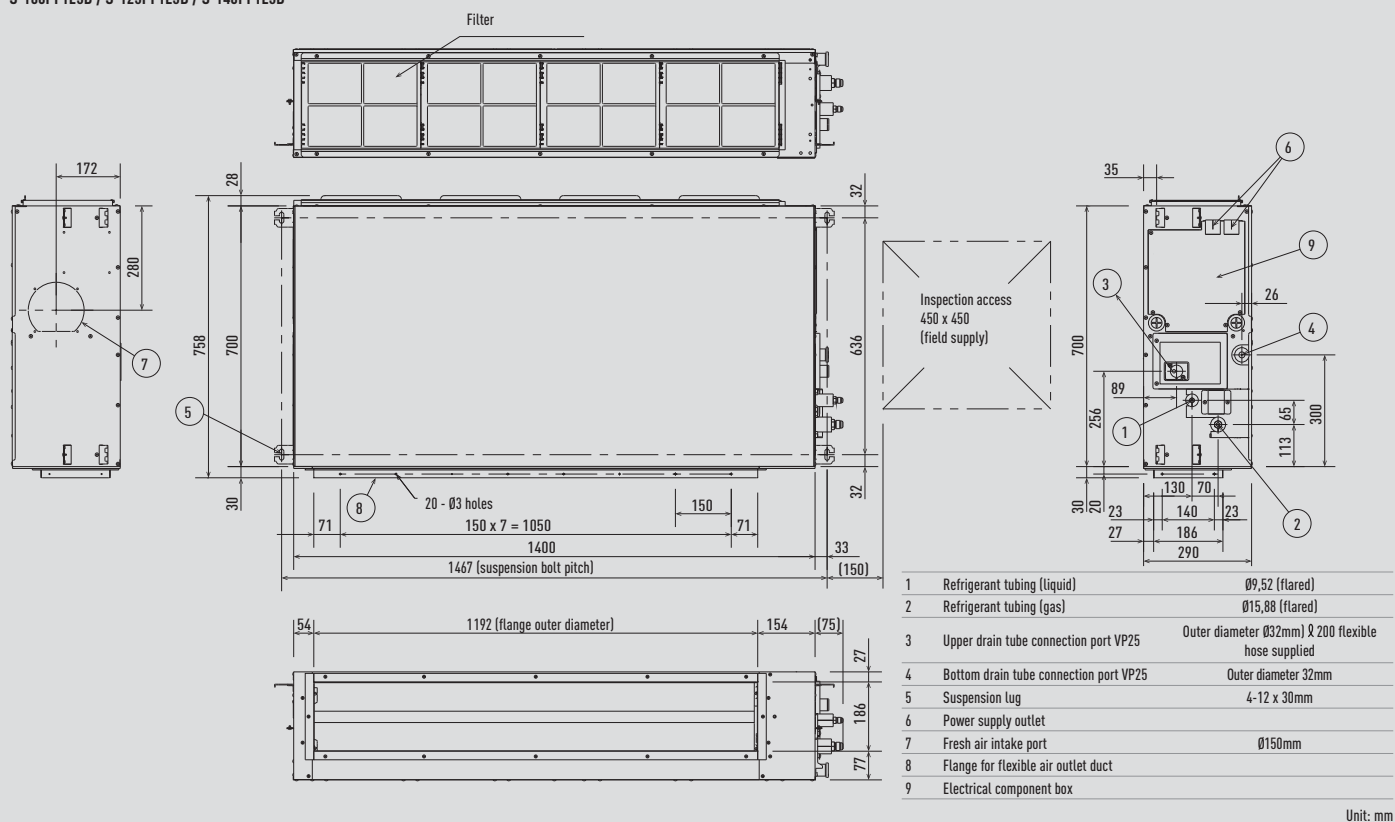

### PACi Low Static Pressure Hide Away

S-36PN1E5A / S-45PN1E5A / S-50PN1E5A

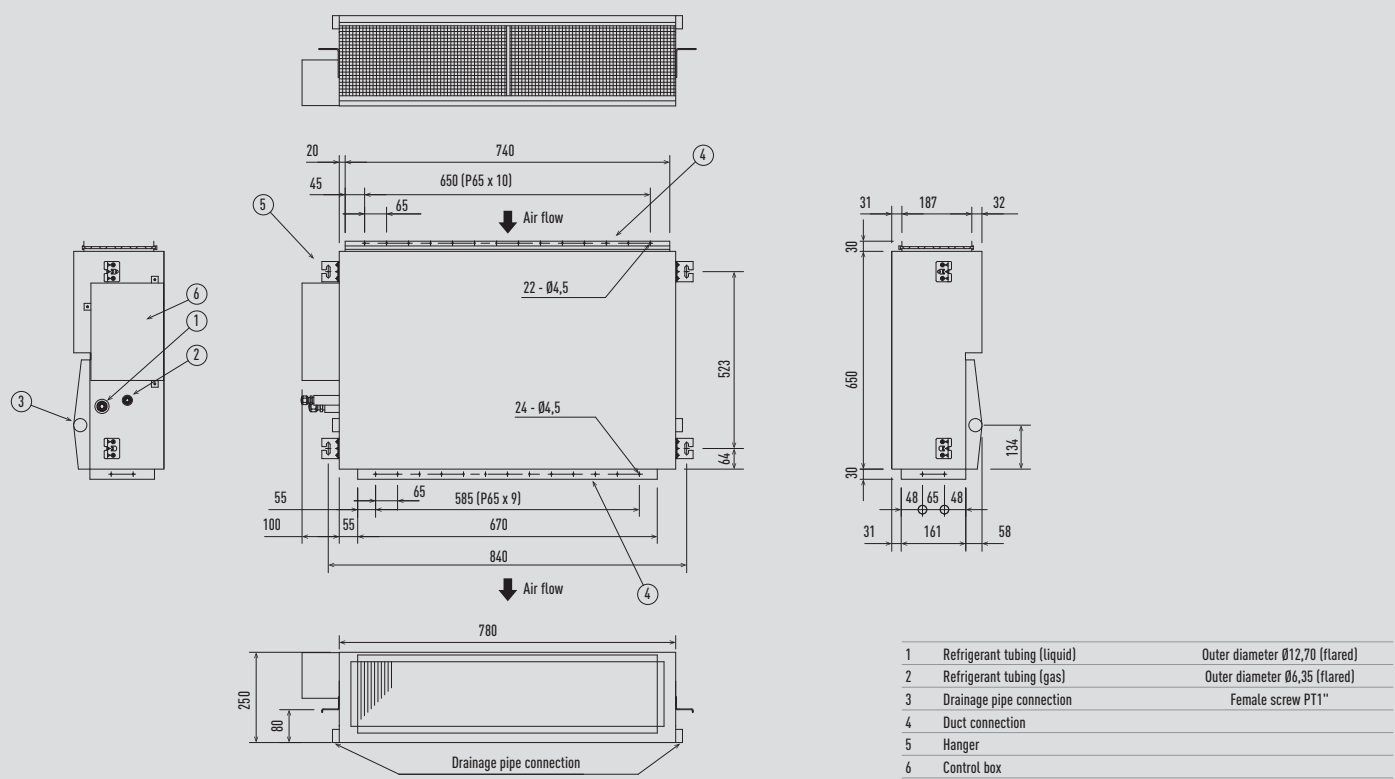

PACi Low Static Pressure Hide Away (Cont.)

S-60PN1E5A / S-71PN1E5A

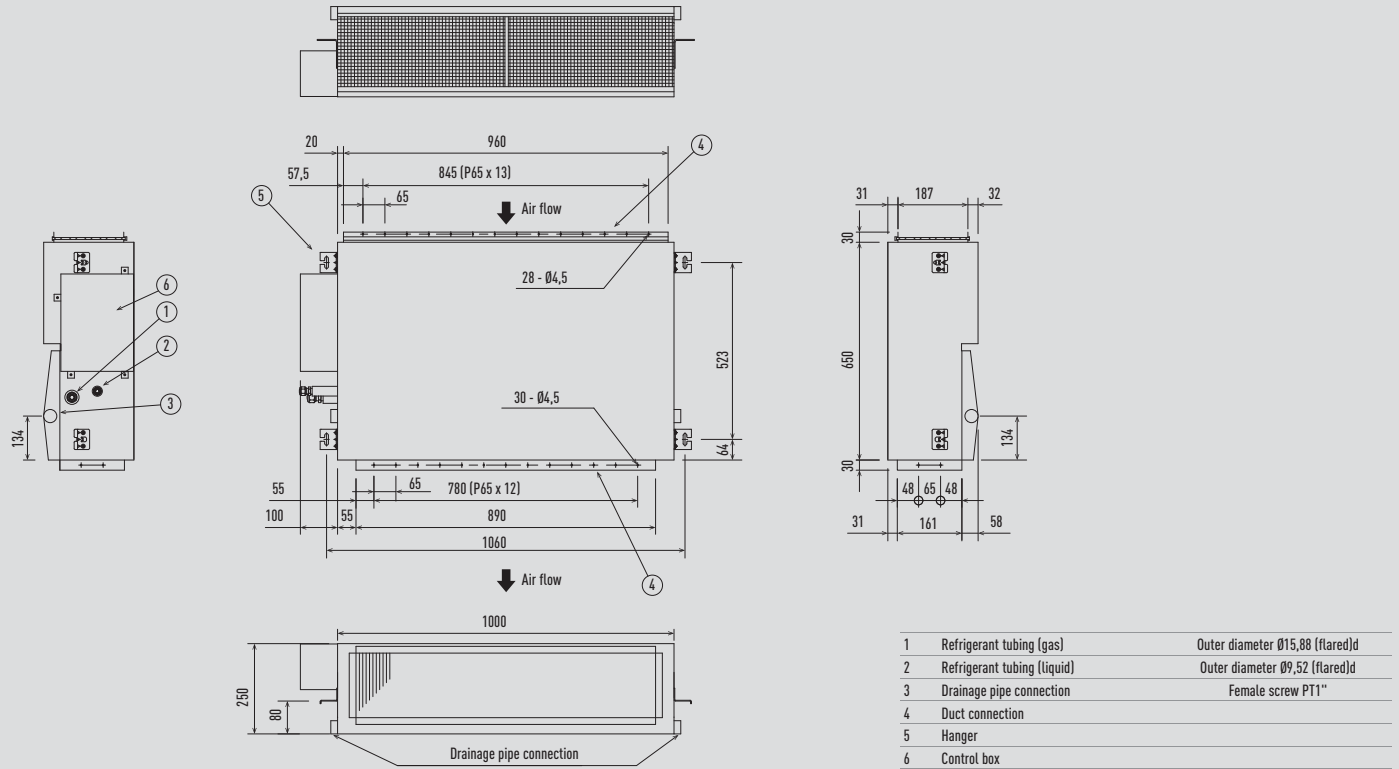

S-100PN1E5A / S-125PN1E5A / S-140PN1E5A

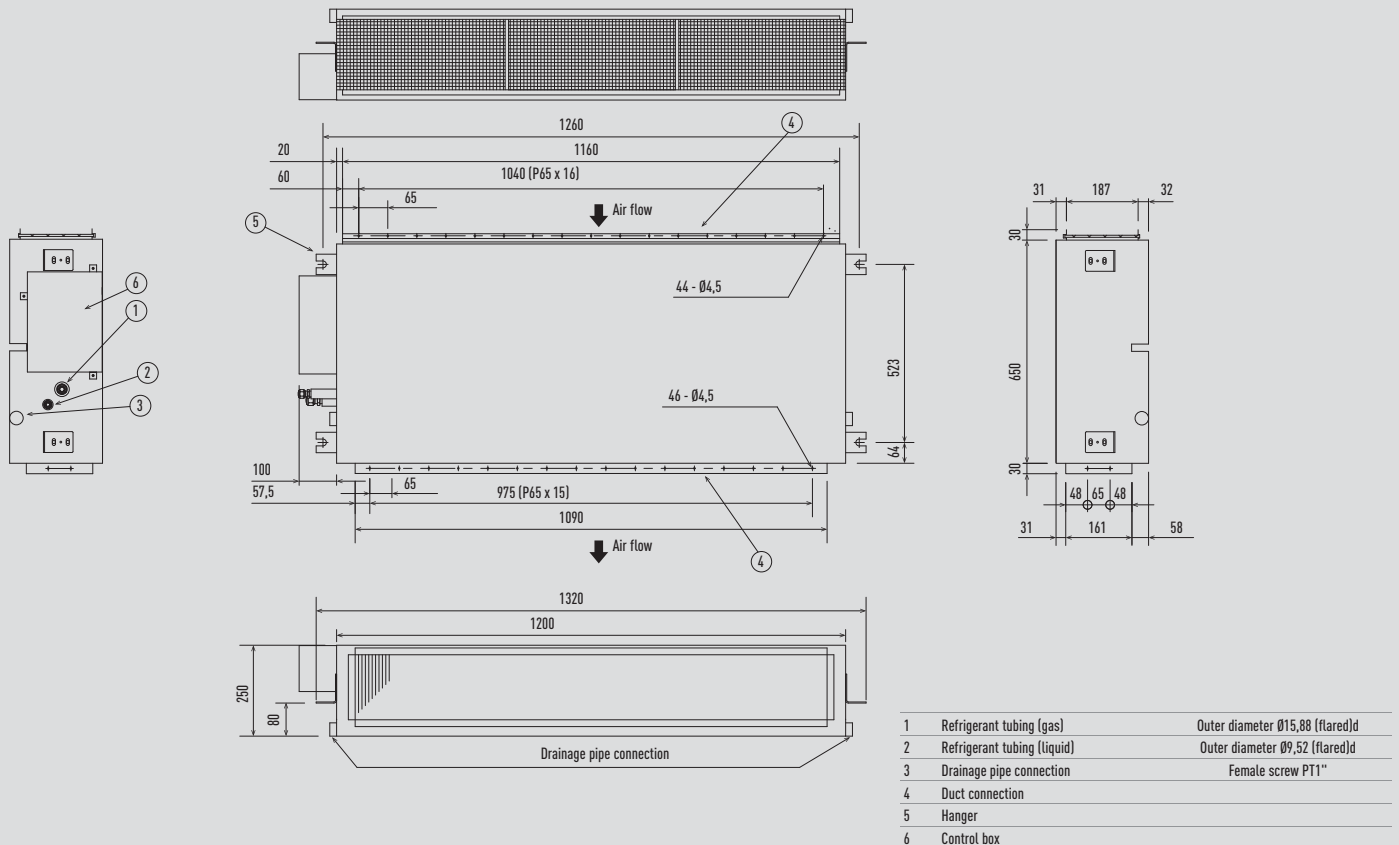

PACi High Static Pressure Hide Away 20,0-25,0kW

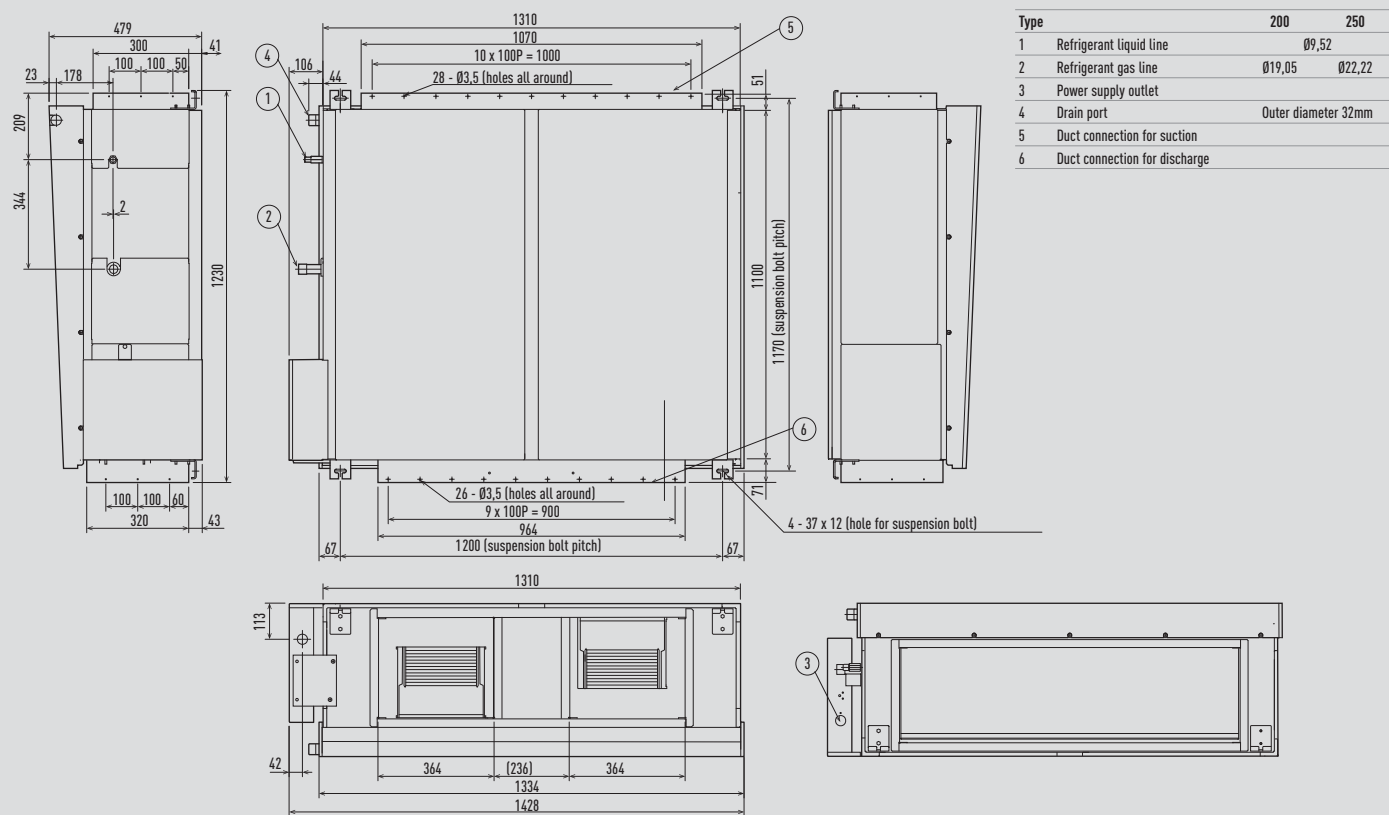

Type	200	250
1 Refrigerant liquid line		Ø9,52
2 Refrigerant gas line	Ø19,05	Ø22,22
3 Power supply outlet		
4 Drain port	Outer diameter 32mm	
5 Duct connection for suction		
6 Duct connection for discharge		

Unit: mm

PACi R32 outdoor unit: small 1 fan

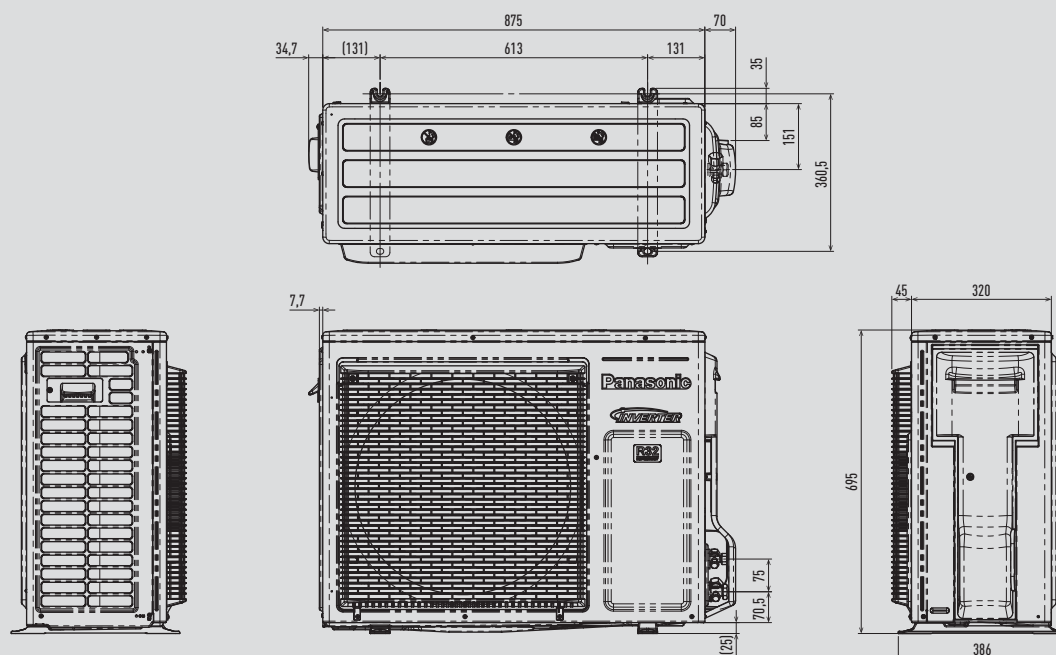

Unit: mm

PACi Elite R32 outdoor unit: medium 1 fan

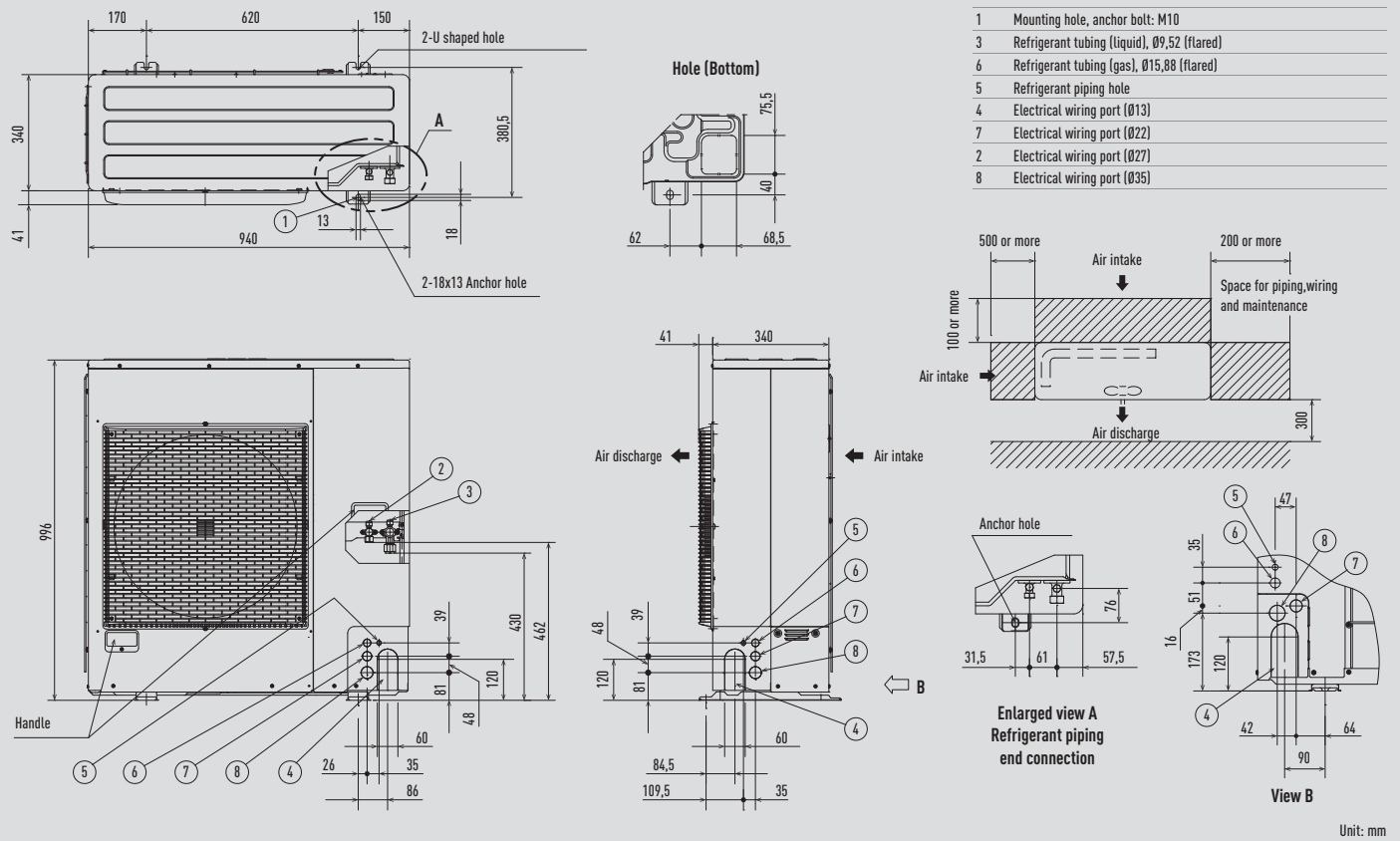

PACi Standard R32 outdoor unit: medium 1 fan

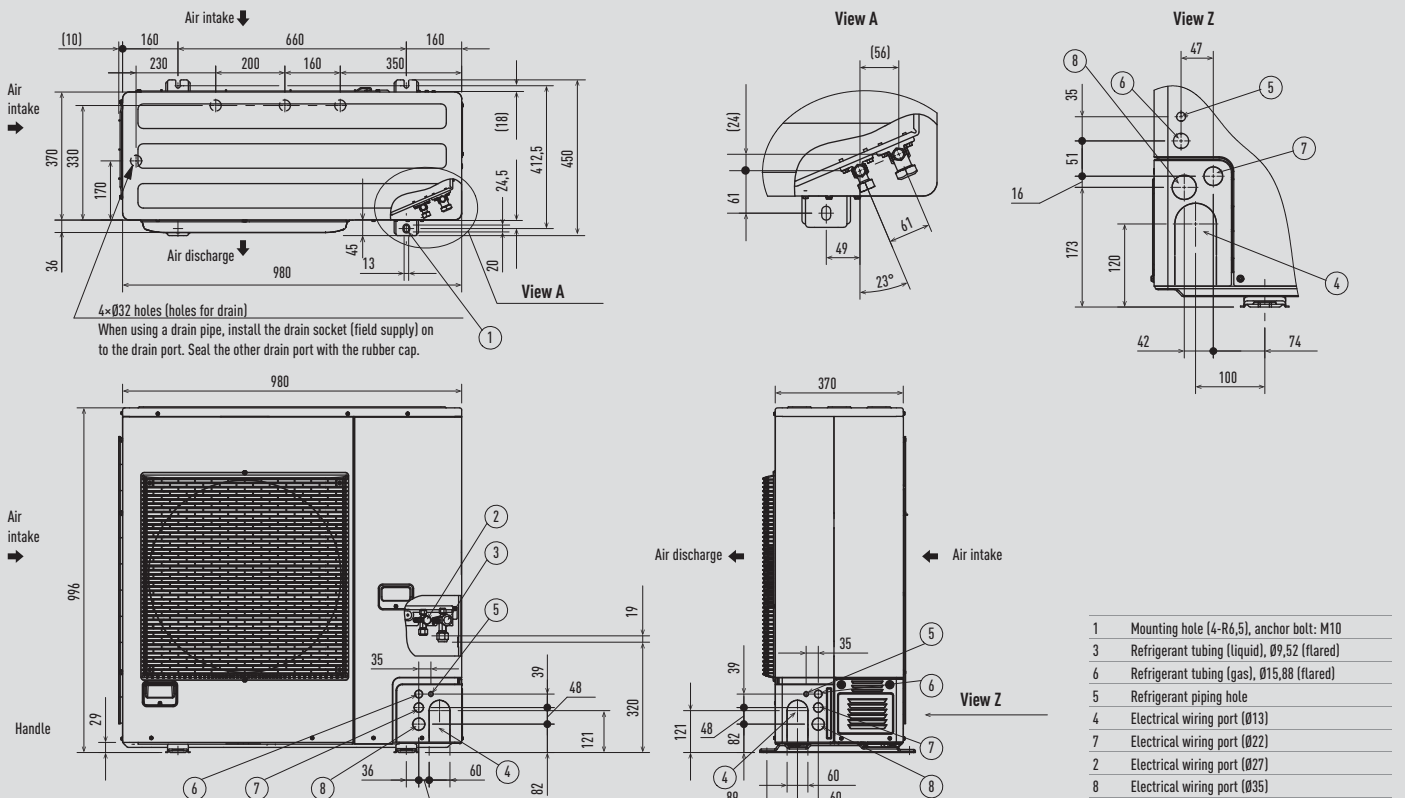

PACi R32 outdoor unit: 2 fans

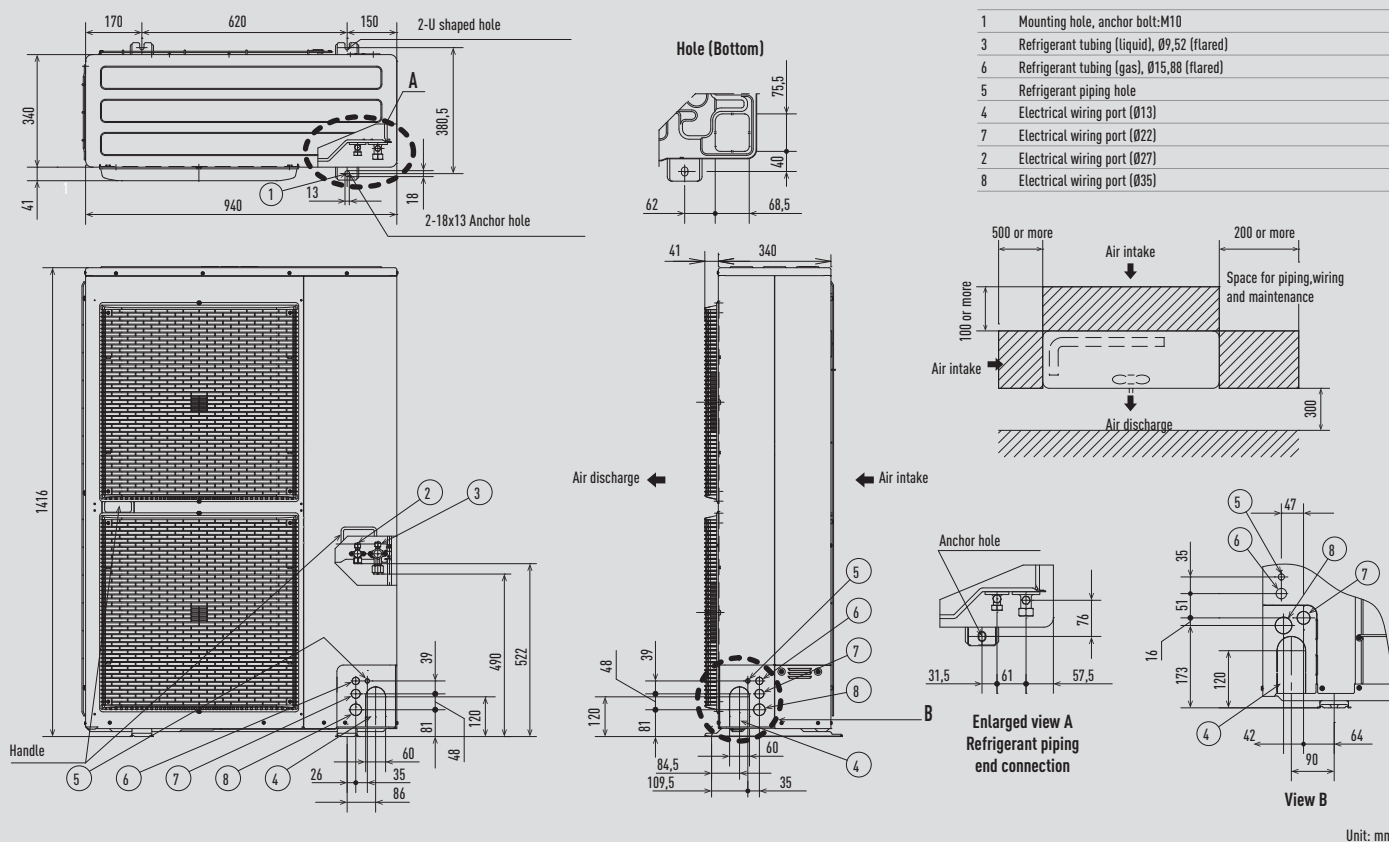

PACi R410A outdoor unit: small 1 fan

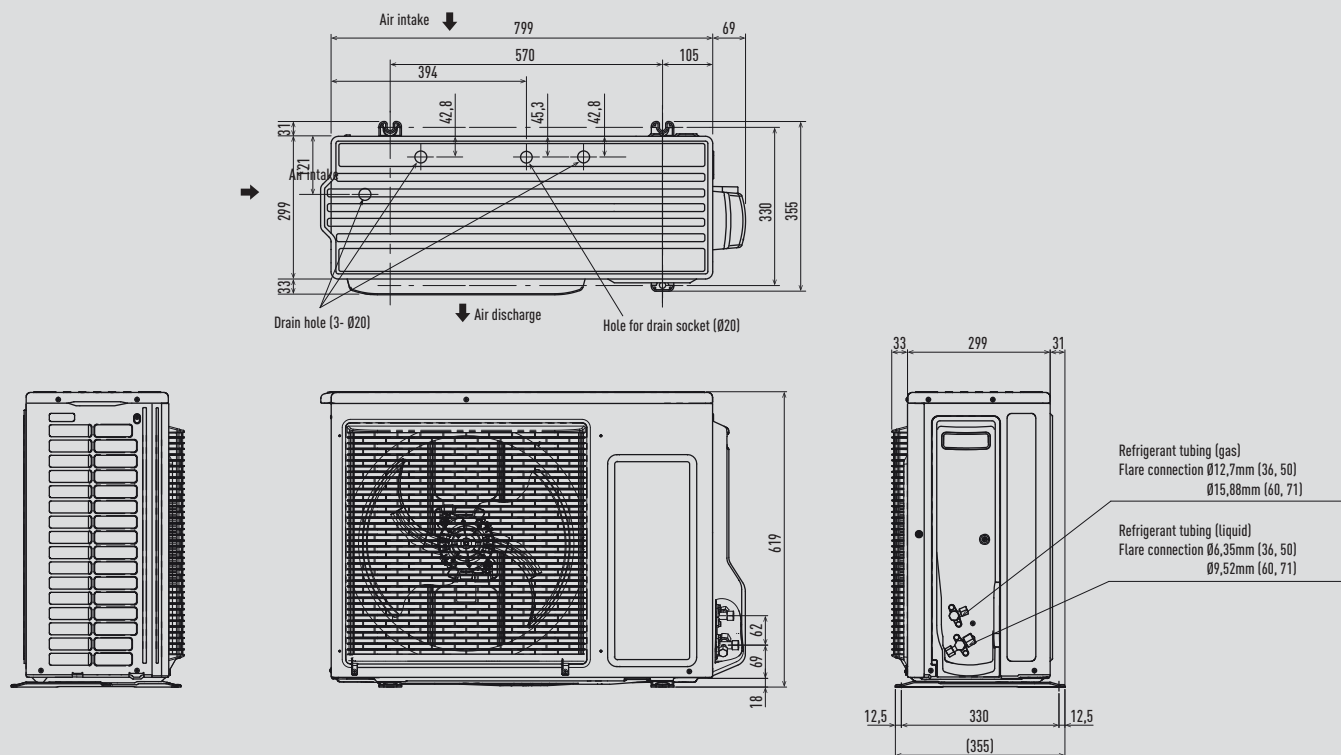

PACi R410A outdoor unit: medium 1 fan

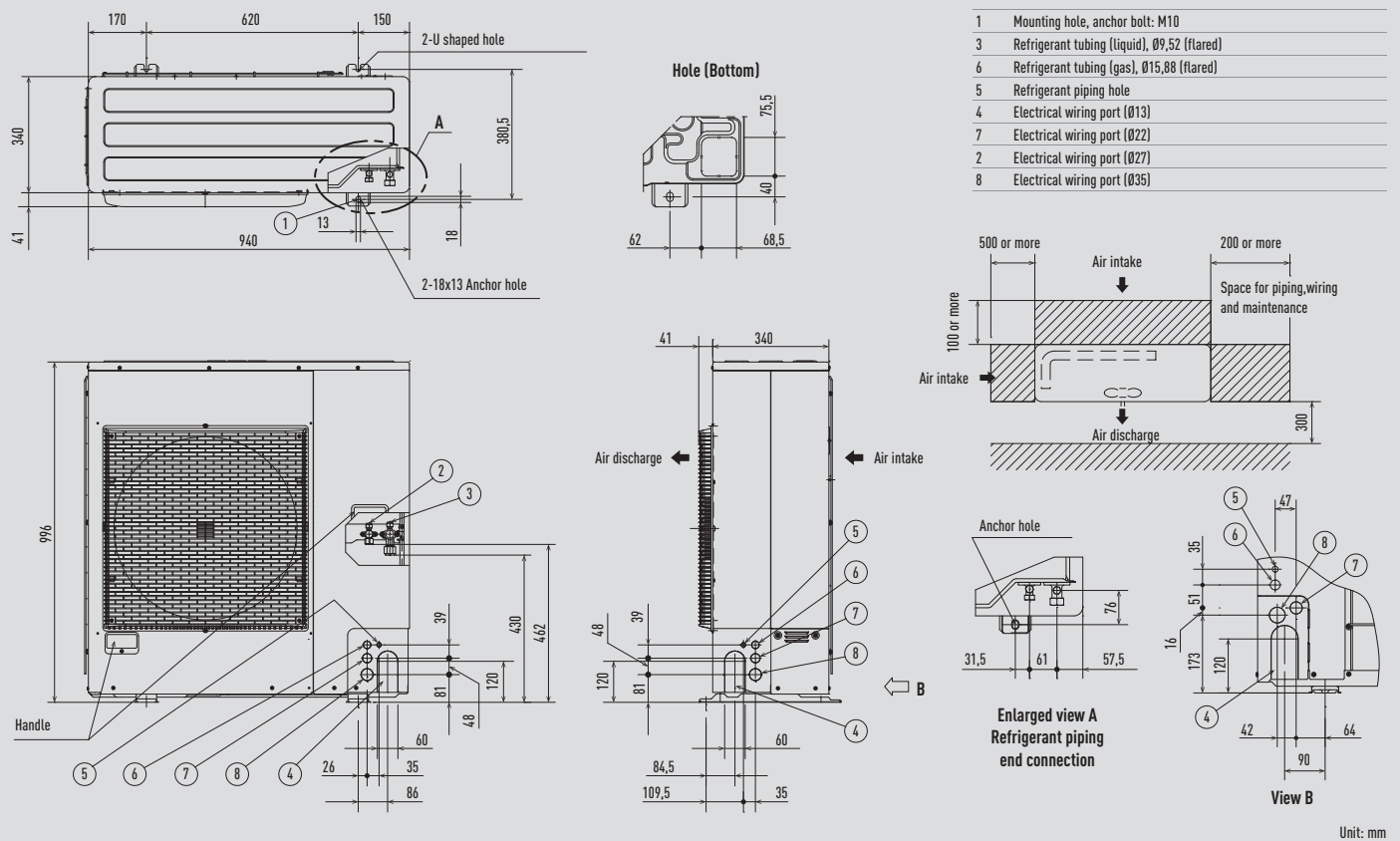

PACi R410A outdoor unit: 2 fans

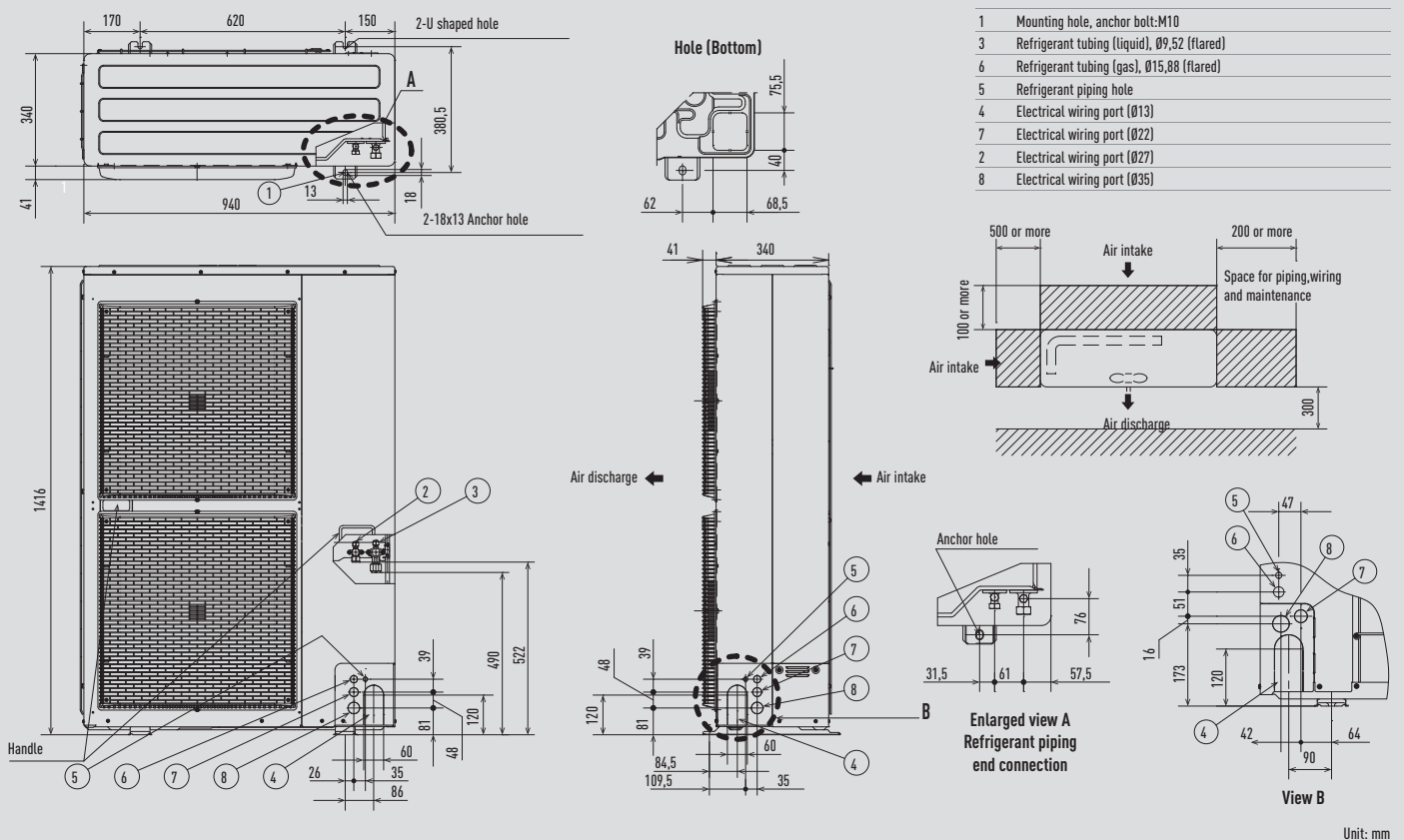

### Big PACi R410A outdoor unit 20,0 and 25,0kW

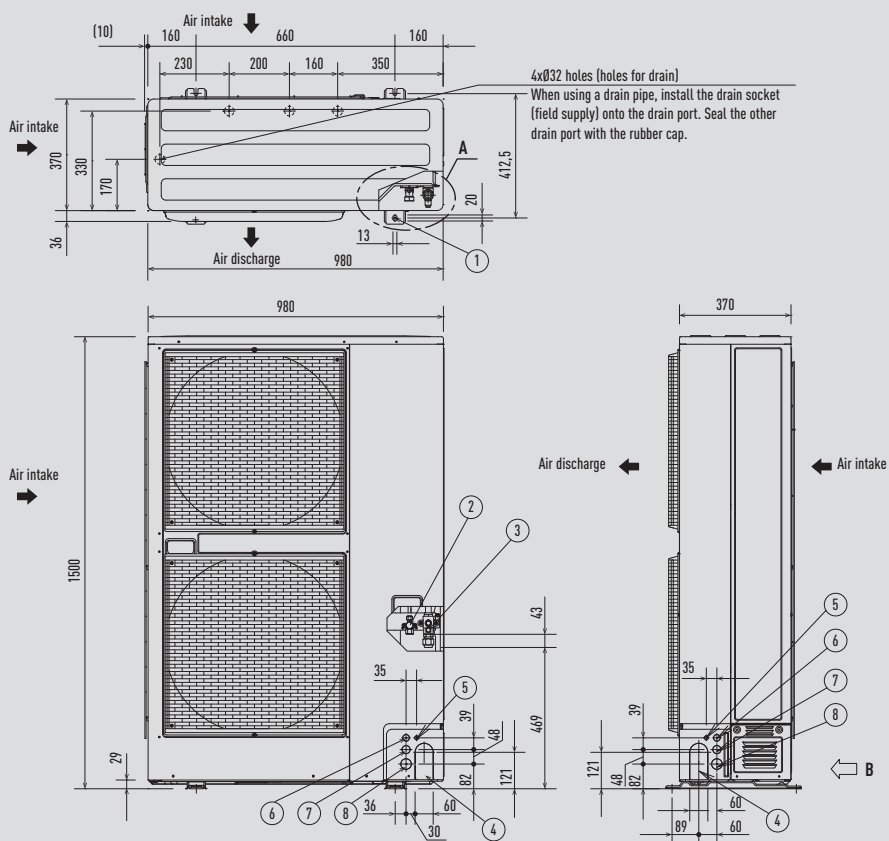

- 1 Mounting hole (4-R6,5), anchor bolt : M10
- 3 Refrigerant tubing (liquid), flared connection (Ø9,52 U-200 / Ø12,70 U-250)
- 6 Refrigerant tubing (gas), Ø15,88 (flared)
- 5 Refrigerant piping hole
- 4 Electrical wiring port (Ø13)
- 7 Electrical wiring port (Ø22)
- 2 Electrical wiring port (Ø27)
- 8 Electrical wiring port (Ø35)

Specification for pipe connecting indoor unit to outdoor unit.

Model name	U-200PE2E8A	U-250PE2E8A
Piping Connections		
Liquid side	Ø9,52	Ø12,70
Gas side	Ø25,40	Ø25,40

1) While the main gas side pipe is Ø25,40, since connecting the outdoor unit's 3-way valve requires a Ø19,05 flare, please be sure to use standard accessories joint piping B or A for connection (brazing), and connect as follows.

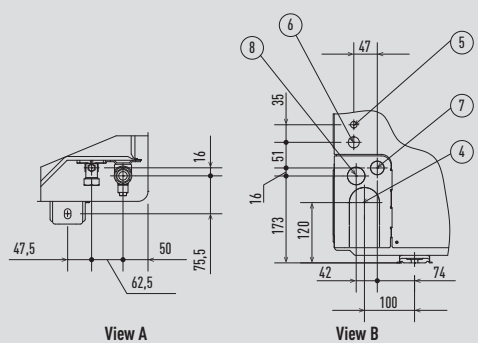

Unit: mm

### AHU Connection Kit

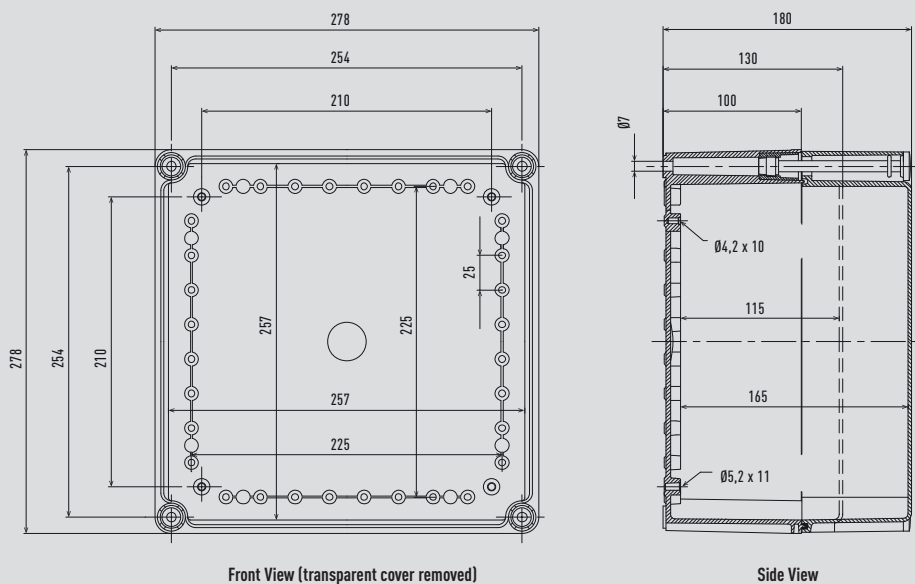

Unit: mm

## Air Curtain with DX Coil

Jet-flow dimensions

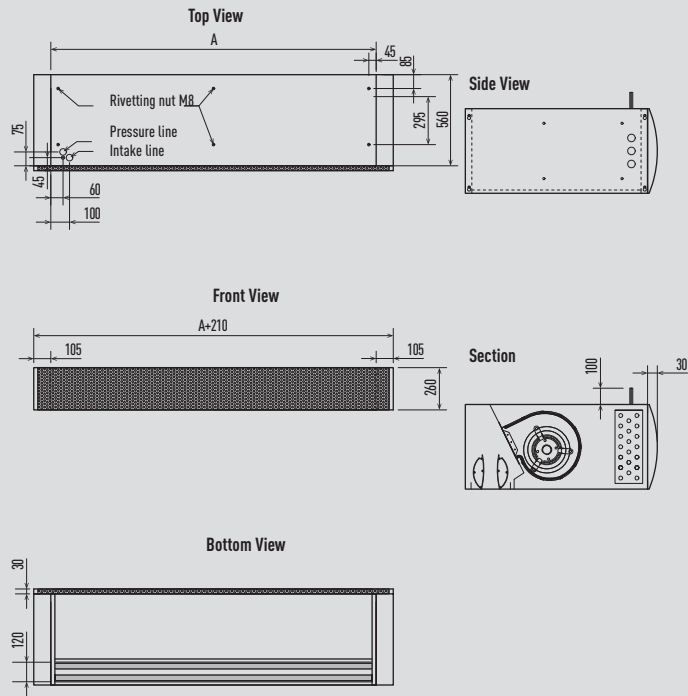

	PAW-10PAIRC-MJ	PAW-15PAIRC-MJ	PAW-20PAIRC-MJ
A	1000	1500	2000

Standard dimensions

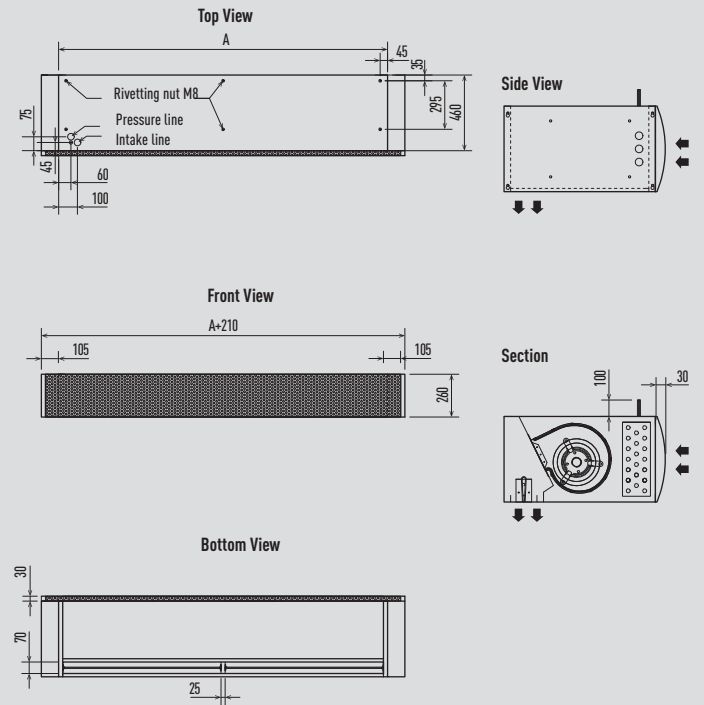

	PAW-10PAIRC-MS	PAW-20PAIRC-MS
A	1000	2000

Unit: mm

## Electric Air Curtain

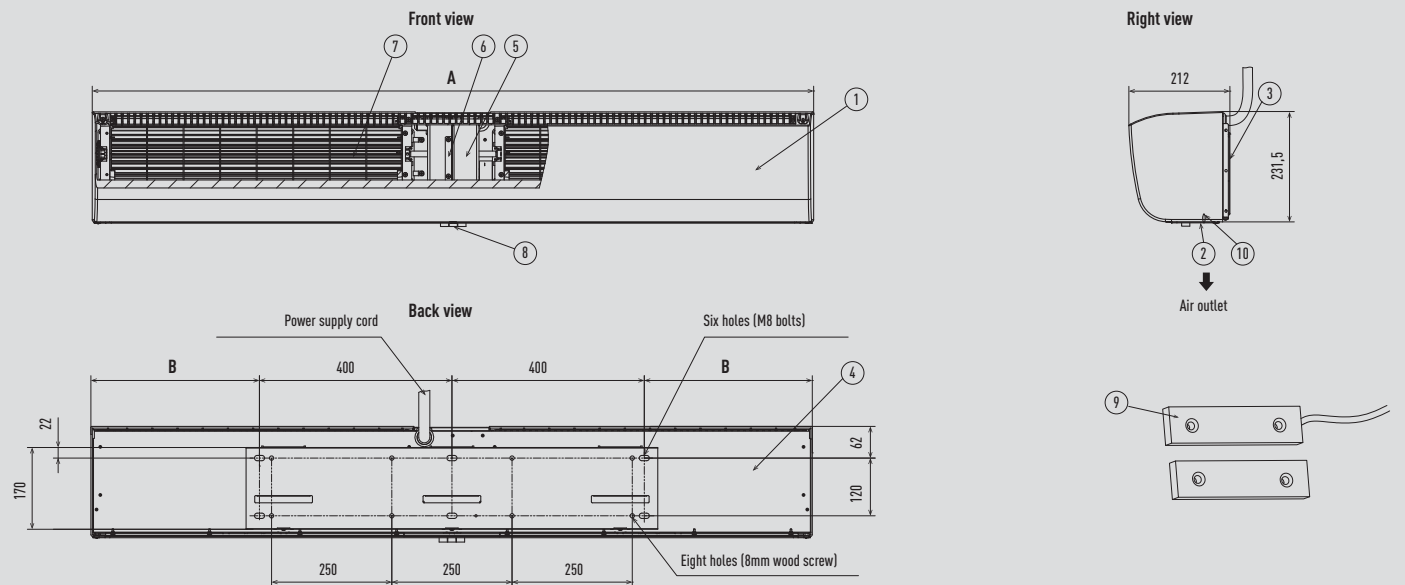

- 1 Front panel
- 2 Air outlet
- 3 Mounting plate
- 4 Back panel
- 5 Motor
- 6 Motor support
- 7 Cross-flow impeller
- 8 Push-button switch
- 9 Gate magnetic switch
- 10 Guide plate

	FY-3009U1	FY-3012U1	FY-3015U1
A	900	1200	1500
B	50	200	350

Unit: mm



### Mini ECOi LE2 Series High Efficiency 4 to 6HP

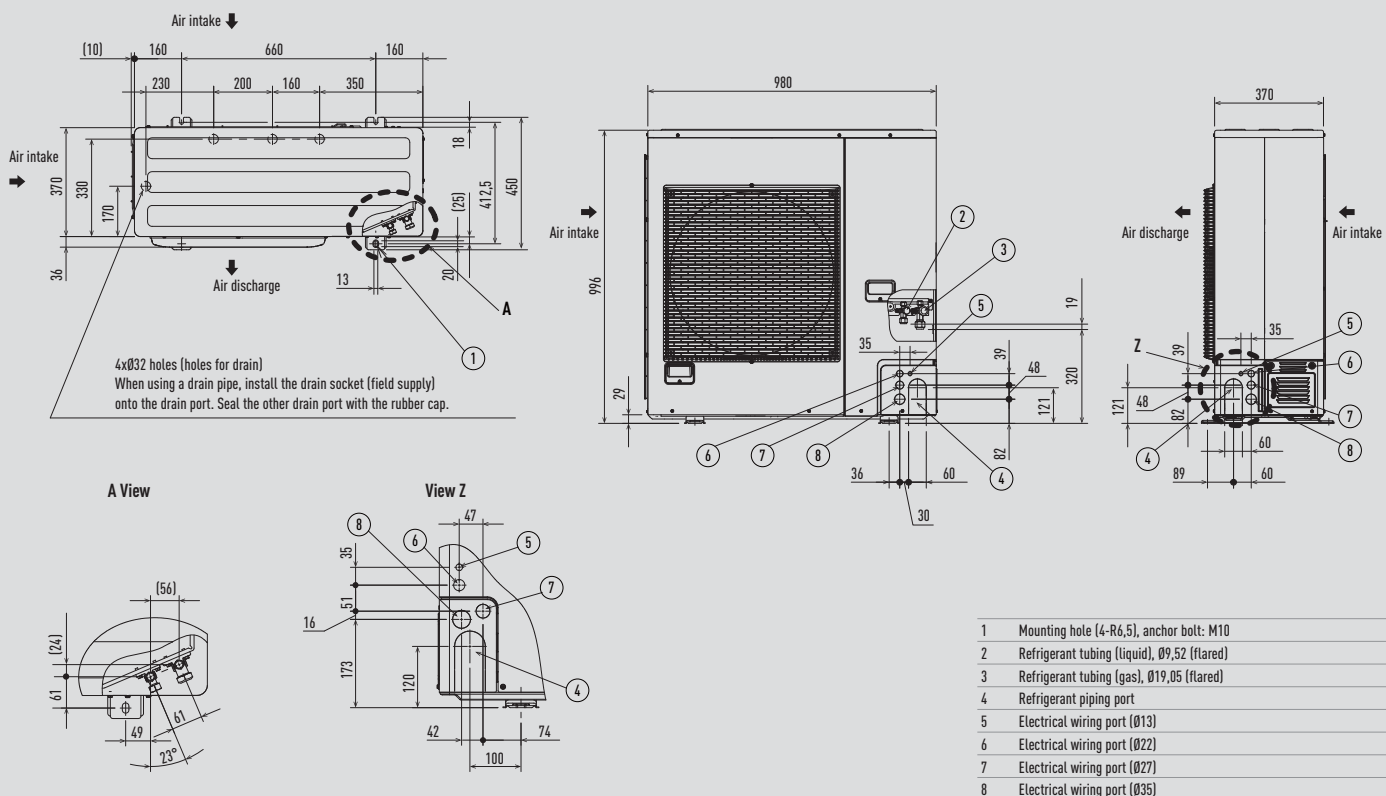

Unit: mm

### Mini ECOi LE1 Series High Efficiency 8 and 10HP

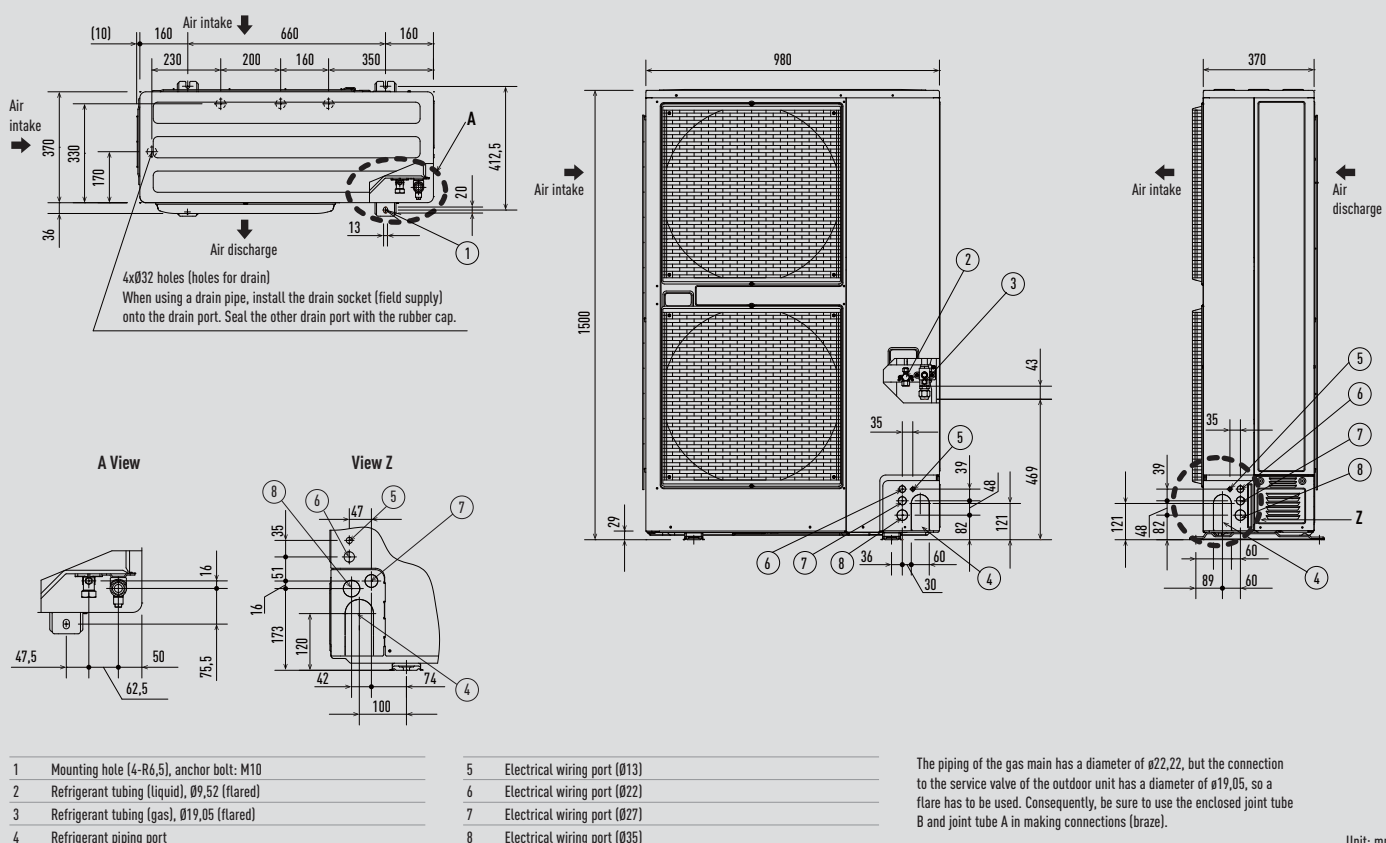

Unit: mm

2-Pipe ECOi EX ME2 Series 8 and 10HP

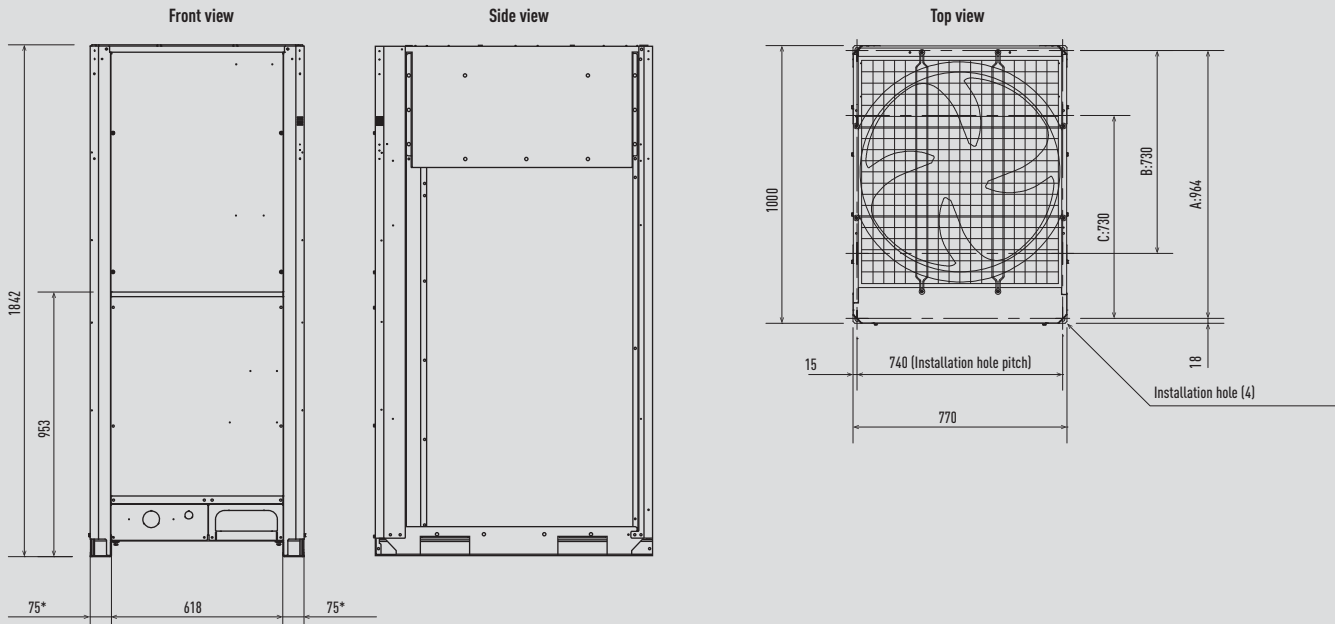

According to the installation site, you may choose the setting position in the depth direction of the anchor bolt from A, B or C.

- A: 964 (Installation hole pitch). The piping is routed out from the front.
- B: 730 (Installation hole pitch)\*. The piping is routed out from the bottom.
- C: 730 (Installation hole pitch).

\* Installation fixing bracket. Installation side.

Unit: mm

2-Pipe ECOi EX ME2 Series 12, 14 and 16HP / 3-Pipe ECOi EX MF3 Series 8-16HP

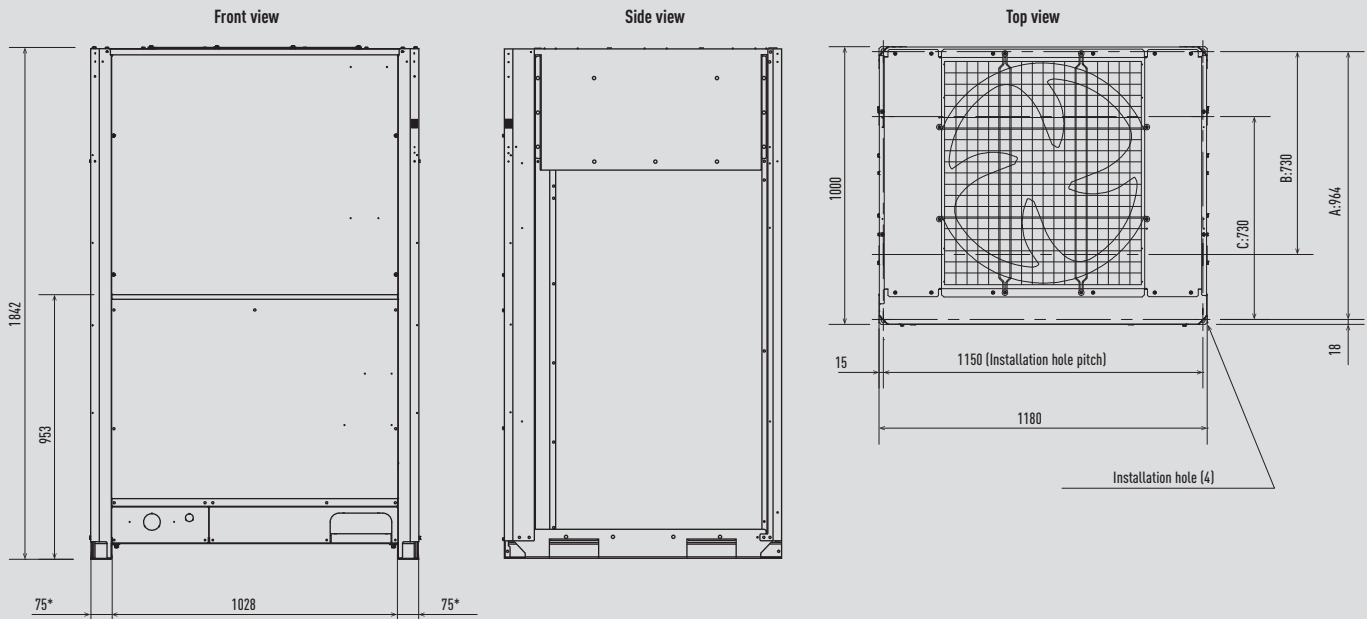

According to the installation site, you may choose the setting position in the depth direction of the anchor bolt from A, B or C.

- A: 964 (Installation hole pitch). The piping is routed out from the front.
- B: 730 (Installation hole pitch)\*. The piping is routed out from the bottom.
- C: 730 (Installation hole pitch).

\* Installation fixing bracket. Installation side.

Unit: mm

2-Pipe ECOi EX ME2 Series 18 and 20HP

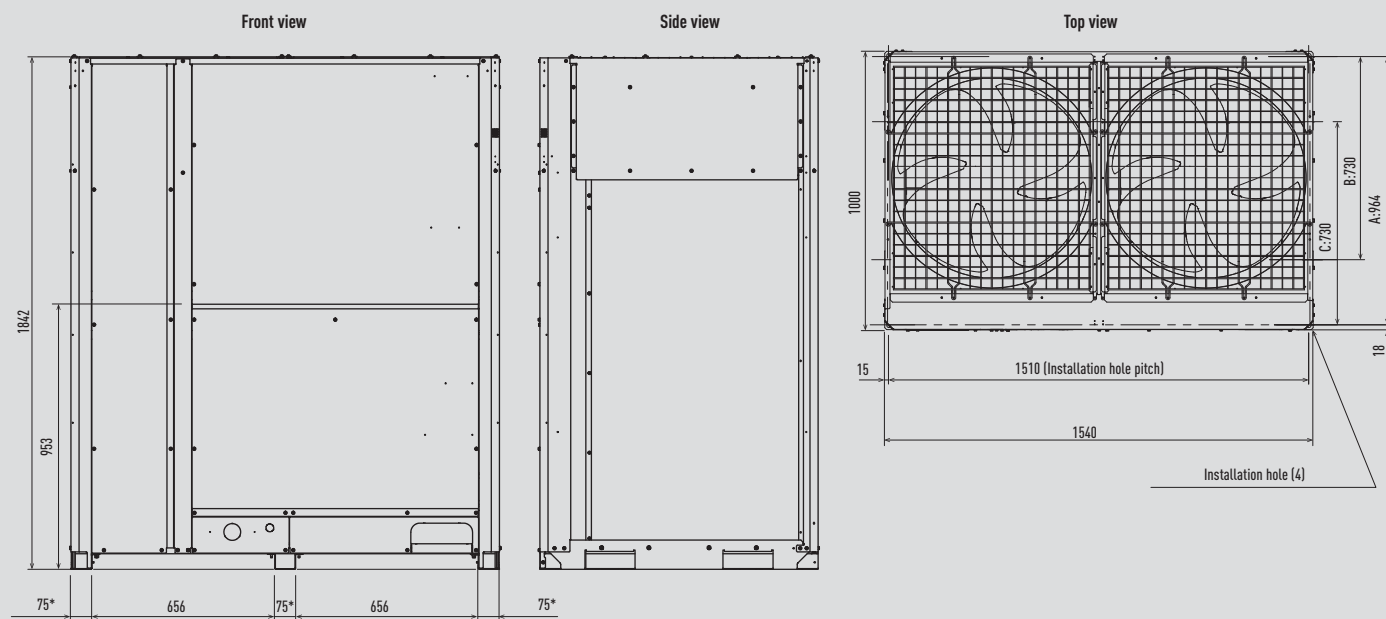

According to the installation site, you may choose the setting position in the depth direction of the anchor bolt from A, B or C.

- A: 964 (Installation hole pitch). The piping is routed out from the front.
- B: 730 (Installation hole pitch)\*. The piping is routed out from the bottom.
- C: 730 (Installation hole pitch).

\* Installation fixing bracket. Installation side.

Unit: mm

ECO G GE3 Series 16 and 20HP

Type	16HP	20HP	
1 Refrigerant tubing (gas)		Ø28,58	9 Engine exhaust outlet
2 Refrigerant tubing (liquid)	Ø12,70	Ø15,88	10 Suspension holes 4-Ø20x30
3 Exhaust gas drain port	Hose outer diameter: Ø25 (accessory)		11 Anchor holes 4-22x30
4 Electrical power supply port	Ø28		12 Segmented display
5 Inter-unit cable port	Ø28		13 Coolant intake (top)
6 Fuel gas port	R3/4		14 Air intake
7 Condensation drain opening	Ø20		15 Coolant level
8 Rain and condensation outlet			16 Hot water inlet Rp3/4
			17 Hot water outlet Rp3/4

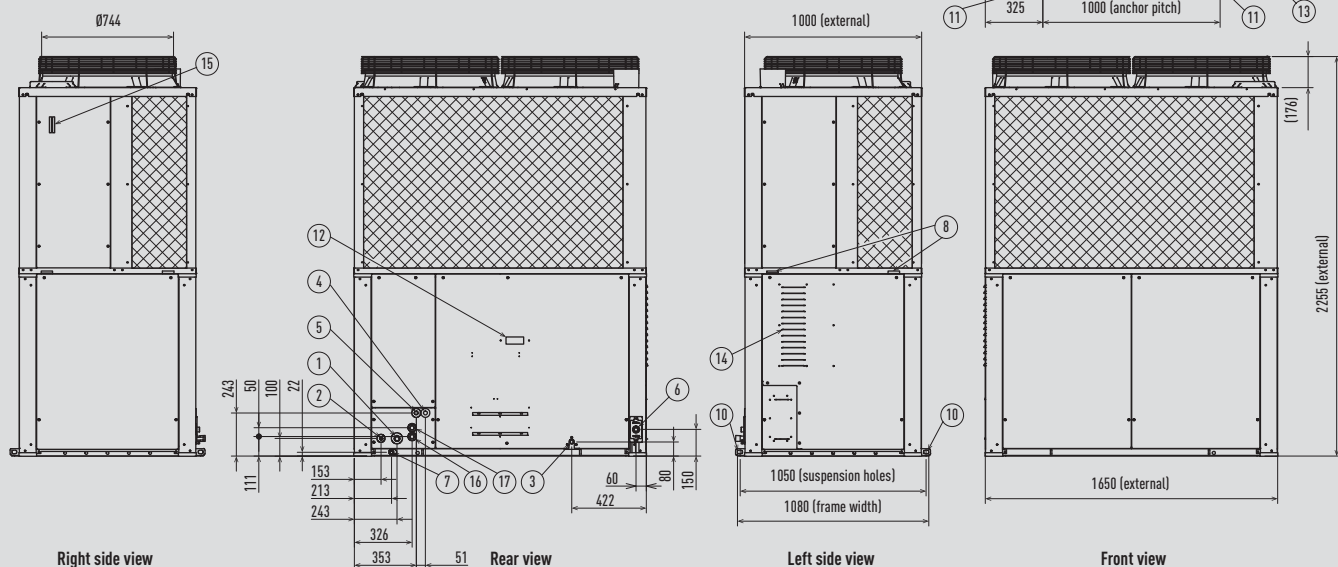

Unit: mm

ECO G GE3 Series 25 and 30HP

Type	25HP	30HP
1 Refrigerant tubing (gas)	Ø28,58	Ø31,75
2 Refrigerant tubing (liquid)	Ø15,88	Ø19,05
3 Exhaust gas drain port	Hose outer diameter: Ø25 (accessory)	
4 Electrical power supply port	Ø28	
5 Inter-unit cable port	Ø28	
6 Fuel gas port	R3/4	
7 Condensation drain opening	Ø20	
8 Rain and condensation outlet		

9 Engine exhaust outlet	
10 Suspension holes 4-Ø20x30	
11 Anchor holes 4-22x30	
12 Segmented display	
13 Coolant intake (top)	
14 Air intake	
15 Coolant level	
16 Hot water inlet	Rp3/4
17 Hot water outlet	Rp3/4

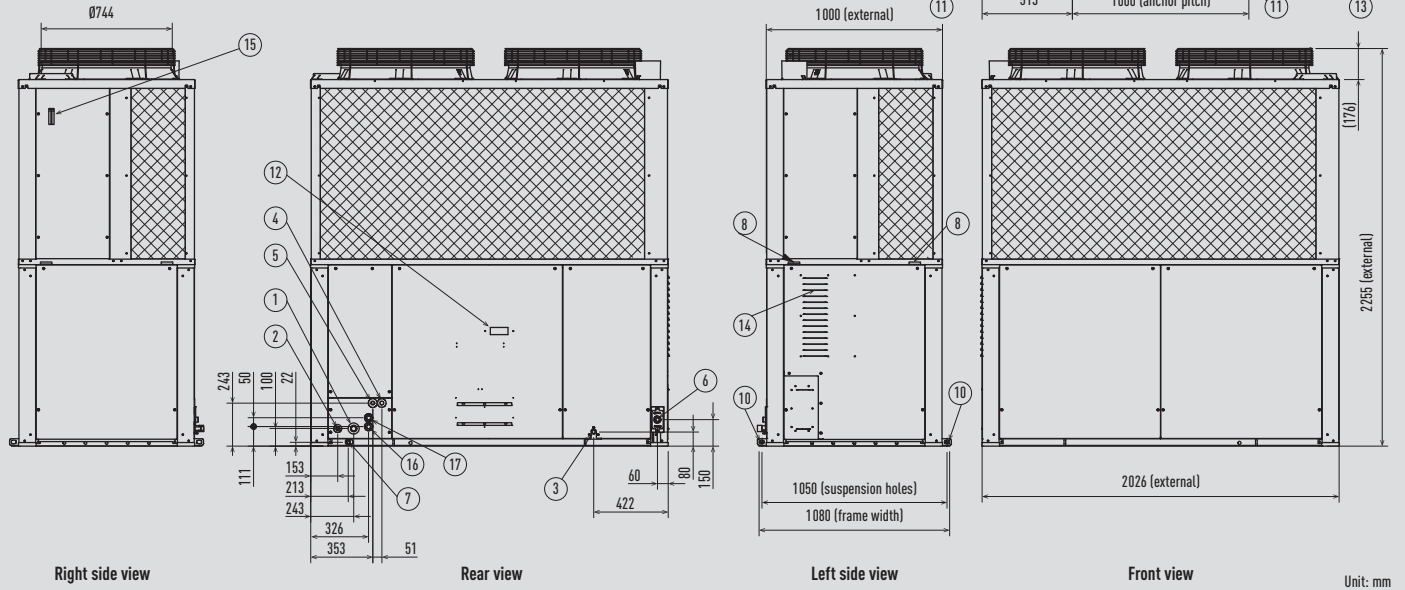

ECO G GF3 Series 16 and 20HP

Type	16HP	20HP
1 Suction refrigerant tubing (gas)	Ø28,58	
2 Discharge refrigerant tubing (gas)	Ø22,22	Ø25,40
3 Refrigerant tubing (liquid)	Ø19,05	
4 Exhaust gas drain port	Hose outer diameter: Ø25 (accessory)	
5 Electrical power supply port	Ø28	
6 Inter-unit cable port	Ø28	
7 Fuel gas port	R3/4	
8 Condensation drain opening	Ø20	

9 Rain and condensation outlet	
10 Engine exhaust outlet	
11 Suspension holes 4-Ø20x30	
12 Anchor holes 4-22x30	
13 Segmented display	
14 Coolant intake (top)	
15 Air intake	
16 Coolant level	
17 Hot water inlet	Rp3/4
18 Hot water outlet	Rp3/4

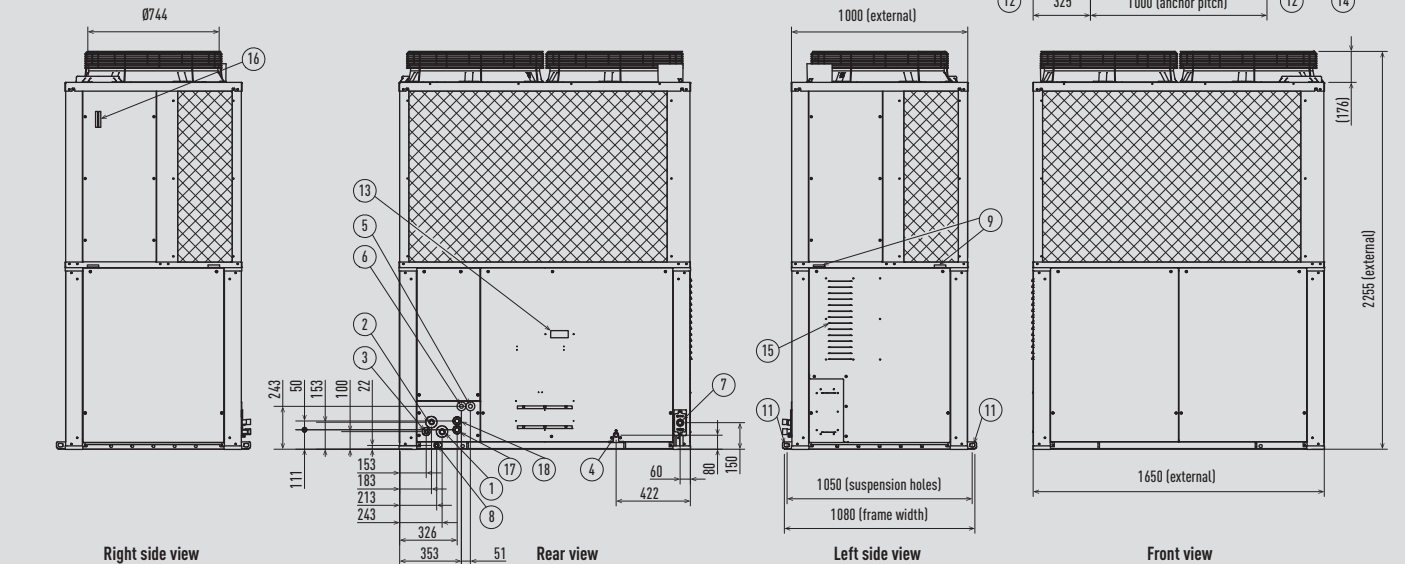

ECO G GF3 Series 25HP

1	Suction Refrigerant tubing (gas)	Ø28,58	10	Engine exhaust outlet	
2	Discharge Refrigerant tubing (gas)	Ø25,40	11	Suspension holes 4-Ø20x30	
3	Refrigerant tubing (liquid)	Ø19,05	12	Anchor holes 4-22x30	
4	Exhaust gas drain port	Hose outer diameter: Ø25 (accessory)	13	Segmented display	
5	Electrical power supply port	Ø28	14	Coolant intake (top)	
6	Inter-unit cable port	Ø28	15	Air intake	
7	Fuel gas port	R3/4	16	Coolant level	
8	Condensation drain opening	Ø20	17	Hot water inlet	Rp3/4
9	Rain and condensation outlet		18	Hot water outlet	Rp3/4

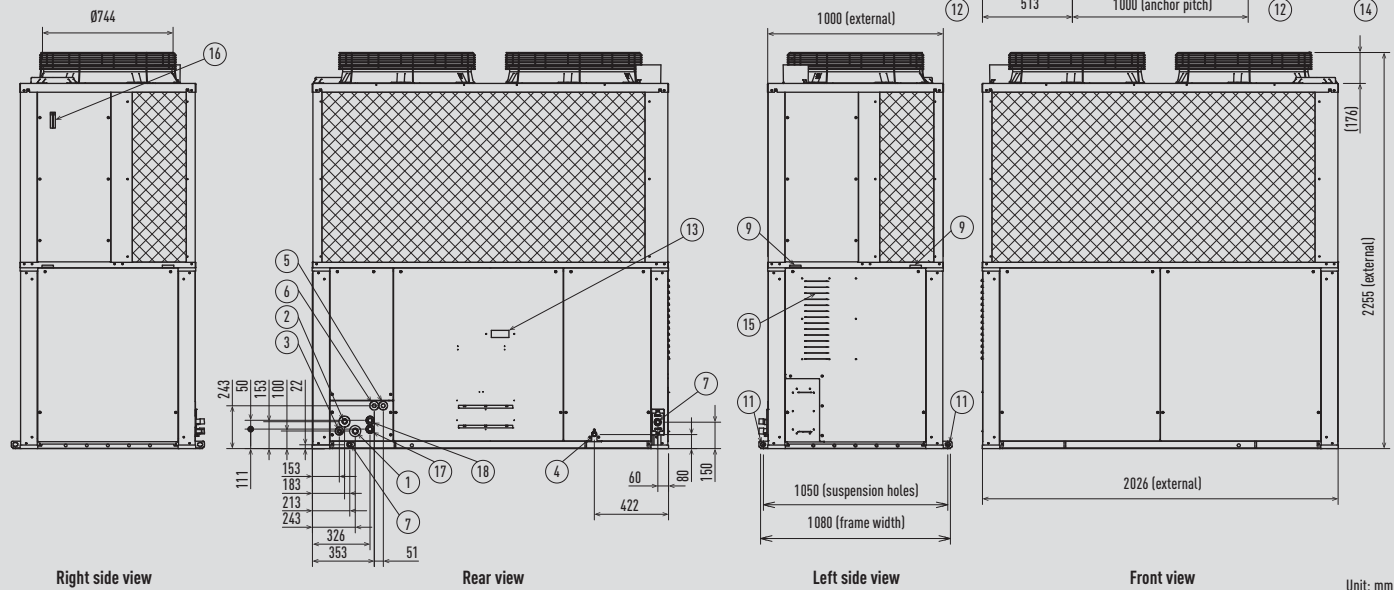

3-Pipe Control Box Kit / Multiple connection type

Heat Recovery Box Dimensions

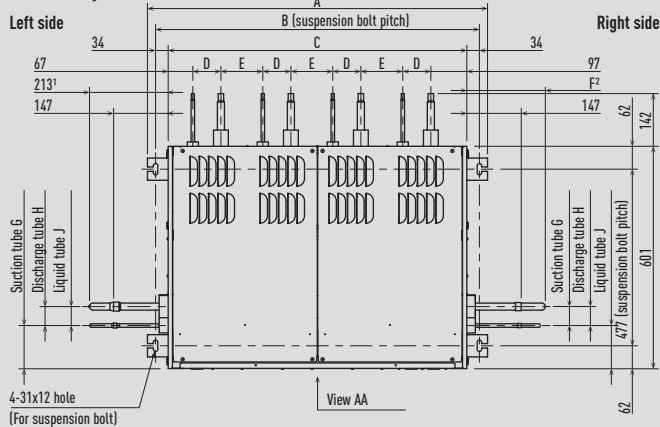

- 1) In case of right side connection.
- 2) Including the protection tubes when connecting to the left side.

Valve Dimensions

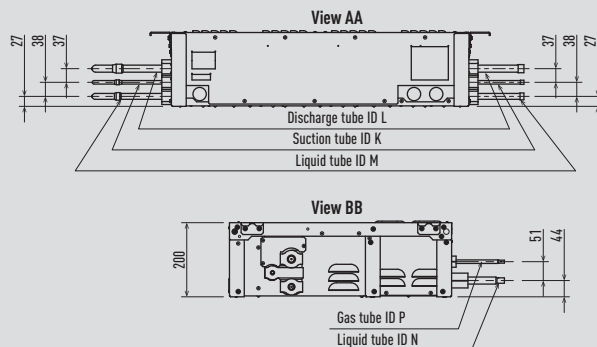
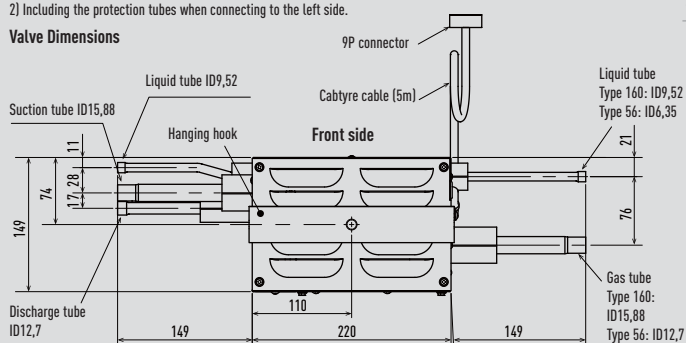

	A	B	C	D	E	F	G	H	J	K	L	M	N	P
Type 456	919	874	807	67	113	213	51	51	117	Ø19,05	Ø15,88	Ø9,52	Ø6,35	Ø12,70
Type 4160	919	874	807	67	113	207	55	54	113	Ø9,52	Ø15,88	Ø28,58	Ø25,40	Ø15,88
Type 656	1297	1253	1185	67	113	213	54	56	115	Ø25,40	Ø19,05	Ø12,70	Ø6,35	Ø12,70
Type 856	1675	1631	1563	67	113	213	53	53	115	Ø28,58	Ø22,22	Ø12,70	Ø6,35	Ø12,70

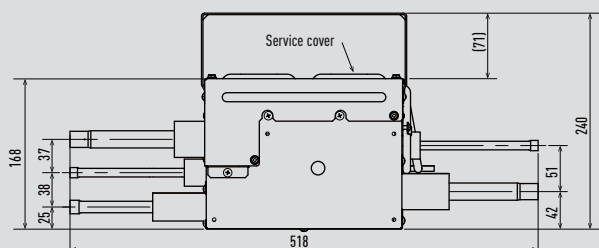

Unit: mm

## Water Heat Exchanger for chilled and hot water production

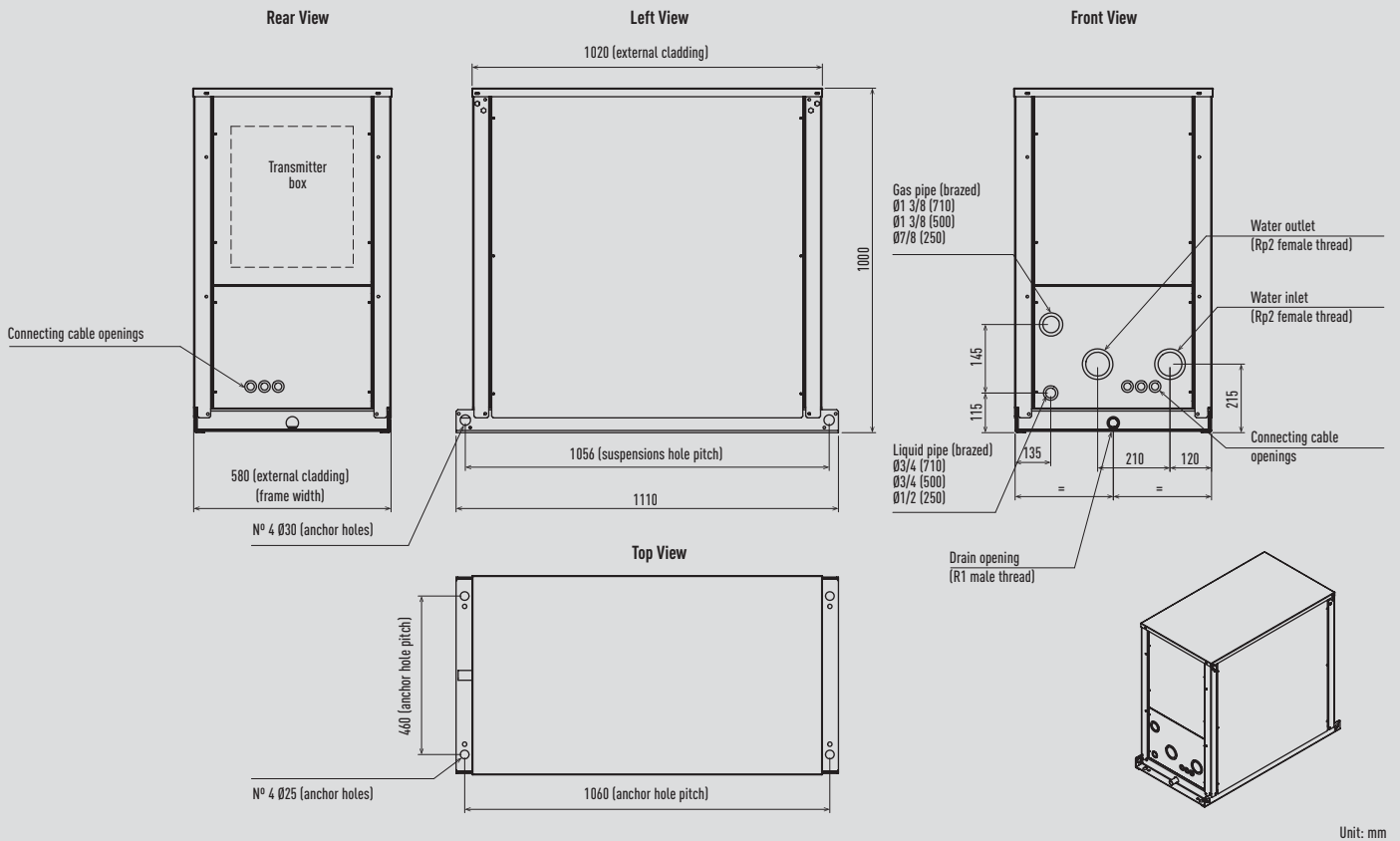

## Y2 Type 4 Way 60x60 Cassette

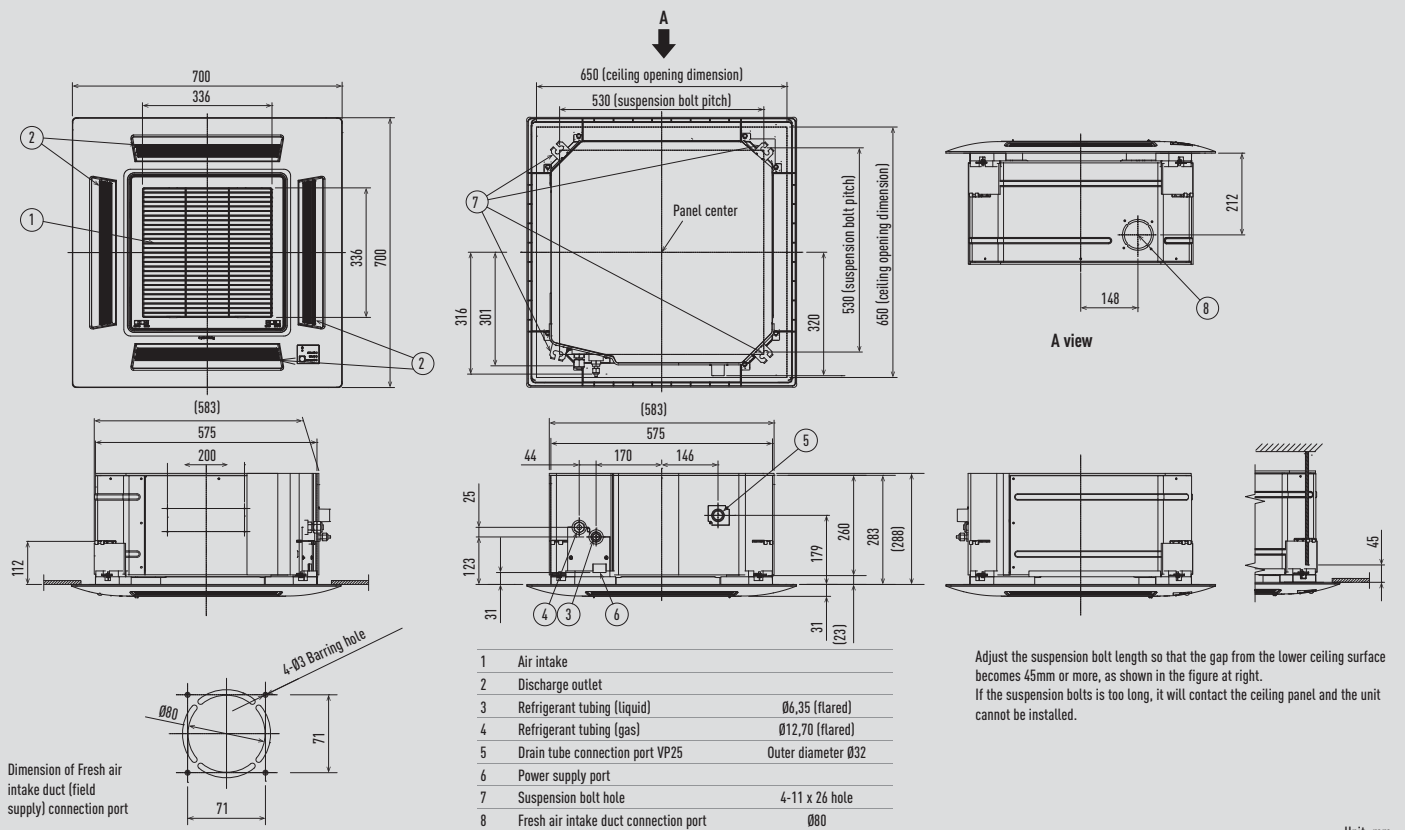

U2 Type 4 Way 90x90 Cassette

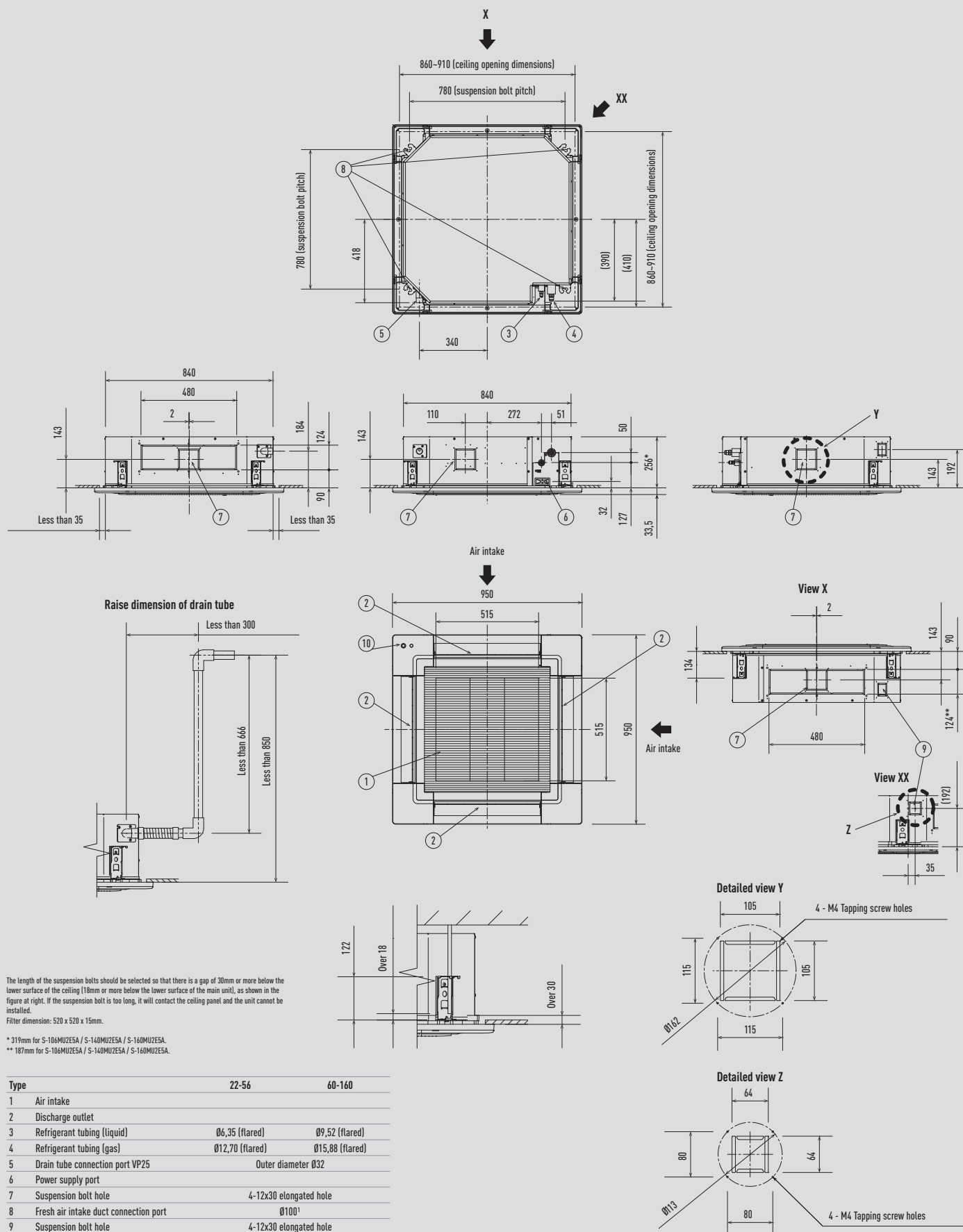

Raise dimension of drain tube

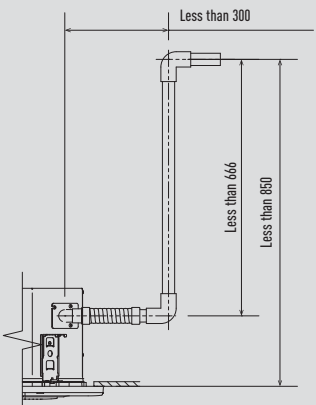

The length of the suspension bolts should be selected so that there is a gap of 30mm or more below the lower surface of the ceiling (18mm or more below the lower surface of the main unit), as shown in the figure at right. If the suspension bolt is too long, it will contact the ceiling panel and the unit cannot be installed.

Filter dimension: 520 x 520 x 15mm.

\* 319mm for S-106MUZESA / S-140MUZESA / S-160MUZESA.

\*\* 187mm for S-106MUZESA / S-140MUZESA / S-160MUZESA.

Type	22-56	60-160
1 Air intake		
2 Discharge outlet		
3 Refrigerant tubing (liquid)	Ø6,35 (flared)	Ø9,52 (flared)
4 Refrigerant tubing (gas)	Ø12,70 (flared)	Ø15,88 (flared)
5 Drain tube connection port VP25	Outer diameter Ø32	
6 Power supply port		
7 Suspension bolt hole	4-12x30 elongated hole	
8 Fresh air intake duct connection port	Ø100 <sup>†</sup>	
9 Suspension bolt hole	4-12x30 elongated hole	
10 Econavi sensor (Only CZ-KPU3A)		

†) Necessary to attach duct connecting flange(field supplied).

Unit: mm

### L1 Type 2 Way Cassette

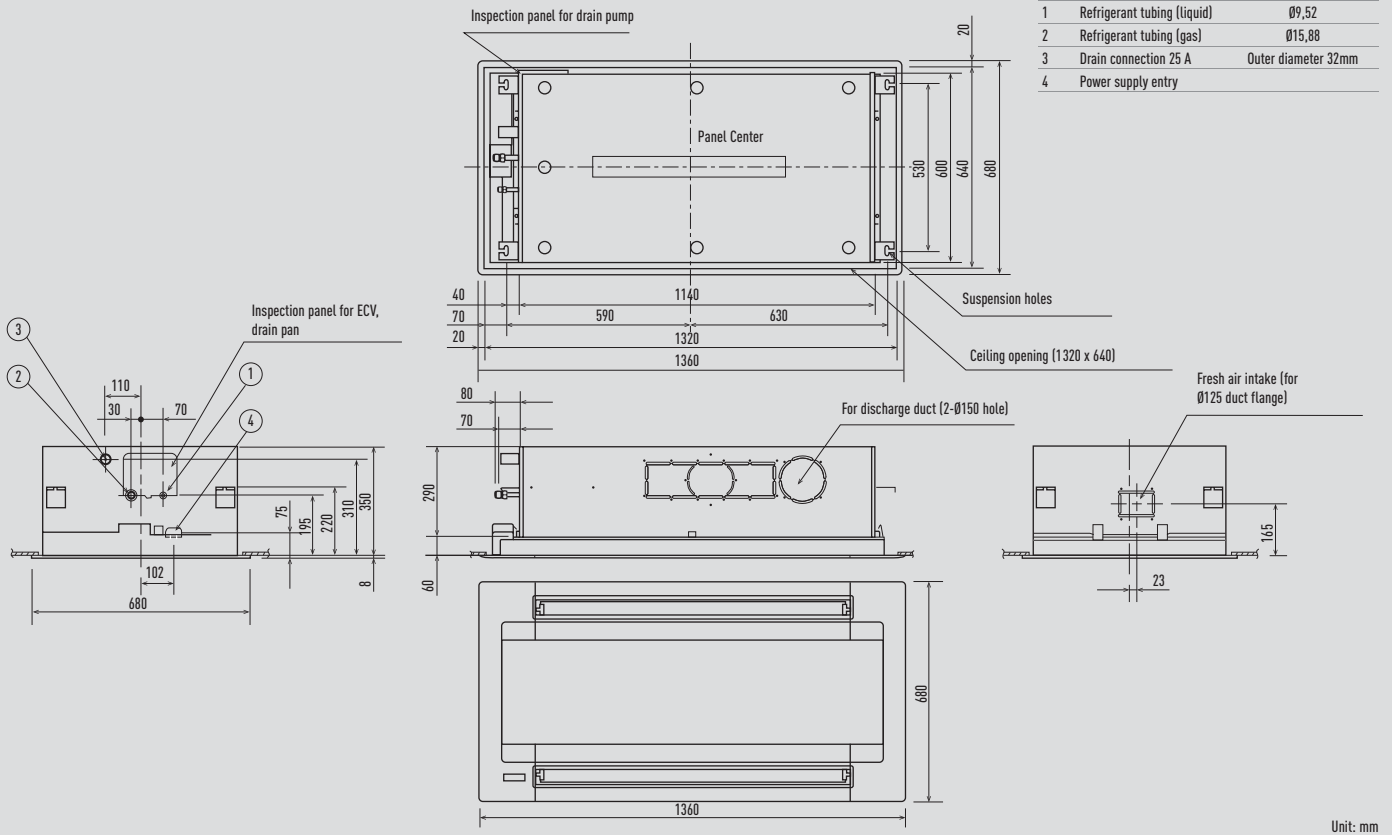

Unit: mm

### D1 Type 1 Way Cassette

	28-56	73
1	Air intake grille	
2	Discharge outlet	
3	Refrigerant tubing (liquid)	Ø6,35 (flared) Ø9,52 (flared)
4	Refrigerant tubing (gas)	Ø12,70 (flared) Ø15,88 (flared)
5	Drain tube connection port VP25	Outer diameter 32
6	Power supply entry	
7	Discharge duct connection port (for descending ceiling)	
8	Fresh air intake duct connection port	Ø100
9	Installation port for wireless remote controller receiver	
10	Suspension bolt hole	4-12 x 30mm

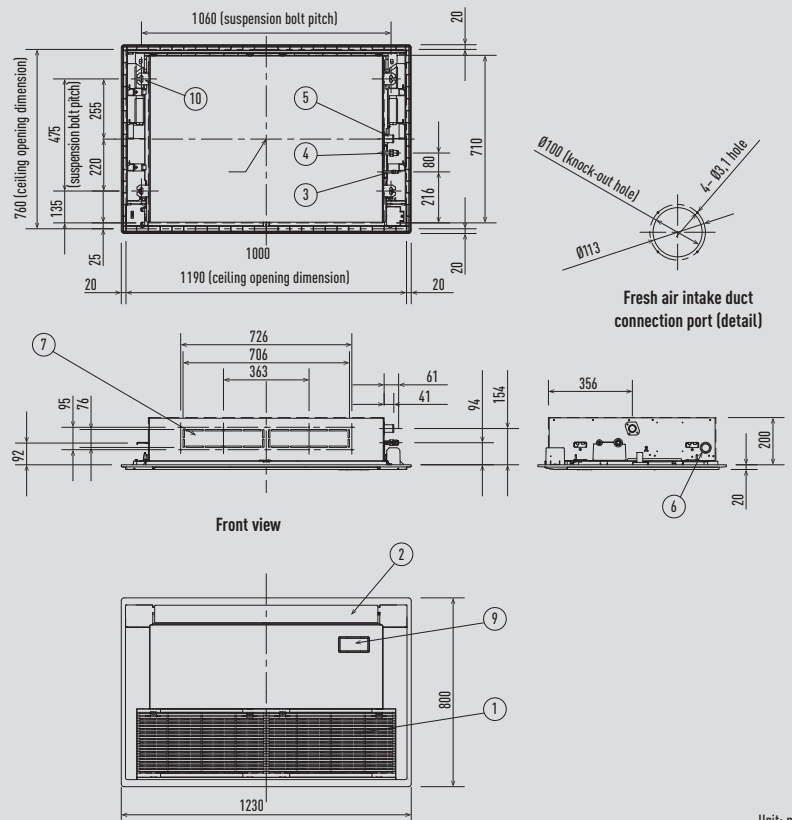

Required space for installation

Front view

Unit: mm



### M1 Type Slim Variable Static Pressure Hide Away

1	Refrigerant piping (narrow tube)	
2	Refrigerant piping (wide tube)	
3	Upper and bottom drain port	Outer diameter 26mm
4	Suspension lug	
5	Power supply outlet	2- Ø30
6	Flange for air intake duct	
7	PL cover	
8	Electrical component box	
9	Frame filter	
10	Signal output board	ACC-SG-AGB: optional

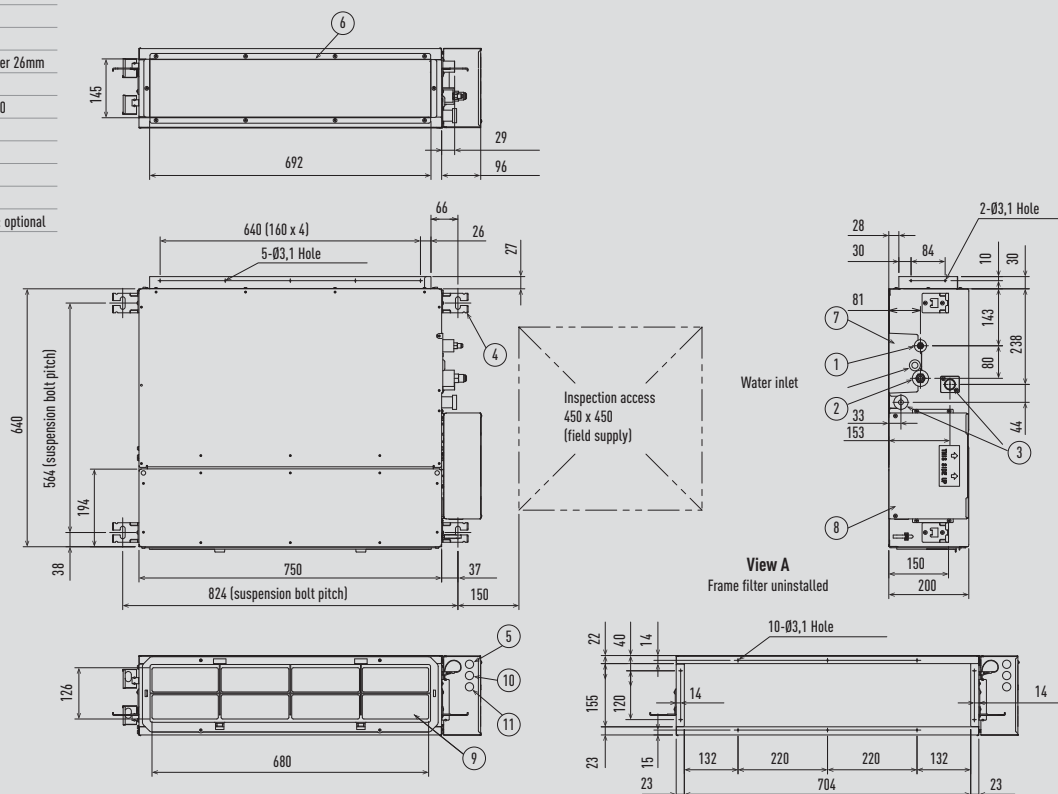

Unit: mm

### F2 Type Variable Static Pressure Hide Away

S-15MF2E5A / S-22MF2E5A / S-28MF2E5A / S-36MF2E5A / S-45MF2E5A / S-56MF2E5A

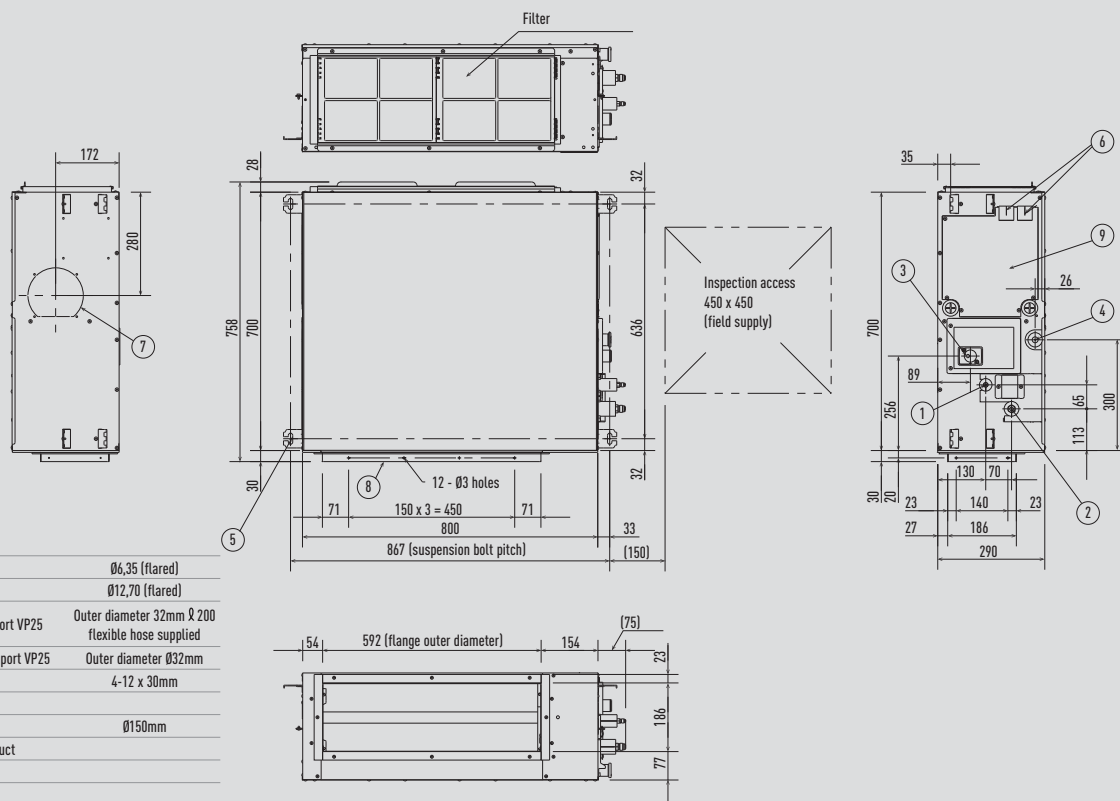

1	Refrigerant tubing (liquid)	Ø6,35 (flared)
2	Refrigerant tubing (gas)	Ø12,70 (flared)
3	Upper drain tube connection port VP25	Outer diameter 32mm Ø 200 flexible hose supplied
4	Bottom drain tube connection port VP25	Outer diameter Ø32mm
5	Suspension lug	4-12 x 30mm
6	Power supply outlet	
7	Fresh air intake port	Ø150mm
8	Flange for flexible air outlet duct	
9	Electrical component box	

Unit: mm

## F2 Type Variable Static Pressure Hide Away

S-60MF2E5A / S-73MF2E5A / S-90MF2E5A

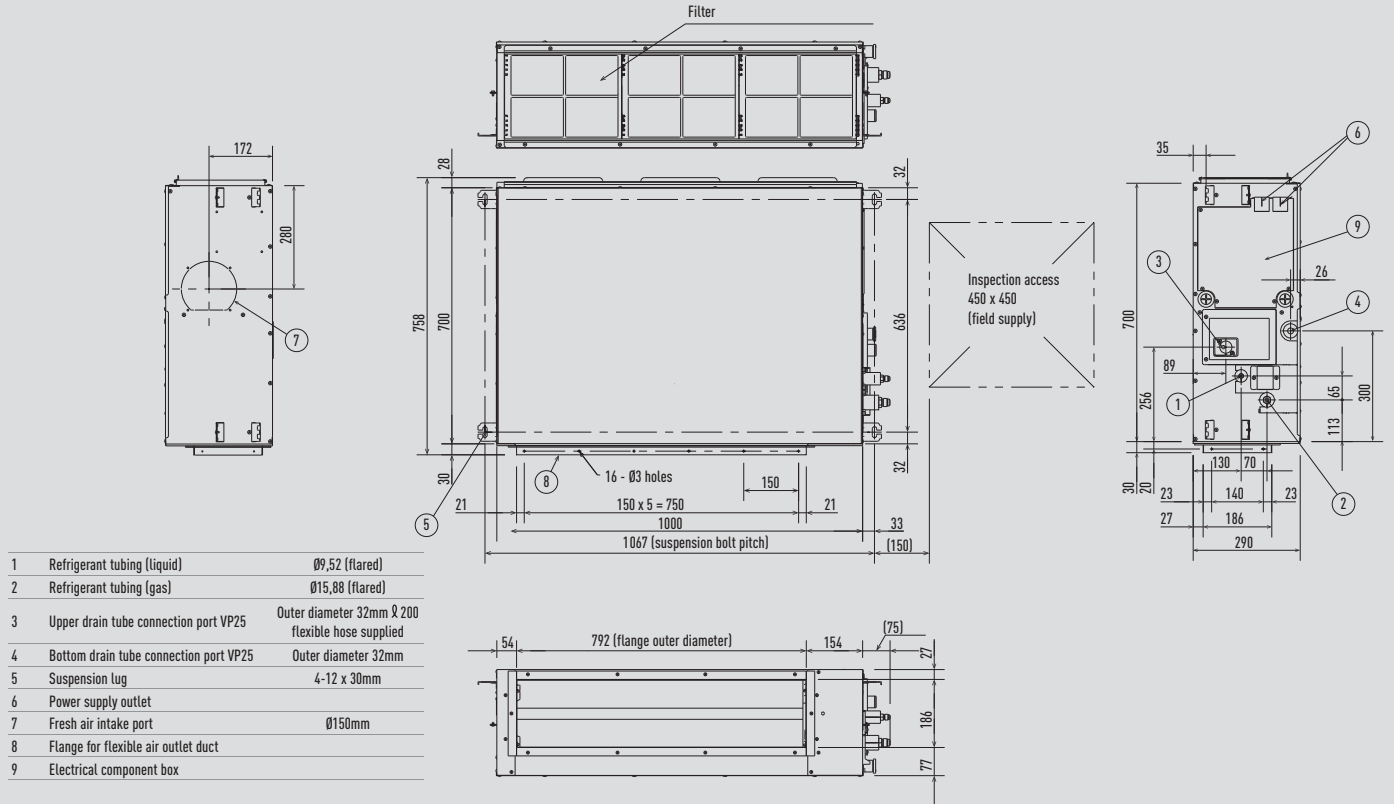

S-106MF2E5A / S-140MF2E5A / S-160MF2E5A

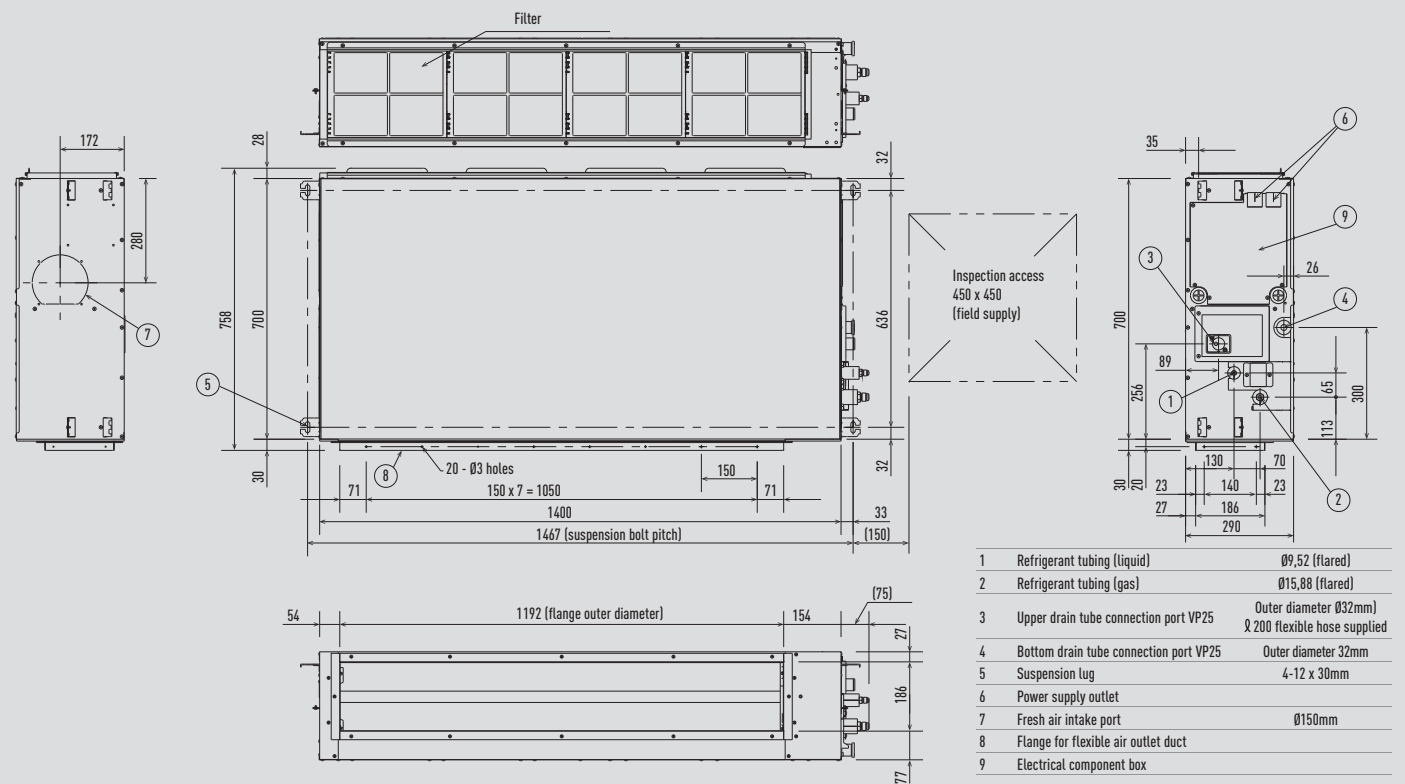

Unit: mm

### E2 Type High Static Pressure Hide Away

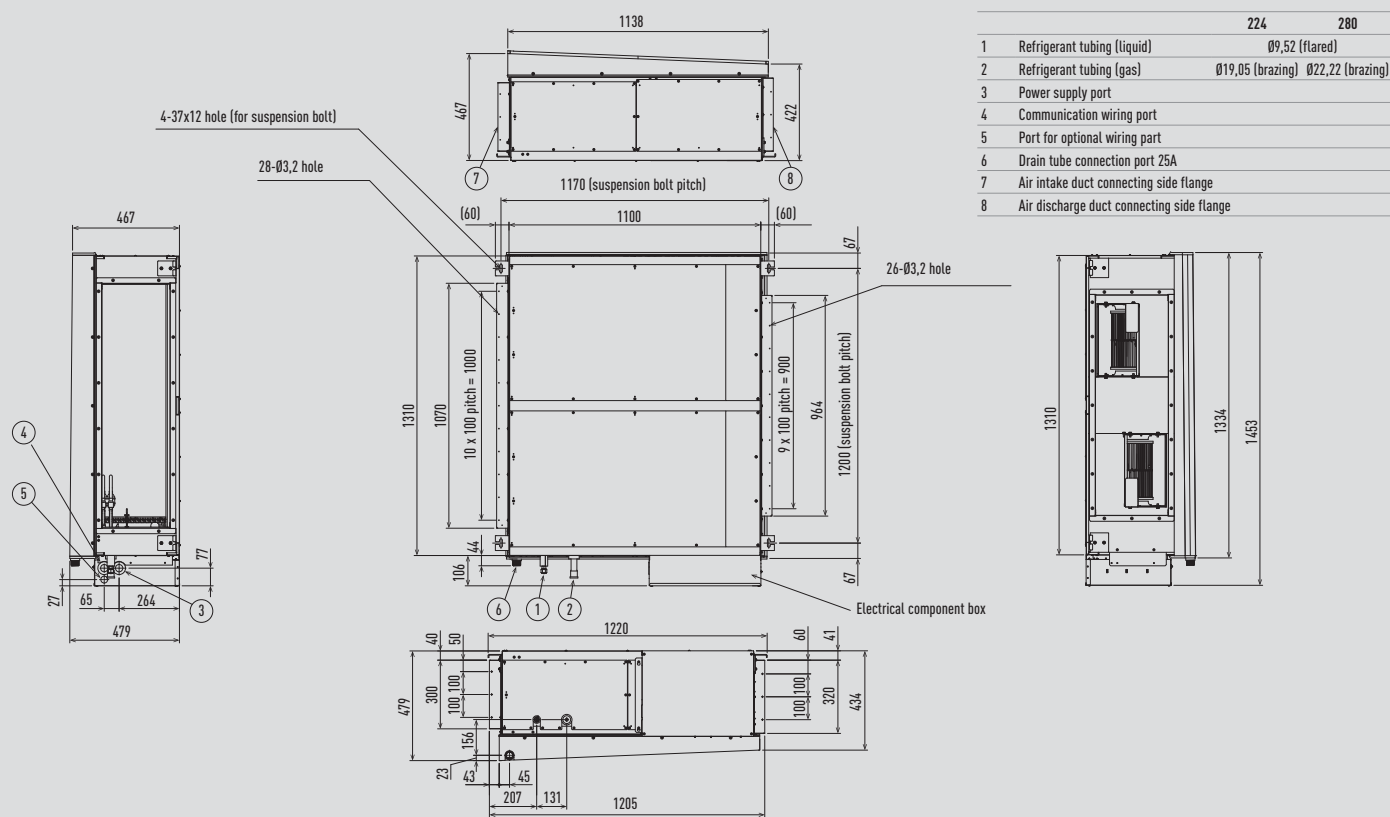

	224	280
1	Refrigerant tubing (liquid)	Ø9,52 (flared)
2	Refrigerant tubing (gas)	Ø19,05 (brazing) Ø22,22 (brazing)
3	Power supply port	
4	Communication wiring port	
5	Port for optional wiring part	
6	Drain tube connection port 25A	
7	Air intake duct connecting side flange	
8	Air discharge duct connecting side flange	

Unit: mm

### P1 Type Floor Standing

- 1 4-Ø12 hole (for fastening the indoor unit to the floor with screws)
- 2 Air filter
- 3 Refrigerant tubing (liquid)
- 4 Refrigerant tubing (gas)
- 5 Level adjusting bolt
- 6 Drain tube connection port (20 A)
- 7 Power cord outlet (downward, rear)
- 8 Refrigerant piping outlet (downward, rear)
- 9 Location for mounting the remote controller (remote controller can be attached within the room)

	A	B	C	Liquid pipes	Gas pipes
22-36	1065	665	632		
45				Ø6,35	Ø12,70
56	1380	980	947		
71				Ø9,52	Ø15,88

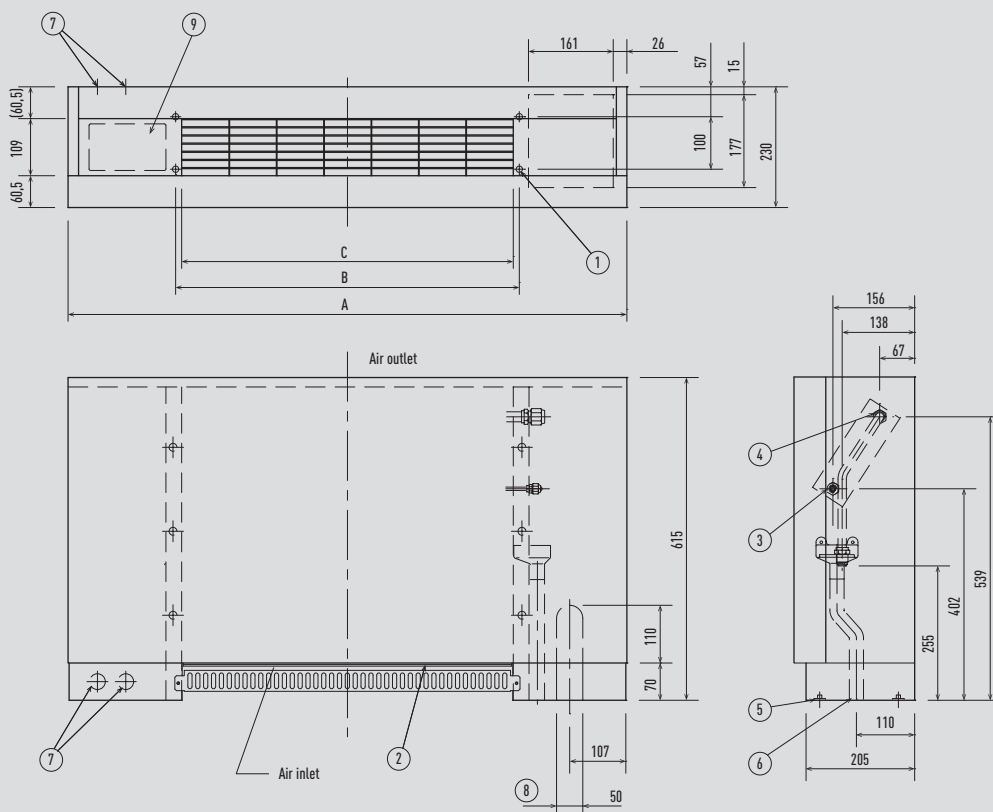

Unit: mm

## T2 Type Ceiling

S-36MT2E5A / S-45MT2E5A / S-56MT2E5A

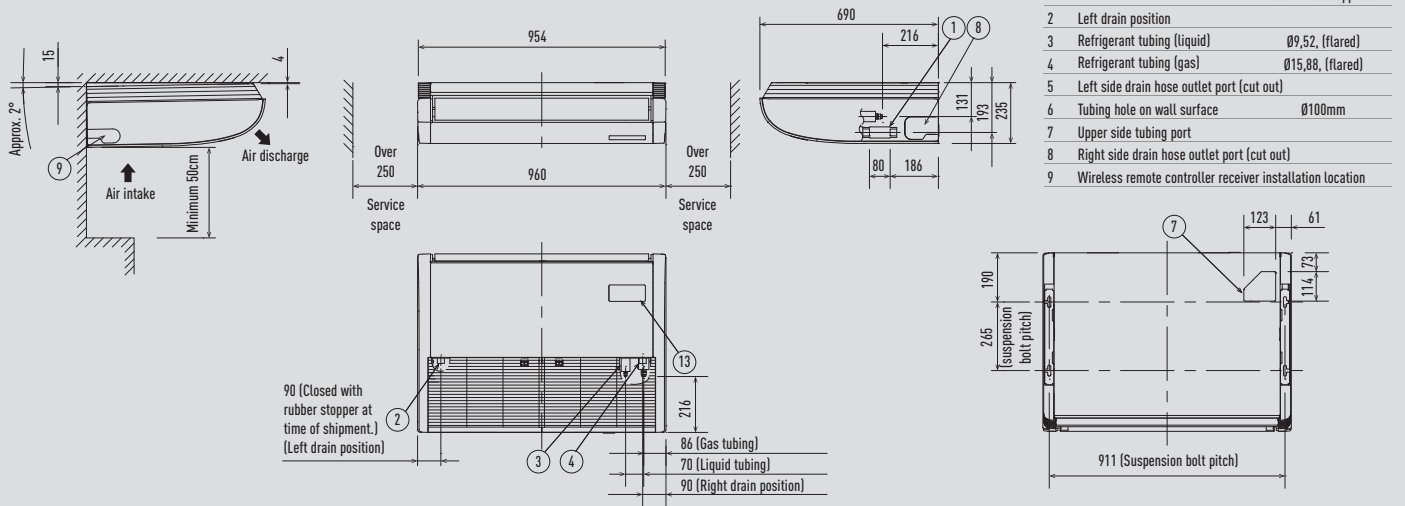

S-73MT2E5A

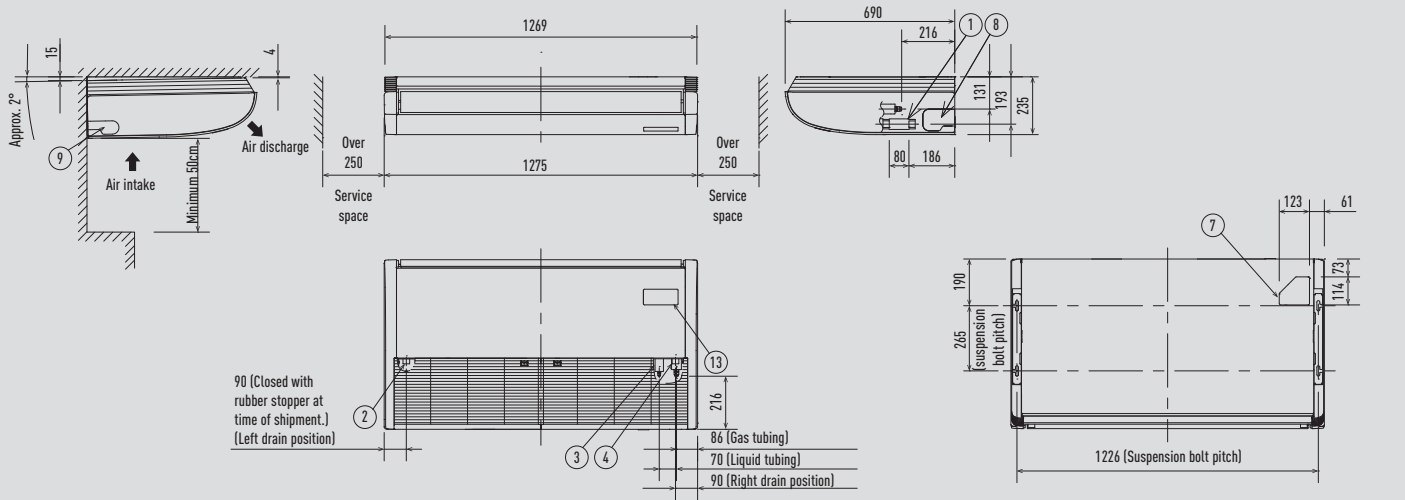

S-106MT2E5A / S-140MT2E5A

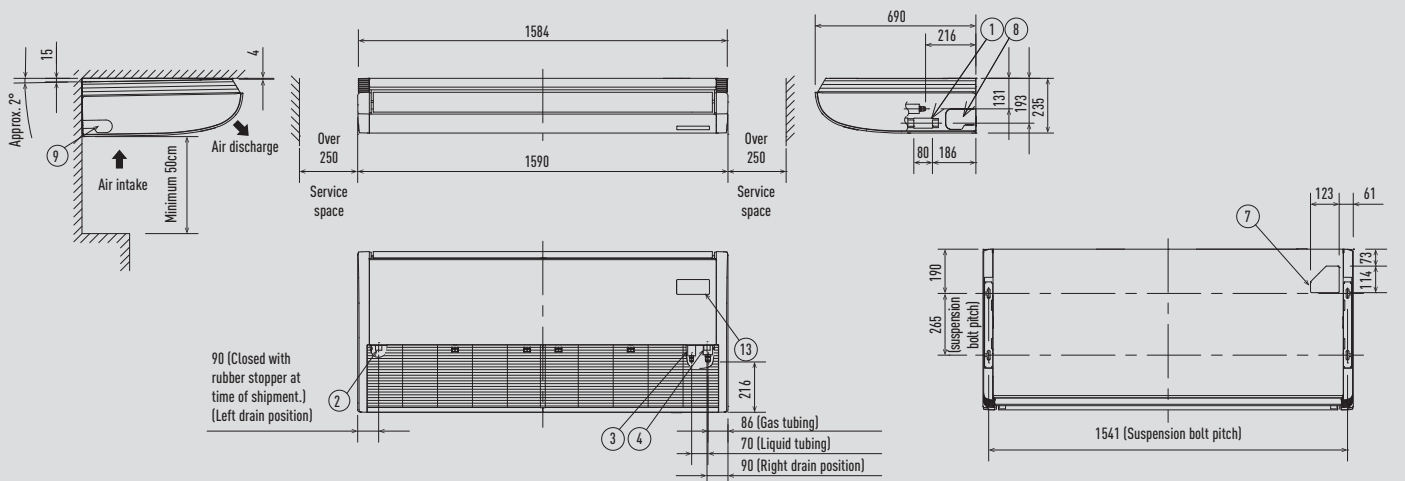

### K2 Type Wall Mounted

S-15MK2E5A / S-22MK2E5A / S-28MK2E5A / S-36MK2E5A

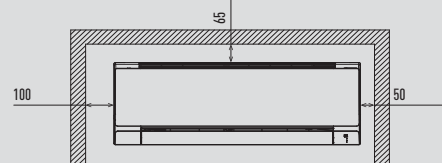
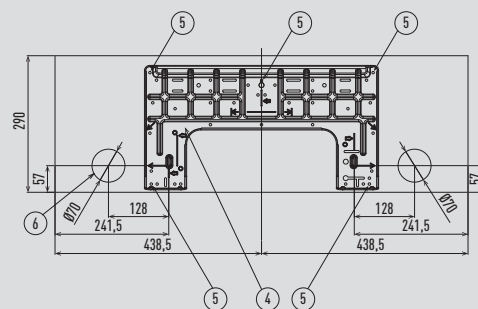
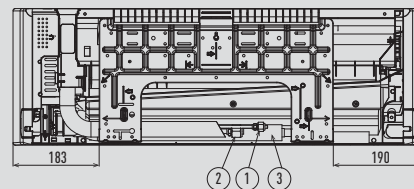
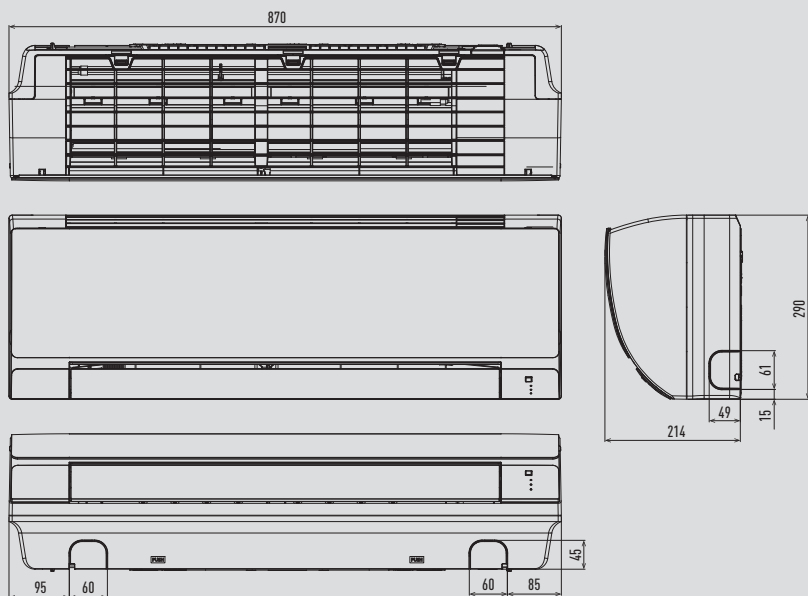

1	Refrigerant tubing (liquid)	Ø6,35 (flared)
2	Drain hose	Outer diameter 16mm
3	Rear panel	PL Back
4	Refrigerant tubing (gas)	Ø12,70 (flared)
5	Rear panel fixing holes	
6	Piping and wiring holes	Ø70

S-45MK2E5A / S-56MK2E5A / S-73MK2E5A / S-106MK2E5A

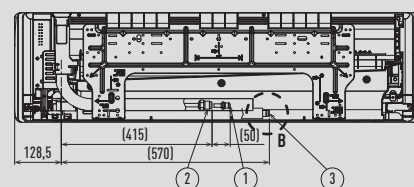
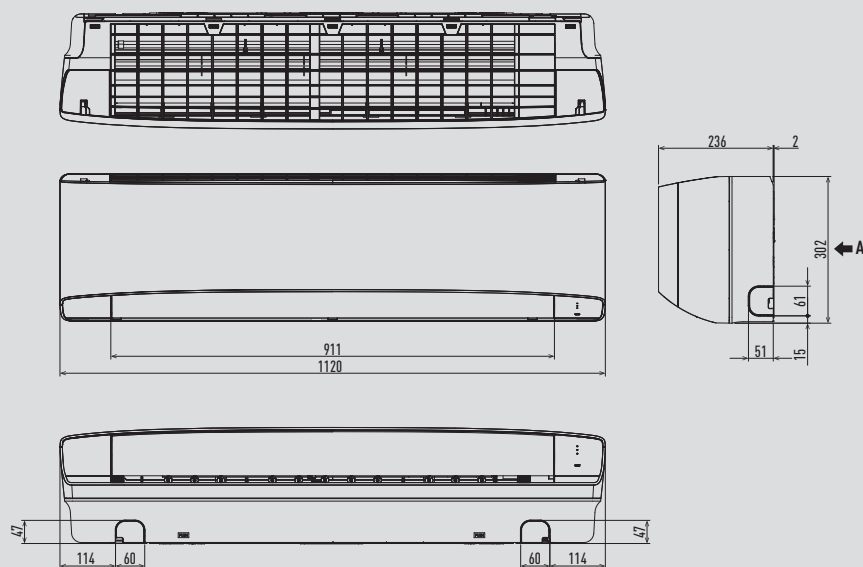

View A

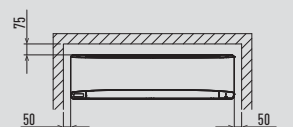
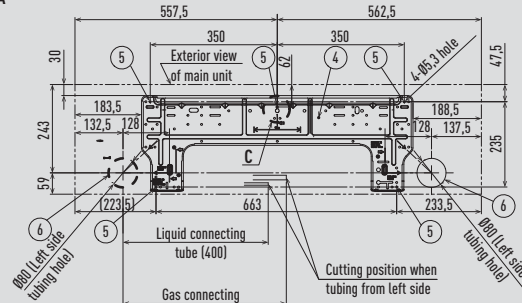

Minimum space requirements for installation

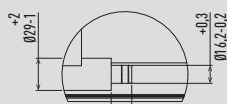

Detailed view B

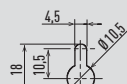

Detailed view C

Type	45-56	73-106
1	Refrigerant tubing (liquid)	Ø6,35 (flared)
2	Refrigerant tubing (gas)	Ø12,70 (flared)
3	Drain hose	
4	Rear panel	
5	Rear panel fixing holes	Ø5,3 holes or as shown in figure "C"
6	Tubing and wiring holes	Ø80

Unit: mm

### R1 Type Concealed Floor Standing

- 1 4-Ø12 hole (for fastening the indoor unit to the floor with screws)
- 2 Air filter
- 3 Refrigerant tubing (liquid)
- 4 Refrigerant tubing (gas)
- 5 Level adjusting bolt
- 6 Drain tube connection port (20 A)
- 7 Flange for the air-outlet duct

	A	B	C	D	E	F	Liquid pipes	Gas pipes
22-36	904	692	672	665	500	86		
45							Ø6,35	Ø12,70
56	1219	1007	1002	980	900	51		
71							Ø9,52	Ø15,88

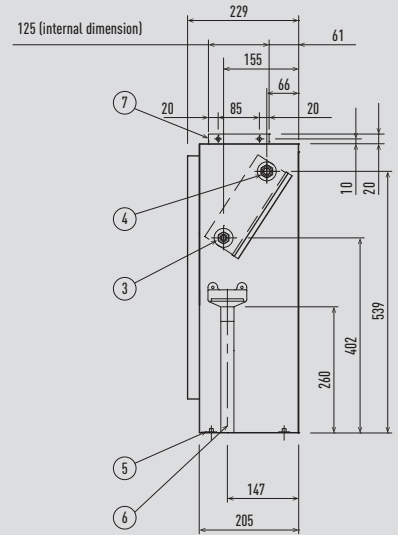
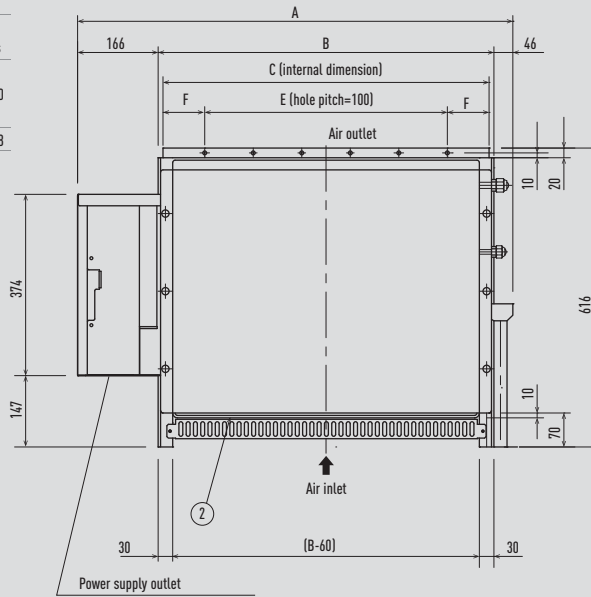
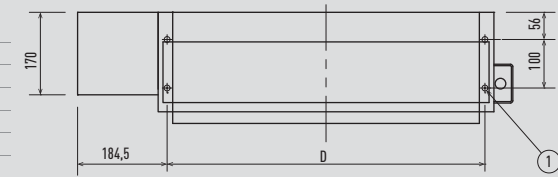

Unit: mm

### Air Curtain with DX Coil

Jet-flow dimensions

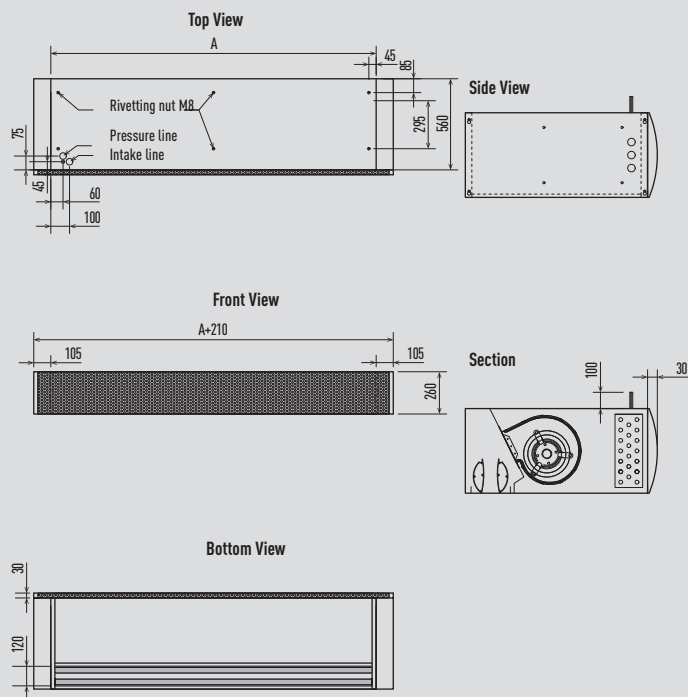

Standard dimensions

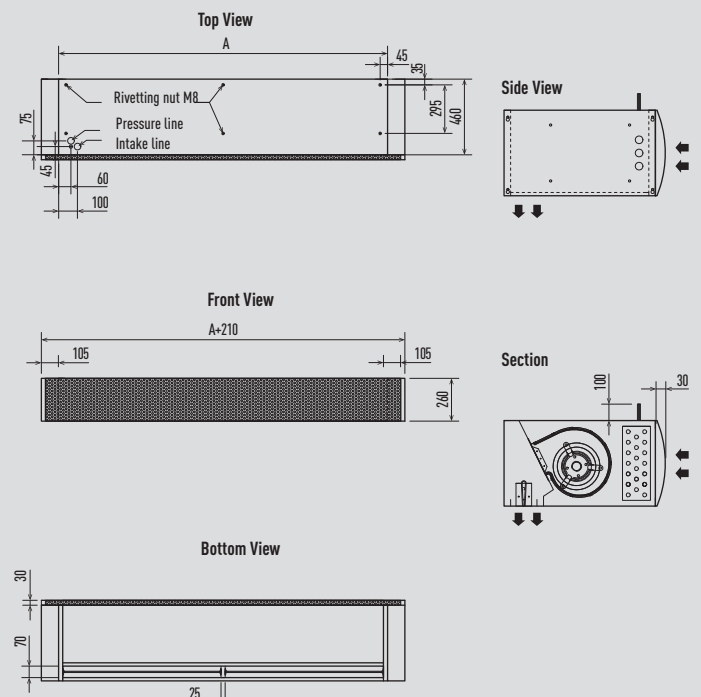

	PAW-10EAIRC-MJ	PAW-15EAIRC-MJ	PAW-20EAIRC-MJ	PAW-25EAIRC-MJ
A	1000	1500	2000	2500

	PAW-10EAIRC-MS	PAW-20EAIRC-MS
A	1000	2000

Unit: mm

Energy Recovery Ventilation System

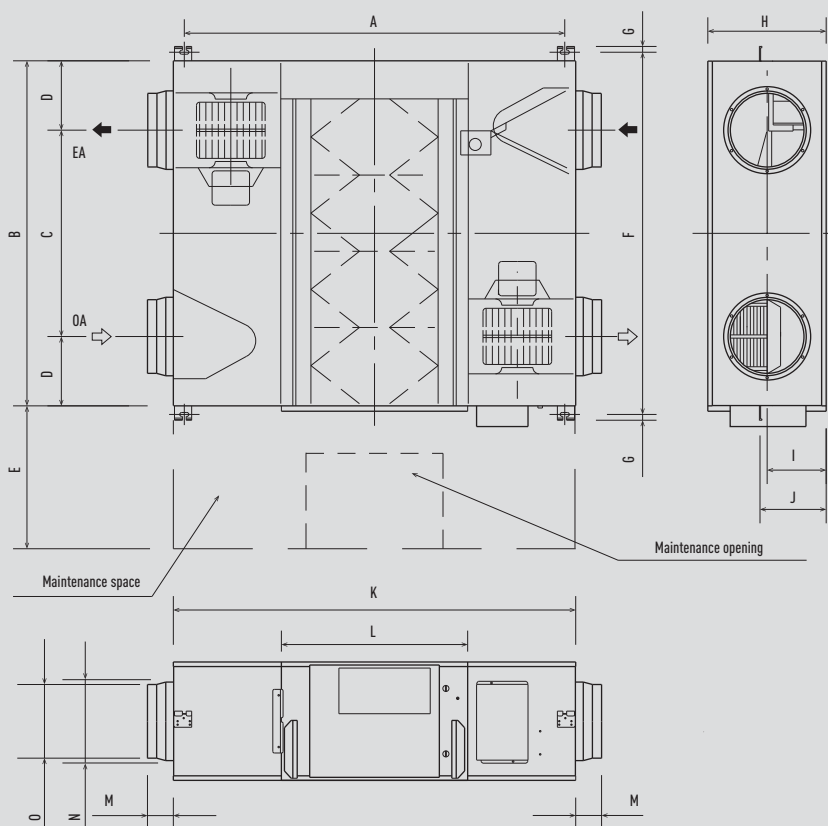

	FY-250ZDY8R	FY-350ZDY8R	FY-500ZDY8R	FY-800ZDY8R	FY-01KZDY8R
A	810	810	890	1250	1250
B	599	804	904	884	1134
C	315	480	500	428	678
D	142	162	202	228	228
E	600	600	600	600	600
F	655	860	960	940	1190
G	19	19	19	19	19
H	270	317	317	288	388
I	135	145	145	194	194
J	159	159	159	218	218
K	882	882	962	1322	1322
L	414	414	414	612	612
M	95	95	107	85	85
N	219	219	246	258	258
O	144	144	194	242	242

Unit: mm

Heat Recovery with DX Coil

	A	A1	A2	B	B1	B2	C	D	D1	Ød	E	Net weight
PAW-500ZDX3N	1822	1752	1986	882	936	994	390	431	431	250	169	81
PAW-800ZDX3N	1822	1752	1986	1132	1186	1244	390	431	431	250	169	87
PAW-01KZDX3N	1822	1752	1986	1132	1186	1244	390	681	532	250	169	87

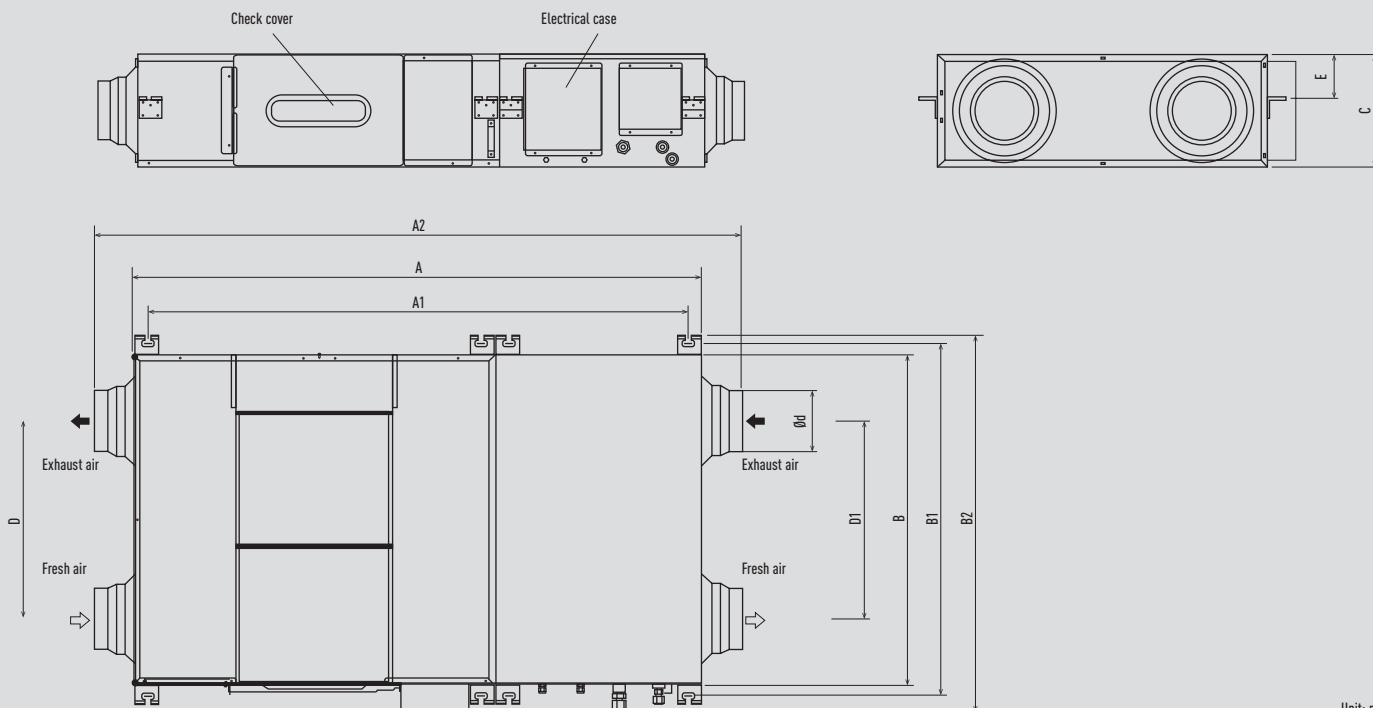

Unit: mm

VRF Smart Connectivity controller external dimensions

Room Controller for SE8000

Dimensions

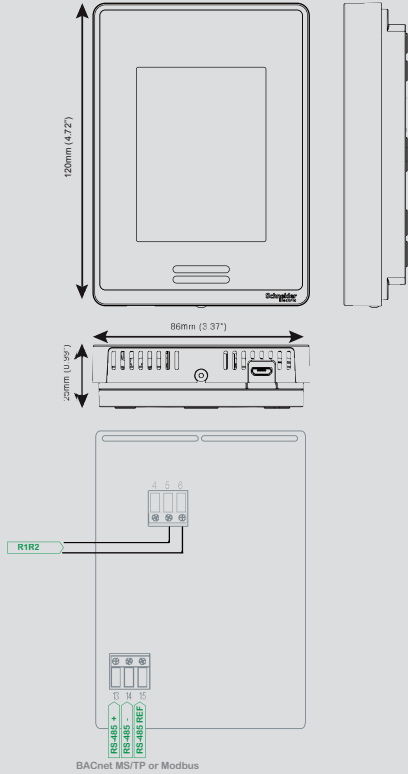

Specifications

**Dimensions**  
 Height: 12cm/4.72in  
 Width: 8.6cm/3.39in  
 Depth: 2.7cm/1.06in  
**Power Requirements**  
 16 Vdc from Panasonic R-R IDU connectors  
 50/60 Hz, 4VA, Class 2 Supply  
**Range from Indoor Unit**  
 Recommended 500ft (150 m)  
**Operating Conditions**  
 0°C to 50°C [32°F to 122°F]  
 0% to 95% R.H. non-condensing  
**Storage Conditions**  
 -30°C to 50°C [-22°F to 122°F]  
 0% to 95% R.H. non-condensing  
**Temperature Sensor**  
 Local 10 K NTC type 2 thermistor  
**Temperature Sensor Resolution**  
 ± 0.1°C [± 0.2°F]  
**Temperature Sensor Accuracy**  
 ± 0.5°C [± 0.9°F] @ 21°C (70°F) typical calibrated

**Humidity Sensor and Calibration**  
 Single point calibrated bulk polymer type sensor  
**Humidity Sensor Precision**  
 Reading range from 10 to 90 % R.H. non-condensing  
 10 to 20% precision: 10%  
 20% to 80% precision: 5%  
 80% to 90% precision: 10%  
**Humidity Sensor Stability**  
 Less than 1.0 % yearly (typical drift)  
**Wiring**  
 Maximum wire length between last indoor unit to SER8150Rx B1194 equals 490ft (150m) with AWG #18 wire [0.82 mm<sup>2</sup>]. Refer to Panasonic VRF guidelines "Wiring System Diagram for Remote Controller" for this limitation.  
**Approximate Shipping Weight**  
 0.34 kg (0.75 lb)

Check with your local government for instruction on disposal of these products.

THIS PRODUCT FOR COMMERCIAL USE ONLY



Wall/Ceiling Wireless Sensor SED-MTH-G-5045

Dimensions

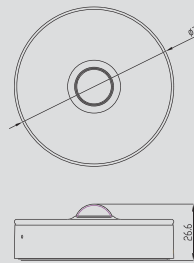

Specifications

**Dimensions** 70mm diam. x 26.6mm  
**Colour** White  
**Weight** 59g  
**Communication** ZigBee 3.0 HA  
**Detection Range** Ceiling: 04m (installation height 2.5m)  
 Wall: R5m (installation height 1.2m)  
**Battery Voltage** 3V  
**Battery Cell** LR03 AAA (2pcs)  
**Battery Life** Up to 5 years  
**Ambient Temperature** -10° - +50°C

Certification

Check with your local government for instruction on disposal of these products.

Door/Window Wireless Sensor SED-WDC-G-5045

Dimensions

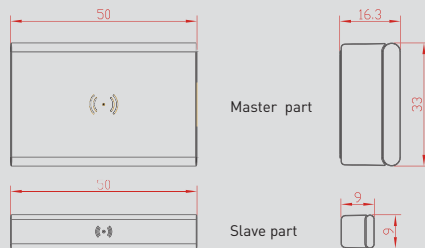

Specifications

**Dimensions** Master part: 50mmx33mmx16.3mm Slave part: 50mmx9mmx9mm  
**Colour** White/transp.  
**Weight** 30g  
**Communication** ZigBee 3.0 HA  
**Detection Range** Trigger 'close': wood 30mm, metal 18mm  
 Trigger 'open': wood 32mm, metal 20mm  
**Battery Voltage** 3V  
**Battery Cell** CR2450  
**Battery Life** Up to 5 years  
**Ambient Temperature** -10° - +50°C

Certification

Check with your local government for instruction on disposal of these products.

CO2 Sensor SED-CO2-G-5045

Dimensions

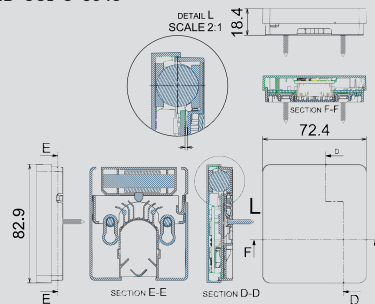

Specifications

**Dimensions** 3.26in x 2.85in x 0.72in  
 82.9 mm x 72.4 mm x 18.4 mm  
**Operating Temperature** 0°C to 50°C [32°F to 122°F]  
**Temperature Accuracy** ±0.3°C [0.54 °F] typical within operating range  
**Humidity Range** 0% to 100%  
**Humidity Accuracy** ± 3% RH [typical within 0% to 80% RH]  
**Measurement Range** 0 to 5000 ppm  
**Measurement/Transmission Intervals** 2.5 minutes (day), 10 minutes (evening)  
 Note: Battery life will be reduced should interval be shortened (i.e. using remote temperature/humidity functions)  
**CO2 Accuracy at NTP** ±60ppm +3% of reading (400 - 2,000ppm range)  
**Communication** Zigbee 3.0 Green Power (encrypted, bi-directional)  
**Battery Voltage** 3.6 V  
**Battery Cell** AA Lithium ion  
**Battery Life** 10+ years (non-replaceable)  
 Note: Battery life can be reduced when sensor is operated at temperatures approaching the operating limits.  
**Ambient Temperature** -30°C to 70°C

Certification

Check with your local government for instruction on disposal of these products.



Relay Pack TE2

Dimensions

ZigBee Pro (optional pink striped antenna for 2.4GHz) \*A13 can be used for pulse counting when ZigBee is paired directly to MPM

GND	R5A
A11	R5B
A12	R4A
A13*	R4B
A14	R3B
GND	Live
AO1	R2B
AO2	Live
AO3	R1B
AO4	Live
NC	Neutral
NC	Neutral
24VAC	Neutral
GND	Neutral

Specifications

- Dimensions: 6.93in x 4.25in, 176mm x 108mm
- Voltage: 24VAC; ± 15%; 50/60HZ; Class 2, 24VDC ± 10%, 115VAC/230VAC, 5VA (24V)
- Typical Consumption: 10VA (115/230 VAC)
- Inputs: Pulse input: Support for one fast pulse input counting (up to 1000Hz / 1ms) – A13
- Outputs: Relay (x4): 0-12V, nominal 50 mA max each, 12-bit resolution; Relay (x5) (optional): Maximum 230VAC, 5A per relay. First three relays (R1, R2 and R3) or based on input power voltage (24V, 115VAC or 230VAC). Two relays (R4 and R5) are independent of the input power voltage
- ZigBee Pro Range: Analog (x1): 24VAC, 2VA (115 VAC and 230 VAC Voltage only models, one additional output) (\*20VAC if used with 110V 50Hz); Frequency: 2400 to 2483.5MHz; 16RF channels; Non line of sight to MPM: 50ft/17m; Line of sight to MPM: 100ft/30m

Certification: Check with your local government for instruction on disposal of these products.

Hotel Room Controller HRC

Dimensions

Specifications

- Dimensions: 5.6in x 4.3in x 2.4in, 144mm x 110mm x 60.5mm
- Digital Inputs: 12
- High Voltage Relay: 10 x 3 A SPST +250 VAC relays
- Digital Outputs: 12 x configurable analog inputs
- Analog Inputs: DI: voltage free DI, 10 kΩ input impedance; 0-20mA: range 0..1000, < 150 Ω impedance; 0-10V: range 0..1000 > 10 kΩ impedance
- Analog Outputs: 6 x 0-10 V outputs. Load impedance > 700 Ω
- Supply Voltage: 24 VAC + 10% NOT ISOLATED; +20...38 Vdc NOT ISOLATED
- Supply Frequency: 50/60 Hz
- Power Cycle: 35 VA / 15 W
- Operating Temperature: -20 to 60 °C (-4 to 140 °F) conforming to UL 60730-1
- Storage Temperature: -30 to 70 °C (-22 to 158 °F)

Certification: Check with your local government for instruction on disposal of these products.

BEMS Gateway MPM

Dimensions

Output port

ZigBee Pro (optional) (Pink striped antenna for 2.4GHz)

24V AC/DC

CAN H

CAN L

GND

Ethernet 100B/T

Input port

RS 485 connectors for Modbus (optional)

OP 1A	GND
OP 1B	A16
OP 2A	GND
OP 2B	A15
15VDC	GND
AO1	A14
GND	GND
AO2	A13
GND	A12
AO3	GND
GND	A11
AO4	

Specifications

- Dimensions: 5.20in x 4.96in, 132mm x 126mm
- Voltage: 24VAC; ± 15%; 50/60HZ, 24VDC ± 10%
- Typical Consumption: 5 VA + Output (VAC), 1.6 W + Output (VDC)
- Communication: ZigBee Pro, EnOcean, BACnet, CANbus (125-500 Kbps), Ethernet (10/100 Mbps)
- Analog Inputs: Current: 4-20mA with 249 external resistor; Voltage: 0-10V
- Outputs: Relay (x2): 24V, 1.1 Amp per relay; Supported protocols: Modbus; Frequency: 868MHz, 902MHz
- RS485 (optional): ZigBee Pro (Optional)

Certification: Check with your local government for instruction on disposal of these products.

PAW-RE2C3 Hotel Controller

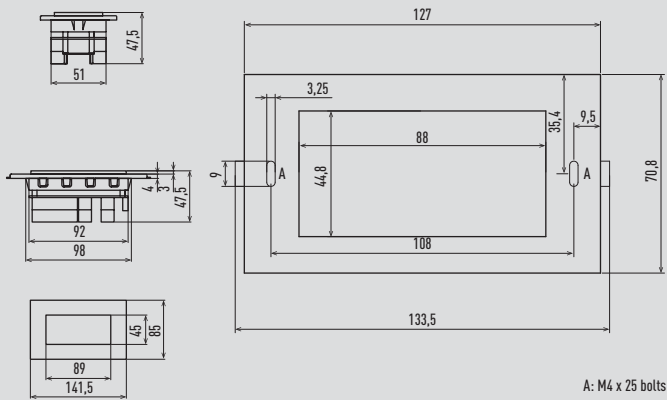

CZ-RTC5B Design wired remote controller

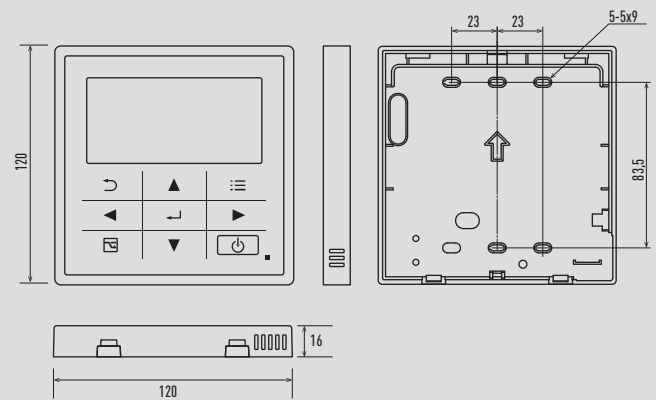

CZ-RTC2 Wired remote controller. Normal operation

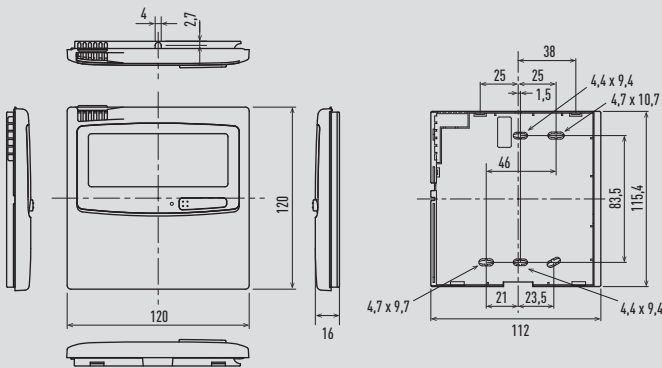

CZ-RWS3 Wireless remote control

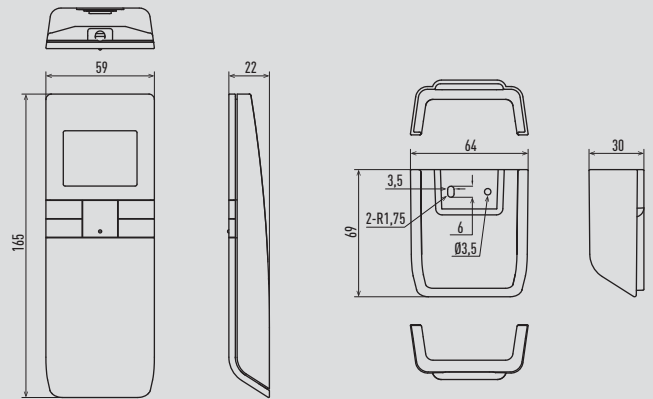

CZ-RE2C2 Simplified remote controller

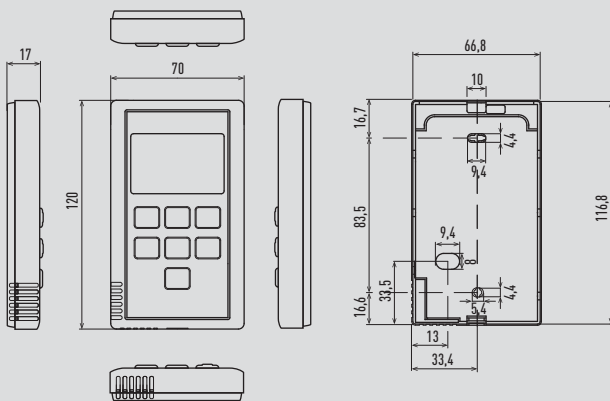

CZ-64ESMC3 System Controller with Schedule timer

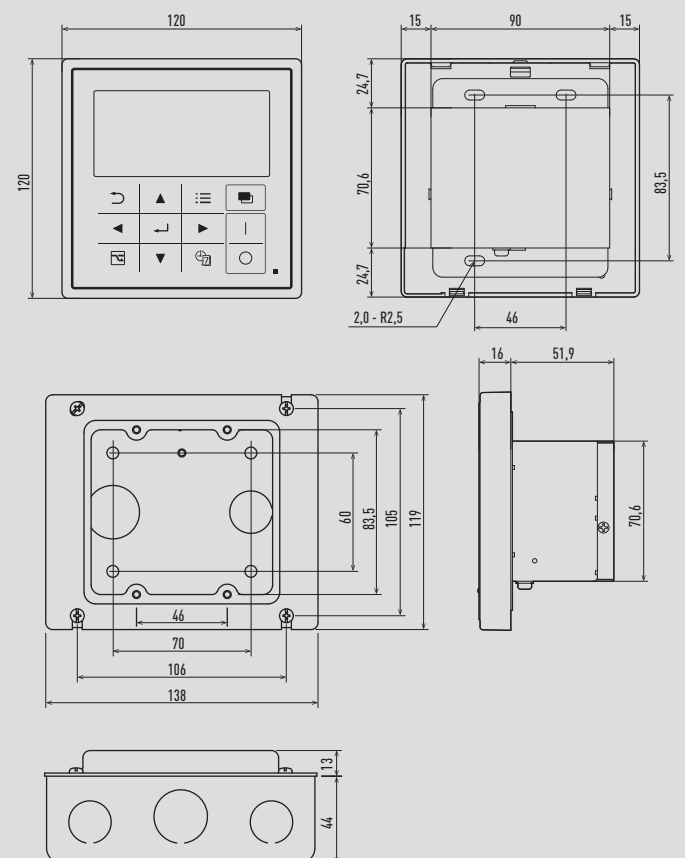

CZ-CSRC3 Remote sensor

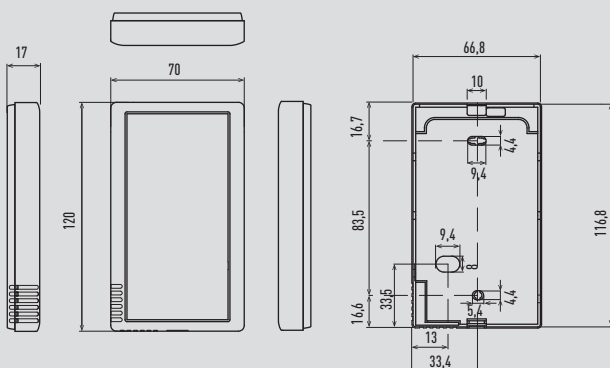

**CZ-ANC3 ON/OFF Controller**

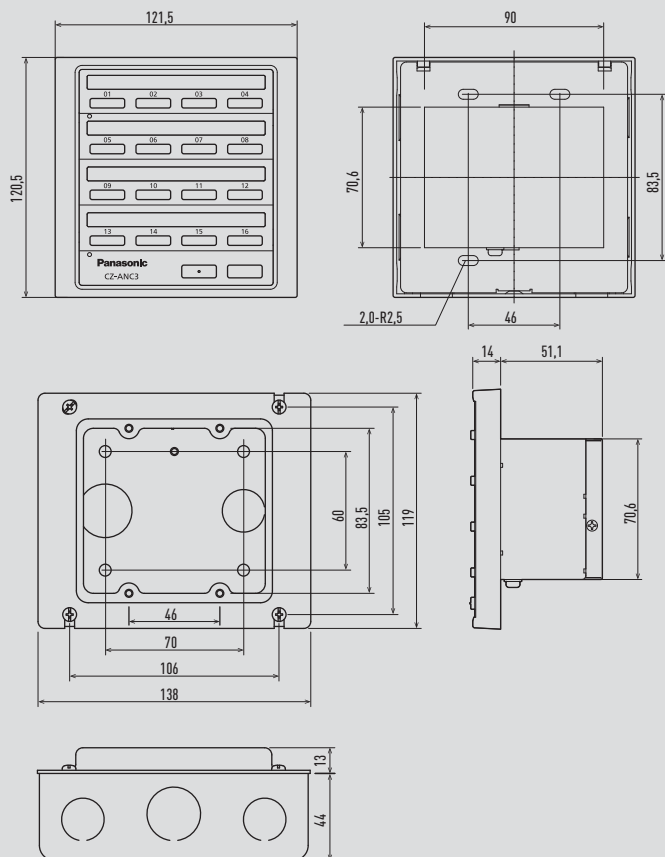

**CZ-256ESMC3 Intelligent Controller (Touch screen panel)**

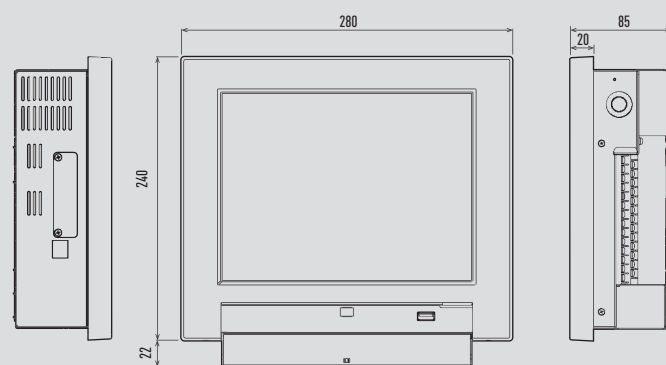

**CZ-CAPDC2 Seri-Para I/O unit for outdoor unit**

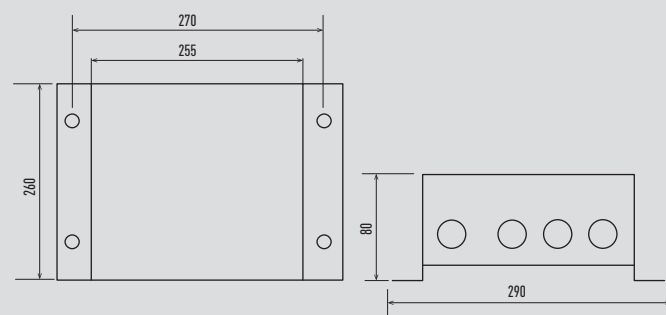

**CZ-CAPC3 Local adaptor for ON/OFF control**

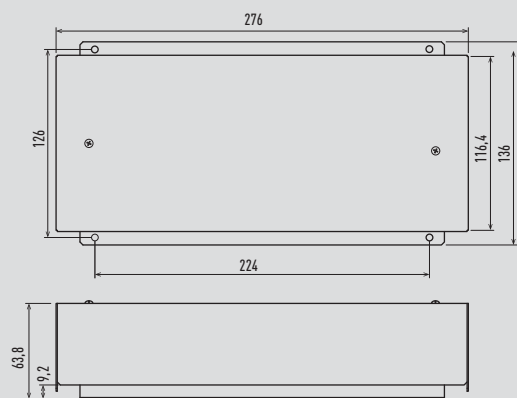

**CZ-CAPBC2 Mini Seri-Para I/O Unit 0 -10V**

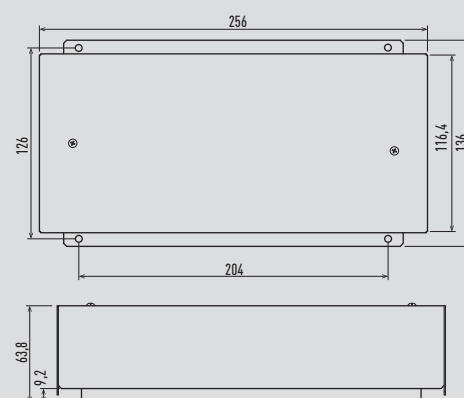

**CZ-CFUNC2 Communication Adaptor**

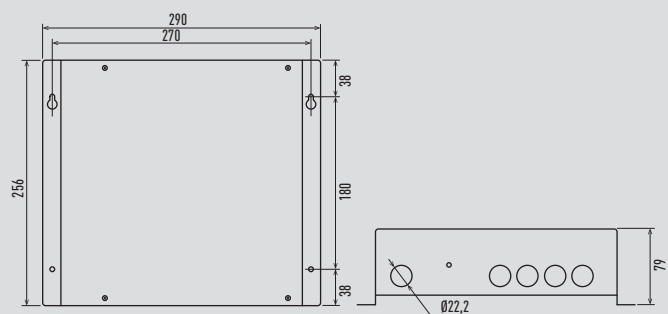







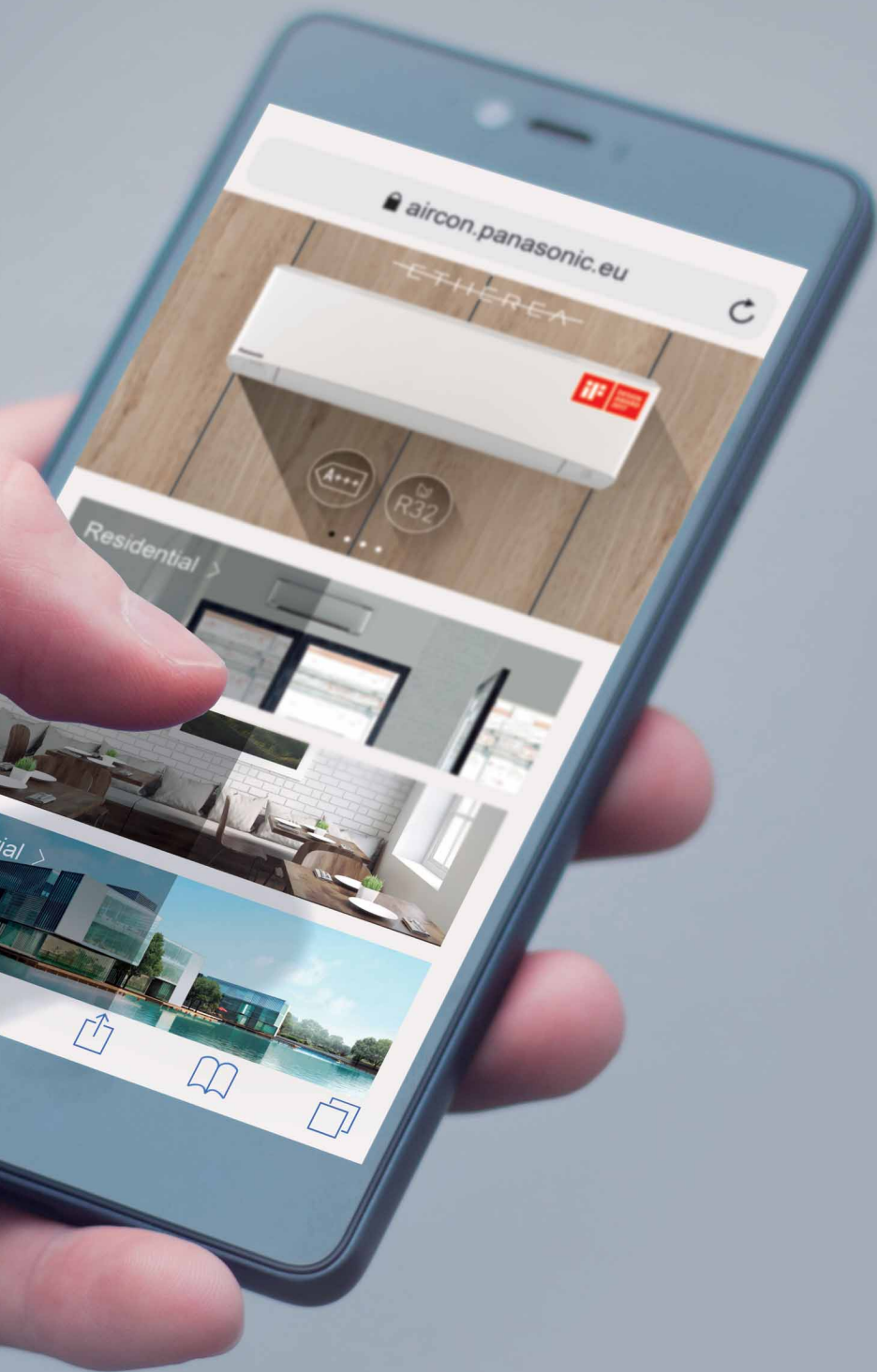

[www.aircon.panasonic.eu](http://www.aircon.panasonic.eu)

---

heating & cooling solutions

Due to the ongoing innovation of our products, the specifications of this catalogue are valid bearing typographic errors, and may be subject to minor modifications by the manufacturer without prior warning in order to improve the product. The total or partial reproduction of this catalogue is prohibited without the express authorisation of Panasonic Marketing Europe GmbH.

**UK / Ireland**  
**Panasonic House**  
Panasonic Heating & Cooling Systems  
Willoughby Road  
Bracknell, Berkshire  
RG12 8FP  
  
01344 85 3182  
uk-aircon@eu.panasonic.com  
www.aircon.panasonic.eu

**France / Belgium / Luxemburg**  
**Panasonic France**  
Division Chauffage et Climatisation  
1 à 7 Rue du 19 Mars 1962  
92238, Gennevilliers Cedex  
  
www.aircon.panasonic.eu

**Germany / Austria / Switzerland**  
**Panasonic Deutschland**  
Hagenauer Str. 43  
65203 Wiesbaden  
  
Hotline Germany: 0800-200 22 23  
Hotline Austria: 0800-700 666  
Hotline Switzerland: 0800-001 074  
klimaanlagen@eu.panasonic.com  
heizung@eu.panasonic.com  
www.aircon.panasonic.eu

**Turkey**  
**Panasonic Elektronik Satis A.S.**  
Abdurrahmangazi Mah. Ebubekir Cad.  
No: 44  
34887 Sancaktepe - Istanbul  
  
+90 216 6810400  
contact\_ptr@eu.panasonic.com  
www.aircon.panasonic.eu

**Czech Republic / Slovakia**  
**Panasonic Marketing Europe GmbH,**  
**organizační složka Česká republika**  
Palac Karlin, Thamova 289/13  
186 00 Prague 8, Czech Republic  
  
+420 236 032 511  
panasonic.praha@eu.panasonic.com  
www.aircon.panasonic.eu

**Spain / Portugal**  
**Panasonic España**  
WTC Almeda Park, Plaza de la Pau s/n,  
Edificio 8, Planta baja  
08940, Cornellà de Llobregat / Barcelona  
  
902 15 30 60  
www.aircon.panasonic.eu

**Italy / Malta**  
**Panasonic Italia**  
Viale dell'Innovazione, 3  
20126, Milano  
  
02-67072556  
www.aircon.panasonic.eu

**Sweden**  
**Panasonic Nordic**  
Telefonvägen, 26  
126 26 Hågersten  
  
+46 8 680 26 00  
www.aircon.panasonic.eu

**Poland**  
**Panasonic Marketing Europe GmbH**  
**Oddział w Polsce Sp. z o.o.**  
Wotoska 9A  
02-583, Warszawa  
  
+48 801 801 887  
AirCon\_Warsaw@eu.panasonic.com  
www.aircon.panasonic.eu

**Netherlands**  
**Panasonic Netherlands**  
Europalaan 28E  
5332 BC, 's-Hertogenbosch  
  
+31 73 6402 538  
airconditioning.nl@eu.panasonic.com  
www.aircon.panasonic.eu



To find out how Panasonic cares for you,  
log on to: [www.aircon.panasonic.eu](http://www.aircon.panasonic.eu)

**Panasonic Marketing Europe GmbH**  
**Panasonic Air Conditioning**  
Hagenauer Strasse 43, 65203 Wiesbaden, Germany



Do not add or replace refrigerant other than the specified type. Manufacturer is not responsible for the damage and deterioration in safety due to usage of the other refrigerant.

The outdoor units in this catalogue contains fluorinated greenhouse gases with a GWP higher than 150.

